

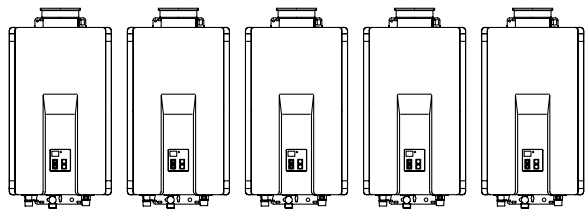

Manifold Electronic Control System Installation Instructions

MSB-C2



Note:

- Up to 5 water heaters can be connected together using the MSB-M and MSB-C1 kits.
- When over 5 water heaters are connected together, MSB-M units are connected using MSB-C2 kits.
- If multiple MSB-M are used, then at least three water heaters should be connected to each MSB-M.
Ex: With 7 water heaters, one MSB-M should control 4 water heaters and the other MSB-M should control 3 water heaters.
- United States & Canada: For use with Rinnai Tankless Water Heaters (except for models V53e, V53i and R63LSe which must use pressure activation valves, PVA).
- Please contact Rinnai if you have further questions on the applicable water heater models.

WARNING

Disconnect all water heaters from their power source before carrying out the following installation procedures.

NOTE: The front cover panels of each water heater must be removed prior to completing the following installation procedures.

Kit Components

MSB-C2 (Pack C)
(For wiring MSB units)

Parts List

Part	Qty
MSB Communication cable (13.1 ft, 4 m)	1
Terminal connector	2
Instruction Sheet	1

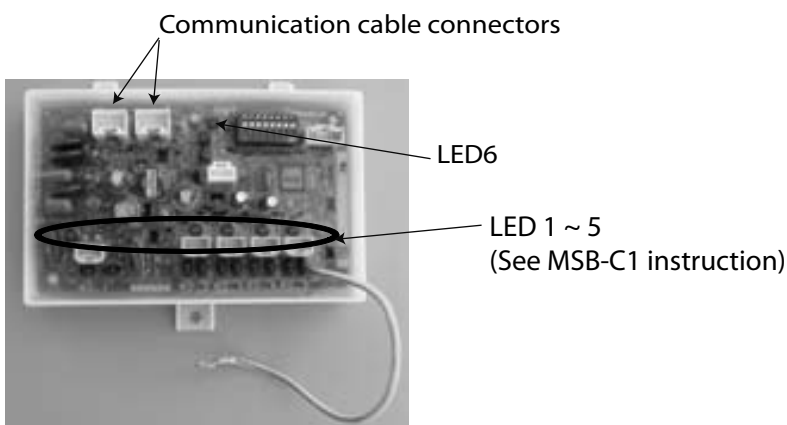
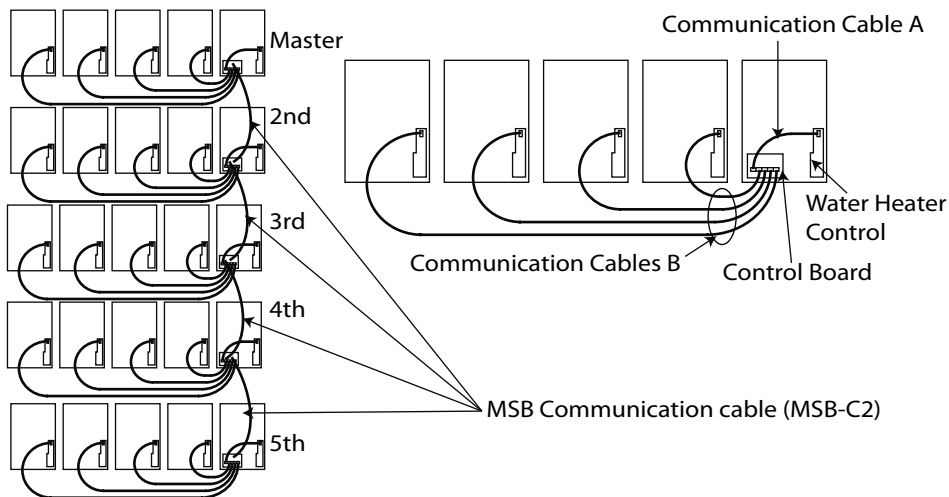

Connecting Multiple MSB-M Units

1) On the master MSB, one connector is connected to the terminal connector and the other one is connected to the MSB Communication cable.

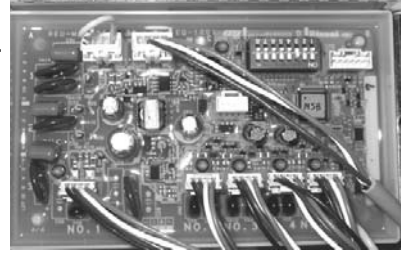

Master MSB board

2) When 2 MSB boards are used a MSB Communication cable will be installed between the master MSB board and the second MSB. The open connector will have the Terminal connector installed on both MSB boards.

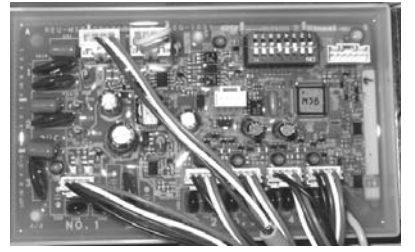

2nd MSB board

A maximum of 5 MSB boards can be connected to each other. The terminal connector is connected on the terminal MSB which has an open connector.

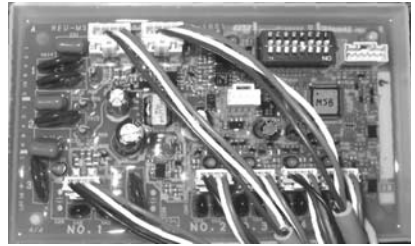

2nd to 4th MSB board

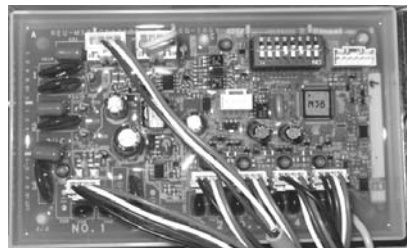

5th MSB board (Terminal MSB)

NOTE:

When viewing the installed MSB board, the dip switch will be as shown below (upside down).

3) Set No 3 switch on the master MSB to ON. The LED light 6 should turn ON confirming the connection.

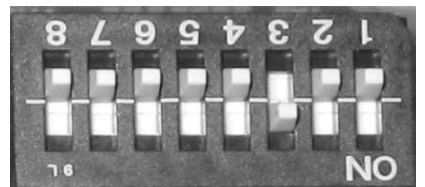

4) Set No 4 switch on the second MSB to ON. The LED light 6 should turn ON confirming the connection.

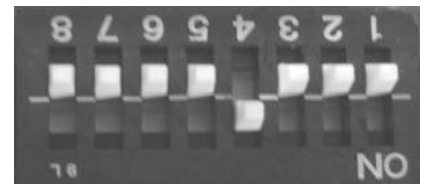

5) Set No 3 and No 4 switches on the third MSB board to ON. The LED light 6 should turn ON confirming the connection.

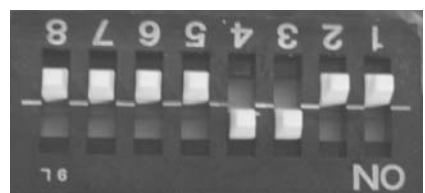

6) Set the No 5 switch on the fourth MSB board to ON. The LED light 6 should turn ON confirming the connection.

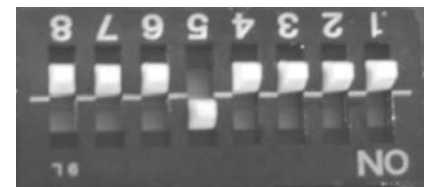

7) Set No 3 and No 5 switches on the on the fifth MSB board to ON. The LED light 6 should turn ON confirming the connection.

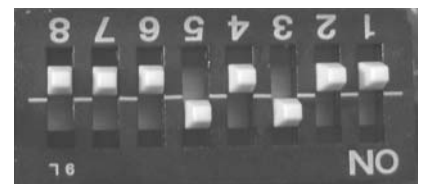

Indicator light (LED 6) on the Control Board indicates the status as follows:

LED 6	EXPLANATION
Solid	Working with multiple MSB boards
Off	Stand alone

Free Manuals Download Website

<http://myh66.com>

<http://usermanuals.us>

<http://www.somanuals.com>

<http://www.4manuals.cc>

<http://www.manual-lib.com>

<http://www.404manual.com>

<http://www.luxmanual.com>

<http://aubethermostatmanual.com>

Golf course search by state

<http://golfingnear.com>

Email search by domain

<http://emailbydomain.com>

Auto manuals search

<http://auto.somanuals.com>

TV manuals search

<http://tv.somanuals.com>