

**8090/8110/8135**  
DSm790/DSm7110/DSm7135  
*LD190/LD1110/LD1135*  
**Aficio™** MP 9000/1100/1350

## Operating Instructions Troubleshooting

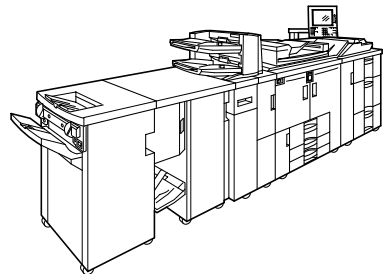

- 
- 1** When the Machine Does Not Operate As wanted
  - 2** Troubleshooting When Using the Copy Function
  - 3** Troubleshooting When Using the Printer Function
  - 4** Troubleshooting When Using the Scanner Function
  - 5** Adding paper, Toner and Staples
  - 6** Clearing Misfeeds
  - 7** Remarks

---

Read this manual carefully before you use this machine and keep it handy for future reference. For safe and correct use, be sure to read the Safety Information in "About This Machine" before using the machine.

## Introduction

This manual contains detailed instructions and notes on the operation and use of this machine. For your safety and benefit, read this manual carefully before using the machine. Keep this manual in a handy place for quick reference.

Do not copy or print any item for which reproduction is prohibited by law.

Copying or printing the following items is generally prohibited by local law:

bank notes, revenue stamps, bonds, stock certificates, bank drafts, checks, passports, driver's licenses.

The preceding list is meant as a guide only and is not inclusive. We assume no responsibility for its completeness or accuracy. If you have any questions concerning the legality of copying or printing certain items, consult with your legal advisor.

## Important

Contents of this manual are subject to change without prior notice. In no event will the company be liable for direct, indirect, special, incidental, or consequential damages as a result of handling or operating the machine.

## Notes:

Some illustrations in this manual might be slightly different from the machine.

Depending on which country you are in, certain units may be optional. For details, please contact your local dealer.

Two kinds of size notation are employed in this manual. With this machine refer to the inch version.

For good copy quality, the supplier recommends that you use genuine toner from the supplier.

The supplier shall not be responsible for any damage or expense that might result from the use of parts other than genuine parts from the supplier with your office products.

## Power Source

208-240 V, 50/60 Hz, 20 A or more.

Please be sure to connect the power cord to a power source as shown above. For details about power source, see p.112 "Power Connection".

## Trademarks

Microsoft®, Windows® and Windows NT® are registered trademarks of Microsoft Corporation in the United States and/or other countries.

TrueType is registered trademarks of Apple Computer, Inc.

PostScript® and Acrobat® are registered trademarks of Adobe Systems, Incorporated.

PCL is a registered trademark of Hewlett-Packard Company.

Bluetooth is a Trademark of the Bluetooth SIG, Inc. (Special Interest Group) and licensed to Ricoh Company Limited.

Other product names used herein are for identification purposes only and might be trademarks of their respective companies. We disclaim any and all rights to those marks.

The proper names of the Windows operating systems are as follows:

- The product name of Windows® 95 is Microsoft® Windows 95.
- The product name of Windows® 98 is Microsoft® Windows 98.
- The product name of Windows® Me is Microsoft® Windows Millennium Edition (Windows Me).
- The product names of Windows® 2000 are as follows:
  - Microsoft® Windows® 2000 Advanced Server
  - Microsoft® Windows® 2000 Server
  - Microsoft® Windows® 2000 Professional
- The product names of Windows® XP are as follows:
  - Microsoft® Windows® XP Professional
  - Microsoft® Windows® XP Home Edition
- The product names of Windows Server™ 2003 are as follows:
  - Microsoft® Windows Server™ 2003 Standard Edition
  - Microsoft® Windows Server™ 2003 Enterprise Edition
  - Microsoft® Windows Server™ 2003 Web Edition
- The product names of Windows NT® 4.0 are as follows:
  - Microsoft® Windows NT® Server 4.0
  - Microsoft® Windows NT® Workstation 4.0

# Manuals for This Machine

Refer to the manuals that are relevant to what you want to do with the machine.

## ❖ **About This Machine**

Be sure to read the Safety Information in this manual before using the machine.

This manual provides an introduction to the functions of the machine. It also explains the control panel, preparation procedures for using the machine, how to enter text, and how to install the CD-ROMs provided.

## ❖ **General Settings Guide**

Explains User Tools settings, and Address Book procedures such as registering e-mail addresses, and user codes. Also refer to this manual for explanations on how to connect the machine.

## ❖ **Trouble Shooting**

Provides a guide to solving common problems, and explains how to replace paper, toner, staples, and other consumables.

## ❖ **Security Reference**

This manual is for administrators of the machine. It explains security functions that the administrators can use to protect data from being tampered, or prevent the machine from unauthorized use.

Also refer to this manual for the procedures for registering administrators, as well as setting user and administrator authentication.

## ❖ **Copy/ Document Server Reference**

Explains Copier and Document Server functions and operations. Also refer to this manual for explanations on how to place originals.

## ❖ **Printer Reference**

Explains Printer functions and operations.

## ❖ **Scanner Reference**

Explains Scanner functions and operations.

## ❖ **Network Guide**

Explains how to configure and operate the machine in a network environment, and use the software provided.

This manual covers all models, and includes descriptions of functions and settings that might not be available on this machine. Images, illustrations, and information about operating systems that are supported might also differ slightly from those of this machine.

## ❖ Other manuals

- Information
- PostScript3 Supplement
- UNIX Supplement
- Manuals for DeskTopBinder Lite

### Note

- Manuals provided are specific to machine types.
- Adobe Acrobat Reader/Adobe Reader must be installed in order to view the manuals as PDF files.
- For “UNIX Supplement”, please visit our Web site or consult an authorized dealer.
- “PostScript3 Supplement” and “UNIX Supplement” include descriptions of functions and settings that might not be available on this machine.

# TABLE OF CONTENTS

<b>Manuals for This Machine</b> .....	<b>i</b>
<b>How to Read This Manual</b> .....	<b>1</b>
Symbols .....	1
Names of Major Options .....	2

## **1. When the Machine Does Not Operate As wanted**

---

<b>Indicators</b> .....	<b>3</b>
<b>Panel Tone</b> .....	<b>4</b>
<b>Checking Machine Status and Settings</b> .....	<b>5</b>
<b>When an Indicator to the Left of a Function Key is Lit</b> .....	<b>8</b>
<b>When You Have Problems Operating the Machine</b> .....	<b>9</b>
<b>When a Job is Not Performed</b> .....	<b>14</b>

## **2. Troubleshooting When Using the Copy Function**

---

<b>When a Message Appears</b> .....	<b>19</b>
<b>Display During Connect Copy</b> .....	<b>24</b>
<b>If Connect Copy is Cancelled</b> .....	<b>25</b>
<b>If You Cannot Exit from Connect Copy</b> .....	<b>26</b>
<b>When You Cannot Make Clear Copies</b> .....	<b>27</b>
<b>When You Cannot Make Copies As Wanted</b> .....	<b>29</b>
When Memory is Full .....	33

## **3. Troubleshooting When Using the Printer Function**

---

<b>When a Message Appears during Installation of the Printer Driver</b> .....	<b>35</b>
Windows 95/98/Me .....	35
Windows 2000 .....	36
Windows XP, Windows Server 2003 .....	36
Windows NT 4.0 .....	37
<b>If USB Connection Fails</b> .....	<b>38</b>
<b>When a Message Appears</b> .....	<b>39</b>
Status Messages .....	39
Alert Messages .....	40
Checking the Error Log .....	41
<b>When You Cannot Print</b> .....	<b>42</b>
<b>Other Printing Problems</b> .....	<b>45</b>

## **4. Troubleshooting When Using the Scanner Function**

---

<b>When Scanning is Not Done as Expected</b> .....	<b>51</b>
<b>When You Cannot Send Scanned Files</b> .....	<b>52</b>
When Stored Files Cannot be Accessed .....	52
When You Cannot Browse the Network to Send a Scan file .....	52
When the TWAIN Driver Cannot be Started .....	52
When Stored Files Cannot be Edited .....	53
When the Network Delivery Function Cannot be Used .....	53
Operations are not possible when messages appear .....	53

<b>When a Message is Displayed</b> .....	<b>54</b>
When a Message is Displayed on the Control Panel.....	54
When a Message is Displayed on the Client Computer.....	61

## **5. Adding paper, Toner and Staples**

---

<b>Loading paper</b> .....	<b>65</b>
Loading paper into Tray 1 (Tandem Tray) .....	65
Loading Paper into the A3/11" × 17" Tray Unit.....	67
Loading Paper into Tray 2 and 3.....	68
Loading Paper into the Large Capacity Tray (LCT) .....	69
Loading Paper into the Wide Large Capacity Tray (Wide LCT) .....	70
Loading Paper into the Multi Bypass Tray (Tray 7) .....	71
Loading Paper in the Interposer.....	72
<b>Changing the Paper Size</b> .....	<b>75</b>
Changing the Paper Size in Tray 2 and 3 .....	76
Changing the Paper Size in the Large Capacity Tray (Tray 4 and 5) .....	78
Changing the Paper Size in the Wide Large Capacity Tray.....	81
Changing to a Size that is Not Automatically Detected.....	84
<b>Pausing Copy When Using Finisher</b> .....	<b>86</b>
<b>Adding Toner</b> .....	<b>87</b>
Inserting Toner .....	89
Used Toner .....	89
<b>Adding Staples</b> .....	<b>90</b>
Finisher .....	90
Booklet Finisher (Saddle Stitch).....	91

## **6. Clearing Misfeeds**

---

<b>Removing Jammed Paper</b> .....	<b>93</b>
Locating Jammed Paper .....	94
Removing Jammed Paper.....	96
When Z-folded paper is not properly aligned .....	105
<b>Removing Jammed Staples</b> .....	<b>106</b>
Finisher .....	106
Booklet Finisher (Saddle Stitch).....	107
<b>Removing Punch and Staple Waste</b> .....	<b>108</b>
Finisher .....	108

## **7. Remarks**

---

<b>Where to Put Your Machine</b> .....	<b>109</b>
Machine Environment .....	109
Moving.....	111
Power Connection.....	112
Access to the Machine .....	113
<b>Maintaining Your Machine</b> .....	<b>114</b>
Cleaning the Exposure Glass.....	114
Cleaning the Auto Document Feeder.....	114
<b>Earth Leakage Circuit Breaker</b> .....	<b>115</b>
<b>INDEX</b> .....	<b>117</b>

# How to Read This Manual

---

## Symbols

---

This manual uses the following symbols:

### **WARNING:**

Indicates important safety notes.

Ignoring these notes could result in serious injury or death. Be sure to read these notes. They can be found in the “Safety Information” section of About This Machine.

### **CAUTION:**

Indicates important safety notes.

Ignoring these notes could result in moderate or minor injury, or damage to the machine or to property. Be sure to read these notes. They can be found in the “Safety Information” section of About This Machine.

### **Important**

Indicates points to pay attention to when using the machine, and explanations of likely causes of paper misfeeds, damage to originals, or loss of data. Be sure to read these explanations.

### **Note**

Indicates supplementary explanations of the machine’s functions, and instructions on resolving user errors.

### **Reference**

This symbol is located at the end of sections. It indicates where you can find further relevant information.

### **[ ]**

Indicates the names of keys that appear on the machine’s display panel.

### **[ ]**

Indicates the names of keys on the machine’s control panel.

---

## Names of Major Options

---

Major options of this machine are referred to as follows in this manual:

- Auto Document Feeder → ADF
- Finisher SR5000 → Finisher
- Booklet Finisher BK5000 → Booklet Finisher











# 1. When the Machine Does Not Operate As wanted

This chapter explains basic troubleshooting procedures that are applicable to all functions of this machine.

## Indicators

This section explains Indicators displayed when the machine requires the user to remove misfed paper, add paper, or other perform other procedures.

 : Misfeed indicator	Appears when a misfeed occurs. See p.93 "Removing Jammed Paper".
 : Add Paper indicator	Appears when paper-out condition occurs. See p.65 "Loading paper".
 : Add Toner indicator	Appears when toner runs out. See p.87 "Adding Toner".
 : Add Staple indicator	Appears when staples run out. See p.90 "Adding Staples".
 : Empty Hole Punch Receptacle indicator	Appears when the hole punch receptacle is full. See p.108 "Removing Punch and Staple Waste"
 : Empty Waste Staple Receptacle indicator	Appears when the waste staple receptacle is full. See p.108 "Removing Punch and Staple Waste"
 : Service Call indicator	Appears when the machine is malfunctioning, or needs repairing.
 : Open Cover indicator	Appears when the front cover, etc, is open.

# Panel Tone

The following table explains the meaning of the various beep patterns that the machine produces to alert users about left originals and other machine conditions.

Beep pattern	Meaning	Cause
Two long beeps.	Machine has warmed up.	After cooling or being switched on, the machine has fully warmed up and is ready for use.
Single short beep.	Panel/screen input accepted.	A control panel or screen key was pressed. Single short beeps are produced only when valid keys are pressed.
Single long beep.	Job completed.	A Copier/Document Server Features job has finished.
Four long beeps.	Soft alert.	The screen changes back to the initial screen after the machine shifts to energy-saving mode, or the setting was reset at the simplified display.
Four long beeps repeated five times.	Soft alert.	An original has been left on the exposure glass, paper is empty, or the punch waste box is full.
Five short beeps repeated five time.	Strong alert.	The machine requires user attention because paper have jammed, the toner needs replenishing, or other troubles have occurred.

## Note

- Users cannot mute the machine's beep alerts. When the machine beeps to alert users of a paper jam or toner request, if the machine's covers are opened and closed repeatedly within a short space of time, the beep alert might continue, even after normal status has resumed.

## Reference

For details about enabling or disabling beep alerts, see “The System Settings”, General Settings Guide.

# Checking Machine Status and Settings

You can check the machine's system status.

## ❖ Maintenance Info

You can check the following items under **[Maintenance Info]**:

- **[Remaining Toner]**  
Displays the amount of remaining toner.
- **[No Staples]**  
Displays where the staple is empty.
- **[Punch Receptacle Full]**  
Displays whether the hole punch receptacle is full.
- **[Waste Staple Receptacle Full]**  
Displays whether the waste staple receptacle is full.
- **[Paper Tray]**  
Displays the paper type and size loaded in the paper tray.
- **[Output Tray Full]**  
Displays whether the output tray is overloaded.
- **[Original Misfeed]**  
Displays state of and solutions for original misfeeds.
- **[Paper Misfeed]**  
Displays state of and solutions for paper jams.
- **[Cover Open]**  
Indicates whether front cover, duplex unit, etc, is open.

## ❖ Data Storage

You can check the following items under **[Data Storage]**:

- **[HDD Remaining Memory]**  
Displays the amount of available hard disk drive memory.
- **[HDD File(s)]**  
Displays the total number of jobs stored in the hard disk drive.
- **[Print Job(s)]**  
Displays the number of jobs for Hold print/Saved print/Locked print/Sample print.
- **[Memory Erase Status]**  
Displays the state of the memory data.

❖ **Machine Address Info**

You can check the following items under **[Machine Address Info]**:

- **[Machine IPv4 Address]**  
Displays the machine's IPv4 address.
- **[Machine IPv6 Address]**  
Displays the machine's IPv6 address.

❖ **Inquiry**

You can check the following items under **[Inquiry]**:

- **[Machine Repairs]**  
Displays the machine number and contact number that are required for service.
- **[Sales Representative]**  
Displays the sales representative's telephone number.
- **[Supply Order]**  
Displays the contact number for placing supply orders.
- **[Supply Details]**  
Displays the name of toner, staples, etc, used on the machine.

**1** On the control panel, press **[System Status]** on the control panel.



**2** Press each tab and check the contents.

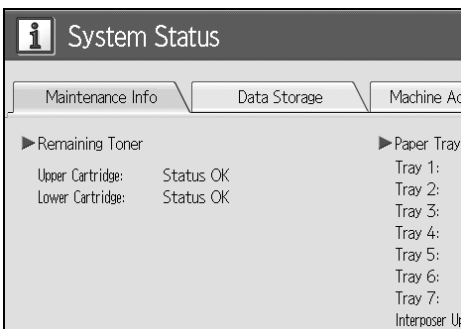

**3** After checking the information, press [Exit]. The previous screen returns.

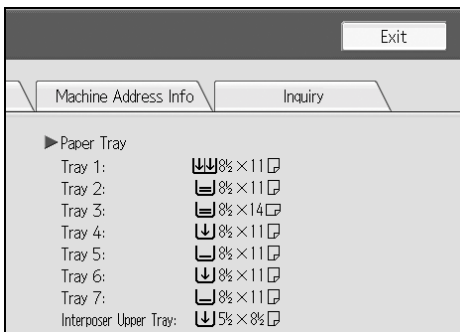

 **Note**

- [Output Tray Full], [Original Misfeed], [Paper Misfeed], and [Cover Open] appear only when these errors occur.
- For details about how to locate and remove misfeeds, see “Checking Jammed Paper” or “Removing Jammed Paper”.

 **Reference**

- p.94 “Locating Jammed Paper”.
- p.93 “Removing Jammed Paper”.

# When an Indicator to the Left of a Function Key is Lit

1

When an indicator to the left of a function key lights up, press the corresponding function key. Then, follow the instructions displayed on the control panel.

Problem	Cause	Solution
Documents and reports do not print out.	The paper output tray is full.	Remove the paper from the tray.
Documents and reports do not print out.	There is no copy paper left.	Add more paper. See p.65 "Loading paper".
An error has occurred.	The function whose indicator is lit is defective.	Record the code number shown in the display and contact your service representative. See "When a Message displayed" of each chapter. You can use other functions normally.
The machine is unable to connect to the network.	A network error has occurred.	<ul style="list-style-type: none"> <li>• Check the displayed message and take an appropriate action. See "When a Message displayed" of each chapter.</li> <li>• Check that the machine is correctly connected to the network, and that the machine is correctly set. See "Network Settings", General Settings Guide.</li> <li>• Contact the administrator.</li> <li>• When the function key is still lit, even if you take the measures above, contact your service representative.</li> </ul>

## Note

- If an error occurs in the function you are using, check the message that appears on the control panel, and then refer to "When a Message is Displayed" for the relevant function.

## Reference

- p.19 "Troubleshooting When Using the Copy Function".
- p.35 "Troubleshooting When Using the Printer Function".
- p.51 "Troubleshooting When Using the Scanner Function".

# When You Have Problems Operating the Machine

The following chart gives explanations of common problems and messages. If other messages appear, follow the instructions displayed.

## Important

- Check the contact address and Serial No. of Machine shown in the call service message, and then contact your service representative.

Problem	Cause	Solution
Although the copier screen appears when the machine is turned on using the main power switch, it cannot be switched to another screen by pressing the <b>[Printer]</b> or <b>[Scanner]</b> key.	Functions other than the copier function are not yet ready.	Wait a little longer.
The machine has just been turned on and the User Tools screen is displayed, but the User Tools menu has items missing.	Functions other than the copier function are not yet ready. Time required varies by function. Functions appear in the User Tools menu when they become ready for use.	Wait a little longer.
The main power indicator continues blinking and does not turn off when pressed.	This occurs in the following cases: <ul style="list-style-type: none"> <li>• ADF is open.</li> <li>• The machine is communicating with external equipment.</li> <li>• The hard disk is active.</li> </ul>	Close ADF, and check if the machine is communicating with a computer.
The display is off.	The machine is in Energy Saver mode.	Press the <b>[Energy Saver]</b> key to cancel Energy Saver Mode. mode.
The display is off.	The operation switch is turned off.	Turn on the operation switch.
Nothing happens when the operation switch is turned on.	The main power switch is turned off.	Turn on the main power switch.
"Please wait." appears.	This message appears when you turn on the operation switch.	Wait for the machine to get ready.
"Please wait." appears.	This message appears when you change the toner bottle.	Wait for the machine to get ready.

Problem	Cause	Solution
"Memory is full. Do you want to store scanned file?" appears.	The scanned originals exceed the number of sheets/pages that can be stored in the hard disk.	<ul style="list-style-type: none"> <li>• Press <b>[Store File]</b> to store pages that have been scanned. Delete unnecessary files with <b>[Delete File]</b>.</li> <li>• Press <b>[No]</b> if you are not storing pages that have been scanned. Delete unnecessary files with <b>[Delete File]</b>.</li> </ul>
"Self checking..." appears.	The machine is performing image adjustment operations.	The machine may perform periodic maintenance during operations. The frequency and duration of maintenance depends on the humidity, temperature, and printing factors such as number of prints, paper size, and paper type. Wait for the machine to get ready.
The user code entry screen is displayed.	Users are restricted by user management.	Enter the user code (up to eight digits), and then press <b>[OK]</b> .
The Authentication screen appears.	Basic Authentication, Windows Authentication, LDAP Authentication or Integration Server Authentication is set.	Enter your login user name and user password. See "When the Authentication Screen is Displayed", About This Machine.
"You do not have the privileges to use this function." is displayed.	The use of the function is restricted to authenticated users only.	Contact the administrator.
"You do not have the privileges to use this function." continues to be displayed even though you have entered a valid user code.	This user code is not allowed to use the function selected.	Press the <b>[Energy Saver]</b> key. Confirm that the display goes off, and then press the <b>[Energy Saver]</b> key again. The display will return to the user code entry display. When printing under the copier or printer function, press the <b>[Energy Saver]</b> key only after printing has finished.
An error message remains, even if misfed paper is removed.	<ul style="list-style-type: none"> <li>• When a misfeed message appears, it remains until you open and close the cover as required.</li> <li>• Paper is still jammed in the tray.</li> </ul>	Clear misfed paper, and then open and close the front cover. see p.93 "Clearing Misfeeds".
Original images are printed on the reverse side of the paper.	You may have loaded the paper incorrectly.	Load paper correctly. Place paper in the paper tray with the print side up. Load paper into the bypass tray with the print side down. See p.74 "Orientation-Fixed Paper or Two-Sided Paper".



Problem	Cause	Solution
Misfeeds occur frequently.	The tray's side fences may not be locked.	<ul style="list-style-type: none"> <li>Remove the paper. See p.93 "Removing Jammed Paper".</li> <li>Check the side fences are locked. See p.75 "Changing the Paper Size".</li> </ul>
Misfeeds occur frequently.	The tray's end fence may not be set properly.	<ul style="list-style-type: none"> <li>Remove the paper. See p.93 "Removing Jammed Paper".</li> <li>Check the end fence is set properly. See p.75 "Changing the Paper Size".</li> </ul>
Misfeeds occur frequently.	Paper of undetectable size has been loaded.	<ul style="list-style-type: none"> <li>Remove the paper. See p.93 "Removing Jammed Paper".</li> <li>When loading the paper of undetectable size, specify the paper size in "Tray Paper Size". See "Paper Size: Tray 1-7", General Settings Guide and "Copy Paper", About This Machine.</li> </ul>
Misfeeds occur frequently.	There is a foreign object on the finisher tray.	<ul style="list-style-type: none"> <li>Remove the paper. See p.93 "Removing Jammed Paper".</li> <li>Do not place anything on the finisher tray. It may cause a paper jam.</li> </ul>
Misfeeds occur frequently.	The staple cartridge is not set correctly.	The Booklet Finisher requires the saddle stitch stapler cartridge also. See p.90 "Adding Staples".
Cannot print in duplex mode.	[1 Sided Copy] is selected for Paper Type: Tray 1-7.	Select [2 Sided Copy] for Paper Type: Tray 1-7 See "Paper Size: Tray 1-7", General Settings Guide.
Cannot print in duplex mode.	You cannot select duplex printing if the paper type is set to [OHP], [Tab Stock], [Translucent] or [Label Paper].	Select a paper type that allows duplex printing. See "Paper Size: Tray 1-7", General Settings Guide.
Authentication failed.	The entered login user name or login password is not correct.	Inquire the user administrator for the correct login user name and login password.
Authentication failed.	The machine cannot perform authentication.	Contact the administrator.
The selected file(s) contained file(s) without access privileges. Only file(s) with access privileges will be deleted.	You have tried to delete files without the authority to do so.	Files can be deleted by the person who created the file. To delete a file which you are not authorized to delete, contact the person who created the file.

## ❖ Document Server

Problem	Cause	Solution
"Exceeded max. number of pages per file. Do you want to store the scanned pages as 1 file?" appears.	The number of scanned pages exceeds the capacity per file of the Document Server.	To store scanned pages as a file, press <b>[Store File]</b> . Scanned data is stored as a file in the Document Server. If you do not want to store scanned pages, press <b>[No]</b> . Scanned data is deleted.
You forgot your password.	You cannot access a protected file without entering the password.	Contact the administrator. To delete the files stored in the document server, select <b>[Delete All Files in Document Server]</b> . As this will permanently delete every single file, make sure the document server does not contain any files you want to keep. See "Delete All Files in Document Server", General Settings Guide.
You cannot find out what is stored in a file.	You may not be able to ascertain the contents of a file simply from the file name.	You can switch the Select File screen between <b>[List]</b> and <b>[Thumbnail]</b> display to check the contents of the file. In list display, the file name, date and time of storage, and user name are shown. In thumbnail display, an image of the stored file appears. You can enlarge the image by pressing <b>[Preview]</b> . Use the Select File screen to check information other than the file name. See "Checking the Details of a Stored Document", Copy/Document Server Reference.
Memory frequently becomes full.	The document server memory is full.	Delete unnecessary files. On the file selection display, select unnecessary files, and then press <b>[Delete File]</b> . If this does not increase available memory, do the following. <ul style="list-style-type: none"> <li>• Switch to the scanner screen, and then delete unnecessary files stored under the scanner function.</li> <li>• Switch to the printer screen, and then delete unnecessary files stored under Sample Print, Locked Print, Hold Print, or Stored Print.</li> </ul>

Problem	Cause	Solution
You want to check print quality before making a large print run.	You can print a single copy without specifying the setting again.	Check print quality by printing out only the first set using the <b>[Sample Copy]</b> key.
"Original is being scanned by another function. Please wait." appears.	Copier or Scanner function is in use.	To cancel a job in progress, first press <b>[Exit]</b> , and then press the <b>[Copy]</b> key or <b>[Scanner]</b> key. Next, press the <b>[Stop]</b> key. When the message "The Stop key was pressed. Stop copying?" press <b>[Stop]</b> .
"Cannot display preview of this page." appears, and you can not check the thumb nail image.	The image data may have been corrupted.	Pressing <b>[Exit]</b> displays the preview screen without a thumbnail.

 **Note**

- ❑ If you cannot make copies as you want because of paper type, paper size, or paper capacity problems, use recommended paper. See "Copy Paper", About This Machine.
- ❑ Using curled paper often causes misfeeds, soiled paper edges, or slipped positions while performing staple or stack printing. When using curled paper, take the stiffness out of the paper with your hands to straighten out the curl, or load the paper up side down. Also, to prevent paper from curling, lay paper on a flat surface, and do not lean it against the wall.

## When a Job is Not Performed

1

If you cannot execute a function, it may be that the machine is being held up by another function.

If you cannot execute a function, terminate any other functions currently active, and then try executing the function again. In certain cases, you can carry out another job (copier, document server, printer, scanner) without canceling the current job being performed. Performing multiple functions simultaneously like this is called "Multi-accessing".

### Combination Chart

#### ❖ **Function Compatibility**

The chart shows Function Compatibility when print priority is set to "Interleave". See "Print Priority", General Settings Guide.

△ : Simultaneous operations are possible.

● : Operation is enabled when the relevant function key is pressed and remote switching (of the scanner/external extension) is done.

○ : Operation is enabled when the **【Interrupt】** key is pressed to interrupt the preceding operation.

→ : Operation is performed automatically once the preceding operation ends.

× : The operation must be started once the preceding operation ends. (Simultaneous operations are not possible.)

Mode after you select		Copy			Interrupt Copying		Printer			Scanner		TWAIN		Document Server		DeskTopBinder		Web Document Server	
		Operations for Copying	Stapling	Sort	Operations for Copying	Copying	Data Reception	Printing	Stapling	Operations for Scanning	Scanning	Scanning	Operations for Document Server	Scanning a Document to Store in Document Server	Printing from Document Server	Printing from Document Server	Printing		
Mode before you select		Operations for Copying	Stapling	Sort	Operations for Copying	Copying	Data Reception	Printing	Stapling	Operations for Scanning	Scanning	Scanning	Operations for Document Server	Scanning a Document to Store in Document Server	Printing from Document Server	Printing from Document Server	Printing		
Copy	Operations for Copying	×	×	×	○	○	△	△	△	●	●	●	●	●	●	△	△		
	Stapling	△ <sup>*1</sup>	→ <sup>*1</sup>	→ <sup>*1</sup>	○	○ <sup>*4</sup>	△	△	→	●	● <sup>*2</sup>	×	●	● <sup>*2</sup>	△ <sup>*3</sup>	△	△ <sup>*3</sup>		
	Sort	△ <sup>*1</sup>	→ <sup>*1</sup>	→ <sup>*1</sup>	○	○	△	△	△	●	● <sup>*2</sup>	×	●	● <sup>*2</sup>	△	△	△		
Interrupt Copying	Operations for Copying	○	○	○	×	×	△	△	△	○	○	○	×	×	×	△	△		
	Copying	○	○	○	×	×	△	→	→	○	○	○	×	×	×	→	→		
Printer	Data Reception	△	△	△	△	△	→	→	→	△	△	△	△	△	△	△	△		
	Print	Printing	△	△	△	○	○	△	→	→	△	△	△	△	△	△	△		
		Stapling	△	→	△	○	○ <sup>*4</sup>	△	→	→	△	△	△	△	△	△ <sup>*3</sup>	△ <sup>*3</sup>	△ <sup>*3</sup>	
Scanner	Operations for scanning	●	●	●	○	○	△	△	△	×	×	●	●	●	△	△	△		
	Scanning	●	● <sup>*2</sup>	● <sup>*2</sup>	○	○	△	△	△	×	×	×	●	● <sup>*2</sup>	△	△	△		
TWAIN	Scanning	×	×	×	×	×	△	△	△	×	×	×	×	×	△	△	△		

Mode after you select		Copy			Interrupt Copying		Printer			Scanner		TWAIN		Document Server		DeskTopBinder		Web Document Server	
		Operations for Copying	Stapling	Sort	Operations for Copying	Copying	Data Reception	Printing	Stapling	Operations for Scanning	Scanning	Scanning	Operations for Document Server	Scanning a Document to Store in Document Server	Printing from Document Server	Printing from Document Server	Printing		
Mode before you select		Operations for Copying	Stapling	Sort	Operations for Copying	Copying	Data Reception	Printing	Stapling	Operations for Scanning	Scanning	Scanning	Operations for Document Server	Scanning a Document to Store in Document Server	Printing from Document Server	Printing from Document Server	Printing		
Document Server	Operations for Document Server	●	●	●	○	○	△	△	△	●	●	●	×	×	×	△	△		
	Scanning a Document to Store in Document Server	●	×	×	○	○	△	△	△	●	● <sup>*2</sup>	×	×	×	×	△	△		
	Printing from Document Server	●	△	△	○	○	△	△	△	△	△	△	△	△ <sup>*5</sup>	△ <sup>*5</sup>	△ <sup>*5</sup>	△	△	
DeskTop-Binder	Printing from Document Server	△	△	△	○	○	△	△	△	△	△	△	△	△	△	×	△		
Web Document Server	Printing	△	△	△	△	△	△	△	△	△	△	△	△	△	△	△	×		

\*1 Simultaneous operations are only possible after the preceding job documents are all scanned and **[New Job]** key appears.  
 \*2 You can scan a document after the preceding job documents are all scanned.  
 \*3 During stapling, printing automatically starts after the current job.  
 \*4 Stapling is not available.  
 \*5 Simultaneous operation become possible after you press **[New Job]** key.

 **Note**

- Stapling cannot be used at the same time for multiple functions.
- If the machine is capable of executing multiple functions simultaneously, specify which function should have priority in “Print Priority”. This setting is factory-preset to “Display Mode”. For setting of Printing Priority Function, see “Print Priority”, General Settings Guide.
- When Finisher or Booklet Finisher is installed on the machine, you can specify the output tray where documents are delivered. See “Output tray settings”, General Settings Guide.
- Operation speed might be reduced if you scan originals while a print job is in progress.





# 2. Troubleshooting When Using the Copy Function

This chapter explains likely causes of and possible solutions for copier function problems.

## When a Message Appears

This section explains the machine's main messages. If other messages appear, follow the instructions they contain.

### Important

- ❑ For messages that are not listed here, see p.9 “When You Have Problems Operating the Machine”.

Message	Cause	Solution
Cannot detect original size.	Improper original is placed.	Select paper manually, not in Auto Paper Select mode, and do not use Auto Reduce/Enlarge function. See “Sizes difficult to detect”, Copy/Document Server Reference.
Cannot detect original size.	Improper original is placed.	Place the original on the exposure glass. See “Placing Originals on the Exposure Glass” and “Sizes difficult to detect”, Copy/Document Server Reference.
Cannot detect original size.	Original is not placed.	Place your originals.
Check original orientation.	Original is not placed in a proper orientation.	Change the orientation of the original.
Check paper size.	Improper paper size is set.	If you press the <b>[Start]</b> key, copy will start onto the selected paper.
Rotate Sort is not available with this paper size.	A size of paper for which Rotate Sort is not available is selected.	Select the proper paper size. See “Sort”, Copy/Document Server Reference.
Rotate Sort is not available with this paper size.	A size of paper for which Rotate Sort is not available is selected.	Select the proper paper size. See “Sort”, Copy/Document Server Reference.

Message	Cause	Solution
Cannot punch this paper size.	The Punch function cannot be used with paper size selected.	<p>The following paper sizes are available for Punch mode:</p> <ul style="list-style-type: none"> <li>• 2 holes: A3, B4, A4, B5, A5, B6, A6, 12"×18", 11"×17", Legal(8<sup>1</sup>/<sub>2</sub>"×14"), Letter(8<sup>1</sup>/<sub>2</sub>"×11"), Half Letter (5<sup>1</sup>/<sub>2</sub>"×8<sup>1</sup>/<sub>2</sub>"), Executive (7<sup>1</sup>/<sub>4</sub>"×10<sup>1</sup>/<sub>2</sub>"), F/GL (8"×13"), Foolscap (8<sup>1</sup>/<sub>2</sub>"×13"), Folio (8<sup>1</sup>/<sub>4</sub>"×13"), 11"×15", 11"×14", 10"×15", 10"×14", 8<sup>1</sup>/<sub>4</sub>"×14", 8"×10", 8K, 16K. Select one of these sizes.</li> <li>• 3 holes: A3, B4, A4, B5, 12"×18", 11"×17", Letter(8<sup>1</sup>/<sub>2</sub>"×11"), Executive (7<sup>1</sup>/<sub>4</sub>"×10<sup>1</sup>/<sub>2</sub>"), 11"×15", 11"×14", 8K, 16K. Select one of these sizes.</li> <li>• 4 holes: Metric version: A3, B4, A4, B5, 12"×18", 11"×17", Letter(8<sup>1</sup>/<sub>2</sub>"×11"), Executive (7<sup>1</sup>/<sub>4</sub>"×10<sup>1</sup>/<sub>2</sub>"), 11"×15", 11"×14", 10"×15", 10"×14", 8K, 16K. Select one of these sizes. Narrow 2 × 2 version: A3, B4, A4, B5, A5, B6, 12"×18", 11"×17", Legal(8<sup>1</sup>/<sub>2</sub>"×14"), Letter(8<sup>1</sup>/<sub>2</sub>"×11"), Half Letter (5<sup>1</sup>/<sub>2</sub>"×8<sup>1</sup>/<sub>2</sub>"), Executive (7<sup>1</sup>/<sub>4</sub>"×10<sup>1</sup>/<sub>2</sub>"), F/GL (8"×13"), Foolscap (8<sup>1</sup>/<sub>2</sub>"×13"), Folio (8<sup>1</sup>/<sub>4</sub>"×13"), 11"×15", 11"×14", 10"×15", 10"×14", 8K, 16K. Select one of these sizes.</li> </ul>
Stapling capacity exceeded.	The number of sheets per set is over the staple capacity.	Check the stapler capacity. See "Supplementary Informations", Copy/Document Server Reference.
Cannot staple paper of this size.	The Staple function cannot be used with paper size selected.	Select a paper size that can be used in Staple mode. See "Supplementary Informations", Copy/Document Server Reference.

Message	Cause	Solution
Duplex is not available with this paper size.	A paper size not available in Duplex mode has been selected.	The following paper sizes are available for Duplex mode: A3☐, B4☐, A4☐☐, B5☐☐, A5☐☐, B6☐, A6☐, 12"×18"☐, 11"×17"☐, Legal (8 <sup>1</sup> / <sub>2</sub> "×11")☐, Letter (8 <sup>1</sup> / <sub>2</sub> "×11")☐☐, Half Letter (5 <sup>1</sup> / <sub>2</sub> "×8 <sup>1</sup> / <sub>2</sub> ")☐☐, Executive (7 <sup>1</sup> / <sub>4</sub> "×10 <sup>1</sup> / <sub>2</sub> ")☐☐, F/GL (8"×13")☐, Foolscap (8"×13")☐, Folio (8 <sup>1</sup> / <sub>4</sub> "×13")☐, 11"×15"☐, 11"×14"☐, 10"×14"☐, 8 <sup>1</sup> / <sub>4</sub> "×14"☐, 8"×10"☐, 8K☐, 16K☐☐. Select one of these sizes.
Maximum number of sets is nn. (A figure is placed at n.)	The number of copies exceeds the maximum copy quantity.	You can change the maximum copy quantity. See "Max. Number of Sets", General Settings Guide.
File being stored exceeded max. number of pages per file. Copying will be stopped.	The scanned originals have too many pages to store as one document.	Press <b>[Exit]</b> , and then store again with an appropriate number of pages.
Magazine or Booklet mode is not available due to mixed image mode.	You selected the Magazine or Booklet function for originals scanned using different functions, such as copy and printer.	Make sure originals for the Magazine or Booklet function are scanned using the same function.
Orig. is being scanned by another function. Please wait.	Document Server or Scanner function is in use.	To cancel the job in process, press <b>[Exit]</b> , and then press the <b>[Document Server]</b> or <b>[Scanner]</b> key. Next, press the <b>[Stop]</b> key. When the message "The Clear / Stop key was pressed. Are you sure you want to stop scanning?" appears, press <b>[Cancel]</b> .
You do not have the privileges to use this function.	This user code is not allowed to use the function selected.	Contact the administrator.
You do not have the privileges to use this function.	This user code is not allowed to use the function selected.	If the message continues to be displayed and you cannot switch the screen, press the <b>[Energy Saver]</b> key. Confirm that the display goes off, and then press the <b>[Energy Saver]</b> key again. The display will return to the user code entry display. When printing under the copier or printer function, press the <b>[Energy Saver]</b> key only after printing has finished.

Message	Cause	Solution
Authentication has failed.	The entered login user name or login password is not correct.	Inquire the user administrator for the correct login user name and login password.
Authentication has failed.	The machine cannot perform authentication.	Contact the administrator.
The selected file(s) contained file(s) without access privileges. Only file(s) with access privileges will be deleted.	You have tried to delete files without the authority to do so.	Files can be deleted by the person who created the file. To delete a file which you are not authorized to delete, contact the person who created the file.
Please wait.	The destination list is being updated from the network using SmartDeviceMonitor for Admin. Depending on the number of destinations to be updated, there may be some delay before you can resume operation. Operations are not possible while this message is displayed.	Wait until the message disappears. Do not switch off the power while this message is displayed.
It will be necessary to start over and reload the tab stock to the trays.	A misfeed occurred when unneeded tab stock was ejected.	Remove the jammed sheet. If cycle printing is specified for tab stock sheets, both needed and unneeded tab stock is ejected when copying restarts. Reload the tab stock trays before the new print cycle begins. After resetting the tab stock pages, press <b>[Exit]</b> . To resume printing, press the <b>[Start]</b> key.

❖ **Connect Copy**

Message	Cause	Solution
Cannot connect to the sub-machine. Check the status of the sub-machine.	<ul style="list-style-type: none"> <li>The <b>?</b> indicator is lit.</li> <li>The hard disk of the sub-machine is malfunctioning.</li> </ul>	Press <b>[Exit]</b> on the main machine and follow the instructions on the display.
Cannot print from the sub-machine. Check the status of the sub-machine.	A paper misfeed has occurred on the sub-machine, or toner or other supplies need to be replenished.	Follow the instructions displayed. For details, see p.87 "Adding Toner", p.93 "Removing Jammed Paper", p.106 "Removing Jammed Staples". If the sub-machine's display indicates that a cover is open, follow the instructions displayed.

Message	Cause	Solution
Cannot print from the sub-machine. Check the status of the sub-machine.	The sub-machine's User Tools menu is open.	Press the <b>[User Tools]</b> key to close the User Tools menu.
Sub-machine is in Interrupt mode.	The sub-machine is in Interrupt mode.	Press the <b>[Interrupt]</b> key on the sub-machine to cancel Interrupt mode.
Sub-machine does not have the same paper setting(s).	Paper type or tray settings on the two machines do not match.	Make the same settings on both machines.
The Cover Sheet setting(s) of the sub-machine is different from the main machine.	Cover settings on the two machines do not match.	Make the same settings on both machines.
The Slip Sheet setting(s) of the sub-machine is different from the main machine.	Slip Sheet settings on the two machines do not match.	Make the same settings on both machines.
The Designation Sheet setting(s) of sub-machine is different from main machine.	Designation Sheet settings on the two machines do not match.	Make the same settings on both machines.
Sub-machine paper settings must be the same to use this tray.	Paper tray settings on the two machines do not match.	Make the same settings on both machines.
No stamp data in the sub-machine.	Stamp data on the sub-machine has been deleted.	Reprogram the stamp on the sub-machine.
Cannot print from the sub-machine. Sub-machine will be disconnected.	The sub-machine has stopped due to power failure or communication error.	Continue copying using the main machine.
Z-fold is available only when Sort mode is selected in Connect Copy.	Sort has not been selected with Z-fold.	Select the Sort function.

## Reference

p.9 "When You Have Problems Operating the Machine"

# Display During Connect Copy

This section explains about the display during Connect Copy.

2

Problem	Cause	Solution
<b>[Connect Copy]</b> is not displayed.	The sub-machine's main power is off.	Turn on the sub-machine's main power.
<b>[Connect Copy]</b> is not displayed.	Functions that cannot be used with Connect Copy are selected on the main machine (such as storing or copying the first page of a document in the Document Server).	Cancel the functions selected on the main machine.
<b>[Connect Copy]</b> is not displayed.	The main machine is in Interrupt mode.	Press the <b>[Interrupt]</b> key on the sub-machine to cancel Interrupt mode.
<b>[Connect Copy]</b> is not displayed.	The <b>[Connect Copy Key Display]</b> setting is off.	Select <b>[Display]</b> for the <b>[Connect Copy Key Display]</b> setting.
<b>[Connect Copy]</b> is not displayed.	The cable connecting the two machines is damaged.	Contact your service representative.
<b>[Connect Copy]</b> is not displayed.	The <b>!</b> is lit.	Follow the instructions displayed.
<b>[Connect Copy]</b> appears faded.	Functions that cannot be used with Connect Copy have been set.	Press the <b>[Clear Modes]</b> key to clear the settings.

# If Connect Copy is Cancelled

This section explains about causes and remedies when Connect Copy is cancelled.

Problem	Cause	Solution
The machine cancels Connect Copy.	The main machine's main power is off, or the operation switch has been pressed.	Turn on the sub-machine's main power or operation switch, and then press <b>[Connect Copy]</b> .
The machine cancels Connect Copy.	The sub-machine's main power is off.	A message instructing you to check the sub-machine appears on the display of the main machine. Press <b>[Cancel]</b> to clear Connect Copy. Turn on the sub-machine's main power, press <b>[Connect Copy]</b> and then make your settings again.
The machine cancels Connect Copy.	The Weekly Timer setting is coming into effect on the main machine.	Turn on the main machine's operation switch , and then press <b>[Connect Copy]</b> .
An error message indicates the main machine has broken down.	The <b>!</b> is lit.	Copying is not possible. Follow the instructions displayed.

# If You Cannot Exit from Connect Copy

This section explains about causes and remedies if you cannot exit from Connect Copy.

Problem	Cause	Solution
There is no response when you press <b>[Connect Copy]</b> .	Scanning is in progress.	Press the <b>[Stop]</b> key on the main machine, and then press <b>[Stop]</b> .
There is no response when you press <b>[Connect Copy]</b> .	Copying is in progress.	Press the <b>[Stop]</b> key on the main machine, and then press <b>[Stop]</b> .
There is no response when you press <b>[Connect Copy]</b> .	A paper misfeed has occurred on either the main machine or sub-machine.	Follow the instructions displayed. For details, see p.93 "Removing Jammed Paper" and p.106 "Removing Jammed Staples". If the sub-machine's display indicates that a cover is open, follow the instructions displayed.
There is no response when you press <b>[Connect Copy]</b> .	A paper misfeed has occurred on either the main or sub-machine.	To cancel Connect Copy, Press the <b>[Stop]</b> key on the main machine, and then press <b>[Stop]</b> .
There is no response when you press <b>[Connect Copy]</b> .	A paper misfeed has occurred on one of the machine, or toner or other supplies need to be replaced.	Follow the instructions displayed. For details, see p.65 "Loading paper", p.87 "Adding Toner", and p.93 "Removing Jammed Paper".
There is no response when you press <b>[Connect Copy]</b> .	A paper misfeed has occurred on one of the machine, or toner or other supplies need to be replaced.	To cancel Connect Copy, press the <b>[Stop]</b> key on the main machine, and then press <b>[Stop]</b> .
There is no response when you press <b>[Connect Copy]</b> .	A paper misfeed has occurred during stapling.	Removed the jammed paper. For details, see p.106 "Removing Jammed Staples". To cancel Connect Copy, press the <b>[Stop]</b> key on the main machine, and then press <b>[Stop]</b> .



# When You Cannot Make Clear Copies

This section explains likely causes of and possible solutions for unclear copies.

Problem	Cause	Solution
Copies appear dirty.	Image density is too high.	Adjust the image density. See "Adjusting Copy Image Density", Copy/Document Server Reference.
Copies appear dirty.	Auto Image Density is not selected.	Adjust the auto density. See "Adjusting Copy Image Density", Copy/Document Server Reference.
The reverse side of an original image is copied.	Image density is too high.	Adjust the image density. See "Adjusting Copy Image Density", Copy/Document Server Reference.
The reverse side of an original image is copied.	Auto Image Density is not selected.	Adjust the auto density. See "Adjusting Copy Image Density", Copy/Document Server Reference.
A shadow appears on copies if you use pasted originals.	Image density is too high.	Adjust the image density. See "Adjusting Copy Image Density", Copy/Document Server Reference. Change the orientation of the original. Put mending tape on the pasted part.
The same copy area is dirty whenever making copies.	The exposure glass or ADF is dirty.	Clean them. See p.114 "Maintaining Your Machine".
The same copy area is dirty whenever making copies.	The original that has already been printed is scanned.	Select <b>[Generation Copy]</b> , and then begin copying. See "Generation Copy", Copy/Document Server Reference.
Copies are too light.	Image density is too light.	Adjust the image density. See "Adjusting Copy Image Density", Copy/Document Server Reference.
Copies are too light.	A light copy may result when you use damp or rough grain paper.	Use the recommended paper. also, use paper that has been stored in the recommended temperature and humidity condition. See "Copy Paper", About This Machine. Contact your service representative.
Copies are too light.	Toner bottle is almost empty.	Add toner. See p.87 "Adding Toner".
Parts of images are not copied.	The original is not set correctly.	Set originals correctly. See "Placing Originals", Copy/Document Server Reference.
Parts of images are not copied.	The correct paper size is not selected.	Select the proper paper size.

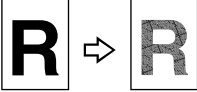
Problem	Cause	Solution
Images appear only partially.	The paper is damp.	Use paper that has been stored in the recommended temperature and humidity condition. See "Copy Paper", About This Machine.
Black lines appear.	The exposure glass is dirty.	Clean them. See p.114 "Maintaining Your Machine".
White lines appear.	The exposure glass is dirty.	Clean them. See p.114 "Maintaining Your Machine".
White lines appear.	When  is blinking, toner is beginning to run out.	Add toner. See p.87 "Adding Toner".
Copies are blank.	The original is not set correctly.	When using the exposure glass, face the originals down. When using the ADF, face them up.
<p>A moiré pattern is produced on copies.</p> 	Your original has a dot pattern image or many lines.	Place the original on the exposure glass at a slight angle.
Black spots appear on the copy of a photographic print.	Because of high humidity, the photographic print has stuck to the exposure glass.	<p>Place the print on the exposure glass in either of the following ways:</p> <ul style="list-style-type: none"> <li>• Place an OHP transparency on the exposure glass, and then place the print on top of the OHP transparency.</li> <li>• Place the print on the exposure glass, and then place two or three sheets of white paper on top of it. Leave the auto-document feeder (ADF) open when copying.</li> </ul>

# When You Cannot Make Copies As Wanted

This section explains likely causes of and possible solutions for unclear copies.

## ❖ Basic

Problem	Cause	Solution
Misfeeds occur frequently.	The number of sheets loaded exceeds the capacity of the machine.	Load paper only as high as the upper limit markings on the side fence of the paper tray or bypass tray. See "Copy Paper", About This Machine.
Misfeeds occur frequently.	The paper is damp.	Use paper that has been stored in the recommended temperature and humidity condition. See "Copy Paper", About This Machine.
Misfeeds occur frequently.	The paper is too thick or too thin.	Use recommended paper. See "Copy Paper", About This Machine.
Misfeeds occur frequently.	The copy paper is wrinkled or has been folded/creased.	Use recommended paper. Use paper that has been stored in the recommended temperature and humidity condition. See "Copy Paper", About This Machine.
Misfeeds occur frequently.	Printed paper is being used.	Use recommended paper. Do not use paper that has been already copied or printed onto. See "Copy Paper", About This Machine.
Copy paper becomes creased.	The paper is damp.	Use paper that has been stored in the recommended temperature and humidity condition. See "Copy Paper", About This Machine.
Copy paper becomes creased.	The paper is too thin.	Use recommended paper. See "Copy Paper", About This Machine.
Copies are not stapled.	There are jammed staples in the stapler.	Remove jammed staples. See p.106 "Removing Jammed Staples".
Copies are not stapled.	The number of copies exceeds the capacity of the stapler.	Check the stapler capacity. See "Supplementary Informations", Copy/Document Server Reference.
Copies are not stapled.	Copy paper is curled.	Turn the copy paper over in the tray.
Staples are wrongly positioned.	Originals are not set correctly.	Check the correct position to place the originals. See "Staple", Copy/Document Server Reference.

Problem	Cause	Solution
You cannot combine several functions.	Selected functions cannot be used together.	Check the combination of functions and make the settings again. See "Function Compatibility", Copy/Document Server Reference.
When sorting, the pages are divided into two blocks.	The memory became full in the middle of sorting and the pages were delivered in two blocks.	You can interrupt copying when the memory becomes full. See "Memory Full Auto Scan Restart", General Settings Guide.
Paper does not output during printing with stapling.	When you stop printing while using the staple function, paper not stapled during printing may be left in the staple unit.	Press the <b>[Clear Modes]</b> key and cancel copy settings, including stapling.
The copy is grayed out or a text pattern appears in the background of the copy.	You have copied a copy-guarded document protected from unauthorized copying.	Check the document. See "Using [Data Security for Copying]", Printer Reference.
Images are skewed.	The side fences in the paper feed tray is not locked.	Make sure the paper guide is locked. See p.75 "Changing the Paper Size".
Images are skewed.	The paper is feeding in at a slant.	Load the paper correctly. See p.65 "Loading paper".

❖ Edit

Problem	Cause	Solution
In Double Copies mode, parts of the original image are not copied.	Combination of original and copy paper is not correct.	Select A3 <input type="checkbox"/> for A4 <input type="checkbox"/> originals and A4 for A5 originals.
In Border, Centre, or Centre/ Border mode, parts of the original image are not copied.	You set a wide erased margin.	Make the margin width narrower. You can adjust it between 2 - 99 mm (0.1" - 3.9"). See "Erase Border Width" and "Erase Centre Width", General Settings Guide.
In Border, Centre, or Centre/ Border mode, parts of the original image are not copied.	Originals are not scanned correctly.	Place the originals correctly.
In Margin Adjustment mode, parts of the original image are not copied.	You set a wide erased margin.	Set a narrower margin with User Tools. You can set the width between 0 - 30 mm (0" - 1.2"). See "Front Margin: Left/Right", "Back Margin: Left/Right", "Front Margin: Top/Bottom" and "Back Margin: Top/Bottom", General Settings Guide.

Problem	Cause	Solution
In Margin Adjustment mode, parts of the original image are not copied.	There is a lack of margin space on the opposite side of the binding position.	Set a narrower margin with User Tools. You can set the width between 0 - 30 mm (0" - 1.2"). See "Front Margin: Left/Right", "Back Margin: Left/Right", "Front Margin: Top/Bottom" and "Back Margin: Top/Bottom", General Settings Guide.
In Image Repeat mode, the original image is not copied repeatedly.	You selected copy paper the same size as the originals, or you did not select the proper reproduction ratio.	Select copy paper larger than the originals or select the proper reproduction ratio.

### ❖ Stamp

Problem	Cause	Solution
The stamp position is wrong.	The paper orientation is wrong.	Check the paper orientation and stamp position.
The stamp is not printed on the back side of sheets when duplex copying.	The back side stamp position is incorrect for the paper size.	Reset the back side stamp position. See "Back Side Stamp Position in Duplex", General Settings Guide.

### ❖ Combine

Problem	Cause	Solution
You cannot make a book from Booklet or Magazine mode by folding copies.	You selected a setting ("Open to left" or "Open to right") that does not match the orientation of originals.	Change the setting. See "Orientation: Booklet, Magazine", General Settings Guide.
When using Combine, parts of the image are not copied.	You specified a reproduction ratio that does not match the sizes of your originals and copy paper.	When you specify a reproduction ratio using Manual Paper Select mode, make sure that the ratio matches your originals and the copy paper. Select the correct reproduction ratio before using Combine mode.
Copies are not in correct order.	You placed the originals in the incorrect order.	When placing a stack of originals in the ADF, the last page should be on the bottom. If you place an original on the exposure glass, start with the first page to be copied.

❖ Duplex

Problem	Cause	Solution
Cannot print in duplex mode.	You have selected a tray which is set to <b>[1 Sided Copy]</b> in <b>[Tray Paper Settings]</b> in <b>[System Settings]</b> .	Set the tray to <b>[2 Sided Copy]</b> in <b>[Tray Paper Settings]</b> in <b>[System Settings]</b> . See "System Settings", General Settings Guide.
Copies are not in correct order.	You placed the originals in the incorrect order.	When placing a stack of originals in the ADF, the last page should be on the bottom. If you place an original on the exposure glass, start with the first page to be copied.
When using Duplex, copy is made Top to Bottom even though <b>[Top to Top]</b> is selected.	You placed the originals in the wrong orientation.	Place the original in the correct orientation. See "Original Orientation", Copy/Document Server Reference.

❖ Connect Copy

Problem	Cause	Solution
You cannot staple, punch, or Z-fold.	The main and sub-machines do not have the same option installed.	Press <b>[Connect Copy]</b> to cancel Connect Copy.
You get different copy results from the main and sub-machines.	The Copy Quality setting differs on the two machines.	Make the same Copy Quality setting on the two machines.

## When Memory is Full

This section explains likely causes of and possible solutions for problems related to full memory.

Message	Cause	Solution
Memory is full. nn originals have been scanned. Press [Print] to copy scanned originals. Do not remove remaining originals. "n" in the message represents a changeable number.	The scanned originals exceeds the number of pages that can be stored in memory.	Press <b>[Print]</b> to copy scanned originals and cancel the scanning data. Press <b>[Stop]</b> to cancel the scanning data and not copy.
Press [Continue] to scan and copy remaining originals.	The machine checked if the remaining originals should be copied, after the scanned originals was printed.	To continue copying, remove all copies, and then press <b>[Resume Printing]</b> . To stop copying, press <b>[Stop]</b> .

### ❖ Connect Copy

Message	Cause	Solution
Sub-machine memory is full. Sub-machine will be disconnected.	The quantity of data exceeds the capacity of the sub-machine.	Continue printing on the main machine.

### Note

- If you set **[Memory Full Auto Scan Restart]** in User Tools to **[On]**, even if the memory becomes full, the memory overflow message will not be displayed. The machine will make copies of the scanned originals first, then automatically proceed scanning and copying the remaining originals. In this case, the resulting sorted pages will not be sequential. See "Input / Output", General Settings Guide.





# 3. Troubleshooting When Using the Printer Function

This chapter explains likely causes of and possible solutions for printer function problems.

## When a Message Appears during Installation of the Printer Driver

This section explains what to do if a message appears when installing the printer driver.

The following describes operations when a message appears during installation of the printer driver. Message number 58 or 34 indicates that the printer driver cannot be installed using Auto Run. Install the printer driver using **[Add Printer]** or **[Install Printer]**.

Message number 58 appears if there is a newer version of the printer driver already installed.

---

### Windows 95/98/Me

---

This section explains the procedure under Windows 95/98/Me.

**1** On the **[Start]** menu, point to **[Settings]**, and then click **[Printers]**.

**2** Double-click the Add Printer icon.

**3** Follow the instructions in Add Printer Wizard.

If the CD-ROM drive is D, the source files of the printer driver are stored in the following location:

- RPCS ("Printer Drivers and Utilities" CD-ROM)  
D:\DRIVERS\RPCS\WIN9X\_ME\ (Language)\DISK1
- PCL 5e ("Printer Drivers and Utilities" CD-ROM)  
D:\DRIVERS\PCL5E\WIN9X\_ME\ (Language)\DISK1
- PCL 6 ("Printer Drivers and Utilities" CD-ROM)  
D:\DRIVERS\PCL6\WIN9X\_ME\ (Language)\DISK1
- PostScript 3 ("Scanner Driver and Utilities" CD-ROM)  
D:\DRIVERS\PS\WIN9X\_ME\ (Language)\DISK1

If the installer starts, click **[Cancel]** to quit.

---

## Windows 2000

---

This section explains the procedure under Windows 2000.

- 1** On the [Start] menu, point to [Settings], and then click [Printers].
- 2** Double-click the Add Printer icon.
- 3** Follow the instructions in Add Printer Wizard.

If the CD-ROM drive is D, the source files of the printer driver are stored in the following location:

- RPCS ("Printer Drivers and Utilities" CD-ROM)  
D:\DRIVERS\RPCS\WIN2K\_XP\Language\DISK1
- PCL 5e ("Printer Drivers and Utilities" CD-ROM)  
D:\DRIVERS\PCL5E\WIN2K\_XP\Language\DISK1
- PCL 6 ("Printer Drivers and Utilities" CD-ROM)  
D:\DRIVERS\PCL6\WIN2K\_XP\Language\DISK1
- PostScript 3 ("Scanner Driver and Utilities" CD-ROM)  
D:\DRIVERS\PS\WIN2K\_XP\Language\DISK1

If the installer starts, click [Cancel] to quit.

---

## Windows XP, Windows Server 2003

---

This section explains the procedure under Windows XP or Windows Server 2003.

- 1** On the [Start] menu, click [Printers and Faxes].
- 2** Click [Add a printer].
- 3** Follow the instructions in Add Printer Wizard.

If the CD-ROM drive is D, the source files of the printer driver are stored in the following location:

- RPCS ("Printer Drivers and Utilities" CD-ROM)  
D:\DRIVERS\RPCS\WIN2K\_XP\Language\DISK1
- PCL 5e ("Printer Drivers and Utilities" CD-ROM)  
D:\DRIVERS\PCL5E\WIN2K\_XP\Language\DISK1
- PCL 6 ("Printer Drivers and Utilities" CD-ROM)  
D:\DRIVERS\PCL6\WIN2K\_XP\Language\DISK1
- PostScript 3 ("Scanner Driver and Utilities" CD-ROM)  
D:\DRIVERS\PS\WIN2K\_XP\Language\DISK1

If the installer starts, click [Cancel] to quit.

## Windows NT 4.0

---

This section explains the procedure under Windows NT 4.0.

- 1** On the [Start] menu, point to [Settings], and then click [Printers].
- 2** Double-click the Add Printer icon.
- 3** Follow the instructions in Add Printer Wizard.

If the CD-ROM drive is D, the source files of the printer driver are stored in the following location:

- RPCS (“Printer Drivers and Utilities” CD-ROM)  
D:\DRIVERS\RPCS\NT4\Language\DISK1
- PCL 5e (“Printer Drivers and Utilities” CD-ROM)  
D:\DRIVERS\PCL5E\NT4\Language\DISK1
- PCL 6 (“Printer Drivers and Utilities” CD-ROM)  
D:\DRIVERS\PCL6\NT4\Language\DISK1
- PostScript 3 (“Scanner Driver and Utilities” CD-ROM)  
D:\DRIVERS\PS\NT4\Language\DISK1

If the installer starts, click [Cancel] to quit.

## If USB Connection Fails

This section explains how to troubleshoot a problem related to USB connection.

Problem	Cause	Solution
The machine is not automatically recognized.	The USB cable is not connected properly.	Turn off the power of the machine, reconnect the USB cable, and then turn it on again.
Windows has already configured the USB settings.	Check whether the computer has identified the machine as an unsupported device.	Open Windows' Device Manager, and then, under <b>[Universal Serial Bus controllers]</b> , remove any conflicting devices. Conflicting devices have a <b>[!]</b> or <b>[?]</b> icon by them. Take care not to accidentally remove required devices. For details, see Windows Help.  When using Windows 2000 / XP or Windows Server 2003, an erroneous device is displayed under <b>[USB Controller]</b> in the <b>[Device Manager]</b> dialog box.
Windows Me and the machine cannot be connected.	You need to download USB Printing Support for Windows Me.	Download USB Printing Support from the supplier's website.  Search the model name you use on the supplier's website, and download USB Printing Support.

3

# When a Message Appears

This section describes the principal messages that appear on the panel display. If a message not described here appears, act according to the message.

## Reference

Before turning the main power off, see “Turning On/Off the Power”, About This Machine.

---

## Status Messages

---

This section describes the machine status messages.

Message	Problem
Ready	This is the default ready message. The machine is ready for use. No action is required.
Printing...	The machine is printing. Wait a while.
Waiting...	The machine is waiting for the next data to print. Wait a while.
Offline	The machine is offline. To start printing, switch the machine online by pressing <b>[Online]</b> key.
Please wait.	The machine is preparing the development unit. Wait a while.
Resetting job...	The machine is resetting the print job. Wait until “Ready” appears on the display panel.
Setting change...	The machine is setting changing. Wait a while.
Hex Dump Mode	In the Hex Dump mode, the machine receives data in hexadecimal format. Turn off the machine after printing, and then turn back on.

## Alert Messages

This section describes the machine Alert messages.

Message	Cause	Solution
Cannot connect with the wireless card. Turn the main power switch off, then check the card. / Problems with the wireless card. / Problems with the wireless board.	<ul style="list-style-type: none"> <li>IEEE 802.11b interface unit was not inserted when the machine was turned on, or it was pulled out after the machine turned on.</li> <li>The settings are not updated although the unit is detected, or errors are found while accessing the unit.</li> </ul>	Turn off the machine and check the IEEE 802.11b interface unit is inserted correctly. Then, turn the machine on again. If the message appears again, call your service representative.
Problems with IEEE 1394 Board.	An error may have occurred in the IEEE 1394 board.	Turn off the main power switch, and back on again. If the message appears again, contact your service representative.
Problem with Hard Disk.	An error has occurred in the hard disk drive.	Turn off the main power switch, and back on again. If the message appears again, contact your service representative.
The entered password is incorrect.	The password of the encrypted PDF file has been entered incorrectly.	Enter the correct password.
USB has a problem.	An error has occurred in the USB interface.	Turn off the main power switch, and back on again. If the message appears again, contact your service representative.
Hardware Problem: Ethernet	An error has occurred in the Ethernet board.	Turn off the main power switch, and back on again. If the message appears again, contact your service representative.
You do not have the privileges to use this function.	Use of this function is restricted.	Contact the administrator.
Authentication has failed.	<ul style="list-style-type: none"> <li>The login user name or password entered is incorrect.</li> <li>The machine currently cannot perform authentication.</li> </ul>	<ul style="list-style-type: none"> <li>Check your login user name and password.</li> <li>Contact the administrator.</li> </ul>
Parallel I/F board has a problem.	An error has occurred in the parallel interface board.	Turn off the main power switch, and back on again. If the message appears again, contact your service representative.
Printer font error.	An error has occurred in the font settings.	Contact your service representative.

Message	Cause	Solution
Memory Overflow	Maximum capacity of PCL 5e/6 or PostScript 3 list display has been exceeded.	Reduce the value of <b>[Resolution]</b> in the printer driver. Alternatively, select <b>[Frame Priority]</b> from <b>[Memory Usage]</b> in <b>[System]</b> . If this message continues to appear after taking these steps, decrease the number of files sent to the machine.

## Checking the Error Log

If files could not be stored due to printing errors, identify the cause of the errors by checking the error log on the control panel.

**1** Press the **[Printer]** key to display the printer screen.

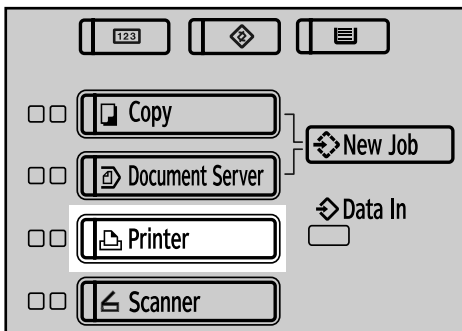

ANR103S

**2** Press **[Error Log]**.

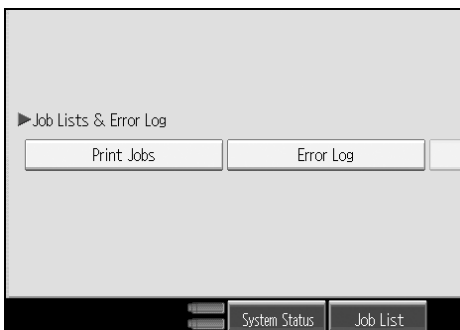

An error log list appears.

### Note

- The most recent 50 errors are stored in the error log. If a new error is added when there are 50 errors already stored, the oldest error is deleted. However, if the earliest error is a Sample Print, Locked Print, Hold Print, or Stored print error, it is not deleted. The error is stored separately until the number of errors reaches 30.
- If the main power switch is turned off, the log is deleted.

# When You Cannot Print

Use the following procedures if printing does not start even after performing **[Print]**.

3

Problem	Cause	Solution
Printing does not start.	The power is off.	Check the cable is securely plugged into the power outlet and the machine. Turn on the main power switch.
Printing does not start.	The machine is set to "Offline".	Press the <b>[Online]</b> key.
Printing does not start.	The cause is displayed on the display of the control panel.	Check the error message or warning status on the display panel and take the required action.
Printing does not start.	The interface cable is not connected correctly.	Connect the interface cable securely. If it has a fastener, fasten that securely as well. See "Connecting to the Interfaces", General Settings Guide.
Printing does not start.	The correct interface cable is not being used.	The type of interface cable you should use depends on the computer. Be sure to use the correct one. If the cable is damaged or worn, replace it. See "Connecting to the Interfaces", General Settings Guide.
Printing does not start.	The interface cable was connected after the machine was switched on.	Connect the interface cable before turning on the machine.
Printing does not start.	If the machine is operating in an extended wireless LAN, failure to print might result from a weak wireless signal.	To check signal status, press the <b>[User Tools]</b> key, and then press <b>[System Settings]</b> on the display panel. On the <b>[Interface Settings]</b> tab, select <b>[IEEE 802.11b]</b> , and then press <b>[Wireless LAN Signal]</b> . If signal quality is poor, move the machine to a location where radio waves can pass or remove objects that might cause interference.  (You can check signal status only when using wireless LAN in the infrastructure mode.)
Printing does not start.	If the machine is operating in an extended wireless LAN, SSID settings are incorrect.	Check using the machine's display panel that the SSID is correctly set. See "Network Settings", General Settings Guide.



Problem	Cause	Solution
Printing does not start.	If the machine is operating in an extended wireless LAN, the receiver's MAC address may be preventing communication with the access point.	Check access point settings when in the infrastructure mode. Depending on the access point, client access may be limited by MAC address. Also, check there are no problems in transmission between access point and wired clients, and between access point and wireless clients.
Printing does not start.	The extended wireless LAN has not started.	Confirm the orange LED is lit, and the green LED is lit or blinks during transmission.
Printing does not start.	The login user name, login password, or driver encryption key is invalid.	Check the login user name, login password, or driver encryption key.
Printing does not start.	Advanced encryption has been set using the Extended Security function.	Check the settings of the Extended Security function with the administrator.
Data-in lamp does not blink or light up.	If the data-in lamp is unlit or not flashing even after performing <b>[Print]</b> , the machine has not received the data.	<ul style="list-style-type: none"> <li>When the machine is connected to a computer via a cable, check the computer print port settings are correct. See "Confirming the Connection Method", Printer Reference.</li> <li>When it is networked with a computer, Contact the administrator.</li> </ul>
The status indicator of the printer is lit.	The cause is displayed on the display of the control panel.	Check the error message on the display panel and take required action. See p.39 "When a Message Appears".
"Updating the destination list... Please wait. Specified destination(s) or sender's name has been cleared." appears.	The destination list is being updated from the network using SmartDeviceMonitor for Admin.	Wait until the message disappears. Do not switch off the power while this message is displayed. Depending on the number of destinations to be updated, there may be some delay before you can resume operation. Operations are not possible while this message is displayed.
<b>[List / Test Print]</b> is disabled.	A mechanical error might have occurred.	Contact your service representative. See "List/Test Print", General Settings Guide.
Printing does not start when using the extended wireless LAN in Ad-hoc mode.	The correct Communication mode is not set.	Turn the main power off and back on. See "Turning On/Off the Power", About This Machine. Or, change the settings for <b>[System Settings]</b> , <b>[Interface Settings]</b> , and <b>[Network]</b> . See "Network Settings", General Settings Guide.

If the printing does not start, consult your service representative.

❖ **When the machine is connected to the computer using the interface cable**

The following shows how to check the print port when the data-in lamp does not light up or blink.

Check if the print port setting is correct. When it is connected using a parallel interface, connect it to LPT1 or LPT2.

For Windows 95/98/Me

- ① Click the **[Start]** button, point to **[Settings]**, and then click **[Printers]**.
- ② Click the icon of the machine. On the **[File]** menu, click **[Properties]**.
- ③ Click the **[Details]** tab.
- ④ In the **[Print to the following port:]** list, confirm the correct port is selected.

For Windows 2000 or Windows NT 4.0

- ① Click the **[Start]** button, point to **[Settings]**, and then click **[Printers]**.
- ② Click the icon of the machine. On the **[File]** menu, click **[Properties]**.
- ③ Click the **[Ports]** tab.
- ④ In the **[Print to the following port(s)]** list, confirm the correct port is selected.

Windows XP

- ① Click the **[Start]** button, and then click **[Printers and Faxes]**.
- ② Click the icon of the machine. On the **[File]** menu, click **[Properties]**.
- ③ Click the **[Ports]** tab.
- ④ In the **[Print to the following port(s)]** list, confirm the correct port is selected.

Windows Server 2003

- ① Click the **[Start]** button, point to **[Settings]**, and then click **[Printers and Faxes]**.
- ② Click the icon of the machine. On the **[File]** menu, click **[Properties]**.
- ③ Click the **[Ports]** tab.
- ④ In the **[Print to the following port(s)]** list, confirm the correct port is selected.

# Other Printing Problems

This section explains likely causes of and possible solutions for problems that can occur when printing from a computer.

Problem	Cause	Solution
Print is smudged.	Settings for thick paper have not been made when printing on thick paper in the bypass tray.	<ul style="list-style-type: none"> <li>PCL 5e/6 and PostScript 3 Select <b>[Thick]</b> in the <b>[Type:]</b> list on the <b>[Paper]</b> tab.</li> <li>RPCS Select <b>[Thick]</b> in the <b>[Paper type:]</b> list on the <b>[Print Settings]</b> tab.</li> </ul>
The print on the entire page is faded.	When  is blinking, toner is beginning to run out.	Add toner. See p.87 "Adding Toner".
The print on the entire page is faded.	The paper is damp.	Use paper that has been stored in the recommended temperature and humidity condition. See "Copy Paper", About This Machine.
The print on the entire page is faded.	The paper is unsuitable.	Use the recommended paper. (Printing on coarse or treated paper might result in faint print image.) See "Copy Paper", About This Machine.
The print on the entire page is faded.	If the <b>[Toner saving]</b> check box is selected in the printer driver settings, the entire page will be faded when printed.	For the RPCS printer driver, <b>[Toner saving]</b> is located on the <b>[Print Quality]</b> tab. For the PostScript 3 printer driver, see PostScript 3 Supplement. See the printer driver Help.
Image bleeds when rubbed.	If you are using thick paper, <b>[Paper type:]</b> might not be set to <b>[Thick]</b> .	On the printer driver's <b>[Setup]</b> tab, set <b>[Paper type:]</b> to <b>[Thick]</b> . See the printer driver Help.
Paper is not fed from the selected tray.	When you are using a Windows operating system, printer driver settings override those set using the display panel.	Set the desired input tray using the printer driver. See the printer driver Help.
The printed image is different from the image on the computer's display.	With certain functions, such as enlargement and reduction, image layout might be different to that on the computer display.	In the application, change the layout, character size, and character settings.
The printed image is different from the image on the computer's display.	You might have selected to replace True Type fonts with machine fonts in the printing process.	To print an image similar to that of the computer display, make settings to print True Type fonts as an image. See the printer driver Help.

Problem	Cause	Solution
Images are printed at slant.	The tray's side fences might not be locked.	Check the side fences are locked. See p.75 "Changing the Paper Size".
Print is slanted.	The paper is feeding in at a slant.	Load the paper correctly. See p.65 "Loading paper".
Misfeeds occur frequently.	The number of sheets loaded exceeds the capacity of the machine.	Load paper only as high as the upper limit markings on the side fences of the paper tray or bypass tray. See "Copy Paper", About This Machine.
Misfeeds occur frequently.	The paper is damp.	Use paper that has been stored in the recommended temperature and humidity condition. See "Copy Paper", About This Machine.
Misfeeds occur frequently.	The paper is too thick or too thin.	Use recommended paper. See "Copy Paper", About This Machine.
Misfeeds occur frequently.	The copy paper is wrinkled or has been folded/creased.	Use recommended paper. Use paper that has been stored in the recommended temperature and humidity condition. See "Copy Paper", About This Machine.
Misfeeds occur frequently.	Printed paper is being used.	Use recommended paper. See "Copy Paper", About This Machine.
Copy paper becomes creased.	The paper is damp.	Use paper that has been stored in the recommended temperature and humidity condition. See "Copy Paper", About This Machine.
Copy paper becomes creased.	The paper is too thin.	Use recommended paper. See "Copy Paper", About This Machine.
White lines appear.	When  is blinking, toner is beginning to run out.	Add toner. See p.87 "Adding Toner".
When printing graphics, the output and the screen are different.	If the printer driver is configured to use the graphics command, the graphics command from the machine is used to print.	If you want to print accurately, set the printer driver to print without using the graphics command. See the printer driver Help.
Garbled characters are printed.	The correct printer language might have not been selected.	Set the correct printer language.
Images are printed in the wrong orientation.	The feed orientation you selected and the feed orientation selected in the printer driver's option setup might not be the same.	Set the machine's feed orientation and the printer driver's feed orientation accordingly. See the printer driver Help.
There is considerable delay between the print start instruction and actual printing.	"Off mode / Sleep mode" might be set.	The machine requires time to warm up if it has been in "Off mode/Sleep mode". Specify "Off mode/Sleep mode" in <b>[System Settings]</b> , <b>[Auto Off Timer]</b> .

Problem	Cause	Solution
There is considerable delay between the print start instruction and actual printing.	Processing time depends on data volume. High volume data, such as graphics-heavy documents, take longer to process.	<p>If the data-in lamp is blinking, data has been received by the printer. Wait for a moment. Making the following setting on the printer driver may reduce the computer's workload.</p> <ul style="list-style-type: none"> <li>❖ <b>PCL 5e/6</b> Select the lower value for <b>[Resolution]</b> on the <b>[Print Quality]</b> tab in the printer properties dialog box.</li> <li>❖ <b>PostScript 3</b> Select the lower value in <b>[Resolution]</b>. The location of this setting is given below. If your operating system is Windows, select <b>[PostScript (optimize for speed)]</b> in <b>[PostScript Output Option]</b>. <b>[PostScript Output Option]</b> is located as follows: <ul style="list-style-type: none"> <li>• Windows 95 / 98 / Me <b>[Print Quality]</b> tab in the printer properties dialog box.</li> <li>• Windows 2000 / XP, Windows Server 2003 <b>[PostScript Output Option]</b> in <b>[PostScript Options]</b> on <b>[Advanced...]</b> on <b>[Layout]</b> tab in the printing preferences dialog box.</li> <li>• Windows NT 4.0 <b>[File]</b> on <b>[Advanced...]</b> on <b>[Document Defaults]</b> tab in the printing preferences dialog box.</li> <li>• Mac OS 9.x <b>[Printer Specifications]</b> in the print dialog box.</li> <li>• Mac OS X <b>[Set 3]</b> tab in <b>[Printer Features]</b> in the print dialog box.</li> </ul> <p>If you use Windows, select <b>[PostScript (optimize for speed)]</b>.</p> <ul style="list-style-type: none"> <li>• Windows 95 / 98 / Me <b>[PostScript output format:]</b> on the <b>[PostScript]</b> tab in the printer properties dialog box.</li> <li>• Windows 2000 / XP, Windows Server 2003 <b>[PostScript Output Option]</b> in <b>[PostScript Options]</b> on <b>[Advanced...]</b> on <b>[Layout]</b> tab in the printing preferences dialog box.</li> <li>• Windows NT 4.0 <b>[File]</b> on <b>[Document Defaults]</b> on <b>[Advanced...]</b> tab in the printing preferences dialog box.</li> </ul> </li> </ul>

Problem	Cause	Solution
There is considerable delay between the print start instruction and actual printing.	Processing time depends on data volume. High volume data, such as graphics-heavy documents, take longer to process.	<p>❖ <b>RPCS</b></p> <p>Select the lower value for <b>[Resolution:]</b> on the <b>[Print Quality]</b> tab in the printer driver's dialog box.</p> <p>Select <b>[Fast]</b> for the <b>[Document type]</b> list on the <b>[Print Quality]</b> tab in the printer driver's dialog box.</p> <p>To enable <b>[Change User Settings...]</b>, select the <b>[User settings]</b> check box.</p> <p>See the printer driver Help.</p>
Images are cut off, or excess is printed.	You may be using paper smaller than the size selected in the application.	Use the same size paper as that selected in the application. If you cannot load paper of the correct size, use the reduction function to reduce the image, and then print. See the printer driver Help.
Page layout is not as expected.	Print areas differ depending on machine used. Information that fits on a single page on one machine may not fit on a single page of another machine.	Adjust the <b>[Printable area:]</b> setting in the <b>[Printer Configuration...]</b> dialog box on the <b>[Print Settings]</b> tab in the RPCS printer driver. See the printer driver Help.
Photo images are coarse.	Some applications print at lower resolution.	Use the application's settings to specify a higher resolution.
Solid lines are printed as broken lines.	Dither patterns do not match.	Make the following settings with the printer driver: Change the <b>[Dithering:]</b> setting on the <b>[Image Adjustments]</b> tab in the <b>[Change User Settings...]</b> dialog box, on the <b>[Print Quality]</b> tab in the RPCS printer driver. See the printer driver Help.
Optional components connected to the machine are not recognized when using Windows 95 / 98 / Me, Windows 2000 / XP, Windows Server 2003, and Windows NT 4.0.	Bidirectional communication is not working.	Set up optional devices on the Properties of the printer. See the printer driver Help.

Problem	Cause	Solution
Duplex printing is malfunctioning.	Duplex printing cannot be done with paper set in the bypass tray.	When using duplex printing, make settings to use paper from a tray other than the bypass tray.
Duplex printing is malfunctioning.	The upper tray cannot be used as an output destination in duplex mode.	Specify a another output tray.
Duplex printing is malfunctioning.	Duplex printing cannot be done with a tray for which <b>[1 Sided Copy]</b> has been specified as Paper Type on the System Settings menu.	Change the Paper Type setting for the tray to <b>[2 Sided Copy]</b> on the System Settings menu. See "System Settings", General Settings Guide.
When using Windows 95 / 98 / Me / 2000 / XP, Windows Server 2003, or Windows NT 4.0, combined printing or booklet printing does not come out as expected.	The correct application or printer driver settings are not made.	Make sure the application's paper size and orientation settings match those of the printer driver. If a different paper size and orientation are set, select the same size and orientation.
A print instruction was issued from the computer, but printing did not start.	User Authentication may have been set.	Contact the administrators.
No transmission when using 1394 interface connection.	<ul style="list-style-type: none"> <li>• Interface connection has not been made.</li> <li>• The correct computer settings are not made.</li> </ul>	Check using the following procedure: <ol style="list-style-type: none"> <li>① Confirm the IEEE 1394 interface cable is connected securely.</li> <li>② Restart the computer. If the error occurs even after executing the above operation, proceed to the following steps.</li> <li>③ Unplug the IEEE 1394 interface cable connected to the computer.</li> <li>④ Run the utility tool for the IEEE 1394 interface board, which is stored in the following path on the CD-ROM "Printer Drivers and Utilities":                \UTILITY\1394\                (For more information about using the utility tool for IEEE 1394, see the README file in the same directory on the CD-ROM.)</li> <li>⑤ Restart the computer.</li> </ol>

Problem	Cause	Solution
PDF files do not print out/cannot perform <b>[PDF Direct Print]</b> .	PDF files are password-protected.	To print password-protected PDF files, enter the password in the <b>[PDF Menu]</b> or on Web Image Monitor. <ul style="list-style-type: none"> <li>• For details about <b>[PDF Menu]</b>, see “PDF Menu”, General Settings Guide.</li> <li>• For details about Web Image Monitor, see the Web Image Monitor Help.</li> </ul>
PDF files do not print out/cannot perform <b>[PDF Direct Print]</b> .	PDF files cannot be printed if they are print-disabled via PDF File Security.	Change the PDF File Security setting.
PDF files do not print out/cannot perform <b>[PDF Direct Print]</b> .	High compression PDF files created using the machine's scanner function cannot print directly.	Open the application used to create the PDF, and then print the file using the application's driver.  Re-save the file in normal (non-compressed) PDF format.  Some types of High Compression PDF files are not supported. Consult your sales representative about the supported file types.
<b>[PDF Direct Print]</b> produces strange or malformed characters.	Fonts were not embedded.	Embed fonts in the PDF file you want to print and then print.
Printing by Bluetooth is slow.	The number of jobs exceeds the capacity of the machine.	Reduce the number of jobs.
Printing by Bluetooth is slow.	<ul style="list-style-type: none"> <li>• A communication error might have occurred.</li> <li>• Interference from IEEE 802.11b (wireless LAN) devices can reduce communication speed.</li> <li>• Bluetooth transmission speeds are not high.</li> </ul>	<ul style="list-style-type: none"> <li>• Remove the machine from close proximity with IEEE 802.11b wireless LAN devices.</li> <li>• If there are active IEEE 802.11b wireless LAN devices or other Bluetooth devices nearby, relocate the machine or disable those devices.</li> </ul>

If the problem cannot be solved, contact your service representative.



# 4. Troubleshooting When Using the Scanner Function

This chapter explains likely causes of and possible solutions for scanner function problems.

## When Scanning is Not Done as Expected

This section explains causes and remedies when scan results are not as expected.

Problem	Cause	Solution
The scanned image is dirty.	The exposure glass or auto document feeder (ADF) is dirty.	Clean these parts. See p.114 "Maintaining Your Machine".
The image is distorted or out of position.	The original was moved during scanning.	Do not move the original during scanning.
The image is distorted or out of position.	The original was not pressed flat against the exposure glass.	Make sure that the original is pressed flat against the exposure glass.
The scanned image is upside down.	The original was placed upside down.	Place the original in the correct orientation. See "Placing Originals", Copy/Document Server Reference.
No image results from scanning.	The original was placed with the front and back reversed.	When the original is placed directly on the exposure glass, the side to be scanned must face down. When the original is fed via the ADF, the side to be scanned must face up. See "Placing Originals", Copy/Document Server Reference.
Images are scanned in rotated.	If you set the original with its upper edge backward and save full color/grey scale images as a TIFF or JPEG file, they are scanned in rotated.	When placing a stack of originals in the ADF, place their lower edges first. See "Various Scan Settings", Scanner Reference.
The scanned image contains white spaces.	<ul style="list-style-type: none"> <li>If you scan originals using functions other than the network TWAIN scanner function, certain paper size and resolution settings may produce scanned images that are larger than the specified size because of margins being added to the sides.</li> <li>If the File Format Converter (optional) is installed, the margins may become wider.</li> </ul>	Scanning at a higher resolution may reduce the margins.

# When You Cannot Send Scanned Files

The following sections explain likely causes of and solutions for Network Delivery and E-mail Sending-related problems.

## When Stored Files Cannot be Accessed

This section explains likely causes of and possible solutions for job access-related problems.

Problem	Cause	Solution
The stored file is locked and is not accessible.	The file, which is password protected, is locked because the password was incorrectly entered ten times.	Contact the administrator.

4

## When You Cannot Browse the Network to Send a Scan file

This section explains likely causes of and possible solutions for the Browser Network failing to operate when files are sent.

Problem	Cause	Solution
The network cannot be browsed when specifying the destination folder.	The following machine settings may not be correct: <ul style="list-style-type: none"> <li>• IPv4 address</li> <li>• Subnet Mask</li> </ul>	Check the settings. See "Network Settings ", General Settings Guide.

## When the TWAIN Driver Cannot be Started

This section explains likely causes of and possible solutions for the TWAIN driver failing to operate.

Problem	Cause	Solution
The Scanner Properties dialog box cannot be displayed.	Advanced encryption has been specified in the extended security setting.	For details about the extended security setting, contact an administrator.

## When Stored Files Cannot be Edited

This section explains likely causes of and possible solutions for the TWAIN driver failing to operate.

Problem	Cause	Solution
Stored files cannot be deleted. File names and passwords cannot be changed. Files cannot be redelivered.	Limits have been imposed using the available extended security function.	Contact the administrator.

## When the Network Delivery Function Cannot be Used

This section explains likely causes of and possible solutions for the Network Delivery function failing to operate.

Problem	Cause	Solution
The network delivery function cannot be used.	The delivery software may be an old version or a security setting may be specified.	Contact the administrator.
The network delivery function cannot be used.	The network delivery function setting is not correct.	Specify it correctly. See "Settings Required to Use the Network Delivery Scanner", General Settings Guide.

## Operations are not possible when messages appear

This section explains likely causes of and possible solutions for messages that appear and when the machine fails to operate.

Message	Cause	Solution
Destination list / machine settings are updated. Selected destinations or function settings have been cleared. Please re-select the settings.	The destination list is being updated from the network using SmartDeviceMonitor for Admin. Depending on the number of destinations to be updated, there may be some delay before you can resume operation. Operations are not possible while this message is displayed.	Wait until the message disappears. Do not switch off the power while this message is displayed.

# When a Message is Displayed

This section explains likely causes of and possible solutions for error messages that may appear on the machine's control panel.

## When a Message is Displayed on the Control Panel

This section explains causes and remedies if an error message appears on the display of the control panel.

### Important

- If a message not described here appears, act according to the message. For information about how to turn off the main power switch, see About This Machine.

4

Message	Cause	Solution
Connection with LDAP server has failed. Check the server status.	A network error has occurred and connection has failed. Try the operation once more.	Try the operation once more. If the message is still shown, the network may be crowded. Check the information of System Settings. See "System Settings", General Settings Guide.
LDAP server authentication has failed. Check the settings.	The user name and password differ from those set for LDAP Authentication.	Make settings correctly for the user name and the password for LDAP server authentication.
The destination list has been updated. Specified destination(s) or sender's name has been cleared.	A specified destination or sender's name was cleared when the destination list in the delivery server was updated.	Specify the destination or sender's name again.
Updating the destination list has failed. Try again?	A network error has occurred.	Check whether the server is connected.
The destination list has been updated. Specified destination(s) or sender's name has been cleared.	A network error has occurred.	If a destination or sender's name was already selected, re-select it after this message disappears.

Message	Cause	Solution
Exceeded max. number of files which can be sent at the same time. Reduce the number of the selected files.	The number of files exceeded the maximum number possible.	Reduce the number of files and send them again.
Cannot detect original size. Place original again, then press the Start key.	You have loaded paper of a size not shown on the paper size selector.	<ul style="list-style-type: none"> <li>Place the original correctly.</li> <li>Specify the scan size.</li> <li>When placing an original directly on the exposure glass, the lifting/lowering action of the ADF triggers the automatic original size detection process. Lift the ADF by more than 30 degrees. See "Placing Originals", Copy/Document Server Reference.</li> </ul>
Exceeded max. No. of results to display. Max.:	Search results have exceeded the max. displayable number.	Search again after changing the search conditions.
You do not have the privileges to use this function.	The machine has not been set to allow you to use the function.	Contact the administrator.
Exceeded max. number of standby files. Try again after the current file is sent.	The maximum number of standby files was exceeded.	There are 100 files waiting in the sending queue for e-mail, Scan to Folder, or delivery functions. Wait until files have been sent.
Exceeded time limit for LDAP server search. Check the server status.	A network error has occurred and connection has failed.	Try the operation once more. If the message is still shown, the network may be crowded. Check the information of System Settings. See "System Settings", General Settings Guide.
The specified group contains some destination(s) that do not have access privileges. Do you want to select only the privileged destination(s)?	The specified group contains some destinations for sending by e-mail and some destinations for sending by Scan to Folder.	To select destinations for sending by e-mail, press <b>[Select]</b> for the message displayed on the e-mail screen. To select destination for sending by Scan to Folder, press <b>[Select]</b> for the message displayed on the Scan to Folder screen.

Message	Cause	Solution
Cannot find the specified path. Please check the settings.	The destination computer name or folder name is invalid.	Check whether the computer name and the folder name for the destination are correct.
Exceeded max. number of alphanumeric characters for the path.	The maximum number of specifiable alphanumeric characters in a path has been exceeded.	The maximum number of characters which can be entered for the path is 128. Check the number of character you entered, and then enter the path again. See "Transmission function", Scanner Reference.
The selected file(s) contained file(s) without access privileges. Only file(s) with access privileges will be deleted.	You have tried to delete files without the authority to do so.	The files can be deleted by the file administrator. To delete a file which you are not authorized to delete, contact the administrator.
Some of selected files are currently in use. They could not be deleted.	You cannot delete a file which is waiting to be transmitted ("Waiting..." status displayed) or whose information is being changed with DeskTopBinder.	Cancel transmission ("Waiting..." status cleared) or the DeskTopBinder setting, and then delete the file.
Selected file is currently in use. Cannot change file name.	You cannot change the name of a file whose status is "Waiting..." or that is being edited with DeskTopBinder.	Change the file name after canceling delivery or completing editing.
Selected file is currently in use. Cannot change password.	You cannot change the name of a file whose status is "Waiting..." or that is being edited with DeskTopBinder.	Delete the password after canceling delivery or completing editing.
Selected file is currently in use. Cannot change user name.	You cannot change the password of a file whose status is "Waiting..." or that is being edited with DeskTopBinder.	A sender's name should be specified before sending e-mail. Send e-mail after specifying the sender's name.

Message	Cause	Solution
Connection with the destination has failed. Check the status and connection. To check the current status, press [Scanned Files Status].	The correct Network settings are not made.	<ul style="list-style-type: none"> <li>• Check the network settings of the client computer.</li> <li>• Check that components such as the LAN cable are connected properly.</li> <li>• Check that the server settings are correct and the server is working properly.</li> </ul>
Authentication with the destination has failed. Check settings. To check the current status, press [Scanned Files Status].	The entered user name or password was invalid.	<ul style="list-style-type: none"> <li>• Check that the user name and password are correct.</li> <li>• Check that the ID and password for the destination folder are correct.</li> <li>• A password of 128 or more characters may not be recognized.</li> </ul>
Sender has not been specified.	The sender's name was not specified.	A sender's name should be specified before sending e-mail. Send e-mail after specifying the sender's name.
Exceeded max. E-mail size. Sending E-mail has been cancelled. Check [Max. E-mail Size] in Scanner Features.	The maximum e-mail size has been exceeded.	<ul style="list-style-type: none"> <li>• Increase the size of [Max. E-mail Size].</li> <li>• Set [Divide &amp; Send E-mail] to [Yes (per Page)] or [Yes (per Max. Size)].</li> </ul> See "Send Settings", General Settings Guide.
Sending the data has failed. The data will be re-sent later.	A network error has occurred and a file was not sent correctly.	Wait until sending is retried automatically after the preset interval. If sending fails again, contact the administrator.
Transmission has failed. To check the current status, press [Scanned Files Status].	While a file was being sent, a network error occurred and the file could not be sent correctly.	Try the operation once more. If the message is still shown, the network may be crowded. Contact the administrator. If multiple files were sent, use the Scanned Files Status screen to check for which file the problem occurred.

Message	Cause	Solution
Transmission has failed. Insufficient memory in the destination hard disk. To check the current status, press [Scanned Files Status].	Transmission has failed. There was not enough free space on the hard disk of the SMTP server, FTP server, or client computer at the destination.	Allocate sufficient space.
Output buffer is full. Sending the data has been cancelled. Please try again later.	The file being stored has exceeded the max. number of pages for one file.	Specify whether to use the data or not. Scan the pages that were not scanned and store them as a new file. See Storing Files Using the Scanner Function Scanner Reference.
Exceeded maximum number of file to store. Delete all unnecessary files.	Too many files are waiting to be delivered.	Please try again after they have been delivered.
Exceeded max. number of stored files. Cannot send the scanned data as capturing files is unavailable.	Too many files are waiting to be delivered.	Please try again after they have been delivered.
Exceeded max. number of files which can be used in Document Server at the same time.	The maximum number of files that can be stored in the document server has been exceeded.	Check the files stored by the other functions, and then delete unneeded files. See "Document Server", Copy/Document Server Reference.
Entered protection code for destination is incorrect. Please re-enter.	The correct protect destination code was not entered.	Make sure the protection code is correct, and then enter it again. See "Registering a Protection Code", General Settings Guide.
Entered user code is not correct.	The entered password is incorrect.	Check the authentication setting, and then specify a correct password.



Message	Cause	Solution
Exceeded max. number of alphanumeric characters.	The maximum enterable number of alphanumeric characters has been exceeded.	Make sure the maximum number of characters which can be entered, and then enter it again. See "Values of various set items for transmission/storage/delivery function", Scanner Reference.
Authentication has failed.	The entered login user name or login password is incorrect.	Check the login user name and login password. The machine is unable to authenticate. Contact an administrator.
The entered path is not correct. Please re-enter.	The entered path format is incorrect.	Confirm the destination computer and the path, and then enter it again.
Captured file exceeded max. number of pages per file. Cannot send the scanned data.	The maximum number of pages per file has been exceeded.	Reduce the number of pages in the transmitted file, and then resend the file. See "Storage function", Scanner Reference.
Original is being scanned by another function. Please wait. <b>[Copier][Document Server]...</b>	The machine is using another function such as copying.	Retry scanning after the operation with the other function is completed.
E-mail address entered is not correct. Please re-enter.	The entered e-mail address is incorrect.	Make sure the e-mail address is correct, and then enter it again.
Memory is full. Scanning has been cancelled. Press [Send] to send the scanned data, or press [Cancel] to delete.	Because there is not enough free hard disk space in the machine for delivering or sending by e-mail while storing in the Document Server, only some of the pages could be scanned.	Specify whether to use the data or not.
Memory is full. Cannot scan. The scanned data will be deleted.	Because of insufficient hard disk space, the first page could not be scanned.	Try one of the following measures: <ul style="list-style-type: none"> <li>• Wait for a while, and then retry the scan operation.</li> <li>• Reduce the scan area or scanning resolution. See "Setting items for Scan Settings", Scanner Reference.</li> <li>• Delete unneeded stored files. See "Deleting a Stored File", Scanner Reference.</li> </ul>

Message	Cause	Solution
Memory is full. Do you want to store scanned file?	Because there is not enough free hard disk space in the machine for storing in the Document Server, only some of the pages could be scanned.	Specify whether to use the data or not.
No paper. Load paper of one of the following sizes, then press [Start Printing].	No paper is set in the specified paper tray.	Load paper of the sizes listed in the message.
Exceeded max. data capacity. Check the scanning resolution, then reset original(s).	The scanned original exceeded maximum data capacity.	Specify the scan size and resolution again. Note that it may not be possible to scan very large originals at a high resolution. See "Relationship between Resolution and File Size", Scanner Reference.
Exceeded max. data capacity. Check scanning resolution, then press Start key again.	The scanned data exceeded maximum data capacity.	Specify the scan size and resolution again. Note that it may not be possible to scan very large originals at a high resolution. See "Relationship between Resolution and File Size", Scanner Reference.
Exceeded max. page capacity per file. Press [Send] to send the scanned data, or press [Cancel] to delete.	The number of scanned pages exceeded maximum page capacity.	Select whether to send the data so far.

## When a Message is Displayed on the Client Computer

This section explains likely causes of and possible solutions for the main error messages displayed on the client computer when using the TWAIN driver.

### Important

- If a message not described here appears, act according to the message. For information about how to turn off the main power switch, see About This Machine.

Message	Cause	Solution
Clear Misfeed(s) in ADF.	A paper misfeed has occurred inside the ADF.	Remove jammed originals, and place them again. Check whether the originals are suitable to be scanned by the machine.
Invalid Winsock version. Please use version 1.1 or higher.	You are using an invalid version of Winsock.	Install the operating system of the computer or copy Winsock from the operating system CD-ROM.
The name is already in use. Check the registered names.	You tried to register a name that is already in use.	Use another name.
Cannot detect the paper size of the original. Specify the scanning size.	The set original was misaligned.	<ul style="list-style-type: none"> <li>Place the original correctly.</li> <li>Specify the scan size.</li> <li>When placing an original directly on the exposure glass, the lifting/lowering action of the ADF triggers the automatic original size detection process. Lift the ADF by more than 30 degrees.</li> </ul>
Cannot add any more scanning mode.	The maximum number of registerable scan modes has been exceeded.	The maximum number of modes that can be stored is 100. Delete unneeded modes.
Cannot specify any more scanning area.	The maximum number of registerable scan areas has been exceeded.	The maximum number of scanning areas that can be stored is 100. Delete unneeded scanning area.
Call Service Please call your service representative.	An unrecoverable error has occurred in the machine.	Call your service representative.
Scanner is not available on the specified device.	The TWAIN scanner function cannot be used on this machine.	Contact your service representative.

Message	Cause	Solution
Scanner is not available. Check the scanner connection status.	<ul style="list-style-type: none"> <li>• The machine's main power switch is off.</li> <li>• The machine is not connected to the network correctly.</li> </ul>	<ul style="list-style-type: none"> <li>• Set the main power switch to "On".</li> <li>• Check whether the machine is connected to the network correctly.</li> <li>• Deselect the personal firewall function of the client computer.</li> <li>• Use an application such as telnet to make sure SNMPv1 or SNMPv2 is set as the machine's protocol. See "Network Settings", General Settings Guide and "Using telnet", Network Guide.</li> </ul>
No response from the scanner.	The machine or client computer is not connected to the network correctly.	Check whether the machine or client computer is connected to the network correctly.
No response from the scanner.	The network is crowded.	Wait for a while, and then try to reconnect.
Error has occurred in the scanner.	The application-specified scan conditions have exceeded the setting range of the machine.	Check whether the scanning settings made with the application exceed the setting range of the machine.
Fatal error has occurred in the scanner.	An unrecoverable error has occurred on the machine.	An unrecoverable error has occurred in the machine. Call your service representative.
Cannot connect to the scanner. Check the network Access Mask settings in User Tools.	An access mask is set.	Contact the network or scanner administrator.
Scanner is not ready. Check the scanner and the options.	The ADF cover is open.	Check whether the ADF cover is closed.
Insufficient memory. Reduce the scanning area.	Scanner memory is insufficient.	<ul style="list-style-type: none"> <li>• Reset the scan size.</li> <li>• Lower the resolution.</li> <li>• Set with no compression. See TWAIN Driver help.</li> </ul> <p>The problem may be due to the following cause:</p> <ul style="list-style-type: none"> <li>• "The Relationship between the Resolution and the Scanning Area" chart in Help for halftone scanning might not always apply. Scanning cannot be performed if large values are set for brightness when using halftone or high resolution.</li> </ul>

Message	Cause	Solution
Cannot find "XXX" scanner used for the previous scan. "YYY" will be used instead. ("XXX" and "YYY" indicate scanner names.)	<ul style="list-style-type: none"> <li>The main power switch of the previously used scanner is not set to "On".</li> <li>The machine is not connected to the network correctly.</li> </ul>	<ul style="list-style-type: none"> <li>Check whether the main power switch of the scanner used for the previous scan is turned off.</li> <li>Check the previously used scanner is connected to the network correctly.</li> <li>Cancel the Personal Firewall of the client computer.</li> <li>Use an application such as telnet to make sure SNMPv1 or SNMPv2 is set as the machine's protocol. See "Network Settings", General Settings Guide and "Using telnet", Network Guide.</li> <li>Select the scanner used for the previous scan.</li> </ul>
Error has occurred in the scanner driver.	An error has occurred in the driver.	<ul style="list-style-type: none"> <li>Check whether the network cable is connected correctly to the client computer.</li> <li>Check whether the Ethernet board of the client computer is recognized correctly by Windows.</li> <li>Check whether the client computer can use the TCP/IP protocol.</li> </ul>
Communication error has occurred on the network.	A communication error has occurred on the network.	Check whether the client computer can use the TCP/IP protocol.
Scanner is in use for other function. Please wait.	A function of the machine other than the scanner function is being used such as the copier function.	Wait for a while and reconnect.
Insufficient memory. Close all other applications, then restart scanning.	Memory is insufficient.	<ul style="list-style-type: none"> <li>Close all the unnecessary applications running on the client computer.</li> <li>Uninstall the TWAIN driver, and then reinstall it after restarting the computer.</li> </ul>
No User Code is registered. Consult your system administrator.	Access is restricted with user codes.	Contact the administrator of the machine.
Any of Login User Name, Login Password or Driver Encryption Key is incorrect.	The entered login user name, password, or driver encryption key was invalid.	<ul style="list-style-type: none"> <li>Check the login user name, login password, and driver encryption key.</li> <li>Permission to use this function has not been granted. Contact the administrator.</li> </ul>

Message	Cause	Solution
Cannot register the user because the scanner's address book is full.	Failed to authenticate the user at the authentication server because the address book is full.	Contact the administrator of the machine.
The user has been already registered in the scanner's address book.	Failed to authenticate the user at the authentication server because same user name has been already registered in the address book.	Contact the administrator of the machine.

# 5. Adding paper, Toner and Staples

This chapter explains troubleshooting procedures that are applicable to all the machine's functions.

## Loading paper

This section explains what to do when paper runs out and needs reloading.

### **CAUTION:**

- *When loading paper, take care not to trap or injure your fingers.*

### **Note**

- Fan the paper before loading.
- Straighten curled or warped paper before loading.
- When paper in trays that are set to automatically eject unnecessary tab stock sheets runs out, reload the tab stock from the beginning of the cycle (the first sheet).
- For paper types and sizes, see “Recommended Paper Sizes and Types”, About This Machine.
- To load paper in the multi bypass tray (Tray 7), see “Using the Multi Bypass Tray (Tray 7)”, Copy/Document Server Reference.



---

## Loading paper into Tray 1 (Tandem Tray)

---

The following procedure explains how to load paper into Tray 1.

### **Important**

- When paper loaded in the right side of Tray 1 runs out, paper on the left is automatically shifted to the right. While the paper is moving, a message instructing you to wait appears. Do not pull out the tray at this time.
- For the right stack, align the right edge of the copy paper with the right edge of the tray. For the left stack, align the left edge of the copy paper to the left edge of the tray.
- Tray 1 uses only letter size (8<sup>1</sup>/<sub>2</sub>"×11" ) paper. If you want to load A4 , contact your service representative.
- Do not stack paper over the limit mark.

**1** Carefully pull out the paper tray until it stops.

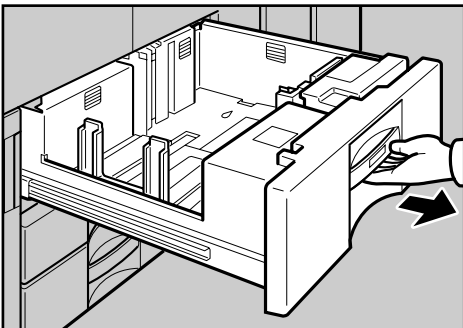

ANQ001S

**2** Square the paper and place it print side down.

- Whole tray pulled out

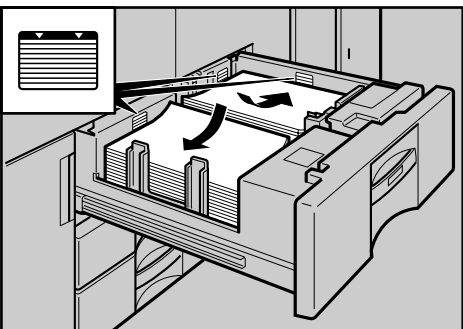

ANQ002S

- Left half of the tray pulled out

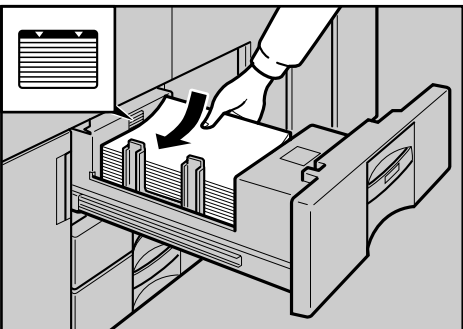

ANQ003S

**3** Carefully slide the paper tray fully in.

 **Note**

- You can load paper even while making copies from Tray 1. You can pull out the left half of the tray while copying is in.



## Loading Paper into the A3/11" × 17" Tray Unit

The following procedure explains how to load paper into the A3/11" × 17" tray unit. To use the A3/11" × 17" tray unit, you must replace Tray 1.

### Important

- Make sure that the paper stack is flush to the right side fence.
- Do not stack paper over the limit mark.

**1** Carefully pull out the paper tray until it stops.

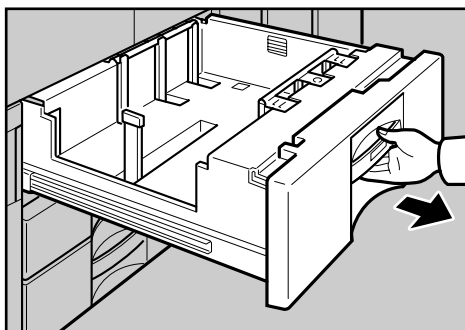

**2** Place the paper in the tray along the edge on the left.

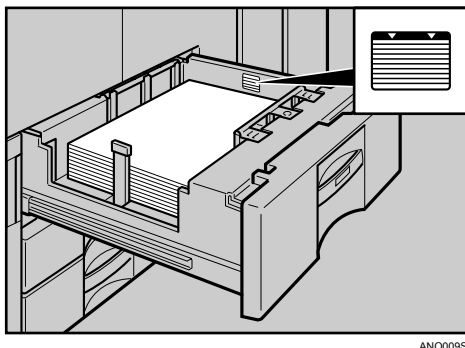

**3** Carefully slide the paper tray fully in.

### Note

- The tray can hold up to 550 sheets.

## Loading Paper into Tray 2 and 3

The following procedure explains how to load paper into Tray 2 and 3.

### Important

- Various sizes of paper can be loaded in Tray 2 and 3 by adjusting the positions of side fence and end fence.
- Check the paper edges are aligned at the right side.
- Do not stack paper over the limit mark.

### **1** Carefully pull out the paper tray until it stops.

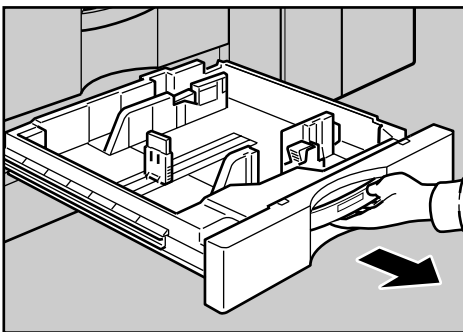

ANQ004S

### **2** Square the paper and load it print side down.

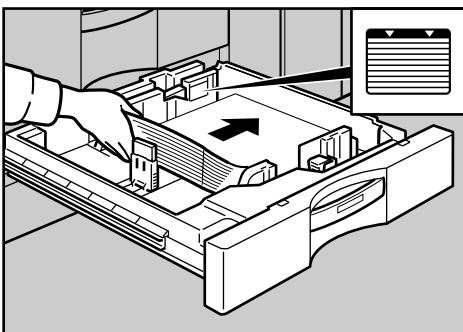

ANQ005S

### **3** Carefully slide the paper tray fully in.

#### Note

- If you load a paper size that is not selected automatically, you will need to specify the paper size with the control panel. Following paper sizes that are not selected automatically.
- The tray can hold up to 550 sheets.

#### Reference

p.75 "Changing the Paper Size"

p.84 "Changing to a Size that is Not Automatically Detected"

## Loading Paper into the Large Capacity Tray (LCT)

The following procedure explains loading paper into the large capacity tray (LCT). The LCT is identified as Tray 4, Tray 5, and Tray 6.

### Important

- Various sizes of paper can be loaded in Tray 4 and Tray 5 by adjusting the positions of side fence and end fence.
- If you want to change the paper size of Tray 6, contact your service representative.
- Check the paper's edges are aligned at the left side.
- Do not stack paper over the limit mark.

### **1** Carefully pull out the paper tray until it stops.

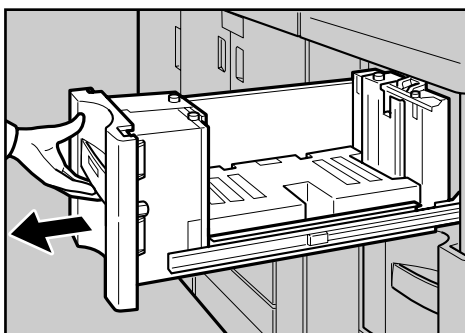

ANQ006S

### **2** Load paper into the paper tray by pushing it against to the left side of the paper tray.

Load the paper print side up.

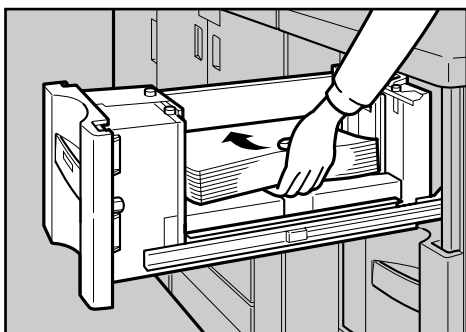

ANQ007S

### **3** Carefully slide the paper tray fully in.

#### Note

- The tray can hold up to 1,100 sheets in Tray 4 and 5, and 2,800 sheets in Tray 6.

#### Reference

p.75 "Changing the Paper Size"

p.84 "Changing to a Size that is Not Automatically Detected"

## Loading Paper into the Wide Large Capacity Tray (Wide LCT)

The following procedure explains loading paper into the wide large capacity tray (Wide LCT). The Wide LCT is identified as Tray 4, Tray 5, and Tray 6.

### Important

- Various sizes of paper can be loaded in the Wide LCT by adjusting the positions of side fence and end fence.
- Check that the paper edges are aligned at the left side.
- Do not load paper above the upper mark in the paper tray

### **1** Carefully pull out the paper tray until it stops.

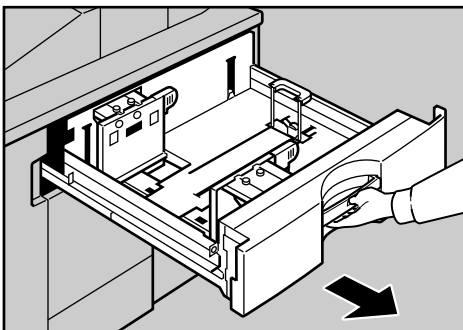

### **2** Load paper into the paper tray by pushing the paper to the left side of the paper tray.

Place paper with printing side up.

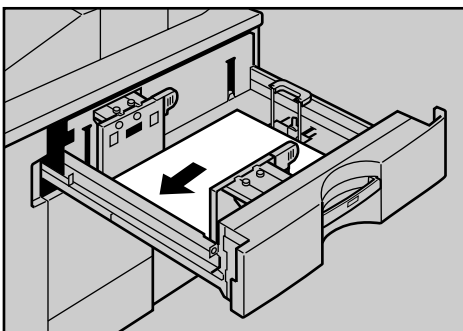

### **3** Carefully slide the paper tray fully in.

#### Note

- The tray can hold up to 1,100 sheets in Tray 4 and 6, and 2,200 sheets in Tray 5.
- If you load paper that cannot be automatically detected, specify its size using the control panel.

#### Reference

p.75 "Changing the Paper Size"

p.84 "Changing to a Size that is Not Automatically Detected"

## Loading Paper into the Multi Bypass Tray (Tray 7)

The following procedure explains loading paper into the multi bypass tray (Tray 7).

### **!** Important

- Check that the paper edges are aligned at the left side.
- The maximum number of sheets you can load into the multi bypass tray (Tray 7) depend on paper type. The number should not exceed the upper limit.

### **1** Set the side fence to the paper size.

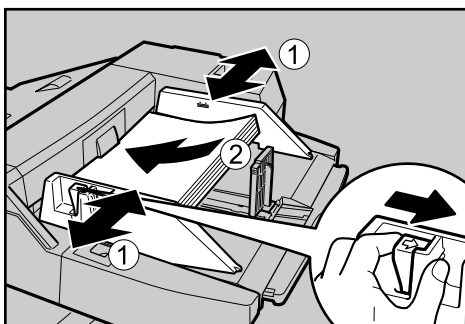

APF028S

### **2** Place paper in the multi bypass tray (Tray 7).

### **3** Set the end fence.

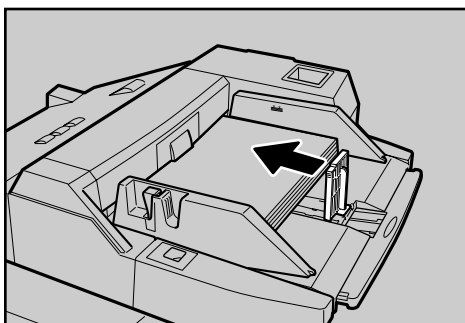

ANQ068S

To remove the end fence, slide it to the right.

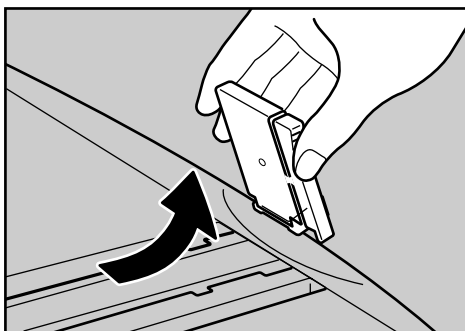

ANQ069S

**4** Press the elevator switch on the multi bypass tray (Tray 7).

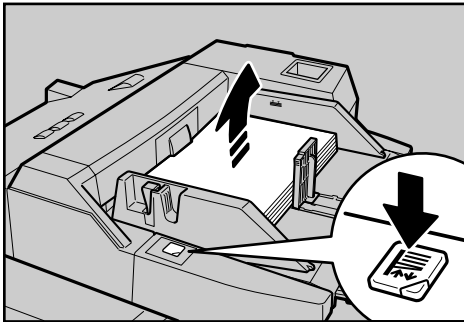

APF030S

The green lamp of the elevator switch is blinking while the tray is going up and down, and keeps lit when it stops.

Press the elevator switch to move down original table if you want to either add paper or remove jammed ones.

**5**

**Note**

- The tray can hold up to 550 sheets.
- For details about using the multi bypass tray (Tray 7), see “Using the Multi Bypass Tray (Tray 7)”, Copy/Document Server Reference.

**Reference**

p.84 “Changing to a Size that is Not Automatically Detected”

---

## Loading Paper in the Interposer

---

The following procedure explains loading paper into the interposer.

**Important**

- Load paper on the side already printed (the front side). If you are using the Booklet Finisher (Saddle Stitch), load sheets print side down.
- Load paper in the interposer in the same orientation as paper in the paper tray.
- The staple or punching location will be on the left side of the paper, when you are facing the machine.
- Do not place anything on top of or leave documents on the sensor. This may lead to the paper size not being correctly scanned or paper jams.
- When using the Z-fold function, the paper in the interposer must be of the same size as the prints after they have been Z-folded. If the paper in the interposer is larger than the Z-folded sheets, a misfeed might occur.

- 1** While pressing the release lever, align the side fence with the paper size to be loaded.

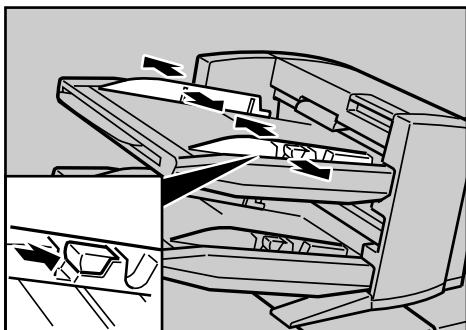

ANQ010S

- 2** Load paper orderly. Tightly fit the side fence to the loaded paper.

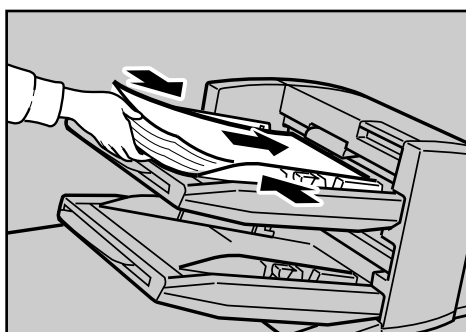

ANQ012S

- 3** When loading paper larger than A4, draw out the paper extender.

 **Note**

- To set the paper in the interposer, align the orientation of originals in the ADF as shown below.

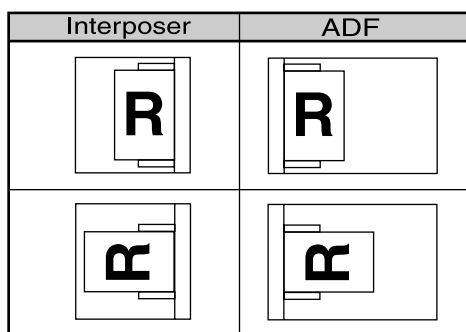

ANR026S

- When paper is loaded which cannot be detected automatically, the user must set the paper size on the control panel.

 **Reference**

p.84 "Changing to a Size that is Not Automatically Detected"

## Orientation-Fixed Paper or Two-Sided Paper









The following describes paper with its orientation and printing surface specified (letterhead paper).

Orientation-fixed (top to bottom) or two-sided paper (for example, letterhead paper, punched paper, or copied paper) might not print correctly, depending on how the originals and paper are placed. Select **[On]** in **[Letterhead Setting]** under **[Copier / Document Server Features]**, and then place the original and paper as shown below. See “Letterhead Setting”, General Settings Guide. When printing with the printer function, placement orientation is the same.

For printing using the printer function, load paper in the same orientation.

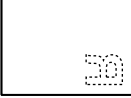
### ❖ Paper orientation

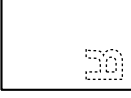
5

Copier mode		Tray 1, 2, 3	Tray 4, 5, 6, multi bypass tray (Tray 7)
		Exposure glass 	1 Sided
ADF 	2 Sided		
Exposure glass 	1 Sided		
ADF 	2 Sided		

 : Displays the paper frontside facing up.

 : Displays the paper backside facing up.

GLTHD01E

### Note

- ❑ Press the **[Tray Paper Setting]** key, specify Letterhead as “Paper Type” for the paper tray you want to use. See “Tray Paper Settings”, General Settings Guide.



# Changing the Paper Size

This section explains how to change a paper size.

Procedures for changing the paper size differ depending on the tray (tray 1 or other optional paper tray units). Make sure you are following the appropriate procedure before you begin.

## **Note**

- Be sure to select the paper size with User Tools. If you do not, misfeeds might occur.
- Fan the paper before loading.
- Straighten curled or warped paper before loading.
- For details about paper sizes and types, see “Copy Paper”, About This Machine.

## Changing the Paper Size in Tray 2 and 3

The following procedure explains how to change a paper size in Tray 2 and 3.

### **Important**

- If a paper tray is pushed vigorously when putting it back into place, the position of the tray's side fence may slip out of place.
- Check that the paper edges are aligned at the right side.
- Do not stack paper over the limit mark.

**1** Check that paper in the paper tray is not being used for copying, and then pull the tray carefully out until it stops.

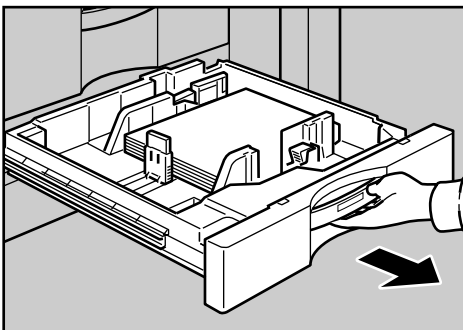

**2** Remove paper if loaded.

**3** Release the lock on the side fence.

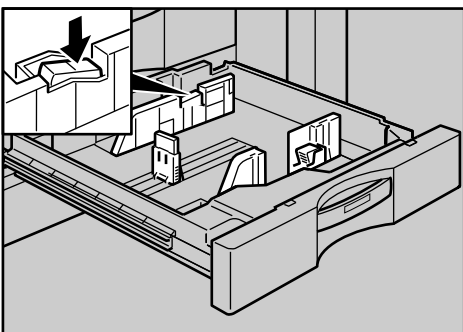

- 4** While pressing down the release lever, slide the side fences until they are aligned the paper size you want to load.

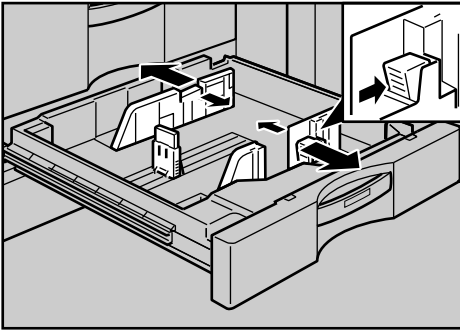

ANQ016S

- 5** Slide the end fence until it is aligned with the size of paper to you want to load.

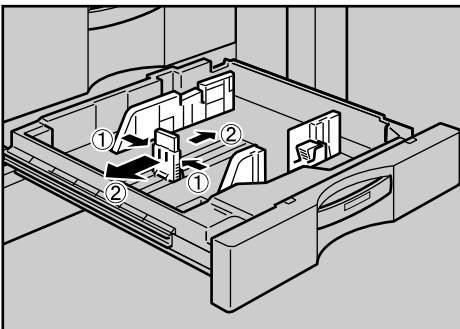

ANQ017S

- 6** Square the paper and load it print side up.  
Re-lock the side fences again.

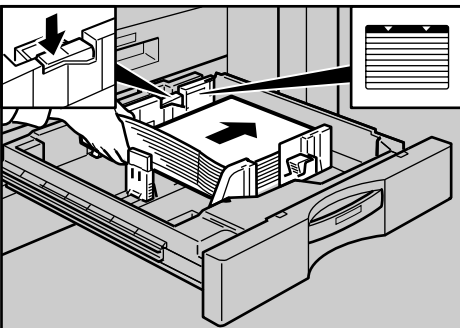

ANQ018S

- 7** Carefully slide the paper tray fully in.

- 8** Check the size on the display.

 **Note**

- If there is space between the side fence and paper, bring the side fence flush against the edge of the paper.

## Changing the Paper Size in the Large Capacity Tray (Tray 4 and 5)

The following procedure explains how to change a paper size in the LCT (Tray 4 and 5).

### **Important**

- As for changing paper sizes of Tray 6, contact your service representative.
- Check that the paper edges are aligned at the left side.
- Do not stack paper over the limit mark.

**1** Carefully pull out the paper tray until it stops.

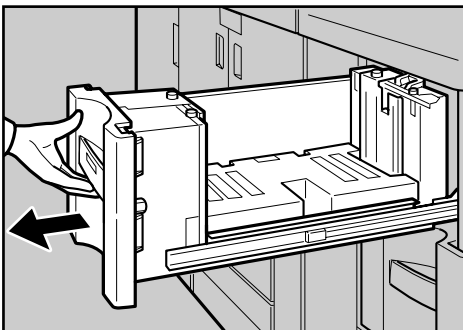

ANQ006S

**2** Pull out the screws fixing the side fence.

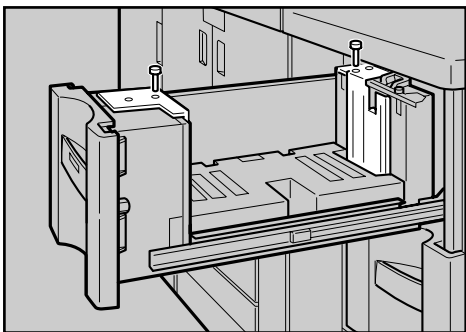

**3** Set the side fences to the size you want.

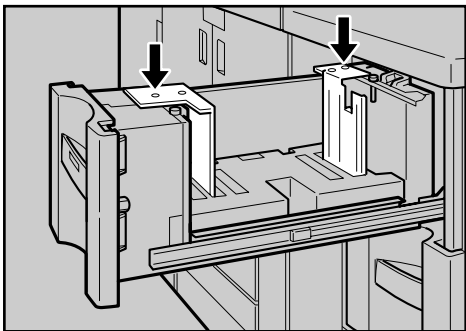

- 4** Fasten the side fence with the screws.

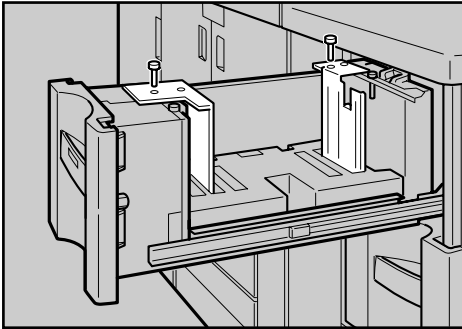

ANQ022S

- 5** Set the end fence along the paper size.

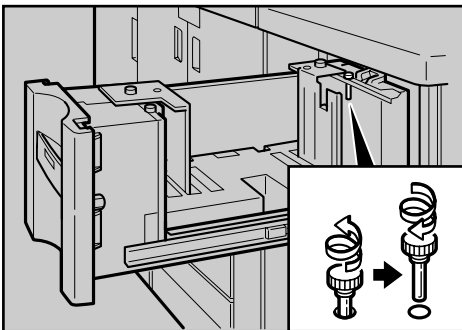

ANQ023S

- 6** Square the paper and set it in the tray.

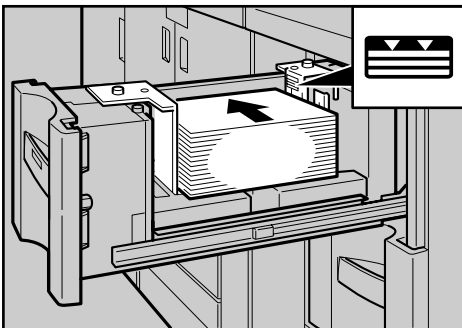

ANQ024S

- 7** Set the paper size selector in the innermost part of the tray to the new paper size.

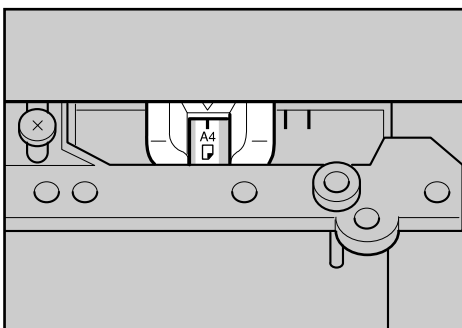

ANQ025S



**8** Carefully slide the paper tray fully in.

**9** Check the size on the display.

---

Load A4 , 8<sup>1</sup>/<sub>2</sub>" × 11"  into the Large Capacity Tray (Tray 4 and 5)

---

Follow the procedure below to set the end fence for A4 , 8<sup>1</sup>/<sub>2</sub>" × 11" .

**1** Set the end fence according to the paper size.

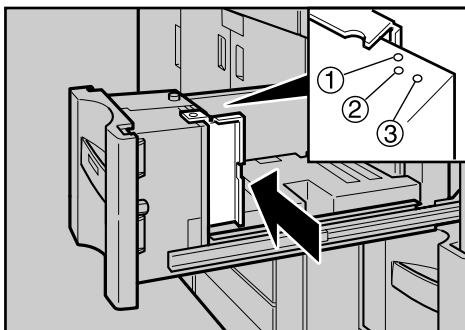



① A4 

② 8<sup>1</sup>/<sub>2</sub>" × 11" 

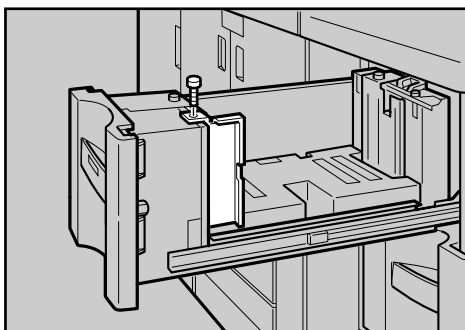
**2** Fasten the end fence using the screw provided.



 **Note**

When loading index tabs, shift the end fence for A4 , 8<sup>1</sup>/<sub>2</sub>" × 11"  to position ③ before setting the end fence for index tabs.

## Changing the Paper Size in the Wide Large Capacity Tray

The following procedure explains how to change a paper size in the wide large capacity tray (Wide LCT).

### Important

- Check that the paper edges are aligned at the left side.
- Do not stack paper over the limit mark.

**1** Carefully pull out the paper tray until it stops.

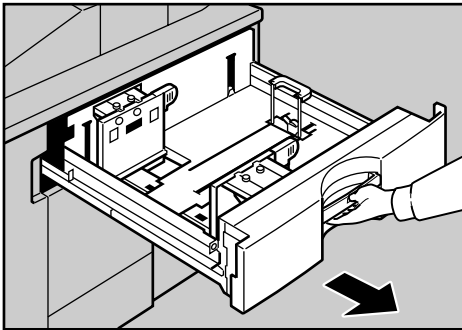

**2** Pull out the screws fixing the side fence.

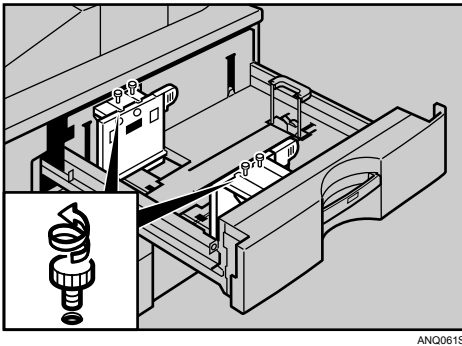

**3** Take the grip of the side fence with your fingers, and adjust the side fence to the paper size.

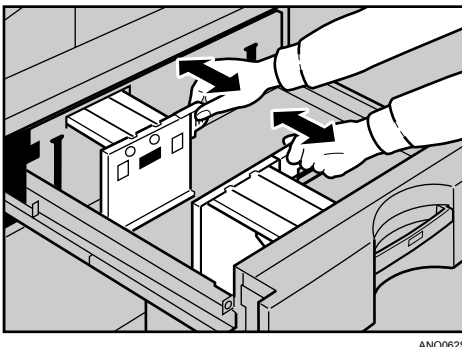

**4** Fasten the side fence with the screws.

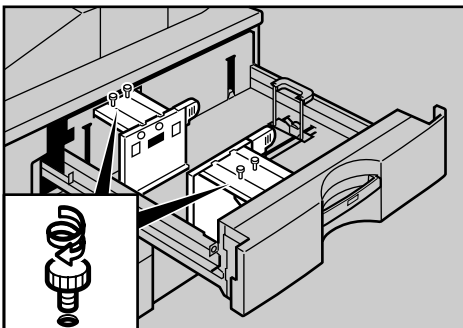

ANQ063S

**5** Release the lock on the back fence.

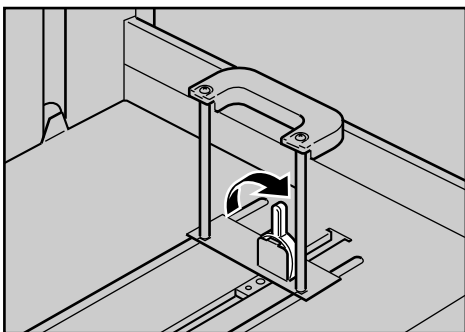

ANQ064S

**6** Square the paper and set it in the tray.

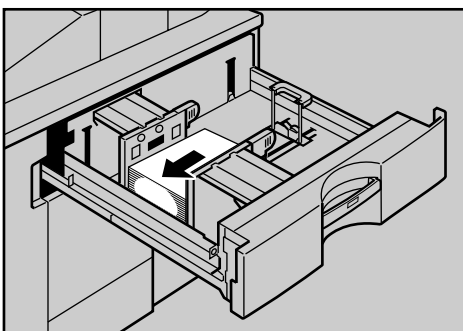

ANQ066S

5



- 7** Tightly fit the back fence to the loaded paper and then re-lock the back fence again.

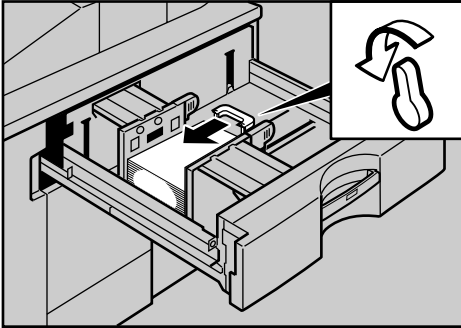

- 8** Carefully slide the paper tray fully in.
- 9** Check the size on the display.

## Changing to a Size that is Not Automatically Detected

If you load a paper size that is not selected automatically, you need to specify the paper size with the control panel. This section explains how to load these paper taking 11"× 15" as an example.

### Important

Following paper sizes that are not selected automatically.

- Tray 2, Tray 3:  
11" × 15", 11" × 14", 10" × 15", 10" × 14", 8<sup>1</sup>/<sub>4</sub>" × 14", 8" × 10"
- Tray 4, Tray 5, Tray 6 (Wide LCT):  
A4, B5, A5, B6, A6, 8<sup>1</sup>/<sub>2</sub>" × 14", 8<sup>1</sup>/<sub>2</sub>" × 13", 8<sup>1</sup>/<sub>4</sub>" × 13", 10<sup>1</sup>/<sub>2</sub>" × 7<sup>1</sup>/<sub>4</sub>, 11" × 15", 10" × 14", 8<sup>1</sup>/<sub>4</sub>" × 14"
- Multi Bypass Tray (Tray 7), Interposer:  
A4, B5, A5, B6, 8<sup>1</sup>/<sub>2</sub>" × 14", 8<sup>1</sup>/<sub>2</sub>" × 13", 8<sup>1</sup>/<sub>4</sub>" × 13", 10<sup>1</sup>/<sub>2</sub>" × 7<sup>1</sup>/<sub>4</sub>, 11" × 15", 10" × 14", 8<sup>1</sup>/<sub>4</sub>" × 14", 8" × 10"

5

**1** Press the [Tray Paper Setting] key.



ANR102S

The Tray Paper Settings screen appears.

**2** Select the tray number on the screen.



**3** Press [Paper Size] tab.

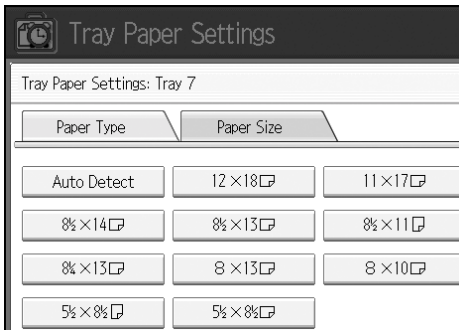

**4** Select a combination of the specified paper size and orientation, and then press [OK].

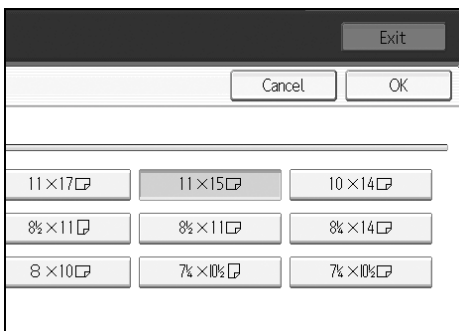

The paper size and orientation appear.

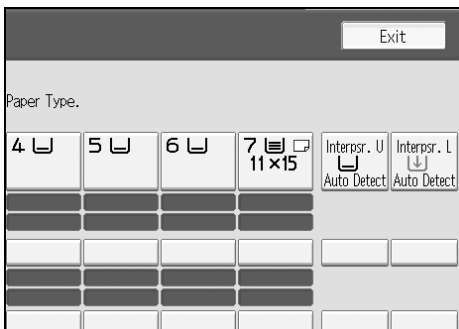

**5** Press the [Tray Paper Setting] key.

The initial display is shown.

**Note**

- If you want to print on paper that is selected automatically after printing on a paper size that is not selected automatically, you must return the setting to "Auto Detect". Reload the paper, select "Auto Detect" in step 4. The setting is returned to "Auto Detect".

## Pausing Copy When Using Finisher

You can pause a large volume of copies when using Finisher.

**1** Press the [Suspend/Resume] key.

The key lights up.

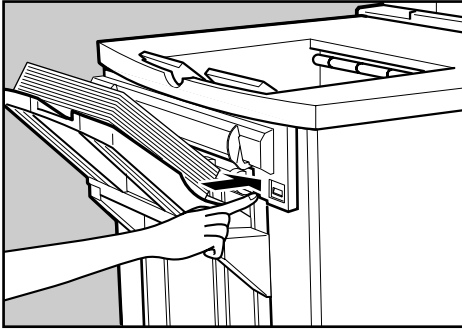

5

**2** Remove the stack of paper from the finisher shift tray.

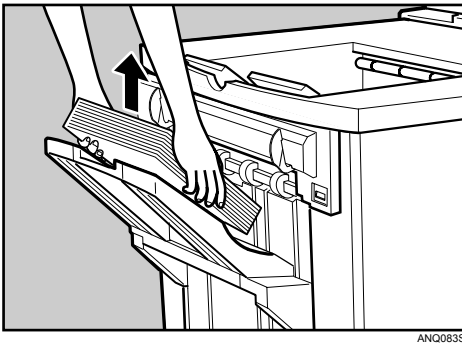

**3** Press the [Suspend/Resume] key.

The key turns off, and then copying restarts.

 **Note**

- You can suspend copy only when the output tray is specified as the finisher shift tray.

# Adding Toner

This section explains adding and storing toner.

**⚠ WARNING:**

- ***Do not incinerate used toner or toner containers. Toner dust might ignite when exposed to an open flame. Dispose of used toner containers in accordance with local regulations.***

**⚠ CAUTION:**

- *Keep toner (used or unused) and toner containers out of reach of children. See a doctor immediately if you accidentally swallow toner.*

**⚠ CAUTION:**

- *If toner or used toner is inhaled, gargle with plenty of water and move into a fresh air environment. Consult a doctor if necessary.*

**⚠ CAUTION:**

- *If toner or used toner gets into your eyes, flush immediately with large amounts of water. Consult a doctor if necessary.*

**⚠ CAUTION:**

- *If toner or used toner is swallowed, dilute by drinking a large amount of water. Consult a doctor if necessary.*

**⚠ CAUTION:**

- *Avoid getting toner on your clothes or skin when removing a paper jam or replacing toner. If your skin comes into contact with toner, wash the affected area thoroughly with soap and water.*
- *If toner gets on your clothing, wash with cold water. Hot water will set the toner into the fabric and may make removing the stain impossible.*

**⚠ CAUTION:**

- *Our products are engineered to meet high standards of quality and functionality, and we recommend that you use only the expendable supplies available at an authorized dealer.*



**⚠ CAUTION:**

- *Open toner cartridges carefully. If you open them forcefully, toner can spill, dirtying your clothes or hands, and possibly resulting in accidental ingestion.*

### Important

- Faults may occur if you use toner other than the recommended type.
- When adding toner, do not turn off the operation switch. If you do, settings will be lost.
- Always add toner when the machine instructs you.
- Do not use recycled toner. This will damage the machine.
- During toner adding, the toner bottle is rotating. Do not touch the toner bottle.
- If toner remains in the bottle, you cannot remove the bottle. Do not remove the bottle forcibly.
- Be sure to set the new toner bottle in the lower hole first.
- Store toner containers in a cool, dry place free from direct sunlight.
- Store toner on a flat surface.

### Note

- If both toner bottles are empty,  will appear.
- You can still make about 200 copies after  appears, but replace the toner early to copy degradation.
- If one of the toner bottle is empty, you can keep copying by using the other bottle.
- You can change the toner bottle during copying.
- If toner remains in the bottle, you cannot pull it out.
- When you change one toner bottle, do not touch the other one.
- Press **[System Status]** to check contact number for consumables' order. For system status, see p.5 "Checking Machine Status and Settings".

## Inserting Toner

The following describes how to replace toner.

### **Important**

- Do not shake the toner bottle with its mouth down after removing it. Residual toner may scatter.

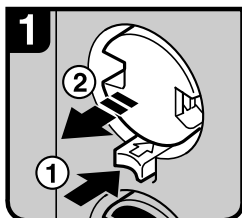

1. Open the toner cover.
2. Push the green button to release the toner bottle.

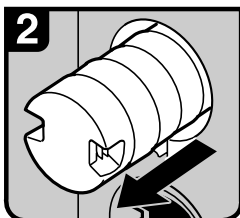

3. Gently pull out the toner bottle gently.

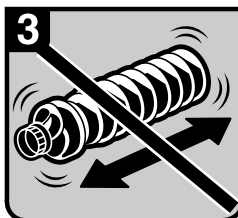

4. Do not shake the toner bottle strongly or toner might spill out.

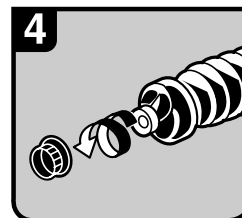

5. Remove the outer cap.
- Note**  
Do not remove the inner cap.



6. Place the toner bottle in position, and then push it in until the green button clicks.



7. Return the button under the toner bottle to its original position.
8. Close the toner cover.

### **Important**

Be sure to set the new toner bottle in the lower hole first.

### **Note**

If you cannot get it to click in, pull out the toner bottle a little, slightly rotate it to the left or right, then try again.

ANR001S

## Used Toner

Toner cannot be re-used.

Bring the stored used container to your sales representative or service representative for recycling through our recycling system. If you discard it on your own, treat it as general plastic waste material.

# Adding Staples

This section explains what to do when staples need replacing.

**⚠ CAUTION:**

- *Keep your hands clear of the booklet finisher tray when pulling out or pushing in the finisher's staple unit. You can trap your fingers if you do not.*

**🔧 Important**

- ❑ Stapling failures or jams may occur if you use a staple cartridge other than that recommended.

Refill the stapler according to the finisher type. (Check the type if you are unsure.) For details about type of finisher, see "Options", About This Machine.

---

## Finisher

---

5

The following procedure explains how to add staples to the Finisher.

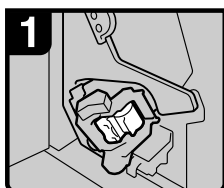

1. Open the finisher front cover.

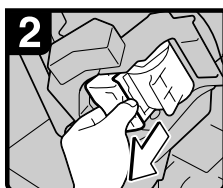

2. Pull out the cartridge lever.

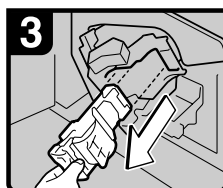

3. Gently pull out the cartridge.

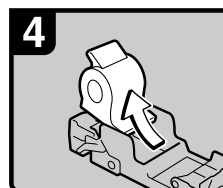

4. Remove the empty refill in the direction of the arrow.

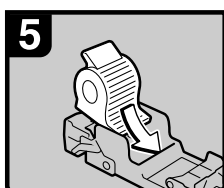

5. Push in the new cartridge until it clicks.

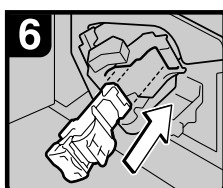

6. Hold the green lever and push in the cartridge until it clicks.

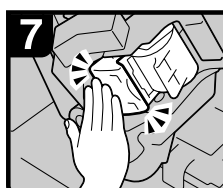

7. Push in the cartridge until it clicks, then raise the lever.

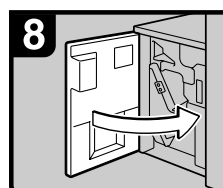

8. Close the finisher front cover.

ANR002S



## Booklet Finisher (Saddle Stitch)

The following procedure explains how to add staples to the Booklet Finisher.

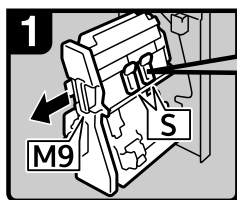

1. Open the finisher front right cover.
2. Pull out the staple unit.

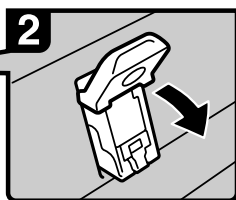

3. Lower the green lever.

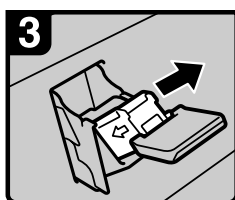

4. Gently pull out the cartridge.

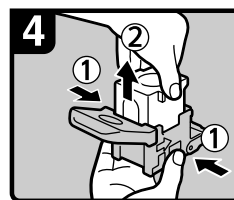

5. Hold both sides of the cartridge then raise the upper unit.

**Note**

If you cannot pull out the upper unit, there are staples remaining inside the cartridge.  
Use all the staples; do not add more.

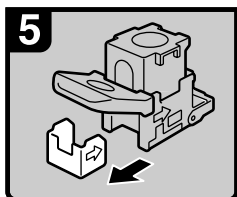

6. Remove the empty refill in the direction of the arrow.

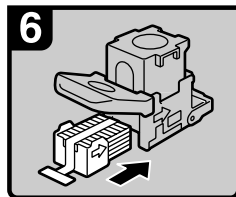

7. Push in the new staples until the arrows are aligned.

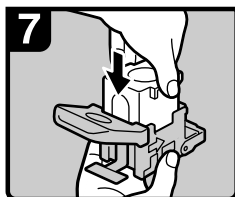

8. Gently push down the upper unit into the cartridge.

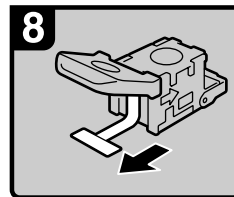

9. Pull out the ribbon.

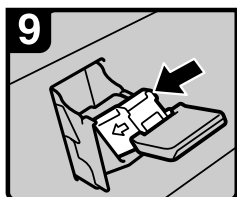

10. Hold the green lever and push in the cartridge until it clicks.

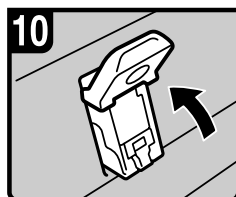

11. Push in the cartridge until it clicks, then raise the lever.

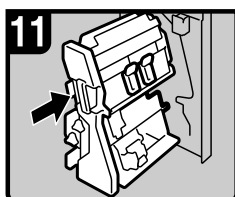

12. Put the staple unit back.
13. Close the finisher front right cover.

ANR003S



# 6. Clearing Misfeeds

This chapter explains what to do when paper or originals misfeed (become jammed inside the machine).

## Removing Jammed Paper

### **CAUTION:**

- *The inside of the machine could be very hot. Do not touch any parts other than specified in this document when removing misfed paper. Otherwise, it may cause burn injury.*

### **CAUTION:**

- *The fusing section of this machine might be very hot. Caution should be taken when removing misfed paper.*

### **CAUTION:**

- *Keep your hands clear of the booklet finisher tray when pulling out or pushing in the finisher's staple unit. You can trap your fingers if you do not.*

### **Important**

- When clearing misfeeds, do not turn off the operation switch. If you do, your copy settings will be lost.
- To prevent misfeeds, do not leave any torn scraps of paper inside the machine.
- Remove the fusing unit only when necessary.
- Contact your service representative if misfeeds occur frequently.

### **Note**

- For details about how to locate and remove misfeeds, see “Checking Jammed Paper” or “Removing Jammed Paper”.

### **Reference**

- p.94 “Locating Jammed Paper”.
- p.96 “Removing Jammed Paper”.

## Locating Jammed Paper

If a misfeed happens, remove the misfed paper or original following the procedures stated on the sticker on the rear of main unit front cover.

A misfeed has occurred in the place corresponding to the letter displayed on the control panel.

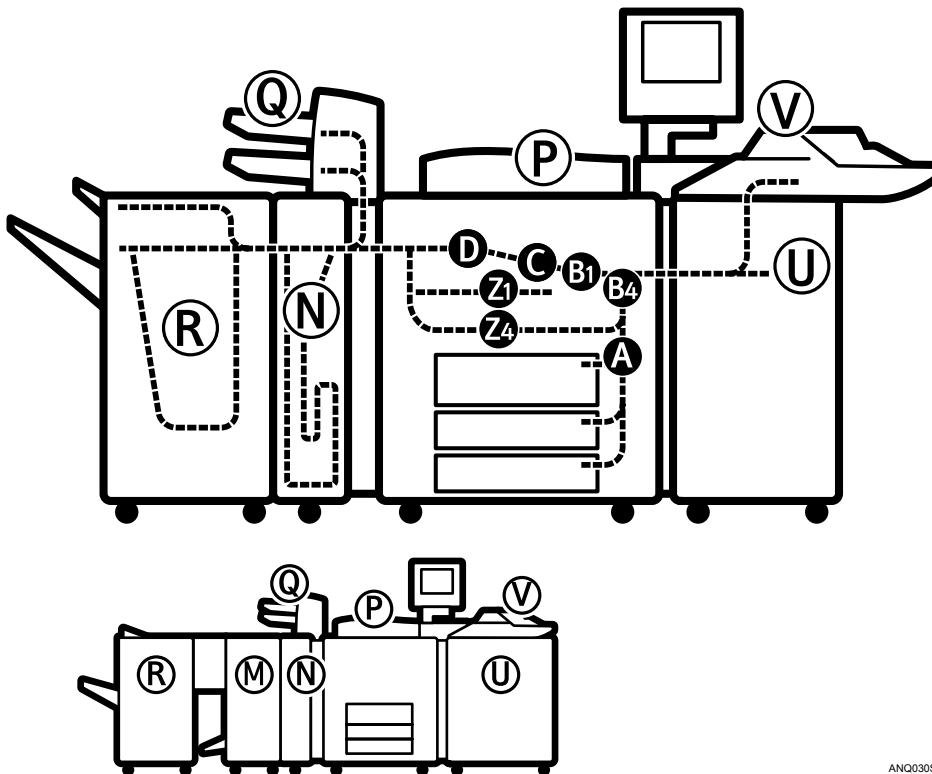

ANQ030S

**1** Press the key of the section from where you want to remove the jammed paper.

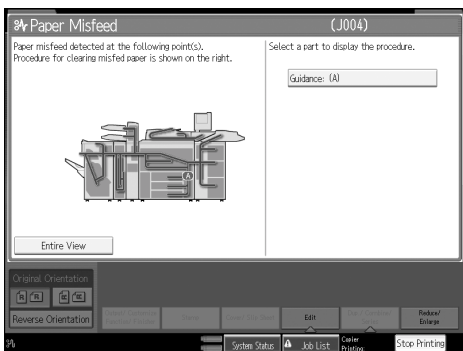

- 2** After each step is complete, press [Next]. To go back to the previous step, press [Previous].

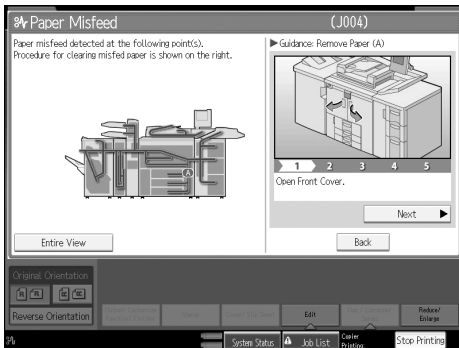

- 3** Press [Entire View], the entire machine is displayed.

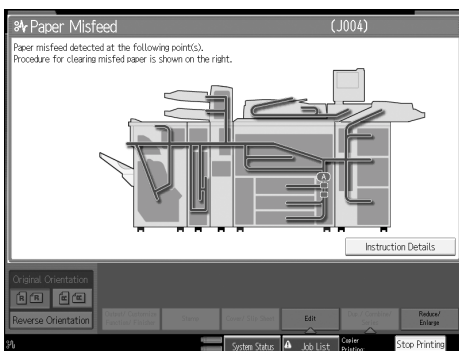

- 4** When all jammed paper are removed, restore the machine to the original state.

 **Note**

- More than one misfeed may be indicated. When this happens, check all the areas indicated.

## Removing Jammed Paper

The following procedure explains how to remove jammed paper.

### ⚠ Important

- ❑ The fusing section of this machine might be very hot. Caution should be taken when removing misfed paper.
- ❑ When removing jammed sheets, take care to touch only those areas explicitly indicated in the manual.
- ❑ Do not remove the fusing unit. Doing so will result in loss of print quality.

### 📌 Note

- ❑ Your machine might differ from that shown in these illustrations, depending on the options installed on it.

- When A is lit

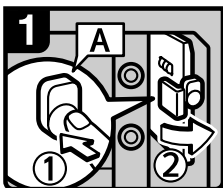

1. Open the front cover of the machine.
2. Push button A and open the guide board.

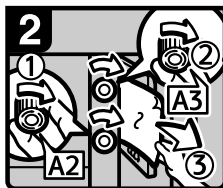

3. Turn knob A2 and A3, then remove misfed paper.
4. Close the guide board.

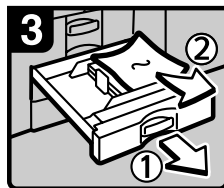

5. If you can not remove misfed paper, pull out the tray in use then remove it.
6. Close the front cover.

ANR004S

- When B1 is lit

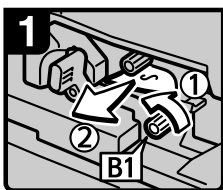

1. Open the front cover of the machine.
2. Turn knob B1 and remove misfed paper.

#### Note:

- Check if lever B2 is in the downward position. If it is not, turn it to the downward position, and then remove any jammed paper.

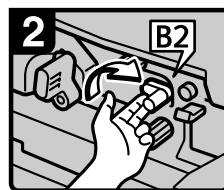

3. Raise lever B2.
4. Close the front cover.

ANR005S

- When B4 is lit

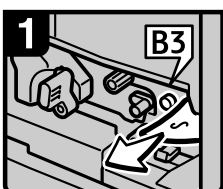

1. Open the front cover of the machine.
2. Push button B3 and open the guide board.
3. Remove misfed paper.

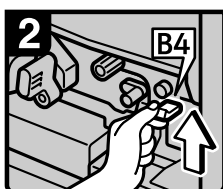

4. Raise lever B4 and close the guide board.
5. Close the front cover.

ANR006S

• When C is lit

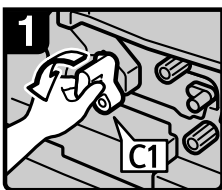

1. Open the front cover of the machine.  
2. Hold lever C1 with your left hand, and then pull it down towards the left.

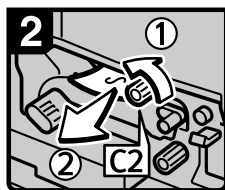

3. Turn knob C2 and remove misfed paper.  
4. Put lever C1 back.  
5. Close the front cover.

ANR007S

• When D is lit

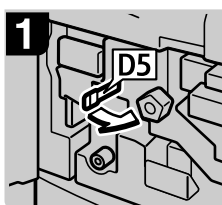

1. Open the front cover of the machine.  
2. Pull lever D5 to the right.

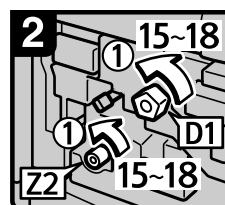

3. Using both hands, turn knobs D1 and Z2 anti-clockwise 15 to 18 times, at the same time.

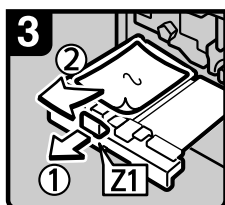

4. Pressing down lever Z1, carefully pull out the fusing unit, and then remove any jammed paper.

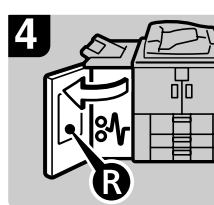

5. Remove jammed paper by following the directions that are stuck to the cover of the option on the machine's left side.

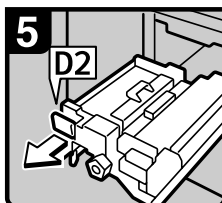

6. Pull lever D2 and fully pull out the fusing unit.

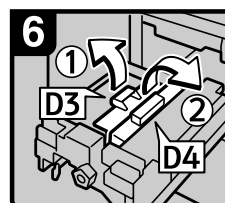

7. Pull up lever D3 and D4.



8. Remove misfed paper and return lever D3 and lever D4 to original position.

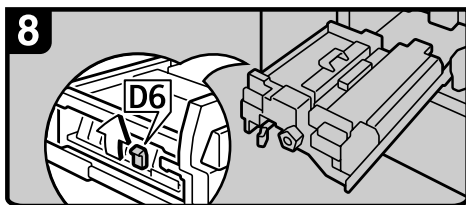

9. Hold up lever D6.

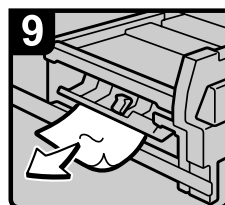

10. Remove misfed paper.  
11. Return the fusing unit to original position.  
12. Close the front cover.

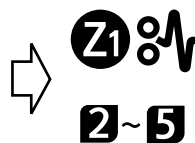

ANR008S

- When M is lit (when Booklet Finisher is installed)

**When M1 - M3 is lit**

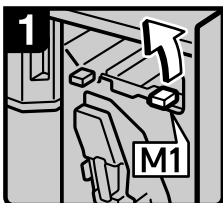

1. Open the finisher front right cover.
2. Raise lever M1.

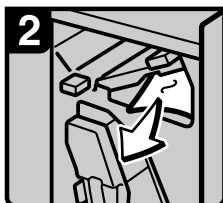

3. Remove misfed paper.

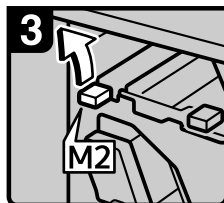

4. Raise lever M2.

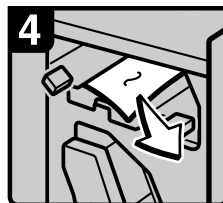

5. Remove misfed paper.

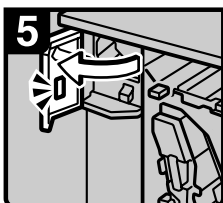

6. Open the front left cover of the finisher.

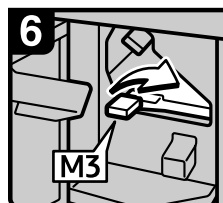

7. Raise lever M3.



8. Remove misfed paper.
9. Return lever M1, M2 and M3 to original position.
10. Close the finisher front left cover.
11. Close the finisher front right cover.

**When M4 - M6 is lit**

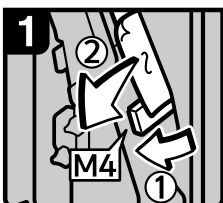

1. Open the finisher front right cover.
2. Lower lever M4 and remove misfed paper.

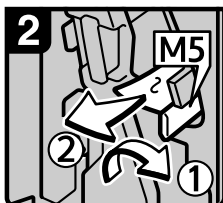

3. If you cannot remove misfed paper, raise lever M5 and remove it.

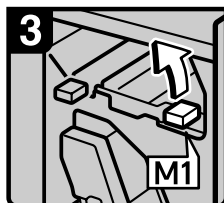

4. Raise lever M1.



5. Lower lever M6 and remove misfed paper.
6. Return lever M1, M4, M5 and M6 to original position.
7. Close the finisher front right cover.

ANRPA400



**When M7 - M11 is lit**

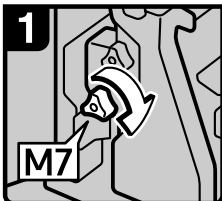

1. Open the finisher front right cover.
2. Turn knob M7.

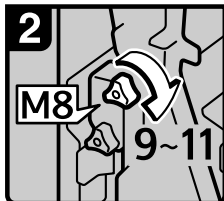

3. Turn knob M8 9-11 times.

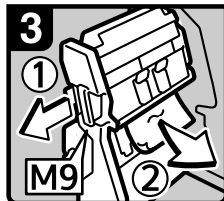

4. Pull handle M9 and pull out staple unit, then remove misfed paper.

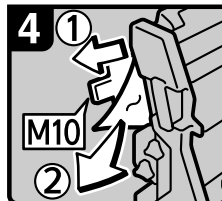

5. If you cannot remove misfed paper, raise lever M10 and remove it.

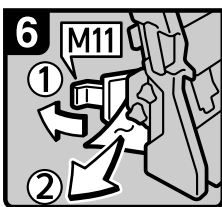

6. If you cannot remove misfed paper, raise lever M11 and remove it.

7. Return lever M10 and M11 to original position.

8. Push the staple unit.

9. Close the finisher front right cover.

ANR019S

• **When N1 is lit (when Z-Folding Unit is installed)**

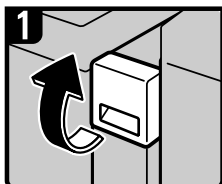

1. Open the Z-folding unit upper cover.

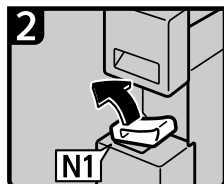

2. Lift the N1 lever.

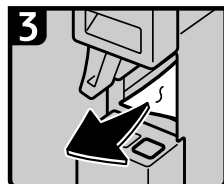

3. Remove misfed paper.
4. Lower the N1 lever.
5. Close the Z-folding unit upper cover.

ANS008S

• When N2 or N3 is lit (when Z-Folding Unit is installed)

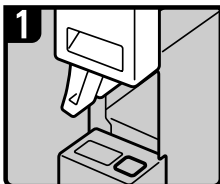

1. Open the Z-folding unit upper cover. Lift the N1 lever.

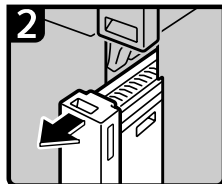

2. Pull out the Z-folding unit.

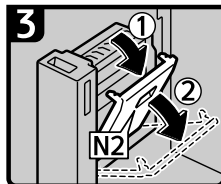

3. Open the N2 cover.

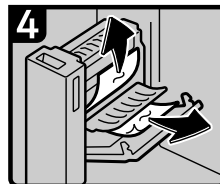

4. Remove misfed paper. Close the N2 cover.

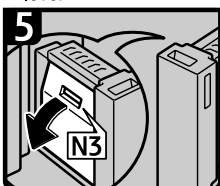

5. If you cannot remove the misfed paper, open the N3 cover.

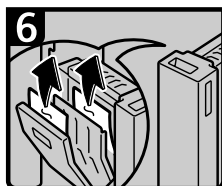

6. Remove misfed paper. Close the N3 cover.

7. Return the Z-folding unit to its original position.  
8. Lower the N1 lever.  
9. Close the Z-folding unit upper cover.

ANS009S

• When P1 is lit (when ADF is installed)

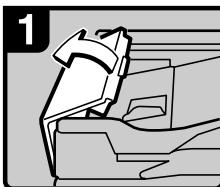

1. Open the cover P1 of the ADF.

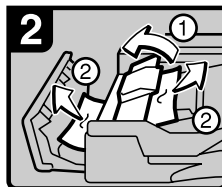

2. Remove misfed originals.  
3. Close the cover P1 of the ADF.  
4. Lift and lower the ADF.

ANR011S

• When P2 is lit (when ADF is installed)

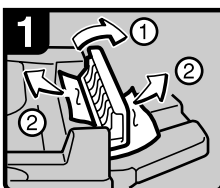

1. Open the cover P2 of the ADF.  
2. Remove misfed originals.  
3. Close the cover P2 of the ADF.  
4. Lift and lower the ADF.

ANR027S

• When Q1 or Q2 is lit (when Interposer is installed)

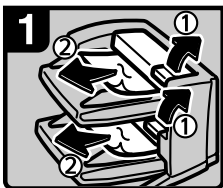

1. Open the interposer upper tray cover or lower tray cover.
2. Remove misfed paper.

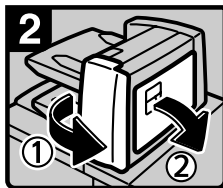

3. Open the interposer main cover and right cover.

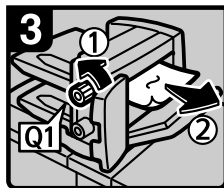

4. Turn knob Q1.
5. Remove misfed paper.

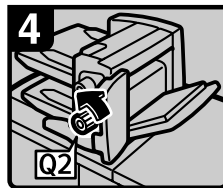

6. Turn knob Q2.

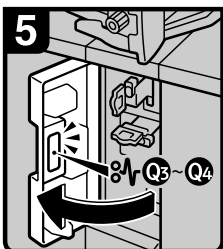

7. Open the interposer base cover.
8. Close the interposer main cover and right cover.
9. Close the interposer base cover.

ANR016S

• When Q3 or Q4 is lit (when Interposer is installed)

6

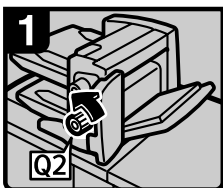

1. Open the interposer main cover.
2. Turn knob Q2.

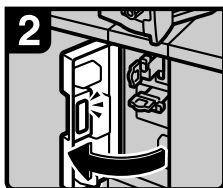

3. Open the interposer base cover.

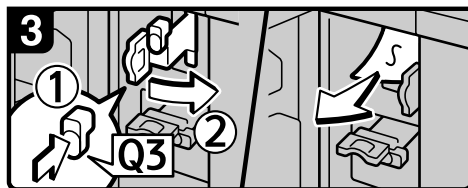

4. Press button Q3, open the guide board.
5. Remove misfed paper.
6. Close the guide board.

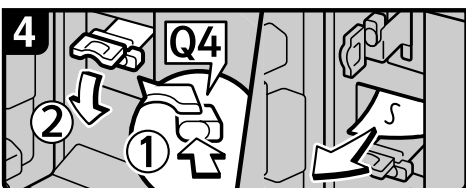

7. Press button Q4, open the guide board.
8. Remove misfed paper.
9. Close the guide board.

10. Close the interposer main cover.
11. Close the interposer base cover.

ANR017S

• When R is lit (when Finisher is installed)

**When R1 - R8 is lit**

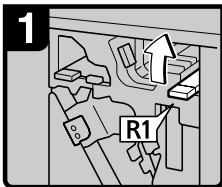

1. Open the finisher front cover.  
2. Raise lever R1.

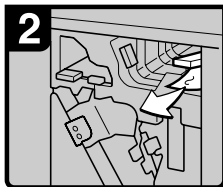

3. Remove misfed paper.

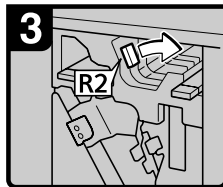

4. If you cannot remove misfed paper, pull lever R2 to the right.

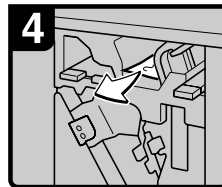

5. Remove misfed paper.

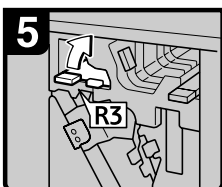

6. If you cannot remove misfed paper, raise lever R3.

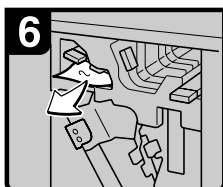

7. Remove misfed paper.  
8. Return lever R1, R2 and R3 to its original position.  
9. Close the finisher front cover.

6

**When R4 - R8 is lit**

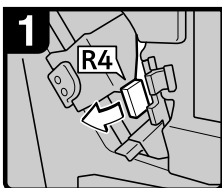

1. Open the finisher front cover.  
2. Pull lower R4 to the left.

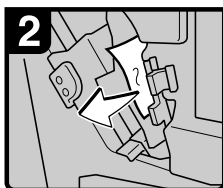

3. Remove misfed paper.

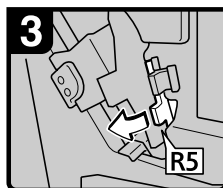

4. If you cannot remove misfed paper, pull lever R5 to the left.

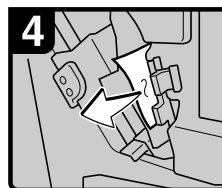

5. Remove misfed paper.

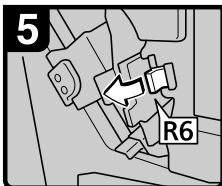

6. If you cannot remove misfed paper, pull lever R6 to the left.

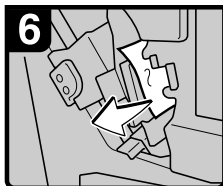

7. Remove misfed paper.

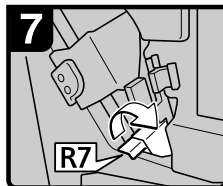

8. If you cannot remove misfed paper, pull lever R7 to the right.

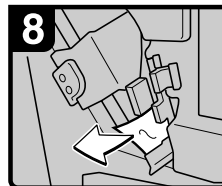

9. Remove misfed paper.

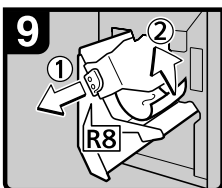

10. Pull handle R8 and pull out the staple unit.  
11. Remove misfed paper.

12. Return the staple unit to its original position.  
13. Return lever R4, R5, R6 and R7 to its original position.  
14. Close the finisher front cover.

ANR021S

• When U is lit (when Large Capacity Tray is installed)

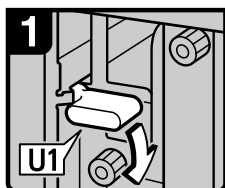

1. Open the front cover of the machine.  
2. Hold down lever U1.

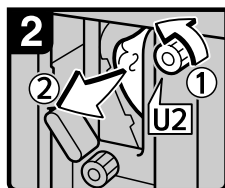

3. Turn knob U2 and remove misfed paper.  
4. Return lever U1 to original position.

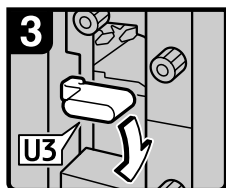

5. Hold down lever U3.

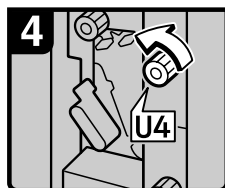

6. Turn knob U4.

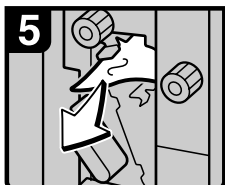

7. Remove misfed paper

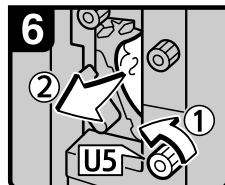

8. Turn knob U5 and remove misfed paper.

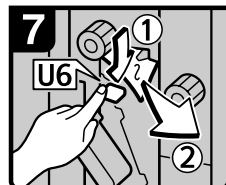

9. Hold down lever U6 and remove misfed paper.

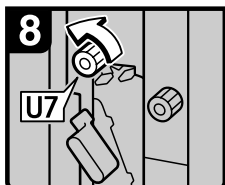

10. Turn knob U7 and remove misfed paper.  
11. Return lever U3 to original position.  
12. Close the front cover.

ANR012S

• When U is lit (when Wide Large Capacity Tray is installed)

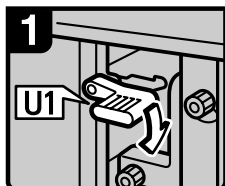

1. Open the front cover of the machine.  
2. Hold down lever U1.

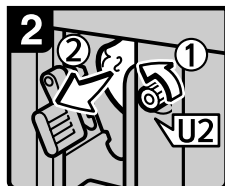

3. Turn knob U2 and remove misfed paper.  
4. Return lever U1 to original position.

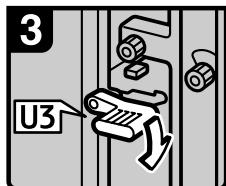

5. Hold down lever U3.

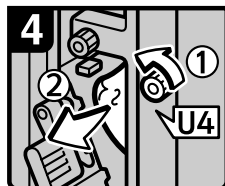

6. Turn knob U4 and remove misfed paper.



7. Hold down lever U5.

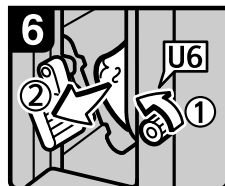

8. Turn knob U6 and remove misfed paper.



9. Hold down lever U7 and remove misfed paper.



10. Turn knob U8 and remove misfed paper.  
11. Return lever U3 to original position.  
12. Close the front cover.

ANR013S

- When V is lit (when Multi Bypass Tray (Tray 7) is installed)

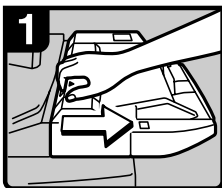

1. Disconnect the multi bypass tray (Tray 7).

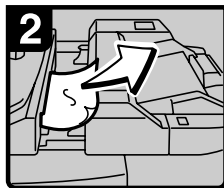

2. Remove misfed paper.  
3. Return the multi bypass tray (Tray 7) to its original position.

ANR020S

- When Z1 is lit

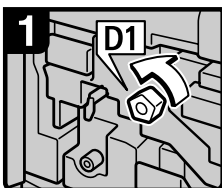

1. Open the front cover of the machine.  
2. Turn knob D1 a few times.

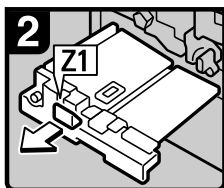

3. Pull handle Z1 and fully pull out the duplex unit.

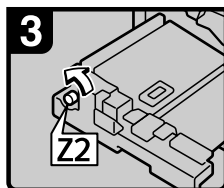

4. Turn knob Z2.

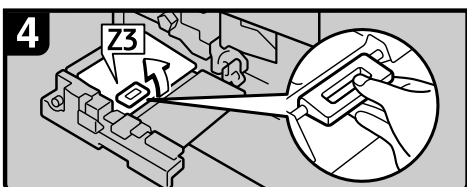

5. Hold up lever Z3 and open the cover.



6. Remove misfed paper.  
7. Close the Z3 cover.  
8. Put the duplex unit back.  
9. Close the front cover.

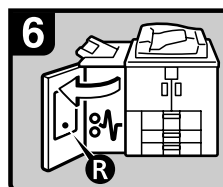

ANR009S

- When Z4 is lit

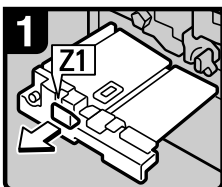

1. Open the front cover of the machine.  
2. Pull handle Z1 and fully pull out the duplex unit.

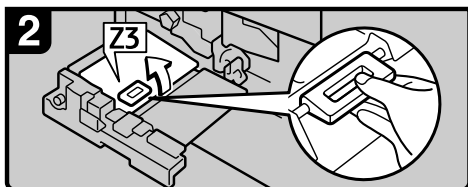

3. Raise lever Z3 and open the cover.

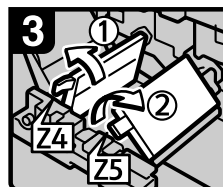

4. Raise lever Z4.  
5. Raise lever Z5.

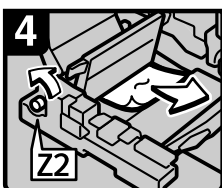

6. Turn knob Z2 and remove misfed paper.



7. Put lever Z5, Z4, and Z3 back.  
8. Put the duplex unit back.  
9. Close the front cover.

ANR010S

**Note**

- Inside the finisher, or inside the front cover, there is a sticker explaining how to remove misfed paper.
- If a detailed removal instruction appears on the right of the screen, follow it.
- You can also use the procedure indicated in **[System Status]** to remove jammed paper.

---

## When Z-folded paper is not properly aligned

---

The following procedure explains when Z-folded copies are not properly aligned.

- 1** Press the **[Suspend/Resume]** key.

The key lights up.

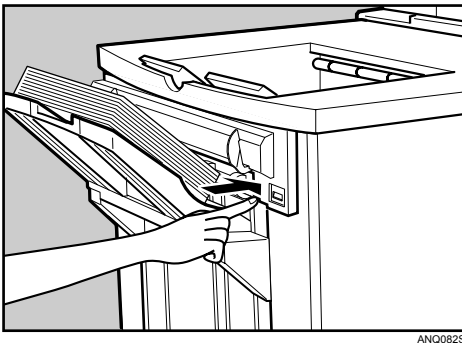

- 2** Remove the copies.

- 3** Set the auxiliary tray for the finisher shift tray.

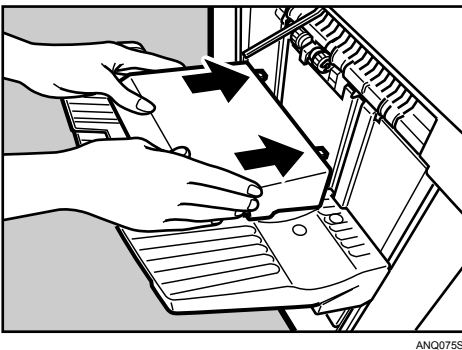

# Removing Jammed Staples

This section explains how to remove jammed staples.

**⚠ CAUTION:**

- *Keep your hands clear of the booklet finisher tray when pulling out or pushing in the finisher's staple unit. You can trap your fingers if you do not.*

**🔊 Important**

- ❑ Curled paper may cause staples to jam. To avoid this, turn copy paper over in the tray.
- ❑ When the finisher is installed, after removing jammed staples, staples will not be ejected the first few times you try to use the stapler.

Remove the jammed staples according to the finisher type. (Check the type if you are unsure.) For details about type of finisher, see "Options", About This Machine.

## Finisher

6

The following procedure explains how to remove jammed staples from the Finisher.

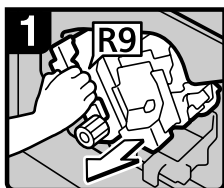

1. Open the finisher front cover.
2. Pull out the staple unit.

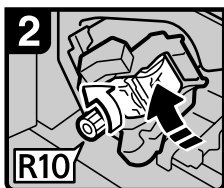

3. Turn knob R10 to rotate to staple unit.

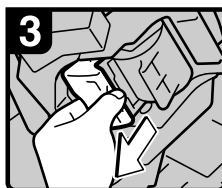

4. Pull out the cartridge lever.

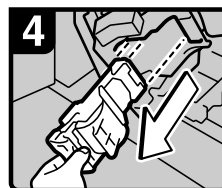

5. Pull out the cartridge gently.

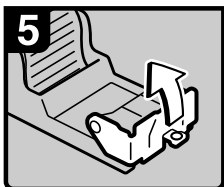

6. Open the cartridge's face plate.

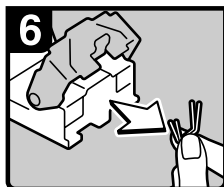

7. Remove any jammed staples.

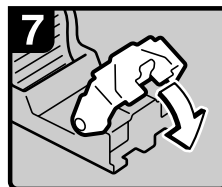

8. Pull down the cartridge's face plate until it clicks.

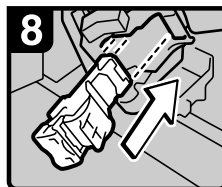

9. Reinstall the cartridge.

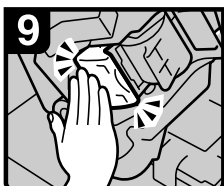

10. Push the cartridge in until it clicks.

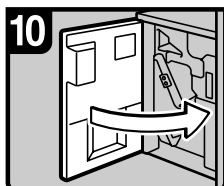

11. Push back the staple unit, and then close the finisher front cover.



## Booklet Finisher (Saddle Stitch)

The following procedure explains how to remove jammed staples from the Booklet Finisher.

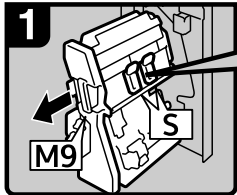

1. Open the finisher front right cover.
2. Pull out the staple unit.

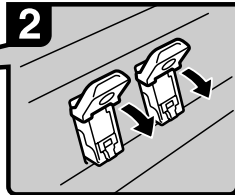

3. Hold the lever and pull it down.

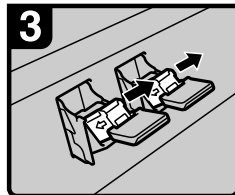

4. Pull out the cartridge gently.

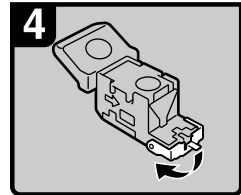

5. Open the cartridge's face plate.

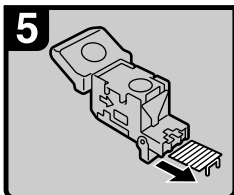

6. Remove any jammed staples.

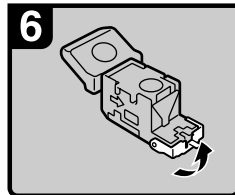

7. Pull up the cartridge's face plate until it clicks.

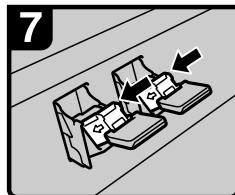

8. Push the cartridge gently.

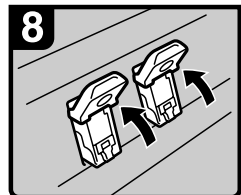

9. Hold the lever and hold it up.

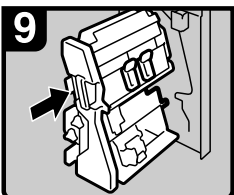

10. Push back the staple unit, and then close the finisher front right cover.

# Removing Punch and Staple Waste

This section explains how to remove punch and staple waste.

 **Note**

- While “Hole Punch Receptacle is full.” or “Waste Staple Receptacle is full.” is displayed, you cannot use the Punch function or the Staple function.

---

## Finisher

---

The following procedure explains how to remove punch and staple wastes from the Finisher.

- Remove punch wastes

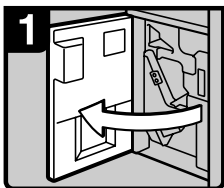

1. Open the finisher front cover.

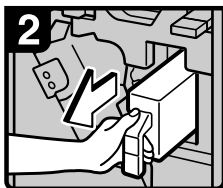

2. Pull out the punch waste box.

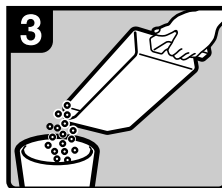

3. Remove punch waste.  
4. Reinstall the punch waste box.  
5. Close the finisher front cover.

ANR025

- Remove staple wastes

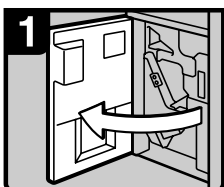

1. Open the finisher front cover.

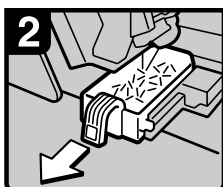

2. Pull out the staple waste box.

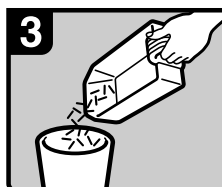

3. Remove staple waste.  
4. Reinstall the staple waste box.  
5. Close the finisher front cover.

ANR024

 **Note**

- If the message is still displayed, reinstall the waste box.

# 7. Remarks

This chapter describes how to maintain and operate the machine.

## Where to Put Your Machine

This section provides precautions for installation, movement and disposal.

---

### Machine Environment

---

Choose your machine's location carefully.

Environmental conditions greatly affect its performance.

---

#### Optimum environmental conditions

---

The following describes precautions when moving the machine.

**⚠ CAUTION:**

- *Keep the machine away from humidity and dust. Otherwise a fire or an electric shock might occur.*
- *Do not place the machine on an unstable or tilted surface. If it topples over, an injury might occur.*

**⚠ CAUTION:**

- *After you move the machine, use the caster fixture to fix it in place. Otherwise the machine might move or come down to cause an injury.*

**⚠ CAUTION:**

- *Make sure the room where you are using the machine is well ventilated and spacious. Good ventilation is especially important when the machine is used heavily.*

- Temperature: 10-32 °C (50-89.6 °F) (humidity to be 54% at 32 °C, 89.6 °F)
- Humidity: 15-80% (temperature to be 27 °C, 80.6 °F at 80%)
- A strong and level base.
- The machine must be level within 5 mm, 0.2 inches: both front to rear and left to right.
- To avoid possible buildup of ozone, make sure to locate this machine in a large well ventilated room that has an air turnover of more than 30 m<sup>3</sup>/hr/person.

---

### **Environments to avoid**

---

- Locations exposed to direct sunlight or other sources of strong light (more than 1,500 lux).
- Locations directly exposed to cool air from an air conditioner or heated air from a heater. (Sudden temperature changes can cause condensation to form inside the machine.)
- Locations close to machines generating ammonia, such as a diazo copy machine.
- Places where the machine will be subject to frequent strong vibration.
- Dusty areas.
- Areas with corrosive gases.

---

## Moving

---

The following describes precautions when moving the machine.

**⚠ CAUTION:**

- *Contact your service representative if you need to lift the machine (such as when relocating it to another floor). Do not attempt to lift the machine without the assistance of your service representative. The machine will be damaged if it topples or is dropped, resulting in malfunction and risk of injury to users. The machine's various handling areas are for service engineer use only. Do not touch these areas.*

**⚠ CAUTION:**

- *Before moving the machine, be sure to disconnect all external connections, especially the power cord from the wall outlet. Damaged power cords are a fire and electric shock hazard.*

**⚠ CAUTION:**

- *Unplug the power cord from the wall outlet before you move the machine. While moving the machine, you should take care that the power cord will not be damaged under the machine.*

**🔧 Important**

- Be careful when moving the machine. Take the following precautions:
  - Turn off the main power.
  - Unplug the power cord from the wall outlet. When you pull out the plug from the socket, grip the plug to avoid damaging the cord, thereby reducing the risk of fire or electric shock.
  - Close all covers and trays, including the front cover and bypass tray.
- Keep the machine level and carry it carefully, taking care not to jolt or tip it. Rough handling may cause a malfunction or damage the hard disk or memory, resulting in loss of stored files.
- Do not take off the holding stand.
- Protect the machine from strong shocks. Impact can damage the hard disk and cause stored files to be lost. As a precautionary measure, files should be copied to another computer.

---

## Power Connection

---

The following explains power supply.

**⚠ WARNING:**

- ***The supplied power cord is for use with this equipment only. Do not use with other appliances. Doing so may result in fire, electric shock, or injury.***

**⚠ WARNING:**

- ***Connect the machine only to the power source described on the inside front cover of this manual. Connect the power cord directly into a wall outlet and do not use an extension cord.***
- ***Do not damage, break or make any modifications to the power cord. Do not place heavy objects on it. Do not pull it hard nor bend it more than necessary. These actions could cause an electric shock or fire.***

**⚠ WARNING:**

- ***If the power cord is damaged (exposure of the core, disconnection, etc.), contact your service representative to change a new one. Operating the machine with a damaged power cord may cause an electric shock or fire.***

**⚠ CAUTION:**

- ***When you disconnect the power plug from the wall outlet, always pull the plug (not the cable).***

**⚠ CAUTION:**

- ***To disconnect the power code, pull it out by plug. Do not drag the code itself. Doing so may result in damage to the code, leading to fire or electric shock.***
- Make sure the plug is inserted firmly in the wall outlet.
- Voltage must not fluctuate by more than 10%.
- The wall outlet shall be installed near the machine and shall be easily accessible.

---

## Access to the Machine

---

Place the machine near the power source, providing the clearance areas shown.

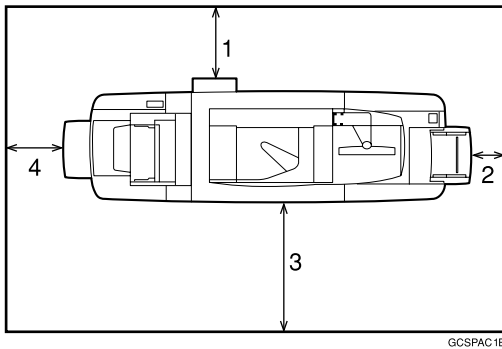

- 1. Rear: more than 20 cm (7.8")**
- 2. Right: more than 3 cm (1.1")**
- 3. Front: more than 55.5 cm (21.6")**
- 4. Left: more than 40 cm (15.7")**

 **Note**

- For the required space when options are installed, contact your service representative.

# Maintaining Your Machine

If the exposure glass or ADF belt is dirty, copy clarity may be reduced. Clean these parts if they are dirty.

## Important

- Do not use chemical cleaners or organic solvents, such as thinner or benzene. If such substances get inside the machine or melt plastic parts, a failure might occur.
- Do not clean parts other than those explicitly specified in this manual. Other parts should only be cleaned by your service representative.

## ❖ How to maintain

Cleaning the machine Wipe the machine with a soft, damp cloth, and then wipe it with a dry cloth to remove the water.

---

## Cleaning the Exposure Glass

---

The following procedure explains how to clean the exposure glass.



Wipe the surface of the exposure glass.

---

## Cleaning the Auto Document Feeder

---

The following procedure explains how to clean the ADF.

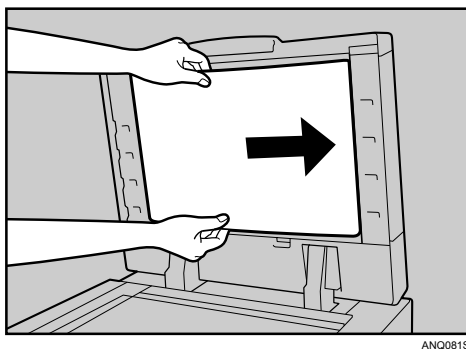

Wipe the surface of the belt, moving it.



# Earth Leakage Circuit Breaker

This section explains how to test the earth leakage circuit breaker. For details, see "Guide to Components", About This Machine.

**⚠ WARNING:**

- **Do not turn the earth leakage circuit breaker from the off to the on position. Otherwise it might lead to an electric shock, fire or smoke, or cause the circuit breakers to trip.**

To prevent electric shock this machine has an earth leakage circuit breaker. The earth leakage circuit breaker is normally in the on position.

Once a month, check that it functions properly by following the procedure below.

**⚡ Important**

- ❑ If the earth leakage circuit breaker is not functioning normally, contact your sales or service representative.

**1** Turn off the power.

**2** Using the tip of a ball-point pen, press the test button of the earth leakage circuit breaker.

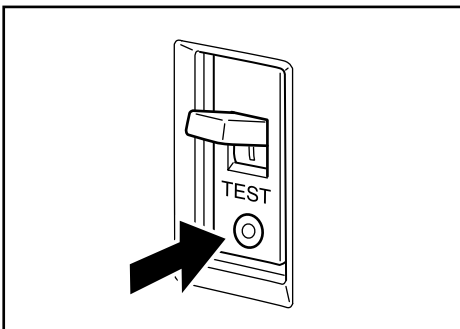

ANQ087S

**3** Confirm that the earth leakage circuit breaker switch moves to the off position.

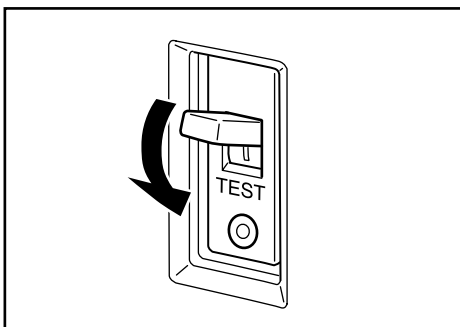

ANQ088S

**4** Turn the switch to the on position.

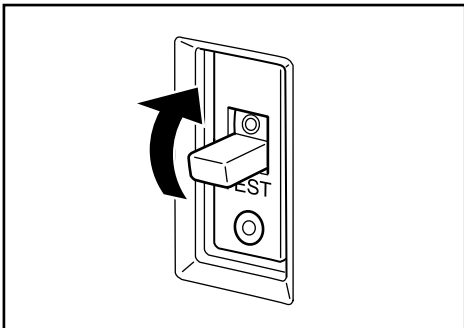

**5** Turn on the main power switch of the machine.

 **Note**

- If the power does not come on, check if the earth leakage circuit breaker is in the off position. If so, do not turn it to the on position. Contact your sales or service representative immediately.

# INDEX

## A

---

- Access to the Machine, 113
- Adding
  - Paper*, 65
  - Staples*, 90
  - Toner*, 87
- Adding Staples
  - Booklet Finisher*, 91
  - Finisher*, 90
- Alert Messages, 40
- Auto Document Feeder (ADF), 114

## B

---

- Booklet Finisher, 91, 107

## C

---

- Cannot Browse
  - the Network to Send a Scan File, 52
- Cannot Exit from Connect Copy, 26
- Cannot Make Clear Copies, 27
- Cannot Make Copies As Wanted, 29
- Cannot Print, 42
- Cannot Send Scanned Files, 52
- Changing the Paper Size, 75
  - LCT (Tray 4 and 5)*, 78
  - Tray 2 and 3*, 76
  - Wide LCT*, 81
- Changing to a Size that is
  - Not Automatically Detected, 84
- Checking Machine Status and Settings, 5
- Checking the Error Log, 41
- Cleaning
  - Auto Document Feeder*, 114
  - Exposure Glass*, 114
- Clearing Misfeeds, 93
- Combine, 29
- Connect Copy, 24, 25, 26, 33
- Connect Copy is Cancelled, 25
- Copy Function, 19

## D

---

- Data Storage, 5
- Display During Connect Copy, 24
- Document Server, 9
- Duplex, 29

## E

---

- Earth Leakage Circuit Breaker, 115
- Edit, 29
- Enquiry, 5
- Environment, 109
- Environments to avoid, 110
- Error Log, 41
- Exposure Glass, 114

## F

---

- Finisher, 86, 90, 106, 108

## H

---

- How to Read This Manual, 1

## I

---

- If USB Connection Fails, 38
- Indicators, 3
- Inserting Toner, 89
- Interposer, 72

## J

---

- Job is Not Performed, 14

## L

---

- Large Capacity Tray (LCT), 69, 78
- Letterhead, 74
- Loading Paper, 65
  - Interposer*, 72
  - LCT*, 69
  - Multi Bypass Tray (Tray 7)*, 71
  - Tray 2 and 3*, 68
  - Wide LCT*, 70
- Locating Jammed Paper, 94

## M

---

- Machine Address Info, 5
- Machine environment, 109
- Maintaining Your Machine, 114
- Maintenance Info, 5
- Manuals for This Machine, i
- Memory is Full, 33
- Moving, 111
- Multi-accessing, 14
- Multi Bypass Tray (Tray 7), 71

## N

---

- Names of Major Options, 2
- Network Delivery Function  
Cannot be Used, 53

## O

---

- Operations are Not Possible  
When Messages Appear, 53
- Optimum environmental conditions, 109
- Other Printing Problems, 45

## P

---

- Panel Tone, 4
- Pausing Copy When Using Finisher, 86
- Power connection, 112
- Printer Function, 35
- Printing surface, 74
- Problems Operating the Machine, 9
- Punch Waste, 108

## R

---

- Removing Jammed Paper, 93, 96
- Removing Jammed Staples, 106
  - Booklet Finisher*, 107
  - Finisher*, 106
- Removing Punch and Staple Waste, 108

## S

---

- Scanner Function, 51
- Scanning is Not Done as Expected, 51
- Stamp, 29
- Staple Waste, 108
- Status Messages, 39
- Stored Files Cannot Be Accessed, 52
- Stored Files Cannot be Edited, 53

## T

---

- Toner, 87
- Tray 1 (Tandem Tray), 65
- Troubleshooting
  - Copy Function*, 19
  - Printer Function*, 35
  - Scanner Function*, 51
- TWAIN, 52, 61
- TWAIN Driver Cannot be Started, 52

## U

---

- Used Toner, 89

## W

---

- When a Message Appears
  - Copy Function*, 19
  - Printer Function*, 39
  - Scanner Function*, 54
  - Scanner Function (Client Computer)*, 61
- When a Message Appears during  
Installation of the Printer Driver, 35
- When an Indicator  
to the Left of a Function Key is Lit, 8
- When the Machine  
Does Not Operate As wanted, 3
- When Z-folded paper  
is not properly aligned, 105
- Wide Large Capacity Tray (Wide LCT), 70, 81
- Windows 2000, 36
- Windows 95/98/Me, 35
- Windows NT 4.0, 37
- Windows Server 2003, 36
- Windows XP, 36

In accordance with IEC 60417, this machine uses the following symbols for the main power switch:

**I** means **POWER ON.**

**⏻** means **STAND BY.**

# Operating Instructions Troubleshooting

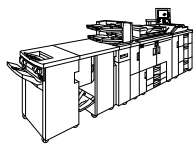

## Free Manuals Download Website

<http://myh66.com>

<http://usermanuals.us>

<http://www.somanuals.com>

<http://www.4manuals.cc>

<http://www.manual-lib.com>

<http://www.404manual.com>

<http://www.luxmanual.com>

<http://aubethermostatmanual.com>

Golf course search by state

<http://golfingnear.com>

Email search by domain

<http://emailbydomain.com>

Auto manuals search

<http://auto.somanuals.com>

TV manuals search

<http://tv.somanuals.com>