

## SP 1200S

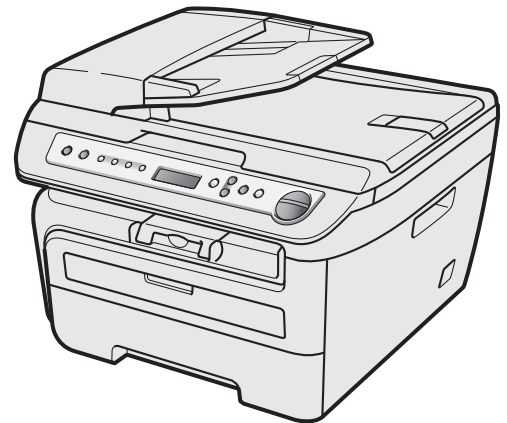

Before you can use the machine, you must set up the hardware and install the driver. Please read this 'Quick Setup Guide' for proper set up and installation instructions.

### STEP 1

Setting Up the Machine







### STEP 2

Installing the Driver & Software

**Setup is Complete!**

Keep this 'Quick Setup Guide' and the supplied CD-ROM in a convenient place for quick and easy reference at all times.

## Symbols used in this guide

 Warning	 Caution	 Improper Setup
<p>Warnings tell you what to do to prevent possible personal injury.</p>	<p>Cautions specify procedures you must follow or avoid to prevent possible damage to the machine or other objects.</p>	<p>Improper Setup icons alert you to devices and operations that are not compatible with the machine.</p>
 Note	 User's Guide or Software User's Guide	
<p>Notes tell you how you should respond to a situation that may arise or give tips about how the current operation works with other features.</p>	<p>Indicates reference to the User's Guide or Software User's Guide which is on the CD-ROM we have supplied.</p>	

## Safety Precautions

---

To use the machine safely .....	2
Symbols for the main power switch .....	3
Regulations .....	4
Important Information for Australia .....	5
Important Information for New Zealand .....	6
Important Information for Some Countries .....	7

## Getting Started

---

Carton components for EU .....	8
Carton components for Asia/Oceania .....	9
Control panel (For EU model) .....	10
Control panel (For Asia/Oceania model) .....	11

## STEP 1 – Setting Up the Machine

---

Installing the drum unit and toner cartridge assembly .....	12
Loading paper in the paper tray .....	13
Install the power cord .....	14
Selecting your language .....	14
Setting the LCD contrast .....	15

## Supplied CD-ROM

---

Supplied CD-ROMs for 'SP 1200S' .....	16
Drivers and Utilities for SP 1200S .....	16
PaperPort™ 11SE and Documentation for SP 1200S .....	16

## STEP 2 – Installing the Driver & Software

---

Installing TYPE 1200S Drivers and Utilities .....	18
Installing ScanSoft™ PaperPort™ 11SE for Windows® .....	20
View and Installing the documentation .....	21

## Consumables and Options

---

Consumables .....	22
-------------------	----

## To use the machine safely

Please keep these instructions for later reference and read them before attempting any maintenance.

### Warning



Before cleaning the inside of the machine, first unplug the telephone line cord, and then the power cord from the electrical socket.

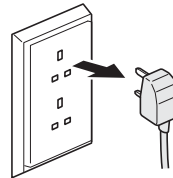

DO NOT use flammable substances, any type of spray or organic solvent/liquids containing alcohol/ammonia to clean the inside or outside of the machine. Doing this may cause a fire or electrical shock. Refer to *Routine maintenance* for how to clean the machine in the User's Guide.



DO NOT handle the plug with wet hands. Doing this might cause an electrical shock.

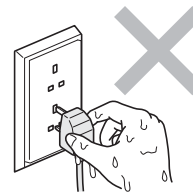

Always make sure the plug is fully inserted.



After you have just used the machine, some internal parts of the machine will be extremely hot. When you open the front or back cover of the machine, DO NOT touch the shaded parts shown in the illustration.

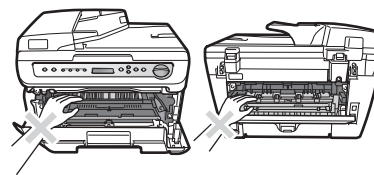

To prevent injuries, be careful not to put your hands on the edge of the machine under the document cover or scanner cover as shown in the illustration.

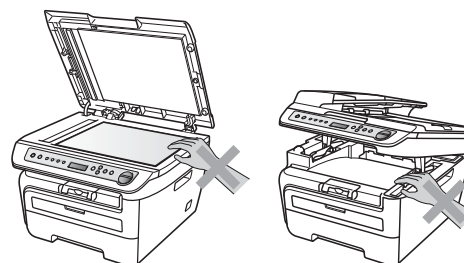



To prevent injuries, DO NOT put your fingers in the area shown in the illustrations.

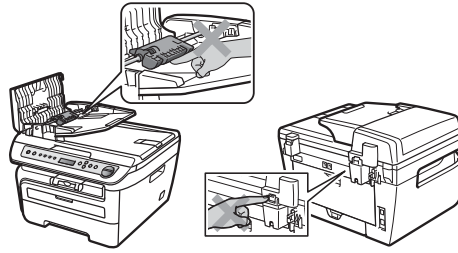

DO NOT use a vacuum cleaner to clean up scattered toner. Doing this might cause the toner dust to ignite inside the vacuum cleaner, potentially starting a fire. Please carefully clean the toner dust with a dry, lint-free cloth and dispose of it according to local regulations.



If moving your machine, use the handholds provided. First making sure to disconnect any cables.



Plastic bags are used in the packaging of your machine. To avoid danger of suffocation, keep these bags away from babies and children.

## Note

The fuser unit is marked with a caution label. DO NOT remove or damage the label.

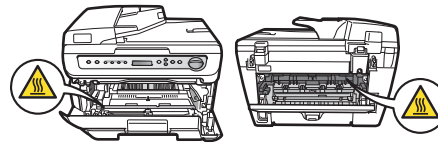



## Caution

Be sure to disconnect the plug from the wall outlet and clean the prongs and the area around the prongs at least once a year. Allowing dust to build up on the plug constitutes a fire hazard.

## Symbols for the main power switch

In accordance with IEC 60417, this machine uses the following symbols for the main power switch:

-  means POWER ON.
-  means POWER OFF.

## Note

When you move the machine, grasp the side handholds that are under the scanner. Do NOT carry the machine by holding it at the bottom.

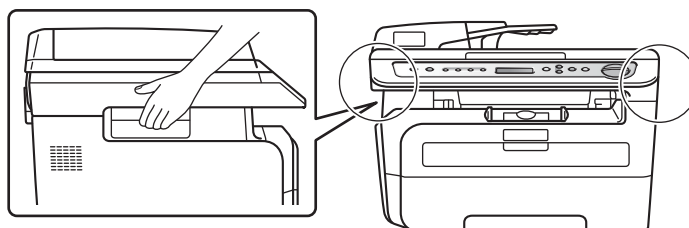

## Regulations

### IEC 60825-1:2007 Specification

This machine is a Class 1 laser product as defined in IEC 60825-1:2007 specifications. The label shown below is attached in countries where required.

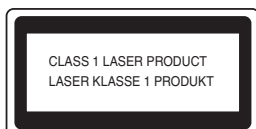

This machine has a Class 3B Laser Diode which emits invisible laser radiation in the Scanner Unit. The Scanner Unit should not be opened under any circumstances.

### Laser Diode

Wave length: 780 - 800 nm

Output: 10 mW max.

Laser Class: Class 3B

### Warning

Use of controls, adjustments or performance of procedures other than those specified in this manual may result in hazardous radiation exposure.

### Disconnect device

This product must be installed near an AC power outlet/electrical socket that is easily accessible. In case of emergencies, you must disconnect the power cord from the AC power outlet/electrical socket to shut off power completely.

### Wiring information (U.K. only)

If you need to replace the plug fuse, fit a fuse that is approved by ASTA to BS1362 with the same rating as the original fuse.

Always replace the fuse cover. Never use a plug that does not have a cover. If in any doubt, call a qualified electrician.

### Warning - This printer must be earthed.

The wires in the mains lead are coloured in line with the following code:

- Green and Yellow: Earth
- Blue: Neutral
- Brown: Live

### Radio interference

This product complies with EN55022 (CISPR Publication 22)/Class B. When connecting the machine to a computer, ensure that you use the following interface cables.

A USB cable which must not exceed 2.0 metres in length.

### EU Directive 2002/96/EC and EN50419

#### Users in the EU, Switzerland and Norway

Our Products contain high quality components and are designed to facilitate recycling.

Our products or product packaging are marked with the symbol below.



European  
Union only

The symbol indicates that the product must not be treated as municipal waste. It must be disposed of separately via the appropriate return and collection systems available. By following these instructions you ensure that this product is treated correctly and help to reduce potential impacts on the environment and human health, which could otherwise result from inappropriate handling. Recycling of products helps to conserve natural resources and protect the environment.

For more detailed information on collection and recycling systems for this product, please contact the shop where you purchased it, your local dealer or sales/service representatives.

#### All Other Users

If you wish to discard this product, please contact your local authorities, the shop where you bought this product, your local dealer or sales/service representatives.

### International ENERGY STAR® Qualification Statement

The purpose of the International ENERGY STAR® Program is to promote the development and popularization of energy-efficient office equipment. As an ENERGY STAR® Partner, Ricoh Company, Ltd. has determined that this product meets the ENERGY STAR® guidelines for energy efficiency.



## Important Information for Australia

### IMPORTANT-For Your Safety

To ensure safe operation the three-pin plug supplied must be inserted only into a standard three-pin power point which is effectively grounded through the normal household wiring.

Extension cords used with the equipment must be three-conductor and be correctly wired to provide connection to ground. Incorrectly wired extension cords are a major cause of fatalities.

The fact that the equipment operates satisfactorily does not imply that the power is grounded and that the installation is completely safe. For your safety, if in any doubt about the effective grounding of the power, consult a qualified electrician.

### Important safety instructions

- 1 Read all of these instructions.
- 2 Save them for later reference.
- 3 Follow all warnings and instructions marked on the product.
- 4 Unplug this product from the wall socket before cleaning the outside of the machine and the scanner glass. DO NOT use liquid or aerosol cleaners. Use a damp cloth for cleaning.
- 5 DO NOT use this product near water.
- 6 DO NOT place this product on an unstable cart, stand, or table. The product may fall, causing serious damage to the product.
- 7 Slots and openings in the casing at the back or bottom are provided for ventilation; to ensure reliable operation of the product and to protect it from overheating, these openings must not be blocked or covered. The openings should never be blocked by placing the product on a bed, sofa, rug, or other similar surface. This product should never be placed near or over a radiator or heater. This product should never be placed in a built-in installation unless adequate ventilation is provided.
- 8 This product should be connected to an AC power source within the range indicated on the rating label. DO NOT connect it to a DC power source or inverter. If you are not sure, contact a qualified electrician.
- 9 This product is equipped with a 3-wire grounded plug, a plug having a third (grounded) pin. This plug will only fit into a grounded power outlet. This is a safety feature. If you are unable to insert the plug into the outlet, call your electrician to replace your obsolete outlet. DO NOT defeat the purpose of the grounded plug.
- 10 DO NOT place anything on top of the power cord including this machine. DO NOT allow the power cord to be stepped on.
- 11 DO NOT touch a document during printing.
- 12 Never push objects of any kind into this product through cabinet slots, since they may touch dangerous voltage points or short out parts resulting in a risk of fire or electric shock. Never spill liquid of any kind on the product.
- 13 DO NOT attempt to service this product yourself, because opening or removing covers may expose you to dangerous voltage points and/or other risks. Refer all servicing to service personnel.
- 14 Wait until pages have exited the machine before picking them up.
- 15 Unplug this product from the wall outlet and refer servicing to Authorised Service Personnel under the following conditions:
  - When the power cord is damaged or frayed.
  - If liquid has been spilled into the product.
  - If the product has been exposed to rain or water.
  - If the product does not operate normally when the operating instructions are followed. Adjust only those controls that are covered by the operating instructions. Incorrect adjustment of other controls may result in damage and will often require extensive work by a qualified technician to restore the product to normal operation.
  - If the product has been dropped or the casing has been damaged.
  - If the product exhibits a distinct change in performance, indicating a need for service.

## Important Information for New Zealand

### Important Safety Instructions

- 1 Read all of these instructions.
  - 2 Save them for later reference.
  - 3 Follow all warnings and instructions marked on the product.
  - 4 Unplug this product from the wall outlet before cleaning the outside of the machine and the scanner glass. DO NOT use liquid or aerosol cleaners. Use a damp cloth for cleaning.
  - 5 DO NOT place this product on an unstable surface, stand, or table. The product may fall, causing serious damage to the product.
  - 6 Slots and openings in the casing and the back or bottom are provided for ventilation; to ensure reliable operation of the product and to protect it from overheating, these openings must not be blocked or covered. The openings should never be blocked by placing the product on a bed, sofa, rug, or other similar surface. This product should never be placed near or over a radiator or heater. This product should not be placed in a built-in installation unless proper ventilation is provided.
  - 7 This product should be connected to an AC power source within the range indicated on the rating label. DO NOT connect it to a DC power source or inverter. If you are not sure, contact a qualified electrician.
  - 8 This product is equipped with a 3-wire earthed plug. This plug will fit into only an earthed socket. This is a safety feature. If you are unable to insert the plug into the outlet, contact your electrician to replace your obsolete socket. DO NOT defeat the purpose of an earthed plug.
  - 9 DO NOT place anything on top of the power cord including this machine. DO NOT allow the power cord to be stepped on.
  - 10 DO NOT touch a document during printing.
  - 11 Never push objects of any kind into this product through cabinet slots, since they may touch dangerous voltage points or short out parts resulting in a risk of fire or electric shock. Never spill liquid of any kind on the product.
  - 12 DO NOT attempt to service this product yourself, because opening or removing covers may expose you to dangerous voltage points and/or other risks. Refer all servicing to service personnel.
  - 13 Unplug this product from the mains power, and refer servicing to qualified Service Personnel under the following conditions:
    - If the power cord is damaged or frayed.
    - If liquid has been spilled into the product.
    - If the product has been exposed to rain or water.
- If the product does not operate normally when the operating instructions are followed. Adjust only those controls that are covered by the operating instructions. Incorrect adjustment of other controls may result in damage and will often require extensive work by a qualified technician to restore the product to normal operation.
  - If the product has been dropped or the casing has been damaged.
  - If the product exhibits a distinct change in performance, indicating a need for service.

### IMPORTANT-For Your Safety

To ensure safe operation the three-pin plug supplied must be inserted only into a standard three-pin power point which is effectively grounded through the normal household wiring.

Extension cords used with the equipment must be three-conductor and be correctly wired to provide connection to ground. Incorrectly wired extension cords are a major cause of fatalities.

The fact that the equipment operates satisfactorily does not imply that the power is grounded and that the installation is completely safe. For your safety, if in any doubt about the effective grounding of the power, consult a qualified electrician.



## Important Information for Some Countries

### Important Safety Instructions

- 1 Read all of these instructions.
- 2 Save them for later reference.
- 3 Follow all warnings and instructions marked on the product.
- 4 Unplug this product from the wall outlet before cleaning the outside of the machine and the scanner glass. DO NOT use liquid or aerosol cleaners. Use a damp cloth for cleaning.
- 5 DO NOT place this product near water.
- 6 DO NOT place this product on an unstable cart, stand, or table. The product may drop, causing serious damage to the product.
- 7 Slots and openings in the casing at the back or bottom are provided for ventilation; to ensure reliable operation of the product and to protect it from overheating, these openings must not be blocked or covered. The openings should never be blocked by placing the product on a bed, sofa, rug, or other similar surface. This product should never be placed near or on a radiator or heater. This product should never be placed in a built-in installation unless adequate ventilation is provided.
- 8 This product should be connected to an AC power source within the range indicated on the rating label. DO NOT connect it to a DC power source or inverter. If you are not sure, contact a qualified electrician.
- 9 This product is equipped with a 2-wire grounding type plug or a 3-wire grounding type plug (Only for Singapore, Malaysia, Hong Kong and India), a plug having two or three pins. This plug will only fit into only a grounding-type power outlet. This is a safety feature. If you are unable to insert the plug into the outlet, contact your electrician to replace your obsolete outlet. DO NOT defeat the purpose of the grounding-type plug.
- 10 DO NOT place anything on top of the power cord including this machine. DO NOT allow the power cord to be stepped on.
- 11 If an extension cord is used with this product, make sure that the total ampere ratings on the products plugged into the extension cord DO NOT exceed the extension cord ampere rating.
- 12 DO NOT touch a document during printing.
- 13 Never push objects of any kind into this product through cabinet slots, since they may touch dangerous voltage points or short out parts resulting in the risk of fire or electric shock. Never spill liquid of any kind on the product.
- 14 DO NOT attempt to service this product yourself, as opening or removing covers may expose you to dangerous voltage points and/or other risks, and may void your warranty. Please refer all servicing to your Authorized Service Personnel.
- 15 Unplug this product from the wall outlet and refer servicing to Authorized Service Personnel under the following conditions:
  - If the power cord is damaged or frayed.
  - If the product has been spilled by liquid.
  - If the product has been exposed to rain or water.
  - If the product does not operate normally when the operating instructions are followed. Adjust only those controls that are covered by the operating instructions. Incorrect adjustment of other controls may result in damage and will often require extensive work by a qualified technician to restore the product to normal operation.
  - If the product has been dropped or the casing has been damaged.
  - If the product exhibits a distinct change in performance, indicating a need for service.
- 16 To protect your product against power surges, we recommend the use of a power protection device (Surge Protector).

### Warning

For protection against the risk of electrical shock, always disconnect all cables from the wall outlet before servicing, modifying or installing the equipment.

Ricoh cannot accept any financial or other responsibilities that may be the result of your use of this information, including direct, special or consequential damages. There are no warranties extended or granted by this document.





## Carton components for EU

Carton components may vary from one country to another.

Save all packing materials and the carton in case for any reason you must ship your machine.

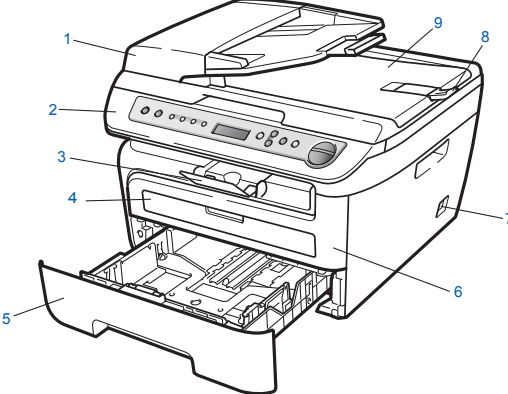
### Warning

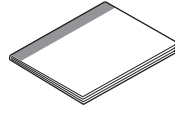
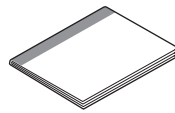
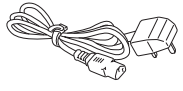
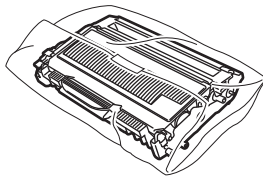
Plastic bags are used in the packaging of your machine. To avoid danger of suffocation, please keep these bags away from babies and children.

 <ol style="list-style-type: none"><li>1. Automatic Document Feeder (ADF)</li><li>2. Control panel</li><li>3. Face-down Output Tray Support</li><li>4. Manual Feed Slot</li><li>5. Paper Tray</li><li>6. Front Cover</li><li>7. Power Switch</li><li>8. ADF Document Output Support Flap</li><li>9. Document Cover</li></ol>	 <p><b>CD-ROMs</b> For Drivers For User Guide and Paper Port™</p>	
	 <p><b>Quick Install Guide</b></p>	
	 <p><b>Safety booklet</b></p>	
 <p><b>AC Power Cord</b></p>	 <p><b>Drum Unit Assembly</b> (including Toner Cartridge)</p>	 <p><b>USB cable</b></p>

Do NOT connect the interface cable at this time. Connecting the interface cable is done during the software installation process.

#### ■ USB interface cable

Please make sure you use a USB 2.0 interface cable that is no longer than 6 feet (2 metres). When you use a USB cable, make sure you connect it to the USB port of your computer and not to a USB port on a keyboard or non-powered USB hub.





## Carton components for Asia/Oceania

Carton components may vary from one country to another.

Save all packing materials and the carton in case for any reason you must ship your machine.

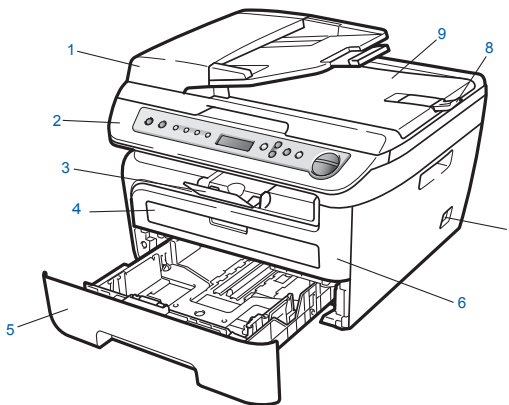
### Warning

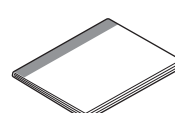
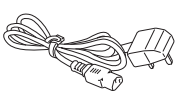
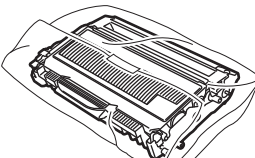
Plastic bags are used in the packaging of your machine. To avoid danger of suffocation, please keep these bags away from babies and children.

 <ol style="list-style-type: none"> <li>1. Automatic Document Feeder (ADF)</li> <li>2. Control panel</li> <li>3. Face-down Output Tray Support</li> <li>4. Manual Feed Slot</li> <li>5. Paper Tray</li> <li>6. Front Cover</li> <li>7. Power Switch</li> <li>8. ADF Document Output Support Flap</li> <li>9. Document Cover</li> </ol>	 <p><b>CD-ROMs</b> For Drivers For User Guide and Paper Port™</p>	
	 <p><b>Quick Setup Guide</b></p>	
	 <p><b>User Guide</b></p>	
 <p><b>AC Power Cord</b></p>	 <p><b>Drum Unit Assembly</b> (including Toner Cartridge)</p>	 <p><b>USB cable</b></p>

Do NOT connect the interface cable at this time. Connecting the interface cable is done during the software installation process.

#### ■ USB interface cable

Please make sure you use a USB 2.0 interface cable that is no longer than 6 feet (2 metres). When you use a USB cable, make sure you connect it to the USB port of your computer and not to a USB port on a keyboard or non-powered USB hub.

## Control panel (For EU model)

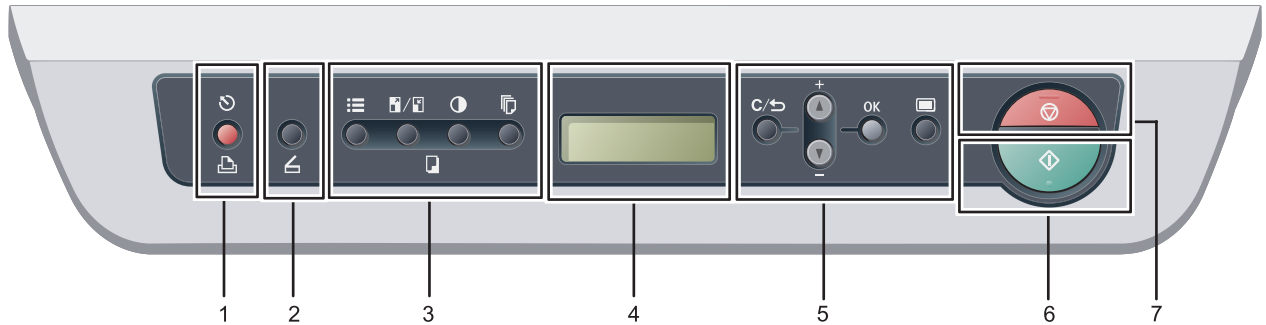

For the details of the control panel, see *Control panel overview* in Chapter 1 of the *User's Guide*.

- 1 **Print key**  
 **Job Cancel**  
Cancels a programmed print job and clears it from the machine's memory.  
To cancel multiple print jobs, hold down this key until the LCD shows *Job Cancel (All)*.
- 2 **Scan key**  
Puts the machine in Scan mode. (For details about scanning, see the *Software User's Guide on the CD-ROM*.)
- 3 **Copy keys:**
  - Options**  
You can quickly and easily choose temporary settings for copying.
  - Enlarge/Reduce**  
Reduces or enlarges copies.
  - Contrast**  
You can increase or decrease the contrast of your copies.
  - Number of Copies**  
Use this key to make multiple copies.
- 4 **LCD**  
Displays messages to help you set up and use your machine.
- 5 **Menu keys:**
  - Clear/Back**  
Deletes entered data or lets you cancel the current setting.
  - + or -**  
Press to scroll through the menus and options.
  - OK**  
Lets you store your settings in the machine.
  - Menu**  
Lets you access the Menu to program your settings in this machine.
- 6 **Start**  
Lets you start making copies or scanning.
- 7 **Stop/Exit**  
Stops an operation or exits from a menu.

## Control panel (For Asia/Oceania model)

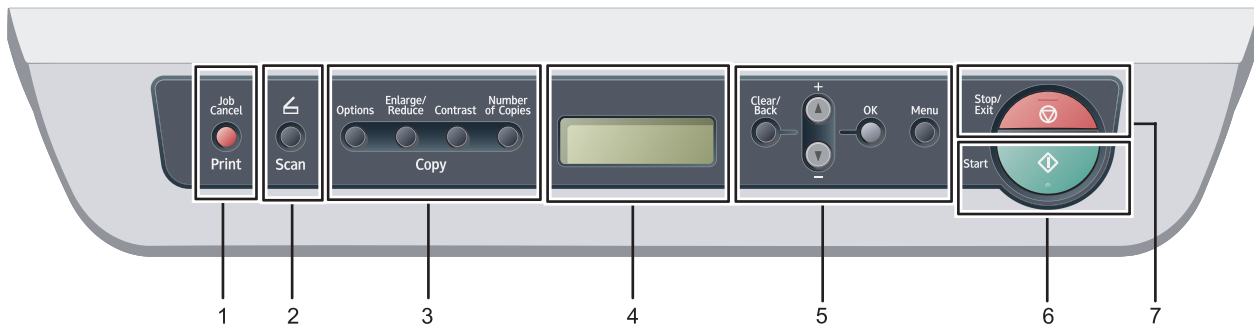

 For the details of the control panel, see *Control panel overview* in Chapter 1 of the User's Guide.

### 1 **Print key**

#### **Job Cancel**

Cancels a programmed print job and clears it from the machine's memory.

To cancel multiple print jobs, hold down this key until the LCD shows *Job Cancel (All)*.

### 2 **Scan key**

Puts the machine in Scan mode. (For details about scanning, see the *Software User's Guide on the CD-ROM*.)

### 3 **Copy keys:**

#### **Options**

You can quickly and easily choose temporary settings for copying.

#### **Enlarge/Reduce**

Reduces or enlarges copies.

#### **Contrast**

You can increase or decrease the contrast of your copies.

#### **Number of Copies**

Use this key to make multiple copies.

### 4 **LCD**

Displays messages to help you set up and use your machine.

### 5 **Menu keys:**

#### **Clear/Back**

Deletes entered data or lets you cancel the current setting.

▲ + or ▼ -

Press to scroll through the menus and options.

#### **OK**

Lets you store your settings in the machine.

#### **Menu**

Lets you access the Menu to program your settings in this machine.

### 6 **Start**

Lets you start making copies or scanning.

### 7 **Stop/Exit**

Stops an operation or exits from a menu.

## 1 Installing the drum unit and toner cartridge assembly

### ⊘ Improper Setup

**DO NOT** connect the interface cable.  
Connecting the interface cable is done when installing the driver.

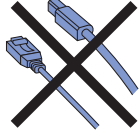

### 1 Open the front cover.

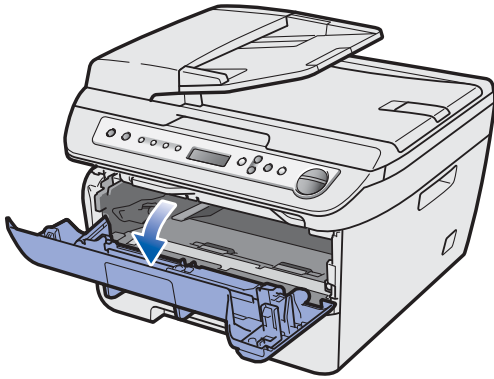

### 2 Unpack the drum unit and toner cartridge assembly.

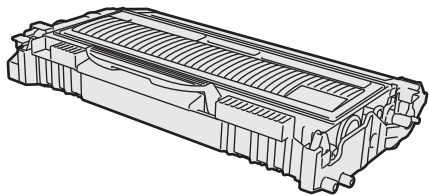

### 3 Gently shake it from side to side several times to distribute the toner evenly inside the assembly.

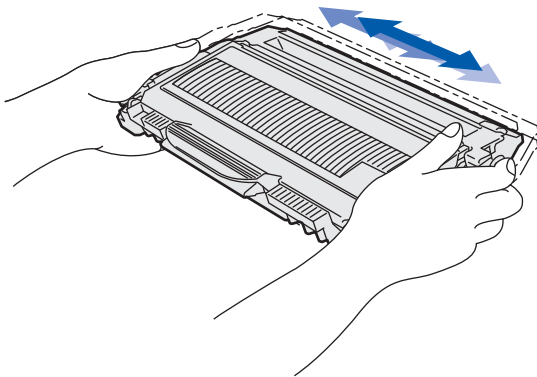

### 4 Put the drum unit and toner cartridge assembly into the machine.

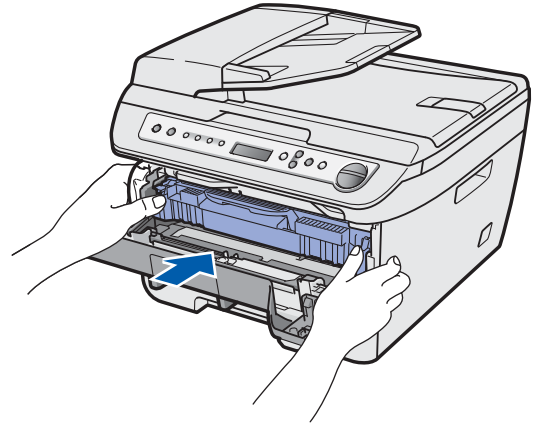
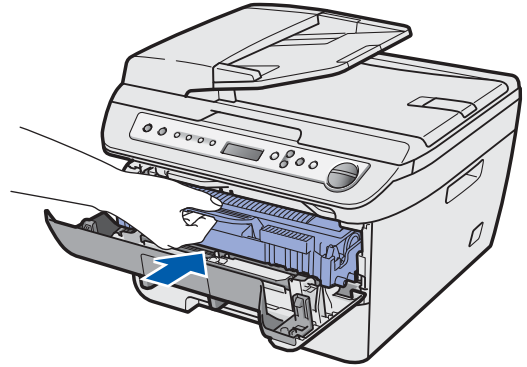

### 5 Close the front cover of the machine.

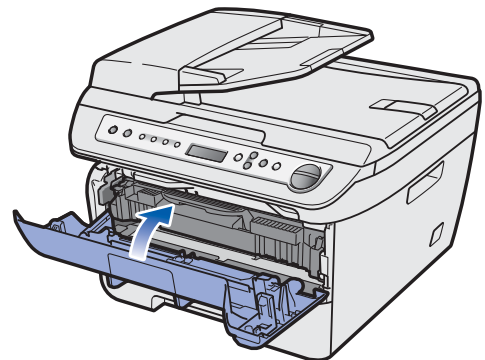

## 2 Loading paper in the paper tray

- 1 Pull the paper tray completely out of the machine.

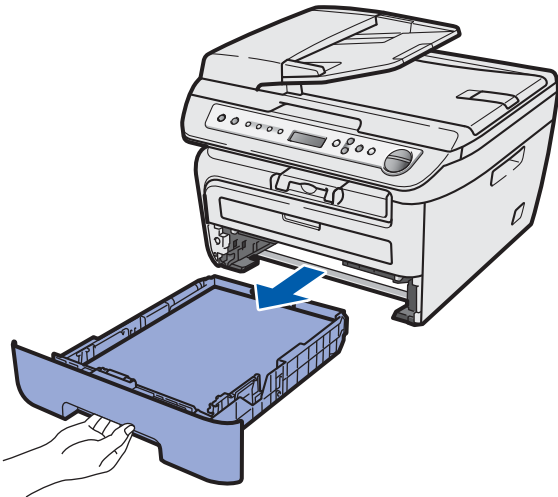

- 2 While pressing the green paper-guide release lever, slide the paper guides to fit the paper size you are using. Make sure that the guides are firmly in the slots.

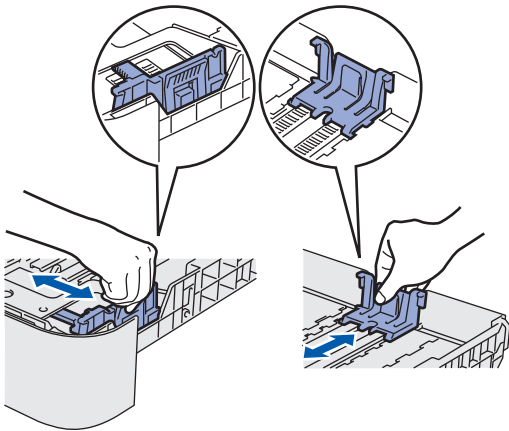

### Note

**(For USA/Canada and Asia)**  
For Legal size paper, press the release button in the bottom of the paper tray and then pull out the back of the paper tray. (Legal size paper is not available in some regions.)

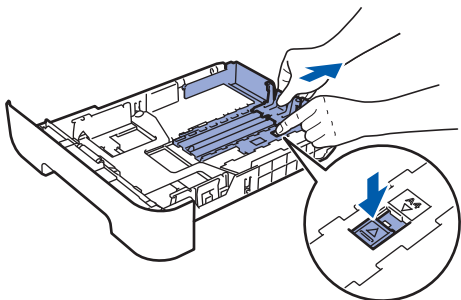

- 3 Fan the stack of paper well to avoid paper jams and misfeeds.

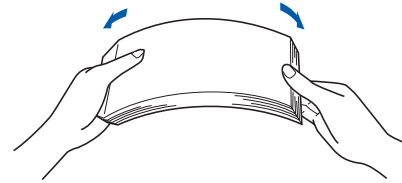

- 4 Put paper in the paper tray. Make sure that the paper is flat in the tray and below the maximum paper mark (1).

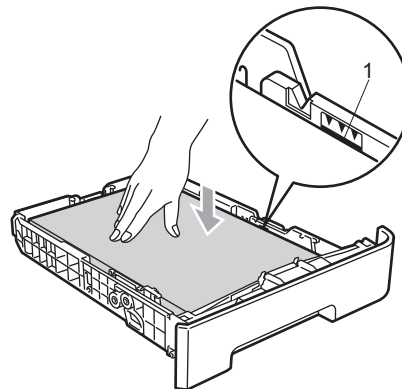

### Caution

Make sure the paper guides touch the sides of the paper so it will feed properly. If you do not this, it may cause damage to your machine.

- 5 Put the paper tray firmly back into the machine. Make sure that it is completely inserted into the machine.

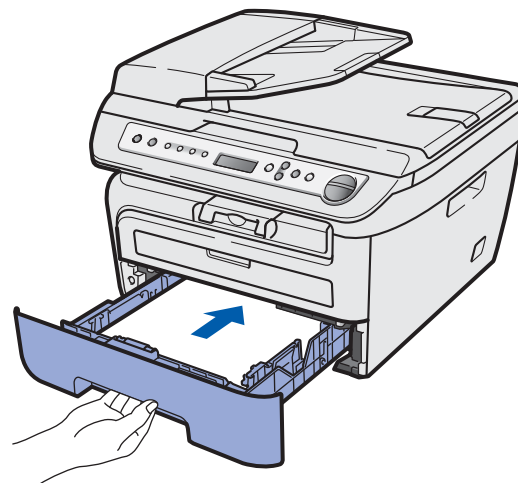

### 3 Install the power cord

- 1 Make sure that the machine's power switch is off. Connect the AC power cord to the machine.

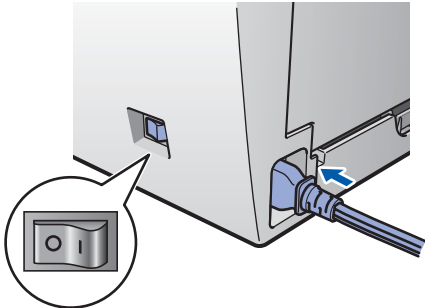

- 2 Plug the AC power cord into an AC outlet. Turn the power switch on.

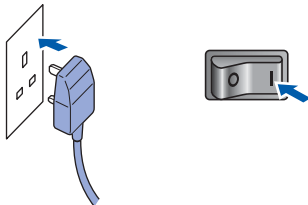



### 4 Selecting your language

- 1 After turning the power switch on, the LCD shows:

```
Select Language
Press OK Key
```

Press **OK**.

- 2 Press  or  to select your language and press **OK**.

```
Select ▲▼ or OK
English
```

- 3 If your language is selected, press  (Yes).

```
English?
▲.Yes ▼. No
```









#### Note

*If you have set the wrong language, you can change the language from the control panel menu of the machine. (For details, see "Changing the LCD language" in Appendix of the User's Guide.)*



## 5 Setting the LCD contrast

You can change the contrast to help the LCD look lighter or darker.

- 1** Press  **Menu** and  or  to select 1.General Setup. Press **OK**.
- 2** Press  or  to select 5.LCD Contrast. Press **OK**.
- 3** Press  to increase the contrast.  
**—OR—**  
Press  to decrease the contrast.  
Press **OK**.

## Supplied CD-ROMs for 'SP 1200S'

### Drivers and Utilities for SP 1200S



#### Install Multi-Function Suite

You can install the Multi-Function Suite software and multifunction drivers.



#### Repair Multi-Function Suite (For USB users only)

If an error occurred during the installation of the **Multi-Function Suite**, use this selection to automatically repair and re-install the **Multi-Function Suite**.



#### Note

*Install Multi-Function Suite includes the Printer Driver, Scanner Driver, ControlCenter3.*

### PaperPort™ 11SE and Documentation for SP 1200S

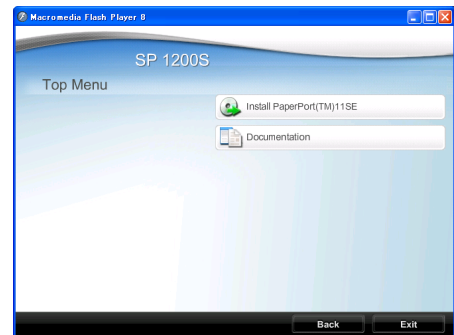

#### Install Paperport™ 11SE

You can install ScanSoft PaperPort 11SE. ScanSoft™ PaperPort™ 11SE. ScanSoft™ PaperPort™ 11SE is a document management application for scanning and viewing documents.



#### Documentation

You can view the manuals for SP 1200S in PDF format.

The Quick Setup Guide, the User Guide and the Software User's Guide. The Software User's Guide includes instructions for features available when connected to a computer. (eg. printing, scanning details)

To save those manuals into your Computer, Click **Install documentation**.

**For USB Interface Cable Users (For Windows® 2000 Professional/XP/7/  
XP Professional x64 Edition/Windows Vista®)**

**Installing TYPE 1200S Drivers and Utilities ..... 18**

**Installing ScanSoft™ PaperPort™ 11SE for Windows® ..... 20**

**View and Installing the documentation ..... 21**

The screens for Windows® in this Quick Setup Guide are based on Windows® XP.

For USB Interface Cable Users (For Windows® 2000 Professional/XP/7/XP Professional x64 Edition/Windows Vista®)

## Installing TYPE 1200S Drivers and Utilities

### Important

Make sure that you have finished the instructions from step 1 *Installing the Driver & Software* on pages 12 through 15.

### Note

- Please close any applications running before installing the Multi-Function Suite.
- Please update to the latest Windows® Service Pack before installing Multi-Function Suite.
- Be sure to use the CD-ROM titled "Drivers and Utilities for SP 1200S"

- 1 Turn off and unplug the machine from the AC outlet and disconnect it from your computer, if you already connected an interface cable.

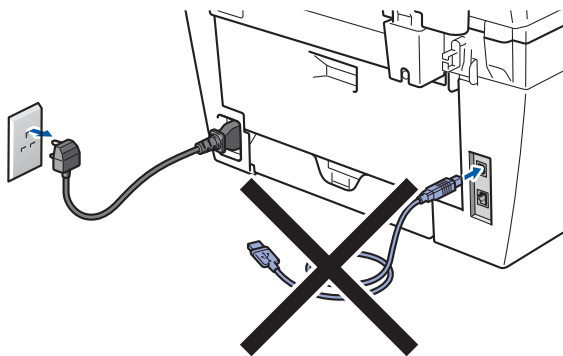

- 2 Turn on your computer. (You must be logged on with administrator rights.)

- 3 Put the supplied CD-ROM for Windows® into your CD-ROM drive. If the model name screen appears, choose your machine. If the language screen appears, choose your language.

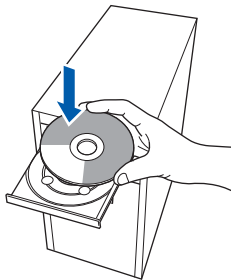

- 4 The CD-ROM main menu will appear. Click **Install Multi-Function Suite**.

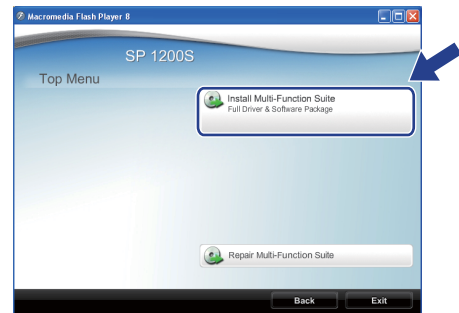

### Note

- If this window does not appear, use Windows® Explorer to run the **start.exe** program from the root folder of the CD-ROM.
- For Windows Vista®, when the User Account Control screen appears, click **Allow**.

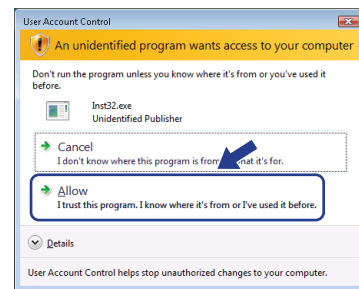

- For Windows® 7, when the **User Account Control Dialog box** appears on your computer, click **YES**.

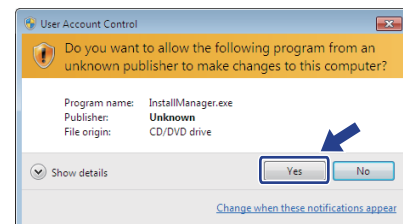

# Installing the Driver & Software

- 5** When the Multi-Function Suite Software License Agreement window appears, click **Yes** if you agree to the Software License Agreement.

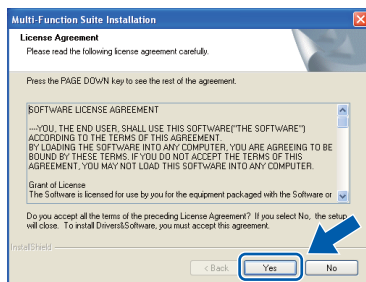

- 6** Choose **Standard** and then click **Next**. The installation will continue.

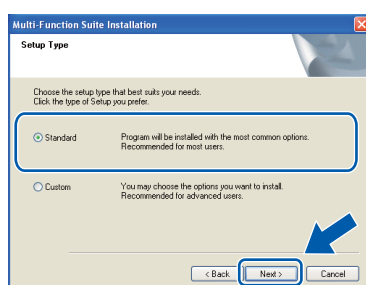

- 7** When this screen appears, connect the USB interface cable to your PC, and then connect it to the machine.

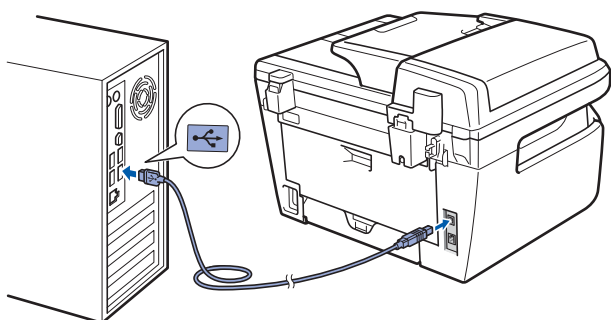
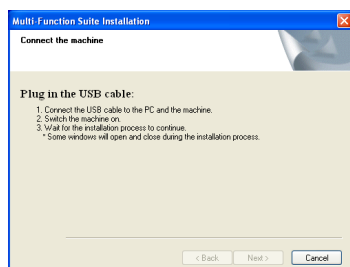

- 8** Plug the AC power cord into an AC outlet. Turn the power switch on.

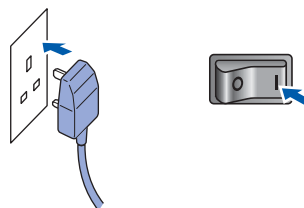

The installation of the drivers will automatically start. **The installation screens appear one after another, please wait for a while.**

## Improper Setup

**DO NOT** try to cancel any of the screens during this installation.

- 9** Click **Finish** to restart your computer. (After restarting the computer, you must be logged on with Administrator rights.)

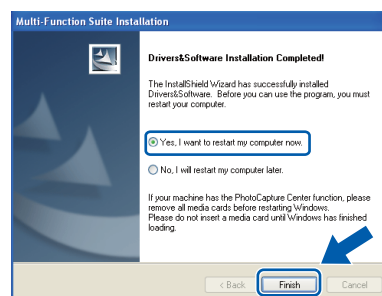

## Note

*After restarting the computer, the **Installation Diagnostics** will run automatically. If the installation is unsuccessful, the installation results window will be shown. If the **Installation Diagnostics** shows a failure, please follow the on-screen instruction.*

## Improper Setup

**DO NOT** connect the machine to a USB port on a keyboard or a non-powered USB hub. We recommend that you connect the machine directly to your computer.



**The Multi-Function Suite (including printer driver and scanner driver) has been installed and the installation is now complete.**

## Installing ScanSoft™ PaperPort™ 11SE for Windows®

### Important

Make sure that you have finished the instructions for installing TYPE 1200S Drivers and Utilities on pages 18 through 19.

### Note

Be sure to use the CD-ROM titled "PaperPort™ 11SE and Documentation for SP 1200S"

- Put the supplied CD-ROM for Windows® into your CD-ROM drive. If the model name screen appears, choose your machine. If the language screen appears, choose your language.

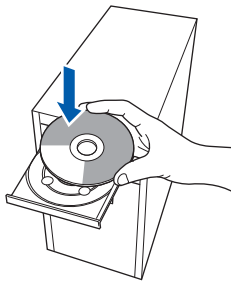

- The CD-ROM Top menu will appear. Click Install Paperport(TM) 11SE.

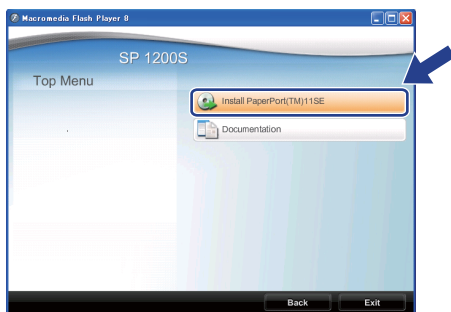

### Note

- If this window does not appear, use Windows® Explorer to run the **start.exe** program from the root folder of the CD-ROM.
- For Windows Vista®, when the User Account Control screen appears, click **Allow**.

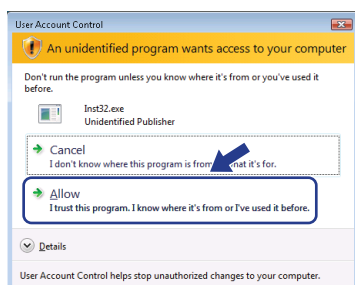

- For Windows® 7, when the **User Account Control Dialog** box appears on your computer, click **YES**.

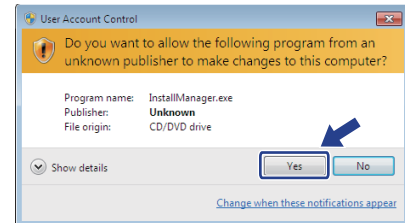

- After reading and accepting the ScanSoft™ PaperPort™ 11SE License Agreement, click **Yes**.

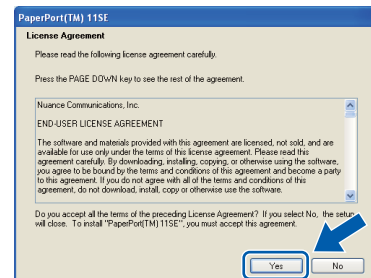

The installation of ScanSoft™ PaperPort™ 11SE will automatically start and finish.

# Installing the Driver & Software

## View and Installing the documentation

### Important

Make sure that you have finished the instructions for installing TYPE 1200S Drivers and Utilities on pages 18 through 19.

### Note

Be sure to use the CD-ROM titled "PaperPort™ 11SE and Documentation for SP 1200S"

- 1 Put the supplied CD-ROM for Windows® into your CD-ROM drive. If the model name screen appears, choose your machine. If the language screen appears, choose your language.

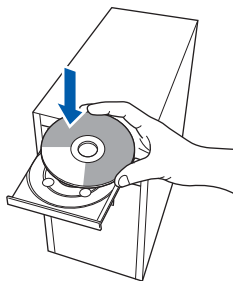

- 2 The CD-ROM Top menu will appear. Click Documentation.
- 3 You can view the manuals for SP 1200S in PDF format. The Quick Setup Guide, the User Guide and the Software User's Guide. The Software User's Guide includes instructions for features available when connected to a computer. (eg. printing, scanning details) To save those manuals into your Computer, Click **Install documentation**.



### Note

- If this window does not appear, use Windows® Explorer to run the **start.exe** program from the root folder of the CD-ROM.
- For Windows Vista®, when the User Account Control screen appears, click **Allow**.

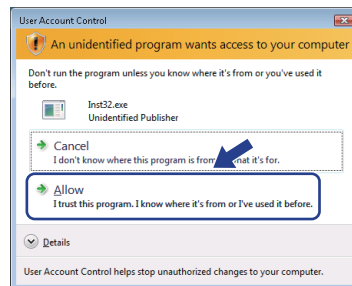

- For Windows® 7, when the **User Account Control Dialog box** appears on your computer, click **YES**.

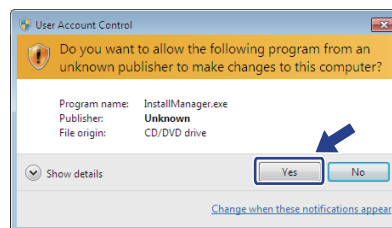

## Consumables

When the time comes to replace consumable items, an error message will be indicated on the LCD. For more information about the consumables for your printer, contact your sales or service representative.

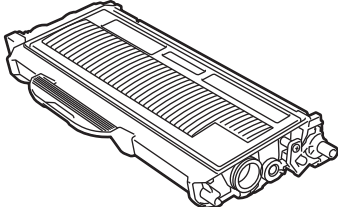
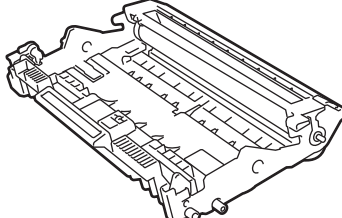
<b>Toner Cartridge</b>	<b>Drum Unit</b>
<b>Print Cartridge SP 1200E</b> (for Europe) <b>Print Cartridge SP 1200S</b> (for Asia)	<b>Drum Unit SP 1200</b> (Approx. 12,000 pages A4/Letter pages)
	

<sup>1</sup> Approx. cartridge yield is declared in accordance with ISO/IEC 19752.



## **Trademarks**

**All brand and product names mentioned in this manual are registered trademarks of their respective companies.**  
Copyright © 2011 Ricoh Co., Ltd. All Rights Reserved.



## Free Manuals Download Website

<http://myh66.com>

<http://usermanuals.us>

<http://www.somanuals.com>

<http://www.4manuals.cc>

<http://www.manual-lib.com>

<http://www.404manual.com>

<http://www.luxmanual.com>

<http://aubethermostatmanual.com>

Golf course search by state

<http://golfingnear.com>

Email search by domain

<http://emailbydomain.com>

Auto manuals search

<http://auto.somanuals.com>

TV manuals search

<http://tv.somanuals.com>