

LASER MFP SP 1000S



Operating Instructions

Read this manual carefully before you use this machine and keep it handy for future reference.
For safe and correct use, be sure to read the Safety Information in this manual before using the machine.

Contents

Security	1	<i>Luminosity setup</i>	16
Security directives	1	<i>Paper type setup</i>	16
Laser safety	1	<i>Paper tray selection</i>	16
<i>For Europe/Asia</i>	1	<i>Flat-bed analysis margins setup</i>	17
<i>For North America</i>	2	<i>Left and right printing margins setup</i>	17
Declaration of conformity	2	<i>Top and bottom printing margins setup</i>	17
<i>Notice to Users in EEA Countries</i>	2	<i>Format paper setup</i>	17
Symbols for the main power switch	2	Parameters/Setup	18
Positions of Warning and Caution labels on the machine	2	Language	18
Environment	4	Technical Parameters	18
Batteries and rechargeable batteries	4	Printing the functions guide	19
The product	4	Print the list of setups	19
<i>Users in the EU, Switzerland and Norway</i>	4	Lock the machine	19
<i>All Other Users</i>	4	<i>Lock the keyboard</i>	19
Software use license	5	Read the counters	19
<i>Definition</i>	5	<i>Scanned pages counter</i>	19
<i>License</i>	5	<i>Printed pages counter</i>	19
<i>Property</i>	5	Display the consumables status	19
<i>Duration</i>	5	Calibrate your scanner	19
<i>Warranty</i>	5	USB memory key	20
<i>Responsibility</i>	5	Use of the USB memory key	20
<i>Development</i>	5	<i>Print your documents</i>	20
Registered trademarks	6	Print the list of files located in the key	20
Notice	6	Print the files located in the key	20
Installation	7	<i>Delete your files located in the key</i>	20
Location conditions	7	Analyse the USB memory key content	21
<i>Cautions of use</i>	7	Save a document on a USB memory key	21
Safety information	8	PC Features	22
<i>Safety During Operation</i>	8	Introduction	22
<i>Power Supply</i>	9	Configuration requirements	22
Rules for use symbols	9	Installation	22
Terminal description	10	<i>Install the software on your PC</i>	22
Command panel	11	<i>Connections</i>	24
<i>Presentation</i>	11	USB Connection	24
<i>Accessing terminal functions</i>	11	<i>Uninstall the software from your PC</i>	24
Packaging contents	12	Multifunction Terminal's Supervision	25
Device installation	12	<i>Checking the connection between the PC and the multifunction machine</i>	25
Loading paper	12	MF Director	25
<i>Loading paper in the paper tray</i>	12	<i>Graphical presentation</i>	25
Handling of paper	12	<i>Utilities and applications activation</i>	25
<i>Humidity control</i>	12	MF Monitor	26
Handling the unit	12	<i>Graphical presentation</i>	26
<i>Operator shocks</i>	12	<i>Display the consumable status</i>	26
<i>Moving the unit</i>	12	<i>Scan To</i>	26
<i>Handling the Toner Cartridge</i>	12	Companion Suite Pro LL functionalities	26
Feed cassette paper insertion	13	<i>Document analysis</i>	26
Cartridge installation	13	Analysis with Scan To	26
Paper delivery stop	14	Analysis from a TWAIN compatible software	27
Starting your device	14	Character recognition software (OCR)	27
<i>Device connection</i>	14	<i>Printing</i>	27
Paper insertion in the manual input tray	14	Printing with the multifunction machine	27
Copy	15	Maintenance	28
Simple copy	15	Service	28
Sophisticated copy	15	<i>General information</i>	28
Special setup for the copy	15	<i>Toner cartridge replacement</i>	28
<i>Resolution setup</i>	15	<i>Issues with smart cards</i>	29
<i>Zoom setup</i>	16	Cleaning	29
<i>Analysis origin setup</i>	16	<i>Scanner reading system cleaning</i>	29
<i>Contrast setup</i>	16	Printer cleaning	29
		<i>Printer external cleaning</i>	29
		Printer issues	29
		<i>Error messages</i>	29

Paper jam	30
Miscellaneous issues	30
Specifications	31
<i>Physical specifications</i>	31
<i>Electrical specifications</i>	31
<i>Environmental specifications</i>	31
<i>Peripheral specifications</i>	31

Security

Security directives

Before turning on your device, check that the outlet that you are going to plug it into conforms to the indications shown on the information plate (voltage, current, power network frequency) located on your device. This device shall be connected to a single phase power network. The device shall not be installed on bare ground.

Batteries and rechargeable batteries, packaging and electric and electronic equipment (EEE), shall be thrown away, as specified by the Instructions of the ENVIRONMENT chapter of this manual.

Because of the device model, the power connector is the only way to disconnecting the device from the power network, that is why it is imperative to apply the following safety measures: your device shall be connected to a power outlet located nearby. The outlet shall be easily accessible.

Your device is delivered with a grounded power cord. It is imperative to connect a grounded connector to a grounded outlet connected to the building earthing.



Repairs-maintenance: Repairs and maintenance should only be carried out by a qualified technician. No user serviceable parts inside the machine. To reduce the risk of electrical shock, you shall not proceed with these operations yourself, because by opening or removing the lids, you could expose yourself to two hazards:

- The laser beam can cause irreversible eye damage.
- Avoid contact with powered parts because it can lead to electrical shock with unfortunate consequences.

For installation conditions and safe use precautions, refer to chapter **Installation**, page 7.

Laser safety



CAUTION *Use of controls or adjustments or performance of procedures other than those specified in the Operating Instructions might result in hazardous radiation exposure.*

For Europe/Asia

This machine is considered a class 1 laser device, safe for office/EDP use. The machine contains 1 class 3B laser diode, 10.72 milliwatt, 760-780 nanometer wavelength for each emitter.

Direct (or indirect reflected) eye contact with the laser beam might cause serious eye damage. Safety precautions and interlock mechanisms have been designed to prevent any possible laser beam exposure to the operator.

The following label is attached on the rear side of the machine.



For North America

CDRH Regulations.

This equipment complies with requirements of 21 CFR subchapter J for class 1 laser products. This equipment contains 1 class 3B laser diode, 10.72 milliwatt, 760-780 nanometer wavelength for each emitter.

This equipment does not emit hazardous light, since the beam is totally enclosed during all customer modes of operation and maintenance.

Declaration of conformity





Notice to Users in EEA Countries

This product complies with the essential requirements and provisions of Directive 1999/5/EC of the European Parliament and of the Council of 9 March 1999 on radio equipment and telecommunications terminal equipment and the mutual recognition of their conformity.

Symbols for the main power switch

In accordance with IEC 60417, this machine uses the following symbols for the main power switch:

-  means POWER ON.
-  means POWER OFF.

Positions of Warning and Caution labels on the machine

This machine has labels for  **WARNING** and  **CAUTION** at the positions shown below. For safety, please follow the instructions and handle the machine as indicated.

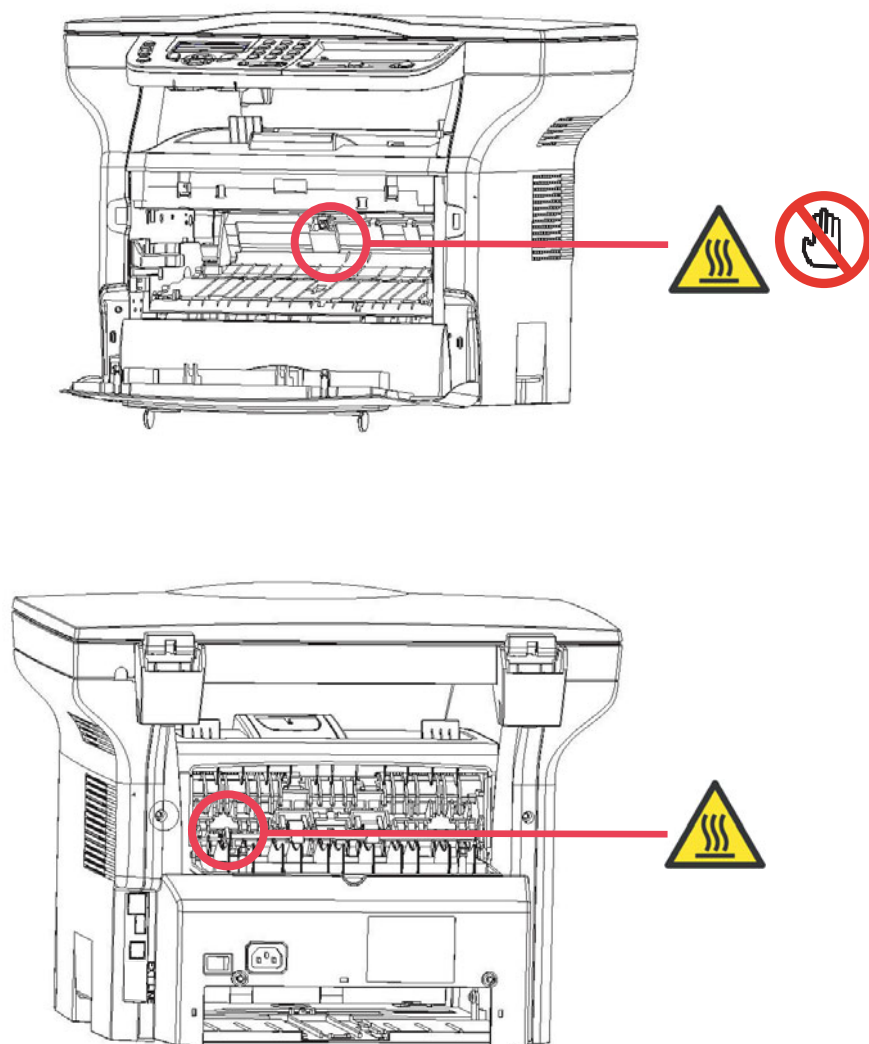

	
CAUTION	Hot surface avoid contact
ATTENTION	Surface chaude Évitez tout contact
ACHTUNG	Heiße Oberfläche Kontakt vermeiden
ATTENZIONE	Superficie calda Evitare il contatto
PRECAUCIÓN	No tocar. Zona muy caliente.
VOORZICHTIG	Heet oppervlak vermijd contact
FÖRSIKTIGT	Het yta. Rör ej.
FORSIGTIG	Varm overflade, undgå berøring
FORSIKTIG	Varm overflate, unngå kontakt
OSTRZEŻENIE	Gorąca powierzchnia nie dotykać
CUIDADO	Superficie quente Evitar contacto
POZOR	Horký povrch nedotýkat se
FIGYELEM	Ne érintse meg a forró felületeket!
TÄRKEÄÄ	Kuuma pinta älä koske.
ОСТОРОЖНО	Горячая поверхность Избегайте контакта
注意	表面高温, 请勿接触。
注意	表面高温請勿碰觸
고온주의	표면이 뜨거우므로 만지지 않도록 주의하십시오.
注意	表面が熱くなっていますので触らないでください。

 **CAUTION** Changes or modifications not expressly approved by the party responsible for compliance could void the user's authority to operate the equipment.

Environment

The preservation of the environment is of importance to the manufacturer. The manufacturer wishes to service the installations with respect to the environment and has chosen to integrate the environmental performance in the whole lifecycle of its products, throughout manufacturing, release, use and disposal.

Batteries and rechargeable batteries

If your product contains batteries or rechargeable batteries, these shall be disposed of at the designated collecting centers.

The product

Users in the EU, Switzerland and Norway

Our Products contain high quality components and are designed to facilitate recycling.

Our products or product packaging are marked with the symbol below.



The symbol indicates that the product must not be treated as municipal waste. It must be disposed of separately via the appropriate return and collection systems available. By following these instructions you ensure that this product is treated correctly and help to reduce potential impacts on the environment and human health, which could otherwise result from inappropriate handling. Recycling of products helps to conserve natural resources and protect the environment.

For more detailed information on collection and recycling systems for this product, please contact the shop where you purchased it, your local dealer or sales/service representatives.

All Other Users

If you wish to discard this product, please contact your local authorities, the shop where you bought this product, your local dealer or sales/service representatives.

Software use license

CAREFULLY READ ALL THE TERMS AND CONDITIONS OF THE PRESENT LICENSE BEFORE OPENING THE SEALED ENVELOPE CONTAINING THE SOFTWARE. OPENING THIS ENVELOPE INDICATES THAT YOU ACCEPT THESE TERMS AND CONDITIONS.

In case you should not accept the terms of this license, the CD-ROM packaging should be returned to the retailer unopened, along with the other components of the product.

Definition

The Software designates programs and associated documentation.

License

- This license allows you to use this Software on personal computers on a local network. You only have permission to use this Software to print on one multifunction machine; you can not lend the Software or authorize anyone to use it.
- You are allowed to make a back up copy.
- This license is non-exclusive and non-transferable.

Property

The manufacturer or its providers hold the Software property right. You only become the owner of the CD-ROM. You shall not modify, adapt, decompile, translate, create any derived piece, rent or sell the Software or the documentation. Any rights not explicitly approved are reserved by the manufacturer or its providers.

Duration

This license remains valid until cancelled. You can cancel it by destroying the program and the documentation as well as any other copies of them. This license will automatically be canceled in case you do not respect the terms of this license. If the license is rendered invalid, you agree to destroy all copies of the program and the associate documentation.

Warranty

The Software is provided "as is" with no warranties what so ever, whether expressed or implied, including without limitation, any warranties of merchantability or fitness for a particular purpose; all the risks concerning the results and performance of this Software are assumed by the buyer. In case the program should appear defective, all the repair and service expenses will be covered by the buyer.

Nevertheless, the license holder benefits from the following warranty: we guarantee that the CD-ROM on which the Software is recorded is free from hardware or manufacturing faults if used in normal conditions, the guarantee is valid for ninety (90) days from the delivery date, the copy of the receipt being the proof of purchase. In case of a CD-ROM fault that due to accident or misuse, the CD-ROM will not be replaced as per the warranty.

Responsibility

If the CD-ROM is not working properly, send it to the retailer together with a copy of the receipt. It is the retailer's sole responsibility to replace the CD-ROM. Nobody, not even the manufacturer who is involved in the creation, realization, merchantability and delivery of this program would be responsible for direct, indirect or immaterial damages, such as, but not limited to, loss of information, loss of time, execution loss, loss of revenue, loss of customers, due to the use or inability to use the program.

Development

With a constant concern for improvement, the manufacturer reserves the right to modify the Software specifications without any notice. In case of modification, your user right does not give you access to free updates.

Registered trademarks

Companion Suite Pro is a registered trademark of Sagem Communication.

Adobe® and the Adobe® products referred to here are registered trademarks of Adobe Systems Incorporated.

PaperPort9SE is a registered trademark of ScanSoft.

Microsoft® Windows® 98, Microsoft® Windows® Millennium®, Microsoft® Windows NT®, Microsoft® Windows 2000®, Microsoft® Windows XP®, and any other Microsoft® product referred to here are registered trademarks of Microsoft Corporation registered and/or used in the United States and/or in other countries.

All the other brands or products referred to as examples or in order to give additional information are registered trademarks of their respective owners.

The screenshots presented in this operating instructions have been created with Windows XP. If you use another operating system, the screenshots displayed may be different from the ones presented in this booklet.

Notice

Do not copy or print any item for which reproduction is prohibited by law.

Copying or printing the following items is generally prohibited by local law: bank notes, revenue stamps, bonds, stock certificates, bank drafts, checks, passports, driver's licenses.

The preceding list is meant as a guide only and is not inclusive. We assume no responsibility for its completeness or accuracy.

If you have any questions concerning the legality of copying or printing certain items, consult with your legal advisor.

Installation

Location conditions

By choosing an appropriate location, you preserve the longevity of the machine. Check that the selected location has the following characteristics:

- Choose a well ventilated location.
- Make sure not to obstruct the ventilation grids located on the left and right sides of the device. During the installation, make sure to place the machine thirty centimeters away from the surrounding objects so all the lids can be easily opened.
- Make sure that this location does not present any ammonia nor any other organic gasses emission hazard.
- The ground outlet (refer to the security notices presented in the **Security** chapter) to which you plan to connect the machine shall be located close to this one and have an easy access.
- **Make sure that the machine is not directly exposed to sun light.**
- Make sure not to place the machine in an area exposed to an air flow generated by an air conditioning, heating or ventilation system, nor in an area subject to big temperature or humidity jumps.
- Choose a solid and horizontal surface on which the machine will not be exposed to intense vibrations.
- **Keep the machine away from any object that could obstruct its ventilation ports.**
- Do not place the machine close to hangings or any other flammable objects.
- Choose a location where the water and other splashes of liquid are limited.
- Make sure that this location is dry, clean and dust free.

Cautions of use

Take into account the important precautions below when using the machine.

Running environment:

- Temperature : 10 °C to 27 °C with an ambient humidity included between 15 to 80% (up to 32°C with an ambient humidity included between 15 to 54%).

Terminal:

The section below describes the precautions to be taken when using the machine:

- Never turn the machine off and never open the lids while printing.
- Never use gas or flammable liquids, or objects generating magnetic field close to the machine.
- When you unplug the power cord, always hold the connector without pulling the cord. A damaged cord presents a potential fire hazard or an electric shock hazard.
- Never touch the power cord with wet hands. You risk getting an electric shock.
- Always unplug the power cord before moving the machine. Otherwise, you could risk having the cord damaged and create a fire hazard or an electric shock hazard.
- Always unplug the power cord when you plan not to use the machine for a long period of time.
- Never put objects on the power cord, never pull it and never fold it. This could cause a fire hazard or an electric shock hazard.
- Always make sure that the machine is not sitting on the power cord or any other electric device communication cables. Make sure also that neither cord nor cable is introduced to the machine inner mechanism. This would expose you to a machine malfunction risk or to a fire hazard.
- Make sure that the printer is unplugged from the power outlet before connecting or disconnecting an interface cable to the printer (use a shielded interface cable).
- Never try to remove any fixed pane or hood. The machine contains high voltage circuits. Any contact with these circuits can cause an electric shock risk.
- Never try to modify the machine. This could cause a fire hazard or an electric shock hazard.
- Always make sure that paper clips, staples or other small metallic items do not get inside the machine via the ventilation ports or other ports. Such items create fire hazards or electric shock hazards.
- Prevent water and any other liquid from spilling on the machine or near to it. Any contact of the machine with water

or liquid can cause a fire hazard or an electric shock hazard.

- If liquid or metallic item gets accidentally inside the machine, turn it off immediately, unplug the power cord and contact your retailer. Otherwise, you would face a fire hazard or an electric shock hazard.
- In case of heat, smoke, unusual smell or abnormal noise emissions, turn the machine off, unplug the power cord immediately and contact your retailer. Otherwise, you would face a fire hazard or an electric shock hazard.
- Avoid using the machine during an "electric storm", this can cause an electric shock hazard due to lightning.

Paper for printing: if you use paper already printed by your machine or another printer, the printing quality may not be optimal.



CAUTION

Make sure to place the machine in well ventilated premises. When operating, the printer generates a small amount of ozone. An unpleasant smell can come from the printer if it is used intensively in not well ventilated premises. For a secure use, make sure you place the machine in well ventilated premises.

Safety information

When using your product, the following safety precautions should always be followed.

Safety During Operation

In this information slip, the following important symbols are used:

WARNING:	Indicates a potentially hazardous situation which, if instructions are not followed, could result in death or serious injury.
CAUTION:	Indicates a potentially hazardous situation which, if instructions are not followed, may result in minor or moderate injury or damage to property.

WARNING

- Connect the power cord directly into a wall outlet and never use an extension cord.
- Disconnect the power plug (by pulling the plug, not the cable) if the power cable or plug becomes frayed or otherwise damaged.
- To avoid hazardous electric shock or laser radiation exposure, do not remove any covers or screws other than those specified in the Operating Instructions.
- Turn off the power and disconnect the power plug (by pulling the plug, not the cable) if any of the following conditions exists:
 - You spill something into the product.
 - You suspect that your product needs service or repair.
 - Your product's cover has been damaged.
- Do not incinerate spilled toner or used toner. Toner dust might ignite when exposed to an open flame.
- Disposal can take place at our authorized dealer or at appropriate collection sites.
- Dispose of the used toner cartridge (or bottle) in accordance with the local regulation.

CAUTION

- Protect the product from dampness or wet weather, such as rain, snow, and so on.
- Unplug the power cord from the wall outlet before you move the product. While moving the product, you should take care that the power cord will not be damaged under the product.
- When you disconnect the power plug from the wall outlet, always pull the plug (not the cable).
- Do not allow paper clips, staples, or other small metallic objects to fall inside the product.
- Keep toner (used or unused), toner cartridge (or bottle), ink (used or unused) or ink cartridge out of reach of children.

- Be careful not to cut yourself on any sharp edges when you reach inside the product to remove misfed sheets of paper or masters.
- For environmental reasons, do not dispose of the product or expended supply wastes at household waste collection point. Disposal can take place at our authorized dealer or at appropriate collection sites.
- Our products are engineered to meet the high standards of quality and functionality, and we recommend that you only use the expendable supplies available at an authorized dealer.

Power Supply

The socket-outlet shall be installed near the product and shall be easily accessible.

Rules for use symbols



WARNING

Indicates important safety notes.

Ignoring these notes could result in serious injury or death. Be sure to read these notes. They can be found in the "Safety Information" section of this manual.



CAUTION

Indicates important safety notes.

Ignoring these notes could result in moderate or minor injury, or damage to the machine or to property. Be sure to read these notes. They can be found in the "Safety Information" section of this manual.



Important

Indicates points to pay attention to when using the machine, and explanations

of likely causes of paper misfeeds, damage to originals, or loss of data. Be sure to read these explanations.



Note

Indicates supplementary explanations of the machine's functions, and instructions on resolving user errors.

Terminal description

Front side

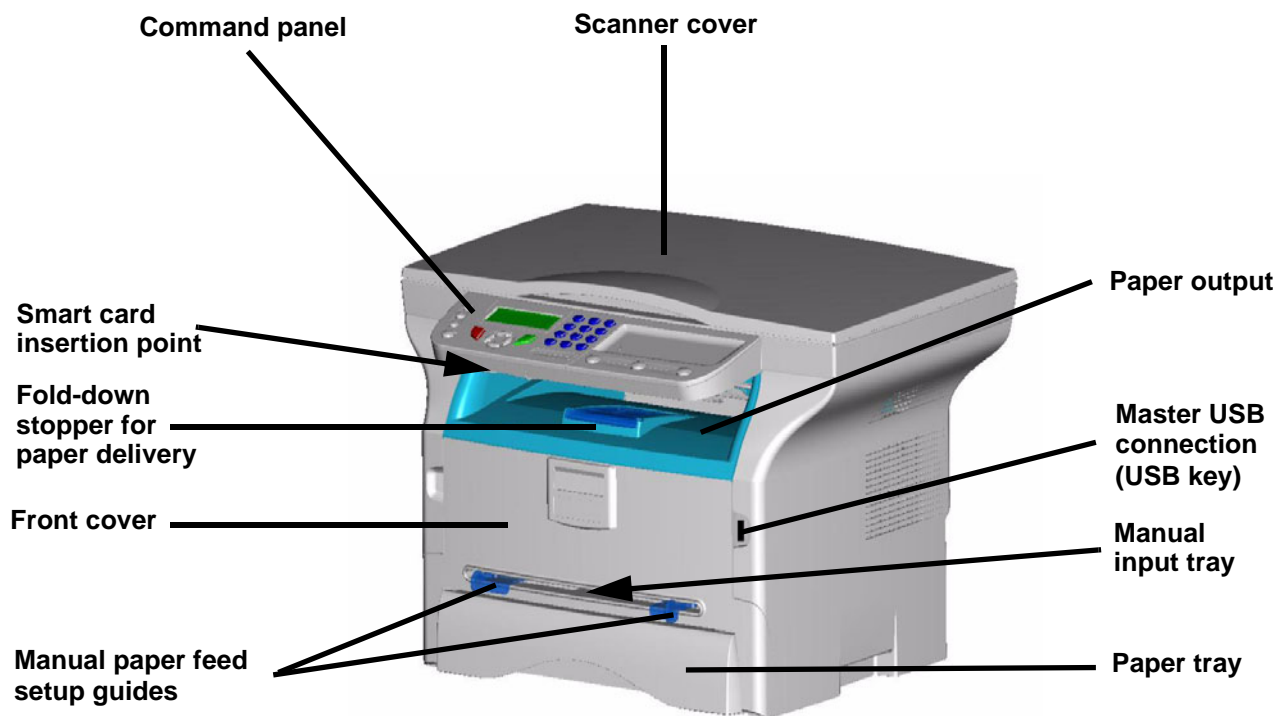

Back side



Command panel

Presentation

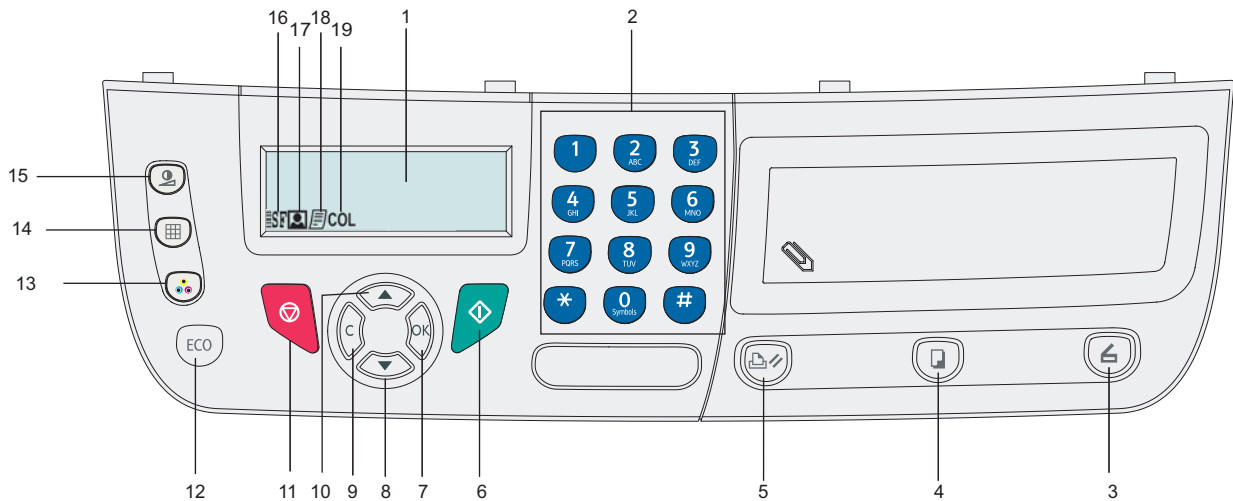

1. Screen.
2. Alphanumerical keypad.
3. Button : document analysis to the PC.
4. Button : local copy.
5. Button : stops the current PC printing.
6. Button : Validation.
7. Button **OK**: confirms the displayed selection.
8. Button : menu access and navigation down the menu.
9. Button **C**: back to the previous menu and input correction.
10. Button : navigation up the menus.
11. Button : stops the current operation.
12. Button **ECO**: sets up the activation delay.
13. Button : colour analysis mode selection.
14. Button : analysis resolution setup.
15. Button : contrast setup.
16. Icon : resolution "Copy : **Quality text**".
17. Icon : resolution "**Photo**".
18. Icon : resolution "Copy : **Auto**".
19. Icon **COL** : color mode.

Accessing terminal functions

All terminal functions and settings are available via the menu and are associated to a specific menu command. For example, **CONTRAST** copy settings are identified in the menu with the command **844**.

Two methods are available to access menu items : a step by step method or a shortcut method.

To access the **CONTRAST** settings with the Step by step method :

- 1 Press on to access the menu.
- 2 Use the or buttons to browse the menu and select **8-ADVANCED FCT**. Confirm with **OK**.
- 3 Use the or buttons to browse the **ADVANCED FUNCTIONS** menu and select **84-COPY**. Confirm with **OK**.
- 4 Use the or buttons to browse the **COPY** menu and select **844-CONTRAST**. Confirm with **OK**.

To access the **CONTRAST** settings with the shortcut method :

- 1 Press on to access the menu.
- 1 Enter 844 with the alphanumerical keypad to directly access the **CONTRAST** item.

Packaging contents

The packaging contains the items listed below:

Multifunction device



1 toner cartridge



1 installation guide and 1 PC installation CD ROM



1 Safety Guide, Command Guide (For Europe only)



1 power cord



1 USB cord



Device installation

- 1 Unpack the device.
- 2 Install the device respecting the security notices stated at the beginning of this booklet.
- 3 Remove all stickers from the machine.
- 4 Remove the plastic protection film from the screen.

Loading paper

Loading paper in the paper tray

- (1) Paper to be used must be inserted face down, and abutting the side fence and back fence. Not abutting the paper may cause feed failure, skewing or paper jams.
- (2) Amount of loaded paper must not exceed the loading mark. If the loading mark is exceeded, this may cause feed failure, skewing, or paper jams.
- (3) Adding paper to the pile may cause double feeding, and should be avoided.
- (4) When withdrawing the cassette from the main unit, always hold it with both hands.

Handling of paper

- (1) Curling must be corrected before loading.
- (2) Curls must not exceed 10 mm.
- (3) Care must be taken with storage to prevent feed faults and image defects due to leaving the paper in conditions of high humidity.
Adding paper to the pile, or splitting the pile may cause feeding problems, and must be avoided.

Humidity control

- (1) Paper which has become damp, or paper which has been left unused for a very long time, must not be used.
- (2) After opening the paper, it must be kept in a plastic bag.
- (3) Paper with wavy ends, paper which is creased, paper with crumples, and any other non-normal paper must not be used.

Handling the unit

Operator shocks

During printing, shocks must not be applied to the paper feed cassette, tray, cover, and other parts of the machine.

Moving the unit

When moving the unit on a desk, it must be lifted, and not dragged.

Handling the Toner Cartridge

- (1) Must not be stood on the side, or held upside down.
- (2) Must not be shaken strongly.

Feed cassette paper insertion

Your device accepts a number of formats and types of papers.

Important See chapter Specifications for the various formats and types of paper.

- 1 Remove the paper feed cassette completely.

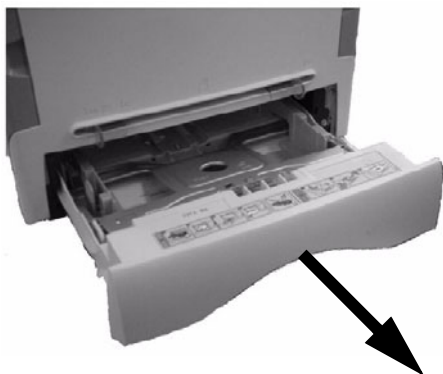

- 2 Push the lower panel down until it clicks.

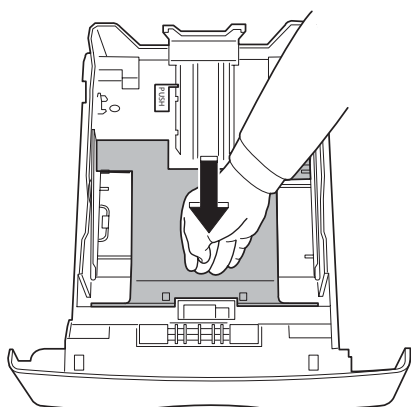

- 3 Setup the back side feed cassette stop by pushing the "PUSH" lever (A). Then adjust the lateral paper guides to the paper format by pushing lever (B) located on the left guide. Adjust the length paper guide to the paper format by pushing lever (C).

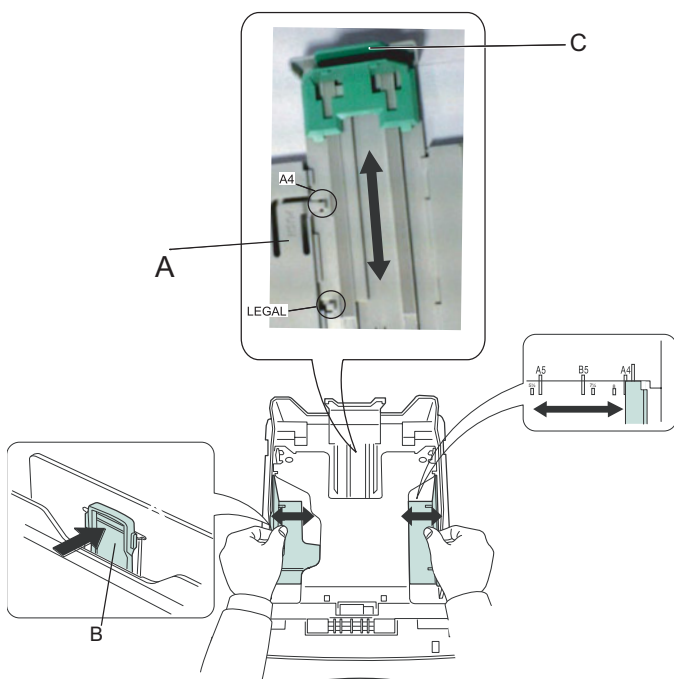

- 4 Take a paper stack, pull the paper off and align it on a flat surface.

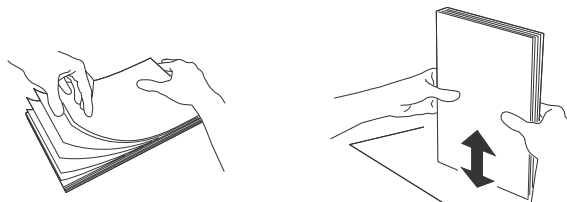

- 5 Put the paper stack in the feed cassette (200 sheets for 80 g/m² paper for instance).
- 6 Put the feed cassette back in its location.

Cartridge installation

- 1 Stand in front of the machine.
- 2 Push the left and right sides of the cover and pull it at the same time towards you.

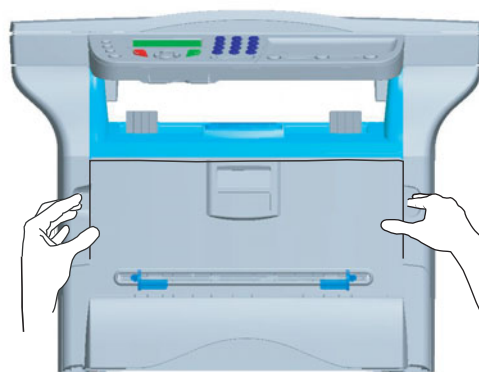

- 3 Remove the starter toner cartridge from its bag. Gently roll the cartridge 5 or 6 times to distribute the toner evenly inside the cartridge. Thoroughly rolling the cartridge will assure the maximum copies per cartridge. Hold it by its handle.

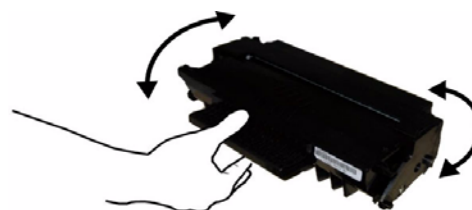

- 4 Insert the cartridge in its slot by pushing it until it clicks (last move down) as shown on the picture below.



- 5 Close the cover.

Paper delivery stop

Adjust the paper delivery stop, depending on the format of the document to be printed. Do not forget to raise the flap to prevent the sheets from falling down.



Starting your device

Device connection



WARNING Before plugging the power cord, it is imperative to refer to the **Security directives**, page 1.

- 1 Connect the power cord to the device.
- 2 Make sure that the On/Off switch is off (O position). Plug the power cord to outlet on the wall.



WARNING The power cord is used as a 230 V power unit cut off. As a precaution, the outlet shall be located close to the device and be of easy access in case of danger.

- 3 Press the On/Off button to turn on the device (I position).
- 4 By default, the machine is set to operate in English. To modify this parameter, refer to **Language**, page 18.

Paper insertion in the manual input tray

The manual input tray allows you to use various paper formats with greater weightings than the one used in the paper feed cassette.

Only one sheet or envelope can be fed at a time.



Important

See chapter Specifications for the various formats and types of paper.

- 1 Spread the manual feed guides to the maximum.

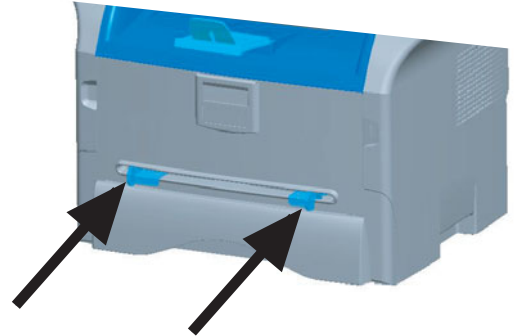

- 2 Insert a sheet or an envelope in the manual input tray.
- 3 Adjust the paper guides against the right and left edges of the sheet or the envelope.
- 4 Print making sure that the chosen paper format corresponds to the selected format on the printer.

Note: When using envelopes

- Feeding can be done only through the manual feed.
- Recommended area should be the area which excludes 15 mm from the leading edge, 10 mm from and both the left and right edges, and the rear edge.
- A few crinkled lines may be given in solid print at the part of being overlapped.
- Envelopes which are not recommended may lead to improper printing.
- Curled envelope after printing should be fixed manually.
- Small crumples on the edge of the wide side of envelopes. Smearing, or less clear printing may appear on the reverse side.
- Set envelope by pressing the folding line of four edges properly after releasing air inside.
- Set envelope in a proper position after aligning in case it is bent or warped.
- Paper conditioning is not allowed. And it should be used under normal office environment.

Copy

Your machine has the function to make one or more copies.

You can also setup several parameters in order to make copies at your will.

Simple copy

In this case, the default parameters are applied.

- 1 Place the document to be copied face down on the glass, respecting the indications around the glass.
- 2 Press the  button twice. The copy is made using the default parameters.

Sophisticated copy

The sophisticated copy allows to do custom setups for the current copy.



Note

You can start copy by pressing



button at any time in below steps.

- 1 Place the document to be copied face down on the glass, respecting the indications around the glass.



Note

After step 1, you can directly enter the number of copies with the alphanumerical keypad and press the OK button to validate. Then refer to step 4.

- 2 Press the  button.
- 3 Enter the number of copies that you want and confirm with the **OK** button.
- 4 Choose the paper tray **AUTOMATIC** or **MANUAL** with the buttons \blacktriangle or \blacktriangledown , then confirm with the **OK** button.
- 5 Choose with the buttons \blacktriangle or \blacktriangledown the printing option (see examples below) depending on the copy mode that you want:
 - Poster mode (flat-bed scanner): **1 Page to 1**, **1 Page to 4** or **1 page to 9**. Confirm with the **OK** button.

Analyzed sheet Output

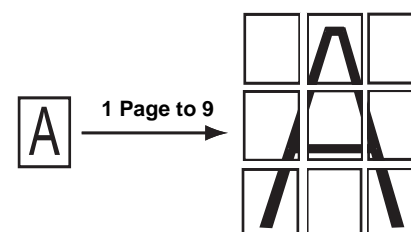
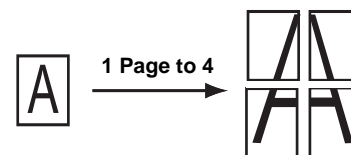
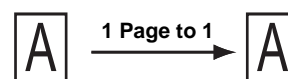

- 6 Adjust the desired zoom level, from **25% TO 400%** with the buttons \blacktriangle or \blacktriangledown , confirm with the **OK** button (only available in **1 Page to 1** copy mode).
- 7 Adjust the desired origin values with the alphanumerical keyboard buttons \blacktriangle or \blacktriangledown then confirm with the **OK** button.
- 8 Choose the resolution depending on the printing quality that you want **DRAFT**, **AUTO**, **QUALITY TEXT** or **PHOTO** with the buttons \blacktriangle or \blacktriangledown , then confirm with the **OK** button.
- 9 Adjust the contrast level with the buttons \blacktriangle or \blacktriangledown , then confirm with the **OK** button.
- 10 Adjust the desired brightness level with the buttons \blacktriangle or \blacktriangledown , then confirm with the **OK** button.
- 11 Choose the paper type **NORMAL**, **THICK** with the buttons \blacktriangle or \blacktriangledown , then confirm with the **OK** button.

Special setup for the copy

Setups done through this menu become the device **default setups** after you confirm.



Important

When the quality of the printing is not satisfying, you can proceed to a calibration with MENU 80.

Resolution setup

The **RESOLUTION** parameter allows you to setup the photocopy resolution.

▼ 841 - ADVANCED FCT/COPY/RESOLUTION

- 1 Choose the resolution with the buttons \blacktriangle or \blacktriangledown according to the following table:

Parameter	Signification
DRAFT	Low resolution.
AUTO	Standard resolution for documents containing text and graphics.
QUALITY TEXT	Optimal resolution for documents containing text.
PHOTO	Optimal resolution for documents containing photographs.



2 Confirm your choice by pressing the **OK** button.



Note

You can also setup the resolution by pressing the  button.

▼ **844 - ADVANCED FCT/COPY/CONTRAST**

- 1 Setup the desired level of contrast with the buttons ▲ and ▼, confirm by pressing the **OK** button.
- 2 You can also directly setup the desired contrast with the  button, press several times on this button until the desired setup without using the Menu 844.
- 3 Quit this menu by pressing the  button.

Luminosity setup

The **LUMINOSITY** parameter allows to lighten or darken your original document.

▼ **845 - ADVANCED FCT/COPY/LUMINOSITY**

- 1 Setup the desired brightness with the buttons ▲ and ▼.
- 2 Confirm your choice by pressing the **OK** button.
- 3 Quit this menu by pressing the  button.

Paper type setup

▼ **851 - ADVANCED FCT/SCAN. & PRINT/PAPER TYPE**

- 1 Select the paper **NORMAL** or **THICK** that you use with the buttons ▲ and ▼.
- 2 Confirm your setup by pressing the **OK** button.
- 3 Quit this menu by pressing the  button.

Paper tray selection

The **Automatic** selection can have two meanings depending on the paper format defined on the paper trays. The following table describes the different cases.

	Default tray	Tray used for copy
Same paper format in the trays	AUTOMATIC	Selection between the main tray and the manual tray.
	MANUAL	The manual tray is used.
Different paper format in the trays	AUTOMATIC	The main tray is used
	MANUAL	The manual tray is used.

▼ **852 - ADVANCED FCT/SCAN. & PRINT/TRAY PAPER**

- 1 Select the default paper tray to use, **AUTOMATIC** or **MANUAL**, with the buttons ▲ and ▼.
- 2 Confirm by pressing the **OK** button.
- 3 Quit this menu by pressing the  button.

Zoom setup

The **ZOOM** parameter allows you to reduce or enlarge an area of a document by choosing the origin and the zoom level to apply to the document, from 25 to 400 %.

▼ **842 - ADVANCED FCT/COPY/ZOOMING**

- 1 Enter the desired zoom level with the Alphanumerical keyboard or choose among predefined values with the buttons ▲ and ▼.
- 2 Confirm your choice by pressing the **OK** button.

Analysis origin setup

If you want, you can change the origin of the scanner.

By entering new values for X and Y in mm (X < 210 and Y < 280), you move the analysed area as shown on the diagram below.

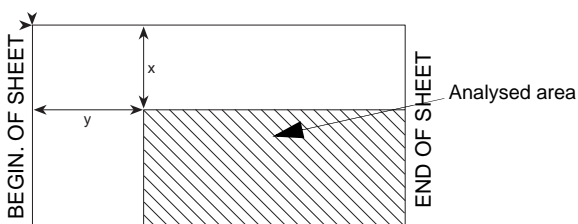

▼ **843 - ADVANCED FCT/COPY/ORIGIN**

- 1 Select the X and Y coordinates with the buttons ▲ or ▼.
- 2 Setup the desired coordinates with the digital keyboard or the buttons ▲ and ▼, confirm your choice by pressing on the **OK** button.

Contrast setup

The **CONTRAST** parameter allows to choose the photocopy contrast.

Flat-bed analysis margins setup

If you want to, you can offset the lateral margins of the document to the left or right during the analysis with your flat-bed scanner.

▼ 853 - ADVANCED FCT/SCAN. & PRINT/ FLATBED MARG

- 1 Setup the left / right margins offsets (by 0.5 mm steps) with the buttons ▲ and ▼ .
- 2 Confirm by pressing the **OK** button.
- 3 Quit this menu by pressing the  button.

- 5 Quit this menu by pressing the  button.

Left and right printing margins setup

If you want to, you can offset the lateral margins of the document to the left or right during printing.

▼ 854 - ADVANCED FCT/SCAN. & PRINT/ PRINTER MARG

- 1 Setup the left / right margins offsets (by 0.5 mm steps) with the buttons ▲ and ▼ .
- 2 Confirm by pressing the **OK** button.
- 3 Quit this menu by pressing the  button.

Top and bottom printing margins setup

If you want to, you can offset the lateral margins of the document towards the top or the bottom during printing.

▼ 855 - ADVANCED FCT/SCAN. & PRINT/ TOP PRINT.

- 1 Setup the top / bottom margins offsets (by 0.5 mm steps) with the buttons ▲ and ▼ .
- 2 Confirm by pressing the **OK** button.
- 3 Quit this menu by pressing the  button.

Format paper setup

This menu allows you to define the default paper format of the manual tray and the main tray. You can also setup the default scanning width.

▼ 856 - ADVANCED FCT/SCAN. & PRINT/ PAPER FORMAT

- 1 Select the paper tray for which you want to define a default paper format with the buttons ▲ and ▼ .
- 2 Confirm by pressing the **OK** button.
- 3 Choose the paper format with the buttons ▲ or ▼ according to the following table:.

Paper tray	Available paper format
MAN. TRAY	A5, A4, Legal and Letter
AUTO. TRAY	A5, A4, Legal and Letter
SCANNER	LTR/LGL and A4

- 4 Confirm by pressing the **OK** button.

Parameters/ Setup

You can setup your machine as you like depending on the use. You will find in this chapter description of the functions.

You can print the functions guide and the available setup of your multifunction machine.

Language

This setting enables you to choose the menu language of your choice. By default, the multifunction machine is set to English.

To select the language:

▼203 - SETUP / GEOGRAPHICAL / LANGUAGE

- 1 Press ▼, enter **203** using the keypad. Confirm with **OK**.
- 2 Select the required language using ▼ and ▲, then press the **OK** button to confirm.
- 3 To exit this menu, press .

Technical Parameters

As delivered your machine is preset by default. However, you may adjust it to meet your requirements by resetting the technical parameters.

To set the technical parameters:

▼29 - SETUP / TECHNICALS

- 1 Select the desired parameter and confirm with **OK**.
- 2 With the buttons ▼ or ▲, modify the parameter settings by following the table below and press **OK**.

Parameter	Signification
8 - Eco energy	Choosing the printer standby delay: the printer will switch to standby after a delay (in minutes) of NON-operation or during the period of time of your choice.
79 - Toner Management	This parameter helps you manage the consumable. When set to WITH [0-10%], you can only replace the toner cartridge when the toner has reached the threshold. If ever you need to replace the toner cartridge before the toner near end, set the parameter to WITH [0-100%] and proceed with the toner cartridge replacement (see chapter Maintenance, page 28). Disabling the toner management (parameter set to WITHOUT) is strongly not recommended as you may spill toner in your print mechanism. When set to WITHOUT , the screen displays TONER ? % .
80 - Toner save	Makes printing lighter to save toner cartridge ink.
93 - Replace format	Page format change. This parameter allows you to print a LETTER format document on A4 pages using the LETTER/A4 setting.

Printing the functions guide



Important

The printing is not possible on A5 paper format.

▼ 51 - PRINT / FUNCTIONS LIST

- 1 Press on ▼ and enter **51** with the alphanumerical keypad. The printing of the functions guide starts.

Print the list of setups



Important

The printing is not possible on A5 paper format.

To print the list of setups:

▼54 - PRINT / SETUP

- 1 Press on ▼, enter **54** with the alphanumerical keypad.
The printing of the list of setups starts.

Lock the machine

This function prevents non-authorized people from accessing the machine. An access code will be required every time someone wants to use the device. After each use, the device will lock automatically.

Before that you have to enter a lock code.

▼811 - ADVANCED FCT / LOCK / LOCKING CODE

- 1 Press on ▼, enter **811** with the alphanumerical keyboard.
- 2 Enter your lock code (4 digits) with the keyboard, confirm with **OK**.



Important

If a code is already registered, enter the old code before typing the new one.

- 3 Enter again your lock code (4 digits) with the keyboard, confirm with **OK**.
- 4 Quit this menu by pressing the  button.

Lock the keyboard

Everytime you use your machine, you will have to enter your code.

▼812 - ADVANCED FCT / LOCK / LOCK KEYBD.

- 1 Press on ▼, enter **812** with the keyboard.
- 2 Enter the lock code and confirm with **OK**.
- 3 With the buttons ▼ or ▲, choose **WITH** and confirm with **OK**.
- 4 Quit this menu by pressing the  button.

Read the counters

This function allows you to view the activity counters for your machine at any time.

According to your needs, you can read the counters for:

- scanned pages,
- printed pages.

Scanned pages counter

To view the number of pages scanned on your machine:

▼823 - ADVANCED FCT / COUNTERS / SCANNED PAGE

- 1 Press on ▼, enter **823** with the keyboard.
- 2 The number of scanned pages appears on the screen.
- 3 Quit this menu by pressing the  button.

Printed pages counter

To view the number of pages printed on your machine:

▼824 - ADVANCED FCT / COUNTERS / PRINTED PG

- 1 Press on ▼, enter **824** with the keyboard.
- 2 The number of printed pages appears on the screen.
- 3 Quit this menu by pressing the  button.

Display the consumables status

You can read at any time the remaining toner in the cartridge. This level appears in percentage.

▼86 - ADVANCED FCT / CONSUMABLES

- 1 Press on ▼, enter **86** with the keyboard.
- 2 The available toner percentage appears on the screen.
- 3 Quit this menu by pressing the  button.

Calibrate your scanner

You can do this operation when the quality of photocopied documents is not satisfactory anymore.

▼80 - ADVANCED FCT / CALIBRATION

- 1 Press on ▼, enter **80** with the keyboard, confirm with **OK**.
- 2 The scanner is triggered and a calibration is done automatically.
- 3 At the end of the calibration, the machine comes back to the screen saver.

USB memory key

You can connect a USB memory Key on the front side of your machine. The files stored in TXT, TIFF and JPEG formats will be analysed and you will be able to use the following actions:

- print the stored files contained in your USB memory key¹,
- delete the files contained in your USB memory key,
- run an analysis on the contents of the inserted USB memory key,
- digitalise a document on your USB memory key,

Use of the USB memory key



Print your documents



Important

The printing is not possible on A5 paper format.

You can print the stored files or a list of the files located in the USB memory key.

Print the list of files located in the key

To print the list of files located in the key:

▼ 01 - MEDIA / PRINT DOC. / LIST

- 1 Insert the USB memory key on the front side of the machine respecting the way of insertion.
- 2 **ANALYSE MEDIA** appears on the screen.
- 3 Select **PRINT DOC.** with the ▼ or ▲ buttons and confirm with **OK**.
- 4 Select **LIST** with the ▼ or ▲ buttons and confirm with **OK**.
- 5 The list is shown in a table with the following information:
 - the analyzed files are indexed in an incremental 1 by 1 order,
 - the files name with their extension,
 - the date of the files last save,
 - the files size in Kbytes.

1. It may be possible that some TIFF files of your USB memory key cannot be printed due to data format limitation.

Print the files located in the key

To print the files located in the key:

▼ 01 - MEDIA / PRINT DOC. / FILE

- 1 Insert the USB memory key on the front side of the machine respecting the way of insertion.
- 2 **ANALYSE MEDIA** appears on the screen.
- 3 Select **PRINT DOC.** with the ▼ or ▲ buttons and confirm with **OK**.
- 4 Select **FILE** with the ▼ or ▲ buttons and confirm with **OK**.
- 5 You have three possibilities to print your files:
 - **ALL**, to print all the files located in the USB memory key.
Select **ALL** with the ▼ or ▲ buttons and confirm with **OK**. The printing is started automatically.
 - **SERIES**, to print several files located in the USB memory key.
Select **SERIES** with the ▼ or ▲ buttons and confirm with **OK**.
FIRST FILE and the first indexed file appears on the screen, select with the ▼ or ▲ buttons the file to print and confirm with **OK**. A star (*) appears on the left side of the file.
LAST FILE appears on the screen, select with the ▼ or ▲ buttons the other files to print and confirm with **OK**.

Press the  button.

- **COPIES NUMBER** appears on the screen, enter the desired number of copies with the alphanumerical keypad and confirm with **OK** to start printing.
- **SELECTION**, to print only one file located in the USB memory key.
Select with the ▼ or ▲ buttons the file to print and confirm with **OK**. **COPIES NUMBER** appears on the screen, enter the desired number of copies with the alphanumerical keypad and confirm with **OK** to start printing.



- 6 Quit this menu by pressing the  button.

Delete your files located in the key

You can delete files located in your USB memory key.

▼ 06 - MEDIA / DELETE / MANUAL

- 1 Insert your USB memory key on the front side of your machine respecting the way of insertion.
- 2 **ANALYSE MEDIA** appears on the screen.
- 3 Select **DELETE** with the ▼ or ▲ buttons and confirm with **OK**.
- 4 Select **MANUAL** with the ▼ or ▲ buttons and confirm with **OK**.

- 5 You have three possibilities to delete your files:
- **ALL**, to delete all the files located in the USB memory key.
Select **ALL** with the ▼ or ▲ buttons and confirm with **OK**.
You come back to the previous menu.
 - **SERIES**, to delete several files located in the USB memory key.
Select **SERIES** with the ▼ or ▲ buttons and confirm with **OK**.
FIRST FILE and the first indexed file appears on the screen, select with the ▼ or ▲ buttons the file to delete and confirm with **OK**. A star (*) appears on the left of the file.
LAST FILE appears on the screen, select with the ▼ or ▲ buttons the other files to delete and confirm with **OK**.
- Press the  button.
- You come back to the previous menu
- **SELECTION**, to delete only one file located in the USB memory key.
Select with the ▼ or ▲ buttons the file to delete and confirm with **OK**.
You come back to the previous menu.
- 6 Quit this menu by pressing the  button.

Analyse the USB memory key content

After a period of inactivity, your machine will return to the main menu. To view the USB memory key again please proceed as follows:

▼ 07 - MEDIA / ANALYSE MEDIA

- 1 Press on ▼, enter **07** with the keyboard.
- 2 The USB memory key analysis is started.
- 3 You can print or delete the detected files located in your USB memory key. Refer to the previous chapters.

Save a document on a USB memory key

This function allows you to digitise and save a document directly in a USB memory key.

- 1 Place the document to be copied face down on the glass.
- 2 Insert the USB memory key in the USB connector of your multifunction device.
The USB memory key analysis is started.
When the analysis is finished, the **MEDIA** menu is displayed.
- 3 Select **SCAN TO** with the ▲ or ▼ buttons then confirm with the **OK** button.

You can also access this function in two other ways:

- by pressing the  button of the machine deck then by selecting **SCAN-TO-MEDIA**.

By pressing the ▼ button from the screen saver then by typing **03** on the alphanumerical keypad.

Important

- 4 Choose the **COLOUR** between **BLACK&WHITE** and **COLOUR** with the ▲ or ▼ buttons and the button **OK**.
- 5 With the alphanumerical keypad, give a name to the scan file (up to 20 characters) and confirm with **OK**.
- 6 Choose the scan format between **IMAGE** and **PDF**, and confirm to start the scan and the recording of the document.
IMAGE allows to have the same kind of file as a photo. **PDF** is a format for the digital documents creation.

The beginning button  immediately starts the scan and sends a file to the support with the parameters defined in the analysis format.

With the **IMAGE** format, if you have selected **BLACK&WHITE** the picture will be saved in **TIFF** format, if you have selected **COLOUR** the picture will be saved in **JPEG** format.

PC Features

Introduction

The Companion Suite Pro software allows the connection of a personal computer with a compatible multifunction machine.

From the PC, you can:

- manage the multifunction machine, allowing you to set it up according to your needs,
- print your documents on the multifunction machine from your usual applications,
- scan colour, grey scale or black and white documents and edit them on your PC, or process them into text using the character recognition software (OCR),

Configuration requirements

The minimum configuration requirements for your personal computer are:

Supported operation systems:

- Windows 98SE,
- Windows Millennium,
- Windows 2000 with at least Service Pack 3,
- Windows XP (Home and Pro).

Processor:

- 500 MHz for Windows 98SE,
- 800 MHz for Windows Me or 2000,
- 1 GHz for Windows XP (Home and Pro),
- CD-ROM drive,
- a free USB port,
- 600 Mbytes of available disk space for the installation.

RAM memory:

- 128 Mbytes minimum for Windows 98SE, Me, and 2000,
- 192 Mbytes minimum for Windows XP (Home and Pro).

Installation

Install the software on your PC

Turn your PC on. Open an ADMINISTRATOR session if working in Windows 2000 and XP environments.

- 1 Open the CD-ROM drive, insert the installation CD-ROM and close the drive.
- 2 An installation procedure is automatically run (Auto run).
- 3 A screen titled COMPANION SUITE PRO LL appears.

This screen allows you to install and uninstall the software, access the product's user guides or browse the CD-ROM contents.

- 4 Place your cursor on INSTALL PRODUCTS and confirm with left-click of the mouse.
- 5 The INSTALL PRODUCTS screen appears. Place your cursor on ALL PRODUCTS and confirm by left-click with the mouse.

The ALL PRODUCTS installation copies on your hard disk the software required for the good execution of the Companion Suite Pro kit, which is:

- Companion Suite Pro (machine management software, printer drivers, scanner, ...),
- PaperPort.



Important

If you already installed a part of the software available in the CD-ROM, then use the CUSTOM installation, select the software that you want to install on your hard drive and confirm your choice.

This Product doesn't have the network and WiFi printer function.

The multifunction machine components only appear if your Windows Installer version is older than 2.0.

The installation resumes, a progress bar appears.

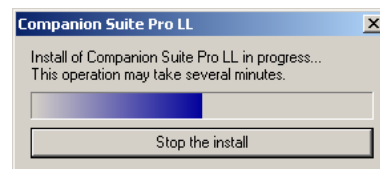

You can stop the program's installation by clicking on the STOP THE INSTALL button.

After search and analysis of the PC components and the multifunction machine's components, you need to restart your PC for the modifications to take effect.

Click on the **OK** button.

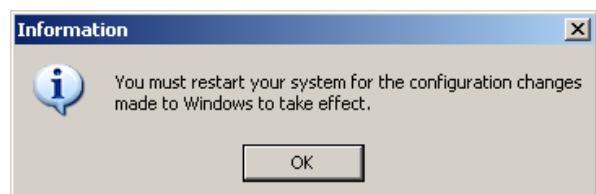

- 6 After restart, the InstallShield Wizard screen shows the progress of the assistant preparation. You can stop the procedure at any time by clicking on the **CANCEL** button.

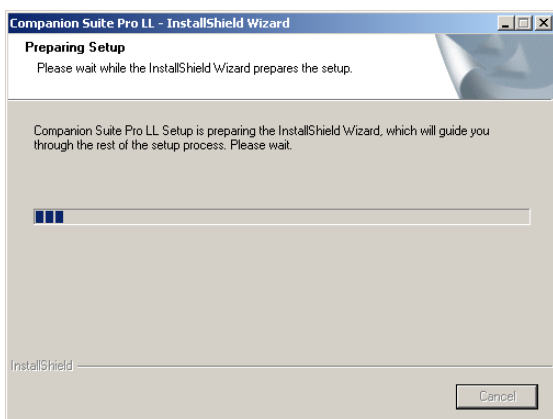

- 7 When the assistant finishes, the welcome screen appears.

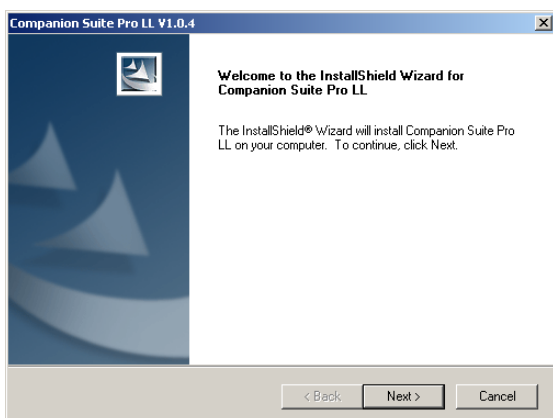

- 8 Click on the **NEXT** button to launch the installation of the COMPANION SUITE PRO kit on your PC.
- 9 Before the files are copied on your hard drive, you need to accept the proposed license agreement, use the scroll bar to read the agreement entirely.

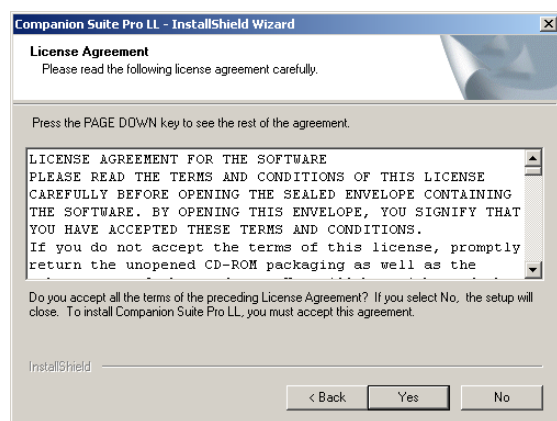

- 10 Click on the **YES** button.
- 11 Click on the **NEXT** button.

- 12 The final installation is ready to be executed.

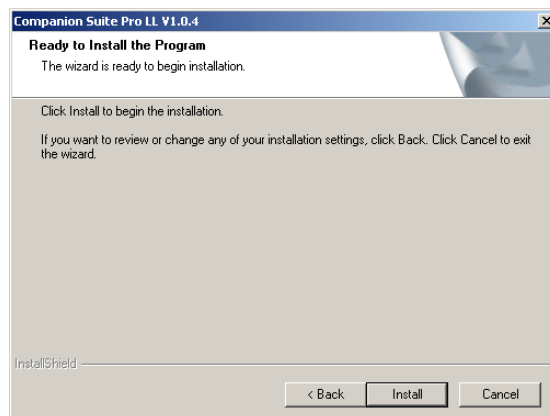

- 13 Click on the **INSTALL** button.

- 14 A screen informs you of the installation progress.

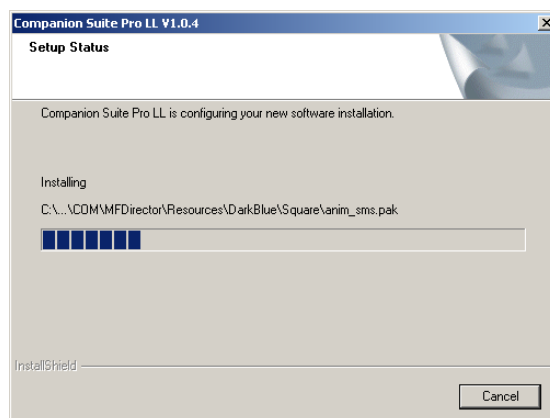

- 15 The Companion Suite Pro software is installed on your PC.

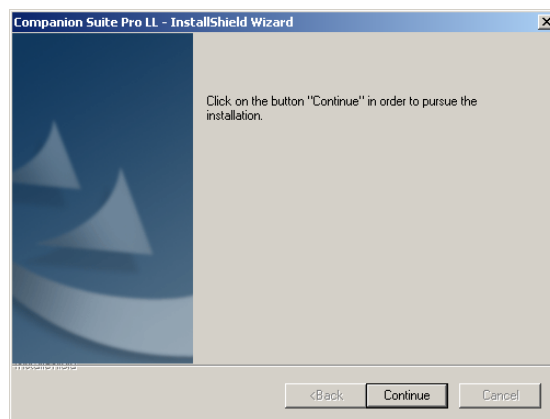

- 16 Click on the **CONTINUE** button to copy the utilities and PaperPort SE software that come along with the kit.

- 17 At the end of the installation, you need to restart your PC to update the system files.

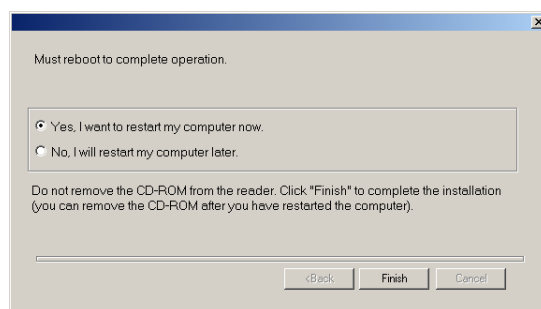

- 18 Select your choice and click on the **FINISH** button.
- 19 Your "Companion Suite Pro" kit is successfully installed on your PC.

You can start the multifunction machine's management software from the menu **START > PROGRAMS > COMPANION SUITE > COMPANION SUITE PRO LL > MF DIRECTOR** or by clicking on the icon **MF DIRECTOR** located on your desktop.

Connections

Make sure that your multifunction machine is powered off.

USB Connection

The connection between the PC and the machine requires a USB 2.0 shielded cable no more than 3 meters long.

It is recommended to install the Companion Suite Pro software first and then to connect the USB cable to your machine.

If you connect the USB cable before installing the Companion Suite Pro software the recognition system (plug and play) identifies automatically that new hardware has been added. To start your machine drivers installation, follow the instructions on screen. If a window asking about the location of the drivers pops up, then indicate the installation CD-ROM. When you use this procedure, only printing function is activated.



Important

- 1 Locate your USB cable connectors and connect as shown below on the picture.



- 2 Power on your multifunction machine. The **ADD HARDWARE** assistant window appears.
- 3 Click on the **NEXT** button to finish the installation.
- 4 Select **FIND THE APPROPRIATE DRIVER FOR MY HARDWARE (RECOMMENDED)**. Click on the **NEXT** button.

- 5 Select the location where the system has to look for the driver. Only the **CD-ROM DRIVES** checkbox has to be selected if Windows asks you where to look for the drivers. Click on the **NEXT** button. The search takes a few moments.
- 6 A window informs you that the driver has been located. Click on the **NEXT** button.
- 7 A screen informs you that the software has been installed. Click on the **FINISH** button.
- 8 If the **ADD HARDWARE** assistant window appears on more time, go back step 3 and follow the instructions. All in all, you will have to follow step 3 through 7 three times. .

You can now use the multifunction machine to print your documents.

Uninstall the software from your PC

Run the programs removal from the menu **START > PROGRAMS > COMPANION SUITE > COMPANION SUITE PRO LL > UNINSTALL**.

- 1 A preparation screen appears.

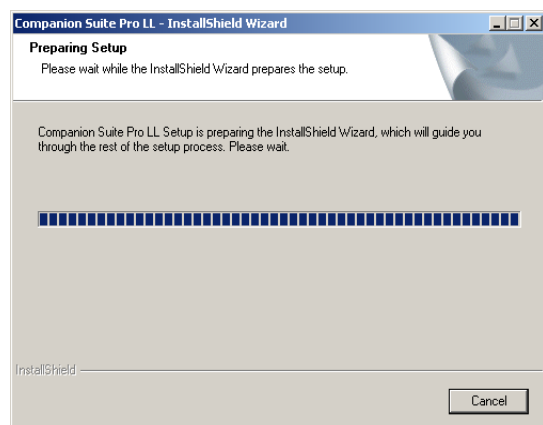

- 2 Click on the **REMOVE** button and confirm your choice by clicking on the **NEXT** button.

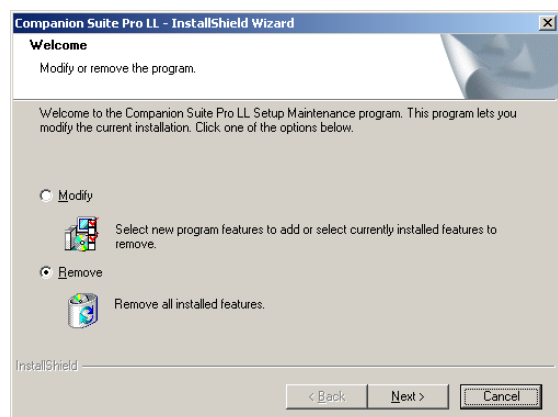

- 3 A confirmation screen appears. Click on **OK** button to continue the **COMPANION SUITE PRO LL** program removal.

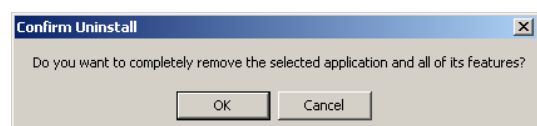

- 4 A preparation screen appears. You can cancel the removal by clicking on **CANCEL**.

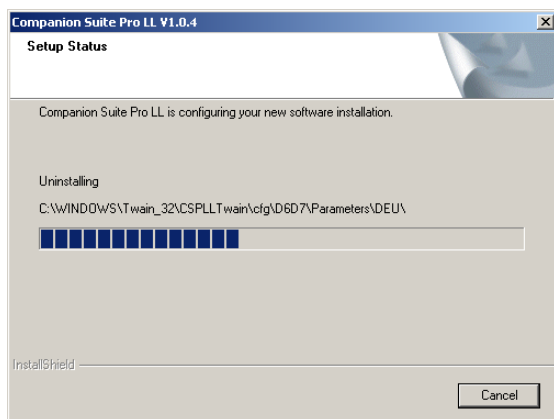

- 5 You need to restart your system at the end of the procedure. Close all open programs, select **YES, I WANT TO RESTART MY COMPUTER NOW** and click on the **FINISH** button.



Multifunction Terminal's Supervision

The software that you have installed contains two multifunction machine management applications, MF DIRECTOR and MF MONITOR, which allow you to:

- check whether the multifunction machine is connected to your PC,
- monitor the multifunction machine activities,
- monitor the status of the multifunction machine consumables from the PC,
- quickly access the graphic editor applications, OCR etc.

To manage the multifunction machine, run the MF Director application by clicking on the icon located on your desktop or from the menu **START > PROGRAMS > COMPANION SUITE > COMPANION SUITE PRO LL > MF DIRECTOR**.

Checking the connection between the PC and the multifunction machine

To check if the connection between the devices is good, run the MF MONITOR software from the icon located on the desktop and check that the same information is displayed on the multifunction machine (for instance the date).

MF Director

This graphical Interface allows you to run the utilities and the software to manage your multifunction machine.

Graphical presentation

Run the application by clicking on the MF Director icon located on your desktop or from the menu **START > PROGRAMS > COMPANION SUITE > COMPANION SUITE PRO LL > MF DIRECTOR**.



By default, MF DIRECTOR is displayed with dark blue rounded shape. You can modify its shape and colour by right-clicking with the mouse.

Utilities and applications activation

The COMPANION SUITE PRO graphical interface allows you to run the following utilities and software:

- get **HELP** from the current documentation,
- run the **PaperPort** software (Doc Manager).

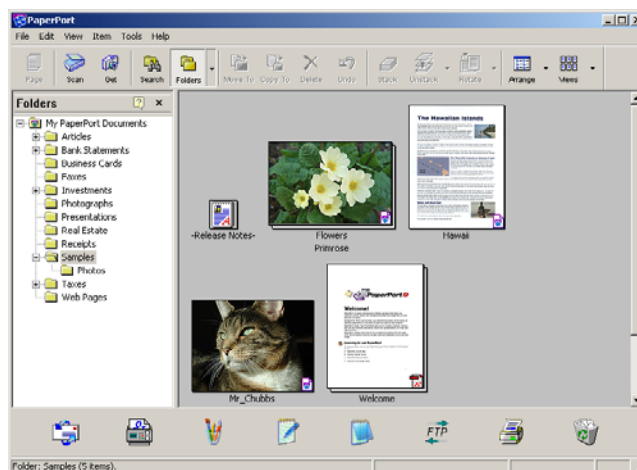

To run a software or utility contained in the COMPANION SUITE PRO kit, place the cursor on it and double-click with the mouse.

MF Monitor

Graphical presentation

Run the application by clicking on the MF Monitor icon located on your desktop or from the menu **START > PROGRAMS > COMPANION SUITE > COMPANION SUITE PRO LL > MF MONITOR**.

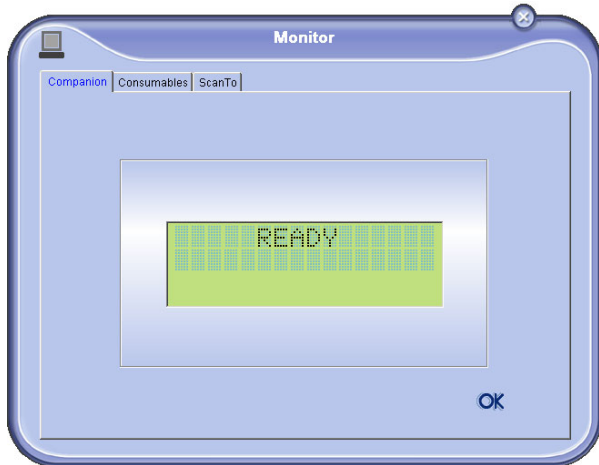

From this screen you can monitor the information or configure your multifunction machine from the tabs:

- **COMPANION:** Presents the multifunction machine screen.
- **CONSUMABLES:** Displays the consumables status.
- **SCAN TO:** Scan Mode and Resolution parameters setup, these parameters will be taken into account when clicking on the (↶) button from the machine.

Display the consumable status

The following information will be available from the Consumables tab:

- current consumables status,
- number of printed pages,
- number of scanned pages.

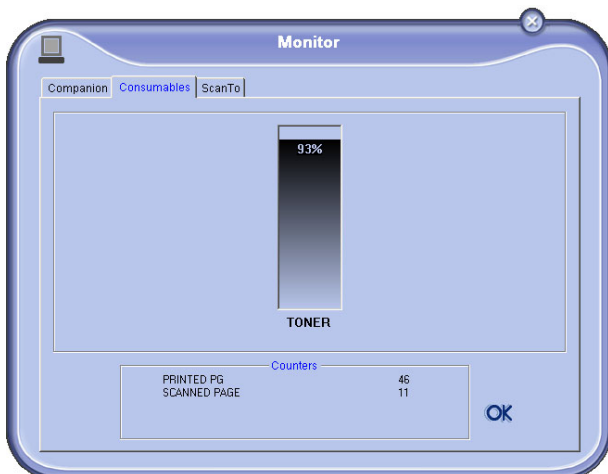

Scan To

The setup of this tab, becomes the default setup for the scanner.



Note

The function **SCAN To** can only be used if the application is running. If this is not the case, activate it.

- 1 Select the Scan To tab.
- 2 Select one of the possible choices:
 - colour,
 - grayscale,
 - black and white.
- 3 Select the scanner resolution (72 dpi to 4800 dpi).
- 4 Confirm your choices by clicking on the **OK** button.

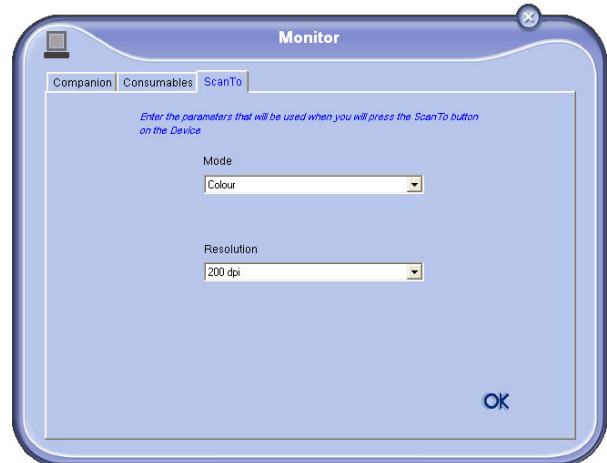

Companion Suite Pro LL functionalities

Document analysis

The document analysis can be carried out in two ways:

- either by the **SCAN TO** function (application accessible from the MF Director window or from the (↶) button from the machine),
- or directly from a TWAIN standard compatible application.

Analysis with Scan To

Run the application by clicking on the MF Director icon located on your desktop or from the menu **START > PROGRAMS > COMPANION SUITE > COMPANION SUITE PRO LL > MF DIRECTOR**.



- 1 Left-click with the mouse on the **SCAN To** graphical image or click the  button from your machine.
- 2 You can follow the ongoing digitisation on a screen.

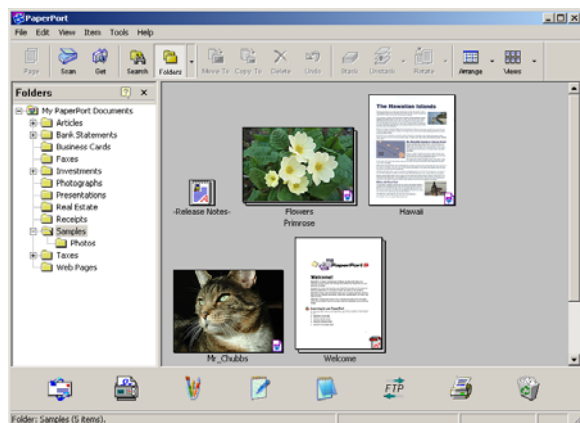

- 3 At the end of the digitisation, the scanned picture appears in the PaperPort window.

**Important**

If the PaperPort software is not installed on your hard drive, the scanned picture will appear on your desktop in TIFF format.

Printing

You can print your documents via the USB connection .

*During the installation of the software, the **LASER PRO LL** printer driver will be installed automatically onto your pc. This will allow you to print your documents on the machine via the USB connection.*

Printing with the multifunction machine

To print a document with the machine from your PC is like printing a document in Windows (use the **PRINT** command from the **FILE** menu of the currently open application on the screen). Select the **LASER PRO LL** printer to print via the USB connection.

**Important**

*The **LASER PRO LL** printer becomes the default printer when the Companion Suite Pro software is installed.*

Analysis from a TWAIN compatible software

- 1 Run the picture editor application and then run the acquisition command.
The document analysis window appears.
- 2 Setup the parameters (contrast, resolution, ...) before starting the digitisation.
- 3 Once the document is digitised, you can archive it or edit it.

Character recognition software (OCR)

The character recognition function allows to create a usable data file for desktop applications from a hardcopy document or from a picture.

The character recognition only works for printed characters, such as printer outputs or typed text. Nevertheless you can request for a handwritten text block to be kept intact (a signature for instance) by outlining it.

Given your machine environment and the character recognition from your machine, the OCR is done with a Drag&drop of a document from the PaperPort to the Notepad icon.

**Important**

For more details about the usage of this software, check the on-line help of the product.

Maintenance

Service

General information



CAUTION

For your safety, it is imperative to refer to the safety information presented in chapter **Security**, page 1.

To ensure that your machine is kept in the best conditions, it is recommended that you periodically clean the inner parts.

Please respect the following rules while using this machine:

- Do not leave the scanner cover open.
- Do not try to lubricate the device.
- Do not close the scanner cover violently or do not apply vibrations to the machine.
- Do not open the cartridge access cover while printing.
- Do not try to disassemble the machine
- Do not use paper which would have stayed in the tray for too long.

Toner cartridge replacement

Three toner cartridge replacement procedures can be used depending on the **TONER MANAGEMENT** setting.

- **TONER MANAGEMENT** setting set to **WITH [0-10%]** : the replacement of the cartridge can be performed only when the message **Toner near end** is displayed. At the end of replacement, validation with the smart card is required.
- **TONER MANAGEMENT** setting set to **WITH [0-100%]** : the replacement of the cartridge can be performed at any time. At the end of replacement, validation with the smart card is required.
- **TONER MANAGEMENT** setting set to **WITHOUT** : the replacement of the cartridge can be performed at any time and no validation with the smart card is necessary. When set to **WITHOUT**, the screen displays **TONER ? %**.

To set the **TONER MANAGEMENT** setting, select **2979 - SETUP / TECHNICALS / TONER MANAGEMENT** and choose the setting.

*This procedure applies when the setting **TONER MANAGEMENT** is set to **WITH [0-10%]**.*



CAUTION

*When set to **With [0-100%]**, follow the procedure from step 2.*

*When set to **WITHOUT**, follow the procedure from step 2 to step 7.*

Your machine comes with a current consumable management system. It tells you if your toner cartridge is close to its end of cycle. The following message will appear on your machine screen.

**TONER NEAR
END**

To quit this screen, press **OK**.

To replace the toner cartridge, proceed as shown below.

When the following message is displayed on the screen:

**TONER EMPTY
REPLACE <OK>**

- 1 Press **OK**.

**OPEN FRONT COVER
REPLACE TONER**

- 2 Stand in front of the device.
- 3 Push on the left and right sides of the cover and pull it towards you.
- 4 Raise and remove the toner cartridge from the machine.
- 5 Unpack the new cartridge.
Gently roll the cartridge 5 or 6 times to distribute the toner evenly inside the cartridge. Thoroughly rolling the cartridge will assure the maximum copies per cartridge.
Insert it into the slot as indicated in the diagram below.



- 6 Close the cover.
The following message appears:

**HAVE YOU CHANGED
THE TONER? <OK>**

- 7 Press **OK**.
- 8 When this message appears,

**INSERT THE
TONER CARD**

insert the smart card provided with the new toner cartridge as shown on the picture below.



9 A wait message appears.

**PLEASE
WAIT**

The smart card is read.

**NEW TONER
REMOVE CARD**

Remove the smart card from the reader, your machine is ready to print again.



CAUTION

*To continue the printing of your documents when the message **TONER NEAR END is displayed, set the TONER MANAGEMENT setting to WITHOUT.***

***Caution:** this procedure is not recommended as disabling toner management (parameter set to **WITHOUT**) can lead to toner being spilled in your print mechanism.*

Issues with smart cards

If you use a smart card that has already been used, the machine will display:

**PLEASE
WAIT**

then,

**REMOVE CARD
ALREADY USED**

If you use a defective smart card, the machine will display:

**PLEASE
WAIT**

then,

**UNKNOWN CARD
REMOVE CARD**

If the **C** button is pressed while the smart card is being read, the machine displays:

**ACTION CANCELLED
REMOVE CARD**

Cleaning

Scanner reading system cleaning

When one or more vertical lines appear on the copies, clean the glass of the scanner.

- 1 Open the scanner cover until it is standing in vertical position.
- 2 Wipe the glass with a soft lint-free cloth soaked with mild alcohol.
- 3 Close the scanner cover.
- 4 Make a copy to check that the symptoms have disappeared.

Printer cleaning

Dust, dirtiness and paper debris on the external and internal surfaces of the printer can affect its operation. We advise that it is cleaned regularly.

Printer external cleaning

Clean the external part of the printer with a soft cloth soaked in mild detergent.

Printer issues

Error messages

When the printer encounters any of the problems described below, the corresponding message is shown on the machine display.

Message	Action
CHECK TONER	Check the presence of a toner cartridge in the machine.
TONER NEAR END	Indicates that your consumable will need changing soon.
REPLACE PAPER	Add paper in tray.
HEATING	Message displayed when starting the machine.
CLOSE COVER PRINTER	The printer front cover is open, close it.
TONER EMPTY REPLACE <OK>	Replace the toner cartridge.
PAPER JAM REMOVE TONER	A sheet of paper is jammed in the machine. Take out the toner cartridge and remove the jammed paper sheet. Take out the paper tray and remove the jammed paper sheet. Then open and close the Front cover.

Message	Action
PAPER JAM EXTERNAL TRAY	A sheet of paper is jammed in the machine. Open the paper jam cover. Remove the jammed paper sheet. Then open and close the Front cover.
PAPER EMPTY	Add paper in the paper tray.



Note

After one of the error messages listed above, it may happen that the printing job is cancelled.

Paper jam

When printing, a sheet of paper may get stuck in the printer or the paper tray and cause a paper jam.

In case of a paper jam in the machine, the following message appears:

**PAPER JAM
EXTERNAL TRAY**

- 1 Open the paper jam cover located at the back of the machine.
- 2 Remove the jammed sheet of paper and close the cover.

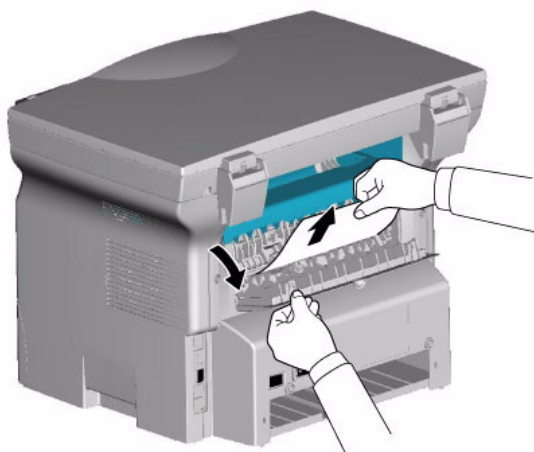

- 3 Open and close the Front cover. The printer starts again automatically.



CAUTION

The fusion unit can reach a very high temperature during the operation. To prevent any harm, do not touch this area.

For details, refer to **Positions of Warning and Caution labels on the machine**, page 2.

In case of paper jam, the following message appears:

**PAPER JAM
REMOVE TONER**

- 1 Remove the toner cartridge and check if a sheet is jammed.
- 2 Remove the sheet of paper which causes the paper jam.
- 3 Put the toner cartridge in the machine, or remove the paper tray and remove the sheet of paper which causes the paper jam.
- 4 Check that the paper sheets in the paper tray are correctly placed.

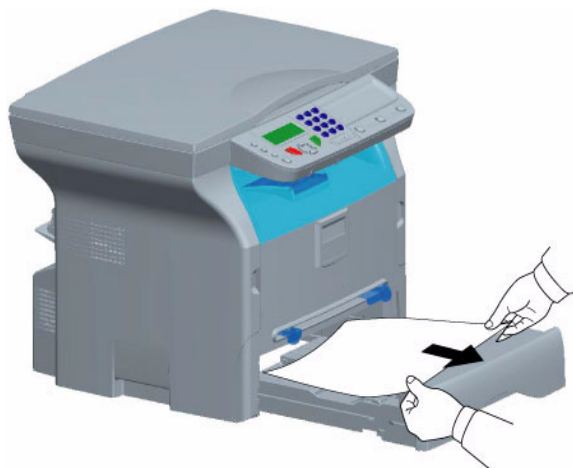

- 5 Replace the paper tray in the machine.

Miscellaneous issues

When turning on the terminal, nothing is displayed on the screen.

Check the connection between the power cord and the outlet.

Specifications

Physical specifications

Dimensions: 344 x 447 x 386 mm
Weight: 11,6 kg

Electrical specifications

Power supply: Single phase 220-240 V - 50/60 Hz - 4.5 A
Electric consumption: 10 W typical in powersave
13 W typical in standby
340 W average during printing (900W peak)

Environmental specifications

Operating temperature: 10 °C to 27 °C with an ambient humidity included between 15 to 80% (up to 32°C with an ambient humidity included between 15 to 54%)

Peripheral specifications

Printer

Type: Laser (on normal paper)
Resolution: 600 dpi
Speed: 16 ppm maximum
Preheating time: 21 sec.
First page out time: 13 sec.

Copier

Type: Autonomous Black and White
Copy speed: 16 ppm maximum
Resolution: 600 dpi
Multiple copies: 99 pages maximum
Zoom range: 25 % to 400 %

Scanner

Type: Color scanner
Color depth: 36 bits
Resolution: 600 dpi (optical)
2400 dpi (interpolated)
Software compatibility: TWAIN
Maximum paper format: Letter

Printing supports

Main paper tray capacity: 250 sheets maximum (60 g/m²), 200 sheets maximum (80 g/m²)
Output tray capacity: 50 sheets
Main tray paper format: A4, A5, Legal, Letter
60 to 105 g/m² paper
Paper format for manual printing: A4, A5, Legal, Letter, B5, exec, A6
52 to 160 g/m² paper

PC connection

Slave USB 2.0 port (PC connection)
Master USB 2.0 port (reader, USB memory key reader)
Operating System: Windows 98 SE, 2000, ME, XP

Specifications are subject to changes for improvement without notice.

B279-8651

Free Manuals Download Website

<http://myh66.com>

<http://usermanuals.us>

<http://www.somanuals.com>

<http://www.4manuals.cc>

<http://www.manual-lib.com>

<http://www.404manual.com>

<http://www.luxmanual.com>

<http://aubethermostatmanual.com>

Golf course search by state

<http://golfingnear.com>

Email search by domain

<http://emailbydomain.com>

Auto manuals search

<http://auto.somanuals.com>

TV manuals search

<http://tv.somanuals.com>