

DDST Unit Type A / Type B

Operating Instructions Printer / Scanner Reference



-
- 1 Getting Started
 - 2 Installing the Software
 - 3 Using the Printer Function
 - 4 Using the TWAIN Scanner Function
 - 5 Troubleshooting
 - 6 Appendix

Read this manual carefully before you use this machine and keep it handy for future reference. For safe and correct use, be sure to read the Safety Information in the "Copy Reference" before using the machine.

Introduction

This manual contains detailed instructions and notes on the operation and use of this machine. For your safety and benefit, read this manual carefully before using the machine. Keep this manual in a handy place for quick reference.

Important

Contents of this manual are subject to change without prior notice. In no event will the company be liable for direct, indirect, special, incidental, or consequential damages as a result of handling or operating the machine.

Do not copy or print any item for which reproduction is prohibited by law.

Copying or printing the following items is generally prohibited by local law:

bank notes, revenue stamps, bonds, stock certificates, bank drafts, checks, passports, driver's licenses.

The preceding list is meant as a guide only and is not inclusive. We assume no responsibility for its completeness or accuracy. If you have any questions concerning the legality of copying or printing certain items, consult with your legal advisor.

Caution:

Use of controls or adjustments or performance of procedures other than those specified in this manual might result in hazardous radiation exposure.

Two kinds of size notation are employed in this manual. With this machine refer to the inch version.

Trademarks

Microsoft®, Windows® and Windows NT® are registered trademarks of Microsoft Corporation in the United States and/or other countries.

Other product names used herein are for identification purposes only and might be trademarks of their respective companies. We disclaim any and all rights to those marks.

The proper names of the Windows operating systems are as follows:

- The product name of Windows® 98 is Microsoft® Windows® 98
- The product name of Windows® Me is Microsoft® Windows® Millennium Edition (Windows Me)
- The product name of Windows® 2000 are as follows:
 - Microsoft® Windows® 2000 Advanced Server
 - Microsoft® Windows® 2000 Server
 - Microsoft® Windows® 2000 Professional
- The product name of Windows® XP are as follows:
 - Microsoft® Windows® XP Professional
 - Microsoft® Windows® XP Home Edition
- The product names of Windows Server™ 2003 are as follows:
 - Microsoft® Windows Server™ 2003 Standard Edition
 - Microsoft® Windows Server™ 2003 Enterprise Edition
 - Microsoft® Windows Server™ 2003 Web Edition

Notes

Some illustrations in this manual might be slightly different from the machine.

Certain options might not be available in some countries. For details, please contact your local dealer.

Depending on which country you are in, your machine may include certain options as standard. For details, please contact your local dealer.

Manuals for This Machine

The following manuals describe the operational procedures of this machine. For particular functions, see the relevant parts of the manual.

Note

- Manuals provided are specific to machine type.
- Adobe Acrobat Reader is necessary to view the manuals as a PDF file.

❖ **General Settings Guide**

Provides an overview of the machine and describes System Settings (paper trays, Key Operator Tools, etc.), and troubleshooting.

❖ **Network Guide**

Describes procedures for configuring the machine and computers in a network environment.

❖ **Copy Reference**

Describes operations, functions, and troubleshooting for the machine's copier function.

❖ **Printer/Scanner Reference (this manual)**

Describes system settings, operations, functions, and troubleshooting for the machine's printer/scanner function.

TABLE OF CONTENTS

Manuals for This Machine	i
How to Read This Manual	1

1. Getting Started

Control Panel	3
Reading the Display and Using Keys	4
Connecting the Machine	5
Requirements	5
Connecting the machine to the host using a USB cable	5

2. Installing the Software

Auto Run	7
Installing the Printer Driver	8
Installing the TWAIN Driver	9
Software Supplied on CD-ROM	10
DDST Driver.....	10
DDST TWAIN Driver	10

3. Using the Printer Function

Printer Features Menu	11
Adjusting Printer Features	12
Printer Features Parameters	13
Paper Input.....	13
List/Test Print	13
Maintenance.....	14
System	16
Host Interface.....	16
Setting Paper on the Bypass Tray	17
Setting the paper size	18
Setting custom size paper.....	19
Setting thick paper or OHP transparencies.....	20
Setting envelopes.....	21
Setting Up the Printer Driver and Canceling a Print Job	23
Windows 98SE / Me - Accessing Printer Properties	23
Windows 2000 / XP and Windows Server 2003 - Accessing Printer Properties	24
Canceling a Print Job	25

4. Using the TWAIN Scanner Function

TWAIN Scanner	27
Preparation for Using the Network TWAIN Scanner	28
TWAIN Scanner Screen	28
Setting Originals	29
Placing Originals	29
Scanning Originals	32

5. Troubleshooting

The Printer Function	33
Error & Status Messages on the Display	33
The Machine Does Not Print	36
Other Printing Problems	38
The Scanner Function	40
When Scanning Is Not Performed as Expected	40
When an Error Message Appears on the Client Computer	41

6. Appendix

The Printer Function	43
Collate and Rotating Collate	43
Edge to Edge Printing	43
The Scanner Function	44
Relationship between Resolution and File Size	44
Specifications	45
Printer.....	45
Scanner.....	46
INDEX	47

How to Read This Manual

Symbols

In this manual, the following symbols are used:

WARNING:

This symbol indicates a potentially hazardous situation which, if instructions are not followed, could result in death or serious injury.

CAUTION:

This symbol indicates a potentially hazardous situation which, if instructions are not followed, may result in minor or moderate injury, or damage to property.

* The statements above are notes for your safety.

Important

If this instruction is not followed, paper might misfeed, originals might be damaged, or data might be lost. Be sure to read this.

Preparation

This symbol indicates prior knowledge or preparation is required before operation.

Note

This symbol indicates precautions for operation, or actions to take after mal-operation.

Limitation

This symbol indicates numerical limits, functions that cannot be used together, or conditions in which a particular function cannot be used.

Reference

This symbol indicates a reference.

[]

Keys and buttons that appear on the computer's display.

[]

Keys that appear on the machine's display.

[]

Keys built into the machine's control panel.

[]

Keys on the computer's keyboard.

1. Getting Started

Control Panel

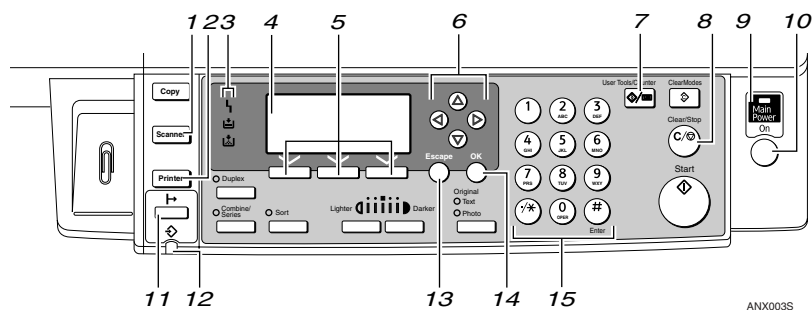

1. [Scanner] key

Press to activate the scanner function.

2. [Printer] key

Press to activate the printer function.

3. Indicators

Displays errors and machine status.

: Error indicator. See *Network Guide* and *General Settings Guide*.

: Load Paper indicator. See *Copy Reference*.

: Add Toner indicator. See *Copy Reference*.

4. Display

Displays operation status and messages.

5. Selection keys

Correspond to items on the display. Press to select the corresponding item.

6. Scroll keys

Press to select an item.

: scroll upward

: scroll downward

: scroll right

: scroll left

7. [User Tools/Counter] key

Press to change default or operation parameters according to requirement.

8. [Clear/Stop] key

Clear: clears an entered numeric value.

9. Main power indicator and On indicator

The main power indicator lights when the main power switch is turned on. The On indicator lights when the operation switch is turned on.

10. Operation switch

Press to turn the power on. The On indicator lights. To turn the power off, press again.

Note

This key is inactivate during printing or while setting printer defaults.

11. [Online] key

Press to switch the printer between on-line and offline.

12. Data In indicator

Blinks while the printer is receiving data from a computer or printing. Lit when preparing to print.

13. [Escape] key

Press to cancel an operation or return to the previous display.

14. [OK] key

Press to set a selected item or entered numeric value.

15. Number keys

Press to enter numeric values.

Reading the Display and Using Keys

This section explains how to read the display and using the selection key for the initial display.

Note

- The copy display is set as the default screen when the machine is turned on. You can change the settings in **[System Settings]**. See *General Settings Guide*.

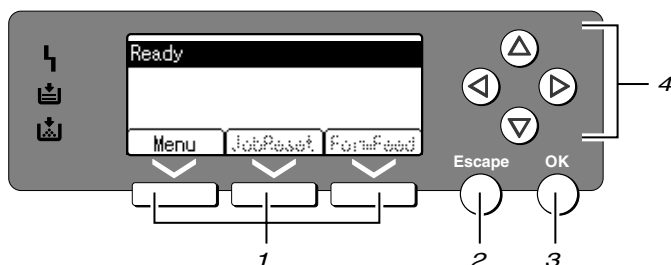

ANX007S

1. Selection keys

Correspond to the function items at the bottom line on the display.

Example: Basic screen

When the instruction "press **[JobReset]**" appears in this manual, press the center selection key.

2. [Escape] key

Press to cancel an operation or return to the previous display.

3. [OK] key

Press to set a selected item or entered numeric value.

4. Scroll keys

Press to move the cursor in each direction, step by step.

When the **[▲]**, **[▼]**, **[▶]**, or **[◀]** key appears in this manual, press the scroll key of the same direction.

Connecting the Machine

Reference

For details about connection using Ethernet, see "Connecting the Network Cable to the Network", *Network Guide*.

Requirements

Before using this machine, make sure all environmental and electrical requirements are met. Connect the machine to the host computer using the USB port or network interface unit.

Make sure all cables, connectors, and electrical outlets necessary to attach the machine to the host computer or network are close at hand.

Connecting the machine to the host using a USB cable

You can connect the machine to the host computer using a USB interface cable.

The USB cable is provided according to machine model:

- Standard model
The USB cable is provided for this model.
- Network standard model
The USB cable is not provided for this model. Purchase a cable that is suitable for connecting this model to your computer.

Follow the procedure below to connect the machine to the host computer using a USB interface cable.

- 1** Connect the USB 2.0 interface cable to the USB port on the right side of the machine's back cover.

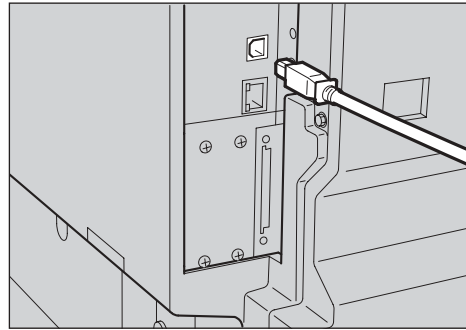

ANX001S

- 2** Connect the other end to the USB port on the host computer.

The machine and computer are now connected. The printer driver and TWAIN driver must be installed next. For details about how to install the printer driver and TWAIN driver, see p.8 "Installing the Printer Driver" and p.9 "Installing the TWAIN Driver".

Note

- If USB 2.0 is used with Windows 98 SE/Me, only a speed equivalent that of USB 1.1 is possible.

2. Installing the Software

This manual assumes you are familiar with general Windows procedures and practices. If you are not, see the operating instructions that come with Windows for details.

Auto Run

Inserting the CD-ROM into the CD-ROM drive starts the installer automatically. The installer helps you install the following printer drivers and software easily.

Note

- When “plug and play” starts, click **[Cancel]** in **[New Hardware Found]**, **[Device Driver Wizard]** or **[Found New Hardware Wizard]** dialog box, and then insert the CD-ROM. The **[New Hardware Found]**, **[Device Driver Wizard]** or **[Found New Hardware Wizard]** dialog box appears depending on the system version of the Windows 98SE / Me / 200 / XP, or Windows Server 2003.
- Auto Run may not work with certain operating system settings. If this happens, launch "Setup.exe" on the CD-ROM root directory.
- To disable Auto Run, press the left **[SHIFT]** key when inserting the CD-ROM into the drive and keep it pressed until the computer finishes reading from the CD-ROM.

Limitation

- Under Windows 2000 / XP, or Windows Server 2003, installing software using Auto Run requires Administrator permission. When you install software using Auto Run, log on using an account that has Administrators permission.

Installing the Printer Driver

When you are using the printer function, you must install the printer driver on the supplied CD-ROM.

1 Quit all applications currently running.

2 Insert the CD-ROM into the CD-ROM drive.

The driver installer starts.

3 Select an interface language, and then click **[OK]**.

The default interface language is English.

4 Click **[DDST Printer Drivers]**.

The DDST Printer Drivers installer starts.

5 The software license agreement appears in the **[License Agreement]** dialog box. After reading through its contents, click **[I accept the agreement.]**, and then click **[Next >]**.

6 Follow the instructions on the display to install DDST Printer Drivers.

If you are required to restart the computer after installing DDST Printer Drivers, restart the computer.

Note

- The printer driver has been installed, plug and play is enabled, and the icon of the printer connected to the "USB" port is added to the **[Printers]** or **[Printers and Faxes]** window.
- When you use the printer function on the Ethernet interface under Windows 98SE / Me, see "Using the Printer Function", *Network Guide*.
- When you use the printer function on the Ethernet interface under Windows 2000 / XP / Server 2003, see "Using the Printer Function", *Network Guide*.

Installing the TWAIN Driver

When you are using the scanner function, you must install the TWAIN driver on the supplied CD-ROM.

1 Quit all applications currently running.

2 Insert the CD-ROM into the CD-ROM drive.

The driver installer starts.

3 Select an interface language, and then click [OK].

The default interface language is English.

4 Click [DDST TWAIN Driver].

The DDST TWAIN Driver installer starts.

5 Click [Close].

Software Supplied on CD-ROM

There are some CD-ROMs that come with the printer option of this machine.

DDST Driver

2

The DDST drivers are included on the CD-ROM that comes with this machine. This allows the computer to communicate with the machine via a printer language.

❖ System requirements

Operating system

- Microsoft Windows 98SE
- Microsoft Windows Me
- Windows 2000
- Windows XP
- Windows Server 2003

Hard disk space

- 80 MB or more

DDST TWAIN Driver

This driver is required to scan an original on the machine.

To use the machine as a network TWAIN scanner, this driver must be installed.

❖ System requirements

- Hardware
PC/AT compatible
- CPU
Pentium 300 MHz or faster recommended
- Operating system
Microsoft Windows 98 (SE or later)
Microsoft Windows Millennium Edition
Microsoft Windows 2000 Professional
Microsoft Windows 2000 Server
Microsoft Windows XP Home Edition
Microsoft Windows XP Professional
- Memory
128 MB or more recommended
- Hard disk space
200 MB or more
- Connection
Ethernet/USB

3. Using the Printer Function

Printer Features Menu

There are five menu items in the Printer Features menu:

Reference

For more information about copier features and system settings, see *Copy Reference* and *General Settings Guide*.

- Paper Input
- List/Test Print
- Maintenance
- System
- Host Interface

You can select the following functions.

Menu	Default
Paper Input See p.13 "Paper Input".	Bypass Paper Size
	Auto Paper Select
	Duplex *1
List/Test Print See p.13 "List/Test Print".	Operations Test
Maintenance See p.14 "Maintenance".	Menu Protect
System See p.16 "System".	Auto Continue
	Edge Smoothing
	Toner Saving
Host Interface See p.16 "Host Interface".	I/O Timeout

*1 Appears on the duplex standard model. Check your machine type.

Adjusting Printer Features

Printer Features allows basic adjustment of operations when using the machine as a printer.

Although factory default settings are suitable for most print jobs, Printer Features allows you access to a number of settings that control basic printer operations. Printer Features settings you make are retained even when you turn off the machine.

For details about copier features and system settings, see *Copy Reference* and *General Settings Guide*.

3

1 Press the [User Tools/Counter] key.

2 Select [Printer Features] using the [▲] or [▼] key, and then press the [OK] key.

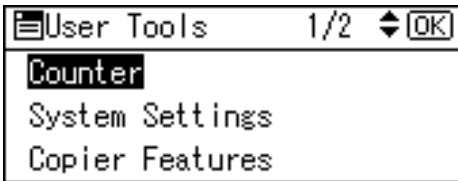

3 Select the desired item using the [▲] or [▼] key, press the [OK] key, and then change its settings.

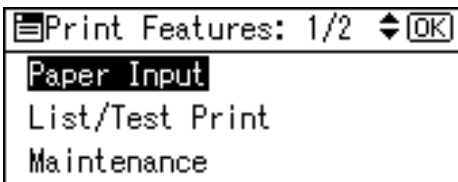

 **Note**

- [OK]: Press to make new settings and go back to previous menus.
- [Escape]: Press to return to a previous menu without changing any setting.

4 After changing the Printer Features settings, press the [User Tools/Counter] key.

 **Note**

- Changes made to functions remain in effect even if the machine is turned off.

Printer Features Parameters

Paper Input

❖ Bypass Paper Size

The size of the paper set in the bypass tray.

Reference

For more information about paper sizes that can be set in the bypass tray, see *General Settings Guide*.

Note

Default:

- Metric version: A4
- Inch version: 11 × 8½

❖ Auto Paper Select

You can set this to enable Auto Paper Select. This machine automatically detects the paper size from the print data, and selects the paper feed tray.

Note

Default: On

❖ Duplex

You can set this to enable the duplex printing. This machine detects the duplex printing from the print data, and selects the paper feed tray.

Note

Default: On

List/Test Print

❖ Operations Test

You can print the operations test page.

Printing the operations test page

1 Press the **[User Tools/Counter]** key.
The User Tools main menu appears.

2 Select **[Printer Features]** using the **[▲]** or **[▼]** key, and then press the **[OK]** key.

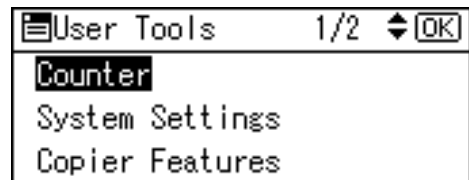

The Printer Features menu appears.

3 Select **[List/Test Print]** using the **[▲]** or **[▼]** key, and then press the **[OK]** key.

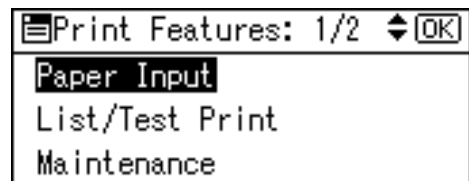

4 Select **[Operations Test]** using the **[▲]** or **[▼]** key, and then press the **[OK]** key.

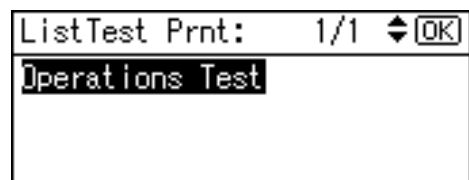

The operations test page is printed.

5 Press the **[User Tools/Counter]** key.

Maintenance

❖ Menu Protect

This procedure allows you to protect menu settings from accidental change. It makes it impossible to change menu settings with normal procedures unless you perform the required key operations.

- Level 1
You can protect "Maintenance", "System", "Host Interface".
- Level 2
You can protect "Paper Input", "Maintenance", "System", "Host Interface".
- Off

Note

- Default: Off

Setting Menu Protect

1 Press the [User Tools/Counter] key.

The User Tools main menu appears.

2 Select [Printer Features] using the [▲] or [▼] key, and then press the [OK] key.



The Printer Features menu appears.

3 Select [Maintenance] using the [▲] or [▼] key, and then press the [OK] key.

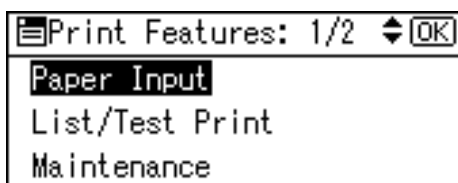

4 Press [Menu Protect].

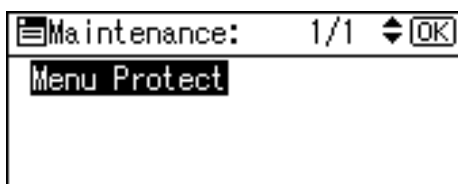

5 Enter an access code using the number keys, and then press the [OK] key.

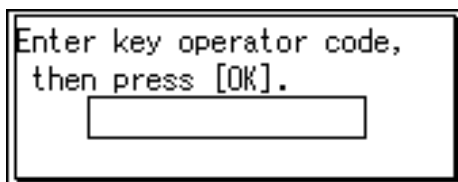

6 Select a menu protect level, and then press the [OK] key.

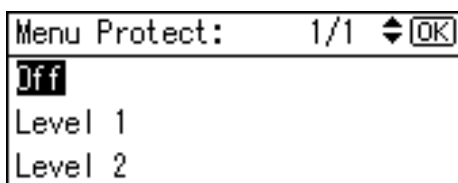

7 Press the [User Tools/Counter] key.

Canceling Menu Protect

1 Press the [User Tools/Counter] key.

2 Select [Printer Features] using the [▲] or [▼] key, and then press the [OK] key.

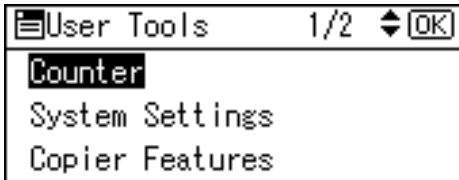

3 Select [Maintenance] using the [▲] or [▼] key, and then press the [OK] key.

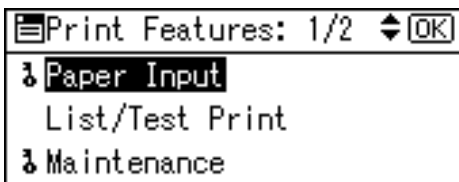

A screen for entering the access codes appears.

4 Enter an access code using the number keys, and then press the [OK] key.

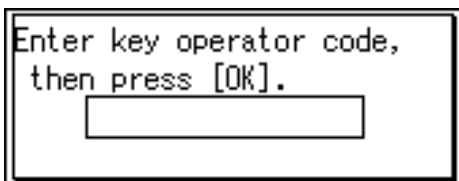

5 Press [Menu Protect].

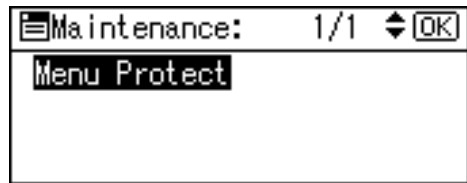

6 Select [Off], and then press the [OK] key.

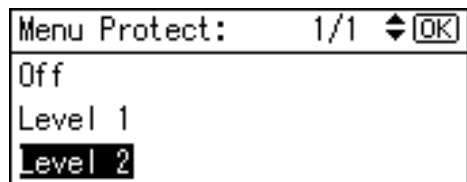

7 Press the [User Tools/Counter] key.

Temporarily canceling Menu Protect

When you select protected items in Printer Features, a screen for entering the access codes appears. When this happens, enter the correct access codes using the number keys, and then press the [OK] key. Menu Protect is then temporarily canceled.

Note

- If you enter the correct access codes, Menu Protect remains canceled while the Printer Features menu is displayed.

System

❖ Auto Continue

You can select this to enable Auto Continue. When it is On, printing continues even after a system error occurs.

- Off
- 0 minutes
- 1 minute
- 5 minutes
- 10 minutes
- 15 minutes

Note

Default: *Off*

❖ Edge Smoothing

Set this to enable Edge Smoothing.

- On
- Off

Note

Default: *On*

If Toner Saving is set to On, Edge Smoothing is ignored even if it is set to On.

❖ Toner Saving

Set this to enable Toner Saving.

- On
- Off

Note

Default: *Off*

Host Interface

❖ I/O Timeout

You can set how many seconds the machine should wait before ending a print job. If data from another port usually arrives in the middle of a print job, you should increase this timeout period.

- 10 seconds
- 15 seconds
- 20 seconds
- 25 seconds
- 60 seconds

Note

Default: *15 seconds*

Setting Paper on the Bypass Tray

The following explains setting paper on the bypass tray. Use the bypass tray to print onto OHP transparencies, labels, thick paper, and envelopes that cannot be loaded in the paper tray.

Reference

For details about setting paper in the paper tray, see *General Settings Guide*.

Note

- ❑ When loading letterhead paper, pay attention to its orientation. See "Orientation-Fixed Paper or Two-Sided Paper", *Copy Reference*.
- ❑ Paper within the following dimensions can be set in the bypass tray:
 - Vertical: 90.0-297.0 mm (3.54 in.-11.69 in.)
 - Horizontal: 148.0-600.0 mm (5.83 in.-23.62 in.)
- ❑ Be sure to set the paper with the side you want to print facing down in the bypass tray.
- ❑ When loading OHP transparencies or thick paper in the bypass tray, make the paper setting using the control panel or printer driver.
- ❑ The number of sheets that can be loaded in the bypass tray depends on the paper type.

Limitation

- ❑ The following functions are disabled when printing from the bypass tray:
 - Duplex Printing
 - Auto Tray Select
 - Auto Tray Switching

Important

- ❑ When printing using the printer function, original images are always rotated by 180 degrees (the orientation of images to be printed is opposite to that of the copier function). When printing onto paper with specific orientation requirements, such as envelopes and letterheads, make sure to rotate the paper feed orientation by 180 degrees.
- ❑ Be sure to set the paper size using the printer driver when printing data from the computer. The paper size set using the printer driver has priority over the one set using the control panel.

1 Open the bypass tray.

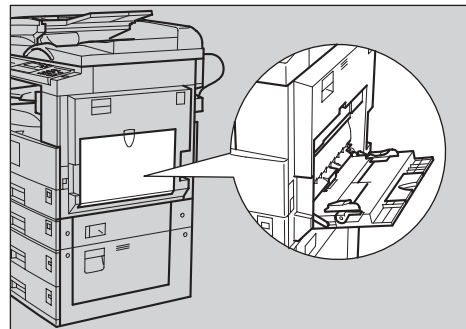

AAW019S1

2 Adjust the paper guides to the paper size.

Important

- ❑ If the paper guides are not flush against the paper, skewed images or paper misfeeds might occur.

- 3** Gently insert paper face down into the bypass tray.

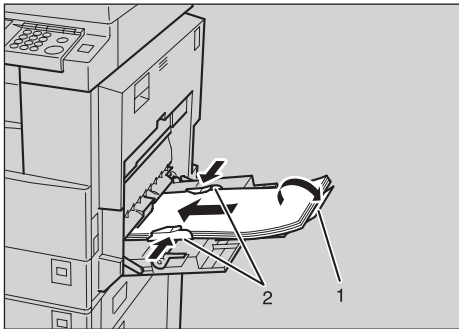

1. Extender

2. Paper guides

Note

- Do not stack paper over the limit mark, otherwise a skewed image or misfeeds might occur.
- Open out the extender to support paper sizes larger than A4 , 8¹/₂"×11" .
- Fan the paper to get air between the sheets to avoid a multi-sheet feed.
- When setting an OHP transparency, make sure that its front and back sides are properly positioned.
- Select paper type when printing onto OHP transparencies or thick paper (over 105g/m²). For details, see p.20 "Setting thick paper or OHP transparencies".
- Select paper type when printing onto envelopes. For details, see p.21 "Setting envelopes".
- Set the paper size, see p.18 "Setting the paper size"

Setting the paper size

Note

- You can set paper size using the printer driver. The following procedures are not necessary when setting paper size using the printer driver.
- The paper size set using the printer driver has priority over that set using the control panel.
- When the printer driver is not used, make settings using the control panel.

Reference

For printer driver settings, see the printer driver Help.

For details about setting custom sizes, see p.19 "Setting custom size paper".

- 1** Press the [User Tools/Counter] key.

- 2** Select [Printer Features] using the [▲] or [▼] key, and then press the [OK] key.

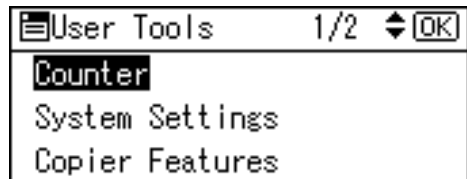

- 3** Select [Paper Input] using the [▲] or [▼] key, and then press the [OK] key.

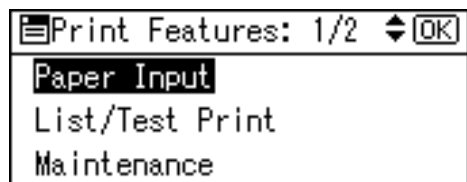

- 4** Select [Bypass Paper Size], and then press the [OK] key.

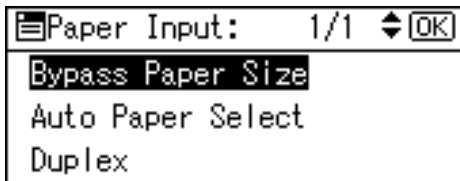

- 5** Select the paper size using the [▲] or [▼] key, and then press the [OK] key.

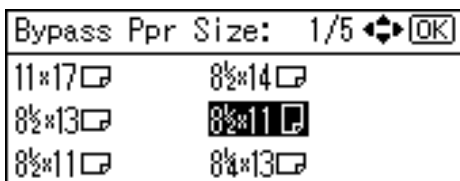

Note

- When printing onto thick paper or OHP transparencies, select the paper type. For details, see p.20 "Setting thick paper or OHP transparencies".

- 6** Press the [User Tools/Counter] key.

Setting custom size paper

Note

- Custom sizes can also be set using the printer driver. The following procedures are not necessary when setting custom sizes using the printer driver.
- Custom size settings set using the printer driver have priority over those set using the machine's control panel.
- When the printer driver is not used, make settings using the control panel.

Reference

For printer driver settings, see the printer driver Help.

- 1** Press the [User Tools/Counter] key.
- 2** Select [Printer Features] using the [▲] or [▼] key, and then press the [OK] key.

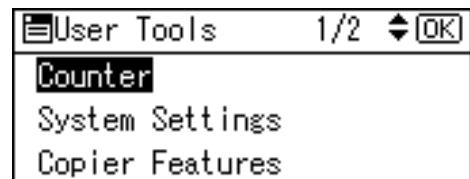

- 3** Select [Paper Input] using the [▲] or [▼] key, and then press the [OK] key.

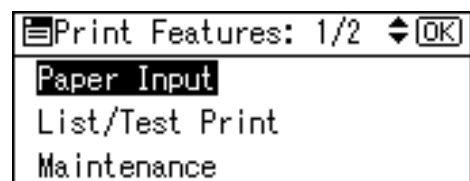

- 4** Select [Bypass Paper Size], and then press the [OK] key.

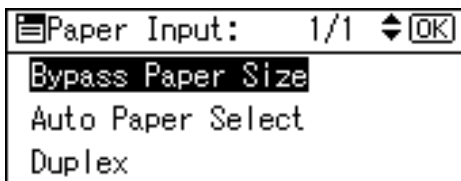

- 5** Select [Custom Size] using the [▲] or [▼] key, and then press the [OK] key.

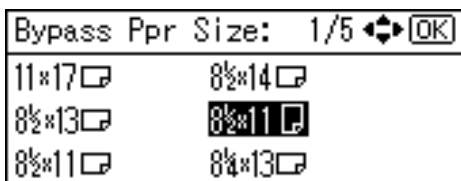

- 6** Enter the horizontal size of the paper using the number keys, and then press the [OK] key.

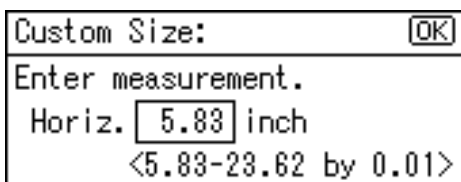

- 7** Enter the vertical size of the paper using the number keys, and then press the [OK] key.

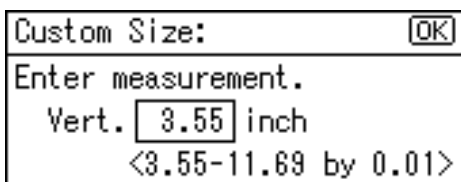

- 8** Press the [User Tools/Counter] key.

Setting thick paper or OHP transparencies

Note

- Paper settings can also be set using the printer driver. The following procedures are not necessary when setting paper sizes using the printer driver.
- Paper size settings set using the printer driver have priority over those set using the machine's control panel.
- When the printer driver is not used, make settings using the control panel.

Reference

For printer driver settings, see the printer driver Help.

- 1** Press the [User Tools/Counter] key.
- 2** Select [System Settings] using the [▲] or [▼] key, and then press the [OK] key.



- 3** Select [Tray Paper Settings] using the [▲] or [▼] key, and then press the [OK] key.

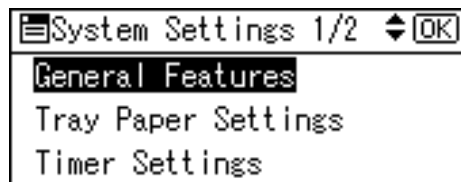

- 4** Select [Paper Type:Bypass Tray] using the [▲] or [▼] key, and then press the [OK] key.

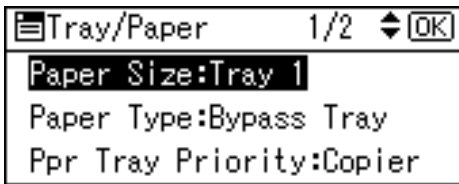

- 5** Select [OHP (Transparency)] or [Thick Paper] using the [▲] or [▼] key, and then press the [OK] key.

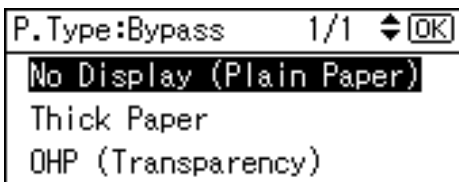

- 6** Press the [User Tools/Counter] key.

Note

- Settings made remain valid until they are reset again. After printing on OHP transparencies or thick paper, make sure you clear settings for the next user.

Setting envelopes

- 1** Press the [User Tools/Counter] key.

- 2** Select [System Settings] using the [▲] or [▼] key, and then press the [OK] key.

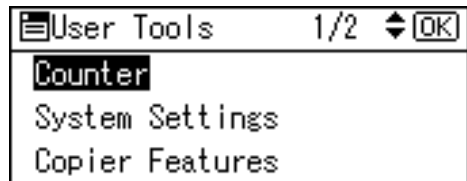

- 3** Select [Tray Paper Settings] using the [▲] or [▼] key, and then press the [OK] key.

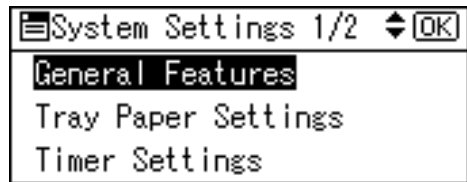

- 4** Select [Paper Type:Bypass Tray] using the [▲] or [▼] key, and then press the [OK] key.

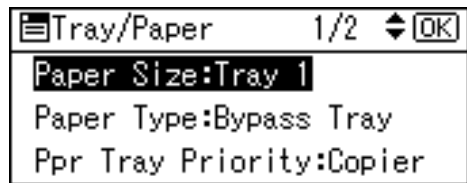

- 5** Select [Thick Paper] using the [▲] or [▼] key, and then press the [OK] key.

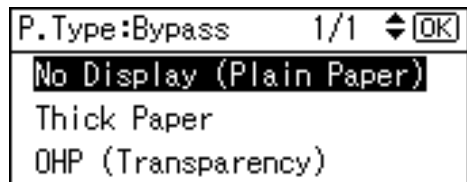

- 6** Press the [Escape] key twice to return to the User Tools main menu.

- 7** Select [Printer Features] using the [▲] or [▼] key, and then press the [OK] key.

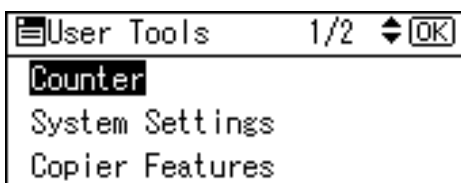

- 8** Select [Paper Input] using the [▲] or [▼] key, and then press the [OK] key.

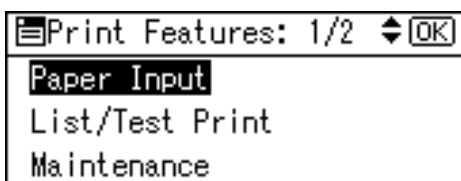

- 9** Select [Bypass Paper Size], and then press the [OK] key.

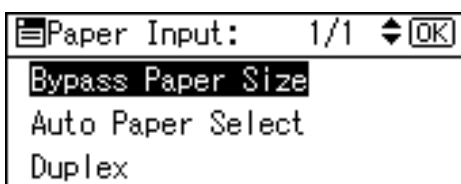

- 10** Select the paper envelope size from [C6 Env], [C5 Env], or [DL Env], and then press the [OK] key.

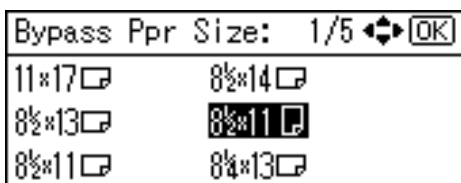

- 11** Press the [User Tools/Counter] key.

Setting Up the Printer Driver and Canceling a Print Job

Windows 98SE / Me - Accessing Printer Properties

Changing default settings

- 1** On the [Start] menu, point to [Settings], and then click [Printers].

The [Printers] window appears.

- 2** Click the icon of the machine whose default you want to change.

- 3** On the [File] menu, click [Properties].

The printer properties dialog box appears.

- 4** Make the settings you want, and then click [OK].

Note

- With some applications, printer driver settings are not used, and the application's own settings are applied.

Making settings from an application

To make settings for a specific application, open the printer properties dialog box from that application. The following example describes how to make settings for the WordPad application that comes with Windows 98SE / Me.

Note

- Actual procedures for opening the printer properties dialog box may vary depending on the application. For more information, see the operating instructions that come with the application you are using.
- Any setting you make in the following procedure is valid for the current application only.

- 1** On the [File] menu, click [Print].

The [Print] dialog box appears.

- 2** In the [Name] list, select the machine you want to use, and then click [Properties].

The printer properties dialog box appears.

- 3** Make the settings you want, and then click [OK].

- 4** Click [OK] to start printing.

Windows 2000 / XP and Windows Server 2003 - Accessing Printer Properties

Changing default settings - Printer properties

⚠ Limitation

- ❑ Changing machine settings requires Manage Printers permission. Members of Administrators and Power Users groups have Manage Printers permission by default. When you set up options, log on using an account that has Manage Printers permission.

1 On the [Start] menu, point to [Settings], and then click [Printers].

The [Printers] window appears.

📝 Note

- ❑ Under Windows XP Professional and Windows Server 2003, open the [Printers and Faxes] window on the [Start] menu.
- ❑ Under Windows XP Home Edition, open the [Printers and Faxes] window by clicking [Control Panel] from the [Start] button on the taskbar, click [Printers and Other Hardware], and then click [Printers and Faxes].

2 Click the icon of the machine whose default you want to change.

3 On the [File] menu, click [Properties].

The printer properties dialog box appears.

4 Make the settings you want, and then click [OK].

📝 Note

- ❑ Normally you do not have to change the “Form to Tray Assignment” settings on the [Device Settings] tab in the PostScript 3 printer driver.
- ❑ Settings you make here are used as default for all applications.

Changing default settings - Printing preferences properties

⚠ Limitation

- ❑ Changing machine settings requires Manage Printers permission. Members of the Administrators and Power Users groups have Manage Printers permission by default. When you set up options, log on using an account that has Manage Printers permission.

1 On the [Start] menu, point to [Settings], and then click [Printers].

The [Printers] window appears.

📝 Note

- ❑ Under Windows XP Professional and Windows Server 2003, open the [Printers and Faxes] window on the [Start] menu.
- ❑ Under Windows XP Home Edition, open the [Printers and Faxes] window by clicking [Control Panel] from the [Start] button on the taskbar, click [Printers and Other Hardware], and then click [Printers and Faxes].

2 Click the icon of the machine whose default you want to change.

3 On the [File] menu, click [Printing Preferences...].

The [Printing Preferences] dialog box appears.

- 4** Make the settings you want, and then click **[OK]**.

 **Note**

- Settings you make here are used as default for all applications.

Making settings from an application

To make settings for a specific application, open the **[Print]** dialog box from that application. The following example describes how to make settings for the WordPad application that comes with Windows 2000 / XP and Windows Server 2003.

 **Note**

- Actual procedures for opening the **[Print]** dialog box vary depending on the application. For details, see the operating instructions that come with the application you are using.
- Any setting you make in the following procedure is valid for the current application only.

- 1** On the **[File]** menu, click **[Print...]**.

The **[Print]** dialog box appears.

- 2** In the **[Select Printer]** list, select the machine you want to use, and then click the tab for which you want to change print settings.

 **Note**

- Under Windows XP and Windows Server 2003, click **[Preference]** to open the Printing Preferences dialog box.

- 3** Make the settings you want.

- 4** Click **[Print]** to start printing.

Under Windows XP and Windows Server 2003, click **[OK]**, and then click **[Print]** to start printing.

Canceling a Print Job

- 1** Double-click the printer icon on the Windows taskbar.

A window appears, showing all print jobs currently queued for printing. Check the current status of the job you want to cancel.

- 2** Select the name of the job you want to cancel.

- 3** On the **[Document]** menu, click **[Cancel Printing]**.

 **Note**

- Under Windows 2000 / XP, and Windows Server 2003, click **[cancel]** on the **[Document]** menu.
- Under Windows 98SE / Me / 2000 / XP, or Windows Server 2003, you can also open the print job queue window by double-clicking the machine icon in the **[Printers]** machine window (the **[Printers and Faxes]** window under Windows XP and Windows Server 2003).

- 4** Press the **[Printer]** key.

- 5** Press **[JobReset]**.

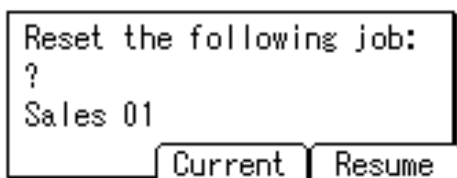

6 Press **[Current]**.

- **[Current]**: cancels the print job currently being processed.
 - **[Resume]**: resumes printing jobs.
- A confirmation message appears.

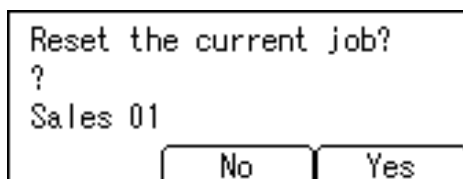
7 Press **[Yes]** to cancel the print job. **Note**

- Press **[No]** to return to the previous display.

 **Important**

- If the machine is shared by multiple computers, be careful not to accidentally cancel someone else's print job.

 **Note**

- You cannot stop printing data that has already been processed. For this reason, printing may continue for a few pages after you press **[JobReset]**.
- A print job containing a large volume of data may take considerable time to stop.

4. Using the TWAIN Scanner Function

TWAIN Scanner

You can use this machine as a TWAIN scanner, by operating this machine from a client computer on the network. Originals can be scanned with the same operation used for USB-connected scanners.

Also, this machine can be used as a TWAIN-compliant scanner, by directly connected with an off-line Computer over USB.

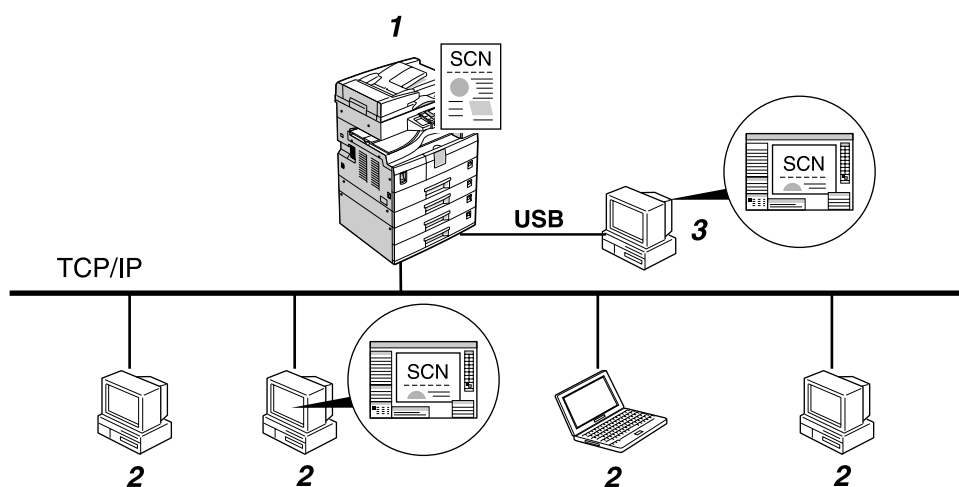

ANX005S

1. This machine

Connect this machine to a ethernet (TCP/IP) and/or a USB.

2. Client computer

The scanner can be operated using a TWAIN-compliant application (such as Imaging).

3. Off-line computer

This is a PC that is USB-connected to this machine. You can use this scanner from a TWAIN-compliant application (such as Imaging).

Process Flow

- 1** Use a TWAIN-compliant application on a "2. Client computer" or "3. Off-line computer" to send a command for scanning via the TWAIN driver.
- 2** Originals are scanned by "1. This machine."
- 3** The scanned data can be edited and stored using the TWAIN-compliant application on the "2. Client computer" or "3. Off-line computer."

Preparation for Using the Network TWAIN Scanner

The following overview diagram shows the preparation steps for using this machine as a TWAIN scanner.

Install the TWAIN driver on a client computer. *1

See p.9 "Installing the TWAIN Driver".



Connect the scanner and client computer with a cable.

USB connection: See p.5 "Connecting the machine to the host using a USB cable".
Ethernet connection: See "Connecting the Machine" in *Network Guide*.

4

*1 If you use this machine as a TWAIN scanner, you need a TWAIN-compliant application on the client computer you use.

TWAIN Scanner Screen

When using the machine as the TWAIN scanner, it is not necessary to press the **[Scanner]** key on the control panel. When the TWAIN driver becomes active on a client computer, the display automatically switches to the following screen.

```
Connecting with PC.  
Set originals and select  
the settings from PC.
```

Setting Originals



The following explains the procedure for placing originals on the exposure glass and in the ADF, and setting the original scan area and orientation according to the placement method.

To correctly display the top/bottom orientation of the scanned original on a client computer, the placement of the original and the settings made on the control panel and scanner driver must match.



Placing Originals

There are two orientations for placing the original. See the table below.

Note

- Normally, an original is  or , but in the table below, a square original is used to make original orientation easy to understand. If the actual shape of the original is different, the combination of original orientation and the orientation specified on the control panel or scanner driver does not change.

❖ Specifying original orientation and setting originals

<p>1 An original to be scanned</p>				
<p>2 Decide the placement method.</p>	Exposure glass		ADF	
<p>3 Place the original. (There are two original orientations.)</p>	<p>Place the original so that the top edge touches the top left of the exposure glass.</p>	<p>Place the original so that the top edge touches the rear of the exposure glass.</p>	<p>Place the top edge of the original first.</p>	<p>Place the original so that the top edge touches the back of the ADF.</p>
<p>4 The original displayed on a computer</p>				

Placing on the Exposure Glass

Originals which do not fit into the ADF, such as sheets with glued-on parts, books, etc., can be placed directly on the exposure glass for scanning.

 **Note**

- ❑ For details about the originals which can be placed on the exposure glass, see *Copy Reference*.

1 Lift the exposure glass cover or the ADF.

 **Note**

- ❑ Lift the exposure glass cover or ADF for more than 30 degrees. The opening/closing action triggers the automatic original size detection process.

2 Place the original on the exposure glass with the side to be scanned facing down. Align the original with the back left corner mark.

There are two original orientations.

- ❖ When placing the original so that the top edge touches the rear of the exposure glass

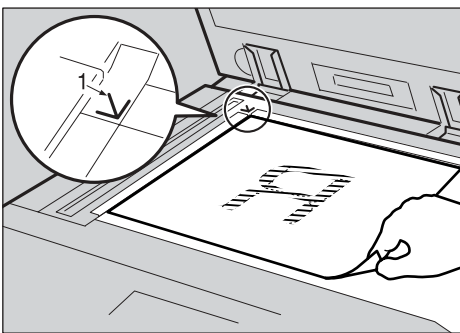

1. Positioning mark

- ❖ When placing the original so that the top edge touches the top left of the exposure glass

When using the machine as a network TWAIN scanner, this orientation is the standard setting for the TWAIN driver. Normally, use this orientation for placing originals.

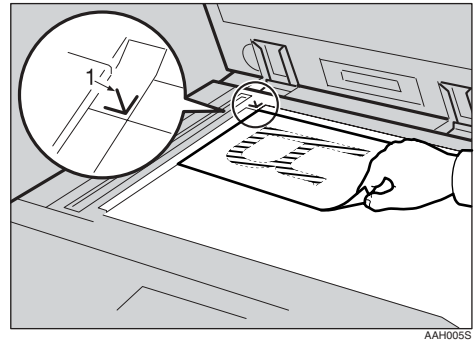

1. Positioning mark

3 Lower the exposure glass cover or the ADF.

4 Select the original orientation according to the orientation of the placed original.

 **Reference**

p.29 "Specifying original orientation and setting originals"

Placing in the Auto Document Feeder

The ADF allows you to place multiple originals at one time. Originals placed in the ADF can be scanned on one side or both sides.

 **Note**

- ❑ The duplex function is available only when you have installed the optional ADF capable of scanning both sides of a sheet (ARDF).

❖ Originals that can and cannot be placed in the ADF

For details about the originals that can and cannot be placed in the ADF, see *Copy Reference*.

Attempting to use originals unsuitable for the ADF can lead to a misfeed and damage to the originals. Place such originals directly on the exposure glass.

⚠ Important

- For details about original sizes that can be detected automatically and notes on placing originals in the ADF, see *Copy Reference*.

1 Adjust the original guide to match the size of the originals.

2 Place the originals with the side to be scanned facing up.

For originals which are to be scanned on both sides, the first side should face up.

There are two orientations.

❖ When placing the originals so that the top edges touch the back of the ADF

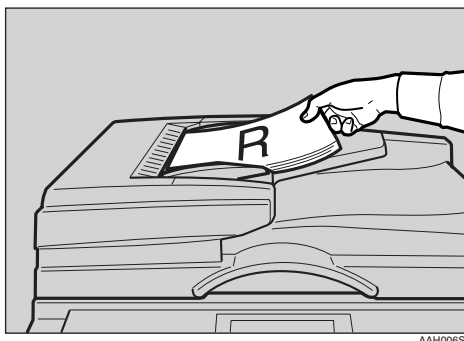

❖ When placing the top edges of the originals first

When using the machine as a network TWAIN scanner, this orientation is the standard setting for the TWAIN driver. Normally, use this orientation for placing originals.

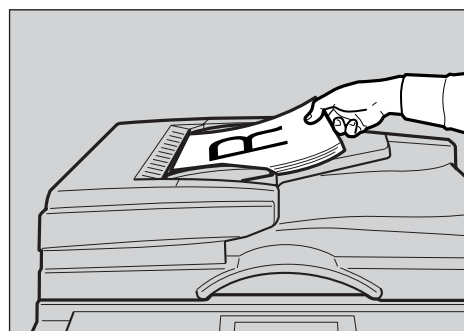

📎 Note

- Originals of the same width and different length can be placed at the same time. Place the originals as shown:

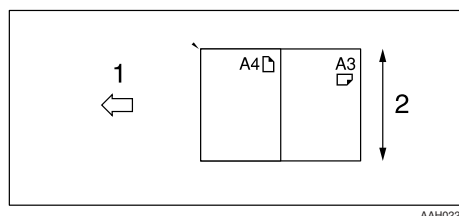

1. ADF placement orientation

2. Height

- Originals are scanned in the inserted order, starting from the topmost page.

3 Select the original orientation according to the orientation of the placed originals.

🔍 Reference

p.29 "Specifying original orientation and setting originals"

Scanning Originals

This section explains how to scan originals using the TWAIN scanner function. This describes how to scan originals with Imaging under Windows 2000.

1 Start Imaging, and then select the scanner driver.

2 On the [Start] menu, point to [Program], point to [Accessories], and then click [Imaging].

3 Click [Select Device...] on the [File] menu.

If the scanner is already selected, no scanner settings are necessary. Proceed to step **5**.

4 Select the name of the machine you want to use in the list, and then click [OK].

5 Place the original in the scanner.



Reference

p.29 "Placing Originals"

6 Click [Acquire Image...] on the [File] menu.

The TWAIN Driver dialog box appears.

7 Select the connection method.

If you are using Network TWAIN, enter the IP address in the box under [Select Device].

If you are using USB TWAIN, click the [USB] check box.

8 Click [OK].

Main Setting window appears.

9 Click [Preview] or [Scan] to preview or scan image.

Click [Scan] to return to Imaging.

10 Save the scan file in Imaging.

11 On the [File] menu, click [Save].

12 Enter the file name, select the folder in which you want to save the file, and then click [Save].

For details about the scanning function, click [Help] on the Main Setting dialog box.

5. Troubleshooting

The Printer Function

Error & Status Messages on the Display

This section describes the principal messages that appear on the display. If a message not described here appears, act according to the message.

Reference

Before turning the main power off, see 'Turning On the Power', *Copy Reference*.

❖ Status messages

Message	Status
Offline	The machine is offline. To start printing, switch the machine online by pressing [Online] on the control panel.
Please wait.	Wait a while.
Printing...	The machine is printing. Wait a while.
Ready	The machine is ready for use. No action is required.
Resetting Job...	The machine is resetting the print job. Wait until "Ready" appears on the display.
Setting change...	The machine settings are being changed. Wait a while.
Waiting...	The machine is waiting for the next data to print. Wait a while.

❖ Alert messages

Messages/Second messages	Causes	Solutions
Change Tray # to the following settings: xxx yyy	The settings of the selected paper tray are different from those specified for printing. # indicates the tray number. xxx indicates the tray number. yyy indicates the paper size.	Press [JobReset] to change the paper tray settings, or press [FormFeed] to print regardless. For details about the paper tray settings, see <i>General Settings Guide</i> .
Collate cancelled.	The collate print function has been canceled.	Turn off the main power switch, and back on again. If the message appears again, contact your sales or service representative.
Collate: Page max.	The maximum number of pages has been exceeded for collation.	Turn off the main power switch, and back on again. Reduce the number of pages to be printed, or, increase memory capacity. When installing a memory module in the machine, contact your sales or service representative.
Duplex cancelled.	Duplex printing has been canceled.	Check the paper used is suitable for duplex printing, or, increase memory capacity. When installing a memory module in the machine, contact your sales or service representative.
Duplex mode is in off position for Tray #	The selected paper tray has not been configured for duplex printing. # indicates the tray number.	Press [JobReset] to change the paper tray settings, or do single-sided printing. For details about the tray settings, see <i>General Settings Guide</i> .
Ethernet Board Error	An error has occurred in the Ethernet interface.	Turn off the main power switch, and back on again. If the message appears again, contact your sales or service representative.
Exceeded max. print size. Press FormFeed/JobReset.	The page images to be printed exceed the maximum print area.	Press [JobReset] to change the paper tray settings, or press [FormFeed] to print regardless.
I/O buffer overflow	The maximum size of the I/O buffer has been exceeded.	Increase the size of the I/O buffer through the Host Interface menu.
Load paper in Tray #	There is no paper in the selected paper tray. # indicates the tray number.	Load the tray with paper.

Messages/Second messages	Causes	Solutions
NV-RAM Error	An error has occurred in the printer.	Turn off the main power switch, and back on again. If the message appears again, contact your sales or service representative.
Output Tray changed.	The output tray has been changed because of the paper size limitation of the selected tray.	Select the correct output tray.
Paper size/type mismatch. Change settings to: xxx yyy	There is no paper tray that matches the paper settings selected under Auto Tray Select. xxx indicates the tray number. yyy indicates the paper size and the paper type.	Press [JobReset] to change the paper tray settings, or press [FormFeed] to print regardless. For details about the paper tray settings, see <i>General Settings Guide</i> .
[Print] without below mode?	This is an alert message concerning a paper tray in auto tray select.	Press [Print] to cancel the mode and print the job.
Printer Font Error	An error has occurred in the font file.	Turn off the main power switch, and back on again. If the message appears again, contact your sales or service representative.
Print overrun.	The image data has been thinned out due to image compression.	Increase memory capacity. When installing a memory module in the machine, contact your sales or service representative.
Paper Tray is in use.	The specified paper tray is in use by another function, such as the copier function.	Wait until the other function has finished using the specified paper tray.
Reset Paper Tray correctly.	The selected paper tray does not exist or is not set correctly.	Set the paper tray correctly.
 Toner is almost empty Add toner	Toner is running out.	Replace the toner cartridge soon to prevent poor print quality.
Tray # Error	An error has occurred with the paper tray. # indicates the tray number.	Press [JobReset] to change the paper tray settings, or press [FormFeed] to select another paper tray and print.
Unauthorized user access.	Print job canceled due to user restrictions.	Check the User Code permission status.
USB has a problem	An error has occurred in the USB interface.	Turn off the main power switch, and back on again. If the message appears again, contact your sales or service representative.

The Machine Does Not Print

Possible Cause	Solutions
Is the power on?	Check the cable is securely plugged into the power outlet and the machine. Turn on the main power switch.
Is the machine online?	If not, press [⏪ Online] on the control panel.
Does the Printer key stay red?	If so, check the error message on the display and take required action.
Is there a warning status or error message on the display?	If so, check the error message or warning status on the display and take the required action.
Is the interface cable connected securely to the machine and computer?	Connect the interface cable securely. If it has a fastener, fasten that securely as well. See p.5 "Connecting the Machine".
Are you using the correct interface cable?	The type of interface cable you should use depends on the computer. Be sure to use the correct one. If the cable is damaged or worn, replace it. See p.5 "Connecting the Machine".
Was the interface cable connected after the machine was turned on?	Connect the interface cable <i>before</i> turning on the machine.

Problem	Solutions
<p>Is the Data In indicator blinking or lit after starting the print job?</p>	<p>If not, data is not being sent to the machine.</p> <ul style="list-style-type: none"> ❖ When the machine is connected to the computer using the interface cable <p>Check the machine port settings are correct. For the USB port connection, the USB port should be set.</p> <ul style="list-style-type: none"> • Windows 98SE / Me <ol style="list-style-type: none"> ① Click the [Start] button, point to [Settings], and then click [Printers]. ② Click the icon of the machine. On the [File] menu, click [Properties]. ③ Click the [Details] tab. ④ In the [Print to the following port:] list, confirm the correct port is selected. • Windows 2000 <ol style="list-style-type: none"> ① Click the [Start] button, point to [Settings], and then click [Printers]. ② Click the icon of the machine. On the [File] menu, click [Properties]. ③ Click the [Ports] tab. ④ In the [Print to the following port(s)] list, confirm the correct port is selected. • Windows XP Professional and Windows Server 2003 <ol style="list-style-type: none"> ① Click the [Start] button, and then click [Printers and Faxes]. ② Click the icon of the machine. On the [File] menu, click [Properties]. ③ Click the [Ports] tab. ④ In the [Print to the following port(s)] list, confirm the correct port is selected. • Windows XP Home Edition <ol style="list-style-type: none"> ① Click the [Start] button, click [Control Panel], click [Printers and Other Hardware], and then click [Printers and Faxes]. ② Click the icon of the machine. On the [File] menu, click [Properties]. ③ Click the [Ports] tab. ④ In the [Print to the following port(s)] list, confirm the correct port is selected. ❖ Network connection <p>Contact your network administrator.</p>

Other Printing Problems

Problem	Causes and Solutions
Smudged print.	Settings for thick paper have not been made when printing on thick paper. Select [Thick] in the [Type:] list on the [Paper] tab on the printer driver.
Page layout is not as expected.	Print areas differ depending on the machine used. Information that fits on a single page on one machine may not fit on a single page of another machine.
Duplex printing is not possible.	<ul style="list-style-type: none"> • Duplex printing cannot be done with paper set in the bypass tray. When using duplex printing, make settings to use paper from a tray other than the bypass tray. • Duplex printing cannot be done with thick paper, OHP transparencies, or labels specified as the paper type. Specify another paper type. • Duplex printing cannot be done using a tray for which [Duplex] is not selected as the paper type in [Tray Paper Settings] in [System Settings]. Select [Duplex] as the paper type in [Paper Input]. See <i>General Settings Guide</i>.
When using Windows 98SE / Me or Windows 2000 / XP, either combined printing or booklet print does not come out as expected.	<p>Make sure the application's paper size and orientation settings match those of the printer driver.</p> <p>If a different paper size and orientation are set, select the same size and orientation.</p>
When using Windows 98SE / Me or Windows 2000 / XP, Auto Reduce/Enlarge print does not come out as expected.	
A print instruction was issued from the computer, but printing did not start.	User code management may be set. Ask the administrator about valid user codes. To print, the user code must be entered from the printer driver.
The print job is not canceled even when the machine is switched to off-line status.	<p>Select [Printer Priority] for [Signal Control].</p> <p>See "User Tools (System Settings)", <i>General Settings Guide</i>.</p>
Photo images are coarse.	Some applications reduce print resolution.
Images are cut off, or excess is printed.	You may be using paper smaller than the size selected in the application. Use the same size paper as that selected in the application. If you cannot load paper of the correct size, use the reduction function to reduce the image, and then print.

Problem	Causes and Solutions
It takes a long time to complete a print job.	The data is large or complex so it takes time to process. If the Data In indicator is blinking, data is being processed. Wait until printing resumes.
It takes too much time to resume printing.	The data is large or complex so it takes time to process. If the Data In indicator is blinking, data is being processed. Wait until printing resumes.
	The machine is in Energy Saver mode. To resume from Energy Saver mode, it has to warm up, and this takes time. See <i>General Settings Guide</i> .
Paper is not fed from the selected tray.	When you are using a Windows operating system, printer driver settings override those set using the control panel. Set the desired input tray using the printer driver.
Optional components connected to the machine are not recognized when using Windows 98SE / Me, Windows 2000 / XP, and Windows Server 2003.	You have to configure the option setup in printer properties when bidirectional transmission is not enabled. See the printer driver Help.
Images are printed in the wrong orientation.	The feed orientation you selected and the feed orientation selected in the printer driver's option setup might not be the same. Set the machine's feed orientation and the printer driver's feed orientation accordingly. See the printer driver Help.
The printed image is different from the image on the computer's display.	With certain functions, such as enlargement and reduction, image layout might be different to that on the computer display.

 **Note**

- If the problem cannot be solved, contact your sales or service representative.

The Scanner Function

When Scanning Is Not Performed as Expected

Problems	Causes and solutions
No image results from scanning.	The original was placed with the front and back reversed. When the original is placed directly on the exposure glass, the side to be scanned must face down. When the original is fed via the ADF, the side to be scanned must face up. See p.29 "Placing Originals".
The image is distorted or out of position.	<ul style="list-style-type: none"> • The original was moved during scanning. Do not move the original during scanning. • The original was not pressed flat against the exposure glass. Make sure that the original is pressed flat against the exposure glass.
The scanned image is dirty.	The exposure glass or the exposure glass cover is dirty. Clean these parts. See <i>General Settings Guide</i> .
The scanned image is upside down.	The original was placed upside down. Place the original in the correct orientation. See p.29 "Placing Originals".

5

When an Error Message Appears on the Client Computer

This section describes the main possible causes and actions for error messages displayed on the client computer when the TWAIN driver is used.

Note

- If an error message that is not contained in this section appears, turn off the main power switch of the machine, and then turn it on again. If the message is still shown after scanning is performed again, note the content of the message and the error number (if listed in the table), and contact your service representative. For details about how to turn off the main power switch, see *General Settings Guide*.



Message	Causes and solutions
[ADF cover has been lifted.]	The ADF cover is open. Close it.
[Clear Misfeed(s) in ADF.]	Remove the jammed originals. When originals are misfed, place them again. Check whether the originals are suitable to be scanned by the machine.
[Insufficient memory. Please close all other applications, then restart scanning.]	Close all the unnecessary applications running on the client computer.
[Insufficient memory. Resolution is too high. Please reduce resolution or expand scanner.]	<ul style="list-style-type: none"> • Reset the scan size. • Lower the resolution. <p> Note</p> <ul style="list-style-type: none"> <input type="checkbox"/> When a paper misfeed occurs in the machine during printing, scanning cannot be performed. In this case, after the misfed paper has been removed, proceed with scanning.
[Invalid command. Scanning has been aborted.]	<p>Check whether the main power switch of the machine is turned off.</p> <p>Check whether the machine is connected to the network correctly.</p>
[No original on platen glass or ADF.]	<p>Place the original correctly.</p> <p>See p.29 "Placing Originals".</p>
[No response from the scanner.]	<ul style="list-style-type: none"> • Check whether the machine is connected to the network correctly. • The network is crowded. Wait for a while, and then try to reconnect.
[Scanner is in use by other user. Please wait.]	The scanner function is being used. Wait for a while and reconnect.
[Scanner is not available. Please check scanner connection.]	<ul style="list-style-type: none"> • Check whether the main power switch of the machine is turned off. • Check whether the machine is connected to the network correctly. • Deselect the personal firewall function of the client computers.

The Printer Function

Collate and Rotating Collate

If you select the collate function on the printer driver, the machine will store print data in memory and automatically collate the printouts.

The collate function can be turned on or off from the printer driver. The machine automatically rotates the printouts under the following conditions:

- When using A4, 8¹/₂×11 or B5 JIS paper
- Paper with the same size and different orientations (e.g., A4  in Tray 1 and A4  in Tray 2)
- Auto Tray Select is specified for tray setting

📌 Limitation

- You cannot use the bypass tray with this function.

❖ Collate

Outputs can be assembled as sets in sequential order.

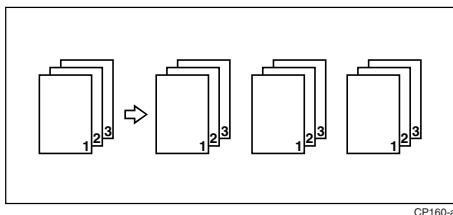

❖ Rotating Collate

Every other output set is rotated by 90° .

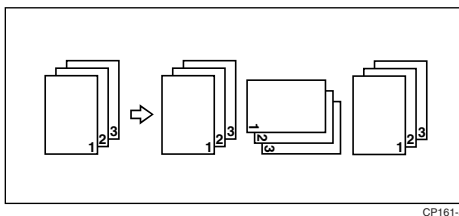

Edge to Edge Printing

If you select the **[Edge to Edge Printing]** function in the **[Paper]** tab on the printer driver, you can print on the entire area of A4 sheets, leaving no borders or edges.

The Scanner Function

Relationship between Resolution and File Size

Resolution and scan area are inversely related. The higher the resolution is set, the smaller the area that can be scanned. Conversely, the larger the scan area, the lower the resolution that can be set.

The relationship between the scanning resolution and the file size is shown below. If the file size is too large, the message "Exceeded max.data capacity. Check the scanning resolution." appears on the control panel of the machine. Specify the scan size and resolution again.

Limitation

- Depending on the image compression level, the maximum image size will be limited.

When Using as a TWAIN Scanner

All combinations up to 297 × 432 mm/11.6 × 17.0 inches (A3, 11 × 17 inches) and 600 dpi are possible.



Reference

To specify the scanning area or resolution when using the machine as a network TWAIN scanner, see TWAIN driver Help.

















Specifications

Printer

This section contains the machine's electrical and hardware specifications, including information about its options.

Component	Specifications
Resolution	600 dpi
Printing speed	16 ppm/21 ppm (A4  , 8½" × 11"  plain paper)  Note <input type="checkbox"/> Printing speeds depend on the machine. Check which type of machine you have. See <i>General Settings Guide</i> .
Interface	<ul style="list-style-type: none"> ❖ Standard model <ul style="list-style-type: none"> • Standard: USB 2.0 interface ❖ Network standard model <ul style="list-style-type: none"> Standard: • USB 2.0 interface • Ethernet interface (100BASE-TX/10BASE-T)
Network protocol	TCP/IP
Printer language	Host-Based Printing
Memory	<ul style="list-style-type: none"> • Standard model 32 MB • Network standard model 64 MB
Operating systems supported by this machine	Windows 98SE / Me Windows 2000 Windows XP Windows Server 2003
Required network cable	100BASE-TX/10BASE-T shielded twisted-pair (STP, Category/Type5) cable.

Scanner

Scan method	Flatbed scanning
Scan speed ^{*1}	Approx.25 pages/minute [Scan size:A4  , Colors/Grada-tions:Binary, Resolution: 200dpi, Select device data com-pression (Binary/Halftone): Data compression (MMR), Document feeder: ADF, ITU-T No.1 Chart]
Maximum power consumption	Less than 1280 W
Image sensor type	CCD Image Sensor
Scan types	Sheet, book
Interface	USB interface, Ethernet interface (10BASE-T or 100BASE-TX)
Maximum scan size	297 × 432 mm/11.6 × 17.0 inches(A3, 11 × 17 inches)
Scan sizes that can be detected au-tomatically	<ul style="list-style-type: none"> • Exposure glass A3 , B4 , A4  , B5 , 8" × 13"  • ADF A3 , B4 , A4  , B5  , A5  , 8.5" × 13" 
Resolution	600 dpi
Variable range of scan resolution	Setting range: 100 dpi - 600 dpi

^{*1} Scanning speeds vary according to machine operating conditions, computer (speci-fication, network traffic, and software, etc.), and original types.

INDEX

B

Bypass tray, 17

C

Canceling a job, 25

Connection

Ethernet board connection, 5

USB connection, 5

Control Panel, 3

Control panel, 4

Custom size paper, 19

printing, bypass tray, 17

D

Data In indicator, 37, 39

DDST TWAIN Driver, 10

Display, 4

error messages, 33

E

Error messages, 33

H

Host Interface, 16

I

Interface, 45

L

List/Test Print, 13

M

Maintenance, 14

Memory, 45

N

Network Cable, 45

Network protocol, 45

O

OHP Transparencies

printing, bypass tray, 20

Operating system, 45

Operations Test, 13

P

Paper Input, 13

paper size, 18

Placing Originals, 29

Placing on the exposure glass, 30

Placing original in the Auto Document Feeder (ADF), 30

Printer driver

DDST, 10

Printer properties, Windows 2000 / XP and Windows Server 2003, 24

Printer properties, Windows 98SE / Me, 23

printer driver

Auto Run, 7

installing, 8

Printer Features

adjusting, 12

menu, 11

parameters, 13

Printer Language, 45

Printing speed, 45

R

Relationship between resolution and file size, 44

When Using as a TWAIN Scanner, 44

Resolution, 45

S

Scanning originals, 32

Setting Originals, 29

Software supplied on CD-ROM, 10

Specifications, 45

System, 16

T

Thick Paper

printing, bypass tray, 20

Troubleshooting, 33

error messages, 33

machine does not print, 36

other printing problems, 38

status messages, 33

When an Error Message Appears on the Client Computer, 41

When Scanning Is Not Performed as Expected, 40

TWAIN

installing, 9

TWAIN scanner, 27

W

Windows 2000 / XP and Windows Server 2003

printer properties, printer driver, 24

Windows 98SE / Me

printer properties, printer driver, 23

Note to users in the United States of America

Note:

This equipment has been tested and found to comply with the limits for a Class B digital device, pursuant to Part 15 of the FCC Rules. These limits are designed to provide reasonable protection against harmful interference in a residential installation. This equipment generates, uses and can radiate radio frequency energy and, if not installed and used in accordance with the instructions, may cause harmful interference to radio communications. However, there is no guarantee that interference will not occur in a particular installation. If this equipment does cause harmful interference to radio or television reception, which can be determined by turning the equipment off and on, the user is encouraged to try to correct the interference by one more of the following measures:

Reorient or relocate the receiving antenna.

Increase the separation between the equipment and receiver.

Connect the equipment into an outlet on a circuit different from that to which the receiver is connected.

Consult the dealer or an experienced radio /TV technician for help.

Caution:

Changes or modifications not expressly approved by the party responsible for compliance could void the user's authority to operate the equipment.

Declaration of Conformity

Product Name: Printer/Scanner Controller

Model Number: DDST Unit Type A / Type B

Responsible party: Ricoh Corporation

Address: 5 Dedrick Place, West Caldwell, NJ 07006

Telephone number: 973-882-2000

This device complies with Part 15 of the FCC Rules.

Operation is subject to the following two conditions:

1. This device may not cause harmful interference, and
 2. this device must accept any interference received, including interference that may cause undesired operation.
-
1. Properly shielded and grounded cables and connectors must be used for connections to a host computer (and/or peripheral) in order to meet FCC emission limits.
 2. An AC adapter with a ferrite core must be used for RF interference suppression.

Note to users in Canada

Note:

This Class B digital apparatus complies with Canadian ICES-003.

Remarque concernant les utilisateurs au Canada

Avertissement:

Cet appareil numérique de la classe B est conforme à la norme NMB-003 du Canada.

DDST Unit Type A / Type B Operating Instructions Printer / Scanner Reference



Free Manuals Download Website

<http://myh66.com>

<http://usermanuals.us>

<http://www.somanuals.com>

<http://www.4manuals.cc>

<http://www.manual-lib.com>

<http://www.404manual.com>

<http://www.luxmanual.com>

<http://aubethermostatmanual.com>

Golf course search by state

<http://golfingnear.com>

Email search by domain

<http://emailbydomain.com>

Auto manuals search

<http://auto.somanuals.com>

TV manuals search

<http://tv.somanuals.com>