Operating Instructions

Printer Reference



-
- 1** Getting Started
 - 2** Preparing the Machine
 - 3** Setting Up the Printer Driver
 - 4** Other Print Operations
 - 5** Printer Features
 - 6** Using the Document Server
 - 7** The Functions and Settings of the Machine
 - 8** Appendix

Read this manual carefully before you use this machine and keep it handy for future reference. For safe and correct use, be sure to read the Safety Information in the "General Settings Guide" before using the machine.

Introduction

This manual contains detailed instructions and notes on the operation and use of this machine. For your safety and benefit, read this manual carefully before using the machine. Keep this manual in a handy place for quick reference.

Important

Contents of this manual are subject to change without prior notice. In no event will the company be liable for direct, indirect, special, incidental, or consequential damages as a result of handling or operating the machine.

Do not copy or print any item for which reproduction is prohibited by law.

Copying or printing the following items is generally prohibited by local law:

bank notes, revenue stamps, bonds, stock certificates, bank drafts, checks, passports, driver's licenses.

The preceding list is meant as a guide only and is not inclusive. We assume no responsibility for its completeness or accuracy. If you have any questions concerning the legality of copying or printing certain items, consult with your legal advisor.

Warning

Use of controls or adjustment or performance of procedures other than those specified in this manual might result in hazardous radiation exposure.

Two kinds of size notation are employed in this manual. With this machine refer to the inch version.

Trademarks

Microsoft®, Windows® and Windows NT® are registered trademarks of Microsoft Corporation in the United States and/or other countries.

Adobe®, PostScript®, Acrobat®, PageMaker® and Adobe Type Manager are registered trademarks of Adobe Systems Incorporated.

PCL® is a registered trademark of Hewlett-Packard Company.

AppleTalk, Apple, Macintosh and Mac OS are registered trademarks of Apple Computer, Incorporated.

IPS-PRINT™ Printer Language Emulation Copyright© 2000, Oak Technology, Inc., All Rights Reserved.

UNIX is a registered trademark in the United States and other countries, licensed exclusively through X/Open Company Limited.

Bluetooth® is a registered trademark of Bluetooth-SIG Inc. worldwide.

Other product names used herein are for identification purposes only and might be trademarks of their respective companies. We disclaim any and all rights to those marks.

The proper names of the Windows operating systems are as follows:

- The product name of Windows® 95 is Microsoft® Windows® 95
- The product name of Windows® 98 is Microsoft® Windows® 98
- The product name of Windows® Me is Microsoft® Windows® Millennium Edition (Windows Me)
- The product name of Windows® 2000 are as follows:
 - Microsoft® Windows® 2000 Professional
 - Microsoft® Windows® 2000 Server
 - Microsoft® Windows® 2000 Advanced Server
- The product name of Windows® XP are as follows:
 - Microsoft® Windows® XP Home Edition
 - Microsoft® Windows® XP Professional
- The product names of Windows Server™ 2003 are as follows:
 - Microsoft® Windows Server™ 2003 Standard Edition
 - Microsoft® Windows Server™ 2003 Enterprise Edition
 - Microsoft® Windows Server™ 2003 Web Edition
- The product name of Windows NT® 4.0 are as follows:
 - Microsoft® Windows NT® Workstation 4.0
 - Microsoft® Windows NT® Server 4.0

Notes

Some illustrations in this manual might be slightly different from the machine.

Certain options might not be available in some countries. For details, please contact your local dealer.

Download from www.Somanuals.com. All Manuals Search And Download.

TABLE OF CONTENTS

Manuals for This Machine	1
How to Read This Manual	3

1. Getting Started

Control Panel	5
Display Panel	7
User Authentication	9
User Code Authentication (Using the Control Panel).....	9
User Code Authentication (Using a Printer Driver)	9
Login (Using the Control Panel)	9
Logoff (Using the Control Panel).....	10
Login (Using a Printer Driver).....	10
Connecting the Machine	11
Requirements.....	11
Connecting the machine to the host using a USB cable	11
Connecting the Machine to the host using the parallel cable/IEEE 1394 (SCSI print) cable ...	12
Connecting to the Ethernet Interface	13
Setting Paper on the Bypass Tray	14
Setting custom size paper.....	16
Setting thick paper or OHP transparencies.....	17

2. Preparing the Machine

Quick Install	19
Confirming the Connection Method	21
Network Connection	21
Local Connection	24
Using the SmartDeviceMonitor for Client Port	25
Installing SmartDeviceMonitor for Client	25
Installing the PCL or RPCS Printer Driver (TCP/IP).....	26
Installing the PCL or RPCS Printer Driver (NetBEUI)	28
Installing the PCL or RPCS Printer Driver (IPP)	30
Changing the Port Settings for SmartDeviceMonitor for Client	32
Using the Standard TCP/IP Port	34
Installing the PCL or RPCS Printer Driver.....	34
Using the LPR Port	36
Installing the PCL or RPCS Printer Driver.....	36
Using as the Windows Network Printer	38
Installing the PCL or RPCS Printer Driver.....	38
Using as the NetWare Print Server/Remote Printer	40
Form Feed.....	42
Banner Page	42
Printing after Resetting the Printer	42

Installing the Printer Driver Using USB	43
Windows 98 SE/Me - USB	43
Windows 2000 - USB	45
Windows XP, Windows Server 2003 - USB	46
Troubleshooting USB	47
Printing with Parallel Connection.....	48
Installing the PCL or RPCS Printer Driver.....	48
Installing the Printer Driver Using IEEE 1394 (SCSI print).....	50
Windows 2000.....	50
Windows XP, Windows Server 2003.....	52
Printing with Bluetooth Connection.....	54
Supported Profiles.....	54
Printing with Bluetooth Connection	54
If a Message Appears during Installation	57
Making Option Settings for the Printer	58
Conditions for Bidirectional Communication	58
If Bidirectional Communication is Disabled.....	60
Installing Font Manager 2000.....	61
Using Adobe PageMaker Version 6.0, 6.5, or 7.0	62

3. Setting Up the Printer Driver

PCL - Accessing the Printer Properties.....	63
Windows 95/98/Me - Accessing the Printer Properties	63
Windows 2000 - Accessing the Printer Properties	64
Windows XP, Windows Server 2003 - Accessing the Printer Properties	66
Windows NT 4.0 - Accessing the Printer Properties	68
RPCS - Accessing the Printer Properties.....	70
Windows 95/98/Me - Accessing the Printer Properties	70
Windows 2000 - Accessing the Printer Properties	72
Windows XP, Windows Server 2003 - Accessing the Printer Properties	74
Windows NT 4.0 - Accessing the Printer Properties	76

4. Other Print Operations

Printing a PDF File Directly	79
Printing Method	79
Using Locked & Sample Print Job List	80
Sample Print	82
Printing a Sample Print File.....	82
Deleting a Sample Print File.....	84
Checking the Error Log	84
Locked Print	86
Printing a Locked Print File	86
Deleting Locked Print Files	87
Checking the Error Log	88
Collate	89
Printing with the Finisher	91
Staple	92
Punch	96
Spool Printing	98
Covers	99
Slip Sheet	103
User Defined Pages	104
Form Feed	105
Print Using a Selected Tray	105
Canceling Form Feed.....	106
Canceling a Print Job	107
Windows - Canceling a Print Job	107

5. Printer Features

Printer Features Menu	109
Adjusting Printer Features	112
Printer Features Parameters	113
List / Test Print	113
Maintenance.....	115
System	115
Host Interface.....	118
PCL Menu	119
PS Menu	120
PDF Menu	121

6. Using the Document Server

Accessing the Document Server	123
--	------------

7. The Functions and Settings of the Machine

Mainframe	125
Functions.....	125
Interface	125
List of the Setting Items	126
Web Image Monitor.....	126
telnet	128
UNIX.....	128
Settings that can be used with PostScript 3.....	129

8. Appendix

Software and Utilities Included on the CD-ROM	131
Printer Drivers for This Printer.....	132
SmartDeviceMonitor for Admin	134
SmartDeviceMonitor for Client	135
Troubleshooting	137
Error & Status Messages on the Display Panel	137
Checking the Error Log	141
The Machine Does Not Print	142
Other Printing Problems.....	145
System Settings (Parallel Connection)	150
Precautions when using Windows Server 2003	151
Precautions when using the Terminal Server mode	151
Specifications	152
Options.....	154
INDEX	156

Manuals for This Machine

The following manuals describe the operational procedures of this machine. For particular functions, see the relevant parts of the manual.

Note

- Manuals provided are specific to machine type.
- Adobe Acrobat Reader/Adobe Reader is necessary to view the manuals as a PDF file.
- Two CD-ROMs are provided:
 - CD-ROM 1“Operating Instructions”
 - CD-ROM 2“Scanner Driver and Document Management Utility”

◆ **General Settings Guide**

Provides an overview of the machine and describes System Settings(such as Tray Paper Settings), Document Server functions and troubleshooting.

Refer to this manual for Address Book procedures such as registering fax numbers, e-mail addresses, and user codes.

◆ **Security Reference**

This manual is for administrators of this machine. It describes security functions that the administrators can use to protect data from being tampered, or prevent the machine from unauthorized use. Also refer to this manual for the procedures for registering administrators, as well as setting user and administrator authentication.

◆ **Network Guide (PDF file - CD-ROM1)**

Provides information about configuring and operating the printer in a network environment or using software. This manual covers all models, and therefore contains functions and settings that may not be available for your model.

Images, illustrations, functions, and supported operating systems may differ from those of your model.

◆ **Copy Reference**

Describes operations, functions, and troubleshooting for the machine’s copier function.

◆ **Facsimile Reference <Basic Features>**

Describes operations, functions, and troubleshooting for the machine's facsimile function.

◆ **Facsimile Reference <Advanced Features>**

Describes advanced facsimile functions such as line settings and procedures for registering IDs.

◆ **Printer Reference (this manual)**

Describes system settings, operations, functions, and troubleshooting for the machine’s printer function.

❖ **Scanner Reference (PDF file - CD-ROM1)**

Describes operations, functions, and troubleshooting for the machine's scanner function.

❖ **Manuals for DeskTopBinder Lite**

DeskTopBinder Lite is a utility included on the CD-ROM labeled "Scanner Driver and Document Management Utility".

- DeskTopBinder Lite Setup Guide (PDF file - CD-ROM2)
Describes installation of, and the operating environment for DeskTopBinder Lite in detail. This guide can be displayed from the **[Setup]** dialog box when DeskTopBinder Lite is installed.
- DeskTopBinder Introduction Guide (PDF file - CD-ROM2)
Describes operations of DeskTopBinder Lite and provides an overview of its functions. This guide is added to the **[Start]** menu when DeskTopBinder Lite is installed.
- Auto Document Link Guide (PDF file - CD-ROM2)
Describes operations and functions of Auto Document Link installed with DeskTopBinder Lite. This guide is added to the **[Start]** menu when DeskTopBinder Lite is installed.

❖ **Other manuals**

- PostScript 3 Supplement (PDF file - CD-ROM1)
- UNIX Supplement (available from an authorized dealer, or as a PDF file on our Web site)

How to Read This Manual

Symbols

In this manual, the following symbols are used:

WARNING:

This symbol indicates a potentially hazardous situation which, if instructions are not followed, could result in death or serious injury.

CAUTION:

This symbol indicates a potentially hazardous situation which, if instructions are not followed, may result in minor or moderate injury, or damage to property.

* The statements above are notes for your safety.

Important

If this instruction is not followed, paper might misfeed, originals might be damaged, or data might be lost. Be sure to read this.

Preparation

This symbol indicates prior knowledge or preparation is required before operation.

Note

This symbol indicates precautions for operation, or actions to take after mal-operation.

Limitation

This symbol indicates numerical limits, functions that cannot be used together, or conditions in which a particular function cannot be used.

Reference

This symbol indicates a reference.

[]

Keys and buttons that appear on the computer's display.

Keys that appear on the machine's display panel.

[]

Keys built into the machine's control panel.

Keys on the computer's keyboard.

1. Getting Started

Control Panel

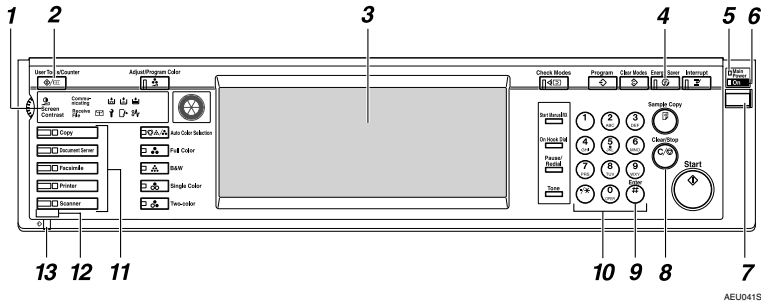

1. Indicators

Displays errors and machine status.

- : Add Staples indicator
 - : Add Toner indicator
 - : Load Paper indicator
 - : Service Call indicator
 - : Open Cover indicator
 - : Misfeed indicator
- See "Control Panel", *General Settings Guide*.

2. [User Tools/Counter] key

- User Tools
Press to change default settings and conditions to your requirements.
- Counter
Press to display or print the total number of copies made.

3. Display panel

Displays operation status, error messages, and function menus. See p.7 "Display Panel".

4. [Energy Saver] key

Press to switch to and from Energy Saver Mode.

Note

- This key is ineffective during System Settings (User Tools) operations.

5. Main power indicator

This indicator lights when the main power switch is turned on.

Important

- Do not turn off the main power switch while the **On** indicator is lit or blinking. Doing so may damage the hard disk.

6. On indicator

This indicator lights when the operation switch is turned on.

7. Operation switch

Press this switch to turn the power on (the **On** indicator goes on). To turn the power off, press this switch again (the **On** indicator goes off).

8. [Clear/Stop] key

Press to cancel the entered data.

9. [#] key

Press after entering a value.

10. Number keys

Press to enter a value for various settings.

11. Function keys

Press to switch between the "Copy", "Document Server", "Fax", "Printer", and "Scanner" screens.

The indicator for the selected function lights.

12. Function status indicators

These show the status of the above functions:

- Green: the function is active.
- Red: the function has been interrupted.

13. Data In indicator

The Data In indicator shows the status of data reception from a computer.

- This indicator blinks when data is being received.
- This indicator lights when there is data remaining to be printed.

Display Panel

This section describes configuration using the display panel when the printer function is selected.

Important

- The machine switches to offline when you make settings when the machine is online. After you complete the setting, the machine switches to online automatically.
- If you make a setting when the machine is offline, it will stay offline afterward.
- The function items displayed serve as selector keys. You can select or specify an item by pressing it lightly.
- When you select or specify an item on the display panel, it becomes highlighted.
- Keys dimmed (for example, **OK**) cannot be used.

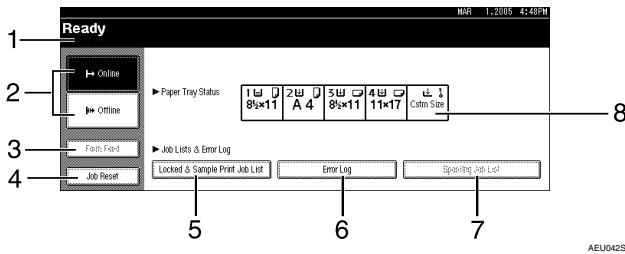

1. Operational status or messages

Displays current machine status, such as "Ready", "Offline", and "Printing...". Information about the print job (user ID and document name) appears in this section.

2. [**Online**] key / [**Offline**] key

When you press these keys, the machine switches between online and offline.

When the machine is online, it can receive data from the computer.

When the machine is offline, it cannot receive data from the computer.

3. [**Form Feed**] key

Press to print all the data left in the machine's input buffer.

Note

- When the machine is online, the status appears dimly.
- This function is not available with the RPCS printer language.

4. [**Job Reset**] key

Press to cancel the current print job.

If you press it when the machine is offline and Hex Dump is selected, Hex Dump is canceled.

5. [Locked & Sample Print Job List]

Press to display Locked/Sample Print jobs sent from a computer.

6. [Error Log]

Press to display the error logs, such as Locked/Sample Print jobs sent from a computer.

 **Note**

- When the power is turned on, the copier display is shown. This is a factory default. This initial setting can be changed. See “User Tools (System Settings)”, *General Settings Guide*.

7. [Spooling Job List]

Press to display spooled jobs.

8. [Paper Tray Status] key

The paper tray settings appear.

User Authentication

When user authentication (User Code Authentication, Basic Authentication, Windows Authentication, or LDAP Authentication) is set, the authentication screen is displayed. Unless a valid user name and password are entered, operations are not possible with the machine. Log on to operate the machine, and log off when you are finished operations. Be sure to log off to prevent unauthorized users from using the machine.

Note

- ❑ Consult the User Administrator about your login user name, password, and user code. For details about the various types of user authentication, consult the appropriate administrators.
- ❑ For user code authentication, enter a number that is registered in the Address Book as a login user name as the user code.

User Code Authentication (Using the Control Panel)

When user authentication is set, the following screen appears.



Enter a user code (eight digit), and then press [#].

User Code Authentication (Using a Printer Driver)

When user authentication is set, specify the user code in the printer properties of a printer driver. For details, see the printer driver Help.

Login (Using the Control Panel)

Follow the procedure below to log in when Basic Authentication, Windows Authentication, or LDAP Authentication is set.

- 1 Press [Enter] for [Login User Name].

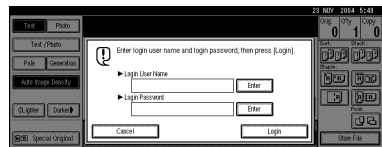

- 2 Enter a login user name, and then press [OK].
- 3 Press [Enter] for [Login Password].
- 4 Enter a login password, and then press [OK].
- 5 Press [Login].

When the user is authenticated, the screen for the function you are using appears.

Logoff (Using the Control Panel)

Follow the procedure below to log off when Basic Authentication, Windows Authentication, or LDAP Authentication is set.

1 Press **[User Tools/Counter]** key.

2 Press **[→ Logout]**.

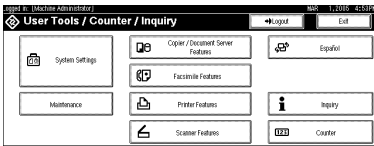

3 Press **[Yes]**.

4 Press **[User Tools/Counter]** key.

Login (Using a Printer Driver)

When Basic Authentication, Windows Authentication, or LDAP Authentication is set, make encryption settings in the printer properties of a printer driver, and then specify a login user name and password. For details, see the printer driver Help.

Note

- When logged on using a printer driver, logging off is not required.

Connecting the Machine

Reference

For information about connection using Ethernet and wireless LAN, see "Confirming the Connection", *Network Guide*.

For information about connection using Bluetooth, see the manual that comes with the optional Bluetooth interface unit.

Requirements

Before using this machine, make sure all environmental and electrical requirements are met. Connect the machine to the host computer using the parallel port, network interface unit, or both.

Make sure all cables, connectors, and electrical outlets necessary to attach the machine to the host computer or network are at hand.

Connecting the machine to the host using a USB cable

You can connect the machine to the host computer using a USB interface cable.

This machine does not come with a USB interface cable. Make sure you purchase the appropriate cable for the machine and your computer.

Follow the procedure below to connect the machine to the host computer using a USB interface cable.

- 1** Connect the USB 2.0 interface cable to the USB port on the right side of the machine.

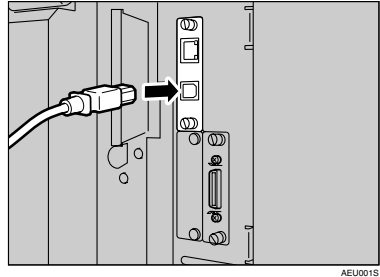

- 2** Connect the other end to the USB port on the host computer.

Note

- The USB 2.0 interface board is supported by Windows 98 SE/Me/2000/XP, Windows Server 2003, Mac OS X or higher.
 - For Windows 98 SE/Me: Make sure to install "USB Printing Support". If USB 2.0 is used with Windows 98 SE/Me, only a speed equal to that of USB 1.1 is possible.
 - For Mac OS: Mac OS supports only the standard USB port. If USB 2.0 is used with a Mac OS, only a speed equal to that of USB 1.1 is possible.

Connecting the Machine to the host using the parallel cable/IEEE 1394 (SCSI print) cable

Connect the machine to the host computer using the optional parallel board or optional IEEE 1394 interface board. This machine does not come with a parallel cable to connect the machine to the host computer.

The machine's parallel interface is a standard bidirectional interface. It requires a standard IEEE 1284 compliant 36-pin parallel cable and a parallel port on the host computer. Make sure you purchase the appropriate cable for the machine and your computer.

Note

- ❑ Do not use a parallel cable that is longer than 3 meters (10 feet).
- ❑ Rating voltage of the interface connector: Max. DC 5V

Follow the procedure below to connect the machine to the host computer using a parallel cable or IEEE 1394 interface cable.

Important

- ❑ Before connecting the machine and a computer using an interface cable, make sure the machine is not operating, and then turn off the main power switches of the machine and computer.
- ❑ Be sure to use a specified interface cable. Other cables may cause radio interference.

- 1 Turn off the main power switches of the machine and computer.

Important

- ❑ Before turning off the main power switch, see "Turning Off the Power", *General Settings Guide*.

- 2 Plug the cable into the connector on the machine's interface.

◆ Parallel Connection

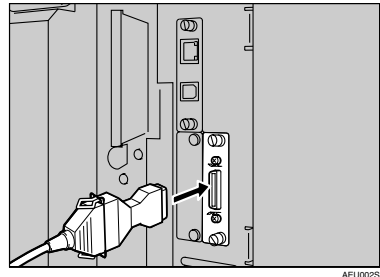

◆ IEEE 1394 (SCSI print) Connection

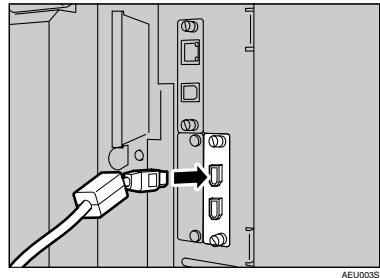

- 3 Plug the other end of the cable into the connector on the computer's interface.

- 4 Turn on the machine's main power switch.

5 Turn on the computer.**Note**

- When using Windows 95/98/Me/2000/XP and Windows Server 2003, a printer driver installation screen might appear when the computer is turned on. If this happens, click **[Cancel]** on the screen. For more information, see p.19 "Preparing the Machine".

The machine and computer are now connected. The printer driver must be installed next. For information about how to install the printer driver, see p.19 "Preparing the Machine".

Connecting to the Ethernet Interface

The network interface board supports 10 BASE-T or 100 BASE-TX connections.

Important

- Before making the connection, touch the metallic part to ground yourself.

- 1** A core for the Ethernet cable is supplied with this machine. The Ethernet cable loop should be about 15 cm (6 in.) (①) from the machine end of the cable.

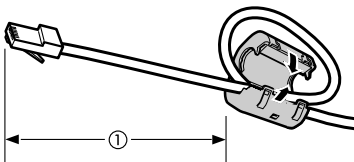

AEV047S

2 Turn off the main power switch.**Important**

- Make sure the main power is off. See "Turning On the Power", *General Settings Guide*.

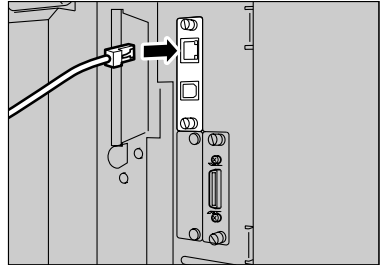
3 Connect the Ethernet cable to the 10 BASE-T / 100 BASE-TX port.

AEL040S

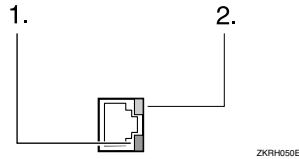
4 Turn on the main power switch.

ZKRH050E

1. Indicator (green)

Remains green when the machine is properly connected to the network.

2. Indicator (yellow)

Turns yellow when 100 BASE-TX is operating. Turns off when 10 BASE-T is operating.

Setting Paper on the Bypass Tray

This section gives instructions for setting paper on the bypass tray. Use the bypass tray to print onto OHP transparencies, labels, thick paper, and envelopes that cannot be loaded in the paper tray.

Reference

For details about setting paper in the regular paper tray, see *General Settings Guide*.

Note

- ❑ When loading letterhead paper, pay attention to its orientation. See "Orientation-Fixed Paper or Two-Sided Paper", *General Settings Guide*.
- ❑ Paper within the following dimensions can be set in the bypass tray:
 - Vertical: 90 - 305 mm (3.6 - 12 in.)
 - Horizontal: 148 - 600 mm (5.9 - 23.6 in.)
- ❑ Be sure to set the paper with the side you want to print facing down in the bypass tray.
- ❑ When loading OHP transparencies or thick paper in the bypass tray, make the paper setting using the control panel or printer driver.
- ❑ The number of sheets that can be loaded in the bypass tray depends on the paper type.
- ❑ Paper sizes fed from the bypass tray are output first sheet down, print side-up.

Limitation

- ❑ The following functions are disabled when printing from the bypass tray:
 - Duplex printing
 - Auto Tray Select
 - Auto Tray Switching
 - Rotating Collate
 - Staple (when the optional unit is installed)
 - Punch (when the optional unit is installed)

Important

- ❑ When printing using the printer function, original images are always rotated by 180 degrees (the orientation of images to be printed is opposite to that of the copier function). When printing onto paper with specific orientation requirements, such as envelopes and letterheads, make sure to rotate the paper feed orientation to 180 degrees.
- ❑ Be sure to set the paper size using the printer driver when printing data from the computer. The paper size set using the printer driver has priority over the one set using the display panel.

1 Open the bypass tray.

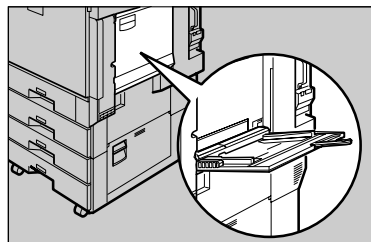

AEU0045

2 Adjust the paper guides to the paper size.

Important

- ❑ If the paper guides are not flush against the paper, skewing and misfeeds might occur.

3 Gently insert paper face up into the bypass tray until the beeper sounds.

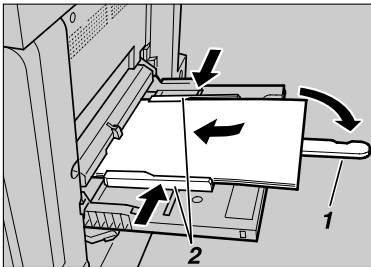

AEU011S

1. Extender

2. Paper guides

Note

- ❑ The beeper will not sound if it is turned off. Gently insert paper until it stops.
- ❑ Do not stack paper over the limit mark, otherwise a skewed image or misfeeds might occur.
- ❑ Open out the extender to support paper sizes larger than A4 , 8¹/₂"×11" .
- ❑ Fan the paper to get air between the sheets to avoid a multi-sheet feed.
- ❑ When setting an OHP transparency, make sure that its front and back sides are properly positioned.
- ❑ Select paper type when printing onto OHP transparencies or thick paper (over 127.9 g/m²). For details, see p.17 "Setting thick paper or OHP transparencies".

4 Select the paper size.

Note

- ❑ You can set paper size using the printer driver. The following procedures are not necessary when setting paper size using the printer driver.
- ❑ The paper size set using the printer driver has priority over that set using the display panel.
- ❑ When the printer driver is not used, make settings using the display panel.
- ❑ Thick paper and OHP transparencies are delivered face up on the top of the preceding page; therefore, the prints need to be rearranged into the correct order. To avoid this, select **[Reverse order print]** in the RPCS printer driver settings to deliver the prints in the correct page order.

Reference

For printer driver settings, see the printer driver Help.

For details about setting custom sizes, see p.16 "Setting custom size paper".

1 Press the **[User Tools/Counter]** key on the control panel.

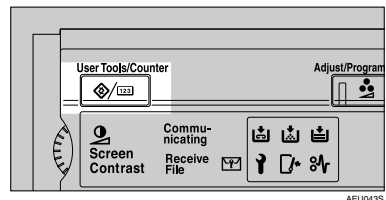

AEU043S

2 Press **[System Settings]**.

3 Press the [Tray Paper Settings] tab.

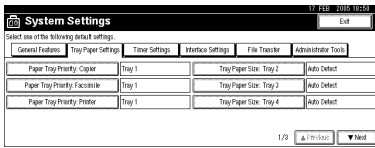

4 Press [▼Next] to scroll through the list.

5 Press [Printer Bypass Paper Size].

6 Select the paper size.

Note

- Press [▲Previous] or [▼Next] to scroll through the list.
- When printing onto thick paper or OHP transparencies, select paper type. For details, see p.17 "Setting thick paper or OHP transparencies".

7 Press [OK].

8 Press the [User Tools/Counter] key.

Setting custom size paper

Note

- Custom sizes can also be set using the printer driver. The following procedures are not necessary when setting custom sizes using the printer driver.
- Custom size settings set using the printer driver have priority over those set using the machine's display panel.
- When the printer driver is not used, make settings using the display panel.

Reference

For printer driver settings, see the printer driver Help.

1 Press the [User Tools/Counter] key on the control panel.

2 Press [System Settings].

3 Press the [Tray Paper Settings] tab.

4 Press [▼Next] to scroll through the list.

5 Press [Printer Bypass Paper Size].

6 Press [Custom Size].

If a custom size is already set, press [Change Size].

7 Press [Vertical].

8 Enter the vertical size of the paper using the number keys, and then press [#].

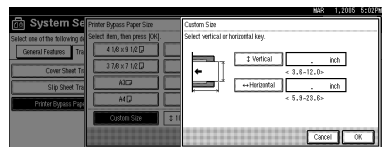

9 Press [Horizontal].

10 Enter the horizontal size of the paper using the number keys, and then press [#].

11 Press [OK].

The paper sizes entered are displayed.

12 Press [OK].

13 Press the [User Tools/Counter] key.

Setting thick paper or OHP transparencies

Note

- ❑ Paper settings can also be set using the printer driver. The following procedures are not necessary when setting paper sizes using the printer driver.
- ❑ Paper size settings set using the printer driver have priority over those set using the machine's display panel.
- ❑ When the printer driver is not used, make settings using the display panel.

Reference

For printer driver settings, see the printer driver Help.

- 1 Press the **[User Tools/Counter]** key on the control panel.
- 2 Press **[System Settings]**.
- 3 Press the **[Tray Paper Settings]** tab.
- 4 Press **[▼Next]** to scroll through the list.
- 5 Press **[Paper Type: Bypass tray]**.

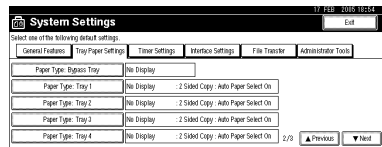

- 6 Select **[OHP]** or **[Thick Paper]**
- 7 Press **[OK]**.
The paper type selected is displayed.
- 8 Press the **[User Tools/Counter]** key.

Note

- ❑ The settings made will remain valid until they are reset again. After printing on OHP transparencies or thick paper, make sure to clear settings for the next user.

2. Preparing the Machine

Quick Install

Windows 95/98/Me/2000/XP, Windows Server 2003, and Windows NT 4.0 users can easily install this software using the CD-ROM provided.

Using Quick Install, the PCL printer driver and/or RPCS printer driver and SmartDeviceMonitor for Client is installed under network environment, and TCP/IP port will be set.

Important

- To install printer driver under Windows 2000/XP Professional, Windows Server 2003, and Windows NT 4.0, you must have an account that has Manage Printers permission. Log on as an Administrator.
- The Quick Install is not available when using this printer under USB connection. If you connect using USB, refer to p.43 "Installing the Printer Driver Using USB".

1 Quit all applications currently running.

2 Insert the CD-ROM into the CD-ROM drive.

The installer starts.

Auto Run may not work with certain operating system settings. If this happens, launch "Setup.exe" on the CD-ROM root directory.

3 Select an interface language, and then click [OK].

The default interface language is English.

4 Click [Quick Install].

The software license agreement appears in the [License Agreement] dialog box.

5 After reading the agreement, click [I accept the agreement] , and then click [Next >].

6 Select the machine model you want to use in the [Select Printer] dialog box.

For network connection via TCP/IP, select the machine whose IP address is displayed in [Connect To].

For parallel connection, select the machine whose printer port is displayed in [Connect To].

7 Click [Install].

The printer driver installation starts.

8 Click **[Finish]**

A message about restarting the computer may appear. Restart the computer to complete installation.

9 Click **[Exit]** in the first dialog box of the installer, and then take out the CD-ROM.

 **Note**

- To stop installation of the selected software, click **[Cancel]** before installation is complete.
- Auto Run may not work with certain operating system settings. If this happens, launch "Setup.exe" on the CD-ROM root directory.
- Select a machine to whose IP address is displayed in **[Connect To]** to install SmartDeviceMonitor for Client when using TCP/IP.

 **Reference**

Quick Install is not available unless bidirectional communication between the machine and computer is enabled via parallel connection. See p.60 "If Bidirectional Communication is Disabled" for details about bidirectional communication between machine and computer.

Confirming the Connection Method

This machine supports network and local connection.

Before installing the printer driver, check how the machine is connected. Follow the driver installation procedure that is appropriate to the connection method.

Network Connection

This machine can be used as a Windows printing port or network printer.

Using this machine as the Windows printing port

Network connections can be established through Ethernet, IEEE 802.11b, and IEEE 1394 (IP over 1394).

Available ports are determined based on the combination of Windows operating system version and connection method used.

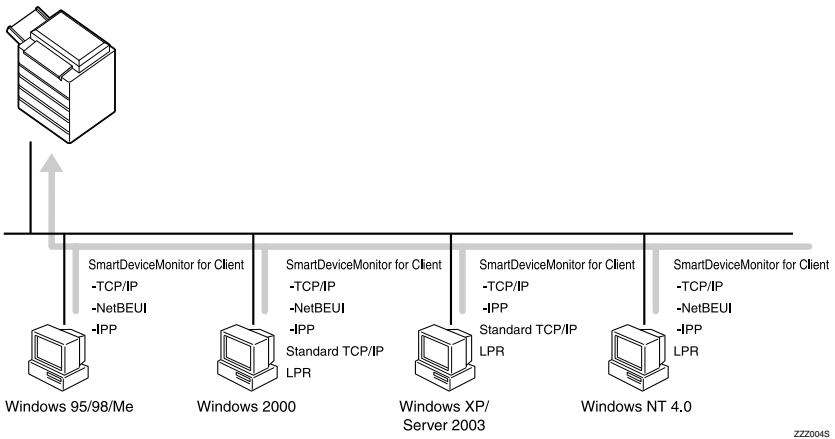

◆ Windows 95/98

Connection Method	Available Ports
Ethernet/ IEEE 802.11b	SmartDeviceMonitor for Client port
IEEE 1394 (IP over 1394)	None

◆ Windows Me

Connection Method	Available Ports
Ethernet/ IEEE 802.11b	SmartDeviceMonitor for Client port
IEEE 1394 (IP over 1394)	SmartDeviceMonitor for Client port

❖ **Windows 2000**

Connection Method	Available Ports
Ethernet/ IEEE 802.11b	SmartDeviceMonitor for Client port Standard TCP/IP LPR port
IEEE 1394 (IP over 1394)	None

❖ **Windows XP**

Connection Method	Available Ports
Ethernet/ IEEE 802.11b	SmartDeviceMonitor for Client port Standard TCP/IP LPR port
IEEE 1394 (IP over 1394)	SmartDeviceMonitor for Client port Standard TCP/IP

❖ **Windows Server 2003**

Connection Method	Available Ports
Ethernet/ IEEE 802.11b	SmartDeviceMonitor for Client port Standard TCP/IP LPR port
IEEE 1394 (IP over 1394)	SmartDeviceMonitor for Client port Standard TCP/IP

❖ **Windows NT 4.0**

Connection Method	Available Ports
Ethernet/ IEEE 802.11b	SmartDeviceMonitor for Client port LPR port
IEEE 1394 (IP over 1394)	None

🔍 **Reference**

See the explanation of how to install the printer driver for each type of port. For the SmartDeviceMonitor for Client port, see p.25 “Using the SmartDeviceMonitor for Client Port”.

For the Standard TCP/IP port, see p.34 “Using the Standard TCP/IP Port”.

For the LPR port, see p.36 “Using the LPR Port”.

Using as a network printer

This machine can be used as the Windows network printer, the NetWare print server, or the NetWare remote printer.

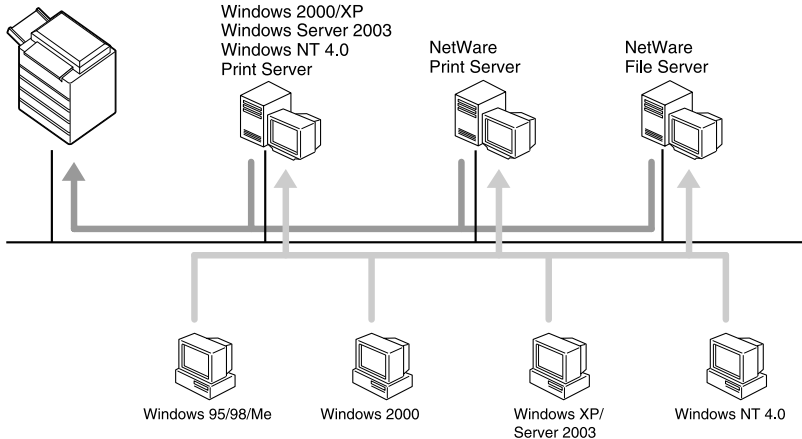

Reference

See the explanation of how to install the printer driver for each type of network printer.

For the Windows network printer, see p.38 "Using as the Windows Network Printer".

For the NetWare print server and remote printer, see p.40 "Using as the NetWare Print Server/Remote Printer".

Local Connection

Local connections can be established via parallel, USB, IEEE 1394 (SCSI print), and Bluetooth connections.

Windows operating system version determines the available connection methods.

- Windows 95:
 - Parallel connections
- Windows 98:
 - Parallel connections
- Windows 98 SE/Me:
 - USB, Parallel, and Bluetooth connections
- Windows 2000:
 - USB, Parallel, IEEE 1394 (SCSI print), and Bluetooth connections
- Windows XP:
 - USB, Parallel, IEEE 1394 (SCSI print), and Bluetooth connections
- Windows Server 2003:
 - USB, Parallel, IEEE 1394 (SCSI print), and Bluetooth connections
- Windows NT 4.0:
 - Parallel connections

Reference

See the explanation of how to install the printer driver for each method of connection.

For the USB connection, see p.43 “Installing the Printer Driver Using USB”.

For the parallel connection, see p.48 “Printing with Parallel Connection”.

For the IEEE 1394 (SCSI print) connection, see p.50 “Installing the Printer Driver Using IEEE 1394 (SCSI print)”.

For the Bluetooth connection, see p.54 “Printing with Bluetooth Connection”.

Using the SmartDeviceMonitor for Client Port

Installing SmartDeviceMonitor for Client

Important

- To install SmartDeviceMonitor for Client under Windows 2000/XP Professional, Windows Server 2003, and Windows NT 4.0, you must have an account that has Manage Printers permission. Log on as an Administrator.
- Install SmartDeviceMonitor for Client before installing the printer driver when using the SmartDeviceMonitor for Client port.

1 Quit all applications currently running.

2 Insert the CD-ROM into the CD-ROM drive.

The installer starts.

Auto Run may not work with certain operating system settings. If this happens, launch "Setup.exe" on the CD-ROM root directory.

3 Select an interface language, and then click [OK].

The default interface language is English.

4 Click [SmartDeviceMonitor for Client/Admin].

5 The SmartDeviceMonitor for Client installer starts.

6 The software license agreement appears in the [License Agreement] dialog box. After reading through its contents, click [I accept the agreement], and then click [Next >].

7 Click [SmartDeviceMonitor for Client], and then click [Next >].

The SmartDeviceMonitor for Client installer starts.

8 Follow the instructions on the display to install SmartDeviceMonitor for Client.

9 Click [Finish].

If you are required to restart the computer after installing SmartDeviceMonitor for Client, restart the computer.

Note

- To stop installation of the selected software, click [Cancel] before installation is complete.

Installing the PCL or RPCS Printer Driver (TCP/IP)

Important

- To install this printer driver under Windows 2000/XP Professional, Windows Server 2003, and Windows NT 4.0, you must have an account that has Manage Printers permission. Log on as an Administrators or Power Users group member.

1 Quit all applications currently running.

2 Insert the CD-ROM into the CD-ROM drive.

The installer starts.

Auto Run may not work with certain operating system settings. If this happens, launch "Setup.exe" on the CD-ROM root directory.

3 Select an interface language, and then click [OK].

The default interface language is English.

4 Click [PCL/RPCS Printer Drivers].

5 The software license agreement appears in the [License Agreement] dialog box.

After reading the agreement, click [I accept the agreement], and then click [Next].

6 Select the printer driver you want to use in the [Select Program] dialog box.

You can select several printer drivers.

7 Select the machine model you want to use.

The printer name can be changed in the [Change settings for 'Printer Name'] box.

8 Double-click the printer name to display the printer settings.

Note

- The details shown in [Comment:], [Driver:], and [Port:] vary depending on the operating system, printer model, and port.

9 Click [Port:], and then click [Add].

10 Click [SmartDeviceMonitor], and then click [New Port...].

11 Click [TCP/IP], and then click [Search].

A list of printers using TCP/IP appears.

12 Select the printer you want to use, and then click **[OK]**.

Only printers that respond to a broadcast from the computer appear. To use a machine not listed here, click **[Specify Address]**, and then enter the IP address or host name of the machine.

Under Windows 95/98/Me, you cannot add an IP address partially similar to the one already used. For example, if "192.168.0.2" is in use, "192.168.0.2xx" cannot be used. Similarly, if "192.168.0.20" is in use, "192.168.0.2" cannot be used.

13 Check that the port of the selected printer is displayed in **[Port:]**.**14** Set a user code, if necessary.

This allows a SmartDeviceMonitor for Admin user to display and check statistics about the number of sheets which each user prints. For details, see SmartDeviceMonitor for Admin Help.

Up to 8 numeric characters can be entered. Neither alphabetic characters nor symbols are available.

15 Select the **[Default Printer]** check box to configure the printer as default.**16** Click **[Finish]**.

Installation starts.

17 Click **[Finish]** in the installation completion dialog box.

A message about restarting the computer may appear. Restart the computer to complete installation

 **Reference**

A message appears if there is a newer version of the printer driver already installed. If there is, you cannot install the printer driver using Auto Run. If you still want to install the printer driver, install use **[Add Printer]**. See p.57 "If a Message Appears during Installation".

Installing the PCL or RPCS Printer Driver (NetBEUI)

Important

- To install this printer driver under Windows 2000, and Windows NT 4.0, you must have an account that has Manage Printers permission. Log on as an Administrator or Power Users group member.
- Windows XP and Windows Server 2003 do not support NetBEUI.
- You cannot print using printers beyond routers.

1 Quit all applications currently running.

2 Insert the CD-ROM into the CD-ROM drive.

The installer starts.

Auto Run may not work with certain operating system settings. If this happens, launch "Setup.exe" on the CD-ROM root directory.

3 Select an interface language, and then click [OK].

The default interface language is English.

4 Click [PCL/RPCS Printer Drivers].

5 The software license agreement appears in the [License Agreement] dialog box.

After reading the agreement, click [I accept the agreement], and then click [Next].

6 Select the printer driver you want to use in the [Select Program] dialog box.

You can select several printer drivers.

7 Select the machine model you want to use.

The printer name can be changed in the [Change settings for 'Printer Name'] box.

8 Double-click the printer name to display the printer settings.

Note

- The details shown in [Comment:], [Driver:], and [Port:] vary depending on the operating system, printer model, and port.

9 Click [Port:], and then click [Add].

10 Click [SmartDeviceMonitor], and then click [New Port...].

11 Click [NetBEUI], and then click [Search].

A list of printers using NetBEUI appears.

12 Select the printer you want to use, and then click [OK].

Only printers that respond to a broadcast from the computer appear. To use a machine not listed here, click **[Specify Address]**, and then enter the NetBEUI address. The NetBEUI address can be checked with the configuration page. For information about printing a configuration page, see p.113 "Printing the configuration page". The NetBEUI address appears in the format of "\\RNPxxxx\xxx" on the configuration page. Enter the machine's network path in the format of "%Computer name\Share name". Use "\\" instead of "%%" at the beginning.

13 Check that the port of the selected printer is displayed in [Port:].**14 Set a user code, if necessary.**

This allows a SmartDeviceMonitor for Admin user to display and check statistics about the number of sheets which each user prints. For details, see SmartDeviceMonitor for Admin Help.

Up to 8 numeric characters can be entered. Neither alphabetic characters nor symbols are available.

15 Select the [Default Printer] check box to configure the printer as default.**16 Click [Finish].**

The printer driver installation starts.

17 Click [Finish] in the installation completion dialog box.

A message about restarting the computer may appear. Restart the computer to complete installation.

Note

- The protocol is set to inactive as default. Enable it using Web Image Monitor or Telnet
- To stop installation of the selected software, click **[Cancel]** before installation is complete.

Reference

A message appears if there is a newer version of the printer driver already installed. If there is, you cannot install the printer driver using Auto Run. If you still want to install the printer driver, use **[Add Printer]**. See p.57 "If a Message Appears during Installation".

Installing the PCL or RPCS Printer Driver (IPP)

Important

- To install printer driver under Windows 2000/XP Professional, Windows Server 2003, and Windows NT 4.0, you must have an account that has Manage Printers permission. For this, log on as an Administrators or Power Users group member.

1 Quit all applications currently running.

2 Insert the CD-ROM into the CD-ROM drive.

The installer starts.

Auto Run may not work with certain operating system settings. If this happens, launch "Setup.exe" on the CD-ROM root directory.

3 Select an interface language, and then click [OK].

The default interface language is English.

4 Click [PCL/RPCS Printer Drivers].

5 The software license agreement appears in the [License Agreement] dialog box.

After reading the agreement, click [I accept the agreement] , and then click [Next].

6 Select a printer driver you want to use in the [Select Program] dialog box.

You can select several printer drivers.

7 Select the machine model you want to use.

The printer name can be changed in the [Change settings for 'Printer Name'] box.

8 Double-click the printer name to display the printer settings.

Note

- The details shown in [Comment:], [Driver:], and [Port:] vary depending on the operating system, printer model, and port.

9 Click [Port:], and then click [Add].

10 Click [SmartDeviceMonitor], and then click [New Port...].

11 Click [IPP].

- 12** In the **[Printer URL]** box, enter “http://printer's address/printer” as the printer's address.

If the server authentication is issued, to enable SSL (a protocol for encrypted communication), enter “https://printer's address/printer” (Internet Explorer 5.01, or a higher version must be installed).

(example IP address: 192.168.15.16)

http://192.168.15.16/printer

https://192.168.15.16/printer

You can enter “http://printer's address/ipp” as the printer's address.

- 13** Enter a name for identifying the printer in **[IPP Port Name]**. Use a name different from the one of any existing port.

If a name is not specified here, the address entered in the **[Printer URL]** box becomes the IPP port name.

- 14** Click **[Detailed Settings]** to make necessary settings.

For information about the settings, see SmartDeviceMonitor for Client Help.

- 15** Check that the port of the selected printer is displayed in **[Port:]**.

- 16** Set a user code, if necessary.

This allows a SmartDeviceMonitor for Admin user to display and check the number of sheets each user prints. For details, see SmartDeviceMonitor for Admin Help.

Up to 8 numeric characters can be entered. No alphabetic characters or symbols can be entered.

- 17** Select the **[Default Printer]** check box to configure the printer as default.

- 18** Click **[Finish]**.

Installation starts.

- 19** Click **[Finish]** in the installation completion dialog box.

A message about restarting the computer may appear. Restart the computer to complete installation

 **Note**

- To stop installation of the selected software, click **[Cancel]** before installation is complete.

 **Reference**

A message appears if there is a newer version of the printer driver already installed. If there is, you cannot install the printer driver using Auto Run. If you still want to install the printer driver, use **[Add Printer]**. See p.57 “If a Message Appears during Installation”.

Changing the Port Settings for SmartDeviceMonitor for Client

Follow the procedure below to change the SmartDeviceMonitor for Client settings, such as TCP/IP timeout, recovery/parallel printing, and printer groups.

 **Note**

- There are no settings for NetBEUI protocol.

Windows 95/98:

- 1** Open [Printers] window from [Start] menu. .
- 2** In the [Printers] window, click the icon of the printer you want to use. On the [File] menu, click [Properties].
- 3** Click the [Details] tab, and then click [Configure Port].
The [Port Settings] dialog box appears.

Windows 2000 / Windows NT 4.0:

- 1** Open [Printers] window from [Start] menu. .
- 2** In the [Printers] window, click the icon of the printer you want to use. On the [File] menu, click [Properties].
- 3** On the [Ports] tab, click [Configure Port].
The [Port Settings] dialog box appears.

Windows XP, Windows Server 2003:

1 Open the **[Printers and Faxes]** window from the **[Start]** menu.

The **[Printers and Faxes]** window appears.

2 Click the icon of the machine you want to use. On the **[File]** menu, click **[Properties]**. The printer properties appear.

3 Click the **[Ports]** tab, and then click **[Configure Port]**.

The **[Port Configuration]** dialog box appears.

- For TCP/IP, timeout setting can be configured.

 **Note**

- If no settings on the **[Recovery/Parallel Printing]** tab are available, follow the procedure below.

① Click **[Cancel]** to close the **[Port Configuration:]** dialog box.

② Start SmartDeviceMonitor for Client, and then right-click the SmartDeviceMonitor for Client icon on the taskbar.

③ Click **[Extended Features Settings]**, and then select the **[Set Recovery/Parallel Printing for each port]** check box.

④ Click **[OK]** to close the **[Extended Features Settings]** dialog box

- User, proxy, and timeout settings can be configured for IPP.

 **Reference**

For information about these settings, see “Using SmartDeviceMonitor for Client”, Network Guide, or SmartDeviceMonitor for Client Help.

Using the Standard TCP/IP Port

Installing the PCL or RPCS Printer Driver

Important

- To install printer driver under Windows 2000/XP Professional, and Windows Server 2003, you must have an account that has Manage Printers permission. Log on as an Administrators or Power Users group member.

1 Quit all applications currently running.

2 Insert the CD-ROM into the CD-ROM drive.

The installer starts.

Auto Run may not work with certain operating system settings. If this happens, launch "Setup.exe" on the CD-ROM root directory.

3 Select an interface language, and then click [OK].

The default interface language is English.

4 Click [PCL/RPCS Printer Drivers].

5 The software license agreement appears in the [License Agreement] dialog box.

After reading the agreement, click [I accept the agreement], and then click [Next].

6 Select a printer driver you want to use in the [Select Program] dialog box.

You can select several printer drivers.

7 Select the machine model you want to use.

The printer name can be changed in the [Change settings for 'Printer Name'] box.

8 Double-click the printer name to display the printer settings.

Note

- The details shown in [Comment:], [Driver:], and [Port:] vary depending on the operating system, printer model, and port.

9 Click [Port:], and then click [Add].

10 Click [Standard TCP/IP], and then click [New Port...].

Configure the Standard TCP/IP port settings, and then see Windows Help if [Standard TCP/IP Port] does not appear.

11 Click [Next] in the [Add Standard TCP/IP Printer Port Wizard] dialog box.

12 Enter the printer name or IP address in the **[Printer Name or IP Address]** box.

The **[Port Name]** text box automatically obtains a port name. Change this name if necessary.

When screen for Device selection appears, select "RICOH NetworkPrinter Driver C Model".

13 Click **[Finish]** in the **[Add Standard TCP/IP Printer Port Wizard]** dialog box.

The installation start dialog box reappears.

14 Check that the port of the selected printer is displayed in **[Port:]**.**15** Configure the default printer as necessary.**16** Click **[Finish]**.

The printer driver installation starts.

17 Click **[Finish]** in the installation completion dialog box.

A message about restarting the computer may appear. Restart the computer to complete installation.

 **Note**

- To stop installation of the selected software, click **[Cancel]** before installation is complete.

 **Reference**

A message appears if there is a newer version of the printer driver already installed. If there is, you cannot install the printer driver using Auto Run. If you still want to install the printer driver, use **[Add Printer]**. See p.57 "If a Message Appears during Installation".

Using the LPR Port

Installing the PCL or RPCS Printer Driver

Important

- To install this printer driver under Windows 2000/XP Professional, Windows Server 2003, and Windows NT 4.0, you must have an account that has Manage Printers permission. Log on as an Administrators or Power Users group member.

1 Quit all applications currently running.

2 Insert the CD-ROM into the CD-ROM drive.

The installer starts.

Auto Run may not work with certain operating system settings. If this happens, launch "Setup.exe" on the CD-ROM root directory.

3 Select an interface language, and then click [OK].

The default interface language is English.

4 Click [PCL/RPCS Printer Drivers].

5 The software license agreement appears in the [License Agreement] dialog box.

After reading the agreement, click [I accept the agreement], and then click [Next].

6 Select a printer driver you want to use in the [Select Program] dialog box.

You can select several printer drivers.

7 Select the machine model you want to use.

The printer name can be changed in the [Change settings for 'Printer Name'] box.

8 Double-click the printer name to display the printer settings.

Note

- The details shown in [Comment:], [Driver:], and [Port:] vary depending on the operating system, printer model, and port.

9 Click [Port:], and then click [Add].

10 Click [LPR Port], and then click [New Port...].

If [LPR Port] does not appear, see Windows Help and install it.

11 Enter the printer's IP address in the [Name or address of server providing lpd] box.

- 12 Enter "lp" in the [Name of printer or print queue on that server] box, and then click [OK].

The port is added.

- 13 Check that the port of the selected printer is displayed in [Port:].

- 14 Configure the default printer as necessary.

- 15 Click [Finish].

The printer driver installation starts

- 16 Click [Finish] in the installation completion dialog box.

A message about restarting the computer may appear. Restart the computer to complete installation.

Reference

A message appears if there is a newer version of the printer driver already installed. If there is, you cannot install the printer driver using Auto Run. If you still want to install the printer driver, use [Add Printer]. See p.57 "If a Message Appears during Installation".

Using as the Windows Network Printer

Installing the PCL or RPCS Printer Driver

2

To use the print server, install the printer driver by selecting "Network printer server", and then select the Windows 2000/XP, Windows Server 2003, or Windows NT 4.0 shared printer.

This section assumes that the client has already been configured to communicate with a Windows 2000/XP, Windows Server 2003, or Windows NT 4.0 print server. Do not begin the following procedure before the client is set up and configured correctly.

Important

- To install printer driver under Windows 2000/XP Professional, Windows Server 2003, and Windows NT 4.0, you must have an account that has Manage Printers permission. For this, log on as an Administrators or Power Users group member.
- If you print with a print server connected to the printer using the SmartDeviceMonitor port, Recovery Printing and Parallel Printing cannot be used from the client.
- If you print with a Windows XP or Windows Server 2003 print server, notification functions of SmartDeviceMonitor may not be used with the client.
- If you print with a Windows NT 4.0 print server, install the printer driver before you connect the print server to the printer.

1 Quit all applications currently running.

2 Insert the CD-ROM into the CD-ROM drive.

The installer starts.

Auto Run may not work with certain operating system settings. If this happens, launch "Setup.exe" on the CD-ROM root directory.

3 Select an interface language, and then click [OK].

The default interface language is English.

4 Click [PCL/RPCS Printer Drivers].

5 The software license agreement appears in the [License Agreement] dialog box.

After reading the agreement, click [I accept the agreement], and then click [Next].

6 Select a printer driver you want to use in the [Select Program] dialog box.

You can select several printer drivers.

- 7** Select the **[Printer Name]** check box to select the printer models you want to use.

The printer name can be changed in the **[Change settings for 'Printer Name']** box.

- 8** Double-click the printer name to display the printer settings.

The details shown in **[Comment:]**, **[Driver:]**, and **[Port:]** vary depending on the operating system, printer model, and port.

- 9** Click **[Port:]**, and then click **[Add]**.

- 10** Click **[Network Printer]**, and then click **[OK]**.

- 11** Double-click the computer name you want to use as a print server in the **[Browse for Printer]** window.

- 12** Select the printer you want to use, and then click **[OK]**.

- 13** Check that the port of the selected printer is displayed in **[Port:]**.

- 14** Configure the user code as necessary.

For an RPCS printer driver, a user code can be set after the printer driver installation. For information about user code, see the printer driver Help.

- 15** Select the **[Default Printer]** check box to configure the printer as default.

- 16** Click **[Finish]**.

The printer driver installation starts.

- 17** Click **[Finish]** in the installation completion dialog box.

A message about restarting the computer may appear. Restart the computer to complete installation.

Reference

A message appears if there is a newer version of the printer driver already installed. If there is, you cannot install the printer driver using Auto Run. If you still want to install the printer driver, use **[Add Printer]**. See p.57 "If a Message Appears during Installation".

Using as the NetWare Print Server/Remote Printer

This explains how to set up the Windows computer used as the NetWare client.

Important

- ❑ To install this printer driver under Windows 2000/XP Professional, Windows Server 2003, and Windows NT 4.0, you must have an account that has Manage Printers permission. Log on as an Administrators or Power Users group member.

The following explanation assumes NetWare Client is installed on the client computer and the NetWare server environment is correctly set up. Install all necessary client applications before following this procedure.

Set up the printer driver while logging on to the NetWare file server.

The following values are used in the example:

- Operating system: Windows 98
- NetWare version: 4.1
- File server name: CAREE
- Queue name: R-QUEUE

1 Insert the CD-ROM into the CD-ROM drive.

The installer starts.

Auto Run may not work with certain operating system settings. If this happens, launch "Setup.exe" on the CD-ROM root directory

2 Select an interface language, and then click [OK].

The default interface language is English.

3 Click [PCL/RPCS Printer Drivers].

4 The software license agreement appears in the [License Agreement] dialog box.

After reading the agreement, click [I accept the agreement], and then click [Next].

5 Select the printer driver you want to use in the [Select Program] dialog box.

You can select several printer drivers.

6 Select the [Printer Name] check box to select the printer models you want to use.

The printer name can be changed in the [Change settings for 'Printer Name'] box.

7 Double-click the printer name to display the printer settings.

The details shown in [Comment:], [Driver:], and [Port:] vary depending on the operating system, printer model, and port.

- 8** Click **[Port:]**, and then click **[Add]**.
- 9** Click **[Network Printer]**, and then click **[OK]**.
- 10** Double-click the name of the NetWare file server on the network tree.
The created queue is displayed.
- 11** Select the print queue, and then click **[OK]**.
- 12** Check that the port of the selected printer is displayed in **[Port:]**.
- 13** Click **[Finish]**.
The printer driver installation starts.
- 14** Click **[Finish]** in the **[Component selection]** dialog box.
- 15** Click **[Finish]** in the **[Introduction complete]** dialog box.
- 16** In the **[Printers]** window, open the printer properties.
Under Windows XP or Windows Server 2003, open the printer properties from the **[Printers and Faxes]** window.
- 17** On the **[Printer Settings]** tab, clear the **[Form Feed]** and **[Enable Banner]** check boxes.
Under Windows 2000/XP, Windows Server 2003, or Windows NT 4.0, click the **[NetWare setting]** tab.
Do not select these check boxes since they are automatically selected by the printer driver. If you select the check boxes, the printer may not print correctly.
- 18** Click **[OK]** to close the printer properties dialog box.

 **Note**

- The protocol is set to inactive as default. Enable it using Web Image Monitor or Telnet

Form Feed

Do not use NetWare to configure form feed. Form feed is controlled by the printer driver on Windows. If NetWare form feed is configured, the printer may not print properly.

Follow the procedure below to disable form feed according to the operating system used:

- Under Windows 95/98/Me, clear the **[Form feed]** check box on the **[Printer Settings]** tab in the printer properties dialog box.
- Under Windows 2000/XP, Windows Server 2003, or Windows NT 4.0, clear the **[Form feed]** check box on the **[NetWare Settings]** tab in the printer properties dialog box.

Banner Page

Do not use NetWare to configure a banner page.

Follow the procedure below to disable banner pages according to the operating system used:

- Under Windows 95/98/Me, clear the **[Enable banner]** check box on the **[Printer Settings]** tab in the printer properties dialog box.
- Under Windows 2000/XP, Windows Server 2003, or Windows NT 4.0, clear the **[Enable banner]** check box on the **[NetWare Settings]** tab in the printer properties dialog box.

Printing after Resetting the Printer

Printer to print server connection requires 30 - 40 seconds to resume after the printer is reset. During this period, jobs may be accepted (depending on NetWare specifications) but not printed.

To print after resetting the printer as the remote printer, check on the print server that the remote printer is disconnected, or wait for two minutes before trying to print.

Installing the Printer Driver Using USB

This section explains how to install printer drivers using USB.

Before installing, check that only the operating system is running on the computer and no print jobs are in progress.

The printer drivers can be installed from the CD-ROM provided with this machine.

Windows 98 SE/Me - USB

2

Important

- Installation via USB is not possible under Windows 95/98. Upgrade to Windows 98 SE/Me.

When USB is first used, the plug and play function starts and the **[New Hardware Found]**, **[Device Driver Wizard]**, or **[Add New Hardware Wizard]** dialog box appears, depending on the operating system.

If the printer driver has already been installed, plug and play is enabled, and the icon of the printer connected to the "USB" port is added to the **[Printers]** window.

- 1** Turn off the power of the machine.
- 2** Connect the machine with the computer via USB cable.
Connect the USB cable firmly.
- 3** Turn on the power of the computer.
- 4** Click **[Next>]**.
- 5** Click **[Search for the best driver for your device. {Recommended}.]**, and then click **[Next>]**.
- 6** Select the **[Specify a location:]** check box, and then click **[Browse...]**.
The **[Browse for Folder]** dialog box appears.
- 7** Insert the CD-ROM into the CD-ROM drive.

Note

- When Auto Run starts, click **[Exit]**.
 - To disable Auto Run, press the **[Shift]** key when inserting the CD-ROM into the drive and keep it pressed until the computer finishes reading from the CD-ROM.
- 8** Specify the location where USB Printing Support is located, and then click **[Next>]**.
If the CD-ROM drive is D, the source files of USB Printing Support are stored in the following location:
D:\DRIVERS\USBPRINT\WIN98ME
 - 9** Check the location, and then click **[Next]**.
USB Printing Support is installed.

10 Click **[Finish]**.

If the printer driver has already been installed, plug and play is enabled, and the icon of the printer connected to the "USB001" port is added to the **[Printers]** window.

11 Click **[Next>]**.**12** Click **[Search for the best driver for your device. {Recommended}.]**, and then click **[Next>]**.**13** Select the **[Specify a location:]**, check box, and then click **[Browse...]**.

The **[Browse for Folder]** dialog box appears.

14 Insert the CD-ROM into the CD-ROM drive. **Note**

- When Auto Run starts, click **[Exit]**.
- To disable Auto Run, press the **[Shift]** key when inserting the CD-ROM into the drive and keep it pressed until the computer finishes reading from the CD-ROM.

15 Specify the location where the source files of the printer driver is stored, and then click **[Next>]**.

If the CD-ROM drive is D, the source files of the printer driver are stored in the following location:

- RPCS
D:\DRIVERS\RPCS\WIN9X_ME\ (Language)\DISK1
- PCL 5c
D:\DRIVERS\PCL5C\WIN9X_ME\ (Language)\DISK1
- PCL 6
D:\DRIVERS\PCL6\WIN9X_ME\ (Language)\DISK1
- PostScript 3
D:\DRIVERS\PS3\WIN9X_ME\ (Language)\DISK1

16 Check the location, and then click **[Next]**.

Add Printer Wizard starts.

17 Click **[Finish]**.

Installation is complete. If installation is successful, the icon of the printer connected to the "USB001" port is added to the **[Printers]** window.

 **Note**

- The number after "USB" varies depending on the number of printers connected.
- It is not necessary to reinstall USB Printing Support when connecting a different machine via USB interface when USB Printing Support is installed.
- After installing USB Printing Support, if the printer driver is not installed, follow the plug-and-play instructions of the printer.

Windows 2000 - USB

Important

- Installing a printer driver requires Administrators permission. Log on using an account that has Administrators permission.

When USB is first used, Found New Hardware Wizard starts, and USB Printing Support is installed automatically.

If the printer driver has already been installed, plug and play is enabled, and the icon of the printer connected to the "USB" port is added to the **[Printers]** window.

If the printer driver is not installed, follow the plug-and-play instructions of the printer to install it from the CD-ROM provided.

- 1** Turn off the power of the machine.
- 2** Connect the machine with the computer via USB cable.
Connect the USB cable firmly.
- 3** Turn on the power of the computer.
- 4** Click **[Next]** in the **[Found New Hardware Wizard]** dialog box.
- 5** "Select the **[Search for a suitable driver for my device (recommended)]** check box, and then click **[Next]**."
- 6** Select the **[Specify location]** check box, and then click **[Next]**.
- 7** Insert the CD-ROM into the CD-ROM drive.

Note

- When Auto Run starts, click **[Exit]**.
- To disable Auto Run, press the left **[Shift]** key when inserting the CD-ROM into the drive and keep it pressed until the computer finishes reading from the CD-ROM.

- 8** Specify the location where the source files of the printer driver is stored.

If the CD-ROM drive is D, the source files of the printer driver are stored in the following location:

- RPCS
D:\DRIVERS\RPCS\WIN2K_XP\ (Language)\DISK1
- PCL 5c
D:\DRIVERS\PCL5C\WIN2K_XP\ (Language)\DISK1
- PCL 6
D:\DRIVERS\PCL6\WIN2K_XP\ (Language)\DISK1
- PostScript 3
D:\DRIVERS\PS3\WIN2K_XP\ (Language)\DISK1

- 9** Check the printer driver location, and then click **[OK]**.

10 Click **[Next]**.

11 Click **[Finish]**.

If the printer driver has already been installed, plug and play is enabled, and the icon of the printer connected to the "USB001" port is added to the **[Printers]** window.

 **Note**

- The number after "USB" varies depending on the number of printers connected.

Windows XP, Windows Server 2003 - USB

 **Important**

- Installing a printer driver requires Administrators permission. Log on using an account that has Administrators permission.

When USB is first used, Found New Hardware Wizard starts, and USB Printing Support is installed automatically.

If the printer driver has already been installed, plug and play is enabled, and the icon of the printer connected to the "USB" port is added to the **[Printers]** window. The printer drivers can be installed from the CD-ROM provided with this machine.

If the printer driver is not installed, follow the plug-and-play instructions of the printer to install it from the CD-ROM provided.

1 Turn off the power of the printer.

2 Connect the machine with the computer via USB cable.

Connect the USB cable firmly.

3 Turn on the power of the computer.

4 In the Found New Hardware Wizard display, click **[Search for a suitable driver for my device [recommended]]**, and then click **[Next>]**.

5 Insert the CD-ROM into the CD-ROM drive.

 **Note**

- If Auto Run starts, click **[Cancel]**, and then **[Exit]**.
- To disable Auto Run, press the left **[SHIFT]** key when inserting the CD-ROM into the drive and keep it pressed until the computer finishes reading from the CD-ROM.

- 6** Select the **[Include this location in the search]** check box under **[Search for the best driver in these location]**, and then click **[Browse]** to select the printer driver location.

If the CD-ROM drive is D, the source files of the printer driver are stored in the following location:

- RPCS
D:\DRIVERS\RPCS\WIN2K_XP\ (Language)\DISK1
- PCL 5c
D:\DRIVERS\PCL5C\WIN2K_XP\ (Language)\DISK1
- PCL 6
D:\DRIVERS\PCL6\WIN2K_XP\ (Language)\DISK1
- PostScript 3
D:\DRIVERS\PS3\WIN2K_XP\ (Language)\DISK1

- 7** Check the printer driver location, and then click **[Next]**.

- 8** Click **[Continue]**.

- 9** Click **[Finish]**.

If installation is successful, the icon of the printer connected to the "USB001" port is added to the **[Printers]** window.

 **Note**

- The number after "USB" varies depending on the number of printers connected.

Troubleshooting USB

Problems	Solutions
The machine is not automatically recognized.	Turn off the power of the machine, reconnect the USB cable, and then turn it on again.
Windows has already configured the USB settings.	<p>Open Windows' Device Manager, and then, under [Universal Serial Bus controllers], remove any conflicting devices. Conflicting devices have a yellow [!] or [?] icon by them. Take care not to accidentally remove required devices. For details, see Windows Help.</p> <p> Note</p> <p><input type="checkbox"/> When using Windows 2000/XP or Windows Server 2003, an erroneous device is displayed under [USB Controller] in the [Device Manager] dialog box.</p>

Printing with Parallel Connection

To use a machine connected using a parallel interface, click **[LPT1]** when installing the printer driver.

2

Installing the PCL or RPCS Printer Driver

Important

- To install this printer driver under Windows 2000/XP Professional, Windows Server 2003, and Windows NT 4.0, you must have an account that has Manage Printers permission. Log on as an Administrators or Power Users group member.

1 Quit all applications currently running.

2 Insert the CD-ROM into the CD-ROM drive.

The installer starts.

Auto Run may not work with certain operating system settings. If this happens, launch "Setup.exe" on the CD-ROM root directory.

3 Select an interface language, and then click **[OK]**.

The default interface language is English.

4 Click **[PCL/RPCS Printer Drivers]**.

5 The software license agreement appears in the **[License Agreement]** dialog box.

After reading the agreement, click **[I accept the agreement]**, and then click **[Next]**.

6 Select a printer driver you want to use in the **[Select Program]** dialog box.

You can select several printer drivers.

7 Select the **[Printer Name]** check box to select the printer models you want to use.

The printer name can be changed in the **[Change settings for 'Printer Name']** box.

8 Double-click the printer name to display the printer settings.

The details shown in **[Comment:]**, **[Driver:]**, and **[Port:]** vary depending on the operating system, printer model, and port.

9 Check that **[LPT1:]** is shown in **[Port:]**.

10 Select the **[Default Printer]** check box to configure the printer as default.

11 Click **[Finish]**.

The printer driver installation starts.

12 Click **[Finish]** in the installation completion dialog box. **Note**

- To stop installation of the selected software, click **[Cancel]** before installation is complete.

 **Reference**

A message appears if there is a newer version of the printer driver already installed. If there is, you cannot install the printer driver using Auto Run. If you still want to install the printer driver, use **[Add Printer]**. See p.57 "If a Message Appears during Installation".

Installing the Printer Driver Using IEEE 1394 (SCSI print)

The printer drivers can be installed from the CD-ROM provided with this machine.

2

Important

- Quit all applications currently running, and do not print during installation.
- Do not connect IEEE 1394 or USB devices to the computer or turn on another printers during installation.
- Before uninstalling the printer driver, check that the IEEE 1394 interface cable is disconnected from the computer.
- SCSI print must be set to "active" from the control panel. For details, see *Network Guide*.
- This machine can receive print data from one computer at a time only. An message may appear if jobs from different computers collide.
- If jobs collide, the first received is printed first.
- When the printer driver is properly installed, connecting or disconnecting the optional IEEE 1394 cable causes the printer icon to change.

Windows 2000

Note

- If **[Found New Hardware Wizard]** appears every time the computer is started or the cable is connected, disable the device. To install another printer driver after setting the "1394_00n" port, click **[1394_00]** as a port during the printer driver installation.
- Installing this printer driver requires Administrators permission. Log on using an account that has Administrators permission.
- The optional 1394 interface unit can be used only with Service Pack 1 (SP1) or higher.

- 1** Connect the machine and computer using the IEEE 1394 interface cable.
- 2** Click **[Next]** in the **[Found New Hardware Wizard]** dialog box.
- 3** When the message "This wizard will complete the installation for this Device: Unknown" appears, click **[Specify a location]**, and then click **[Next>]**.
- 4** When the message "Locate Driver Files" appears, select the **[Optional search locations.]** check box, and then click **[Specify a location]**, and then click **[Next>]**.

5 Insert the CD-ROM into the CD-ROM drive. **Note**

- If Auto Run starts, click **[Cancel]**, and then **[Exit]**.
- To disable Auto Run, press the left **[SHIFT]** key when inserting the CD-ROM into the drive and keep it pressed until the computer finishes reading from the CD-ROM.

6 Click **[Browse]**.**7** Select the printer driver you want to use.

If the CD-ROM drive is D, the source files of the printer driver are stored in the following location:

- RPCS
D:\DRIVERS\RPCS\WIN2K_XP\ (Language)\DISK1
- PCL 5c
D:\DRIVERS\PCL5C\WIN2K_XP\ (Language)\DISK1
- PCL 6
D:\DRIVERS\PCL6\WIN2K_XP\ (Language)\DISK1
- PostScript 3
D:\DRIVERS\PS3\WIN2K_XP\ (Language)\DISK1

8 Click **[Open]**.**9** Click **[OK]**.**10** Follow the instructions.

When installation is complete, the printer connected to "1394_00n" appears in the **[Printers]** window. ("n" shows the number of printers connected.)

 **Note**

- If the printer driver has already been installed, the printer icon is added to the **[Printers]** window. In this case, printer driver installation is not necessary.
- If printing does not work properly after the installation, delete the port and re-install the printer driver. For details, see p.142 "The Machine Does Not Print".
- If you do not want to install the printer when Found New Hardware Wizard starts under an operating system that supports SCSI print, disable the device by following the procedure below.
 - ① When the **[Found New Hardware Wizard]** dialog box appears, click **[Next>]**.
 - ② When the message "This wizard will complete the installation for this Device: Unknown" appears, select the **[Search for a suitable driver for my device recommended]** check box, and then click **[Next>]**.
 - ③ When the message "Please choose your search and installation option." appears, clear all check boxes from **[Search for the best driver in these locations.]**, and then click **[Next>]**.
 - ④ When the message "Driver Files Search Results" appears, select the **[Disable the device. The Add/Remove Hardware Wizard in the control Panel can be able to complete the driver installations.]** check box, and then click **[Finish]."**

Windows XP, Windows Server 2003

Important

- SCSI print must be set to "active" from the control panel. For details, see *Network Guide*.
- Installing this printer driver requires Administrators permission. Log on using an account that has Administrators permission.

Note

- This machine can receive print data from one computer at a time only. If a job from a computer collides with other data, a message may appear on the computer.
- To install another printer driver after setting the "1394_00n" port, click **[1394_00]** as a port during the printer driver installation.
- When the printer driver is properly installed, connecting or disconnecting the optional IEEE 1394 cable causes the printer icon to change.

1 Connect the machine and computer using the IEEE 1394 interface cable.

When the **[Found New Hardware Wizard]** dialog box appears, check that **[This wizard helps you install software for: (Unknown)]** is displayed.

2 Select the **[Install from a list on specific location (Advanced)]** check box, and then click **[Next>]**.

3 When the message "Please choose your search and installation option." appears, select the **[Search for the best driver in these locations.]** check box, select the **[Include this location in the search:]** check box, and then select the **[Include this location in the search:]** check box.

4 Insert the CD-ROM into the CD-ROM drive.

Note

- If Auto Run starts, click **[Cancel]**, and then **[Exit]**.
- To disable Auto Run, press the left **[SHIFT]** key when inserting the CD-ROM into the drive and keep it pressed until the computer finishes reading from the CD-ROM.

5 Specify the location where the source files of the printer driver is stored, and then click **[Next]**.

If the CD-ROM drive is D, the source files of the printer driver are stored in the following location:

- RPCS
D:\DRIVERS\RPCS\WIN2K_XP\ (Language)\DISK1
- PCL 5c
D:\DRIVERS\PCL5C\WIN2K_XP\ (Language)\DISK1
- PCL 6
D:\DRIVERS\PCL6\WIN2K_XP\ (Language)\DISK1
- PostScript 3
D:\DRIVERS\PS3\WIN2K_XP\ (Language)\DISK1

When installation is complete, the printer connected to "1394_00n" appears in the **[Printers and Faxes]** window. ("n" shows the number of printers connected.)

6 Follow the instructions.

Note

- If the printer driver has already been installed, the printer icon is added to the **[Printers and Faxes]** window. In this case, printer driver installation is not necessary.
- Even if the printer driver is already installed, the message " Found New Hardware Wizard" may appear when the machine and the computer are connected using the IEEE 1394 interface cable for the first time. If it does, install the printer driver.
- If printing does not work properly after the installation, delete the port and reinstall the printer driver. For details, see p.142 "The Machine Does Not Print".
- If you do not want to install the printer when Found New Hardware Wizard starts under an operating system that supports SCSI print, disable the device by following the procedure below
 - ① When the **[Found New Hardware Wizard]** dialog box appears, check that **[This wizard helps you install software for: Unknown]** displayed, select **[Install from a list on specific location (Advanced)]** check box, and then click **[Next>]**.
 - ② When the message "Please choose your search and installation option." appears, clear all check boxes from **[Search for the best driver in these locations.]**, and then click **[Next>]**.
 - ③ When the message "The wizard could not find the software on your computer for.." appears, click **[OK]**.
 - ④ When the message "Cannot Install this Hardware" appears, select the **[Don't prompt again to install the software]** check box, and then click **[Finish]**.

Printing with Bluetooth Connection

Supported Profiles

❖ SPP, HCRP

- A maximum of two Bluetooth adaptor or Bluetooth-equipped computers can be connected at the same time using the Bluetooth interface: one by SPP, one by HCRP.
- When connecting more than one Bluetooth adaptor or Bluetooth-equipped computer at the same time, the first device that establishes connection is selected. When selecting the connection between the other devices, cancel the first established connection.
- Conditions for bidirectional communications
 - SPP connection does not support bidirectional communications.
 - HCRP connection supports bidirectional communications.

❖ BIP

- For BIP connection, a module including PostScript 3 must be installed in the machine.
- Only one Bluetooth adaptor or Bluetooth-equipped computer can be connected via BIP.
- Only JPEG images that can be printed using BIP.
- User codes are disabled for BIP.
You cannot print if print functions are restricted.
- Some printers do not support BIP.

Printing with Bluetooth Connection

To install the printer driver, follow the procedure used to install parallel interface.

Important

- To install the printer driver under Windows 2000/XP Professional or Windows Server 2003, you must have an account that has Manage Printers permission. Log on as an Administrators or Power Users group member.

Note

- System requirements vary depending on the Bluetooth standard and specifications. For details, see the manuals provided with each product.
- For information about setting up Bluetooth under other operating systems or using it with different utilities, see the manuals provided with those operating systems or utilities.

- 1** Start 3Com Bluetooth Connection Manager.
- 2** Check that the printer you want to use appears in 3Com Bluetooth Connection Manager.
- 3** On the [Tool] menu, click [COM port].
- 4** Check that the message "Bluetooth Serial Client (COMx) " appears under Client Ports. (X indicates the COM port number used by Bluetooth.)
- 5** Click [Close].
- 6** On the [Start] menu, point to [Settings], and then click [Printers].
The [Printers] window appears.
- 7** Click the icon of the printer you want to use.
- 8** On the [File] menu, click [Properties].
- 9** Click the [Ports] tab.
- 10** Under [Port], select the [COMx:] check box. X indicates the COM port number used by Bluetooth.
- 11** Click [OK].
Close the [Printers] window.

❖ **If a dialog box appears while transmitting a print job, reestablish network connection as follows:**

- ① Select the printer you want to use in the [Printers and Faxes] box.
- ② Click [Connect].

 **Note**

- To always use the same printer, select the [Always use for this connection] check box.

 **Reference**

For details, see the manuals provided with the Bluetooth adaptor or computer equipped with Bluetooth.

Configuring Security Mode Settings

1 Start 3Com Bluetooth Connection Manager.

2 On the [Tools] menu, click [Security Mode].

The [Security Mode] dialog box appears.

3 Select the security mode in the [Security Mode:] list.

If you click [High], or [Custom], and specify [Link] in the [Custom Settings] dialog box, enter the Bluetooth password. For information about entering the password, see p.56 "Printing in the Security Mode".

For all other security modes and custom settings, no password is required.

 **Note**

For information about each mode, see the manuals provided with the utility.

4 Click [OK].

Close the [Security Mode] dialog box.

 **Reference**

For details about the security mode, see 3Com Bluetooth Connection Manager Help. For details about the password entry which is required to transmit print jobs, see p.56 "Printing in the Security Mode".

Printing in the Security Mode

1 Send the print job to the printer in use.

Depending on the computer configuration, the [Connect] dialog box may appear. If it does, use it to establish the network connection.

2 The [Authentication] dialog box appears.

3 Enter the Bluetooth password, and then click [OK].

As the Bluetooth password, enter the last four digits of the machine's serial number. You can find the serial number on the label on the back of the machine. For example, if the serial number is 00A0-001234, the Bluetooth password is 1234.

4 The print job is sent.

 **Note**

The Bluetooth password differs for each machine and cannot be changed.

If a Message Appears during Installation

Message number 58 or 34 indicates the printer driver cannot be installed using Auto Run. Install the printer driver using **[Add Printer]** or **[>Install Printer]**.

For Windows 95/98/Me, Windows 2000 and Windows NT 4.0:

- 1** On the **[Start]** menu, point to **[Settings]**, and then click **[Printers]**.
- 2** Double-click the Add Printer icon.
- 3** Follow the instructions in Add Printer Wizard.

 **Note**

- If the printer driver is on a CD-ROM, the location of the RPCS printer driver is either `\DRIVERS\RPCS\WIN9X_ME`, `\DRIVERS\RPCS\WIN2K_XP`, or `\DRIVERS\RPCS\NT4`. If the installer starts, click **[Cancel]** to quit.

For Windows XP Professional and Windows Server 2003:

- 1** On the **[Start]** menu, click **[Printers and Faxes]**.
- 2** Click **[Add a printer]**.
- 3** Follow the instructions in Add Printer Wizard.

 **Note**

- If the printer driver is on a CD-ROM, the location of the RPCS printer driver is `\DRIVERS\RPCS\WIN2K_XP`. If the installer starts, click **[Cancel]** to quit.

For Windows XP Home Editions:

- 1** On the **[Start]** menu, click **[Control Panel]**.
- 2** Click **[Printers and Other Hardware]**.
- 3** Click **[Printers and Faxes]**.
- 4** Click **[Install Printer]**.
- 5** Follow the instructions in Add Printer Wizard.

 **Note**

- If the printer driver is on a CD-ROM, the location of the RPCS printer driver is `\DRIVERS\RPCS\WIN2K_XP`. If the installer starts, click **[Cancel]** to quit.

Making Option Settings for the Printer

Make option settings for the machine using the printer driver when bidirectional communication is disabled.

Reference

For details about making option settings for the printer, see p.60 “If Bidirectional Communication is Disabled”.

Conditions for Bidirectional Communication

Bidirectional communication allows information about paper size and feed direction settings to be automatically sent to the printer. You can check machine status from your computer.

- Bidirectional communication is supported by Windows 95/98/Me/2000/XP, Windows Server 2003, and Windows NT 4.0.
- If you use the RPCS printer driver and bidirectional communication is enabled under Windows 2000, the **[Change Accessories]** tab is unavailable.

Note

- The RPCS printer driver supports bidirectional communications and updates the machine status automatically.
- The PCL printer driver supports bidirectional communications. You can update machine status manually.
- The PostScript 3 printer driver does not support bidirectional communications.

To support bidirectional communication, the following conditions must be met:

◆ When connected with parallel cables

- The computer must support bidirectional communication.
- The machine must support bidirectional communication.
- The interface cable must support bidirectional communication.
- The machine must be connected to the computer using the standard parallel cables and parallel connectors.
- Under Windows 2000, **[Enable bidirectional support]** must be selected, and **[Enable printer pooling]** must not be selected on the **[port]** tab with the RPCS printer driver.

❖ When connected with the network

- The machine must support bidirectional communication.
- SmartDeviceMonitor for Client included on the CD-ROM must be installed, and TCP/IP must be used.
- Under Windows 2000, **[Enable bidirectional support]** must be selected, and **[Enable printer pooling]** must not be selected on the **[port]** tab with the RPCS printer driver.
- In addition to the above, one of the following conditions must also be met:
 - The SmartDeviceMonitor for Client port and the TCP/IP protocol must be used.
 - The standard TCP/IP port must be used without changing the default port name (for Windows 2000/XP and Windows Server 2003).
 - Microsoft TCP/IP print IP address must be specified for use (for Windows NT 4.0).
 - IPP port name must include the IP address when using the IPP protocol.

❖ When connected with IEEE 1394

- The computer must support bidirectional communication.
- The machine must be connected to the IEEE 1394 connector of a computer using the IEEE 1394 interface cable.
- **[Activate]** must be selected in the SCSI print of IEEE 1394 and **[Activate]** must be selected in the Bidi-SCSI print.
- Under Windows 2000/XP or Windows Server 2003, **[Enable bidirectional support]** must be selected, and **[Enable printer pooling]** must not be selected on the **[port]** tab with RPCS printer driver.

❖ When connected with USB

The machine must be connected to the computer's USB port using the USB interface cable.

The computer must support bidirectional communication.

Note

- Install SmartDeviceMonitor for Client from the CD-ROM provided.

If Bidirectional Communication is Disabled

Set up option settings when bidirectional communications are disabled.

Limitation

- Under Windows 2000/XP and Windows Server 2003, Manage Printers permission is required to change the printer properties in the **[Printers]** folder. Log on as an Administrators or Power Users group member.
- Under Windows NT 4.0, Full Control permission is required to change the printer properties in the **[Printers]** folder. Log on as an Administrators or Power Users group member.

1 On the **[Start]** menu, point to **[Settings]**, and then click **[Printers]**.

The **[Printers]** window appears.

2 Click the icon of the printer you want to use.

3 On the **[File]** menu, click **[Properties]**.

4 Click the **[Accessories]** tab.

If options in the **[Change Accessories]** tab are disabled, bidirectional connection is enabled. In this case, no change is necessary for option settings.

Note

- If you are using the RPCS printer driver, click the **[Change Accessories]** tab.
- If you are using the PS printer driver, click the **[Device Settings]** tab.

5 Select options installed from the **[Option]** area, and then make the necessary settings.

6 Select the total amount of the memory in **[Total Memory:]**, when the optional SDRAM module is added.

7 Under **[Paper source tray settings]**, click and highlight the tray to be used, and then select the appropriate size, position, and type for the tray. Select the **[Tray locking]** check box to exclude the tray from the targets of automatic tray selection.

8 Click **[OK]** to close the printer properties dialog box. Click the **[Defaults]** tab, and then click **[Change Accessories]** to display the option selection.

Click **[OK]** to close the printer properties dialog box. Click the **[Defaults]** tab, and then click **[Change Accessories]** to display the option selection.

Installing Font Manager 2000

! Limitation

- Under Windows 2000/XP, Windows Server 2003, or Windows NT 4.0, installing applications by Auto Run requires administrator permission. To install a printer driver by Auto Run, log on using an account that has administrator permission.

1 Quit all applications currently running.

2 Insert the CD-ROM into the CD-ROM drive.

The installer starts.

3 Click [Font Manager 2000].

4 Follow the instructions on the screen.

Using Adobe PageMaker Version 6.0, 6.5, or 7.0

2

Under Windows 95/98/Me/2000/XP, Windows Server 2003, or Windows NT 4.0 with Adobe PageMaker, you need to copy PPD files to the PageMaker folder.

PPD files have the .ppd extension in the folder "DRIVERS\PS\WIN9X_ME\ (Language)\DISK1\" on the CD-ROM.

The "WIN9X_ME" folder inside the "PS" folder is for Windows 95/98/Me. Use the folder at this level that is appropriate for the operating system you are currently using.

The third folder "(Language)" may be substituted by an appropriate language name.

Copy the .ppd file to the PageMaker folder.

- **For PageMaker 6.0 default installation**
The directory is "C:\PM6\RSRC\PPD4".
- **For PageMaker 6.5 default installation**
The directory is "C:\PM65\RSRC\USENGLISH\PPD4".
The "USENGLISH" may vary depending on your language selection.
- **For PageMaker 7.0 default installation**
The directory is "C:\PM7\RSRC\USENGLISH\PPD4".
The "USENGLISH" may vary depending on your language selection.

Note

- If the driver is not set correctly after copying the ".ppd" file, printing may not be performed properly.
- When using PageMaker, the optional features that can be selected by the printer driver will not be active. The following procedure describes how to activate the optional printer features.
 - ① On the **[File]** menu, click **[Print]**.
The **[Print Document]** dialog box appears.
 - ② Make the necessary settings in the **[Features]** box.

3. Setting Up the Printer Driver

PCL - Accessing the Printer Properties

Windows 95/98/Me - Accessing the Printer Properties

There are two methods to open the printer properties dialog box.

Making printer default settings

To make the printer default settings, open the printer properties dialog box from the **[Printers]** window.

Important

- You cannot change the printer default settings for each user. Settings made in the printer properties dialog box are applied to all users.

1 On the **[Start]** menu, point to **[Settings]**, and then click **[Printers]**.

The **[Printers]** window appears.

2 Click the icon of the printer you want to use.

3 On the **[File]** menu, click **[Properties]**.

4 Make the necessary settings, and then click **[OK]**.

Note

- With some applications, the printer driver settings are not used, and the application's own default settings are applied.

Reference

For details, see Printer Driver Help.

Making printer settings from an application

You can make printer settings for a specific application.

To make printer settings for a specific application, open the printer properties dialog box from that application. The following explains how to make settings for the WordPad application provided with Windows 95/98/Me.

1 On the **[File]** menu, click **[Print]**.

The **[Print]** dialog box appears.

2 Select the printer you want to use in the **[Name]** list, and then click **[Properties]**.

The printer properties dialog box appears.

3 Make the necessary settings, and then click [OK].

4 Click [OK] to start printing.

 **Note**

- The procedure to open the printer properties dialog box may vary depending on the application. For details, see the manuals provided with the application you use.
- With some applications, the printer driver settings are not used, and the application's own default settings are applied.
- Any settings you make in the following procedure are valid for the current application only.
- General users can change the properties displayed in the [Print] dialog box of an application. Settings made here are used as defaults when printing from this application.

 **Reference**

For details, see Printer Driver Help.

Windows 2000 - Accessing the Printer Properties

Making printer default settings - the printer properties

 **Important**

- To change the printer default settings including option configuration settings, log on using an account that has Manage Printers permission. Members of the Administrators and Power Users groups have Manage Printers permission by default.
- You cannot change the printer default settings for each user. Settings made in the printer properties dialog box are applied to all users.

1 On the [Start] menu, point to [Settings], and then click [Printers].

The [Printers] window appears.

2 Click the icon of the printer you want to use.

3 On the [File] menu, click [Properties].

The printer properties dialog box appears.

4 Make the necessary settings, and then click [OK].

 **Note**

- Settings you make here are used as the default settings for all applications.
- Do not make a setting for [Form to Tray Assignment].

 **Reference**

For details, see Printer Driver Help.

Making printer default settings - Printing Preferences

Important

- You cannot change the printer default settings for each user. Settings made in the printer properties dialog box are applied to all users.

1 On the **[Start]** menu, point to **[Settings]**, and then click **[Printers]**.

The **[Printers]** window appears.

2 Click the icon of the printer you want to use.

3 On the **[File]** menu, click **[Printing Preferences...]**.

The **[Printing Preferences]** dialog box appears.

4 Make the necessary settings, and then click **[OK]**.

Note

- Settings you make here are used as the default settings for all applications.

Reference

For details, see Printer Driver Help.

Making printer settings from an application

You can make printer settings for a specific application.

To make printer settings for a specific application, open the **[Printing Preferences]** dialog box from that application. The following explains how to make settings for the WordPad application provided with Windows 2000.

Note

- The procedure to open the **[Printing Preferences]** dialog box may vary depending on the application. For details, see the manuals provided with the application you use.
- Any settings you make in the following procedure are valid for the current application only.
- General users can change the properties displayed in the **[Print]** dialog box of an application. Settings made here are used as defaults when printing from this application.

1 On the **[File]** menu, click **[Print...]**.

The **[Print]** dialog box appears.

2 Select the printer you want to use in the **[Select Printer]** list.

3 Make the necessary settings, and then click **[Apply]** to start printing.

Reference

For details, see Printer Driver Help.

Windows XP, Windows Server 2003 - Accessing the Printer Properties

Making printer default settings - the printer properties

Important

- To change the printer default settings including option configuration settings, log on using an account that has Manage Printers permission. Members of the Administrators and Power Users groups have Manage Printers permission by default.
- You cannot change the printer default settings for each user. Settings made in the printer properties dialog box are applied to all users.

1 On the [Start] menu, click [Printers and Faxes].

The [Printers and Faxes] window appears.

2 Click the icon of the printer you want to use.

3 On the [File] menu, click [Properties].

The printer properties dialog box appears.

4 Make the necessary settings, and then click [OK].

Note

- Settings you make here are used as the default settings for all applications.
- Do not make a setting for [Form to Tray Assignment].

Reference

For details, see Printer Driver Help.

Making printer default settings - Printing Preferences

Important

- You cannot change the printer default settings for each user. Settings made in the printer properties dialog box are applied to all users.

1 On the [Start] menu, click [Printers and Faxes].

The [Printers and Faxes] window appears.

2 Click the icon of the printer you want to use.

3 On the [File] menu, click [Printing Preferences...].

The [Printing Preferences] dialog box appears.

4 Make the necessary settings, and then click [OK].

Note

- Settings you make here are used as the default settings for all applications.

Reference

For details, see Printer Driver Help.

Download from www.Somanuals.com. All Manuals Search And Download.

Making printer settings from an application

You can make printer settings for a specific application.

To make printer settings for a specific application, open the **[Printing Preferences]** dialog box from that application. The following explains how to make settings for the WordPad application provided with Windows XP.

Note

- The procedure to open the **[Printing Preferences]** dialog box may vary depending on the application. For details, see the manuals provided with the application you use.
- Any settings you make in the following procedure are valid for the current application only.
- General users can change the properties displayed in the **[Print]** dialog box of an application. Settings made here are used as defaults when printing from this application.

1 On the **[File]** menu, click **[Print...]**.

The **[Print]** dialog box appears.

2 Select the printer you want to use in the **[Select Printer]** list.

3 Make the necessary settings, and then click **[Apply]** to start printing.

Reference

For details, see Printer Driver Help.

Windows NT 4.0 - Accessing the Printer Properties

Making printer default settings - the printer properties

Important

- To change the printer default settings including option configuration settings, log on using an account that has Full Control permission. Members of the Administrators, Server Operators, Print Operators, and Power Users groups have Full Control permission by default.
- You cannot change the printer default settings for each user. Settings made in the printer properties dialog box are applied to all users.

1 On the [Start] menu, point to [Settings], and then click [Printers].

The [Printers] window appears.

2 Click the icon of the printer you want to use.

3 On the [File] menu, click [Properties].

The printer properties dialog box appears.

4 Make the necessary settings, and then click [OK].

Note

- Settings you make here are used as the default settings for all applications.
- Do not make a setting for [Form to Tray Assignment].

Reference

For details, see Printer Driver Help.

Making printer default settings - Default

Important

- To change the printer default settings including option configuration settings, log on using an account that has Full Control permission. Members of the Administrators, Server Operators, Print Operators, and Power Users groups have Full Control permission by default.
- You cannot change the printer default settings for each user. Settings made in the printer properties dialog box are applied to all users.

1 On the [Start] menu, point to [Settings], and then click [Printers].

The [Printers] window appears.

2 Click the icon of the printer you want to use.

3 On the [File] menu, click [Document Defaults].

The [Default] dialog box appears.

4 Make the necessary settings, and then click [OK]. **Note**

- Settings you make here are used as the default settings for all applications.

 **Reference**

For details, see Printer Driver Help.

Making printer settings from an application

You can make printer settings for a specific application.

To make printer settings for a specific application, open the printer properties dialog box from that application. The following explains how to make settings for the WordPad application provided with Windows NT 4.0.

 **Note**

- The procedure to open the printer properties dialog box may vary depending on the application. For details, see the manuals provided with the application you use.
- With some applications, the printer driver settings are not used, and the application's own default settings are applied.
- Any settings you make in the following procedure are valid for the current application only.
- General users can change the properties displayed in the [Print] dialog box of an application. Settings made here are used as defaults when printing from this application.

1 On the [File] menu, click [Print].

The [Print] dialog box appears.

2 Select the printer you want to use in the [Name] list, and then click [Properties].

The printer properties dialog box appears.

3 Make the necessary settings, and then click [OK].**4** Click [OK] to start printing. **Reference**

For details, see Printer Driver Help.

RPCS - Accessing the Printer Properties

Windows 95/98/Me - Accessing the Printer Properties

There are two dialog box types of the printer properties dialog box.

"Multi-tab" is used as an example in this manual. For details about changing the dialog box types, see the printer driver Help.

❖ Multi-tab

This dialog box type is designed for users who often change print settings to perform various printing operations.

❖ Custom Setting

This dialog box type is designed for users who rarely change print settings. This type of dialog box may vary depending on the installed options.

Making printer default settings

To make the printer default settings, open the printer properties dialog box from the [Printers] window.

Important

- You cannot change the printer default settings for each user. Settings made in the printer properties dialog box are applied to all users.

Note

- With some applications, the printer driver settings are not used, and the application's own default settings are applied.

1 On the [Start] menu, point to [Settings], and then click [Printers].

The [Printers] window appears.

2 Click the icon of the printer you want to use.

3 On the [File] menu, click [Properties].

Note

- When you open the printer properties dialog box initially after installing the RPCS printer driver, a confirmation message appears. After clicking [OK], the printer properties dialog box appears.

4 Make the necessary settings, and then click [OK].

Reference

For details, see Printer Driver Help.

Making printer settings from an application

You can make printer settings for a specific application.

To make printer settings for a specific application, open the printer properties dialog box from that application. The following explains how to make settings for the WordPad application provided with Windows 95/98/Me.

Note

- The procedure to open the printer properties dialog box may vary depending on the application. For details, see the manuals provided with the application you use.
- With some applications, the printer driver settings are not used, and the application's own default settings are applied.
- Any settings you make in the following procedure are valid for the current application only.
- General users can change the properties displayed in the **[Print]** dialog box of an application. Settings made here are used as defaults when printing from this application.

1 On the **[File]** menu, click **[Print]**.

The **[Print]** dialog box appears.

2 Select the printer you want to use in the **[Name]** list, and then click **[Properties]**.

The printer properties dialog box appears.

3 Make the necessary settings, and then click **[OK]**.

4 Click **[OK]** to start printing.

Reference

For details, see Printer Driver Help.

Windows 2000 - Accessing the Printer Properties

Making printer default settings - the printer properties

Important

- To change the printer default settings including option configuration settings, log on using an account that has Manage Printers permission. Members of the Administrators and Power Users groups have Manage Printers permission by default.
- You cannot change the printer default settings for each user. Settings made in the printer properties dialog box are applied to all users.

1 On the [Start] menu, point to [Settings], and then click [Printers].

The [Printers] window appears.

2 Click the icon of the printer you want to use.

3 On the [File] menu, click [Properties].

The printer properties dialog box appears.

Note

- When you open the printer properties dialog box initially after installing the RPCS printer driver, a confirmation message appears. After clicking [OK], the printer properties dialog box appears.

4 Make the necessary settings, and then click [OK].

Note

- Settings you make here are used as the default settings for all applications.
- Do not make a setting for [Form to Tray Assignment].

Reference

For details, see Printer Driver Help.

Making printer default settings - Printing Preferences

Important

- You cannot change the printer default settings for each user. Settings made in the printer properties dialog box are applied to all users.

1 On the [Start] menu, point to [Settings], and then click [Printers].

The [Printers] window appears.

2 Click the icon of the printer you want to use.

3 On the [File] menu, click [Printing Preferences...].

The [Printing Preferences] dialog box appears.

4 Make the necessary settings, and then click [OK].

Note

- Settings you make here are used as the default settings for all applications.

Reference

For details, see Printer Driver Help.

Making printer settings from an application

You can make printer settings for a specific application.

To make printer settings for a specific application, open the [Printing Preferences] dialog box from that application. The following explains how to make settings for the WordPad application provided with Windows 2000.

Note

- The procedure to open the [Printing Preferences] dialog box may vary depending on the application. For details, see the manuals provided with the application you use.
- Any settings you make in the following procedure are valid for the current application only.
- General users can change the properties displayed in the [Print] dialog box of an application. Settings made here are used as defaults when printing from this application.

1 On the [File] menu, click [Print...].

The [Print] dialog box appears.

2 Select the printer you want to use in the [Select Printer] list.

3 Make the necessary settings, and then click [Apply] to start printing.

Reference

For details, see Printer Driver Help.

Windows XP, Windows Server 2003 - Accessing the Printer Properties

Making printer default settings - the printer properties

Important

- To change the printer default settings including option configuration settings, log on using an account that has Manage Printers permission. Members of the Administrators and Power Users groups have Manage Printers permission by default.
- You cannot change the printer default settings for each user. Settings made in the printer properties dialog box are applied to all users.

1 On the [Start] menu, click [Printers and Faxes].

The [Printers and Faxes] window appears.

2 Click the icon of the printer you want to use.

3 On the [File] menu, click [Properties].

The printer properties dialog box appears.

Note

- When you open the printer properties dialog box initially after installing the RPCS printer driver, a confirmation message appears. After clicking [OK], the printer properties dialog box appears.

4 Make the necessary settings, and then click [OK].

Note

- Settings you make here are used as the default settings for all applications.
- Do not make a setting for [Form to Tray Assignment].

Reference

For details, see Printer Driver Help.

Making printer default settings - Printing Preferences

Important

- You cannot change the printer default settings for each user. Settings made in the printer properties dialog box are applied to all users.

1 On the [Start] menu, click [Printers and Faxes].

The [Printers and Faxes] window appears.

2 Click the icon of the printer you want to use.

3 On the [File] menu, click [Printing Preferences...].

The [Printing Preferences] dialog box appears.

4 Make the necessary settings, and then click [OK].

Note

- Settings you make here are used as the default settings for all applications.

Reference

For details, see Printer Driver Help.

Making printer settings from an application

You can make printer settings for a specific application.

To make printer settings for a specific application, open the [Printing Preferences] dialog box from that application. The following explains how to make settings for the WordPad application provided with Windows XP.

Note

- The procedure to open the [Printing Preferences] dialog box may vary depending on the application. For details, see the manuals provided with the application you use.
- Any settings you make in the following procedure are valid for the current application only.
- General users can change the properties displayed in the [Print] dialog box of an application. Settings made here are used as defaults when printing from this application.

1 On the [File] menu, click [Print...].

The [Print] dialog box appears.

2 Select the printer you want to use in the [Select Printer] list.

3 Make the necessary settings, and then click [Apply] to start printing.

Reference

For details, see Printer Driver Help.

Windows NT 4.0 - Accessing the Printer Properties

Making printer default settings - the printer properties

Important

- To change the printer default settings including option configuration settings, log on using an account that has Full Control permission. Members of the Administrators, Server Operators, Print Operators, and Power Users groups have Full Control permission by default.
- You cannot change the printer default settings for each user. Settings made in the printer properties dialog box are applied to all users.

1 On the [Start] menu, point to [Settings], and then click [Printers].

The [Printers] window appears.

2 Click the icon of the printer you want to use.

3 On the [File] menu, click [Properties].

The printer properties dialog box appears.

Note

- When you open the printer properties dialog box initially after installing the RPCS printer driver, a confirmation message appears. After clicking [OK], the printer properties dialog box appears.

4 Make the necessary settings, and then click [OK].

Note

- Settings you make here are used as the default settings for all applications.
- Do not make a setting for [Form to Tray Assignment].

Reference

For details, see Printer Driver Help.

Making printer default settings - Default

Important

- To change the printer default settings including option configuration settings, log on using an account that has Full Control permission. Members of the Administrators, Server Operators, Print Operators, and Power Users groups have Full Control permission by default.
- You cannot change the printer default settings for each user. Settings made in the printer properties dialog box are applied to all users.

1 On the [Start] menu, point to [Settings], and then click [Printers].

The [Printers] window appears.

2 Click the icon of the printer you want to use.

3 On the [File] menu, click [Document Defaults...].

The [Default] dialog box appears.

4 Make the necessary settings, and then click [OK].

Note

- Settings you make here are used as the default settings for all applications.

Reference

For details, see Printer Driver Help.

Making printer settings from an application

You can make printer settings for a specific application.

To make printer settings for a specific application, open the printer properties dialog box from that application. The following explains how to make settings for the WordPad application provided with Windows NT 4.0.

Note

- The procedure to open the printer properties dialog box may vary depending on the application. For details, see the manuals provided with the application you use.
- With some applications, the printer driver settings are not used, and the application's own default settings are applied.
- Any settings you make in the following procedure are valid for the current application only.
- General users can change the properties displayed in the **[Print]** dialog box of an application. Settings made here are used as defaults when printing from this application.

1 On the **[File]** menu, click **[Print]**.

The **[Print]** dialog box appears.

2 Select the printer you want to use in the **[Name]** list, and then click **[Properties]**.

The printer properties dialog box appears.

3 Make the necessary settings, and then click **[Apply]**.

4 Click **[OK]** to start printing.

Reference

For details, see Printer Driver Help.

4. Other Print Operations

Printing a PDF File Directly

You can send PDF files directly to the machine for printing, without having to open a PDF application.

⚠ Limitation

- This function is possible only when the optional PostScript 3 unit is installed.
- This function is possible for genuine Adobe PDF files only.
- Version 1.3, 1.4, and 1.5 PDF files are compatible.
- Transparency and JBIG2 (functions of PDF version 1.4) are not compatible.
- PDF version 1.5 exclusive functions are not compatible.

📝 Note

- Paper size errors may occur when printing on custom size paper.

Printing Method

❖ Using DeskTopBinder Lite

PDF files registered with DeskTopBinder Lite can be sent directly to the machine for printing.

⚠ Limitation

- Use DeskTopBinder Lite on the provided CD-ROM.

📝 Note

- PDF Direct Print settings can be made from PDF Direct Print properties.
- When printing PDF files for which a password is set, one of the following settings is required:
 - Enter the PDF password from PDF Direct Print properties. The RPCS printer driver must be installed.
 - To set the PDF password, select **[Change PDF Password]** on the **[PDF Menu]** in Printer Features.
- When a group password is set with DeskTopBinder Lite, set a group password using **[PDF Group Password]** on the **[PDF Menu]** in Printer Features.

🔍 Reference

For details, see DeskTopBinder Lite Help.

❖ Using commands

From UNIX, you can print PDF files directly, using commands such as "ftp" and "lpr".

Using Locked & Sample Print Job List

A list of files stored in the machine can be viewed on the display panel.

1 Press the **[Printer]** key.

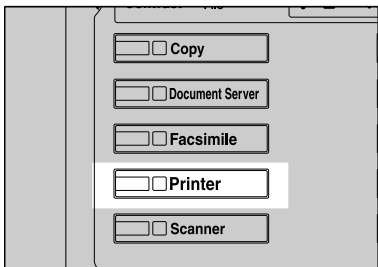

AEU0445

The Printer screen appears.

2 Press **[Locked & Sample Print Job List]**.

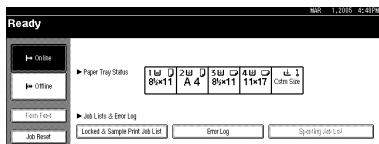

A list of files stored in the machine appears.

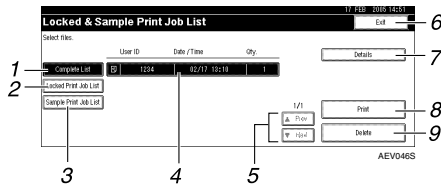

1. [Complete List]

Displays all files stored in the machine.

2. [Locked Print Job List]

Displays only locked print files stored in the machine. See p.86 "Locked Print".

3. [Sample Print Job List]

Displays only sample print files stored in the machine. See p.82 "Sample Print".

4. User ID, Date/Time, and Qty. display

Displays the time when the instruction to print the stored files was entered, User ID, and the remaining number of copies.

Note

- The display is not updated if a new file is stored while the list of stored files is displayed. To update the display, press **[Exit]** to return to the Printer screen, and then press **[Locked & Sample Print Job List]** again.

5. [▲Prev.] / [▼Next]

If the list of files does not fit on the screen, scroll down to view the list.

6. [Exit]

Returns to the Printer screen.

7. [Details]

Displays details about the selected file.

8. [Print]

Prints the selected file.

9. [Delete]

Deletes the selected file.

Sample Print

Use this function to print only the first set of a multiple-set print job. After you have checked the result, remaining sets can be printed or canceled using the machine's control panel. This can reduce misprints due to mistakes in content or settings.

Note

- If the application has a collate option, make sure it is not selected before sending a print job. By default, sample print jobs are automatically collated by the printer driver. If a collate option is selected from the application's **[Print]** dialog box, more prints than intended may be produced.
- You can identify the file you want to print by user ID and date and time when the job was stored.
- The number of pages the machine can save depends on the contents of the print image. For example, the machine can save up to 30 jobs or 1,000 pages, including locked print files, depending on data volume.
- If the first set of the sample print files is not as you expected and you do not want to print remaining sets, delete the sample print file using the display panel. If you print the remaining sets of the sample print file, the job in the machine is deleted automatically.
- Turning off the machine's main power switch deletes sample print files.

Printing a Sample Print File

The following procedure describes how to print a sample print file with the PCL 6 / 5c and the RPCS printer driver. For information about how to print a sample print file with the PostScript 3 printer driver, see *PostScript 3 Supplement* included as a PDF file on the CD-ROM.

Limitation

- Applications with their own drivers, such as PageMaker, do not support this function.
- If you are using Mac OS X, you need Mac OS X v10.2 or higher to use this function.

1 Configure the sample print in the printer driver's properties.

Reference

For details about configuring the printer drivers, see the relevant Help files.

2 Start printing from the application's **[Print]** dialog box.

Note

- Make sure to set more than two copies.

The sample print job is sent to the machine, and the first set is printed.

- 3** On the machine's control panel, press the **[Printer]** key to display the Printer screen.

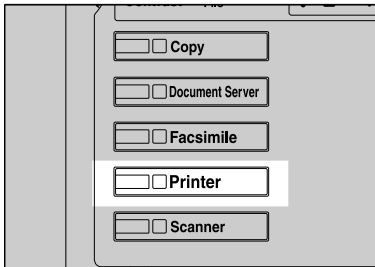

AEU0445

- 4** Press **[Locked & Sample Print Job List]**.

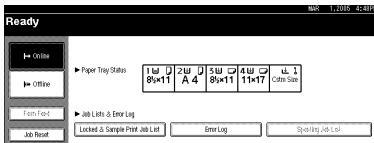

A list of the print files stored in the machine appears.

- 5** Press **[Sample Print Job List]**.

A list of the sample print files stored in the machine appears.



The following items also appear:

- User ID: The user ID set up by the printer driver.
- Date / Time: The date and time when the job was sent from the computer.
- Qty.: The number of remaining sets.

Note

- Depending on the security settings, certain print jobs may not be displayed.

- 6** Select the file you want to print by pressing it.

Note

- Press **[▲Prev.]** or **[▼Next]** to scroll through the list.
- Only one file can be selected at a time.

- 7** Press **[Print]** to change the number of sets to be printed.

- 8** Enter the new number of sets using the number keys.

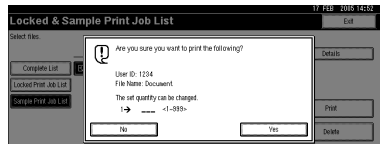

If you do not want to change the set quantity, proceed to step **9**.

Note

- You can enter up to 999 sets.
- Press **[Clear/Stop]** to correct any entry mistakes.

- 9** Press **[Yes]**.

The remaining sets are printed.

Note

- Press **[No]** to cancel printing.
- When printing is completed, the stored file will be deleted.
- To cancel printing, press **[Exit]**. After that, press **[Job Reset]**. After it has started, the file will be deleted.
- Remaining print jobs are printed before the sample print job.

Deleting a Sample Print File

If you are not satisfied with the sample printout, you can delete the sample print file, revise it and print it again until the settings are suitable.

1 Press the **[Printer]** key to display the Printer screen.

2 Press **[Locked & Sample Print Job List]**.

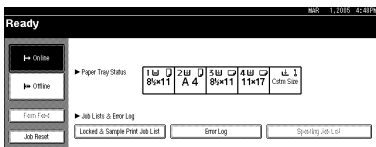

A list of the print files stored in the machine appears.

3 Press **[Sample Print Job List]**.

A list of sample print files stored in the machine appears.

Note

- Depending on the security settings, certain print jobs may not be displayed.

4 Select the file you want to delete by pressing it.

Note

- Press **[▲Prev.]** or **[▼Next]** to scroll through the list.
- Only one file can be selected at a time.

5 Press **[Delete]**.

The delete confirmation screen will appear.

6 Press **[Yes]** to delete the file.

After the file has been deleted, the file list screen will return.

Note

- If you do not want to delete the file, press **[No]**.

Checking the Error Log

If a file could not be stored, you can check the error log on the control panel.

Limitation

- The latest 30 error files are stored in the error log. If a new error file is added when there are 30 error files already stored, the oldest file is deleted. However, if the oldest error file is a sample print file, it is not deleted, but stored instead in the sample print error log until the number of sample print error files reaches 20.
- If the main power switch is turned off, the log is deleted.

1 Press the **[Printer]** key to display the Printer screen.

2 Press **[Error Log]**.

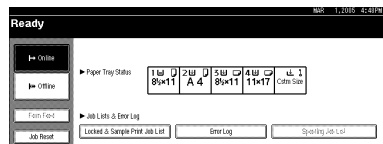

3 Press **[Sample Print Job List]**.

Note

- Depending on the security settings, certain print jobs may not be displayed.

4 Press [Details].

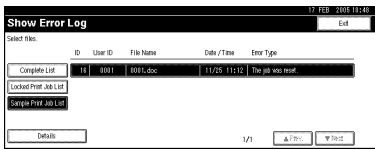

An error log list appears.



Note

- Press [**▲Prev.**] or [**▼Next**] to scroll through the error files.
- Press [**Exit**] after checking the log.
- To print files that appear in the error log, resend them after stored files have been printed or deleted.

Locked Print

Use this function to maintain privacy when printing confidential documents on the machine over a shared network. Usually, it is possible to print data using the display panel once it is stored in this machine. When using Locked Print, it is not possible to print unless a password is entered on the machine's display panel. Your confidential documents will be safe from being viewed by other people.

4

Note

- ❑ If the application has a collate option, make sure it is not selected before sending a print job. Locked print jobs are automatically collated by the printer driver as default. If a collate option is selected in the application print dialog box, more sets than intended may be printed.
- ❑ You can identify the file you want to print by User ID, and date and time when the job was stored.
- ❑ The number of pages the machine can save depends on print image content. For example, the machine can save up to 30 jobs or 1,000 pages including sample print files, depending on data volume.
- ❑ After the locked print file is printed, the job is automatically deleted.
- ❑ Turning off the machine's main power switch deletes locked print files.

Printing a Locked Print File

The following procedure describes how to print a locked print file with the PCL 6 / 5c and the RPCS printer driver. For information about how to print a locked print file with the PostScript 3 printer driver, see *PostScript 3 Supplement* included as a PDF file on the CD-ROM.

Limitation

- ❑ Applications with their own drivers, such as PageMaker, do not support this function.
- ❑ If you are using Mac OS X, you need Mac OS X v10.2 and higher to use this function.

1 Configure the locked print in the printer driver's properties.

Reference

For details about configuring the printer drivers, see the corresponding Help files.

2 Start printing from the application's [Print] dialog box.

The locked print job is sent to the machine.

3 On the machine's control panel, press the [Printer] key to display the Printer screen.

4 Press [Locked & Sample Print Job List].

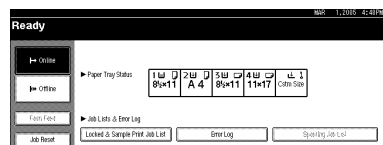

A list of the print files stored in the machine appears.

5 Press **[Locked Print Job List]**.

A list of the locked print files stored in the machine appears.



The following items also appear:

- User ID: The user ID set up by the printer driver.
- Date / Time: The date and time when the job was sent from the computer.

Note

- Depending on the security settings, certain print jobs may not be displayed.

6 Select the file you want to print by pressing it.**Note**

- Press **[▲Prev.]** or **[▼Next]** to scroll through the list.
- Only one file can be selected at a time.

7 Press **[Print]**.

The password screen appears.

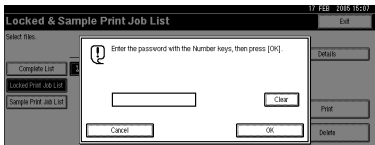
**8** Enter the password using the number keys, and then press **[OK]**.

The print confirmation screen appears.

Note

- A confirmation screen will appear if the password is not entered correctly. Press **[OK]** to enter the password again.

9 Press **[Yes]**.

The locked file is printed.

Note

- Press **[No]** to cancel printing.
- To cancel printing, press **[Exit]**. After that, press **[Job Reset]**. After it has started, the file will be deleted.

Deleting Locked Print Files

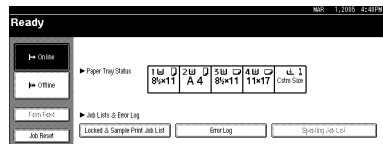
1 Press the **[Printer]** key to display the Printer screen.**2** Press **[Locked & Sample Print Job List]**.

A list of the print files stored in the machine appears.

3 Press **[Locked Print Job List]**.

A list of the locked print files stored appears.

Note

- Depending on the security settings, certain print jobs may not be displayed.

4 Select the file you want to delete by pressing it.**Note**

- Press **[▲Prev.]** or **[▼Next]** to scroll through the list.
- Only one file can be selected at a time.

5 Press **[Delete]**.

The password screen is displayed.

- 6** Enter the password using the number keys, and then press **[OK]**.

The delete confirmation screen appears.

 **Note**

- A confirmation screen will appear if the password is not entered correctly. Press **[OK]** to enter the password again.

- 7** Press **[Yes]**.

After the file has been deleted, the file list screen returns.

 **Note**

- If you do not want to delete the file, press **[No]**.

Checking the Error Log

If a file could not be stored in this machine, you can check the error log on the display panel.

 **Limitation**

- The latest 30 error files are stored in the error log. If a new error file is added when there are 30 error files already stored, the oldest file is deleted. However, if the oldest error file is a locked print file, it is not deleted, but stored instead in the locked print error log until the number of locked print error files reaches 20.
- If the main power switch is turned off, the log will be deleted.

- 1** Press the **[Printer]** key to display the Printer screen.

- 2** Press **[Error Log]**.

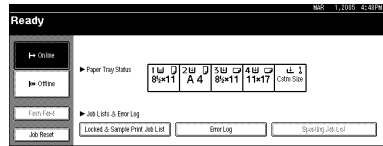

- 3** Select **[Locked Print Job List]**.

 **Note**

- Depending on the security settings, certain print jobs may not be displayed.

- 4** Press **[Details]**.

An error log list appears.

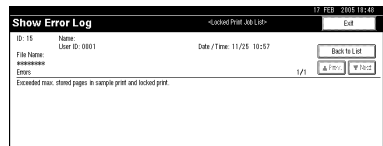

 **Note**

- Press **[▲Prev.]** or **[▼Next]** to scroll through the error files.
- Press **[Exit]** after checking the log.
- To print files that appear in the error log, resend them after stored files have been printed or deleted.

Collate

When printing multiple documents such as handouts for meetings, you can separate sets into order. This function is known as “Collate”. Collate stores data transmitted from a computer in memory. The following are the three types of collate:

◆ Collate

Printed output is assembled as sets in sequential order.

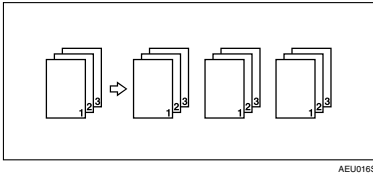

◆ Rotating Collate

Every other print set is rotated by 90 degrees .

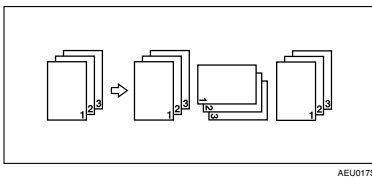

◆ Shift Collate

(The optional finisher is required for this function.)

The finisher shift tray moves backward or forward when a job or set is output, causing the next to shift, so you can separate them.

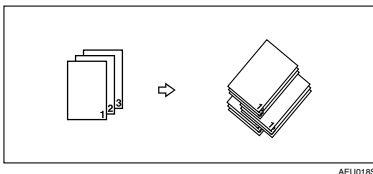

! Limitation

- The optional finisher is required for Shift Collate.
- Rotating Collate is not possible when feeding paper from the bypass tray.
- Shift Collate is not possible when printing on $8\frac{1}{2} \times 5\frac{1}{2}$ .
- If jobs containing pages of various sizes are set, Rotating Collate will not work.
- Rotating Collate, Staple, and Punch functions cannot be combined.

 **Note**

- You can set Collate in the RPCS printer driver.
 - If you cannot make Shift Collate even with the optional finisher installed, options may not be set up correctly in the printer driver. Correct the printer driver's option settings. For details, see the printer driver Help.
- If Auto Continue occurs on the first set, Collate will be canceled.
- If forced printing occurs on the first set, Collate will be canceled.
- If a document with mixed paper sizes or sizes larger than A4, 8¹/₂ "× 11" is set, it can only be collated, even if Rotating Collate has been selected.
- If the following functions are selected, Collate or Shift Collate will be applied even if Rotating Collate is selected:
 - Covers
 - Slip Sheet
- When Rotating Collate has been selected, printing speed will be slower than with other collate functions.
- When setting Collate in the printer driver settings, make sure that a collate option is not selected in the application's print settings. If a collate option is selected, printing will not be as intended.
- The Rotating Collate function requires two paper trays containing same size paper but in different orientations.

 **Reference**

For information about paper sizes and the number of sets you can use Collate, Rotating Collate, and Shift Collate with in every option, see *Copy Reference*.

For printing methods, see the printer driver Help.

Printing with the Finisher

You can collate, staple or punch holes in printed paper by installing the optional finisher. Make sure you read the following precautions when using the optional finisher:

Reference

For information about optional finishers, see *General Settings Guide*.

To use the staple function, see p.92 “Staple”.

To use the punch function, see p.96 “Punch”.

❖ Be sure to make settings for options installed on the machine in the printer drivers.

Reference

To make settings for options in the printer drivers, see p.58 “Making Option Settings for the Printer”.

❖ Be sure to set the paper size and paper orientation in the printer driver when using duplex printing, booklet, combine (layout), staple and punch functions.

Reference

For information about duplex printing, booklet, and layout, see the printer driver Help.

To use the staple function, see p.92 “Staple” and the printer driver Help.

To use the punch function, see p.96 “Punch” and the printer driver Help.

Note

- Depending on the application, print settings may not be enabled and printed output may not be as expected.

❖ When setting staple or collate in the printer driver, make sure that the Collate check box is cleared in the application's [Print] dialog box.

If Collate is enabled in the application, printing will not be as intended.

Staple

With the optional finisher installed, sets can be stapled individually when printing multiple sets.



















Staple Position

The specified staple position varies depending on paper size, type, quantity and feed orientation. The following table shows staple positions:

Paper Orientation on the Machine	Print Data Direction	Staple Position	2 Tray Finisher	Booklet Finisher
	R Vertical	Top Left Slant	R	×
		Top Right Slant	×	×
		Top Left	R	R
		Top Right	R	R
		2 at Top	×	×
		2 at Left	R	R
		2 at Right	R	R
		2 at Center	×	×
	R Horizontal	Top Left Slant	×	×
		Top Right Slant	R	×
		Top Left	R	R
		Top Right	R	R
		2 at Top	R	R
		2 at Left	×	×
		2 at Right	×	×
		2 at Center	×	×

× : means that the staple position is not supported.

AEU037S

Paper Orientation on the Machine	Print Data Direction	Staple Position	2 Tray Finisher	Booklet Finisher
	<div style="border: 1px solid black; padding: 2px; display: inline-block;">R</div> Vertical	Top Left Slant	×	×
		Top Right Slant		×
		Top Left		
		Top Right		
		2 at Top		
		2 at Left	×	×
		2 at Right	×	×
		2 at Center	×	
	<div style="border: 1px solid black; padding: 2px; display: inline-block;">R</div> Horizontal	Top Left Slant		×
		Top Right Slant	×	×
		Top Left		
		Top Right		
		2 at Top	×	×
		2 at Left		
		2 at Right		
		2 at Center	×	

× : means that the staple position is not supported.

AEU0385

Reference

- For paper sizes and maximum numbers of sheets available for stapling, see “Specifications”, *General Settings Guide*.
- For printing methods, see the printer driver Help.
- The staple position will vary when using the PostScript 3 printer driver. For more information, see the PostScript 3 printer driver Help.







Stapling Precautions

Limitation

- Stapling can be done only with the optional finisher installed.
- Stapling cannot be done when paper is fed from the bypass tray.
- You cannot interrupt the current job with a job for another function requiring stapling or collating.
- When printing on letterhead, stapling may not be at the specified position.
- When the optional booklet finisher is installed, and PostScript 3 is used, you cannot specify **[2 at Center]**.

Note

- When the finisher is installed, and when an output tray that cannot output using the staple function has been selected, the paper will be output according to System Settings.
- If you cannot make staple settings even with the finisher installed, options may not be set correctly in the printer driver. Correct option settings in the printer driver. For details, see the printer driver Help.
- When duplex printing is selected, adjust staple positions to the binding orientation.
- When the finisher is being used for another function's job (for example, a copy job), printing will start after that job ends.
- When setting Staple in the printer driver settings, make sure that a collate option is not selected in the print settings of the application. If a collate option is selected in the application, printing will not be as intended.
- Be sure to set paper size and orientation in the printer driver when stapling.
 - Depending on the software you are using, print settings may not be saved and the printed result may not be as expected.
- When printing restarts after removing jammed paper, the printing position may be different, depending on the location of the jam.
 - If the paper jam occurred in the optional finisher, printing will restart from the top page of the data currently being printed, or from the page where the paper jam occurred.
 - If the paper jam occurred in the machine, printing will restart from the page where the paper jam occurred.
- Even if the paper jam occurred in the machine, the error will not be cleared unless the cover of the finisher is opened and closed.















- ❑ Staple printing will be canceled under the following conditions:
 - If the number of staple jobs exceeds maximum. For information about the maximum number, see “Specifications”, *General Settings Guide*.
 - If a paper size that cannot be stapled is selected. For information about paper sizes that can be stapled, see “Specifications”, *General Settings Guide*.
 - If positions other than those fixed for stapling are specified.
 - If there are inconsistencies between the orientation in duplex mode and the staple position.
 - If paper sizes are mixed when a different paper size is specified during a print job.
 - When staples have run out.
 - When feeding paper from the bypass tray.
 - When staples have run out and Auto Continue is set, printing will continue without stapling after the message has been displayed.
- ❑ When using the optional 2 tray finisher or optional booklet finisher to select other than **[2 at Center]**, the following paper sizes can be stapled using Mixed Size mode:
 - A3  and A4 
 - B4  and B5 
 - 11 × 17  and 8¹/₂ × 11 

Punch

With the optional finisher installed, holes can be punched into printed output.

Punch Position

The specified punch position varies depending on paper feed and print data orientation. The following table shows punch positions:

Paper Orientation on the Machine	Print Data Direction	Punch Position		
		2 holes	3 holes	4 holes
	Vertical			
	Horizontal			
	Vertical			
	Horizontal			

AEV0315

Note

- Punch positions will vary slightly from page to page as holes are punched into each sheet individually.

Reference

For information about paper sizes that can be punched, see “Specifications”, *General Settings Guide*.

For printing methods, see the printer driver Help.

The punch position will vary when using the PostScript 3 printer driver. For details, see the PostScript 3 printer driver Help.

Punching Precautions

⚠ Limitation

- Punching cannot be done when paper is fed from the bypass tray.

📝 Note

- If you cannot make punch settings even with the finisher installed, options may not be set correctly in the printer driver. Correct option settings in the printer driver. For details, see the printer driver Help.
- When duplex printing is selected, adjust punch positions according to binding orientation.
- Be sure to set the punch position the same as the staple position when using it with the staple function.
- Be sure to set paper size and orientation in the printer driver when punching.
 - Depending on the software you are using, print settings may not be enabled and the printed result may not be as expected.
- Punch will be canceled under the following conditions:
 - When a paper size that cannot be punched is selected. For information about paper sizes that can be punched, see “Specifications”, *General Settings Guide*.
 - If positions other than those fixed for punching are specified.
 - If there are inconsistencies between the orientation in duplex mode and the punch position.
 - When feeding paper from the bypass tray.
 - When the punch receptacle has become full and Auto Continue is set, printing will continue without punching after the message appears.

Spool Printing

Spool Printing allows print jobs transferred from a computer to be temporarily stored, and then prints them after they are transferred. This shortens printing time as it maximizes printer efficiency.

Important

- During Spool Printing, the hard disk is accessed and the Data-In indicator blinks. Turning off the computer or machine during Spool Printing can damage the hard disk. Also, if the computer or machine is turned off during Spool Printing, spooled jobs will be deleted. Therefore, do not turn the power to the computer or machine off during Spool Printing.

Limitation

- If data is sent to the machine using other protocols besides `diprint`, `lpr`, `ipp`, and `smb`, Spool Printing cannot be performed.
- Up to a maximum of 150 jobs at once can be spool printed.

Note

- Printing the first page with Spool Printing will be slow.
- The computer requires less print processing time when large amounts of data are spooled.
- Stored spool jobs can be viewed or deleted using a Web browser.

Setting Spool Printing

Spool Printing can be set using telnet or a Web browser.

- Using a Web browser
See *Network Guide* or Help for more information.
- Using telnet
Type in “`spoolsw spool on`” to set Spool Printing.
See *Network Guide* for more information about telnet.

Viewing a list of spool jobs on the display panel

If Spool Printing is set, a list of spooled jobs can be viewed on the display panel screen.

Press the **[Printer]** key, and then press **[Spooling Job List]**. A list of spooled jobs appears.

- Deleting jobs
Select files to be deleted, and then press **[Delete]**.

Note

- If Spool Printing is not set, you cannot select **[Spooling Job List]**.

Viewing/Deleting spool jobs in a Web browser

Start the Web browser and enter the machine's IP address in the address bar. This displays the top page.

For more information, see *Network Guide*.

Covers

Using this function, you can insert cover and back sheets fed from a different tray to that of the main paper, and print on them.



Reference

For printing methods, see the printer driver Help.

Limitation

- To use this function, Collate must be set. Rotating Collate cannot be set.

Note

- The cover sheets should be the same size and orientation as the body of the paper.
- If "Auto Tray Select" is set as the paper feed tray for the body paper, the paper will be delivered from a tray containing paper in the  orientation. Therefore, if the cover paper is set to  orientation, the orientation of cover and body will be different.

◆ **Cover Sheet**

Prints the first page of the document on the sheet for the cover page.

- Print on one side
Prints on one side of the cover sheet only, even when duplex printing is selected.

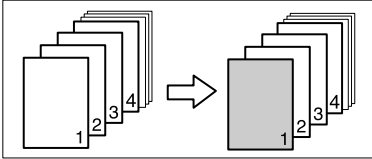

AEV016S

- Print on both sides
Prints on both sides of the cover sheet when duplex printing is selected.
 - Front cover printed on both sides

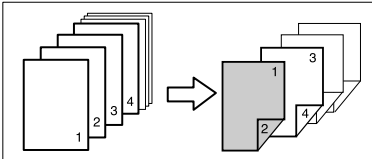

AEV017S

- Front cover printed on one side

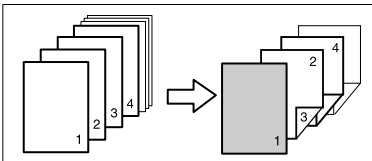

AEV032S

- Blank
 - When printing one side

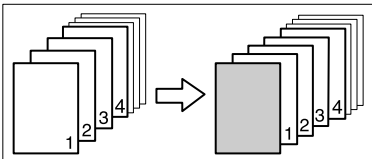

AEV018S

- When printing both sides

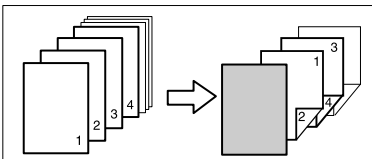

AEV033S

◆ Front and Back Covers

Prints the first and last page of the document as the cover and back cover pages.

- Print on one side
Prints on one side of the cover sheets only, even when duplex printing is selected.
- Back cover page face inside

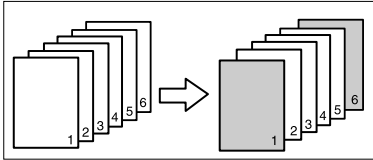

- Back cover page face outside

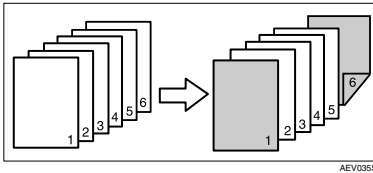

- Print on both sides
Prints on both sides of the cover sheets when duplex printing is selected.
- Front cover printed on both sides, back cover page face inside, and the number of pages is even

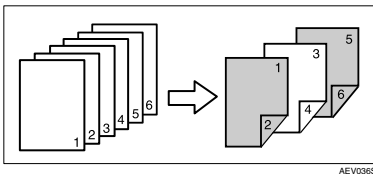

- Front cover printed on both sides, back cover page face inside, and the number of pages is odd

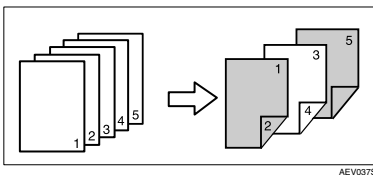

- Front cover printed on one side, back cover page face inside, and the number of pages is even

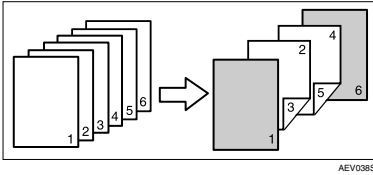

- Front cover printed on one side, back cover page face inside, and the number of pages is odd

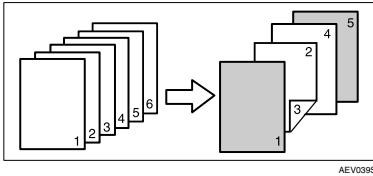

- Blank
 - When printing one side

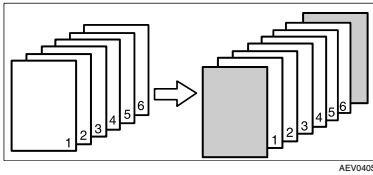

- When printing both sides

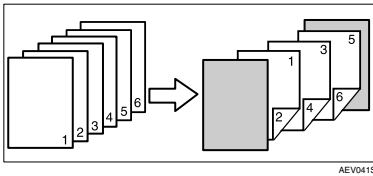

Slip Sheet

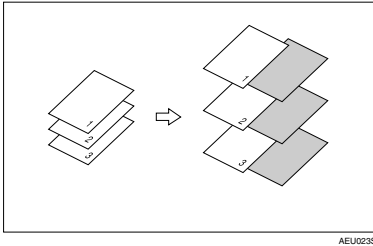

❖ Inserting a slip sheet between each page

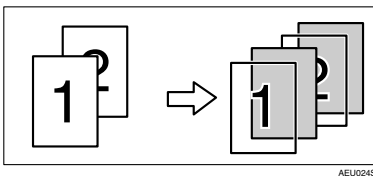

❖ Inserting a slip sheet between OHP transparencies



Note

- Collate cannot be set when using slip sheets.
- When the duplex printing or cover printing is set, you cannot insert slip sheets.
- The slip sheet should be the same size and orientation as the main paper.
- If “Auto Tray Select” has been set as the paper feed tray for the body paper, the paper will be delivered from a tray containing paper in  orientation. Therefore, when the cover paper has been set to  orientation, the orientation of the output cover paper and body paper will be different.
- The same paper feed tray cannot be set for the main paper and slip sheets.

User Defined Pages

Using this function, you can specify the page numbers for each input tray.

Reference

For printing methods, see the printer driver Help.

Limitation

- This function is available with the PCL 6/5c printer driver only.
- If **[Document Server]** is selected under **[Job Type:]**, User Defined Page cannot be used.
- If **[User Defined Pages]** is selected under **[Paper Selection:]** on **[Paper]** tab, **[Layout:]** cannot be selected.
- If **[User Defined Pages]** is selected under **[Paper Selection:]** on **[Paper]** tab, **[Booklet]** under **[Duplex:]** cannot be selected.

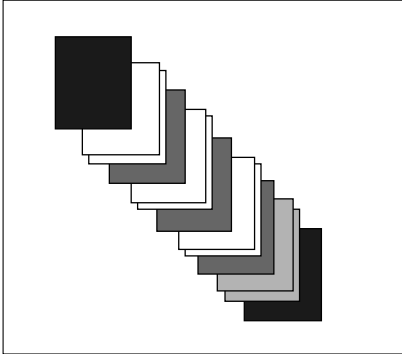

AEV044S

Form Feed

This section gives instructions for operating the machine when there is no tray for the selected paper size or type, or when paper loaded in the machine has run out.

Limitation

- The tray cannot be changed if the following functions are set for it:
 - Staple
 - Punch
 - Duplex Printing to a tray that does not support duplex printing
 - Cover Sheet
 - Front and Back Covers
 - Slip Sheet

Note

- If form feed is selected for a tray with the following settings, you can change the tray by canceling the settings:
 - Staple
 - Punch
- If Auto Continue is selected, form fed paper is printed after a set interval. See p.115 “System”.

If the machine does not have a tray for the selected paper size or paper type, or if the selected paper loaded in the machine has run out, a caution message appears.

If this message appears, do one of the following:

Print Using a Selected Tray

- 1** Select the tray for form feed from those that appear on the display panel.

If you want to print after adding paper to the tray, select the tray after loading the correct paper.

Note

- To load paper in the bypass tray, see p.14 “Setting Paper on the Bypass Tray”.

- 2** Press [Continue].

The machine prints using the selected tray.

Note

- If a tray with a smaller paper size is selected, the print job may be cut short, or other problems may occur.

Canceling Form Feed

1 Press [Reset].

Delete the stored print job, and then cancel form feed.

2 Press [Reset Current Job] or [Reset All Jobs].

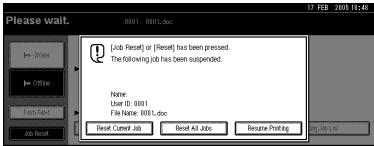

- **[Reset Current Job]**: cancels the print job currently being processed.
- **[Reset All Jobs]**: cancels all jobs in the print queue.
- **[Resume Printing]**: resumes printing jobs.

A confirmation message appears.

3 Press [Yes] to cancel the print job.

Note

- ❑ Press **[No]** to return to the previous display.

Important

- ❑ If the machine is shared by multiple computers, be careful not to accidentally cancel someone else's print job.
- ❑ Under Windows, If the machine is connected to the computer using a parallel cable, sent print jobs may be canceled if **[Reset All Jobs]** is pressed while "waiting . . ." is on the display panel. After the interval set in **[I/O Timeout]** in Printer Features has passed, the next print job can be sent. A print job sent from a different client computer will not be canceled in this case.

Note

- ❑ You cannot stop printing data that has already been processed. For this reason, printing may continue for a few pages after you press **[Job Reset]**.
- ❑ A print job containing a large volume of data may take considerable time to stop.

Reference

p.107 "Canceling a Print Job"

Canceling a Print Job

Windows - Canceling a Print Job

1 Double-click the printer icon on the Windows task tray.

A window appears, showing all print jobs currently queued for printing. Check the current status of the job you want to cancel.

2 Select the name of the job you want to cancel.

3 On the [Document] menu, click [Cancel Printing].

Note

- In Windows XP, Windows Server 2003, and Windows NT 4.0, click [cancel] on the [Document] menu.
- In Windows 95/98/Me/2000 or Windows NT 4.0, you can also open the print job queue window by double-clicking the machine icon in the [Printers] machine window (the [Printers and Faxes] window under Windows XP and Windows Server 2003).

4 Press the [Printer] key on the machine's control panel.

5 Press [Job Reset] on the display panel.

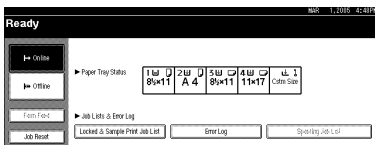

6 Press [Reset Current Job] or [Reset All Jobs].

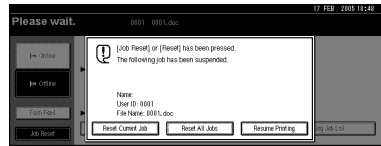

- [Reset Current Job]: cancels the print job currently being processed.
- [Reset All Jobs]: cancels all jobs in the print queue.
- [Resume Printing]: resumes printing jobs.

A confirmation message appears.

7 Press [Yes] to cancel the print job.

Note

- Press [No] to return to the previous display.

Important

- If the machine is shared by multiple computers, be careful not to accidentally cancel someone else's print job.
- If the machine is connected to the computer using a parallel cable, sent print jobs may be canceled if [Reset All Jobs] is pressed while "waiting..." is on the display panel. After the interval set in [I/O Timeout] in Printer Features has passed, the next print job can be sent. A print job sent from a different client computer will not be canceled in this case.

 **Note**

- You cannot stop printing data that has already been processed. For this reason, printing may continue for a few pages after you press **[Job Reset]**.
- A print job containing a large volume of data may take considerable time to stop.

5. Printer Features

Reference

For more information about copier features and system settings, see *Copy Reference* and *General Settings Guide*.

Printer Features Menu

There are seven menu items in the Printer Features menu:

- List / Test Print
- Maintenance
- System
- Host Interface
- PCL Menu
- PS Menu (optional)
- PDF Menu (optional)

You can select the functions in the following table:

Menu	Default
List / Test Print See p.113 "List / Test Print".	Config. Sheet and Error Log
	Config. Page
	Error Log
	Menu List
	PCL Config. / Font Page
	PS Config. / Font Page *1
	PDF Config. / Font Page *1
Maintenance See p.115 "Maintenance".	Hex Dump
	Menu Protect
	List / Test Print Lock
	4 color Graphic Mode

Menu	Default
System See p.115 "System".	Print Error Report
	Auto Continue
	Memory Overflow
	Job Separation *2
	Memory Usage
	Duplex
	Copies
	Blank Page Print
	B&W Page Detect
	Printer Language *1
	Sub Paper Size
	Page Size
	Letterhead Setting
	Bypass Tray Setting Priority
Host Interface See p.118 "Host Interface".	I/O Buffer
	I/O Timeout
PCL Menu See p.119 "PCL Menu". Extend A4 Width	Orientation
	Form Lines
	Font Source
	Font Number
	Point Size
	Font Pitch
	Symbol Set
	Courier Font
	Extend A4 Width
	Append CR to LF
PS Menu (optional) *1 See p.120 "PS Menu".	Data Format
	Resolution
	Color Setting
	Color Profile

Menu	Default
PDF Menu (optional) * ¹ See p.121 "PDF Menu".	Change PDF Password
	PDF Group Password
	Resolution
	Color Setting
	Color Profile

*¹ Appears when the PostScript 3 unit (optional) is installed.

*² Appears when a finisher (optional) is installed.

Adjusting Printer Features

Printer Features allows basic adjustment of operations when using the machine as a printer.

Although factory default settings are suitable for most printing jobs, Printer Features gives you access to a number of settings that control basic printer operations. Printer Features settings you make are retained even when you turn off the machine.

For more information about copier features and system settings, see *Copy Reference* and *General Settings Guide*.

1 Press the **[User Tools/Counter]** key on the control panel.

2 Press **[Printer Features]**.

3 Select the desired item by pressing the tab, and then change its settings.

 **Note**

- [OK]**: Press to make new settings and go back to previous menus.
- [Cancel]**: Press to return to a previous menu without changing any setting.

4 After changing Printer Features settings, press **[Exit]** to return to the User Tools / Counter menu.

 **Note**

- You can also exit from the User Tools / Counter menu by pressing the **[User Tools/Counter]** key.
- Changes made to functions remain in effect even if the machine is turned off.
- You can also exit from the Printer Features menu by pressing **[Exit]** in the main menu.

Printer Features Parameters

List / Test Print

❖ Config. Sheet and Error Log

You can print the configuration page and error log.

❖ Config. Page

You can print the machine's current configuration values.

Reference

p.113 "Printing the configuration page"

❖ Error Log

You can print error logs listing all the errors that occurred during printing.

The latest 30 error files are stored in the error log. If a new error file is added when there are 30 error files already stored, the oldest file is deleted. However, if the oldest error file is a sample print file or a locked print file, it is not deleted, but stored instead in a corresponding print error log until the number of those print error files reaches 20.

In addition to error logs, records of Auto Job Cancel and jobs canceled manually from the control panel can be printed.

❖ Menu List

You can print a Menu List showing the machine's function menus.

❖ PCL Config. / Font Page

You can print the current configuration and installed PCL font list.

❖ PS Config. / Font Page

You can print the current configuration and installed PostScript font list.

Note

- This menu can be selected only when the optional PostScript 3 unit is installed.

❖ PDF Config. / Font Page

You can print the current configuration and installed PDF font list.

Note

- This menu can be selected only when the optional PostScript 3 unit is installed.

❖ Hex Dump

You can print the Hex Dump.

Printing the configuration page

1 Press the **[User Tools/Counter]** key on the control panel.

The User Tools / Counter menu appears.

2 Press **[Printer Features]**.

The Printer Features menu appears.

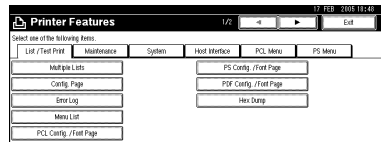

3 Press **[Config. Page]** on the **[List / Test Print]** tab.

The configuration page is printed.

Interpreting the configuration page

❖ System Reference

- Unit Number
Displays the serial number assigned to the board by its manufacturer.
- Total Memory
Displays the total amount of memory (SDRAM) installed on the printer.
- Firmware Version
 - Printer
Displays the version number of the printer firmware.
 - System
Displays the version number of the system firmware.
 - Engine
Displays the version number of the printer engine.
 - LCDC
Displays the version number of the panel display.
 - NIB
Displays the version number of the Network interface.
- Controller Option
This item(s) appears when the controller option(s) is installed.
- HDD: Font / Macro Download
Displays the capacity of the hard disk drive.
- Printer Language
Displays the version number of the printer driver language.
- Options
Displays optional trays installed.
- Consumption Status
Displays the amount of toner remaining.

❖ Paper Input

Displays settings made under the Paper Input menu.

❖ Maintenance

Displays settings made under the Maintenance menu.

❖ System

Displays settings made under the System menu.

Reference

p.115 "System"

❖ PCL Menu

Displays settings made under PCL Menu.

Reference

p.119 "PCL Menu"

❖ PS Menu

Displays settings made under PS Menu.

Reference

p.120 "PS Menu"

❖ PDF Menu

Displays settings made under PDF Menu.

Reference

p.121 "PDF Menu"

❖ Host Interface

Displays settings made under the Host Interface menu.

When DHCP is active on the network, the actual IP address, subnet mask and gateway address appear in parentheses on the configuration page.

Reference

p.118 "Host Interface"

❖ Interface Information

Displays the interface information.

Maintenance

◆ Menu Protect

This procedure lets you protect menu settings from accidental change. It makes it impossible to change menu settings with normal procedures unless you perform the required key operations. In a network environment, only administrators can make changes to menu settings.

- Level 1
You can protect "Maintenance", "System", "Host Interface", "PCL Menu", "PS Menu" and "PDF Menu".
- Level 2
You can protect "Maintenance", "System", "Host Interface", "PCL Menu", "PS Menu", "PDF Menu" and "Tray Paper Settings" in System Settings.
- Off

Note

- Default: *Level 2*
- You can protect menu settings using a Web browser.

◆ List / Test Print Lock

You can lock the [List / Test Print] menu.

- On
- Off

Note

- Default: *Off*

◆ 4 Color Graphic Mode

- Text Priority
Use the optimum CMYK toner combination for text printing.
- Photo Priority
Use the optimum CMYK toner combination for photo printing.

Note

- Default: *Photo Priority*

System

◆ Print Error Report

Select this to have an error report printed when a printer or memory error occurs.

- On
- Off

Note

- Default: *Off*

◆ Auto Continue

You can select this to enable Auto Continue. When it is On, printing continues after a system error occurs.

- Off
- Immediate
- 1 minute
- 5 minutes
- 10 minutes
- 15 minutes

Note

- Default: *Off*

◆ Memory Overflow

Select this to have a memory overflow error report printed.

- Do not Print
- Error Information

Note

- Default: *Do not Print*

◆ Job Separation

You can enable Job Separation.

- On
- Off

Note

- Default: *Off*
- This menu appears only when a finisher (optional) is installed.

❖ Memory Usage

You can select the amount of memory used in Font Priority or Frame Priority, according to paper size or resolution.

- Font Priority
This setting uses memory for registering fonts.
- Frame Priority
This setting uses frame memory for high speed printing.

Note

Default: *Frame Priority*

❖ Duplex

You can select to have print on both sides of each page.

- Off
- Long Edge Bind
- Short Edge Bind

Note

Default: *Off*

❖ Copies

You can specify the number of print sets. This setting is disabled if the number of pages to print has been specified with the printer driver or another command.

- 1 to 999 by 1

Note

Default: 1

❖ Blank Page Print

You can select whether or not to print blank pages.

- On
- Off

Pages that match one of the following conditions are identified as blank.

- There are no images.
- There are images but they are outside of the printable area.
- There are only blank characters.

Note

Default: *On*

The printer does not identify pages with white-colored images as blank.

❖ B&W Page Detect

Set this to enable B&W Page Detect.

- On
- Off

Note

Default: *On*

❖ Printer Language

You can specify the printer language.

- Auto
- PCL
- PS
- PDF

Note

Default: *Auto*

This menu appears only when the PostScript 3 unit (optional) is installed.

◆ Sub Paper Size

You can enable the Auto Substitute Paper Size (LT↔A4) feature.

- Auto
- Off

Note

Default: *Off*

◆ Page Size

You can select the default paper size.

- 12 × 18
- 11 × 17
- 8¹/₂ × 4
- 8¹/₂ × 11
- 5¹/₂ × 8¹/₂
- 7¹/₄ × 10¹/₂
- 8 × 13
- 8¹/₂ × 13
- 8¹/₄ × 13
- A3
- B4 JIS
- A4
- B5 JIS
- A5
- A6
- 8K
- 16K
- 4¹/₈ × 9¹/₂
- 3⁷/₈ × 7¹/₂
- C5 Env
- C6 Env
- DL Env
- Custom Size

Note

Default:

- Inch version: 8¹/₂ × 11
- Metric version: A4

◆ Letterhead Setting

You can rotate original images when printing.

When printing, original images are always rotated by 180 degrees. Therefore, output might not be as expected when printing onto letterhead or preprinted paper requiring orientation. Using this function, you can specify image rotation.

- Off
- Auto Detect
- On (Always)

Note

Default: *Off*

When set to Off, original images are rotated by 180 degrees.

When set to Auto Detect, the machine detects a letterhead or preprinted paper automatically, and does not rotate them.

When set to On (Always), the machine does not rotate.

This function reduces printing speed.

◆ Bypass Tray Setting Priority

You can specify which of the two options, (Printer) Driver / Command or Machine Settings, has priority for determining the paper size for the bypass tray.

- Driver / Command
- Machine Settings

Note

Default: *Driver / Command*

❖ Default Printer Language

You can set the default printer language if the machine cannot find the printer language automatically.

- PCL
- PS
- PDF

Note

- Default: *PCL*
- This menu appears only when the PostScript 3 unit (optional) is installed.

Host Interface

❖ I/O Buffer

You can set the size of the I/O Buffer. Normally it is not necessary to change this setting.

- 128 KB
- 256 KB
- 512 KB

Note

- Default: *128 KB*

❖ I/O Timeout

You can set how many seconds the machine should wait before ending a print job. If data from another port usually arrives in the middle of a print job, you should increase this timeout period.

- 10 seconds
- 15 seconds
- 20 seconds
- 25 seconds
- 60 seconds

Note

- Default: *15 seconds*

PCL Menu

❖ Orientation

You can set the page orientation.

- Portrait
- Landscape

Note

- Default: *Portrait*

❖ Form Lines

You can set the number of lines per page.

- 5 to 128 by 1

Note

- Default:
 - Inch version: 60
 - Metric version: 64

❖ Font Source

You can set the storage location of the default font.

- Resident
- RAM
- HDD
- SD

Note

- Default: *Resident*
- RAM, HDD and SD can be selected only when fonts have been downloaded to the machine.

❖ Font Number

You can set the ID of the default font you want to use.

- 0 to 50 by 1

Note

- Default: 0

❖ Point Size

You can set the point size you want to use for the selected font.

- 4.00 to 999.75 by 0.25

Note

- Default: 12.00
- This setting is effective only with variable-space fonts.

❖ Font Pitch

You can set the number of characters per inch for the selected font.

- 0.44 to 99.99 by 0.01

Note

- Default: 10.00
- This setting is effective only with fixed-space fonts.

❖ Symbol Set

You can specify the set of print characters for the selected font. The available options are as follows:

Roman-8, ISO L1, ISO L2, ISO L5, PC-8, PC-8 D/N, PC-850, PC-852, PC8-TK, Win L1, Win L2, Win L5, Desktop, PS Text, VN Intl, VN US, MS Publ, Math-8, PS Math, VN Math, Pifont, Legal, ISO 4, ISO 6, ISO 11, ISO 15, ISO 17, ISO 21, ISO 60, ISO 69, Win 3.0

Note

- Default: *PC-8*

❖ Courier Font

You can select a courier font type.

- Regular
- Dark

Note

- Default: *Regular*

◆ Extend A4 Width

You can extend the printing area width (when printing on A4 sheet with PCL).

- Off
- On

Note

- Default: *Off*
- When the setting is On, the width will be 8¹/₂ inches.

◆ Append CR to LF

When set to On, a carriage return will follow each line feed: CR=CR, LF=CR-LF, FF=CR-FF.

- Off
- On

Note

- Default: *Off*

◆ Resolution

You can set the print resolution in dots per inch.

- 300 dpi
- 600 dpi (Fast)
- 600 dpi (Standard)

Note

- Default: *600 dpi (Fast)*

PS Menu

This menu appears only when the optional PostScript 3 unit is installed.

◆ Data Format

You can select a data format.

- Binary Data
- TBCP

Limitation

- This setting is not effective when operating the machine with a parallel, USB, or EtherTalk connection.
- When operating the machine with a parallel or USB connection, if binary data is sent from the printer driver, the print job is canceled.
- When operating the machine with an Ethernet connection, the print job is canceled under the following conditions;
 - The printer driver data format is TBCP, and the data format selected on the display panel is Binary Data.
 - The printer driver data format is binary, and the data format selected on the display panel is TBCP.

Note

- Default: *Binary Data*

◆ Resolution

You can set the print resolution in dots per inch.

- 600 dpi (Fast)
- 600 dpi (Standard)
- 1200 dpi

Note

- Default: *600 dpi (Fast)*

❖ Color Setting

You can make an RGB setting.

- None
- Fine
- Super Fine

Note

Default: *Super Fine*

❖ Color Profile

You can set the color profile.

- Auto
- Presentation
- Solid Color
- Photographic
- User Setting

Note

Default: *Auto*

PDF Menu

This menu appears only when the optional PostScript 3 Unit is installed.

❖ Change PDF Password

Set the password for the PDF file executing PDF Direct Print.

- Current Password
- New Password
- Confirm New Password

A password can be set using on the Web Image Monitor, but in this case the password information is sent through the network. If security is a priority, set the password using this menu from the Control Panel.

Note

Default: *Not Set*

❖ PDF Group Password

Set the group password already specified with DeskTopBinder Lite.

- Current Password
- New Password
- Confirm New Password

A password can be set using on the Web Image Monitor, but in this case the password information is sent through the network. If security is a priority, set the password using this menu from the Control Panel.

Note

Default: *Not Set*

❖ Resolution

You can set the print resolution in dots per inch.

- 600 dpi (Fast)
- 600 dpi (Standard)
- 1200 dpi

Note

Default: *600 dpi (Fast)*

❖ Color Setting

You can make an RGB setting.

- None
- Fine
- Super Fine

Note

Default: *Super Fine*

❖ Color Profile

You can set the color profile.

- Auto
- Presentation
- Solid Color
- Photographic
- User Setting

Note

Default: *Auto*

6. Using the Document Server

Accessing the Document Server

The Document Server enables you to store documents on the machine's hard disk, allowing you to edit and print as and when you want.

Limitation

- Applications with their own drivers, such as PageMaker, do not support this function.

Reference

For more information about Document Server functions, see *General Settings Guide*.

For information about how to access Document Server from a client, see the printer driver Help.

Note

- When you use the Document Server, the following functions can be selected using the machine's control panel:
 - Copies
 - Collate
 - Duplex
 - Staple
 - Punch
 - Paper selection: Paper source tray, paper type, paper output tray.
 - Functions related to paper selection: Cover Sheet, Slip Sheet.
- The above items are dimmed, so you cannot set them from the printer properties dialog box when the Document Server is selected.
- You must enter a user ID, using up to eight alphanumeric characters.
- You should enter a Password and File Name to distinguish the job from others.
- Up to 2,000 files can be stored in the Document Server. No new files can be stored after 2,000 is reached. Even if less than 2,000 files are stored, new files cannot be stored when
 - a file to be stored contains more than 1,000 pages,
 - the total number of pages contained in files stored exceeds 9,000,
 - the hard disk is full.
- The Document Server also stores files scanned using the Automatic Document Feeder (ADF) or exposure glass. You should delete unnecessary stored files once in a while so as not to exceed the capacity of the hard disk. For how to delete stored files, see *General Settings Guide*.
- When using the hard disk for functions other than those of Document Server, you may be unable to store new files in the Document Server, even if there are less than 2,000 files stored.

7. The Functions and Settings of the Machine

Mainframe

Network Guide, PostScript 3 Supplement, and UNIX Supplement cover all models, and therefore contain all the functions and settings. This chapter describes the functions and setting items used for configuring the model you are using.

Reference

For details about functions and setting items, see *Network Guide*, *PostScript 3 Supplement* and *UNIX Supplement*.

Functions

The following functions are available with the machine:

- Copy
- Printer
- Scanner
- Fax
- Document Server

Note

- The machine must be equipped with the Printer/Scanner Unit in order to use the printer or scanner function.

Interface

The following interfaces are available with the machine:

- Ethernet (100BASE-TX / 10BASE-T)
- USB (2.0 / 1.1)
- IEEE 1284 (parallel)
- IEEE 1394 (SCSI print)
- IEEE 802.11b (wireless LAN)
- Bluetooth

Note

- To use the IEEE 1284, IEEE 1394 (SCSI print), IEEE 802.11b (wireless LAN), or Bluetooth interface, the machine must be equipped with the corresponding unit for that interface.
- You cannot have the IEEE 1284, IEEE 1394 (SCSI print), IEEE 802.11b (wireless LAN), and Bluetooth interface on the machine at the same time.

List of the Setting Items

Web Image Monitor

The following are the items of Web Image Monitor available with the machine:

R : Read

W : Write

— : None

 **Note**

Depending on the security settings, certain items may not be displayed.

Menu		Before login	After login as Admin.	
Top Page		R	R	
Reset Printer Job		—	RW	
Reset Device		—	RW	
Status	Input Tray	R	R	
	Output Tray	R	R	
	Toner	R	R	
	Function	R	R	
	System	R	R	
	Counter	R	R	
	Printer Language	R	R	
Document Server		RW	RW	
Fax Received File		RW	—	
Job	Printer	Job History	R	R
		Error Log	RW	RW
		Locked & Sample Print	RW	RW
	Fax History	Transmission	R	R
		Reception	R	R
		LAN-Fax	R	R
	Document Server		RW	RW
Address Book		—	RW	
Inquiry		R	R	

Menu		Before login	After login as Admin.	
Configuration	Device Settings	System	R	RW
		Paper	R	RW
		Timer Settings	R	RW
		E-mail	R	RW
		File Transfer	—	RW
		Program/Change Administrator	—	RW
		User Authentication Management	—	RW
		Administrator Authentication Management	—	RW
	Printer		R	RW
	Fax	General	—	RW
		Administrator Tools	—	RW
		E-mail Settings	—	RW
		IP-Fax Settings	—	RW
		Gateway Settings	—	RW
		Parameter Settings	—	RW
	Interface		R	R
	Network	Protocol	R	RW
		TCP/IP	R	RW
		NetWare	R	RW
		AppleTalk	R	RW
		SMB	R	RW
		SNMP	—	RW
		SNMPv3	—	RW
		Rendezvous	R	RW
		System Log	R	R
	Webpage		RW	RW
	Security	Access Control	—	RW
IPP Authentication		—	RW	
SSL/TLS		—	RW	
Certificates		—	RW	

telnet

The following telnet can be used with the machine:

access, appletalk, autonet, btconfig, dhcp, diprint, dns, domainname, help, hostname, ifconfig, info, ipp, netware, passwd, prnlog, rendezvous, route, set, show, slp, smb, snmp, spoolsw, sprint, status, syslog, web, wiconfig, wins

UNIX

The following UNIX commands can be used with the machine:

Device Option	Value	Function Summary.
binding	longedge, shortedge, left, top, right	Specifies the binding direction for duplex printing.
copies	Number of copies (1 - 999)	Specifies the number of copies.
duplex	off, on	Specifies whether duplex printing is on or off.
filetype	pcl, postscript (rps)	Specifies the printer language for printing.
filter	text	Specifies the text printing.
mediatype	plain, recycled, special, thick, transparency, color, letterhead, preprinted, labels, plainduplexbacks, thickduplexbacks, plainorrecycled	Specifies the paper type.
orientation	portrait, landscape	Specifies the feed direction of the paper.
outbin	lower, finishershift, finisherproof, finisherbooklet, upper, lower2, lower3	Specifies the output tray.
paper	a3, a4, a5, a6, jisb4, jisb5, jisb6, ledger, legal, letter, halfletter, executive, fgl, foolscap, folio, com10, monarch, c6, c5, dl, k8, k16, a3wide, custom	Specifies the paper size.
punch	off, leftport, leftland, rightport, rightland, topport, topland	Specifies the punch position.
punchhole	jp2, us2, us3, eu4, neu4	Specifies the punch hole.
qty	Number of collated sets (1 - 999)	Specifies the number to collate.
resolution	value of resolution (300, 600, 1200)	Specifies the resolution for printing.

Device Option	Value	Function Summary.
staple	off, lefttop, righttop, lefttopslantport, lefttopslantland, lefttopvertport, lefttopvertland, left2port, left2land, right2port, right2land, righttopvertport, righttopvertland, righttopslantport, righttopslantland, righttophorizport, righttophorizland, top2port, top2land, lefttophorizport, lefttophorizland, booklet	Specifies the staple position.
tray	tray1, tray2, tray3, tray4, lct, bypass, all	Specifies the input tray.

Settings that can be used with PostScript 3

The following PostScript 3 settings can be used with the machine:

Settings	Selectable Items
Black Over Print	Off, On
CMYK Simulation Profile:	Off, US OffsetPrint, Euroscale, JapanColor, Palette Color
Collate	Off, On
Color/ Black and White	Color, Black and White
Color Profile	Auto, User Setting, Photographic, Presentation, Solid Color, CLP Simulation
Color Setting:	Off, Fine, Super Fine
Dithering	Auto, User Setting, Text, Photographic
Duplex	Off, Open to Left, Open to Top
Fit to Print Size:	Prompt User, Nearest Size and Scale, Nearest Size and Crop
Gradation	Fast, Standard
Gray Reproduction	Black by K, Black/Gray by K, CMY + K
Image Smoothing	Off, On, Auto, Less than 90 ppi, Less than 150 ppi, Less than 200 ppi, Less than 300 ppi
Input Tray	Bypass Tray, Tray 1, Tray 2, Tray 3, Tray 4
Paper Size	See <i>General Setting Guide</i> .
Paper Type	See <i>General Setting Guide</i> .
Punch	Off, 2 at Left, 3 at Left, 4 at Left, 2 at Right, 3 at Right, 4 at Right, 2 at Top, 3 at Top, 4 at Top
Resolution	600 dpi, 1200 dpi
Staple	Off, Top Left, Top Right, 2 at Left, 2 at Right, 2 at Top
Toner Saver	Off, On

8. Appendix

Software and Utilities Included on the CD-ROM

Three CD-ROMs come with this printer: "Printer Drivers and Utilities", "Operating Instructions", and "Scanner Driver and Document Management Utility". The following are included on the three separate CD-ROMs.

◆ **Font Manager 2000**

For installing new screen fonts, or organizing and managing fonts already in the system. For details about Font Manager 2000, see the manual on the CD-ROM labeled "Printer Drivers and Utilities".

◆ **SmartDeviceMonitor for Admin**

For the system administrator to manage network printers.

Reference

SmartDeviceMonitor for Admin Help

◆ **SmartDeviceMonitor for Client**

For users to manage their network print status.

Reference

SmartDeviceMonitor for Client Help

◆ **1394 Utility**

For the optional IEEE 1394 interface unit. For details, see the Readme file or the manual provided with the optional IEEE 1394 interface unit.

◆ **USB Printing Support**

For connection to Windows 98 SE/Me computers via USB.

◆ **Acrobat Reader**

This utility allows you to read PDF files (Portable Document Format).

Note

- Documentation about using the machine is included on the CD-ROM in PDF format. For details about using Acrobat Reader, see Acrobat Reader online Help.

◆ **Printer Utility for Mac**

This utility allows users to download and manage a variety of fonts as well as manage printers. For details about this utility, see *PostScript Supplement*.

Viewing the contents of the CD-ROM

Follow the procedure below to view the contents of the CD-ROM.

1 Insert the CD-ROM into the CD-ROM drive.

The installer starts.

2 Click **[Browse This CD-ROM]**.

Explorer starts and displays the contents of the CD-ROM.

Printer Drivers for This Printer

Printing requires installing a printer driver appropriate to your operating system. The following drivers are included on the CD-ROM provided with this machine.

Printer Language	PCL 6	PCL 5c	RPCS	PostScript 3
Windows 95 ^{*1}	OK	OK	OK	OK ^{*12}
Windows 98 ^{*2}	OK	OK	OK	OK ^{*12}
Windows Me ^{*3}	OK	OK	OK	OK ^{*12}
Windows 2000 ^{*4}	OK	OK	OK	OK ^{*13}
Windows XP ^{*5}	OK	OK	OK	OK ^{*13}
Windows Server 2003 ^{*6}	OK	OK	OK	OK ^{*13}
Windows NT 4.0 ^{*7}	OK ^{*11}	OK ^{*10}	OK ^{*10}	OK ^{*11} ^{*12}
Mac OS ^{*8}	—	—	—	OK ^{*12}
Mac OS X ^{*9}	—	—	—	OK ^{*14}

^{*1} Microsoft Windows 95 operating system

^{*2} Microsoft Windows 98 operating system

^{*3} Microsoft Windows Millennium Edition

^{*4} Microsoft Windows 2000 Advanced Server

Microsoft Windows 2000 Server

Microsoft Windows 2000 Professional

^{*5} Microsoft Windows XP Professional

Microsoft Windows XP Home Edition

^{*6} Microsoft Windows Server 2003 Standard Edition

Microsoft Windows Server 2003 Enterprise Edition

^{*7} Microsoft Windows NT Server operating system version 4.0, Microsoft Windows NT Workstation operating system version 4.0 in a computer using x86 processors.

^{*8} Versions 8.6 to 9.2 of the Mac OS (Mac OS X Classic mode is supported.)

^{*9} Mac OS X 10.1 or later (Native mode)

^{*10} Requires Service Pack 4 or later.

^{*11} Requires Service Pack 6 or later.

^{*12} The Adobe PostScript 3 printer drivers and PostScript Printer Description (PPD) files are included on the CD-ROM labeled "Printer Drivers and Utilities".

^{*13} The PostScript Printer Description (PPD) files are included on the CD-ROM labeled "Printer Drivers and Utilities".

^{*14} The Adobe PostScript Printer Description (PPD) installer is included on the CD-ROM labeled "Printer Drivers and Utilities".

◆ PCL printer drivers

Two kinds of PCL printer driver (PCL 5c and PCL 6) are included on the CD-ROM that comes with this machine. These drivers allow your computer to communicate with this machine via a printer language.

 Note

- ❑ Some applications may require installation of the PCL 5c printer driver. In this case, you can install PCL 5c without having to install PCL 6.

 Reference

See p.19 "Preparing the Machine".

◆ RPCS printer driver

This printer driver allows the computer to communicate with the printer using a printer language. In addition to the conventional user interface, another preset user interface is provided.

 Reference

See p.19 "Preparing the Machine".

◆ Adobe PostScript Printer Drivers and PPD files

Adobe PostScript printer drivers and the PPD files are included on the CD-ROM provided with this machine. Adobe PostScript printer drivers allow the computer to communicate with the printer using a printer language. PPD files allow the printer driver to enable specific printer functions.

 Reference

See *PostScript 3 Supplement*.

◆ PPD files

PPD files are included on the CD-ROM provided with this machine. PPD files allow the printer driver to enable specific printer functions.

 Reference

See *PostScript 3 Supplement*.

SmartDeviceMonitor for Admin

SmartDeviceMonitor for Admin is an application that uses TCP/IP and IPX/SPX to monitor network printers. It can monitor multiple network printers using IP address. We recommend that network administrators use this application

❖ File path

SmartDeviceMonitor for Admin is stored in the following folder on the CD-ROM.

NETWORK\DEVMON\ADMIN\Disk1

Operating system	Protocol stack
Windows 95/98/Me	TCP/IP provided with Windows 95/98/Me IPX/SPX provided with Windows 95/98/Me NetWare Client provided with Windows 95/98 Novell Client provided with Windows 95/98
Windows 2000	TCP/IP provided with Windows 2000 IPX/SPX provided with Windows 2000 NetWare Client provided with Windows 2000 Novell Client provided with Windows 2000 or Window NT
Windows XP	TCP/IP provided with Windows XP IPX/SPX provided with Windows XP NetWare Client provided with Windows XP Novell Client provided with Windows XP
Windows Server 2003	TCP/IP provided with Windows Server 2003 IPX/SPX provided with Windows Server 2003 NetWare Client provided with Windows Server 2003 Novell Client provided with Windows Server 2003
Windows NT 4.0	TCP/IP provided with Windows NT IPX/SPX provided with Windows NT Client Service for NetWare provided with Windows NT Novell Client provided with Windows 2000 or Windows NT

❖ Available functions

SmartDeviceMonitor for Admin has the following functions to check:

- printer supplies such as paper or toner;
- results of print jobs executed from the computer.

🔍 Reference

For information about the operations of the system administrator, see *Network Guide*.

For information about using SmartDeviceMonitor for Admin, see SmartDeviceMonitor for Admin Help.

SmartDeviceMonitor for Client

SmartDeviceMonitor for Client has the following functions. We recommend that users install this application.

- Printing in a peer-to-peer network, using TCP/IP, NetBEUI, and IPP from Windows 95/98/Me/2000/XP, Windows Server 2003, and Windows NT 4.0.
- Constantly monitoring the status of devices on the network using TCP/IP and IPX/SPX.

❖ File path

SmartDeviceMonitor for Client is stored in the following folder on the CD-ROM.

NETWORK\DEVMON\CLIENT\Disk1

Operating system	Protocol stack
Windows 95/98/Me	TCP/IP provided with Windows 95/98/Me IPX/SPX provided with Windows 95/98/Me NetBEUI provided with Windows 95/98/Me NetWare Client provided with Windows 95/98/Me Novell Client provided with Windows 95/98/Me
Windows 2000	TCP/IP provided with Windows 2000 IPX/SPX provided with Windows 2000 NetBEUI provided with Windows 2000 NetWare Client provided with Windows 2000 Novell Client provided with Windows 2000 or NT
Windows XP	TCP/IP provided with Windows XP IPX/SPX provided with Windows XP NetWare Client provided with Windows XP Novell Client provided with Windows XP
Windows Server 2003	TCP/IP provided with Windows Server 2003 IPX/SPX provided with Windows Server 2003 NetWare Client provided with Windows Server 2003 Novell Client provided with Windows Server 2003
Windows NT 4.0	TCP/IP provided with Windows NT IPX/SPX provided with Windows NT NetBEUI provided with Windows NT Client Service for NetWare provided with Windows NT Novell Client provided with Windows 2000 or Windows NT

◆ Available functions

SmartDeviceMonitor for Client has the following functions.

- Peer-to-peer print function
 - Prints directly on the network printer without sending any data to a print server.
 - Prints on a substitute printer when there are too many jobs waiting on the specified printer, or when an error disables printing (Recovery Printing).
 - Allocates multiple print jobs to multiple printers (Parallel Printing).
 - Executes prior group registration of printers specified for Recovery Printing or Parallel Printing.
- Notification function
 - Displays an error message when there is an error on the specified printer while transferring or printing data.
 - Notifies a print completion. You can also be notified of the print condition, such as displaying the notice only when Recovery Printing is executed.
- Monitoring function
 - Checks printer supplies such as paper or toner.
 - Simultaneously monitors multiple printers in use.
 - Checks the printer's network settings and detailed information of printers.
 - Enables you to check the print job log using the user ID

! Limitation

- For Recovery Printing or Parallel Printing, the options on the printers must be the same. If a necessary option is not installed, a printer cannot be used for Recovery Printing or Parallel Printing.
- For Recovery Printing or Parallel Printing, the paper loaded in the printers must be the same. When a tray is selected for printing, load the same paper in that tray in all printers.
- For Recovery Printing or Parallel Printing, the print results may be different if the printers are not the same model or have exactly the same options.
- If you select Sample Print or Locked Print, you cannot select Recovery Printing or Parallel Printing.

🔍 Reference

SmartDeviceMonitor for Client Help

Troubleshooting

Error & Status Messages on the Display Panel

This section describes the principal messages that appear on the panel display. If a message not described here appears, act according to the message.

Reference

Before turning the main power off, see "Turning On the Power", *General Settings Guide*.

◆ Status messages

Message	Status
Hex Dump Mode	In Hex Dump mode, the machine receives data in hexadecimal format. Turn off the machine after printing, and then turn back on.
Offline	The machine is offline. To start printing, switch the machine online by pressing [Online] on the display panel.
Please wait.	The machine is preparing the development unit. Wait a while.
Printing...	The machine is printing. Wait a while.
Ready	This is the default ready message. The machine is ready for use. No action is required.
Resetting job...	The machine is resetting the print job. Wait until "Ready" appears on the display panel.
Setting change...	The machine is setting changing. Wait a while.
Waiting...	The machine is waiting for the next data to print. Wait a while.

◆ Alert messages

Messages/Second messages	Causes	Solutions
Authentication has failed.	The login user name or password entered is incorrect. The machine currently cannot perform authentication.	Check your login user name and password. Consult an administrator.
Cannot store data of this size.	The maximum size of files stored in the document server has been exceeded.	Reduce the size of the file you want to download.
Collate has been cancelled.	The collate print function has been canceled.	Turn off the main power switch, and back on again. If the message appears again, contact your sales or service representative.

Messages/Second messages	Causes	Solutions
Data storage error.	Sample print, locked print, or accessing the document server was attempted without the hard disk installed, or the hard disk is damaged.	Contact your sales or service representative.
Driver Setting Error (Memory)	There is an error in the downloaded font(s).	Reset the parameter for downloading fonts.
	Insufficient memory or memory settings for the printer driver may not match memory actually installed.	Specify correct memory capacity on the [Change Accessories...] tab in the RPCS printer driver.
		To print the image correctly, increase memory capacity, or reduce resolution image.
Duplex has been cancelled.	Duplex printing has been cancelled.	Check the paper used is suitable for duplex printing. Or, increase memory capacity. When installing a memory module in the machine, contact your sales or service representative.
Ethernet board has a problem.	An error has occurred in the Ethernet board.	Turn off the main power switch, and back on again. If the message appears again, contact your sales or service representative.
Exceeded max. capacity of document server. Cannot store.	Hard disk drive capacity exceeded storing to the Document Server.	Delete some files stored in the Document Server or decrease the file size to be downloaded.
Exceeded max. capacity of system file. Cannot print PDF file(s).	File system capacity is full, and the PDF file cannot be printed.	Delete unnecessary files from the hard disk.
Exceeded max. number of files of document server. Cannot store.	The maximum number of files stored in the Document Server has been exceeded.	Delete some files stored in the Document Server.
Exceeded max. number of pages of document server. Cannot store.	The maximum number of pages stored in the Document Server has been exceeded.	Delete some pages stored in the Document Server or decrease the number of pages to be downloaded.
Exceeded max. pages. Collate is incomplete.	The maximum number of pages has been exceeded for collation.	Turn off the main power switch, and back on again. Reduce the number of pages to be printed. If the message appears again, contact your sales or service representative.

Messages/Second messages	Causes	Solutions
Exceeded max. stored files in sample print and locked print.	The maximum number of stored files has been exceeded during Sample Print or Locked Print.	Delete some stored files or reduce file sizes.
Exceeded max. stored pages in sample print and locked print.	The maximum number of stored pages has been exceeded during Sample Print or Locked Print.	Reduce the number of pages to be printed.
File system error. Cannot print PDF file(s).	The PDF file cannot be printed due to file system error.	Check the PDF file for errors.
HDD is full.	The maximum hard disk area size for form/font has been exceeded.	Delete unused form / font types.
	An HDD overflow error occurred during Sample Print or Locked Print.	Delete some stored files, or reduce the size of the file to be downloaded.
HDD has a problem.	An error has occurred in the hard disk drive.	Turn off the main power switch, and back on again. If the message appears again, contact your sales or service representative.
IEEE 1394 board has a problem.	An error occurred in the IEEE 1394 board	
IEEE 802.11b (Wireless LAN) has a problem.	IEEE 802.11b interface unit was not inserted when the machine was turned on, or it was pulled out after the machine turned on.	Turn off the machine and check the IEEE 802.11b interface unit is inserted correctly. Then, turn the machine on again. If the message appears again, call your service center.
Output tray has been changed.	The output tray has been changed because of the paper size limitation of the selected tray.	Select the correct output tray.
Paper in staple tray. Open Finisher Cover and remove paper.	There is paper remaining inside the finisher.	Open the cover of the finisher, and remove the paper.
Parallel I/F board has a problem.	An error has occurred in the parallel interface board.	Contact your sales or service representative.
PDF file error. Cannot print.	The PDF file cannot be printed due to syntax error.	Check the PDF file for errors.
PDF file printing is not allowed. Cannot print.	An attempt was made to print a restricted document.	The PDF file cannot be printed.
PDF password is incorrect. Cannot print.	The entered password does not match that set for printing encrypted documents.	Enter the correct password.

Messages/Second messages	Causes	Solutions
Print overrun.	The image data has been thinned out due to image compression.	Increase memory capacity. When installing a memory module in the machine, contact your sales or service representative.
Punch has been cancelled.	Punch has been canceled.	Check the paper feed direction, paper orientation, and punch position.
Staple has been cancelled.	Staple printing has been canceled.	Check the paper feed direction, paper orientation and stapling position.
The print job has been cancelled because capture file(s) could not be stored: Exceeded max. memory.	An HDD overflow error has occurred when storing capture file(s).	Delete some files stored in the Document Server or reduce the size of files to be printed.
The print job has been cancelled because capture file(s) could not be stored: Exceeded max. number of files.	The maximum number of stored capture files has been exceeded.	Delete some files stored in the Document Server.
The print job has been cancelled because capture file(s) could not be stored: Exceeded max. number of pages per file.	The maximum number of stored capture pages has been exceeded.	Delete some files stored in the Document Server or reduce the size of files to be printed.
 Toner is almost empty.	The toner has almost run out.	Replace the toner cartridge with a new one.
Turn the main power switch off then on.	The IEEE 802.11b interface unit may have come off, or an error may have occurred in the IEEE 802.11b interface unit.	Turn off the main power switch, and check the IEEE 802.11b interface unit is installed correctly. If the message appears again, contact your sales or service representative.
USB has a problem.	An error has occurred in the USB interface.	Turn off the main power switch, and back on again. If the message appears again, contact your sales or service representative.
You do not have a privilege to use this function. This job has been cancelled.	Print job canceled due to user restrictions. The login user name or password entered is incorrect. The right to use the function has not been set.	Check your login user name and password. Consult an administrator.
You do not have a privilege to use this function. This operation has been cancelled.	The right to use this function has not been set.	Consult an administrator.

Checking the Error Log

If files could not be stored due to printing errors, identify the cause of the errors by checking the error log on the control panel.

! Limitation

- The latest 30 error files are stored in the error log. If a new error file is added when there are 30 error files already stored, the oldest file is deleted. However, if the oldest error file is a sample print file or a locked print file, it is not deleted, but stored instead in a corresponding print error log until the number of those print error files reaches 20.
- If the main power switch is turned off, the log is deleted.

1 Press the **[Printer]** key to display the Printer screen.

2 Press **[Error Log]**.

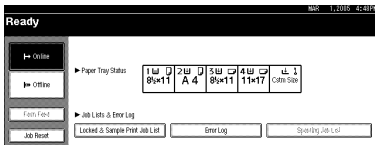

An error log list appears.

The Machine Does Not Print

Possible Cause	Solutions
Is the power on?	Check the cable is securely plugged into the power outlet and the machine. Turn on the main power switch.
Is the machine online?	If not, press [▶ Online] on the display panel.
Does the printer function status indicator stay red?	If so, check the error message on the display panel and take required action.
Is there a warning status or error message on the display panel?	If so, check the error message or warning status on the display panel and take the required action.
Does the "Updating the destination list...Please wait. Specified destination(s) or sender's name has been cleared." message appear?	The destination list is being updated from the network using SmartDeviceMonitor for Admin. Depending on the number of destinations to be updated, there may be some delay before you can resume operation. Operations are not possible while this message is displayed. Wait until the message disappears. Do not switch off the power while this message is displayed.
Can you print a configuration page?	If you cannot print a configuration page, there maybe a machine malfunction. Contact your sales or service representative. See p.113 "Printing the configuration page" for printing a configuration page.
Is the interface cable connected securely to the machine and computer?	Connect the interface cable securely. If it has a fastener, fasten that securely as well. See p.11 "Connecting the Machine".
Are you using the correct interface cable?	The type of interface cable you should use depends on the computer. Be sure to use the correct one. If the cable is damaged or worn, replace it. See p.11 "Connecting the Machine".
Was the interface cable connected after the machine was turned on?	Connect the interface cable <i>before</i> turning on the machine.
Is the signal status satisfactory when using wireless LAN in infrastructure mode ?	To check signal status, press [User Tools/Counter] key on the display panel, and then press [System Settings] on the display panel. On the [Interface Settings] tab, select [IEEE 802.11b], and then press [Wireless LAN Signal]. If signal quality is poor, move the machine to a location where radio waves can pass or remove objects that might cause interference. Note <input type="checkbox"/> You can check signal status only when using wireless LAN in infrastructure mode.
When using wireless LAN, is the SSID correctly set?	Check using the machine's display panel that the SSID is correctly set. See "Interface Settings/IEEE 802.11b (Option)", <i>General Settings Guide</i> .

Possible Cause	Solutions
When using wireless LAN, is the access point correctly set?	Check access point settings when in infrastructure mode. Depending on the access point, client access may be limited by MAC address. Also, check there are no problems in transmission between access point and wired clients, and between access point and wireless clients.
When using wireless LAN, is the LED on the wireless LAN card lit or blinking?	Confirm the orange LED is lit, and the green LED is lit or blinks during transmission.
Is the wireless LAN being used in ad hoc mode?	Turn the main power off and back on. See "Turning On the Power", General Settings Guide. Otherwise, configure [Network] in [Interface Settings] in [System Settings] . See "Setting Up the Machine on a Network", <i>Network Guide</i> .
Did you change the option settings on the machine?	When using the RPCS printer driver on Windows 2000 and connecting with IEEE 1394, an error may occur if you change the option settings on the machine. In this case, follow the procedure below: <ol style="list-style-type: none"> ① Unplug the IEEE 1394 interface cables connected to the computer. ② Run the utility tool for the IEEE 1394 interface board, which is stored in the following path on the CD-ROM "Printer Drivers and Utilities". <code>\UTILITY\1394\</code>  Reference For more information about using the utility tool for IEEE 1394, see the README file in the same directory on the CD-ROM. ③ Restart the computer. ④ Connect the computer to the machine using the IEEE 1394 interface cables.
Is the weekly timer set?	The printer may not be able to print because of the weekly timer setting. Check the setting. For details, see "User Tools (System Settings)", <i>General Settings Guide</i> .
Print cannot be performed from the printer driver.	The login user name, password, or driver encryption key entered is incorrect. A high level of encryption was set using the Extended Security function. <ul style="list-style-type: none"> • Check your login user name, password, and driver encryption key. • For information about the Extended Security settings, consult an administrator.

Problem	Solutions
Is the Data In indicator blinking or lit after starting the print job?	<p>If not, data is not being sent to the machine.</p> <p>❖ When the machine is connected to the computer using the interface cable</p> <p>Check the machine port settings are correct. For parallel port connection, port LPT1 or LPT2 should be set.</p> <ul style="list-style-type: none"> • Windows 95/98/Me <ol style="list-style-type: none"> ① Click the [Start] button, point to [Settings], and then click [Printers]. ② Click the icon of the machine. On the [File] menu, click [Properties]. ③ Click the [Details] tab. ④ In the [Print to the following port:] list, confirm the correct port is selected. • Windows 2000 <ol style="list-style-type: none"> ① Click the [Start] button, point to [Settings], and then click [Printers]. ② Click the icon of the machine. On the [File] menu, click [Properties]. ③ Click the [Ports] tab. ④ In the [Print to the following port(s)] list, confirm the correct port is selected. • Windows XP Professional, Windows Server 2003 <ol style="list-style-type: none"> ① Click the [Start] button, and then click [Printers and Faxes]. ② Click the icon of the machine. On the [File] menu, click [Properties]. ③ Click the [Ports] tab. ④ In the [Print to the following port(s)] list, confirm the correct port is selected. • Windows XP Home Edition <ol style="list-style-type: none"> ① Click the [Start] button, click [Control Panel], click [Printers and Other Hardware], and then click [Printers and Faxes]. ② Click the icon of the machine. On the [File] menu, click [Properties]. ③ Click the [Ports] tab. ④ In the [Print to the following port(s)] list, confirm the correct port is selected. • Windows NT 4.0 <ol style="list-style-type: none"> ① Click the [Start] button, point to [Settings], and then click [Printers]. ② Click the icon of the machine. On the [File] menu, click [Properties]. ③ Click the [Ports] tab. ④ In the [Print to the following port(s)] list, confirm the correct port is selected. <p>❖ Network connection</p> <p>Contact your network administrator.</p>



Other Printing Problems

Problem	Causes and Solutions
The print on the entire page is faded.	<p>If the [Toner Saving] check box is selected in the printer driver settings, the entire page will be faded when printed.</p> <p>For the RPCS printer driver, [Toner Saving] is located on the [Print Quality] tab. For the PostScript 3 printer driver, see <i>PostScript 3 Supplement</i>.</p> <p>See the printer driver Help.</p>
Print is smudges.	<p>Settings for thick paper have not been made when printing on thick paper in the bypass tray.</p> <ul style="list-style-type: none"> • PCL 6/5c and PostScript 3 Select [Thick] in the [Type:] list on the [Paper] tab. • RPCS Select [Thick] in the [Paper Type:] list on the [Print Settings] tab.
When printing graphics, the output and the screen are different.	<p>If the printer driver is configured to use the graphics command, the graphics command from the machine is used to print.</p> <p>If you want to print accurately, set the printer driver to print without using the graphics command.</p> <p>See the printer driver Help.</p>
Page layout is not as expected.	<p>Print areas differ depending on machine used. Information that fits on a single page on one machine may not fit on a single page of another machine.</p> <p>Adjust the [Printable area:] setting in the [Printer Configuration...] dialog box on the [Print Settings] tab in the RPCS printer driver.</p> <p>See the printer driver Help.</p>
Duplex printing is malfunctioning.	<ul style="list-style-type: none"> • Duplex printing cannot be done with paper set in the bypass tray. When using duplex printing, make settings to use paper from a tray other than the bypass tray. • Duplex printing cannot be done with thick paper, OHP transparencies, or labels specified as the paper type. Specify another paper type. • Duplex printing cannot be done with a tray for which [1 Sided Copy] has been specified as Paper Type on the System Settings menu. Change the Paper Type setting for the tray to [2 Sided Copy] on the System Settings menu. See <i>General Settings Guide</i>.

Problem	Causes and Solutions
When using Windows 95/98/Me/2000/XP, Windows Server 2003, or Windows NT 4.0, either combined printing or booklet print does not come out as expected.	Make sure the application's paper size and orientation settings match those of the printer driver. If a different paper size and orientation are set, select the same size and orientation.
When using Windows 95/98/Me/2000/XP, Windows Server 2003, or Windows NT 4.0, Auto Reduce/Enlarge print does not come out as expected.	
A print instruction was issued from the computer, but printing did not start.	User code management may have been set. Ask the administrator about valid user codes. To print, the user code must be entered from the printer driver.
The print job is not canceled even when the machine is switched to offline status.	Even when the machine is offline, printing is performed when [Job Acceptance Priority] has been set in [Parallel Interface] in the [Interface Settings] in the System Settings menu. Change the setting of Signal Control to Printer priority. See "User Tools (System Settings)", <i>General Settings Guide</i> .
Photo images are coarse.	Some applications reduce print resolution.
Fine dot pattern does not print.	Make the following settings with the printer driver: <ul style="list-style-type: none"> • Change the [Dithering:] setting on the [Image Adjustments] tab in the [Change User Settings...] dialog box on the [Print Quality] tab in the RPCS printer driver. <p> Note</p> <ul style="list-style-type: none"> <input type="checkbox"/> To enable [Change User Settings...], select the [User Setting] check box. See the printer driver Help.
Images are cut off, or excess is printed.	You may be using paper smaller than the size selected in the application. Use the same size paper as that selected in the application. If you cannot load paper of the correct size, use the reduction function to reduce the image, and then print. See the printer driver Help.

Problem	Causes and Solutions
<p>It takes a long time to complete a print job.</p>	<p>Photographs and other data intensive pages take a long time for the machine to process, so simply wait when printing such data.</p> <p>Changing the following settings with the printer driver may help speed up printing:</p> <p>❖ PCL 6/5c Select the lowest value for [Resolution] on the [Print Quality] tab in the printer properties dialog box.</p> <p>❖ PostScript 3 Set the lower value in [Resolution]. The location of this setting is given below. If your operating system is Windows, select [PostScript (optimize for speed)] in [PostScript Output Option]. [PostScript Output Option] is located as follows:</p> <ul style="list-style-type: none"> • Windows 95/98/Me [Print Quality] tab in the printer properties dialog box. • Windows 2000/XP, Windows 2003 Server [Print Quality] in [Graphics] on [Advanced...] on [Paper Quality] tab in the printer properties dialog box. • Windows NT 4.0 [Graphics] on [Advanced...] on [Paper Quality] tab in the printer properties dialog box. • Mac OS 9.x [Printer Specifications] in the print dialog box. • Mac OS X [Set 3] tab in [Printer Features] in the print dialog box. <p>If you use Windows, select [PostScript (optimize for speed)]</p> <ul style="list-style-type: none"> • Windows 95/98/Me [PostScript output format:] on the [PostScript] tab in the printer properties dialog box. • Windows 2000/XP, Windows Server 2003 [PostScript Output Option] in [PostScript Option] on [Advanced...] on [Print Quality] tab in the printer properties dialog box. • Windows NT 4.0 [PostScript Output Option] in [PostScript Option] on [Document Options] on [Advanced...] tab in the printer properties dialog box. <p>❖ RPCS Select [Speed] for [Print priority] on the [Print Quality] tab in the printer driver's dialog box.</p> <p> Note <input type="checkbox"/> To enable [Change User Settings...], select the [User Setting] check box. Select [Fast] for [Document type] list on the [Print Quality] tab in the printer properties dialog box.</p> <p>See the printer driver Help.</p>

Problem	Causes and Solutions
It takes a long time to complete a print job.	<p>The data is so large or complex that it takes time to process. If the Data In indicator is blinking, data is being processed. Simply wait until printing resumes.</p> <p>If "Warming Up . . ." appears on the display panel, the machine is warming up. Wait for a while.</p>
It takes too much time to resume printing.	<p>The data is so large or complex that it takes time to process. If the Data In indicator is blinking, data is being processed. Simply wait until printing resumes.</p> <p>The machine was in Energy Saver Mode. To resume from Energy Saver Mode, it has to warm up, and this takes time. See <i>General Settings Guide</i>.</p>
Paper is not fed from the selected tray.	<p>When you are using a Windows operating system, printer driver settings override those set using the display panel. Set the desired input tray using the printer driver.</p> <p>See the printer driver Help.</p>
Solid lines are printed as broken lines.	<p>Make the following settings with the printer driver:</p> <ul style="list-style-type: none"> Change the [Dithering:] setting on the [Image Adjustments] tab in the [Change User Settings...] dialog box, on the [Print Quality] tab in the RPCS printer driver. <p>See the printer driver Help.</p>
Optional components connected to the machine are not recognized when using Windows 95/98/Me, Windows 2000/XP, Windows Server 2003, and Windows NT 4.0.	<p>You have to configure the option setup in printer properties when bidirectional transmission is not enabled.</p> <p>See the printer driver Help.</p>
Images are printed in the wrong orientation.	<p>The feed orientation you selected and the feed orientation selected in the printer driver's option setup might not be the same. Set the machine's feed orientation and the printer driver's feed orientation accordingly.</p> <p>See the printer driver Help.</p>
The printed image is different from the image on the computer's display.	<p>With certain functions, such as enlargement and reduction, image layout might be different to that on the computer display.</p> <p>You might have selected to replace True Type fonts with machine fonts in the printing process.</p> <p>To print an image similar to that of the computer display, make settings to print True Type fonts as an image.</p> <p>See the printer driver Help.</p>

Problem	Causes and Solutions
<p>No transmission when using 1394 interface connection</p>	<p>Check using the following procedure:</p> <ol style="list-style-type: none"> ① Confirm the IEEE 1394 interface cable is connected securely. ② Restart the computer. If the error occurs even after executing the above operation, proceed to the following steps. ③ Unplug the IEEE 1394 interface cable connected to the computer. ④ Run the utility tool for the IEEE 1394 interface board, which is stored in the following path on the CD-ROM "Printer Drivers and Utilities": <code>\UTILITY\1394\</code> <p> Reference For more information about using the utility tool for IEEE 1394, see the README file in the same directory on the CD-ROM.</p> <ol style="list-style-type: none"> ⑤ Restart the computer.
<p>When connecting the machine using USB 2.0, the first page of a print job that contains a large volume of data is printed, but the remaining pages are not.</p>	<p>Check that USB Printing Support is installed on your computer.</p> <p> Reference See p.43 "Installing the Printer Driver Using USB".</p>

 **Note**

If the problem cannot be solved, contact your sales or service representative.

System Settings (Parallel Connection)

❖ Parallel Timing

Specifies the timing for the parallel interface. Normally, you do not need to change this setting.

- ACK Inside
- ACK Outside
- STB Down

Note

Default: *ACK Inside*

❖ Parallel Communication Speed

Specifies the communication speed of the parallel interface. If the speed is too high, data may not be transferred smoothly. If this happens, change the setting to "Standard".

- High Speed
- Standard

Note

Default: *High Speed*

❖ Selection Signal Status

Specifies the signal level of the parallel interface.

- High
- Low

Note

Default: *High*

❖ Input Prime

Specifies whether the prime signal is active or inactive when an input prime signal is sent. Normally, you do not need to change this setting.

- Effective
- Invalid

Note

Default: *Invalid*

❖ Bidirectional Communication

Specifies, for instance, how a printer connected to the parallel interface responds to a status request. If you experience problems using another manufacturer's printer, set this to Off.

Limitation

If set to Off, asynchronous communication will not work.

- On
- Off

Note

Default: *On*

❖ Signal Control

Specifies how to handle any errors that occur when printing from a computer. Normally, you do not need to change this setting.

- Job Acceptance Priority
- Printer Priority
- Facsimile Priority

Note

Default: *Job Acceptance Priority*





Precautions when using Windows Server 2003

Precautions when using the Terminal Server mode

Certain printer driver functions are disabled. Disabled functions are displayed in gray. When using all printer driver functions, use Windows Server 2003 in normal mode.

Specifications

This section contains the machine's electrical and hardware specifications, including information about its options.

Component	Specifications
Resolution	1800 × 600 dpi equivalent 1200 × 1200 dpi (PCL6, RPCS and PostScript3 only) 600 × 600 dpi 300 × 300 dpi (PCL5c B&W only)
Printing speed	Type 1: <ul style="list-style-type: none"> • Full Color: 24 ppm • B&W: 28 ppm Type 2: <ul style="list-style-type: none"> • Full Color: 28 ppm • B&W: 35 ppm Type 3: <ul style="list-style-type: none"> • Full Color: 35 ppm • B&W: 45 ppm (A4  , 8 1/2" × 11"  plain paper) <p> Note</p> <input type="checkbox"/> Printing speeds depend on the machine. Check which type of machine you have. See <i>General Settings Guide</i> .
Interface	Standard: <ul style="list-style-type: none"> • Ethernet interface (100BASE-TX / 10BASE-T) • USB 2.0 interface Option: <ul style="list-style-type: none"> • IEEE 1284 parallel interface <p> Note</p> <input type="checkbox"/> Use a standard 36-pin printer cable not longer than 3 meters (10 feet).
Network protocol	TCP/IP, IPX/SPX, NetBEUI ^{*1} , AppleTalk
Printer language	Standard: PCL 6/5c, RPCS Option: PostScript 3, PDF
Fonts	PCL 6/5c : Agfa Monotype 35 Intellifonts, 10 TrueType fonts, and 1 Bitmap font. PostScript 3 : 136 fonts (Type 2:24, Type 14:112)

Component	Specifications
Memory	1024 MB
Hard disk	Storage capacity : 80 GB
Operating systems supported by this machine	Windows 95/98/Me Windows 2000 Windows XP Windows Server 2003 Windows NT 4.0 Mac OS 8.6 to 9.2 Mac OS X
Network cable	100BASE-TX / 10BASE-T shielded twisted-pair (STP, Category/Type5) cable.

*1 To use NetBEUI, use the SmartDeviceMonitor port.

Options

Limitation

- Only one optional interface board can be installed in the machine at a time. Therefore, the optional IEEE 1394 interface board, the IEEE 802.11b interface unit, the IEEE 1284 interface board, and Bluetooth interface unit cannot be installed concurrently.

IEEE 1394 Interface Board Type B

❖ Transmission spec.:

IEEE 1394

❖ Interface:

IEEE std 1394-1995 compliant

IEEE std 1394a-2000 compliant

❖ Device class:

SCSI print (Windows 2000/XP, Windows Server 2003)

IP over 1394 (Windows Me/XP, Windows Server 2003)

❖ Protocol:

SBP-2 (SCSI print)

TCP/IP (IP over 1394)

❖ Interface connector:

IEEE 1394 (6 pin × 2)

❖ Required cable:

1394 interface cable (6 pin × 4 pin, 6 pin × 6 pin)

Important

- You cannot plug devices together to create loops.
- Do not use cable that is more than 4.5 meters in length.

❖ Data transfer speed:

Maximum 400 Mbps

❖ Connectable number of devices on a bus:

Maximum 63

❖ Allowed cable hops on a bus:

Maximum 16

❖ Power supply:

Non external power supply

Cable Power repeated (IEEE 1394a-2000 compliant)

IEEE 1284 Interface Board Type A

❖ **Transmission spec.:**

IEEE 1284

❖ **Required cabled:**

Standard IEEE 1284 compliant Micro Centronics 36 pin cable

IEEE 802.11b Interface Unit Type H

❖ **Transmission spec.:**

Based on IEEE 802.11b (wireless LAN)

❖ **Protocol:**

TCP/IP, NetBEUL, IPX/SPX, AppleTalk

 **Note**

SmartDeviceMonitor and Web browser are supported.

❖ **Data transfer speed:**

Auto select from below speed

1 Mbps, 2 Mbps, 5.5 Mbps, 11 Mbps

❖ **Frequency range:**

- Inch version:
2412 - 2462 MHz (1 - 11 channels)
- Metric version:
2412 - 2472 MHz (1 - 13 channels)

❖ **Transmittable distance:**

1 Mbps 400 m ^{*1}
 2 Mbps 270 m ^{*1}
 5.5 Mbps 200 m ^{*1}
 11 Mbps 140 m ^{*1}

^{*1} These figures are a guideline for outdoor use. In general, the transmittable distance indoors is 10 - 100 m, depending on environment.

❖ **Transmission mode:**

Ad hoc, and infrastructure mode

PostScript 3 Unit Type 3245

 **Reference**

See *PostScript 3 Supplement*.

Bluetooth Interface Unit Type 3245

 **Reference**

See p.54 "Printing with Bluetooth Connection".

Download from www.Somanuals.com. All Manuals Search And Download.

INDEX

B

- Bluetooth Interface Unit Type 3245, 155
- Bypass tray, 14

C

- Canceling a job
 - Windows*, 107
- Clear/Stop key, 6
- Collate, 89
- Configuration page, 113
- Connection
 - Ethernet interface connection*, 13
 - IEEE 1394 interface connection*, 12
 - Parallel interface connection*, 12
 - USB interface connection*, 11
- Control Panel, 5
 - printer features*, 109
- Control panel
 - locked print*, 86
 - sample print*, 82
- Covers, 99
- Custom size paper, 16
 - printing, bypass tray*, 14

D

- Data In indicator, 6, 144, 148
- Display panel, 5, 7
 - error messages*, 137
- Document Server, 123

E

- Energy Saver key, 5
- Error Log, 141
- Error messages, 137

F

- Finisher, 91
- Font Manager 2000, 61
- Fonts, 152
- Function keys, 6
- Function status indicator, 6

H

- Hard disk, 153
- Host Interface, 118

I

- IEEE 1284 Interface Board Type A, 155
- IEEE 1394 Interface Board Type B, 154
- IEEE 802.11b Interface Unit Type H, 155
- Installing the Printer Driver
 - Quick Install*, 19
- Installing the Printer Driver Using USB, 43
- Interface, 152

L

- List / Test Print, 113
- Locked print, 86
 - deleting*, 87

M

- Main power indicator, 5
- Maintenance, 115
- Memory, 153

N

- Network Cable, 153
- Network protocol, 152
- Number keys, 6

O

- OHP Transparencies
 - printing, bypass tray*, 17
- On indicator, 5
- Operating system, 153
- Operation switch, 5
- Options, 154

P

- PageMaker, 62
- PCL menu, 119
- PDF Direct Print, 79
- PostScript 3 Unit Type 3245, 155
- Precautions when using the Terminal Server mode
 - Windows Server 2003*, 151
- Precautions when using Windows Server 2003
 - Windows Server 2003*, 151
- printer driver, 132
- Printer features
 - adjusting*, 112
 - menu*, 109
 - parameters*, 113
- Printer Language, 152
- Printing a PDF File Directly
 - PDF Direct Print*, 79
- Printing Method
 - PDF Direct Print*, 79
- Printing speed, 152
- Printing with Bluetooth Connection
 - Windows*, 54
- Printing with Parallel Connection
 - Windows 2000*, 48
- Punch, 96

R

- Resolution, 152

S

- Sample print, 82
 - deleting*, 84
- Slip Sheet, 103
- SmartDeviceMonitor for Admin, 134
- SmartDeviceMonitor for Client, 135
- Specifications, 152
- Spool printing, 98
- Staple, 92
- System, 115

T

- Thick Paper
 - printing, bypass tray*, 17
- Troubleshooting, 137
 - error messages*, 137
 - machine does not print*, 142
 - other printing problems*, 145
 - status messages*, 137

U

- User Tools/Counter key, 5

W

- Windows
 - canceling a job*, 107
- Windows 2000
 - printer properties, PCL*, 64
 - printer properties, RPCS*, 72
- Windows 95/98/Me
 - printer properties, PCL*, 63
 - printer properties, RPCS*, 70
- Windows NT 4.0
 - document defaults, PCL*, 68
 - document defaults, RPCS*, 77
 - printer properties, PCL*, 68
 - printer properties, RPCS*, 76
- Windows Server 2003
 - printer properties, PCL*, 66
 - printer properties, RPCS*, 74
- Windows XP
 - printer properties, PCL*, 66
 - printer properties, RPCS*, 74

MEMO

MEMO

MEMO

Note to users in the United States of America

Note:

This equipment has been tested and found to comply with the limits for a Class B digital device, pursuant to Part 15 of the FCC Rules. These limits are designed to provide reasonable protection against harmful interference in a residential installation. This equipment generates, uses and can radiate radio frequency energy and, if not installed and used in accordance with the instructions, may cause harmful interference to radio communications. However, there is no guarantee that interference will not occur in a particular installation. If this equipment does cause harmful interference to radio or television reception, which can be determined by turning the equipment off and on, the user is encouraged to try to correct the interference by one more of the following measures:

Reorient or relocate the receiving antenna.

Increase the separation between the equipment and receiver.

Connect the equipment into an outlet on a circuit different from that to which the receiver is connected.

Consult the dealer or an experienced radio /TV technician for help.

Caution:

Changes or modifications not expressly approved by the party responsible for compliance could void the user's authority to operate the equipment.

Declaration of Conformity

Product Name: Printer/Scanner Controller + Copy Machine

Model Number:

C2824/DSc428/LD328c/Aficio 3228C

C3528/DSc435/LD335c/Aficio 3235C

C4535/DSc445/LD345c/Aficio 3245C

Responsible party: Ricoh Corporation

Address: 5 Dedrick Place, West Caldwell, NJ 07006

Telephone number: 973-882-2000

This device complies with Part 15 of the FCC Rules.

Operation is subject to the following two conditions:

1. This device may not cause harmful interference, and
 2. this device must accept any interference received, including interference that may cause undesired operation.
-
1. Properly shielded and grounded cables and connectors must be used for connections to a host computer (and/or peripheral) in order to meet FCC emission limits.
 2. An AC adapter with a ferrite core must be used for RF interference suppression.

Note to users in Canada

Note:

This Class B digital apparatus complies with Canadian ICES-003.

Remarque concernant les utilisateurs au Canada

Avertissement:

Cet appareil numérique de la classe B est conforme à la norme NMB-003 du Canada.

Printed in Japan

EN (USA) B180-7512



B1807512

Free Manuals Download Website

<http://myh66.com>

<http://usermanuals.us>

<http://www.somanuals.com>

<http://www.4manuals.cc>

<http://www.manual-lib.com>

<http://www.404manual.com>

<http://www.luxmanual.com>

<http://aubethermostatmanual.com>

Golf course search by state

<http://golfingnear.com>

Email search by domain

<http://emailbydomain.com>

Auto manuals search

<http://auto.somanuals.com>

TV manuals search

<http://tv.somanuals.com>