

**RICOH**

# FAX1400L

## Operating Instructions <Basic Features>

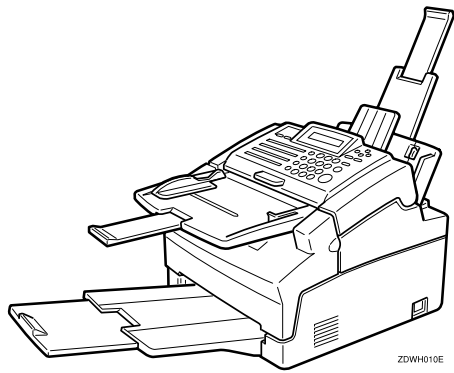

Read this manual carefully before you use this product and keep it handy for future reference.  
For safety, please follow the instructions in this manual.

## Introduction

This manual contains detailed instructions on the operation and maintenance of this machine. To get maximum versatility from this machine all operators should carefully read and follow the instructions in this manual. Please keep this manual in a handy place near the machine.

Please read the Safety Information in the Advanced Features manual before using this machine. It contains important information related to USER SAFETY and PREVENTING EQUIPMENT PROBLEMS.

### Notes:

Some illustrations might be slightly different from your machine.

Certain options might not be available in some countries. For details, please contact your local dealer.

### Laser Safety:

Direct (or indirect reflected) eye contact with the laser beam may cause serious eye damage. Safety precautions and interlock mechanisms have been designed to prevent any possible laser beam exposure to the operator.

### Warning:

Use of controls or adjustment or performance of procedures other than those specified in this manual might result in hazardous radiation exposure.

Two kinds of size notation are employed in this manual. With this machine refer to the metric version.

For good copy quality, Ricoh recommends that you use genuine Ricoh toner.

Ricoh shall not be responsible for any damage or expense that might result from the use of parts other than genuine Ricoh parts in your Ricoh office product.

### Important

Parts of this manual are subject to change without prior notice. In no event will the company be liable for direct, indirect, special, incidental, or consequential damages as a result of handling or operating the machine.

### Power Source:

AC220–240V, 50/60Hz

Please be sure to connect the power cord to a power source as above. For details about power source, see Chapter 10, "Connecting the Power and Switching On" in the Advanced Features manual.

# How to Read This Manual

---

## Symbols

---

In this manual, the following symbols are used:

### **WARNING:**

This symbol indicates a potentially hazardous situation that might result in death or serious injury when you misuse the machine without following the instructions under this symbol. Be sure to read the instructions, all of which are described in the Safety Information section in the Advanced Features manual.

### **CAUTION:**

This symbol indicates a potentially hazardous situation that might result in minor or moderate injury or property damage that does not involve personal injury when you misuse the machine without following the instructions under this symbol. Be sure to read the instructions, all of which are described in the Safety Information section in the Advanced Features manual.

\* The statements above are notes for your safety.

### **Important**

If this instruction is not followed, paper might be misfed, originals might be damaged, or data might be lost. Be sure to read this.

### **Preparation**

This symbol indicates the prior knowledge or preparations required before operating.

### **Note**

This symbol indicates precautions for operation, or actions to take after misoperation.

### **Limitation**

This symbol indicates numerical limits, functions that cannot be used together, or conditions in which a particular function cannot be used.

### **Reference**

This symbol indicates a reference.

[    ]

Keys built into the machine's operation panel.

# TABLE OF CONTENTS

<b>Manuals for this machine .....</b>	<b>1</b>
Basic Features (This Manual) .....	1
Advanced Features .....	1

## 1. Introduction

---

<b>Part Names .....</b>	<b>3</b>
Front View .....	3
Rear View .....	4
<b>Operation Panel .....</b>	<b>5</b>
<b>Symbols and Conventions Used in This Manual .....</b>	<b>7</b>

## 2. Faxing

---

<b>Types of Transmission .....</b>	<b>9</b>
<b>Suitable Document Types .....</b>	<b>10</b>
<b>Memory Transmission and Immediate Transmission .....</b>	<b>11</b>
Memory Transmission .....	11
Canceling a Memory Transmission .....	14
Immediate Transmission .....	15
Canceling an Immediate Transmission .....	15
When Setting Thin and Soft Documents .....	16
<b>Very Fine Detail Faxing .....</b>	<b>17</b>
Resolution .....	17
<b>Reception Modes .....</b>	<b>18</b>
Switching Between Auto, Fax, and Telephone Mode .....	19

## 3. Setup

---

<b>Initial Settings and Adjustments .....</b>	<b>21</b>
Initial Settings (Function 61) .....	21
<b>Storing and Editing Fax Numbers (Functions 31 &amp; 32) .....</b>	<b>23</b>
Storing, Editing and Erasing Quick Dial Numbers (Function 31) .....	23
Quick Dial Label .....	24
Attaching the Quick Dial Sheet .....	24
Storing, Editing and Erasing Speed Dial Numbers (Function 32) .....	24
<b>Storing and Editing a Group of Fax Numbers (Function 33) .....</b>	<b>26</b>
Erasing Groups .....	28
Programming the Group Key .....	29
<b>Entering Characters .....</b>	<b>30</b>
Entering Symbols .....	30
Entering Numbers .....	30
Wild Cards .....	31

## 4. Troubleshooting

---

<b>Loading Paper into the Paper Tray .....</b>	<b>33</b>
<b>Adjusting The Volume and Sounds The Machine Makes (Function 92)...</b>	<b>35</b>
<b>If an Indicator Lights on the Operation Panel.....</b>	<b>36</b>
<b>Communication Problems.....</b>	<b>37</b>
<b>Clearing a Document Jam .....</b>	<b>38</b>
<b>Clearing a Copy, Fax, or Print Jam .....</b>	<b>39</b>
Inside the Machine .....	39
When Paper Will Not Feed.....	41
<b>Error Messages.....</b>	<b>43</b>
<b>Solutions to Common Problems.....</b>	<b>45</b>
<b>INDEX.....</b>	<b>50</b>

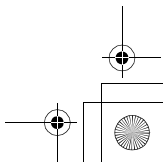
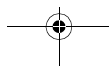
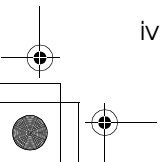
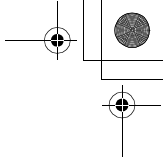
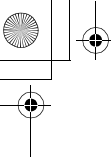

# Manuals for this machine

There are the Basic Features manual and the Advanced Features manual for this machine. Please consult the manual that suits your needs.

---

## Basic Features (This Manual)

---

The Basic Features manual explains the most frequently used fax functions and operations.

---

## Advanced Features

---

The Advanced Features manual describes more advanced functions, and also explains settings for key operators.

### ❖ Chapter 1 Advanced Transmission Features

Explains about sending at a specific time without having to be by the machine and also taking advantage of off-peak telephone line charges.

### ❖ Chapter 2 Communication Information

Explains about erasing a fax message stored in memory and checking the contents of any files in memory.

### ❖ Chapter 3 Transmission Features

Explains about useful features for transmission. You can find out about dialing numbers easily.

### ❖ Chapter 4 Reception Features

Explains about reception features. You can find out about receiving messages in telephone mode, and printing with the Reverse Order Printing function for easier document distribution.

### ❖ Chapter 5 Copying

Read this chapter when you would like to know about copying operations and functions.

### ❖ Chapter 6 Facsimile User Tool

Explains about how to print telephone number lists. You can print out those lists at any time.

### ❖ Chapter 7 Key Operator Settings

Explains about functions the key operator handles. You can find out about setting up the Date and Time, and selecting the display language.

❖ **Chapter 8 Troubleshooting**

Explains about reading error reports. When these reports are printed out, check the report and take the appropriate action.

❖ **Chapter 9 Maintaining Your Machine**

Explains about cleaning the rollers and scanner, replacing the toner cartridge and cleaning pad and so on.

❖ **Chapter 10 Installation**

Explains about the machine environment and installing the optional Memory card.

❖ **Chapter 11 Appendix**

You can check the option and specifications for this machine.



# 1. Introduction

## Part Names

### Front View

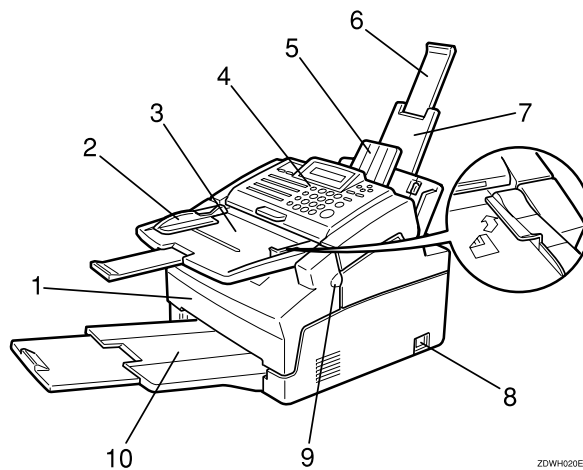

#### 1. Front Unit

Open this unit when changing the toner cartridge.

#### 2. Document Guides

Slide the left guide to fit the size of the paper you are feeding.

#### 3. Automatic Document Feeder (ADF)

Holds up to some sheets of paper for automatic feeding. Place originals face down.

#### 4. Operation Panel

Key panel for operating the machine.

#### 5. Document Delivery Tray

Scanned documents are stacked on the document delivery tray.

#### 6. Paper Tray Extension

Extend to support originals.

#### 7. Paper Tray

Holds up to 100 sheets of plain paper.

#### 8. Power Switch

The Power Switch turns your machine on and off.

#### 9. Front Unit Release Tab

Hold this tab when opening Front Unit.

#### 10. Print Delivery Tray

Copies, incoming faxes are stacked here.

#### ⚠ Limitation

- Do not place more than 50 sheets of paper stock on the Print Delivery Tray.

## Rear View

1

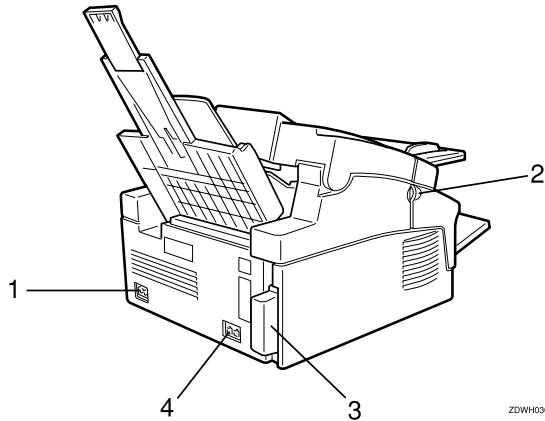

**1. Power Socket**

**2. Front Unit Release Tab**

Hold this tab when opening Front Unit.

**3. Optional Card Insertion Slots**

Insert the Optional Memory Card.

**4. TEL/LINE**

Connect your telephone line and external telephone here.

4

# Operation Panel

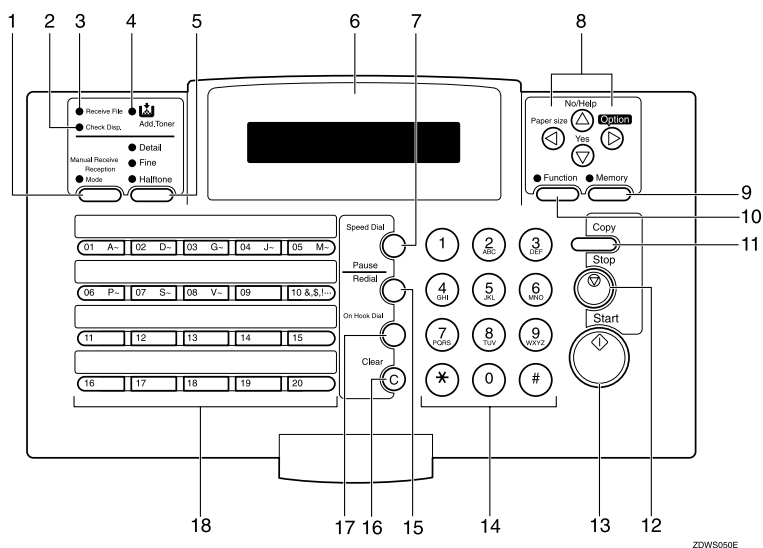

1

## 1. [Reception Mode] key

Press this to select the reception mode (Tel, Fax or Auto).

Lights when the reception mode is Telephone.

## 2. Check Display indicator

The **Check Disp.** Indicator blinks to tell you to read the display.

## 3. Receive File indicator

The **Receive File** indicator lights when an incoming message was received into memory. (see P.36 "If an Indicator Lights on the Operation Panel").

## 4. Add Toner indicator

Blinks when toner is about to run out and lights continuously when toner has run out.

## 5. [Resolution] key

The resolution/Halftone is indicated by these three indicators and can be changed by the resolution/Halftone. When the Indicator is not lit, Standard is selected.

## 6. Control panel Display

The Liquid Crystal Display guides you through tasks and informs you of the state of the machine. Messages appear here. The display consists of two 20-character lines.

## 7. [Speed Dial] key

Press the **[Speed Dial]** key using Speed Dialer Feature.

## 8. Arrow keys

- ▼ **[Yes]** accept
- ▲ **[No]** reject / **[Help]** Print help list
- ◀ scroll left / **[Paper Size]** The paper size selection screen for Paper Tray will appear.
- ▶ scroll right / **[Option]** Press to access the options.

## 9. Memory key/ indicator

When the **Memory** indicator is on, then memory transmission is in effect, if it is off, immediate transmission is in effect. Switch between the two with the **[Memory]** key.

5

**10. [Function] key**

Press the **[Function]** key and enter a two digit code to access Functions 11 to 51. (For Functions 61 to 94, enter 6, the access code on see Chapter 7, "Access Code for Functions 61 to 94" in the Advanced Features manual.)

**11. [Copy] key**

Press this to copy the document now in the Automatic Document Feeder.

**12. [Stop] key**

Press the **[Stop]** key to stop a transmission or a document scanning, to stop a reception or to stop a long copy run. The machine will finish printing out the sheet being printed and then stop.

Press to clear any selected settings and return the condition it was in just after being switched on.

**13. [Start] key**

Press the **[Start]** key to start all tasks.

**14. Ten key pad**

Use the ten key pad (sometimes called the ten keys) to dial fax numbers, to enter the numbers of copies, etc.

**15. [Pause/Redial] key**

The **[Pause/Redial]** key inserts a pause when you are dialing or storing a fax number. Or, press the key to redial the last number dialed. (The redial feature does not work once you have started dialing a new number.)

**16. [Clear] key**

Press the **[Clear]** key to erase the last character or digit entered, or use the left and right arrow keys to move the cursor, and then press Clear to erase whatever is at the cursor.

**17. [On Hook Dial] key**

Press to dial a phone call from the keypad without lifting the external telephone handset (if the machine is connected to the external telephone).

**18. [Quick Dial] keys**

There are 20 Quick Dial keys. Use them to store individual fax numbers (see P.23 "Storing and Editing Fax Numbers (Functions 31 & 32)") or groups (see P.26 "Storing and Editing a Group of Fax Numbers (Function 33)"). You can also use these keys to enter characters (see P.30 "Entering Characters"). In addition you can register Quick Dial 09 as the Dial Option key (see Chapter 3, "Dial Options-Assigning the Dial Option key" in the Advanced Features manual). You can also use Quick Dial 10 as a Group key (see P.29 "Programming the Group Key")

# Symbols and Conventions Used in This Manual

1

## ◆ Documents:

A document is anything you put on the feed table of your machine, whether you are faxing it or copying it.

## ◆ Prints:

A print is anything that comes out of the machine: a fax message you received or a copy you made.

## ◆ Procedures:

Procedures are described step by step. Perform them in order. When you see a display, it always shows what comes after performing the step it accompanies. Other illustrations accompanying steps help you find the right key or handle, or show you how to perform the step.

**■** This is a step in a procedure.

THIS CORRESPONDS TO  
THE LCD DISPLAY.

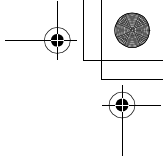
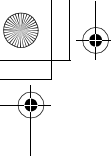

# Introduction

---

1

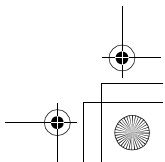
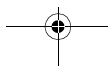
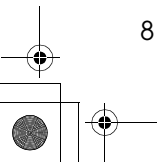
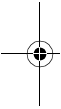

## 2. Faxing

### Types of Transmission

There are two types of transmission.

#### ◆ Memory Transmission

When a fax message is stored in memory, then transmission starts automatically. It is convenient when you would like to take documents back in a hurry.

You can send the same message to more than one destination in a single operation. This technique is referred to as Broadcasting.

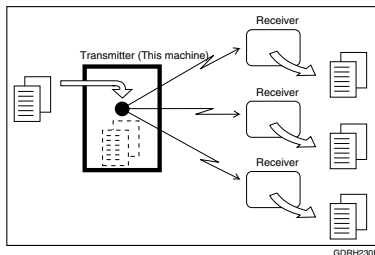

#### ◆ Immediate Transmission

The machine dials immediately, and transmits the fax while scanning.

It is convenient when you would like to send a message immediately, and would like to check whether you have successfully connected with the other party's fax machine. A fax message is not stored in memory.

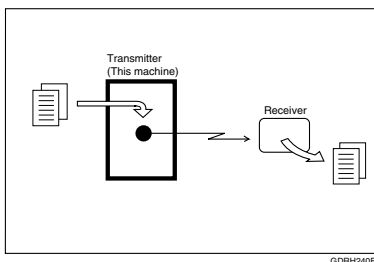

#### ⚠ Important

- If there is a power failure, the power switch is turned off, or the plug is pulled out for more than 12 hours (without optional memory), all files stored in memory are deleted. As soon as power is restored, the Power Failure Report is printed to help you identify deleted files. See Chapter 8, "Power Failure Report" in the Advanced Features manual.

## Suitable Document Types

Do not place damaged pages in the Automatic Document Feeder.

**2**

- If your pages are curled or dog eared, flatten them.
- If your pages are stuck together, shuffle the stack.
- If your pages are folded, torn, or patched together, make copies.
- If your pages have binding files, trim the edges or make copies.

### Important

- Do not place originals that contain the following materials in the Automatic Document Feeder ;
  - Crayon
  - Paint
  - Charcoal, soft pencil
  - Glue
  - Thermal paper
  - Clips
  - OHP Sheets, vinyl-coated paper
  - Waxed paper
  - Carbon paper
  - Silicone oil

### Note

- Copies made with a copier that uses silicone oil may cause a mis-feed. To avoid this, do not scan such copies until five or ten minutes after copying.
  - **Clearly Written**  
Small faint characters may not be transmitted clearly.
  - **Uniform Page Size**  
Do not use different sizes of document in the same transmission.
  - **Uniform Paper Quality**  
Do not use different types of paper quality in the same transmission.

### Reference

See Chapter11, "Document and Paper Specifications" in the Advanced Features manual.



## Memory Transmission and Immediate Transmission

There are two ways to send a fax message.

- Memory Transmission
- Immediate Transmission

### Memory Transmission

Memory Transmission is convenient because:

- Fax messages can be scanned much more quickly (you can take your document away from the fax machine without waiting too long).
- While your fax message is being sent, another user can operate the machine (people will not have to wait by the fax machine too long).
- You can send the same message to more than one place with the same operation.
- After you press the **[Start]** key, the machine doesn't dial until all the pages of your fax message have been stored in the memory.

#### Note

- If your document gets stuck while it is being processed, press the **[Stop]** key, and turn to P.38 "Clearing a Document Jam" for instructions on how to safely remove the original.

#### 1 Make sure that the machine is in standby mode for faxing.

The display should look like this:

```
READY      100% 10:00
SET DOC. OR DIAL NO.
```

#### Note

- If the display shows "SAVING ENERGY", press any key to exit Energy Saving mode.

```
READY      100% 10:00
SAVING ENERGY
```

#### 2 Fan your document stack (at most 30 pages: 80g/m<sup>2</sup>) to make sure all pages are loose, then square it.

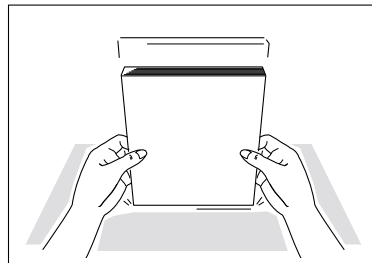

#### Note

- All pages in your document must be one-sided and be of the same size.

2

Faxing

**3** Carefully insert the document stack face down into the Automatic Document Feeder. At this time, the Panel display should change to "DIAL FAX NUMBER".

2



**Important**

Gently insert the documents, until you feel them catch on the rollers inside the Automatic Document Feeder.

**Note**

- Make sure this message appears. If it does not, your document will not be scanned from the Automatic Document Feeder.
- You can dial before you set the document. Place the document after you dial the number and go to step 7.

**4** The display will look like this:

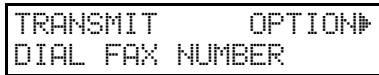

**5** If the memory indicator is not lit, press the **[Memory]** key.

**6** Dial the number in one of the following ways.



Ten Key Pad	Quick Dial
<p style="text-align: center;">GF DIAL 0N</p>	<p style="text-align: center;">GF DIAL 1N</p>
Speed Dial	Group
<p>Example: Speed Dial 10</p> <p style="text-align: center;">GF DIAL 2N</p>	<p>Example:</p> <p>Method *1 Quick Dial key 08.</p> <p>Method *2 Quick Dial key 10 and 1 on the ten key pad.</p>

- \*1 In this example Group Dial is programmed in Quick Dial 08.
- \*2 In this example Quick Dial key 10 is programmed as the Group key, and Group dial number 1 is programmed.

**Note**

- If you want to erase a digit of the phone number, press the **[Clear]** key. If you want to erase the entire number, press the **[No]** key.
- The maximum destinations you can dial using the ten key pad is 49. However, this limitation is also subject to memory capacity.

**Reference**

Programming Quick Dial: see P.23 "Storing and Editing Fax Numbers (Functions 31 & 32)".

Programming Speed Dial: see P.23 "Storing and Editing Fax Numbers (Functions 31 & 32)".

Programming Group Dial: see P.26 "Storing and Editing a Group of Fax Numbers (Function 33)".

Programming Group key: see P.29 "Programming the Group Key".

**7** Press the **[Yes]** key to enter another number.

```
TRANSMIT DIAL/START
DIAL NEXT FAX NUMBER
```

**Note**

- Repeat steps **6** and **7** until all destinations are entered.
- If you have only one destination, press the **[Start]** key.
- The machine stores your message and dials the first number (or, if you select Send Later, it will return to standby mode and the fax message will be sent at the time that you selected).

**Reference**

Send Later: see Chapter 1, "Sending at a Specific Time (Send Later)" in the Advanced Features manual.

**8** Press the **[Start]** key.

The machine will dial the destination's number.

```
5551234
SET DOC. OR DIAL NO.
```

**Note**

- If the other party's line is busy, your machine will dial again. (See Chapter 3, "Redial" in the Advanced Features manual.)

```
READY 98% 10:04
SET DOC. OR DIAL NO.
```

- If the other party's fax machine answers, both machines will connect and yours will send the message. A name or a label will appear on the upper line.
- If your line goes through a local switchboard (a PBX), remember to dial the exit code. Press the **[Pause]** key immediately after entering the code. If the number includes a country code, press the **[Pause]** key after the country code, and then dial the rest of the number.

Faxing

## Canceling a Memory Transmission

### Before start is pressed

2

- 1 Press the **[Stop]** key, or remove the document you have set.

### While the document is being scanned in

- 1 Press the **[Stop]** key.  
The fax message which has already been scanned in is canceled.

### During Transmission

- 1 Press the **[Stop]** key during communication.

```
5551234
STOP & CLR FILE? Y/N
```

- 2 Then, press the **[Yes]** key to cancel the transmission.

### While the message is awaiting transmission (Functions 21)

Every time you store a fax message in your machine's memory, a new file is created. Each file is given a number. This number appears on the File Reserve Report, Journal and Transmission Result Report. To see which files are currently in memory, you may print a file list.

- 1 To erase a fax message stored in memory; press the **[Function]** **[2]** **[1]**, and then the **[Yes]** key.

```
FILE NO. ■■■■ KPAD/↔
PRINT LIST ←/SEARCH▶
```

- 2 Press the **▶** key to scroll through the messages.

You will see the display. A number or a label will appear on the lower line.

```
FILE NO.027 Y/↔
5551234
```

#### Note

- Press the **◀** key to obtain a list of all the files and their numbers. If you already know the number of the file to erase, enter it directly from the ten key pad.

- 3 Press the **[Yes]** key.

```
FILE NO.027 Y/N
CLEAR?
```

- 4 Press the **[Yes]** key again to erase the file.

- 5 Press the **[Function]** key.

#### Note

- To erase another file, go to step 2.

## Immediate Transmission

Immediate Transmission is convenient when:

- You wish to quickly check whether you have successfully connected with the other party's fax machine.
- Your machine's memory is getting full.

The machine dials immediately after you press the **[Start]** key. The message is scanned and transmitted page by page without being stored in memory.

### 1 Make sure that the machine is in standby mode.

The display should look like this:

```

READY      100% 10:00
SET DOC. OR DIAL NO.
    
```

#### Note

- The memory indicator should go out. If the memory indicator is lit, press the **[Memory]** key.

### 2 Place the entire document face down into the Automatic Document Feeder.

```

TRANSMIT     OPTION▶
DIAL FAX NUMBER
    
```

#### Note

- No more than 30 pages (80g/m<sup>2</sup>).
- You can dial before you set the document. Place the document after you dial the number and go to step **3**.

### 3 Dial.

```

TRANSMIT     Y/START
5551234■■■■■■■■■■■■■■■■■■■■
    
```

#### Note

- If you install an external telephone, you can send the message manually. Pick up the external telephone handset and dial.

### 4 Press the **[Start]** key.

```

5551234
DIALING
    
```

The machine dials and connects to the other party. The number that you dialed and the other party's OWN NAME or FAX NUMBER is displayed.

## Canceling an Immediate Transmission

### Before start is pressed

- #### 1 Press the **[Stop]** key, or remove the document you have set.

### While dialing or during transmission

- #### 1 Press the **[Stop]** key.

However, the fax message which has already scanned in has transmitted.

Remove the document after it is canceled.

Faxing

## When Setting Thin and Soft Documents

- 1 Open the operation panel (①), and then insert the document until the paper end touches the projection next to the roller (②).

2

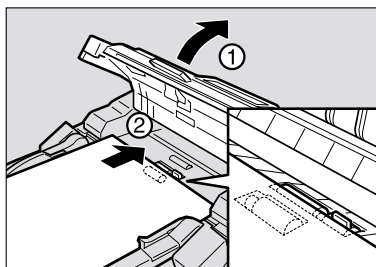

ZDWH033E

### ⚠ Limitation

- When setting thin and soft documents, set one sheet of documents.

- 2 Close the operation panel and make sure it locks securely into place.

## Very Fine Detail Faxing

If you need to send a document which requires optimum clarity, select the resolution setting appropriate to your needs.

You can select different settings for each page of your message. Simply change the settings for page 2 while page 1 is being scanned.

### Resolution

The resolution button gives you control over document quality. The indicators above the button show the current setting. Choose a setting that matches your document.

#### ◆ Standard:

Standard quality. Use for most printed or typewritten documents. This is selected when the other resolution indicators are not lit.

#### ◆ Detail:

High quality. Use for documents with small print or fine details.

#### ◆ Fine:

Very high quality. Use this for high quality reproduction.

#### ◆ Halftone:

Use this for optimum quality if your document contains photographs/diagrams with complex shading patterns or gray tones. If you choose this setting, resolution will automatically be Detail.

#### ! Limitation

- If the other party's machine does not support the resolution at which you are sending, this machine automatically switches to a resolution supported by the other party's machine.

#### ✎ Note

- Faxing at a higher resolution requires more time. Frequent use of high resolution could cause an increase in your phone bill, especially for long distance transmissions.

**2**

## Reception Modes

The machine can treat incoming fax messages and telephone calls in three ways.

2

### ❖ Auto mode

Use this mode if your line is shared by a fax machine and telephone. When a call comes in, the machine will ring a number of times to give you the chance to pick up the external telephone handset. If you do not pick up and the call is a fax message, the machine will go into fax mode and start receiving. You can choose the number of times the machine rings before taking the call by altering the Auto Ring time (see Chapter 7, "Setting The Auto Ring Time" in the Advanced Features manual).

### ❖ Connecting to a Telephone Answering Machine (TAM)

When Auto Mode is selected, you can connect the machine to a Telephone Answering Machine (TAM).

TAM mode ensures that your answering machine has the chance to respond to incoming telephone calls. If the call happens to be a fax message, the message will be given to the fax machine automatically.

In the TAM Mode, the Auto Ring count must be set to one ring more than the number of rings that your answering machine waits before it takes the call.

### ❗ Important

- ❑ If the Auto Mode function does not operate as expected when using an answering machine, leave the first five seconds of the answering machine message blank.

### ❖ Fax mode

In this mode the machine automatically answers incoming calls. When a call is received, the machine rings a few times to alert you that a message is being sent, then starts receiving and printing the message. Fax mode is ideal for a dedicated fax line.

### ❖ Telephone mode

Use this mode if your line is shared by a fax machine and a telephone, but you wish to answer all calls yourself and decide whether they are fax messages or telephone calls. You must manually hit the Start key to receive a fax.

The machine will ring continuously until you answer the call, so you have to be near the machine at all times.

The Manual Receive indicator is lit when the machine is in this mode.



## Switching Between Auto, Fax, and Telephone Mode

The Manual Receive indicator is lit when the machine is in Telephone mode. To switch to a different mode, follow the steps below.

- 1** Press the **[Reception Mode]** key.

```
RECEIVE MODE  Y/↔  
▶FAX TEL AUTO
```

- 2** Press the **◀** and **▶** keys to select the mode you require.

```
RECEIVE MODE  Y/↔  
FAX TEL ▶AUTO
```

- 3** Press the **[Yes]** key.

```
READY 100% 10:00  
SET DOC. OR DIAL NO.
```

2

Faxing

---

2

## 3. Setup

### Initial Settings and Adjustments

Before you connect your machine to the telephone system, you must enter a few settings and make a few adjustments.

#### ◆ OWN NAME :

This should be your name or company name, in 20 characters or less. During a communication, if the other party's fax machine supports OWN NAME, then this replaces the FAX NUMBER following. The other party's name will appear on your display, and yours on theirs.

#### ◆ FAX HEADER :

This must be the telephone number of the line your machine is connected to.

Your FAX HEADER can be up to 32 characters long, and is printed on the header of every page you send. Required in the United States.

#### ◆ FAX NUMBER :

This is your fax machine's phone number, which must include country and area codes. During any communication, your FAX NUMBER appears on their display. (Conversely their FAX NUMBER appears on your display.)

#### ! Limitation

- The FAX NUMBER feature is not available in some areas.

#### ! Important

- The FAX NUMBER code is required by international law. You cannot legally connect a fax machine to the telephone system if the FAX NUMBER code is not programmed. Further, the FAX HEADER code and the date and time of transmission must be included in the header of all pages faxed to, from, or within the United States.

### Initial Settings (Function 61)

During the course of this procedure you will have to enter letters and other characters.

Use the ten key pad for entering numbers. Use Quick Dial keys 1 to 8 for entering letters, the **[Yes]** key to accept a character, and Quick Dial key 10 to enter spaces and symbols. See P.30 "Entering Characters" for details.

If these settings have been made before, the messages on the display will not always match those shown here. The setting already entered will appear along with the trans "CHANGE?". In this case, press the **[Yes]** key to change the setting.

- 1 Press **[Function] [6]** and enter the access code **[2] [2] [2] [2]**. Press **[6] [1]**, and then the **[Yes]** key.

```

SET OWN NAME      Y/NEXT▶
  
```

Setup

**2** Press the **[Yes]** key.

```

OWN NAME      ABC
████████████████████
    
```

**3** Enter your office, company, or personal name, or any other appropriate identification. (Using the Quick Dial keys.)

**3**

```

OWN NAME      ABC Y/⏪
XYZ COMPANYY██████████
    
```

**Reference**

See P.30 "Entering Characters".

**4** Press the **[Yes]** key.

```

OWN NAME      ABC Y/N
XYZ COMPANYY██████████
    
```

**5** Press the **[Yes]** key.

"PROGRAMMED" will flash on the display.

```

                                Y/NEXT▶
SET FAX HEADER
    
```

**6** Press the **[Yes]** key.

```

HEADER CHANGE? Y/N
XYZ COMPANY
    
```

**7** Press the **[No]** key.

The OWN NAME programmed in step **3** appears. You should keep it. Press the **[No]** key to keep the FAX HEADER as is.

```

                                Y/NEXT▶
SET FAX NUMBER
    
```

**Note**

If you wish to change it, press the **[Yes]** key and edit the FAX HEADER.

**8** Press the **[Yes]** key.

```

FAX NUMBER      KPAD
████████████████████
    
```

**9** Enter your phone number including the country and area codes.

```

FAX NUMBER      KPAD/Y/N
+61123456789██████████
    
```

**10** Press the **[Yes]** key.

"PROGRAMMED" will flash on the display.

```

                                Y/NEXT▶
SET PSTN ACCESS NO.
    
```

**11** Press the **[Function]** key to finish.

```

READY          100% 10:00
SET DOC. OR DIAL NO.
    
```

## Storing and Editing Fax Numbers (Functions 31 & 32)

You can store numbers that you often use in the machine's memory. A stored number will remain in memory even if the power is cut.

You can store numbers in two ways.

### ❖ Quick Dials

The number is assigned to its own key. To dial that number, just press the key. You can store up to 20 numbers in this way.

### ❖ Speed Dials

The number is given a two-digit code. To dial the number, press the **[Speed Dial]** key and enter the code. There are 50 Speed Dial codes available numbered 00 to 49.

### Storing, Editing and Erasing Quick Dial Numbers (Function 31)

This procedure describes how to store and edit fax numbers in Quick Dial keys.

- 1 Press **[Function]** **[3]** **[1]**, and then the **[Yes]** key.

QUICK/SEARCH  
PRINT LIST/SEARCH

#### 📌 Note

- ❑ To print a list of all Quick Dials and their contents, press the **[Left Arrow]** key and the **[Yes]** key, and then press the **[Start]** key.

- 2 Select a Quick Dial in any one of the following ways:

- Press a Quick Dial key (e.g. press Quick Dial 01).

001 PROGRAM? Y/SEARCH

- Press the **[Right Arrow]** key until the Quick Dial you want appears on the display.

- 3 Press the **[Yes]** key.

001 KPAD/Y/N

- 4 Do one of the following:

- Enter the fax number you wish to store in this Quick Dial using the ten key pad, and then press the **[Yes]** key.

001 KPAD/Y/N  
212551234

- To clear the number, press the **[No]** key, and then the **[Yes]** key, and go to step 3.

- 5 Do one of the following:

- If you wish to enter or edit a label for this Quick Dial, press the **[Yes]** key.

001 PROGRAM LABEL? Y/N

- If you do not wish to give this number a label, press the **[No]** key and go to step 3.

3

Setup

- 6** Enter or edit the label using the Quick Dial keys and the ten key pad. See P.30 "Entering Characters"



- 7** Press the [Yes] key.

3



**Note**

- To print a Quick Dial List, press the ◀ key to select "LIST". Then, press the [Yes] Key, and then the [Start] key.
- To print a Quick Dial label, choose "LABEL". Then, press the [Yes] key, and then the [Start] key.

- 8** You now have two choices:

- To store, edit or delete another Quick Dial, go to step 2.
- To finish, press [Function] key.

### Quick Dial Label

Use this function to print a sheet showing the contents of each Quick Dial. The size of the sheet matches the dimensions of the keys.

The following items are printed depending on what is stored in each key:

- Fax number label
- Group Dial label

### Attaching the Quick Dial Sheet

You can write the stored numbers on the Quick Dial Sheet provided, and attach it to the machine

- 1** Fit the Quick Dial Sheet over the Quick Dial Keys.

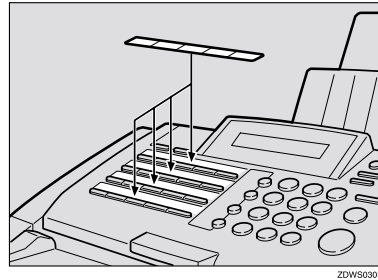

### Storing, Editing and Erasing Speed Dial Numbers (Function 32)

This procedure describes how to store and edit fax numbers in Speed Dials.

- 1** Press [Function] [3] [2], and then the [Yes] key.



**Note**

- To print a list of all Speed Dials and their contents, press the ◀ key, and then press the [Start] key.

- 2** Select a Speed Dial in any one of the following ways:

- Enter the Speed Dial code on the ten key pad. (e.g. 01)

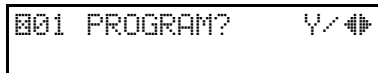

- Press the ▶ key until the Speed Dials you want appears on the display.

**3** Press the **[Yes]** key.



**4** Do one of the following:

- Enter the fax number you wish to store in this Speed Dial using the ten key pad. Then, press the **[Yes]** key.



- To clear the number, press the **[No]** key, and then the **[Yes]** key and go to step **3**.

**5** Do one of the following:

- If you wish to enter or edit a label for this Speed Dial, press the **[Yes]** key.



- If you do not wish to give this number a label, press the **[No]** key and go to step **4**.

**6** Enter or edit the label using the Quick Dial keys.

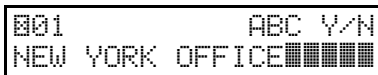

**7** Press the **[Yes]** key.

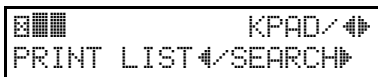

**Note**

- To Print a Speed Dial List, press the **[Left Arrow]** key, and then the **[Start]** key.

**8** You now have two choices:

- To store, edit or delete another Speed Dial, go to step **2**.
- To finish, press **[Function]** key.

3

## Storing and Editing a Group of Fax Numbers (Function 33)

### ◆ Groups

If you often broadcast messages to the same set of destinations, you can combine these numbers into a group. Then just select the group and each number will be dialed in sequence automatically.

You can register the following items in a Group:

- Destination fax numbers
- Group name (up to 20 characters)

You can enter destination numbers by Quick Dial keys, Speed Dials, or Ten keys.

#### ✎ Note

- You can register up to 3 Groups.
- The combined maximum number of destinations you can register in all Groups is 90.
- The number of destinations that can be registered with the ten keys depends on how the machine is used. In theory you can register up to a combined maximum of 49 destinations with the ten keys for all groups. However, if you register 49 items with the ten keys, Memory Transmission becomes unavailable. Only register up to 48 items with the ten keys.
- The maximum number of destinations you can register in a Group is 30.

- If you register the same destination more than once with a Speed Dial or Quick Dial in Groups, it is only counted as one item. However, if you register two or more identical destinations with the ten keys they will be counted as two or more items.
- If all destinations are different, you may not be able to store 30 destinations in a Group.
- Print the Group Dial List and keep it when you register or change destinations. See Chapter 6, "Lists You Can Print Out Yourself" in the Advanced Features manual.
- How to count numbers

Registered items		Total Numbers
Group 1	Quick Dial: [01], [03], [05] Speed Dial: [01], [02], [10] Ten Key: 0312345678	10 numbers
Group 2	Quick Dial: [01], [05] Speed Dial: [01], [02], [08] Ten Key: 0312345678, 0451119999	



Storing and Editing a Group of Fax Numbers (Function 33)

	Registered items	Total Numbers
Group 1	Quick Dial: [01], [02], [03], Speed Dial: [01], [02], [03] Ten Key: 0312345678	14 numbers
Group 2	Quick Dial: [04], [05] Speed Dial: [04], [05], [06] Ten Key: 0312345678, 0451119999	

This section describes how to program or edit a Group. You can also get a printout of numbers that are already stored. In this example we will program Group 1 into Quick Dial key 01.

**1** Press **[Function] [3] [3]**, and then the **[Yes]** key.

```
GROUP 1 1-3/4
PRINT LIST/SEARCH
```

**2** Enter the number of the group you want to program or edit.

**Note**

- e.g. Group 1: Press **[1]**.
- To print a list, press the **[Left]** key, and then press the **[Start]** key.

**3** Press the **[Yes]** key.

```
GROUP 1 Y/N
PROGRAM QUICK?
```

**4** To program or edit a Quick Dial key for this group, press the **[Yes]** key.

```
GROUP 1 QUICK/N
```

**Note**

- If you do not program or edit, press the **[No]** key and go to step **6**.

**5** Press the Quick Dial key you wish to use for this group, **[01]** for example, and then press the **[Yes]** key.

**Note**

- If you want to free up the old Quick Dial key, press the **[No]** key, and then the **[Yes]** key.

```
GROUP 1 Y/N
PROGRAM LABEL?
```

- If a message like "USED AS..." flashes up, the key is already in use. Press a different key.

**6** If you wish to give this group a name, press the **[Yes]** key.

```
GROUP 1 ABC
```

**Note**

- If not, press the **[No]** key and go to step **6**.

**7** Enter or edit the name, and then press the **[Yes]** key.

How to enter characters, see P.30 "Entering Characters"

```
GROUP 1 KPAD/N
```

3

Setup

**8** Enter a fax number.

**Note**

- Enter a fax number in one of these ways :
  - Press a Quick Dial key.
  - Press the Speed Dial key followed by two digits.
  - Enter a number on the ten key pad.

**9** Press the **[Yes]** key.

**Note**

- If "ALREADY PROGRAMMED" briefly flashes up on the display, either press the **[No]** key to keep the number and choose another number, or press the **[Yes]** key to clear.

**10** Press the **[No]** key to finish entering numbers in this group.

**Note**

- To enter another number, go back to step **8**.

**11** Press the **[Function]** key.

**Note**

- To work on another group, go to step **8**.

## Erasing Groups

These steps describe how to erase single numbers from a group.

**1** Press the **[Function]** **[3]** **[3]**, and then the **[Yes]** key.

```
GROUP 1 1-3/
PRINT LIST/SEARCH
```

**2** Enter the group number using the ten key pad, and then press the **[Yes]** key.

```
GROUP 1 Y/N
PROGRAM QUICK?
```

**3** Press the **[No]** key.

```
GROUP 1 Y/N
PROGRAM LABEL?
```

**4** Press the **[No]** key.

```
GROUP 1 Y/N
CLEAR?
```

**5** Press the **[Yes]** key.

```
GROUP 1 Y/N
CLEARED
```

**6** Press the **[Function]** key.

**Note**

- To delete another number, go to step **2**.

## Programming the Group Key

You can program the 3 groups. However, if there is no room in Quick Dial keys, this group key is helpful. You have to Quick Dial 10 as the group key. How to transmit using the group key, see P.11 "Memory Transmission".

- 1 Press **[Function] [3] [1]**, and then the **[Yes]** key.



```
QUICK/
PRINT LIST/SEARCH
```

- 2 Press Quick Dial **[10]**.

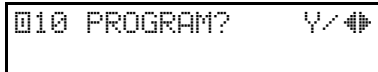

```
010 PROGRAM?
Y/N
```

- 3 Press the **[Yes]** key.



```
010
PROGRAM GROUP KEY?
Y/N
```

- 4 Press the **[Yes]** key.



```
QUICK/
PRINT LIST/SEARCH
```

- 5 Press the **[Function]** key.

3

Setup

## Entering Characters

Use the ten key pad for entering numbers. Use Quick Dial keys 1 to 8 for entering letters, the ◀ and ▶ keys to change to another letter, the **[Yes]** key to accept a character, and Quick Dial key 10 for spaces and other characters.

If at any time you make a mistake when entering a character or digit, press the **[Clear]** key to erase it. To correct a character or number already entered, use the ◀ and ▶ keys to reach the mistake, enter the new character, and press **[Clear]** key to erase the mistaken character. If you press the **[No]** key, whole characters are erased.

3

Quick Dial Key	Letters	Quick Dial Key	Letters
01 A-	A, B, C	06 P-	P, Q, R
02 D-	D, E, F	07 S-	S, T, U
03 G-	G, H, I	08V-	V, W, X, Y, Z
04 J-	J, K, L	09	Nothing
05 M-	M, N, O	10 &, \$, !...	Space & Symbols

### Note

- Enter the fax number using the "+", "space", and number keys.

## Entering Symbols

**1** Press **[10]** of the Quick Dial key.

**2** Press the ◀ and ▶ keys to scroll symbols.

### Note

- You can enter the following symbols. "Space" & \$! " # % ' ( ) \* + , . / : ; < = > ? @ [ ¥ ] ^ \_ ` { } ~ ° -

**3** Press the **[Yes]** key.

## Entering Numbers

**1** Enter numbers using the ten key pad.

---

## Wild Cards

---

This feature greatly enhances the effectiveness of the following feature:

- Authorized Reception

In each of these features, you have to store the OWN NAME or FAX NUMBER of various terminals that you normally receive fax messages from. Then, when your machine detects an incoming call, it checks the OWN NAME or FAX NUMBER of the other terminal, and acts accordingly.

When you program OWN NAME's for these features, you can program wild cards to greatly expand the number of terminals that you can specify.

For example, if you wish to accept messages from all 150 branches of XYZ Company (using Authorized Reception), you do not have to store the OWN NAME of each branch of XYZ Company. Program "XYZ" as a wild card for Authorized Reception. If the OWN NAME's of all XYZ branches contain an "XYZ" somewhere in the OWN NAME, messages coming in from them will be accepted, and sent on to head office.

### Note

- This feature cannot recognize spaces. If you store MAN as a wild card, and a terminal with an OWN NAME that includes MANCHESTER, HUMAN, or HUMANE calls you, your machine will recognize MAN as a wild card and accept the message.

### Reference

Authorized Reception: see Chapter 7, "Rejecting or Accepting Messages from Specified Senders (Authorized Reception)" in the Advanced Features manual.

OWN NAME and FAX NUMBER: see P.21 "Initial Settings and Adjustments".

Setup

---

3

# 4. Troubleshooting

## Loading Paper into the Paper Tray

### Important

- When loading paper into the Paper Tray, do not load more than 100 sheets of paper (70g/m<sup>2</sup>–90g/m<sup>2</sup>). Overloading the Paper Tray can cause misfeeds.
- Curled paper might cause misfeeds.
- When paper can not be fed into the machine, set the paper inside out.

- 1** Fan the stack paper to make sure that all pages are not sticking together. The Paper Tray holds up to 100 sheets of paper (70g/m<sup>2</sup>–90g/m<sup>2</sup>).

### Note

- Remove any paper that may have dropped inside the machine in the area vacated by the Paper Tray.

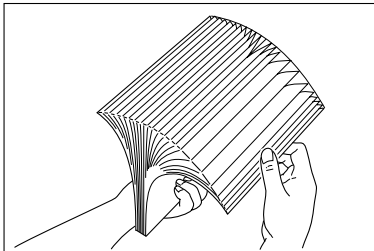

- 2** Square the stack by tapping it on a desk or tabletop.

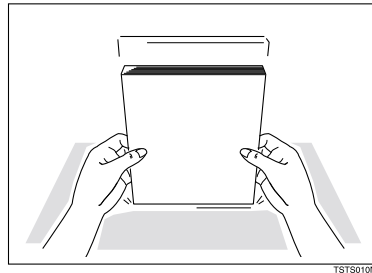

- 3** Push the Document Delivery Tray toward the Operation Panel (1), place paper into the Paper Tray (2).

### Limitation

- Do not fill up papers over the limit mark on the tray guide.

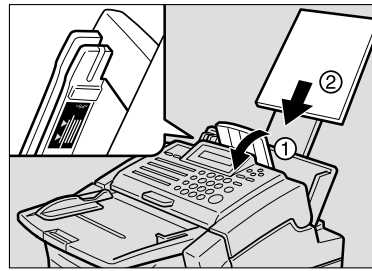

### The meaning of the limit mark

- White Line  
Recommended amount of paper.
- Orange Line  
Maximum amount of paper.

- 4** Gently return the Document Delivery Tray to its original position.

## Troubleshooting

---

- 5** Squeeze the tray guide and slide it against the edge of the stack.

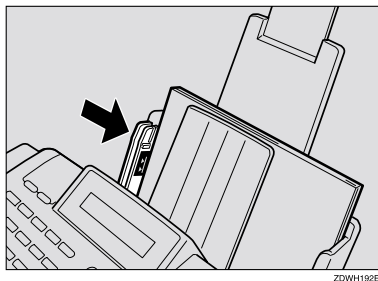

4

**Note**

- ❑ Paper misfeeds or paper jam may occur if you ignore the limitation of paper amount.



## Adjusting The Volume and Sounds The Machine Makes (Function 92)

You can change the beeper (monitor) volume of the desired feature.

TRANS MONITOR	The sound of signal transmissions.
RECV MONITOR	The sound of signal receptions.
ONHOOK MONITOR	The sound of signal on hook dialing.
DIAL MONITOR	The sound when a number is dialed.
BUZZER	The sound (does not buzz) to signal something going amiss.
KEY	The sound when a key is pressed.

- 1 Press **[Function] [6]** and enter the access number **[2] [2] [2] [2]**. Then press **[9] [2]**.

```
ADJUSTMENT  Y/NEXT▶
92 ADJUST VOLUME
```

- 2 Press the **[Yes]** key.
- 3 Adjust the transmission monitor volume with the **◀** and **▶** keys, and then press the **[Yes]** key when finished.

```
TRANS MONITOR  Y/▶◀
MIN ▶▶▶      MAX
```

- 4 Adjust the reception monitor volume with the **◀** and **▶** keys, and then press the **[Yes]** key when finished.

```
RECV MONITOR  Y/▶◀
MIN ▶▶▶      MAX
```

- 5 Adjust the on hook monitor volume with **◀** and **▶** keys and press the **[Yes]** key when finished.

```
ONHOOK MONITOR Y/▶◀
MIN ▶▶▶      MAX
```

- 6 Adjust the dial monitor volume with the **◀** and **▶** keys, and then press the **[Yes]** key when finished.

```
DIAL MONITOR  Y/▶◀
MIN ▶▶▶      MAX
```

- 7 Adjust the BUZZER monitor volume with the **◀** and **▶** keys, and then press the **[Yes]** key when finished.

```
BUZZER        Y/▶◀
MIN ▶▶▶      MAX
```

- 8 Adjust the KEY volume with the **◀** and **▶** keys, and then press the **[Yes]** key when finished.

```
KEY           Y/▶◀
MIN ▶▶▶      MAX
```

- 9 Press the **[Function]** key to return to standby mode.

## If an Indicator Lights on the Operation Panel

- ◆ **“PRESS STOP KEY” appears in the display:**

Press the [Stop] key.

- ◆ **The Receive File indicator is lit:**

You have received a fax message which is now stored in the memory. See Chapter 4, “Printing Messages that Have Been Received into Memory (Substitute Reception)” in the Advanced Features manual.

4

- ◆ **The Check Display indicator is lit:**

Read the message on the display and check the descriptions listed on P.43 “Error Messages”.

- ◆ **The Add Toner indicator is blinks:**

The toner cartridge is nearly empty.

- ◆ **The Add Toner indicator is lit:**

The toner cartridge is empty. Install a new cartridge. See Chapter 9, “Replacing the Toner Cartridge and Cleaning Pad” in the Advanced Features manual.

## Communication Problems

If "ERROR PRESS STOP " appears in the display: Press the **[Stop]** key.

ERROR PRESS STOP KEY

Causes:

- A poor line caused the communication to fail.
- The line is noisy. Try to retransmit.
- The other machine is out of order. Ask the other party to check their machine.

4

## Clearing a Document Jam

When an original is jammed, "CLEAR ORIGINAL" is displayed – follow this procedure to solve the problem.

**Note**

- If copies, fax messages or prints are jammed, follow the next procedure.

**1** Open the operation panel.

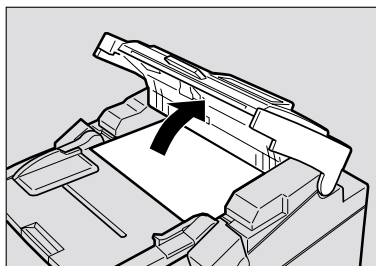

ZDWH061E

**Important**

- Do not pull out the document without opening the operation panel, or you will damage the scanning mechanism.

**2** Pull out the misfed original.

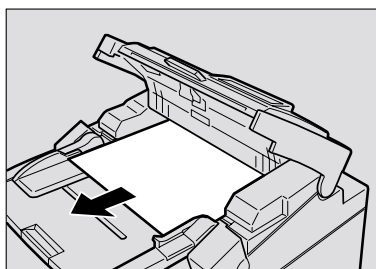

ZDWH062E

**3** Close the operation panel, and make sure it locks securely into place.

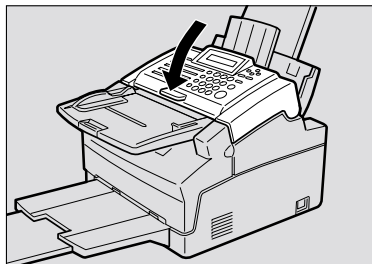

ZDWH071E

**Important**

- If copying was in progress, be sure to specify the desired copy quantity again.

## Clearing a Copy, Fax, or Print Jam

When "CLEAR COPY" is displayed, follow this procedure to solve the problem. For how to clear original jams, see the previous procedure.

### **⚠ WARNING:**

When removing the toner cartridge, do not touch the electrical elements and a screw inside the machine as this may damage the unit.

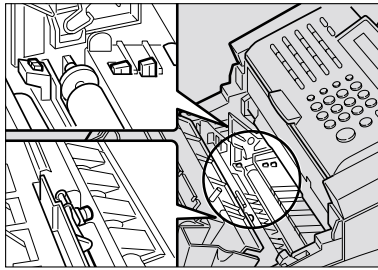

### **⚠ CAUTION:**

When removing misfed paper, do not touch the fusing section because it could be very hot.

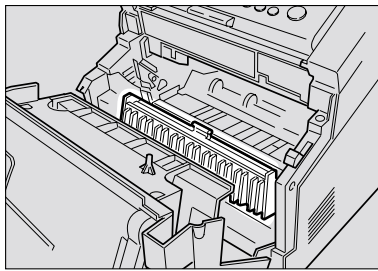

### **⚠ Important**

- Hold a misfed sheet with both hands and slowly pull it out. Do not use a tool, such as a screwdriver or tweezers as this may damage the unit.

### **✎ Note**

- If "CLEAR COPY" is still displayed after you clear the jam, there may be paper jammed in another part of the machine. Check all areas described in this section
- Switch the power off when loading paper. If you leave the power switched on, the paper may be fed in to the machine causing a paper jam. Always leave the power switched on when removing paper.

4

## Inside the Machine

- 1** Lift up the tabs located on the sides of the machine and open the Front Unit.

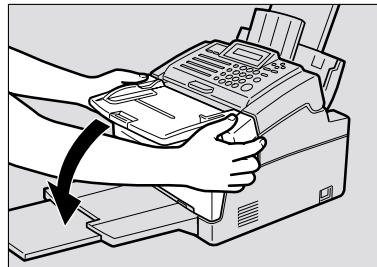

### **⚠ Important**

- Please remove the paper on the Print Delivery Tray, before you open the Front Unit.

Troubleshooting

**2** Pull out the toner cartridge.

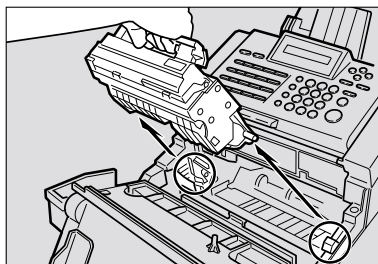

ZDWY041E

**Note**

- Be sure to hold the toner cartridge by its handle.
- Keep the toner cartridge horizontal to avoid spilling the toner.

**3** Push back the blue paper release lever located on the right.

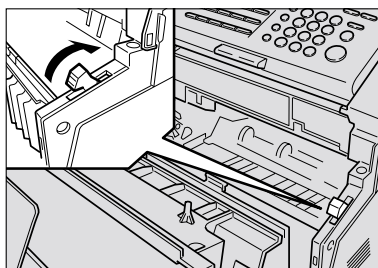

ZDWY010E

**Note**

- The lever releases pressure on the paper. If you do not push it back, you could damage the machine when removing paper.

**4** Pull out the misfed paper in the directions indicated by the arrows in the illustrations.

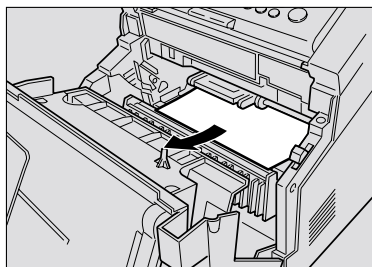

ZDWY021E

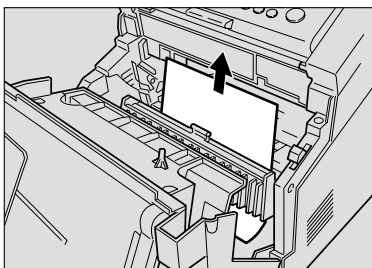

ZDWY020E

**Note**

- If toner gets on your hands, wash them immediately.

**5** Pull the blue release lever back to its original position.

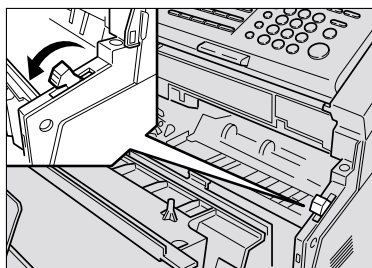

ZDWY011E

**6** Install the toner cartridge into the machine.

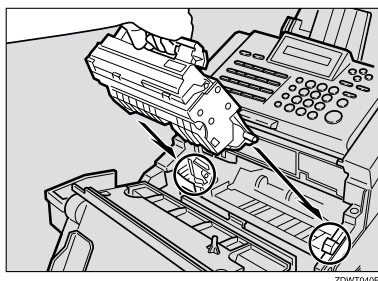

ZDWT040E

**Note**

- Be sure to hold the toner cartridge by its handle.
- Keep the toner cartridge horizontal to avoid spilling the toner.

**7** Close the Front Unit.

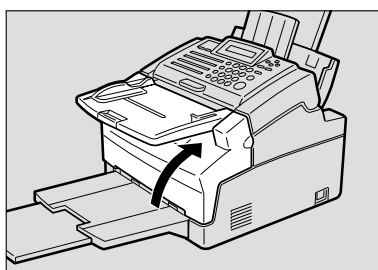

ZDWH051E

**Important**

- If a paper misfeed occurs during a copy job, be sure to specify the desired copy quantity again.

**Note**

- If "CLEAR COPY" is still displayed after you clear the jam, there may be paper jammed in another part of the machine. Check all areas described in this section.

**When Paper Will Not Feed**

If the paper do not feed well, check using the following procedure.

**Important**

- When loading paper into the Paper Tray, do not load more than 100 sheets of paper (70g/m<sup>2</sup>-90g/m<sup>2</sup>). Overloading the Paper Tray can cause misfeeds.
- Curled paper might cause misfeeds.
- When paper will not feed, set the paper inside out.

4

**1** Remove all paper.

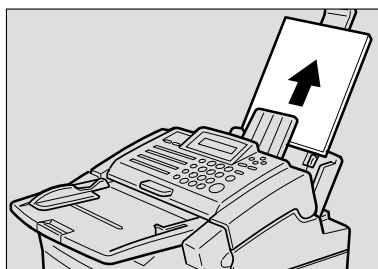

ZDWH200E

**2** Lift up the tabs located on the sides of the machine and open the front unit.



ZDWH042E

**Important**

- Please remove the paper on the Print Delivery Tray, before you open the Front Unit.

## Troubleshooting

- 3** Close the front unit. When the front unit is closed, the motor will start running. When the sound of the motor stops, set paper in the original position and continue with normal operation.

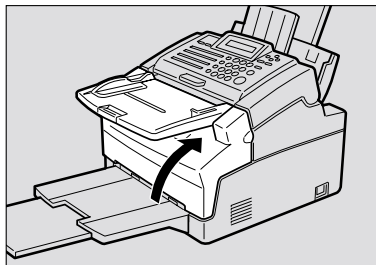

ZDWH051E

4

- 4** Make sure that the paper tray is set correctly.

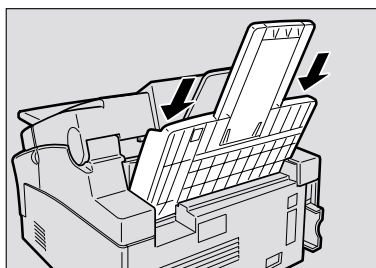

ZDWH100E



## Error Messages

The following messages may appear while you are operating or programming the machine.

NO FILE EXISTS	No polling reception operations have been programmed. There are no messages in memory waiting for transmission. Incorrect file number. Check the file number and try again.
TOO MANY DEST.	The memory cannot hold any more telephone numbers. Either: <ul style="list-style-type: none"> <li>• Delete some numbers, and try again.</li> <li>• Wait until some of the Send Later or other delayed transmissions waiting in memory have been carried out, and try again.</li> </ul>
USED AS GROUP DIAL	This Quick Dial Key has a Group stored in it.
USED AS DIAL	This Quick Dial Key has a telephone number stored in it.
USED AS GROUP KEY	This Quick Dial Key is programmed as Group Key.
USED AS DIAL OPTION	Dial Option feature is set in Quick 09.
NOT PROGRAMMED	Either: <ul style="list-style-type: none"> <li>• This Quick Dial Key or Speed Dial Code does not contain a number.</li> <li>• This Quick Dial Key does not contain a Keystroke Program.</li> </ul>
ALREADY PROGRAMMED	This number is already included in this Group.
ADD TONER	The toner cartridge is empty. Install a new cartridge.
ADD PAPER	The Paper Tray is empty. Load the paper.
CLEAR ORIGINAL	A document is jammed in the Automatic Document Feeder. A document is stopped while the document is being scanned in.
CLEAR COPY	Paper is jammed in the printer.
CLOSE COVER	A cover is not closed properly. Check that Front Unit is closed.
UNABLE USE PRINTER	Machine cannot print a list/file, because the heater is not warm enough or printer is not ready, the machine is receiving a fax message or reports are printed automatically.

## Troubleshooting

---

SERVICE CALL ■■■-■■■H	Machine is out of order. Switch the power off then on again. If the same message appears, even after doing this, call your service representative.
◀CHECK PAPER SIZE	The size of the installed paper does not match the currently selected paper size. Set the paper size or install the appropriate paper. See Chapter 9, "Changing the Paper Size Settings" in the Advanced Features manual.
TONER NEAR EMPTY	The toner cartridge is nearly empty.

## Solutions to Common Problems

If a problem is not cleared, even after performing the Action Required, call your service representative.

Problem	Required Action
STANDBY MODE	
Nothing happens when the switch is turned on.	Check the power cord. Is it properly plugged into the outlet? Plug it in firmly.
SET DOC. OR DIAL NO. is not displayed.	Switch the power on. If no characters are displayed, check that the power cord is plugged in.
The display does not show the Ready condition, or the machine stops during an operation.	Does "CLEAR ORIGINAL" or "CLEAR COPY" appear in the display? Clear the misfed paper.
	 <b>Reference</b> See P.38 "Clearing a Document Jam", P.39 "Clearing a Copy, Fax, or Print Jam".
	Does "ADD PAPER" appear in the display? Load paper into the paper tray. See P.33 "Loading Paper into the Paper Tray".
	Does "CLOSE COVER" appear in the display? Close the Front Unit.
	Is the Add Toner indicator on? Load a new toner cassette. See Chapter 9, "Replacing the Toner Cartridge and Cleaning Pad" in the Advanced Features manual.

4

Troubleshooting

Problem	Required Action
TRANSMISSION	
The original is not pulled into the Automatic Document Feeder.	<p>In case panel display is not changed to "DIAL FAX NUMBER", you did not feed the document far enough into the Automatic Document Feeder.</p> <p>Insert the document into the Automatic Document Feeder until it stops.</p> <p>Retransmit.</p>
	Do user maintenance, especially rollers(1). See Chapter 9, "Cleaning the Rollers and Scanner" in the Advanced Features manual.
	<p>The telephone line is disconnected.</p> <p>Check that the line is connected properly.</p>
	<p>The telephone line type setting is incorrect.</p> <p>Check the telephone line type setting. See Chapter 7, "Setting the Phone Line Type (Function 62)" in the Advanced Features manual.</p>
	<p>If your machine is connected to your PBX, the dialed number does not contain an PSTN access code or a pause.</p> <p>Include the PSTN access number and a pause before the telephone number.</p> <p>Check the Access Number setting. See Chapter 7, "Setting the Access Number (Function 61)" in the Advanced Features manual.</p>
	<p>If your machine is connected to your PBX, the dialed number did not have enough pauses between the access PSTN number and the telephone number.</p> <p>Try adding more pauses after the access PSTN code.</p>
	<p>The Country Code setting is incorrect.</p> <p>Check the Country Code setting. See Chapter 7, "Setting the Country Code (Function 61)" in the Advanced Features manual.</p>
	<p> <b>Note</b></p> <p><input type="checkbox"/> This Function is not available in some areas.</p>

4

Problem	Required Action
Frequent original misfeeds (Multifeeds)	Incorrect positioning of originals Put the document in the Automatic Document Feeder correctly. See P.11 <i>"Memory Transmission"</i> .
	Incorrect alignment of originals Align the edges of the document. See P.10 <i>"Suitable Document Types"</i> .
	Curled pages Flatten the document. See P.10 <i>"Suitable Document Types"</i> .
	Incorrect document type Use a proper document type. See P.10 <i>"Suitable Document Types"</i> .
	Mixed document types The pages must all be of the same type.
	Static electricity on the originals Shuffle the document. See P.11 <i>"Memory Transmission"</i> .
	User maintenance is needed. Do user maintenance, especially roller (1). See Chapter 9, <i>"Cleaning the Rollers and Scanner"</i> in the Advanced Features manual.
Frequent original misfeeds (Non-feeds)	Copier silicone oil on the originals Wait a few minutes, and then try again.
	Incorrect alignment of originals Align the edges of the document. See P.11 <i>"Memory Transmission"</i> .
	Curled pages Flatten the document. See P.10 <i>"Suitable Document Types"</i> .
	Incorrect document type Use a proper document type. See P.10 <i>"Suitable Document Types"</i> .
	Do not place more than 30 pages (80g/m <sup>2</sup> ) in the Automatic Document Feeder at once. If document types are not appropriate, or documents are damp, reduce the number of pages then place the documents in the Automatic Document Feeder.
	User maintenance is needed. Do user maintenance, especially rollers (1). See Chapter 9, <i>"Cleaning the Rollers and Scanner"</i> in the Advanced Features manual.

Troubleshooting

4

Problem	Required Action
Transmission cannot take place; CLEAR ORIGINAL appears.	The document is jammed in the Automatic Document Feeder. Remove the jammed document. See P.38 "Clearing a Document Jam"
	The document may be longer than the maximum limit (see Chapter 11, "Document and Paper Specifications" in the Advanced Features manual). Make sure that none of your originals exceed this limit.
	Do user maintenance, especially rollers (1). See Chapter 9, "Cleaning the Rollers and Scanner" in the Advanced Features manual.
Transmission cannot take place. Before taking action, wait until the machine is in standby mode, and then press the <b>[Stop]</b> key.	The other machine is out of order. Check the error report. Ask the other party to check their machine and correct the fault.
	The line is noisy. Check that the dial tone is sent out. Try to retransmit.
Consistent difficulty in communicating with a particular terminal	There are some bad lines between you and that other terminal. Store that terminal's number as a Quick Dial Key or Speed Dial Code.
Consistent poor image quality when communicating with a particular terminal	Then call a service technician. Inform the nature of the problem and give the Quick Dial Key or Speed Dial Code that you stored the number in.
RECEPTION	
The telephone keeps ringing and no fax is printed.	You might be in TEL mode. Change to Auto or FAX mode. See P.18 "Reception Modes".
	Power is switched off. Switch the power on.
RECEPTION/COPYING	
No printout; the Check Disp. indicator is lit. ADD PAPER appears.	The Paper Tray are empty. Add Paper . See P.33 "Loading Paper into the Paper Tray".
No printout; CLEAR COPY appears.	The printer has jammed. Clear the jam. See P.39 "Clearing a Copy, Fax, or Print Jam".
Copies are blank.	The original might be placed face up in the Automatic Document Feeder. Position the original correctly. See P.11 "Memory Transmission".

Problem	Required Action
Copies are wrinkled.	Is the copy paper set at an angle? Make sure the paper is set correctly. See P.33 "Loading Paper into the Paper Tray" Make sure the paper tray is installed correctly. See the setup guide, "Before You Use This Machine".
Copy paper misfeeds occur frequently.	Is the proper paper in the paper tray? Paper size and weight must be within the standards set for this machine. See Chapter 11, "Specifications" in the Advanced Features manual.
	Is folded, wrinkled, damp, or curled paper in the paper tray? Always use dry, undamaged paper.
	Is the paper set properly in the paper tray? Always load paper correctly. See P.33 "Loading Paper into the Paper Tray". Make sure that there is not too much paper in the trays; do not fill them up over the load limit mark (White Line).
	Are there any pieces of misfed paper or other foreign objects in the machine? Make sure that the paper path is completely clear of paper and other material after a misfeed.
	Are you copying onto recycled paper? Fan the stack of recycled paper and load it in the paper tray.
Stripes on copies.	The scanner is dirty. Clean scanner (4, 5). See Chapter 9, "Cleaning the Rollers and Scanner" in the Advanced Features manual.
<b>TELEPHONING</b>	
You cannot receive phone calls; the unit only rings once then goes into receive mode.	You might be in FAX mode. Change to TEL or Auto mode. See P.18 "Reception Modes".
You cannot receive phone calls; the unit does not ring.	The telephone line is not connected. Connect the modular cord. See Chapter 10, "Connecting Up to the Telephone Line" in the Advanced Features manual.

# INDEX

## A

---

- Add Toner indicator, 5
- Arrow keys, 5
- Automatic Document Feeder (ADF), 3
- Auto mode, 18

## C

---

- Canceling a Memory Transmission, 14
  - Before start is pressed*, 14
  - During Transmission*, 14
  - While the document is being scanned in*, 14
  - While the message is awaiting transmission (Functions 21)*, 14
- Canceling an Immediate Transmission, 15
  - Before start is pressed*, 15
  - While dialing or during transmission*, 15
- Characters, 30
- Check Display indicator, 5
- CLEAR COPY, 39
- Clearing a Jam
  - Document*, 38
  - inside the machine*, 39
- Clear key, 6
- Communication Problems, 37
- Control panel Display, 5
- Copy key, 6
- CSI → FAX NUMBER, 21

## D

---

- Document Delivery Tray, 3
- Document Guides, 3
- Document Jam, 38

## E

---

- Editing
  - Fax Numbers*, 23
  - Group*, 26
  - Quick Dial Numbers*, 23
  - Speed Dial Numbers*, 24
- Entering
  - Characters*, 30
  - Numbers*, 30
  - Symbols*, 30
- Erasing
  - Group*, 28
  - Quick Dial Numbers*, 23
  - Speed Dial Numbers*, 24
- Error Messages, 43

## F

---

- FAX HEADER, 21
- Faxing, 9
- Fax mode, 18
- FAX NUMBER, 21
- Front Unit, 3
- Front Unit Release Tab, 3, 4
- Function key, 6

## G

---

- Group Dial List, 27
- Group Key, 29

## I

---

- Immediate Transmission, 9, 15
- Indicators
  - Add Toner*, 5, 36
  - Check Display*, 5, 36
  - Manual Receive*, 19
  - Memory*, 5, 11
  - Receive File*, 5, 36
- Initial Settings, 21
- Introduction, 3

## L

---

- Lists
  - Group Dial List*, 27
  - Quick Dial List*, 24
  - Speed Dial List*, 24

## M

---

- Manual Receive indicator, 19
- Memory indicator, 5
- Memory Transmission, 9, 11

## O

---

- On Hook Dial key, 6
- Operation Panel, 3, 5
- Optional Card Insertion Slots, 4
- OWN NAME, 21



## P

---

- Paper, 33
- Paper Tray, 3
- Paper Tray Extension, 3
- Part Names
  - Front View*, 3
  - Rear View*, 4
- Pause/Redial key, 6
- Power Socket, 4
- Power Switch, 3
- Print Delivery Tray, 3
- Programming
  - FAX HEADER*, 21
  - FAX NUMBER*, 21
  - Fax Numbers*, 23
  - Group*, 26
  - Group key*, 29
  - OWN NAME*, 21
  - Quick Dial Numbers*, 23
  - Speed Dial Numbers*, 24

## Q

---

- Quick Dial, 23
- Quick Dial keys, 6
- Quick Dial Label, 24
- Quick Dial List, 24
- Quick Dial Sheet, 24

## R

---

- Receive File indicator, 5
- Reception Mode
  - Auto Mode*, 18
  - Fax Mode*, 18
  - Telephone Mode*, 18
- Reception Mode key, 5
- Resolution, 17
- Resolution key, 5
- RTI → OWN NAME, 21

## S

---

- Sending a Fax, 11
- Solutions to Common Problems, 45
- Speed Dial, 5, 24
- Speed Dial List, 24
- Start key, 6
- Stop key, 6
- Suitable Document Types, 10
- Symbols, 7

## T

---

- Telephone mode, 18
- TEL/LINE, 4
- Ten key pad, 6
- Thin and Soft Documents, 16
- Transmission
  - Immediate*, 15
  - Memory*, 11
- Troubleshooting, 33
- TTI → FAX HEADER, 21

## V

---

- Volume Control, 35

## W

---

- When Paper Will Not Feed, 41
- Wild Cards, 31

MEMO

In accordance with IEC 60417, this machine uses the following symbols for the main power switch:

**I** means **POWER ON.**

**O** means **POWER OFF.**



## **RICOH COMPANY, LTD.**

15-5, Minami Aoyama 1-chome,  
Minato-ku, Tokyo 107-8544, Japan  
Phone: +81-(0)3-3479-3111

Ricoh shall not be responsible for any damage or expense that may result from the use of parts other than recommended parts.

For good copy quality, Ricoh recommends that you use genuine Ricoh toner.

### **TONER CARTRIDGE**

**RICOH FAX TONER CARTRIDGE TYPE 1340 BLACK** is recommended for the best performance.

## **Overseas Affiliates**

### **U.S.A.**

RICOH CORPORATION  
5 Dedrick Place  
West Caldwell, New Jersey 07006  
Phone: +1-973-882-2000

### **The Netherlands**

RICOH EUROPE B.V.  
Groenelaan 3, 1186 AA, Amstelveen  
Phone: +31-(0)20-5474111

### **United Kingdom**

RICOH UK LTD.  
Ricoh House,  
1 Plane Tree Crescent, Feltham,  
Middlesex, TW13 7HG  
Phone: +44-(0)20-8261-4000

### **Germany**

RICOH DEUTSCHLAND GmbH  
Mergenthalerallee 38-40,  
65760 Eschborn  
Phone: +49-(0)6196-9060

### **France**

RICOH FRANCE S.A.  
383, Avenue du Général de Gaulle  
BP 307-92143 Clamart Cedex  
Phone: +33-(0)1-40-94-38-38

### **Spain**

RICOH ESPAÑA S.A.  
Avda. Litoral Mar, 12-14,  
08005 Barcelona  
Phone: +34-(0)93-295-7600

### **Italy**

RICOH ITALIA SpA  
Via della Metallurgia 12,  
37139 Verona  
Phone: +39-045-8181500

### **Hong Kong**

RICOH HONG KONG LTD.  
21/F., Tai Yau Building,  
181, Johnston Road,  
Wan Chai, Hong Kong  
Phone: +852-2862-2888

### **Singapore**

RICOH ASIA PACIFIC PTE.LTD.  
260 Orchard Road,  
#15-01/02 The Heeren,  
Singapore 238855  
Phone: +65-830-5888

**FAX1400L Operating Instructions**

Printed in China

AE (AE) H538-8609

## Free Manuals Download Website

<http://myh66.com>

<http://usermanuals.us>

<http://www.somanuals.com>

<http://www.4manuals.cc>

<http://www.manual-lib.com>

<http://www.404manual.com>

<http://www.luxmanual.com>

<http://aubethermostatmanual.com>

Golf course search by state

<http://golfingnear.com>

Email search by domain

<http://emailbydomain.com>

Auto manuals search

<http://auto.somanuals.com>

TV manuals search

<http://tv.somanuals.com>