

RICOH

OPERATOR'S MANUAL

RICOH FAX 170 / 180

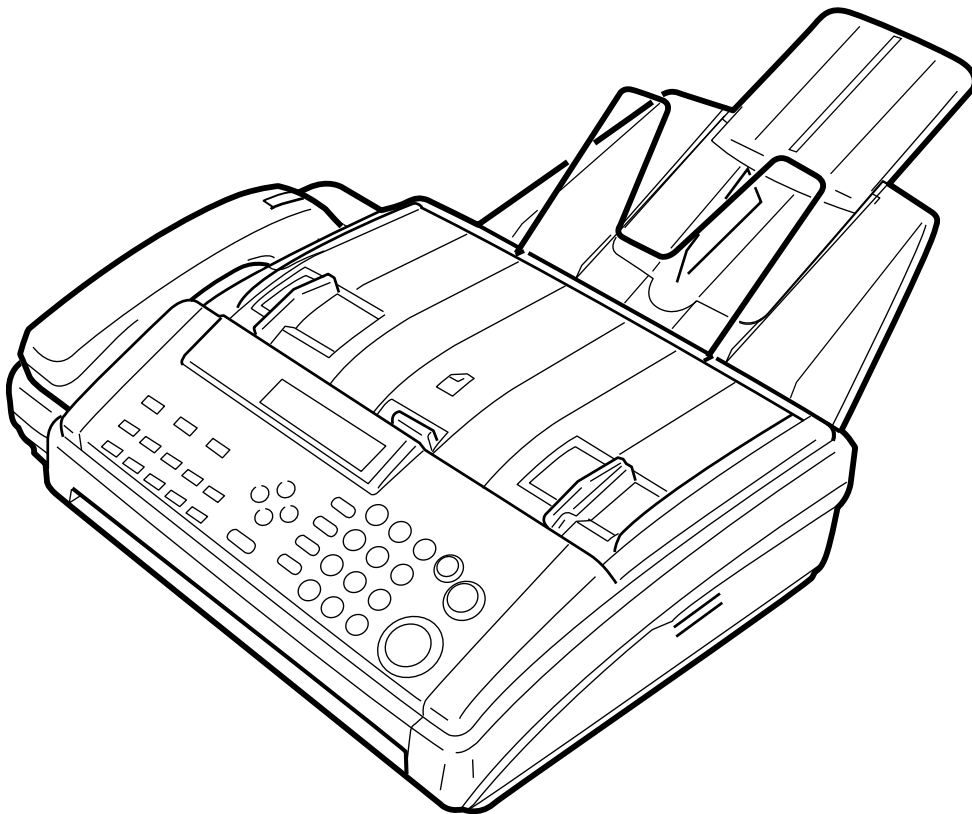

Type I.....RICOH FAX 180

Type II.....RICOH FAX 170

Please read all of these instructions and keep this manual by your machine.

OFFICIAL NOTICE TO USERS

USA

FCC Requirements

1. This equipment complies with Part 68 of the FCC rules. On the cover of this equipment is a label that contains, among other information, the FCC registration number and ringer equivalence number (REN) for this equipment. If requested, this information must be provided to the telephone company.
2. This equipment uses the following USOC jack: RJ11C
3. The REN is used to determine the quantity of devices which may be connected to the telephone line. Excessive REN's on the telephone line may result in the devices not ringing in response to an incoming call. In most, but not all areas, the sum of the REN's should not exceed five (5.0). Contact the telephone company to determine the maximum REN for the calling area.
4. If this equipment causes harm to the telephone network, the telephone company will notify you in advance that temporary discontinuance of service may be required. If advance notice is not practical, the telephone company will notify the customer as soon as possible. Also, you will be advised of your right to file a complaint with the FCC if you believe it is necessary.
5. The telephone company may make changes in its facilities, equipment, operations, or procedures that could affect the operation of the equipment. If this happens, the telephone company will provide advance notice in order for you to make necessary modifications in order to maintain uninterrupted service.
6. In the event of operation problems (document jam, copy jam, communication error indication), refer to the solving problems section in this manual.
7. If you cannot correct the problem, please contact the RICOH CORP. CUSTOMER SUPPORT DEPT. at 1-800-FASTFIX for repair and warranty information. If it is causing harm to the telephone network, the telephone company may request you to disconnect the equipment from the network until the problem is resolved.
8. This equipment cannot be used on telephone company-provided coin service. Connection to Party Line Service is subject to state tariffs.

WHEN PROGRAMMING EMERGENCY NUMBERS AND/OR MAKING TEST CALLS TO EMERGENCY NUMBERS:

1. Remain on the line and briefly explain to the dispatcher the reason for the call before hanging up.
2. Perform such activities in the off-peak hours, such as early morning hours or late evenings.

CANADA

The Industry Canada label identifies certified equipment. This certification means that the equipment meets certain telecommunications network protective, operational, and safety requirements. The department does not guarantee the equipment will operate to the user's satisfaction. Before installing this equipment, users should ensure that it is permissible to be connected to the facilities of the local telecommunications company. The equipment must also be installed using an acceptable method of connection. The customer should be aware that compliance with the above conditions may not prevent degradation of service in some situations.

Repairs to certified equipment should be made by an authorized Canadian maintenance facility designated by the supplier. Any repairs or alterations made by the user to this equipment, or equipment malfunctions, may give the telecommunications company cause to request the user to disconnect the equipment. Users should ensure for their own protection that the electrical ground connections of the power utility, telephone lines, and internal metallic water pipe system, if present, are connected together. This precaution may be particularly important in rural areas.

Caution: Users should not attempt to make such connections themselves, but should contact the appropriate electric inspection authority, or electrician, as appropriate.

The standard connecting arrangement code for this equipment is CA11A.

The Load Number (LN) assigned to each terminal device denotes the percentage of the total load to be connected to a telephone loop which is used by the device to prevent overloading. The termination of a loop may consist of any combination of devices subject only to the requirement that the sum of the load numbers of all the devices does not exceed 100.

SUPPLIES

Caution: Ricoh Shall not be responsible for any damage or expense that may result from the use of parts other recommended parts.

Paper Roll

Paper Roll Type 30AS is recommended for the best performance.

RICOH

Headquarters: Ricoh Corporation, 5 Dedrick Place, West Caldwell, NJ 07006. 201-882-2000
U.S. Government Marketing: Ricoh Corporation, 1700 N. Moore Street, Suite 1200, Arlington, VA22209. 403-525-3234
Ricoh Business Machines Ltd.: 23/F., China Overseas Building, 139 Hennessy Road, WANCHAI, Hong Kong. 2862-2888
Ricoh Company., Ltd. 15-5, Minami-Aoyama 1-chome, Minatoku, Tokyo 107, Japan

ENG

Part No. H0688601B

Printed in China

WARNING: This equipment has been tested and found to comply with the limits for a Class B digital device, pursuant to Part 15 of the FCC Rules. These limits are designed to provide reasonable protection against harmful interference in a residential installation. This equipment generates, uses, and can radiate radio frequency energy and, if not installed and used in accordance with the instructions, may cause harmful interference to radio communications. However, there is no guarantee that interference will not occur in a particular installation. If this equipment does cause harmful interference to radio or television reception, which can be determined by turning the equipment off and on, the user is encouraged to try to correct the interference by one or more of the following measures:

- Reorient or relocate the receiving antenna.
- Increase the separation between the equipment and receiver.
- Connect the equipment into an outlet on a circuit different from that to which the receiver is connected.
- Consult the dealer or an experienced radio/TV technician for help.

Notice about the Telephone Consumer Protection Act (Valid in the USA only)

Attention Please!

The Telephone Consumer Protection Act of 1991 among other things makes it unlawful for any person to send any message via a telephone fax machine unless such message clearly contains in a margin at the top or bottom of each transmitted page or on the first page of the transmission, the date and time it is sent and an identification of the business or other entity, or other individual sending the message and the telephone number of the sending machine or such business, other entity, or individual. This information is transmitted with your document by the TTI (Transmit Terminal Identification) feature.

In order for you to meet the requirement, your machine must be programmed by following the instructions in the accompanying Operation Manual. In particular, please refer to the "Getting Started" and/or "Programming" sections. Also refer to the TTI (Transmit Terminal Identification) programming procedure to enter the business identification and telephone number of the terminal or business. Do not forget to set the date and time.

Thank you.

NOTICE TO USERS (New Zealand)

Equipment connected to the interface port shall be certified to meet the requirements of Reg. 18 of the New Zealand wiring Regulations 1976.

Telepermitted equipment may only be connected to the interface port.

The operation of this equipment on the same line as telephones or other equipment with audible warning devices or automatic ring detectors will give rise to bell tinkle or noise and may cause false tripping of the ring detector. Should such problems occur, the user is not to contact Telecom Faults Service.

Immediately disconnect the equipment should it ever suffer physical damage which results in their internal parts becoming accessible in normal use. Arrange for its disposal or have it repaired before it is reconnected.

Should it necessary to move the equipment, it is necessary to disconnect the Telecom network connection before disconnecting the Power lead or any separate earth lead. Similarly, when reconnecting the equipment it is necessary to connect the power lead or earth lead before connecting the telecom Network.

Not all standard telephones will respond to incoming ringing when connected to the extension socket.

IMPORTANT SAFETY INSTRUCTIONS

1. Read all of these instructions.
2. Save these instructions for later use.
3. Follow all warnings and instructions marked on the product.
4. Unplug this product from the wall outlet before cleaning. Do not use liquid cleaners or aerosol cleaners. Use a damp cloth for cleaning.
5. Do not use this product near water.
6. Do not place this product on an unstable cart, stand, or table. The product may fall, causing serious damage to the product or injuring the user.
7. Slots and openings in the cabinet and the back or bottom are provided for ventilation; to ensure reliable operation of the product and to protect it from overheating, these openings must not be blocked or covered. The openings should never be blocked by placing the product on a bed, sofa, rug or other similar surface. This product should not be placed in a built-in installation unless proper ventilation is provided.
8. This product should be operated from the type of power source indicated on the marking label. If you are not sure of the type of power available, consult an authorized sales person or your local power company.
9. This product is equipped with a 3-wire grounding type plug, a plug having a third (grounding) pin. This plug will only fit into a grounding-type power outlet. This is a safety feature. If you are unable to insert the plug into the outlet, contact your electrician to replace your obsolete outlet. Do not defeat the purpose of the grounding type plug. (This does not apply in countries in which the 2-wire, non-grounded type plug is used)
10. Do not allow anything to rest on the power cord. Do not locate this product where persons will walk on the cord.
11. If an extension cord is used with this product. Make sure that the total of ampere ratings of the products plugged into the extension cord do not exceed the extension cord ampere rating. Also, make sure that the total of all products plugged into the wall outlet does not exceed 15 amperes.
12. Never push objects of any kind into this product through cabinet slots as they may touch dangerous voltage points or short out parts that could result in a risk of fire or electric shock. Never spill liquid of any kind on the product.
13. Do not attempt to service this product yourself, as opening or removing covers may expose you to dangerous voltage points or other risks. Refer all servicing to qualified service personnel.
14. Unplug this product from the wall outlet and refer servicing to qualified service personnel under the following conditions:
 - A. When the power cord or plug is damaged or frayed.
 - B. If liquid has been spilled into the product.
 - C. If the product has been exposed to rain or water.
 - D. If the product does not operate normally when the operating instructions are followed. Adjust only those controls that are covered by the operating instructions since improper adjustment of other controls may result in damage and will often required extensive work by a qualified technician to restore the product to normal operation.
 - E. If the product has been dropped or cabinet has been damaged.
 - F. If the product exhibits a distinct change in performance, indicating a need for service.

Table of Contents

IMPORTANT SAFETY INSTRUCTIONS

INTRODUCTION

WHAT DOES A FAX MACHINE DO?	1
SOME OF THE THINGS THAT THIS MACHINE CAN DO	1
FACSIMILE FEATURES AVAILABILITY TABLE	2
MANUAL OVERVIEW	4
MANUAL CONVENTIONS	5
Key Names	5
Displays	5
Symbols	6

GENERAL PRECAUTIONS

POWER AND GROUNDING	7
Power Supply	7
Grounding	7
COLD WEATHER POWER-UP	8
THUNDERSTORMS	8
PAPER PRECAUTIONS	9
OPERATING PRECAUTIONS	9
GENERAL	9

GUIDE TO COMPONENTS

1. OPERATION PANEL	10
Type I Model (USA)	10
(ASIA)	10
Type II Model	10
2. FRONT VIEW	12
3. REAR VIEW	12

INSTALLING THE MACHINE

LOCATION	13
INSTALLATION	13
Installation Procedure	14
SOME ITEMS MUST BE PROGRAMMED FIRST	16
Overview	16
Setting the Date and Time	17
Setting Your Machine's Identification	18
RTI (Identification Display)	18
TTI (Page Header)	19
CSI (Telephone number display)	20
Tone Dial or Pulse Dial?	21

When You Change to Daylight Saving Time	21
Cutting Paper	22
Switching the Automatic Cutter On	22
Out Line or Extension Telephone System?	23
Setting The Access Number	23
Cutting the Leading Edge of The Paper	24
STORING OFTEN USED NUMBERS	25
Three Convenient Ways to Dial	25
Quick Dial and Speed Dial	25
Groups (Type I Only)	26
Programming Quick Dials	26
Programming a New Quick Dial	27
Editing a Quick Dial	27
Erasing a Quick Dial	28
Programming Speed Dials	29
Programming a New Speed Dial	29
Editing a Speed Dial	30
Erasing a Speed Dial	31
Programming Groups (Type I Only)	31
Programming a Group	31
Editing Group Dial	32
Erasing Group Dials	33
Programming the Group Key	34
OTHER ITEMS TO PROGRAM AT YOUR LEISURE	34
Storing and Dialing Part of a Number	34

BASIC OPERATION

SENDING IMMEDIATELY VS. SCANNING QUICKLY	35
Sending Quickly	35
Scanning Quickly (Type I Only)	35
Sending Quickly(Immediate Transmission)	36
Scanning Quickly (Memory Transmission, Type I Only)	37
Sending to More Than One Location (Broadcasting)	38
Canceling a Memory Transmission	38
Printing The Stored Messages	39
If You Make a Mistake	39
Possible Problems	40
Sending a Page With Very Fine Detail	40
Resolution	41
Selecting The Halftone Type	41
Home Position Setting Adjustments	42
Dialing with the Telephone Directory	43
Other Features for Transmission	44
Sending at a Specific Time	44
Printing the Page Number (Immediate Transmission Only)	45
Sending Your Identification at the Top of Your Message	46

Changing Transmission Mode (Type I Only)	46
Converting Immediate Transmission to Memory Transmission	46
Memory Transmission as Your First Choice	46
REDIALING	47
Automatic Redialing	47
Using the Redial Key	48
RECEIVING FAX MESSAGES	49
Choosing the Reception Mode & How to Receive	49
Overview	49
Giving Priority to Autoselect Mode	49
Setting the Auto Ring Count	49
Connecting the Telephone Answering Machine (TAM) to Your Fax.	50
Giving Priority to Fax Messages (Fax Mode)	50
Giving Priority to Phone Calls (Manual Receive Mode)	50
Receiving	51
Auto Select Mode	51
FAX Mode	51
Tel Mode	52
When You Connect the Telephone Answering Machine	52
If the caller is another fax machine:	52
If the caller is a telephone caller:	52
Receiving Fax Messages When There Is a Problem (Type I Only)	53
Over view	53
Switching Substitute Reception On or Off	53
CHANGING RECEPTION MODE	55
Switching Reception Mode Switch Over On/off	55
Using Reception Mode Switchover	55
MAKING TELEPHONE CALLS	56
Making a Telephone Call	56
Using On Hook Dial	56
Using the Handset	57
Using the Redial key	57
Answering the Telephone	57
To Talk Before Sending a Fax (On Hook Dial)	57

ADVANCED FEATURES

TRANSMISSION	58
Storing an Often Used Document (Type I Only)	58
Overview	58
Storing an Auto Document	58
Using a Program	59
Printing the Contents of an Auto Document	60
Erasing a Program	60
Printing a List of Auto Documents	60
Tonal Signals	61

Operating the Tone Key	61
ECM (Error Correction Mode) and Page Retransmission (Type I Only)	62
Protection Against Wrong Connections	63
Preventing Transfer to a Wrong Connection	63
Preventing a Wrong Connection (ID Transmission)	64
RECEPTION	65
Rejecting Messages from Certain Senders	65
Closed Network Reception	65
Rejection of Messages from Unidentified Senders	65
Authorized Reception	66
Overview	66
Switching Authorized Reception On/Off	67
Selecting Whether to Exclude or Include Senders	67
Programming the Authorized Senders	68
Editing the Authorized Senders	68
Forwarding (Type I Only)	70
Overview	70
Programming the Forwarding Feature	71
Editing the Forwarding Feature	72
Switching Forwarding On/Off	73
Selecting Which Message to Forward	73
Switching Local Printing On/Off	74
Enabling and Disabling the Forwarding Mark	74
Wild Cards	75
OTHER	76
Calling to Request a Message (Polling)	76
Overview	76
Storing the IDCode	76
Leaving Documents to Be Picked up by Others (Polling Transmission)	77
Free Polling	77
Secured Polling	77
Stored ID Override	78
Printing the Contents of Stored Polling Messages (Type I Only)	78
Canceling Polling Transmission Files	79
Type I Models	79
Type II Models	79
Options for Polling Transmission	79
Picking up Messages Stored Elsewhere (Polling Reception)	80
Procedure	80
Stored ID Override Option	80
Canceling Polling Reception	81
Options for Polling Reception	82
Saving Paper	82
RDS (Remote Diagnostic System)	83
Overview	83
Switching RDS On/ Off	83
AI Short Protocol	84

REPORTS

AUTOMATICALLY PRINTED REPORTS	85
SWITCHING REPORTS ON/OFF	86
PRINTING A SAMPLE OF DATA ON THE REPORTS	87
REPORT FORMATS	88
REPORTS YOU CAN PRINT OUT YOURSELF	89

MAINTAINING YOUR MACHINE

DAILY CARE	91
Procedure	91
REPLACING PAPER	93
Procedure	93
PAPER CYCLING	93

SOLVING PROBLEMS

DOCUMENT JAMS	94
COPY JAMS	95
COMMUNICATION PROBLEMS	96
OPERATING DIFFICULTIES	96
DISPLAYED ERROR MESSAGES	97
ERROR CODES	98

TECHNICAL REFERENCE

ENTERING TELEPHONE NUMBERS	100
ENTERING NAMES AND LABELS	100
ON/ OFF SWITCHES AND USER PARAMETERS	101
On /Off Switches	101
User Parameter Settings	102
COUNTERS	106
DOING TWO THINGS AT ONCE (Dual Access) (Type I Only)	106
DOCUMENT TYPE	107
LIMITS ON THE USE OF STORED TELEPHONE NUMBERS	109
SPECIFICATIONS	110
GLOSSARY	111

INDEX

FUNCTION LIST

 Type I Models

 Type II Models

Quick Reference Card

OFFICIAL NOTICE TO USERS

INTRODUCTION

Thank you for purchasing this product. This compact machine is ideal for small businesses and home office users. It is very easy to operate. You will soon become accustomed to its features and will be able to enjoy years of service from it.

WHAT DOES A FAX MACHINE DO?

A fax machine scans your document and converts it into a series of black and white dots (the number of dots there are across and down the page depends on the resolution that you selected; refer to the specifications section of this manual for details). This series of dots is transformed into an electrical signal and sent out over the telephone line to the destination fax machine.

The receiving fax machine reconstructs your letter from the incoming signal and prints it.

If you are worried about whether the message arrived at the destination, you can check a report called the TCR(Transacation Confirmation Report). When you print this report, you can see the result of the most recent fax communications made by your machine.

You can use your fax machine to send and receive many types of documents, even photographs.

SOME OF THE THINGS THAT THIS MACHINE CAN DO

This machine has many features. Here are samples of what the machine can do.

Calling To Request a Message

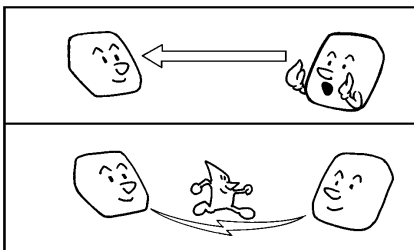

See page 76

Authorized Reception

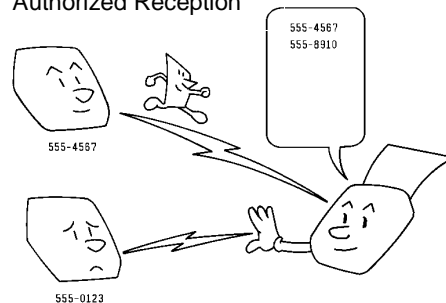

See page 66

Forwarding (TYPE I Only)

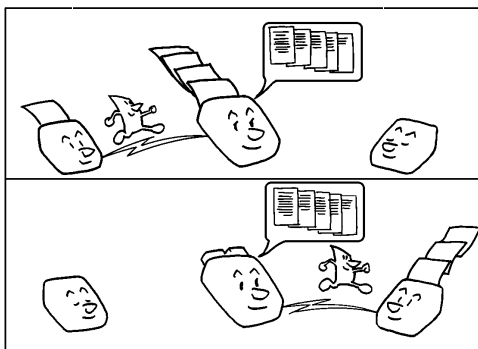

See page 70

Storing an Often Used Document (TYPE I Only)

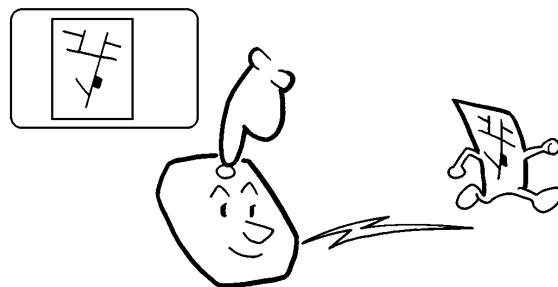

See page 58

FACSIMILE FEATURES AVAILABILITY TABLE

This table shows whether a feature is available or not on your machine. Make sure which model you are using: Type I or Type II.

✓: Possible ✗: Impossible

Feature	Page	Type I	Type II
Sending Quickly (Immediate Transmission)	36	✓	✓
Scanning Quickly (Memory Transmission)	37	✓	✗
Sending to More Than One Location (Broadcasting)	38	✓	✗
Contrast Adjustment	41	Auto	Auto
Resolution Adjustment	41	✓	✓
Halftone	41	✓	✓
Quick Dial	26	✓	✓
Speed Dial	29	✓	✓
Group Dial	31	✓	✗
Printing the Page Number (Page Count)	45	✓	✓
Sending at a Specific Time (Send Later)	44	✓	✓
Sending Your Identification at the Top of Your Message (TTI Print)	46	✓	✓
Telephone Directory	43	✓	✓
Automatic Redialing	47	✓	✓
Redial Key	48	✓	✓
Auto Select Mode	49	✓	✓
Telephone Mode (Manual Receive Mode)	50	✓	✓
FAX Mode	50	✓	✓
Connecting the External Telephone Answering Machine	50	✓	✓
Receiving a Fax message When There Is a Problem (Substitute Reception)	53	✓	✗
Using the Handset	57	✓	✓
Using On Hook Dial	56	✓	✓
Leaving Documents to Be Picked Up by Others (Polling Transmission)	77	✓	✓
Picking Up messages Stored Elsewhere (Polling Reception)	80	✓	✓
Storing An Often Used Document (Auto Document)	58	✓	✗
Forwarding	70	✓	✗
Authorized Reception	66	✓	✓
Wild Cards	75	✓	✓
Copying	84	✓	✓
One Touch Change Over	55	✓	✓
Preventing Transfer to a Wrong Connection	63	✓	✓
Preventing a Wrong Connection	64	✓	✓
Blocking Wrong Connection Reception	65	✓	✓

FACSIMILE FEATURES AVAILABILITY TABLE

FEATURE	Page	Type I	Type II
Rejection of Messages from Unidentified Senders	65	✓	✓
ECM & Page Retransmission	62	✓	✓
RDS	83	✓	✓
AI Short Protocol	84	✓	✗
Storing And Dialing Part Of A Number (Chain Dialing)	34	✓	✓
Counters	106	✓	✓
Doing Two Things at Once (Dual Access)	106	✓	✗
Daylight Saving Time (U.S Only)	21	✓	✓
Date and Time	17	✓	✓
Selecting Tone Dial or Pulse Dial (Telephone Line Type)	21	✓	✓
Tonal Signal	61	✓	✓
Extension System	23	✓	✓
RTI, TTI and CSI	18,19, 20	✓	✓
Paper Save mode	82	✓	✓
Automatic Cutter	22	✓	✓
Cutting the Leading Edge of the Paper	24	✓	✓
On/ Off Switches	101	✓	✓
User Parameter Settings	102	✓	✓
TCR (Transmission Confirmation Report)	85	✓	✓
Transmission Result Report	85	✓	✓
Error Report	85	✓	✓
Communication Result Report	85	✓	✗
Communication Failure Report	85	✓	✗
File Reserve Report	85	✓	✗
Power Failure Report	86	✓	✗
Polling Clear Report	86	✓	✗
File List	89	✓	✗
Quick Dial List	89	✓	✓
Speed Dial List	89	✓	✓
Group Dial List	89	✓	✗
Program List	90	✓	✗
Authorized Reception List	90	✓	✓
Fowarding List	90	✓	✗
User Parameter List	90	✓	✓

INTRODUCTION

MANUAL OVERVIEW

Your facsimile machine is equipped with a wide range of labor-saving and cost-saving features. This manual contains instructions on how to operate and take care of your machine. **Please keep it near the machine at all times.**

Note that the external appearance of the machine in some illustrations may differ slightly from the actual machine.

The manual consists of the following sections.

- How to Use This Manual - This is the section that you are now reading. It contains an overview of the manual and the conventions used by the authors.
- General Precautions - This section lists precautions that you should keep in mind when operating the machine. Read this section before you begin to use your machine.
- Guide to Components - This contains a diagram that shows where the main components and operation panel of your machine are situated.
- Installation-The best place to install your machine is described here. Please also refer to it when you plan to move the machine to another location. It also explains the things you have to do before you can send your fax message and lists important features that will make faxing more convenient.
- Basic Operation - This section describes the features and settings that would normally be used daily.
- Advanced Features - This section explains how to take advantage of the special features of your fax machine.
- Reports - This section explains the reports that the machine generates in the case of error codes or paper jams, refer to this section. (Many routine problems do not need to be solved by an experienced technician).
- Maintaining Your Machine- This section shows you what to do when consumable supplies run out.
- Solving Problems- For example if your machine cannot communicate or there is a paper jam. Refer to this section. (Many routine problems do not need to be solved by an experienced technician.)
- Technical Reference-Inputting characters, specifications, User Switches and other technical information.
- Quick Reference Guide - This indicates how to use this machine at a glance.

NOTE: This manual is for both Type I and Type II Models. Some parts of this manual are divided according to these models. Check which model you are using.

MANUAL CONVENTIONS

Key Names

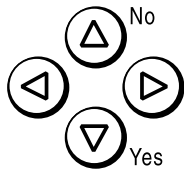

On the operation panel, there are four buttons (▲▼◀▶). They show the directions up, down, left and right. These are the scroll keys. They are often used in the operating procedures to gain access to various features. For example, if you see "Press the ▶ key" in the manual, you are being asked to press the right-pointing arrow of the scroll button. On this machine, the ▲ key also acts as the **No** key, the ▼ key is used as the **Yes** key.

Displays

Messages seen on the display are shown in a larger box, usually on the right hand side of the page, directly opposite the step that brought it up on the display. After following a step in a procedure, check the display to see if it corresponds to the one in the manual. This may help you to check whether you are following the procedure correctly. The following examples show three common types of display.

Example A: The keys that can be pressed are shown in the top right. In this example, you can press the **Yes** or **Start** key.

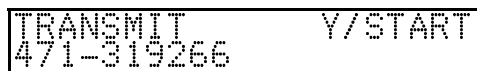

Example B: The choices of settings for a feature are shown on the screen. The current setting is TT . If you press the ▶ key, the setting will be changed to PD.



Example C: The ABC in the right corner of the display indicates that you can input letters using the Quick Dial keys, and numbers using the ten keypad on the operation panel.

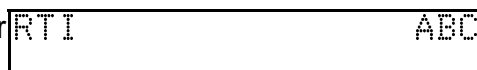

MANUAL CONVENTIONS

Most procedures start from standby mode as shown in the display. The Type I model has two types of standby display and the Type II model has one type of display. The percentage number shows how much memory spacing is remaining. MEM. TX indicates that the machine is in Memory Transmission mode. If you start a procedure and do not enter anything at the operation panel for more than 1 minute, the machine returns to standby mode. You can select different time spans after which the machine automatically returns to standby mode. If you want to change this, contact your service representative.

TYPE I Models

- Immediate Transmission mode

```
READY 100% 10:00AM  
SET DOC. OR DIAL NO.
```

- Memory Transmission mode

```
MEM. TX 100% 10:00AM  
SET DOC. OR DIAL NO.
```

TYPE II Models

```
READY 100% 10:00AM  
SET DOC. OR DIAL NO.
```

Symbols

The text contains two symbols that highlight important points or direct you towards other parts of the manual that are related to the feature currently being described.



Indicates a hint (for example a page number where related information can be found).



Indicates that you can switch the current feature on or off using Function 62 or Function 63. Some features must be switched on before they will work.

GENERAL PRECAUTIONS

WARNING : Do not attempt any maintenance or troubleshooting other than that mentioned in this manual.

GENERAL
PRECAUTION

POWER AND GROUNDING

Pay attention to the following :

Power Supply

1. Power requirements:
North America: 115 V, 60Hz
Saudi Arabia: 115 V, 60Hz or
220-240Vac, 50/60 Hz
Other areas: 220-240Vac, 50/60 Hz
2. Insert the power plug securely into the wall socket.
3. Make sure that the wall outlet is near the machine and readily accessible.
4. Do not connect other equipment to the same socket.
5. Do not step on or set anything on the power cord.
6. Do not connect other equipment to the same extension cord.
7. Be sure that the power cord is not in a position where it would trip someone.

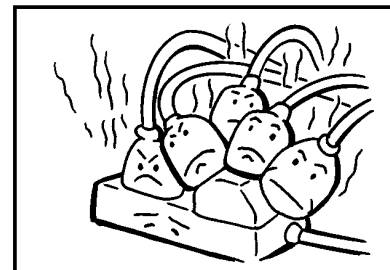
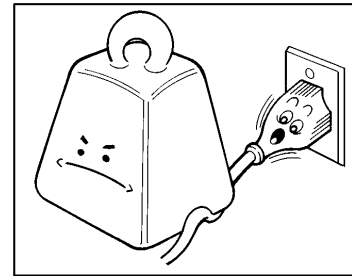
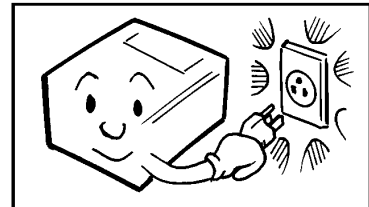

Grounding

Ground the machine and the lightning protection circuit in accordance with regulations. Do not ground to gas or water pipes, or to a telephone ground plug. Proper grounding is to the ground terminal of the power outlet. Be sure that the ground terminal of the power outlet is properly grounded.

The lightning protection circuit for the machine requires the machine to be properly grounded. If proper grounding is provided, about 90% of lightning damage can be prevented. For safety, be sure to connect the machine to a three-prong grounded outlet.

COLD WEATHER POWER-UP

Avoid raising the room temperature abruptly when it is below 14°C [57°F], or condensation may form inside the machine.

1. Raise the room temperature to 20°C [68°F] at less than 10°C [18°F] per hour.
2. Wait for 30 to 60 minutes.
3. Connect the power cord.

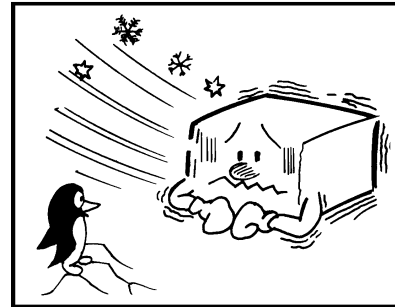

NOTE: Do not use the machine near a humidifier.

THUNDERSTORMS

With proper grounding, about 90% of lightning damage can be prevented. However, if possible, during severe electric storms disconnect the power cord and telephone line cord.

NOTE:

All fax messages stored in the memory are erased if power cord is disconnected.

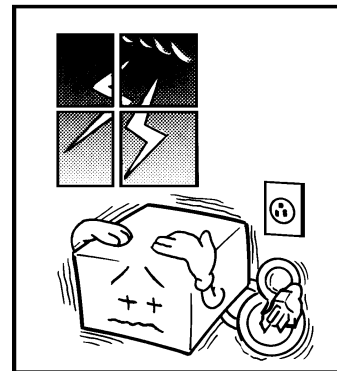

Precautions When Installing and Using the Handset

- Never install telephone wiring during a lightning storm.
- Never install the telephone jack in wet locations
- Never touch uninsulated telephone wires or terminals unless the telephone line has been disconnected at the network interface.
- Use caution when installing or modifying telephone lines.
- Avoid using a telephone (other than a cordless type) during an electrical storm. There may be a remote risk of electric shock from lightning.
- Do not use the telephone to report a gas leak in the vicinity of leak.

PAPER PRECAUTIONS

The following list of precautions tells you how to store and handle your printer paper.

Unused paper

- Store in a dry, cool, dark place.
- Do not store under uneven pressure.

Copies

- Store in a dry, cool, dark place.
- Do not use adhesives or writing materials containing alcohol or other organic solvents.
- Avoid contact with films or adhesive tapes containing plasticizers.
- Avoid contact with diazo photosensitive paper.
- When a copy gets wet, dry it by wiping it gently with a soft cloth or tissue.
- Do not scratch or rub it with hard materials.
- Do not copy with a mercury lamp diazo copier.
- Make a photocopy if the information is to be kept for a long time.
- Do not store copies in vinyl file folders.

OPERATING PRECAUTIONS

- While the machine is in operation, unplug the power cord.
- Keep corrosive liquids, such as acid, off the machine.
- Do not touch copy paper if your fingers are wet and oily; fingerprints may appear on the copy.
- Do not let paper clips, staples or other small metal objects fall into the machine.
- Do not place beverages on or near the machine, they may spill on or into it .

GENERAL

- Since some parts of the machine are supplied with high voltage, make sure that you do not attempt any repairs or attempt to access any part of the machine except those described in this manual.
- Do not modify or replace parts other than those mentioned in this manual.
- After unplugging the power cord, always wait for more than three seconds before plugging it back in.
- Paper Cutter is located in the paper exit area.
Paper Cutter is a sharp moving part and is considered hazardous.

CAUTION (115vac areas Only)



This symbol is intended to alert the user to the presence of important operating and maintenance(servicing). instructions in the literature accompanying the machine.



This symbol is attached to some components to alert the user not to touch them, because they may be hazardous.

GUIDE TO COMPONENTS

1. OPERATION PANEL

Type I Model (USA)

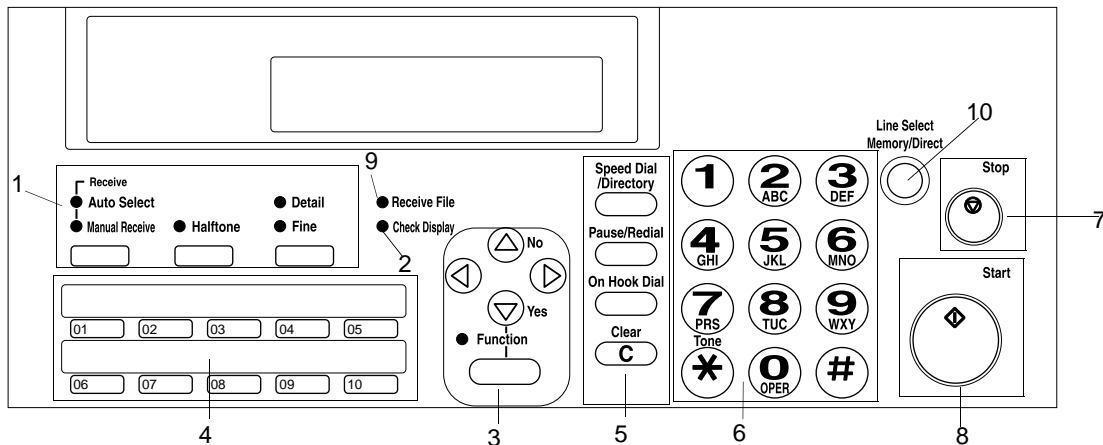

(ASIA)

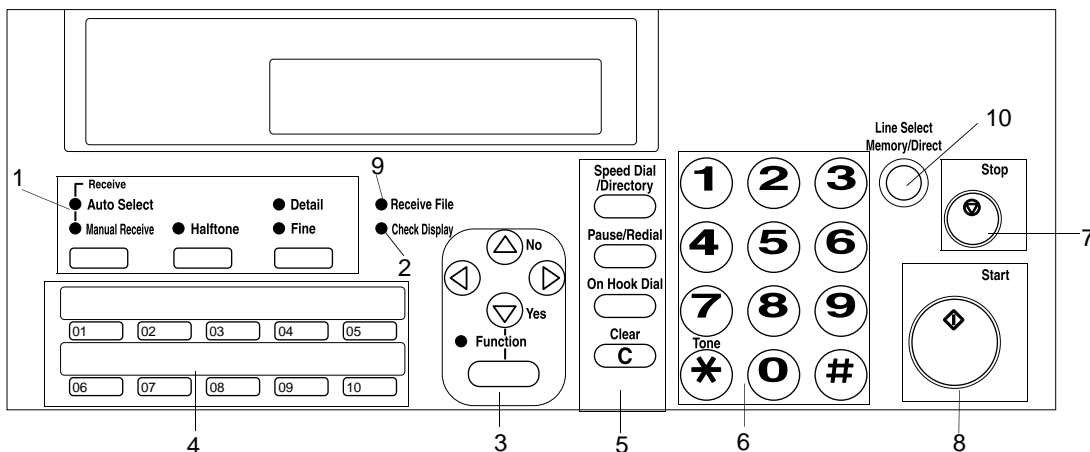

Type II Model

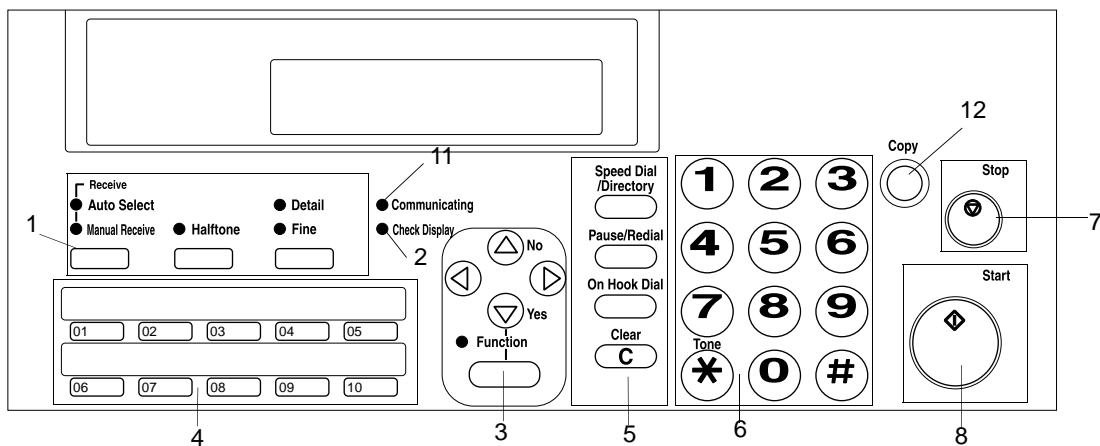

1	Reception Mode Key	Press this to select the reception mode.
	Auto Select Indicator	Lights when you are in Auto Select Mode.
	Manual Receive Indicator	Lights when you are in Telephone mode.
	Detail Indicator	Lights when you are in Detail mode.
	Fine Indicator	Lights when you are in Fine mode.
	Resolution Key	Press this key to select resolution.
	Halftone Key/ Halftone Indicator	Press the key under the indicator to use Halftone Mode, the indicator lights when you are in Halftone Mode.
2	Check Display Indicator	Lights or blinks when there is a problem with the machine; look at the display to determine the nature of the problem.
3	Yes Key (▼)	Use to answer questions on the display.
	No Key (▲)	Use to answer questions on the display.
	Arrow Keys	When the arrow keys(◀ and ▶)are shown on the display, use these keys to access the options, items or functions shown by the arrow. Also use it to move the cursor when programming or editing a displayed item.
	Function Key	Press to use one of the numbered functions.
4	Quick Dial Key	Each of these can be programmed with a telephone number.
5	Speed Dial Key/ Tel Directory Key	Press this to dial using a Speed Dial or the Tel Directory feature.
	Pause/Redial Key	Press this if you need to insert a pause when dialing. Also, press this to redial.
	On Hook Dial Key	Press this to dial without picking up the handset.
	Clear Key	Use this as a backspace key during programming.
6	Ten Keypad	Use this as a telephone keypad, or to enter a Speed Dial code.
7	Stop Key	Press this to stop the machine and return it to standby mode.
8	Start Key	Press this to start fax communications. Press this to copy a document in the feeder(Type I Only).
9	Receive File Indicator (Type I Only)	Lights when incoming messages are received into memory.
10	Line Select Key (Type I Only)	Press this to change to Memory Transmission.
11	Copy Key (Type II Only)	Press this to copy the document now in the feeder.
12	Communicating Indicator (Type II Only)	Lights when a fax message is being transmitted or received.

2. FRONT VIEW

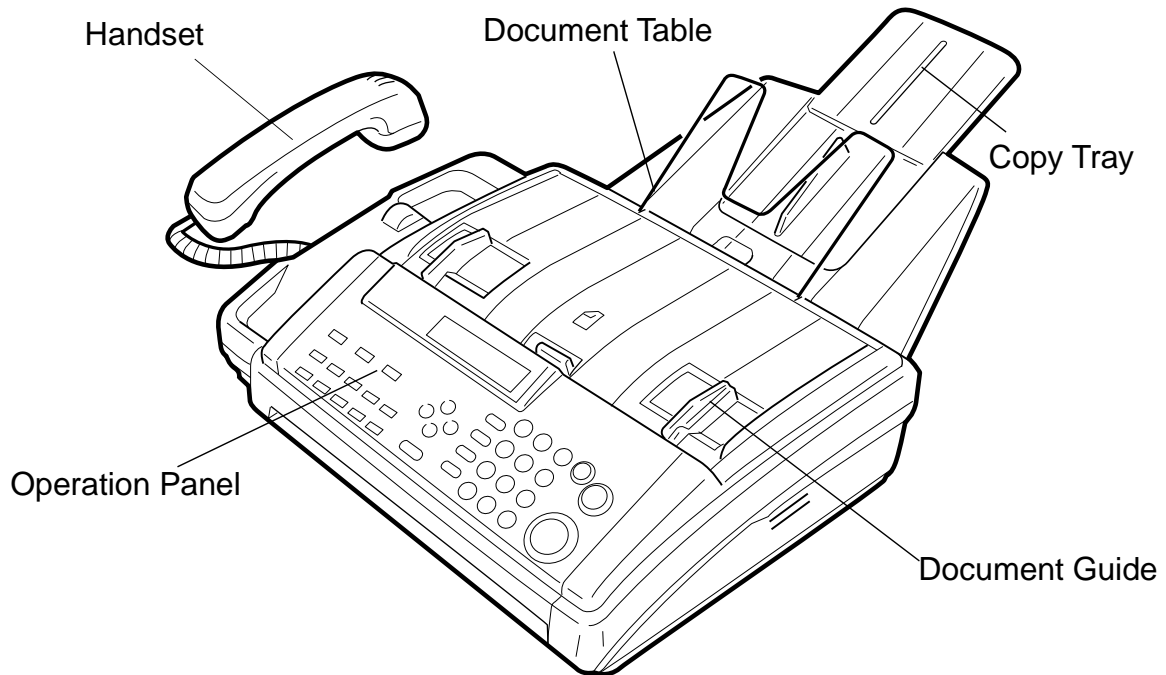

3. REAR VIEW

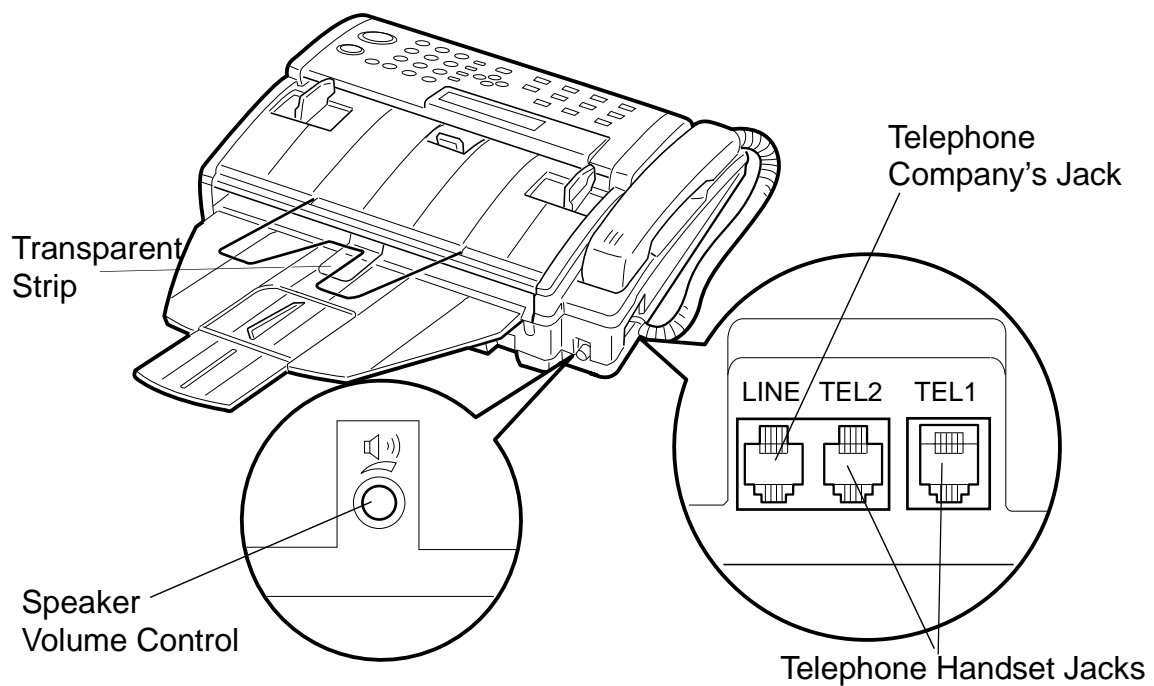

INSTALLING THE MACHINE

LOCATION

For the best possible performance, install your machine in a place which satisfies the following conditions.

- Not exposed to direct sunlight
- Well ventilated (air turnover at least three times per hour).
- Level
- Not subject to vibration
- Away from other electronic equipment, to avoid interference
- Away from areas containing corrosive gas.
- Dust-free
- Condensation-free
- Temperature 17 to 28°C [63 to 82 °F]
- Humidity 40 to 70%RH (do not install near a humidifier)
- Away from heaters and air conditioners, to avoid sudden changes of temperature
- Within 2m (2.2 yards) of a three-pin grounded power outlet
- With the clearance as shown on the right

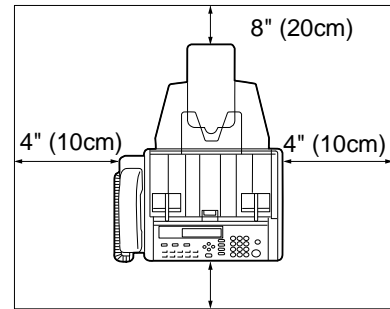

INSTALLING THE MACHINE

NOTE: If you wish to receive legal size messages or copy the legal size documents, you must allow 8" (20cm) clearance at the back of the machine.

INSTALLATION

CAUTION: Do not plug it in until everything is connected properly. When moving the machine, first disconnect the telephone line, then the power cord.

NOTE : Before doing the installation procedure, check the contents of the box . In some models, some of the accessories have already been installed.

- Fax Machine
- Paper Roll
- Document Table
- Copy tray
- Operation Manual
- Handset
- Telephone Cord
- Quick Dial Sheet
- Modular Cord
- Paper Guide
- Paper Holder Rod

INSTALLING THE MACHINE

Installation Procedure

1 Attach the accessories to the main machine.

- 1-1) Copy Tray [A]
- 1-2) Document Table [B]
- 1-3) Quick Dial Sheet [C]
- 1-4) Telephone Cord [D]

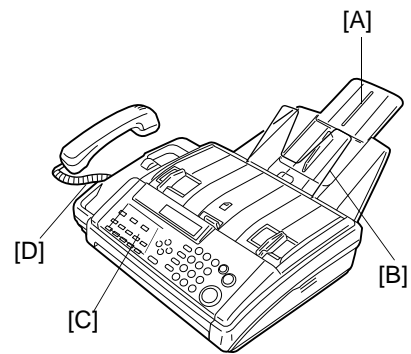

NOTE: Make sure the transparent strip that prevents paper curling is above the copy tray.

2. Install a thermal paper roll.

- 2-1) Lift the catch to unlock the printer cover. Then, hold the paper guides and open the cover.
- 2-2) Unpack the thermal paper.
- 2-3) Set the paper guides [E] at each end to match the paper size. The paper roll must be set in the center.
- 2-4) Install the rod into the paper roll as shown, then set the roll into the machine (hold the roll in a direction so that it rolls away from you when pulled upwards.)

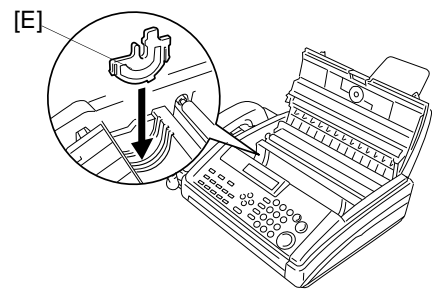
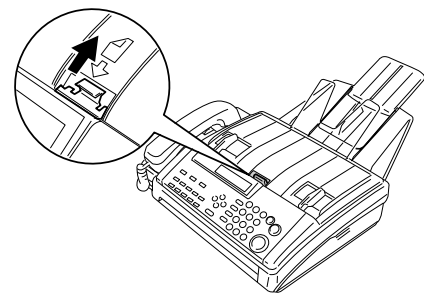

NOTE: Make sure the ends of rod fit into the paper guides there is no slack paper inside the machine.

- 2-5) Pull out the leading edge and insert it between the roller and the cover until you can see the leading edge of the paper.

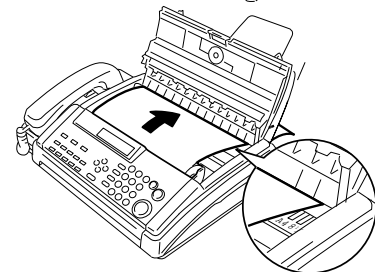
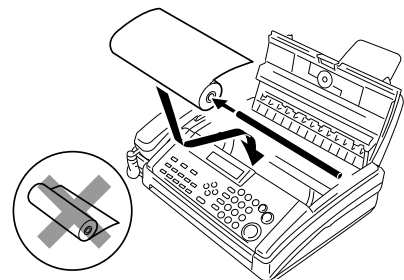

NOTE:

- Make sure the transparent strip that prevents paper curling is above the copy tray.
- Make sure the paper edges are aligned with the marks printed by the roller.

2-6) Close the printer paper cover until it audibly locks into place.

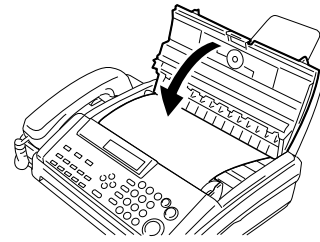

3. Connect up the machine.

3-1) Plug in the power cord.

3-2) Connect the telephone line.

3-3) Connect the telephone handset [F] to the telephone Jack.

3-4) Connect an external telephone if you wish.

3-5) Press the **Start** key to tear off the excess paper.

INSTALLING THE MACHINE

Power Source:
North America: 115 Vac, 60 Hz
Saudi Arabia: 115 Vac, 60Hz or 220-240 Vac 50/60 Hz
Other Areas: 220-240 Vac, 50/60 Hz

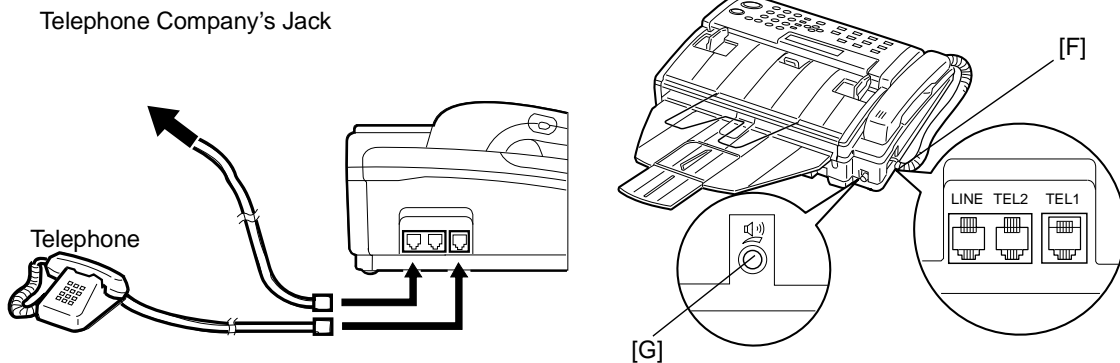

4. Adjust the speaker volume using the dial [G] at the back of the machine.

SOME ITEMS MUST BE PROGRAMMED FIRST

Overview

After you have installed your new machine and connected it to the telephone line for the first time, the machine will ask you to program the following items. If you do not program them, you can not start any operation.

- Date and Time: see page 17.
- Telephone Line Type: see page 21.
- RTI: see page 18.
- TTI: see page 19.
- CSI: see page 20.

You should set up your machine's clock and identification. In fact, for faxes sent to and from, or within the United States, the United States Federal Communications Commission (FCC) states that the fax message must contain header information that identifies the sender (or the sender's organization), and the date and time that the fax was sent.

In addition, you also have to make sure that the fax machine's dialing circuits are set up correctly. There are two settings: Pulse Dial and Tone Dial. If you select the wrong setting, your machine will not be able to dial the fax number. If you are not sure which setting to use, contact your telephone company. To change this setting, see the following section of the manual.

Make sure that attached handset's dialing circuit is set up correctly (there is probably a switch on the side of the handset).

Also, it is better to program the following features before you start to send fax messages.

- Day Light Saving Time (US Only): see page 21.
- Paper Cutting Setting: see page 22.
- Storing Often Used Numbers: see page 25.
- Cutting Leading Edge setting: see page 24.
- Outline Access System: see page 23.

Setting the Date and Time

Your fax machine has an internal clock. It controls the following features:

- The time display on the operation panel while the machine is idle.
- Operation of time-delay features like Send Later.
- The date and time that is printed out at the other end on pages received from your machine. Program the correct date and time when you install the machine.
- In areas where the supply is 220 Vac, the order of steps is a little bit different from the following. You must change the date first, then the month and year.

1. Press the **Function** key and **6,2,2,2,2,8,1** using the ten keypad. Then press the **Yes** key.

```
SUN      KPAD/Y
JAN 01 1994  10:00AM
```

Example: Change to August 24, 1995 at 2: 30PM.

2. Adjust the month.

```
SUN      KPAD/Y
AUG 01 1994  10:00AM
```

- Press the # key to advance a month.
- Press the * key to go back a month.
- Press the ► key to move the cursor and accept the setting.

3. Type in the **date, year** and **time** using the keypad.

```
THU      KPAD/Y
AUG 24 1995  11:30PM
```

NOTE: The day of the week will be set automatically.

Example : Press 2,4,9,5,1,1,3,0,# using the ten keypad



Pressing the # key changes between AM and PM

4. When the display is correct, press the **Yes** key, then press the **Function** key to finish.

Cross- references:
Send Later: see page 45

The times in this manual are shown AM/PM Format. This format is used in models where the supply is 115 Vac. In other areas, the 24-hour clock format is used. 24 hour equivalents are listed below.

00	Midnight (12am)	06	6 am	12	Noon (12 pm)	18	6 pm
01	1 am	07	7 am	13	1 pm	19	7 pm
02	2 am	08	8 am	14	2 pm	20	8 pm
03	3 am	09	9 am	15	3 pm	21	9 pm
04	4 am	10	10 am	16	4 pm	22	10 pm
05	5 am	11	11 am	17	5 pm	23	11 pm

SOME ITEMS MUST BE PROGRAMMED FIRST

Setting Your Machine's Identification

There are three labels with which to identify yourself to the operator at the other end. These labels are called the RTI, the TTI and the CSI.

- RTI (Remote Terminal Identification) and CSI (Called Subscriber Identification): These appear at the other end in the display on the operation panel during communication, and on reports after communication.
- TTI (Transmit Terminal Identification): This is printed at the other end at the top of each page received from your machine.

You can see the RTI, TTI and CSI of the other party during communication (see the following diagram) and on reports printed by the machine later.

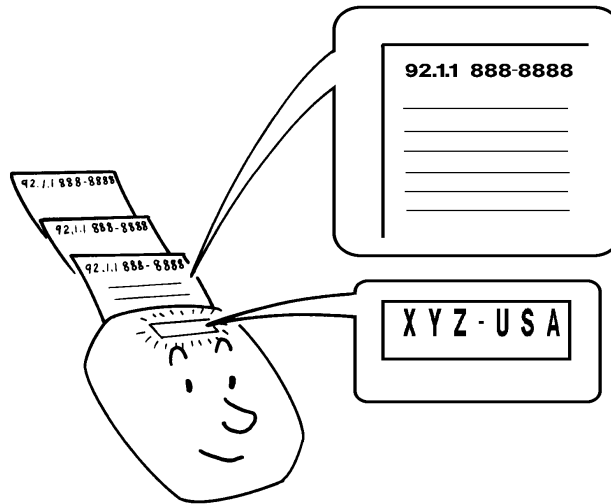

Some machines may reject your transmitted fax messages if you have not stored the RTI or CSI in advance.

NOTE You can switch the TTI off for a particular transmission if you do not wish it to be printed on your pages at the other end. See page 46.

RTI (Identification Display)

Your RTI appears on the other party's operation panel during communication if the other machine was made by the same manufacturer as yours. The RTI can have up to 20 characters (numbers and letters can be used, along with some symbols). Program something easy to recognize, such as your name, company name or department name within the company.

1. Press the **Function** key and then **6,2,2,2,2,6,1** using the ten keypad, then press the **Yes** key.

SET POLLING ID Y/NEXT▶

SOME ITEMS MUST BE PROGRAMMED FIRST

2. Press the **▶** key until the screen is as shown opposite.

```
SET RTI Y/NEXT▶
```

3. Press the **Yes** key.

```
RTI ABC
```

4. Input the RTI that you will be using.
Example: XYZ COMPANY

```
RTI ABC Y /◀▶  
XYZ COMPANY
```

NOTE: This name cannot be more than 20 characters long.



Inputting and editing are explained on page 100.

5. Press the **Yes** key to store your setting.
If you are still in the RTI setting, press the **Yes** key again.

6. Either :

- Select another feature : **Go to step 2.**
- Finish : Press the **Function** key.

TTI (Page Header)

Your TTI is printed at the other end at the top of each page received from your machine. The TTI can have up to 32 characters (numbers and letters can be used, along with some symbols). Program something easy to recognize, such as your name, company name or department name within the company.

1. Either

```
SET TTI Y/NEXT▶
```

- If you have just entered the RTI in the previous procedure, press the **Yes** key.
 - Press the **Function** key and **6,2,2,2,2,6,1** using the ten keypad, then press the **Yes** key. Press the **▶** key until the screen is as shown above, then press the **Yes** key.
2. If you have already entered an RTI, the TTI will be copy of this name.
- If this TTI is correct: Press the **No** key then go to step 5.
 - Otherwise : Press the **Yes** key.

```
TTI CHANGE? Y/N  
XYZ COMPANY
```

SOME ITEMS MUST BE PROGRAMMED FIRST

3. Input the TTI that you will be using or edit the TTI that is already there.

Example: XYZ CO. HEAD OFFICE

NOTE: This cannot be more than 32 characters long.



Inputting and editing are explained on page 100.

4. Press the **Yes** key to store your setting. If you are still in the TTI setting, press the **Yes** key again.
5. Either:
- Enter the CSI next: Go to step 1 in the CSI Programming procedure.
 - Finish : Press the **Function** key.

CSI (Telephone number display)

Your CSI appears on the other party's operation panel during communication instead of your RTI, if the other party's machine is another manufacturer's product. The CSI can have up to 20 characters (only numbers and spaces can be used). Enter your fax machine's telephone number, because some features of your machine may not work if the CSI is not the same as the telephone number.

1. Either:

- If you have just entered the TTI in the previous procedure, press the **Yes** key.
- Press the **Function** key and **6,2,2,2,2,6,1** using the ten keypad, then press **Yes** key. Press the **▶** key until the screen is as shown above, then press the **Yes** key.



2. Press the **Yes** key.



3. Input your telephone number using the ten keypad.

Example: 4712319266

NOTE: This cannot be not more than 20 characters long.

- You may wish to input a "+" sign, a common practice in Europe to signify your international dial access code. Press the Quick Dial Key 09 until the "+" appears at the cursor.



Inputting and editing are explained on page 100.



4. Press the **Yes** key to store your setting.
5. Finish : Press the **Function** key.

Tone Dial or Pulse Dial?

If the setting of this feature is incorrect you will not be able to dial using the machine's keypad or automatic dials.

There are two basic types of telephone company exchange:

- Exchanges using Tone Dialing (also known as DTMF, TT or sometimes PB)
- Exchanges using Pulse Dialing (also known as PD or DP)

The telephone line type setting in your fax machine must match the type of exchange that you are connected to. If you are not sure what type your local exchange is, ask your telephone company.

Change the setting for the fax machine using Function 62.

1. Press the **Function** key and **6,2,2,2,2,6,2** using the ten keypad, then press the **Yes** key.

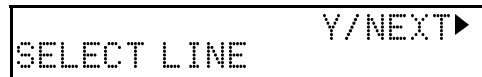

2. Press the **Yes** key. In the opposite display, TT is currently selected.

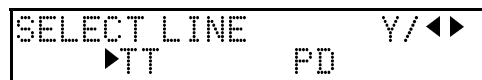

3. Change the setting by using the ◀ and the ▶ keys.



4. Press the **Yes** key to store your setting, then press the **Function** key to finish.

When You Change to Daylight Saving Time

Whenever local custom requires advancing the clock or setting the clock back, use this feature. You can easily move the clock forwards when daylight saving time begins, and back when it ends.

- When you install the machine for the first time, take care that the setting is correct before you set the date and time.

1. Press the **Function** key and **6,2,2,2,2,6,2**, using the ten keypad, then press the **Yes** key.

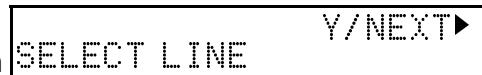

2. Press the ▶ key until the screen is as shown opposite.



SOME ITEMS MUST BE PROGRAMMED FIRST

3. Press the **Yes** key.

```
DAYLIGHT      Y/◀▶
ON            ▶OFF
```

4. Use the ◀ and ▶ keys to switch this feature on or off.

```
DAYLIGHT      Y/◀▶
▶ON           OFF
```

5. Press the **Yes** key to store your setting, then press the **Function** key.

Cutting Paper



This machine has two paper cutting settings.

- Manual Paper Cutting
- Automatic Paper Cutting

You must select whether or not the machine should cut the paper automatically after printing.

NOTE: When you are in manual paper cutting mode, after receiving or copying, make sure that your machine is in standby mode and no document is in the feeder, then press the **Start** key to cut the paper.

Switching the Automatic Cutter On

If you wish to use Automatic Cutting, you must switch the Automatic cutter on. Do the following procedure.

1. Press the **Function** key and the **6,2,2,2,2,6,2** using the ten keypad, then press the **Yes** key.

```
SELECT LINE   Y/NEXT ▶
```

2. Press the ▶ key until the display is as shown opposite.

```
AUTO CUTTER  Y/NEXT▶
ON/OFF
```

3. Press the **Yes** key.

```
AUTO CUTTER  Y/◀▶
▶ON           OFF
```

4. Change the setting by using the ◀ and the ▶ keys.

```
AUTO CUTTER  Y/◀▶
ON            ▶OFF
```

5. Press the **Yes** key to store your setting, then press the **Function** key to finish.

Out Line or Extension Telephone System?

You can select an extension line or out line using the PABX Access System.

Out line: You get an outside line without doing anything.

Inside line: You get an outside line by dialing the access number before the telephone numbers.

1. Press the **Function** key and **6,2,2,2,2,6,3** using the ten keypad, then press the **Yes** key.
2. Press the **Yes** key. Press the ◀ key **once** or press the ▶ key until the settings for Switch 13 are displayed.
3. Change the settings of digit 0.
4. If you wish to change the setting, press **0** using the ten keypad.
5. Press the **Yes** key, then press the **Function** key.

```
SETTING?                                Y/◀
PRINT LIST ◀
```

```
                                KPAD/Y/▶◀
SWITCH 13: 0000 0000
```

```
                                KPAD/Y/▶◀
SWITCH 13: 0000 0000
```

Digit 0
0: Outline
1: Inside line

INSTALLING THE MACHINE

NOTE: With On-hook Dial or when using the handset this feature has no effect.

Setting The Access Number

If you select inside line, you have to program the number which precedes the telephone number.

1. Press the **Function** key and **6,2,2,2,2,6,1** using the ten keypad, then press the **Yes** key.
2. Press the ▶ key until the display is as shown opposite.
3. Press the **Yes** key.
4. Enter the access number.
Example: 0, press 0 using the ten keypad
5. Press the **Yes** key to store your setting, then press the **Function** key to finish.

```
                                Y/NEXT ▶
SET POLLING ID
```

```
                                Y/NEXT ▶
SET PSTN ACCESS NO.
```

```
NUMBER                                KPAD
■ ■
```

```
NUMBER                                KPAD/N
0 ■
```

SOME ITEMS MUST BE PROGRAMMED FIRST

Cutting the Leading Edge of The Paper



In situations where the machine is not copying or receiving messages very often, the edge of the paper roll may curl. If this feature is on, the machine will automatically cut off the curled part before receiving or copying.

The machine will cut the leading edge of the paper if a message is not received or a copy made for more than 24 hours. If you wish to change this period, contact your service representative.

1. Press the **Function** key and **6,2,2,2,2,6,3** using the ten keypad, then press the **Yes** key.

```
SETTING?          Y/◀  
PRINT LIST ◀
```

- At this time, you can print the user parameter list, press the ◀ key then press the Yes key.

2. Press the **Yes** key. Press the ▶ key until the settings for switch 13 are displayed.

```
                KPAD/Y/◀▶  
SWITCH 13: 0000 0000
```

3. Change the setting of digit 7.

```
                KPAD/Y/◀▶  
SWITCH 13: 1000 0000
```

4. If you wish to change the setting, press **7** using the ten keypad.

Digit 7
0: The curled edge is not cut automatically.
1: The curled edge is cut automatically

5. Press the **Yes** key, then press the **Function** key.

STORING OFTEN USED NUMBERS

Three Convenient Ways to Dial

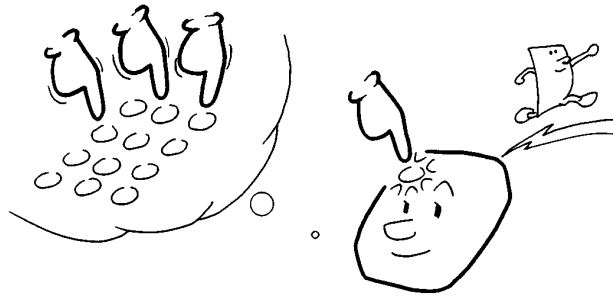

Instead of dialing the full number on the fax machine's keypad, you can use Speed Dial, Quick Dial or Group Dial.

These features allow you to store telephone numbers in your machine's memory. (A stored number will remain in the memory, and you can use it as many times as you wish without having to reprogram it).

Then, when you need to dial a number, just call it up (for example, by pressing the required Quick Dial Key).

Group Dial is available on Type I models only.

Quick Dial and Speed Dial

Quick Dial and Speed Dial are very useful for dialing numbers that you often call, especially if these numbers are very long (like international numbers).

These features make your machine much easier to use. However, first you have to program the telephone numbers that you need into the Quick Dial keys and Speed Dial codes in your machine.

After programming your Quick Dials and Speed Dials, you can dial a telephone number with very few keystrokes.

- For Quick Dial, just press the **appropriate Quick Dial key** then press the **Start** key.
- For Speed Dial, press the **key** on the operation panel labeled "**Speed Dial**", enter a **two-digit Speed Dial code**, then press the **Start** key.

You can store up to 10 Quick Dial keys and 50 Speed Dial codes in a Type I model, 10 Quick Dial keys and 20 Speed Dial codes in a Type II model. When you store a Quick Dial or a Speed Dial, you can also store the name of the other party as a quick reference (this name will be displayed on the operation panel before you press the Start key, so you can check whether you have selected the correct number).

For the Quick Dial keys, you can also attach adhesive labels to the Quick Dial plate.

STORING OFTEN USED NUMBERS

Groups (Type I Only)

If you frequently send the same message at the same time to more than one place, program these telephone numbers into a group. Then you can send the message to all the addresses in that group with just a few keystrokes.

You can also program a name for that group (for example, "Branch Offices"), which will be displayed before you press the Start key. This helps you to check whether you selected the correct group.

You can store up to 3 groups in this machine.

Groups can be used with the following features.

- Sending to More Than One Location (Broadcasting): see page 38.
- Polling Reception : see page 80.

CAUTION:

There are limits on the number of addresses that can be dialed with each of these features. Do not store more numbers in the group than the capacity of the feature that you plan to use it with. These limits are:

Broadcasting :10 addresses

Polling Reception : 10 addresses

Programming Quick Dials

This machine has 10 Quick Dial keys (01 to 10), each of which can be programmed as one of the following : a Quick Dial key, a Group or an Auto Document program. The page number in the following table shows the location of the programming procedure.

1	Quick Dial	A fax or telephone number.	Page 26
2	Group	A set of fax numbers that you often wish to send the same fax to at the same time.	Page 31
3	Auto Document	A page that you often send, such as a map.	Page 28

STORING OFTEN USED NUMBERS

2. Press the **Quick Dial** key that you wish to edit. Example : Quick Dial 01

```

01 CHANGE? Y/◀▶
NEW YORK OFFICE
    
```

- If the wrong number is displayed, use the ◀ and the ▶ keys to scroll through the Quick Dial keys on the screen.

3. Press the **Yes** key.

```

01 KPAD/Y/N
3841037227 ■■■■■■■■■■
    
```

4. Edit the number.

```

01 KPAD/Y/N
3104719266 ■■■■■■■■■■
    
```

- Use the ◀ and ▶ keys to move the cursor and use the Clear key to delete characters at the cursor.

5. Press the **Yes** key.

```

01 Y/N
PROGRAM LABEL?
    
```

6. Either:

```

01 ABC Y/N
NEW YORK OFFICE
    
```

- Change the label: Edit the existing labels then press the **Yes** key.
 Keep the label as it is : Press the **No** key, then go to step 9.

7. Edit the label.

Example: NEW YORK BRANCH

```

01 ABC Y/N
NEW YORK BRANCH ■■■■■■■■■■
    
```

8. Press the **Yes** key. If the display is not as opposite, press the **Yes** key **again**.

```

■ QUICK /◀▶
PRINT LIST◀/SEARCH▶
    
```

9. Either:

- Edit another: **Go to step 2**.
 Print a list of Quick Dial Numbers. Press the ◀ key.
 Finish : Press the **Function** key.

Erasing a Quick Dial

1. Press the **Function** key and **3,1** using the ten keypad, then press the **Yes** key.

```

■ QUICK/◀▶
PRINT LIST◀/SEARCH▶
    
```

- At this time, you can print a Quick Dial List if you press the ◀ key, then press the Start key.

2. Press the **Quick Dial** Key that you wish to erase. Example : Quick Dial 01.

```

01 CHANGE? Y/◀▶
NEW YORK OFFICE
    
```

- If the wrong number is displayed, use the the ◀ and the ▶ keys to scroll through the Quick Dial Keys on the screen.

3. Press the **Yes** key.

```

01 KPAD/Y/◀▶
3841037227 ■■■■■■■■■■
    
```

4. Erase the number: Press the **No** key and then press the **Yes** key



5. Either:

- Program another: **Go to step 2.**
- Print a list of Quick Dial numbers: Press the ◀ key.
- Finish : Press the **Function** key.

Programming Speed Dials

Using this feature, you can store telephone numbers as Speed Dial Codes. Type I has 50 Speed Dial Codes (00 to 49) and Type II has 20 Speed Dial Codes (00 to 19). You can also store a label with each telephone number for use with the Telephone Directory.

INSTALLING THE MACHINE

Telephone Directory

This makes using Speed Dial Codes easier.

When you program a Speed Dial Code, you can program a name and a telephone number. Then, instead of having to refer to the latest Speed Dial Code list when you want to dial that number, you can type in the first letter of the name, and scroll through the list of names that begin with that letter until you find the right one.

Programming a New Speed Dial

1. Press the **Function** key and **3,2** using the ten keypad, then press the **Yes** key.



- At this time you can print Speed Dial List if you press the ◀ key, then press the Start key.

2. Input the **Speed Dial Code** that you wish to program (Type I:00 to 49, Type II: 00 to 19) using the ten keypad. Then press the **Yes** key.



Example : Speed Dial Code 01, Press the speed dial key then 0,1 using the ten keypad.

- If a telephone number is displayed, press the No key and then press the Yes key.

3. Enter the telephone number using the ten keypad.

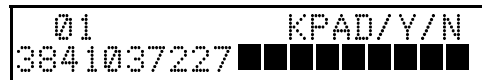

Example : Press 3,8,4,1,7,0,3,2,2,7

If your machine is behind a PBX, include the access code and a pause before the telephone number. For an international number, place a pause after the country code. To input a pause, press the Pause key.

4. Press the **Yes** key.



STORING OFTEN USED NUMBERS

5. To enter a label for this Quick Dial :
 Press the **Yes** key.
 If you do not wish to program a label: Press the **No** key.



6. Enter the label for this Speed Dial
 Example : WASHINGTON OFFICE.



? Inputting and editing : see page 100.

7. Press the **Yes** key. If the display is not as opposite, press the **Yes** key **again**.

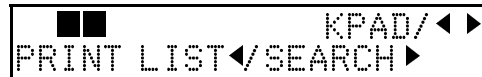

8. Either:
 Program another : **Go to step 2**.
 Print a list of Speed Dial number: Press the ◀ key.
 Finish : Press **Function** key.

Editing a Speed Dial

1. Press the **Function** key and **3,2** using the ten keypad, then press the **Yes** key.
 At this time you can print a Speed Dial List if you press the ◀ key, then press the Start key.

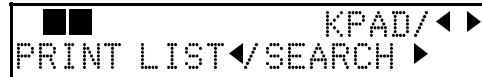

2. Input the **Speed Dial code** that you wish to edit. Example Quick Dial 01
 If the wrong number is displayed, use the ◀ and ▶ keys to scroll through the Speed Dial keys on the screen.



3. Press the **Yes** key.



4. Edit the number.

- Use the ◀ and ▶ keys to move the cursor and use Clear key to delete character at the cursor, the No key to delete whole digit and the ten keypad to enter the digits.



5. Press the **Yes** key.



6. Either:

- Change the label and edit the existing labels: Press the **Yes** key.
 Keep the label as it is : Press the **No** key, then go to step 10.

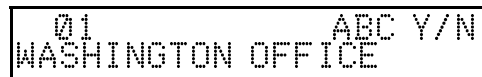

7. Edit the label.



8. When you have entered the new label:
Press the **Yes** key. If the display is not as opposite, press the **Yes** key **again**.

```

■■■■ KPAD/◀▶
PRINT LIST ◀/SEARCH ▶
    
```

9. Either:

- Edit another: **Go to step 2**.
- Print a list of Speed Dial Numbers: Press the ◀ key.
- Finish : Press the **Function** key.

Erasing a Speed Dial

1. Press the **Function** key and **3,2** using the ten keypad, then press the **Yes** key.

```

■■■■ Y/◀▶
PRINT LIST ◀/SEARCH ▶
    
```

- At this time, you can print a Speed Dial List if you press the ◀ key, then press the Start key.

2. Input the **Speed Dial Code** that you wish to erase. Example: Speed Dial 01

```

01 CHANGE? Y/◀▶
ATLANTA BRANCCCH
    
```

- If the wrong number is displayed, use the ◀ and ▶ keys to scroll through the Speed Dial keys on the screen.

3. Press the **Yes** key .

```

01 KPAD/Y/N
225231047■■■■■■■■■■
    
```

4. Erase the number: Press the **No** key and then press the **Yes** key.

```

■■■■ Y/◀▶
PRINT LIST ◀/SEARCH ▶
    
```

5. Either:

- Program another: **Go to step 2**.
- Print a list of Speed Dial Numbers: Press the ◀ key.
- Finish : Press the **Function** key.

Programming Groups (Type I Only)

Groups allow you to combine some numbers into one group, for easy sequential transmission to all the numbers in that group. These numbers can be selected from those already stored in Quick Dial keys or Speed Dial codes, or you can select other numbers by entering them using the ten keypad.

You can also store a label with each group. This label will be displayed when you select the Group.

NOTE: Up to 10 numbers can be stored in a group.

Programming a Group

1. Press the **Function** Key and **3,3** using the ten keypad, then press the **Yes** key.

```

GROUP ■ 1-3/◀▶
PRINT LIST ◀/SEARCH ▶
    
```

- At this time, you can print a Group Dial List, if you press the ◀ key, then press the Start key.

2. Enter the group number using the ten key pad, then press the **Yes** key.

```

GROUP 1 Y/N
PROGRAM QUICK?
    
```

- There are 3 groups, from 1 to 3.

STORING OFTEN USED NUMBERS

3. Press the **Yes** key.

```
GROUP 1          QUICK/N
█
```

4. Press the **Quick Dial** key you wish to program the Group Dial in, then press the **Yes** key.

```
GROUP 1          Y/N
PROGRAM LABEL?
```

5. Either:

```
GROUP 1          ABC
█
```

- If you wish program a label: Press the **Yes** key.
- If you do not wish to program a label: Press the **No** Key, then go to step 8.

6. Enter a label for this Group using the Quick Dial keys. Example: EUROPE BRANCH

```
GROUP 1          ABC Y/◀▶
EUROPE BRANCH█
```



Inputting and editing : see page 100

7. Press the **Yes** key. If the display is not as opposite, press the **Yes** key **again**.

```
GROUP 1          DIAL/N
█
```

8. Enter a number that you wish to store in this group. For example:

- Quick Dial 08 : Press the Quick Dial 08 key.

```
GROUP 1          Y/N
08
```

- Speed Dial 10: Press the Speed Dial key and 1,0 using the ten keypad.
- Full number: Input it using the keypad on the operation panel.

```
GROUP 1          Y/N
10
```

```
GROUP 1          KPAD/Y/N
3104712262█
```

9 Press the **Yes** key.

10. Either:

- Input another number: Go to step 8.
- Print a list of Group Dial Numbers: Press the ◀ key.
- Finish storing numbers in this group: Press the **No** key and the **Function** key.

Editing Group Dial

1. Press the **Function** Key and **3,3** using the ten keypad, then press the **Yes** key.

```
GROUP █          1-3/◀▶
PRINT LIST ◀/SEARCH ▶
```

- At this time, you can print a Group Dial list by pressing the ◀ key then press the **Start** key.

2. Enter the group station number which you wish to edit using the ten key pad, then press the **Yes** key.

```
GROUP 1          Y/N
PROGRAM QUICK?
```

3. Either:

```
GROUP 1          Y/N
 04
```

- Change the Quick Dial key where the group is stored: Press the **Yes** key. Then press the new **Quick Dial** key. Press the **Yes** key to accept.
- Keep the same the Quick Dial key: Press the **No** key.

4. Either:

```
GROUP 1          Y/N
PROGRAM LABEL?
```

- Change the Group label: Press the **Yes** key. Edit the label using the Quick Dial keys, then press the **Yes** key to accept the new label.
- Keep the same label: Press the **No** key.

5. Either:

- Add a new number to the group: Enter it using the ten keypad, then press the **Yes** key.
- Erase a number from this group: Enter it using the ten keypad then press the **Yes** key again to confirm the deletion.
- Finish: Press the **Yes** key.

Erasing Group Dials

1. Press the **Function** Key and **3,3** using the ten keypad, then press the **Yes** key.

```
GROUP ■          1-3/◀▶
PRINT LIST ◀/SEARCH ▶
```

- At this time, you can print a group dial list by pressing the ◀ key then press the **Start** key.

2. Enter the group station number which you wish to edit using the ten key pad, then press the **Yes** key.

```
GROUP 1          Y/N
PROGRAM QUICK?
```

- There are 3 groups, from 01 to 03.

3. Press the **No** key.

```
GROUP 1          QUICK/N
PROGRAM LABEL?
```

4. Press the **No** key.

```
GROUP 1          Y/N
CLEAR?
```

5. Press the **Yes** key.

```
GROUP 1          Y/N
    CLEARED
```

6. Either:

- Erase the another number: go to step 2.
- Finish: press the Function key.

Programming the Group Key

You can program 3 groups. However, there is no room in Quick Dial keys, this group key is helpful. You have to program the 10 of the Quick Dial key as the group dial key.

1. Press the **Function** key and **3,1** using the ten keypad, then press the **Yes** key.

```
■ QUICK / <>
PRINT LIST </> SEARCH >
```

2. Press the **Quick Dial 10**.

```
10 PROGRAM? Y / <>
```

3. Press the **Yes** key.

```
10 PROGRAM? Y / N
PROGRAM GROUP KEY?
```

4. Press the **Yes** key.

NOTE: How to transmit using the Group key, see page 39.

OTHER ITEMS TO PROGRAM AT YOUR LEISURE

Storing and Dialing Part of a Number

This feature is called Chain Dialing. This feature allows you to compose a telephone number from various parts, some of which may be stored as Quick Dial Keys or Speed Dial Codes, and some of which may be input using the keypad. For example, you can program commonly used area or country codes into Speed Dial Codes or Quick Dial keys. The maximum number of digits is 240 including pauses.

This feature is convenient if:

- You often communicate with many terminals for which the area code, or the international code is the same.
- You often make international calls.
For example, if you often call Tokyo, Japan, program 011813 (overseas to Tokyo to the USA) as Quick Dial key 01. This will save work at the operation panel when dialing a Tokyo number.
- Your PBX requires an ID code before the destination number.
For example, if your ID is 1234567, and the destination is stored in Quick Dial key 01, enter 1234567 using the ten keypad, press the Pause key, then press the Quick Dial key 01.

NOTE: Do not store any labels with the Quick Dials and Speed Dials that you are using with Chain Dialing.

Cross-reference
Quick Dial and speed dial: See page 28 and 29.

BASIC OPERATION

SENDING IMMEDIATELY VS. SCANNING QUICKLY

Sending Quickly

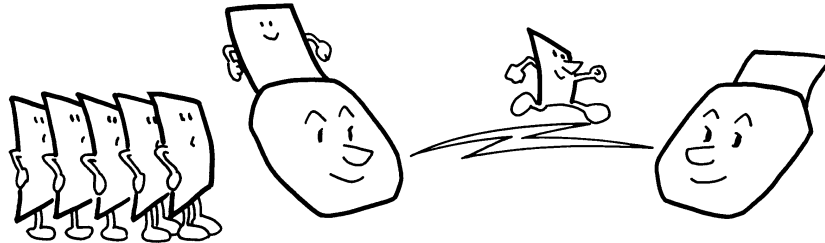

This is known as Immediate Transmission. It is convenient when:

- You wish to send a message immediately.
- You wish to check quickly whether you have successfully connected with the other party.
- Your machine's memory is becoming full.

The machine dials immediately after you press the Start key (or at a specified later time, if you used a time delay feature like Send Later). The message is scanned and transmitted page by page without being stored in memory.

Scanning Quickly (Type I Only)

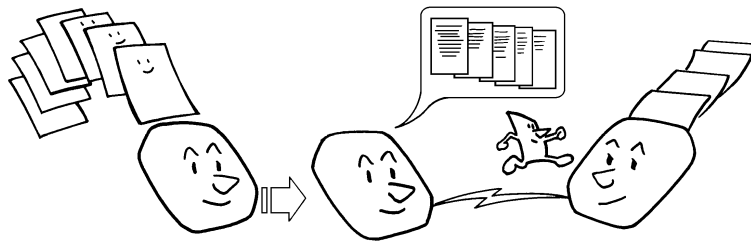

This is called Memory Transmission : It is convenient because:

- Fax messages can be scanned much more quickly (you can take your document away from the fax machine without waiting for the transmission to be completed).
- While your fax message is being sent, another user can operate the machine (people will not have to wait by the fax machine a long time).
- You can send the same message to more than one place in the same operation.

After you press the Start key, the machine doesn't dial until all the pages of your fax message have been stored in the memory. The default mode of this machine is Immediate Transmission, so the procedures described in this manual will be based on the assumption that you are using Immediate Transmission.

Cross-references
Send Later:see page 44

Sending Quickly(Immediate Transmission)

For Type II models, you can skip step 1 and 2 because the machine is always in Immediate Transmission mode. The advantages and disadvantages of Immediate Transmission and Memory Transmission are discussed on pages 35.

1. Make sure that the machine is in standby mode.
2. If the display does not look like above, then press the **Line Select** Key.
3. Follow both steps in any order
 - You can dial in any of these ways:

```
READY 100% 10:00AM
SET DOC. OR DIAL NO.
```

```
TRANSMIT Y/START
3104719266
```

a) Ten Keypad	b) Quick Dial	c) Speed Dial	d) Handset
		<p>Example: Speed Dial 10</p>	

- Carefully place your fax message face down into the document feeder.

```
TRANSMIT OPTION▶
DIAL FAX NUMBER
```



Selecting Resolution: See page 41.
Options for Sending a Message : See page 44.

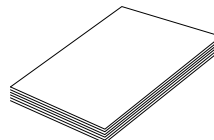
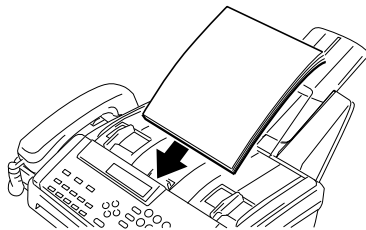

Good

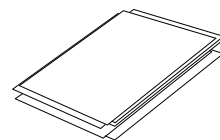

Bad

- The Pages must be placed in the feeder with the first page at the bottom of the stack.
 - Feed the pages in so that the top edge goes in first.
 - Do not feed in more than 10 pages.
 - Do not use unsuitable types of originals (see page 108).
 - Adjust the document guides to fit the width of the pages.
 - Do not use pages of different sizes.
4. Press the **Start** key.
 5. The machine dials and the line to the other party is connected. While it is dialing, the number that you dialed is displayed (or if you used Quick Dial or Speed Dial, the Quick Dial or Speed Dial Label stored for that number is displayed). After transmission the machine will return to standby mode.

Scanning Quickly (Memory Transmission, Type I Only)

1. Make sure that the machine is in standby mode.
 - The display on the operation panel must be as shown on the right.
2. If the display does not look like above, then press the **Line Select** key.
3. Follow both steps in any order.
 - Dial in one of the following ways:

```
MEM. TX 100X 10:00AM
SET DOC. OR DIAL NO
```

```
TRANSMIT Y/STRT
3104719266
```

a) Ten Keypad	b) Quick Dial	c) Speed Dial	d) Handset*
		<p>Example: Speed Dial 10</p>	

*:Only if the telephone handset is installed.

If your machine is behind a PBX, dial the access code, then a pause, then the telephone numbers. For international numbers, press the Pause key after entering the country code.

- Carefully place your fax message face down into the auto document feeder.

```
MEM. TX OPTION▶
DIAL FAX NUMBER
```

? Selecting Contrast and Resolution: See page 41.
Options for Sending a Message : See page 44.

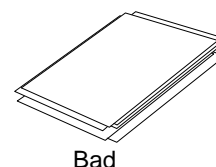
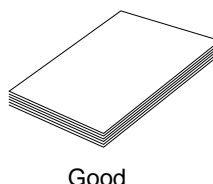
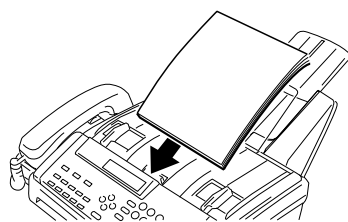

- The Pages must be placed down in the feeder with the first page at the bottom of the stack.
 - Feed the pages in so that the top edge goes in first.
 - Do not feed in more than 10 pages.
 - Do not use unsuitable type of original (see page 108).
 - Adjust the document guides to fit the width of the pages.
 - Do not use pages of different sizes.
4. Press the **Start** key.
 - The machine will scan the document and dial.

```
SAVING TO MEMORY
F-001 F.01 99%
```

File Number

SENDING IMMEDIATELY VS. SCANNING QUICKLY

- The machine dials, and the line to the other party is connected.

NOTE: Watch the display. The identification of the other party will appear. If you have dialed the wrong number, as soon as possible press the **Stop** key before you are connected.

- After sending the message, the machine hangs up automatically.

Sending to More Than One Location (Broadcasting)

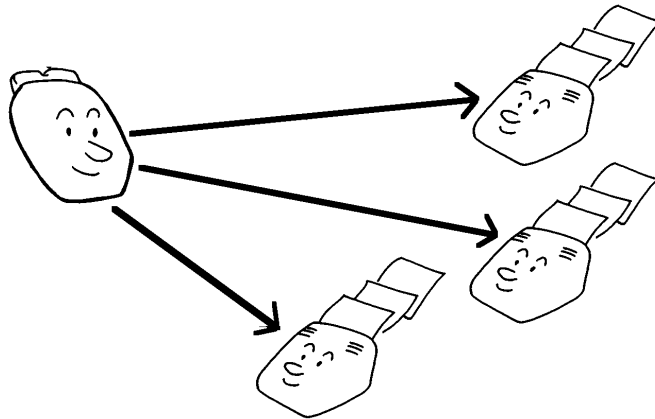

When you are in Memory Transmission, you can send the same message to many destinations (maximum 10 destinations). After dialing the first destination (step 3 in the above operation), dial another destination number. After dialing all destinations, press the **Start** key.

Canceling a Memory Transmission

If you would like to cancel a transmission after scanning or if your machine's memory is becoming full, please follow this procedure. This is also useful when you need space for an important job.

- Press the **Function** key and **2,1** using the ten keypad, then press the **Yes** key.

To print a list of files: Press the **◀** key then press the **Start** key.

- Either:

- If you do not know the file number: Scroll through the file numbers with the **▶** key until the required file appears.
- If you know the file number: Input it directly:
Example: File No.013, press 0,1,3.

```
FILE NO. ■■■■ KPAD/◀▶  
PRINT LIST ◀/SEARCH▶
```

```
FILE NO. 013 Y/◀▶  
CHICAGO OFFICE
```

3. Press the **Yes** key.

```
FILE NO. 013    Y/N
CLEAR?
```

4. Either :

- Erase the file: Press the **Yes** key.
- Keep the file: Press the **No** key.

5. Either:

- Erase another file: Press the **Yes** key and go to step 2.
- Finish: Press the **Function** key.

NOTE: When there are no appropriate files, "NO FILES" is displayed.

Printing The Stored Messages

1. Press the **Function** key and **5,1** using ten keypad, then press the **Yes** key.

```
FILE NO. ■■■ KPAD/◀▶
PRINT LIST◀/SEARCH ▶
```

- To print list of files press ◀ key, then press the Start key.

2. Either:

```
FILE NO. 004 START/N
CHICAGO OFFICE
```

- Scroll through the files on the display: Press the ▶ key until the required file appears. Then press the **Yes** key.
- If you know the file number, input it directly: Enter the file number, then press the **Yes** key.

3. Press the **Start** key.

BASIC OPERATION

Transmission Using The Group Key

1. Either:

- Place a document into the feeder.
- Press the **Quick Dial 10** (Group Key). Then, enter the group number.

```
GROUP          Y/START
01 DISTRIBUTOR
```

2. Press the **Start** key.

If You Make a Mistake

If you make a mistake when inputting a name or number, either :

- Press the **No** key to erase the entire name or number and start again.
- Press the **Clear** key to erase the last letter or digit that you entered.

If you enter the wrong function number,

- Press the **Function** key to return to standby mode and start again.

If you dialed the wrong number, either:

- Press the **No** key.
- If scanning has already begun, press the **Stop** key.
- If you already programmed the number into the machine by pressing the **Yes** key, remove the document from the feeder and start again.

Possible Problems

You want to take out the document:

Open the operation panel and take out the document.

CAUTION: Do not pull out the document without opening the operation panel or you will damage the machine.

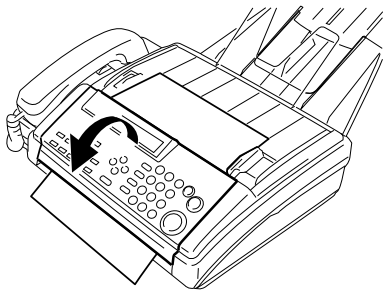

NOTE: If the document will not come out, push forward the two green levers. After you have removed the document, replace the levers and close the panel

You want to send more than 10 pages:

While the last page is being fed in, place more pages (up to 10) in the feeder.

You make a mistake while dialing:

If you have already pressed the Start key, press the **Stop** key immediately.

If you haven't pressed the Start key yet, either:

- Press the **No** key: The entire number is deleted. Enter a new number.
- Press the **Clear** key: Only the last digit is deleted.

You find a mistake after scanning (Memory Transmission):

Use Function 21 to clear the memory file. (see page 38)

The Check Display indicator is blinking:

An error has been detected. Follow the instructions on the display. For more information about error displays see page 97.

Sending a Page With Very Fine Detail

You may wish to send many different types of fax messages. Some of these may be difficult to reproduce at the other end. However, your machine has two settings (Resolution and Halftone) that you can adjust to help you transmit your document with the best possible quality. In this model, contrast is adjusted automatically.

If you are not sure whether your settings are suitable, make a copy of the document using these settings. The printout shows how the fax message will look when it is printed at the other end.

- If your fax message has more than one page, you can select different settings for each page. For example, if you wish to use a different resolution just for page 2, change the resolution setting while page 1 is being scanned. Then, while page 2 is being scanned, you can return the resolution setting to the original setting.
- If you try and send a message in fine mode and the receiver does not have this feature, then the message will be printed in detail mode at the other end.

Resolution

If your document contains fine print or detailed diagrams, use a higher resolution setting.

Standard: Suitable for most typewritten documents. When the Detail and Fine indicators are not lit, this mode is selected.

Detail: Use for documents with small print or fine details. When the Detail indicator is lit, this mode is selected.

Fine: Use this for high quality reproduction. When the Fine indicator is lit, this mode is selected.

Halftone: If your document contains a photograph or diagrams with complex shading pattern or grays, switch Halftone Mode on to achieve optimum image quality. This mode is selected when the Halftone indicator is lit. If it is not lit, press the Halftone key.

Selecting The Halftone Type

This model has two types of Halftone, the Dither Process and the higher quality Error Diffusion Process. To change the currently used Halftone type, perform the following procedure.

1. Press the **Function** key and **6,2,2,2,6,3** using the ten keypad, then press the **Yes** key.

```
SETTING?          Y/◀
PRINT LIST ◀
```

- At this time, you can print a User Parameter List if you press the ▶ key, then press the Start key.

2. Press the **Yes** key, then press the ◀ and the ▶ keys until the settings for Switch 10 are shown.

```
                KPAD/Y/◀▶
SWITCH 10: 0000 0000
```

- The setting on the display is the current setting.

3. To change the setting of digit 7, press **7** using the ten keypad.

```
                KPAD/Y/◀▶
SWITCH 10: 1000 0000
```

Digit 7

0: STD MODE- The machine will use the higher quality Error Diffusion Process.

1: SPD MODE- The machine will use the Basic Halftone Process

4. Finish : Press the **Yes** key then the **Function** key.

Halftone Mode slows down the transmission speed and may increase your communication costs, especially if you use the Error Diffusion process. Higher resolutions also do this. This is because these settings create larger amounts of data to be sent. Messages are transmitted faster if you use the standard resolution setting, and keep Halftone off.

Home Position Setting Adjustments

For resolution and halftone, you can select whether the settings return to the home position at the end of transmission (in a new machine, they do). Also, you can change the settings of the home position. If you need other adjustments, contact a service representative. The procedure is as follows (see page 102 if you need more information about the User Parameter Settings adjustment procedure).

1. Press the **Function** key and **6,2,2,2,2,6,3** using the ten keypad, then press the **Yes** key.

```
SETTING?          Y/◀
PRINT LIST ◀
```

- At this time, you can print a User Parameter List if you press the ◀ key.

2. Press the **Yes** key. The settings for Switch 00 are now displayed on the bottom line of the display. If you wish to change to Switch 01, press the ▶ key until the settings for Switch 01 are displayed.

```
                KPAD/Y/◀▶
SWITCH 00: 0000 0000
```

- The settings that you may need to change are those for Switch 00 and 01. The functions of these are as follows.

SWITCH 00

* indicates the factory settings.

Digit	Purpose						
4	Resolution	Digit 5	Digit 4	Setting	Digit 5	Digit 4	Setting
5		0	0	Standard *	1	0	Fine
		0	1	Detail	1	1	Do not use
6	Transmission mode (Type I Only)				0: Memory Transmission		
					1: Immediate Transmission *		
7	Halftone On/Off home position				0: Off *		1: On

SWITCH 01

Digit	Purpose
7	If you change any of the resolution, transmission mode or halftone settings before making a transmission, then: 0: The setting(s) will not return to the home position after the transmission or making copies. 1: The setting(s) will return to the home position after the transmission or making copies.*

3. If you wish to change one of the settings, press the key on the ten keypad that corresponds to the digit that you wish to change. For example press 7 to change digit 7 of the switch.

```
                KPAD/Y/◀▶
SWITCH 00: 1000 0000
```

4. Finish: Press the **Yes** key, then press the **Function** key.

Dialing with the Telephone Directory

This can be done for any number that you have stored as a Speed Dial code with a label programmed for it.

Example: You wish to Dial "XYZ CO. LONDON"

1. Make sure that the machine is in standby mode.

```
READY 100% 10:00AM
SET DOC. OR DIAL NO.
```

2. Carefully place your fax message into the auto document feeder.

```
TRANSMIT OPTION▶
DIAL FAX NUMBER
```

3. Press the **Speed Dial/Tel Directory** Key.

```
SPEED DIAL 0-4
PUSH NUM OR ABC
```

NOTE: On Type II models, you will see "0-1" in the upper right corner of the display

4. Press the appropriate Quick Dial key for the Speed dial label.

```
TEL DIR. Y/◀▶
01 XA COMPANY
```

Quick Dial	Letter	Quick Dial	Letter	Quick Dial	Letter	Quick Dial	Letter
01	ABC	02	DEF	03	GHI	04	JKL
05	MNO	06	PQR	07	STU	08	VWXYZ

5. If the label you want does not appear, scroll through the labels using the ◀ and ▶ keys until you find it.

```
TEL DIR. Y/◀▶
08 XYZ COMPANY
```

6. Press the **Yes** key to dial the number you want.

7. Either:

- Dial more numbers. (Broadcasting:Type I only)
- Press the **Start** key.

Cross-references
Speed Dial : page 29.

Other Features for Transmission

When you make a routine transmission, you can use a few optional features. Press the ► key to access them.

Sending at a Specific Time

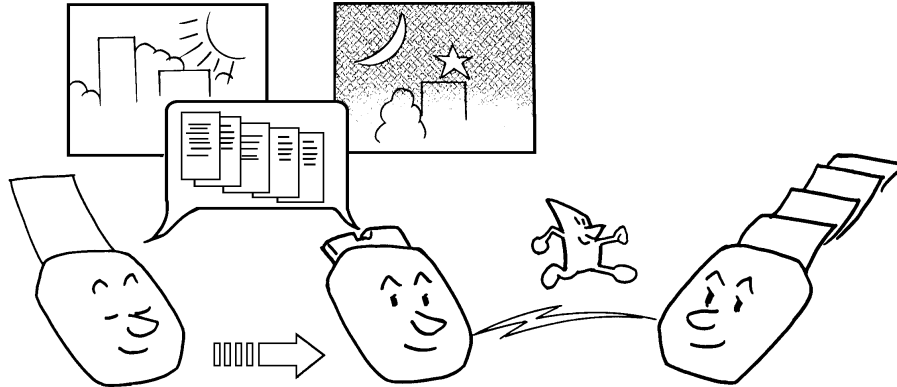

Using this feature, you can instruct the machine to delay transmission of your message until a later time which you specify. This allows you to take advantage of off-peak telephone line charges without having to be by the machine at the time.

CAUTION (Type I Only):

If your machine's memory is full, you will have to keep the message in the document feeder. This means that nobody can use the document feeder unless they remove your document. This would automatically cancel the Send Later Operation.

1. Press the ► key until "SEND LATER?" is displayed.

```
SET OPTION          Y/►
SEND LATER?
```

2. Press the **Yes** key.

```
SET OPTION          KPAD/Y
TIME 00:00AM 10:00AM
```

3. Example: Send at 11:30 PM
Press 1,1,3,0,# using the ten keypad.
 To change AM to PM or the other way around,
Press the # key.

```
SET OPTION          */#/Y
TIME 11:30PM 10:00AM
```

4. Press **Yes** key

```
READY 97%          10:00AM
TRANS STANDBY
```

- The send later time cannot be more than 24 hours in the future.

Printing the Page Number (Immediate Transmission Only)

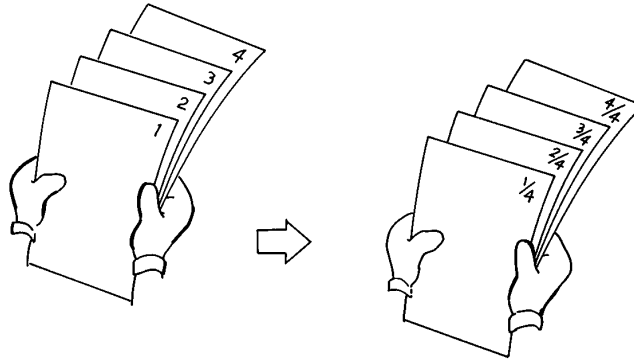

When your fax message is printed at the other end, page numbers will be printed on the top of each page. Using the Page Number feature, you can select the format in which the page numbers are printed.

If you do not use Page Number:

Page numbers will be printed only as a sequence (for example P1,P2,P3). This makes it difficult for the other party to tell at a glance whether any pages are missing (for example, due to a double feed in your machine's document feeder).

If you use Page Number:

Page numbers will be printed in batch-numbering format (for example P1/3, P2/3, and P3/3 for a three-page message). This makes it easy for the other party to see how many pages you sent and if any are missing. However, you have to input the number of pages using the keypad before sending them.

NOTE: On Type I models, when you use Memory Transmission, Page number is automatically switched on and the number of pages is automatically counted.

BASIC OPERATION

- 1. Press the **▶** key until "SET PAGES?" is displayed.

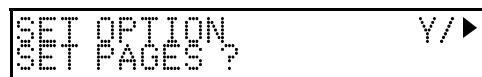

- 2. Press the **Yes** key.



- 3. Enter the total number of pages you wish to send Example : 10 pages. Press 1,0 using the ten keypad.



- 4. Press the **Yes** key.



Sending Your Identification at the Top of Your Message

Normally, the TTI programmed in your machine is printed at the top of each of the pages you transmit when they are received at the other end. The top of the image will be overprinted if there is no margin at the top of the transmitted page.

NOTE: If you switch TTI off, the image received at the other end will be unmarked.

1. Press the **▶** key until "TTI PRINT?" is displayed.

```
SET OPTION          Y/▶  
TTI PRINT?
```

2. Press the **Yes** key.

```
SET OPTION          Y/◀▶  
▶ON OFF
```

3. Press the **◀** and the **▶** keys until the displayed setting is correct.

```
SET OPTION          Y/◀▶  
ON ▶OFF
```

4. Press the **Yes** key.

```
TRANSMIT           OPTION ▶  
DIAL FAX NUMBER
```

Cross-reference
TTI: see page 19

Changing Transmission Mode (Type I Only)



Converting Immediate Transmission to Memory Transmission

If there is a message still waiting in the document feeder, you can convert it into memory file. Press the Line Select key to make sure that the machine is in Memory Transmission mode, then press the Start key. The document will be scanned and stored into memory, leaving the document feeder free for others to use.

Memory Transmission as Your First Choice

The default mode of your machine is Immediate Transmission. If you wish, you can change this home position to Memory Transmission.

The procedure is as follows. If you need more information about the User Parameter settings adjustment procedure, see page 102.

1. Press the **Function** key and **6,2,2,2,2,6,3** using the ten keypad, then press the **Yes** key.

```
SETTING?           Y/◀  
PRINT LIST◀
```

- At this time, you can print a User Parameter List, if you press the **◀** key, then press the Yes key.

2. Press the **Yes** key. The settings for switch 0 are now shown in the display. The setting that you need to change is that for digit 6.
3. If you wish to change the setting, press **6** using the ten keypad.
4. Finish: Press the **Yes** key, then press the **Function** key.

```

                KPAD/Y/◀▶
SWITCH 00: 0000 0000
    
```

```

                KPAD/Y/◀▶
SWITCH 00: 0100 0000
    
```

Digit6
 0: Memory Transmission
 1: Immediate Transmission

REDIALING

If a message was not transmitted successfully, that does not mean that you have to enter the telephone number again. In many cases, the machine will redial the destination automatically.

Automatic Redialing

The machine will automatically redial the other party if any of the following conditions occurred.

- The other party's line was busy.
- There was no reply from the other party.
- The message was rejected by the machine at the other end because of excessive errors (in this case, redialing will only take place if Memory Transmission was used).

Redialing is done 4 times at 5 minute intervals (for Memory Transmission) or 2 times at 5 minute intervals (for Immediate Transmission). The number of redials and the redial intervals may be adjusted by a service technician.

- During redialing, the number being dialed is displayed as shown on the right.
- If redialing fails for an Immediate Transmission, the display shown opposite. You can convert this communication to a Memory Transmission to free up the machine for other users. Press the **Line Select** key then press the **Yes** key.

```

3172270471
SET DOC. OR DIAL NO.
    
```

```

READY 100% 10:00AM
REDIAL STANDBY
    
```

BASIC OPERATION

Using the Redial Key

The machine remembers the last 10 (last one in a Type II Model) number that you have input. If you have to redial the numbers, either:

- Type I Models: Just press the Redial key until the number or name of the party you wish to redial is displayed, then press the Start key.
- Type II Models: Just press the Redial key, then press the Start key.

This feature has the following uses:

- If the machine is waiting to redial the other party, you do not have to wait for the redialing interval to expire. Press the **Redial** key until the required telephone number or name is displayed, then press the **Start** key.
- If you wish to send another message to the same address that you sent one to recently, you don't have to dial the full number again if it is still in the Redial memory. Place the message in the feeder, then press the **Start** key.
- Press the **Redial** key until the required telephone number or name is displayed, then press **Start** key.

NOTE: Using Redial, you cannot retry a failed Memory Transmission. However, you can redial the telephone number, as explained in the previous pages (Type I Only).

- Redial key employs the AI Short Protocol feature.

1. Follow both steps in any order.

- Press the **Pause/Redial** key until the required number appears in the display, then press the **Yes** key **twice**.

REDIAL Y/ <>
08 ATLANTA OFFICE

- Carefully place your fax message into the auto document feeder

TRANSMIT OPTION▶
DIAL FAX NUMBER

2. Either:

- Select another number. (Type I Only: Broadcasting)
- Start the transmission : Press the **Start** key.

RECEIVING FAX MESSAGES

Choosing the Reception Mode & How to Receive

Overview

There are three ways to set up your machine to receive fax messages;

- Auto Select Mode
- Manual Receive Mode
- FAX Mode

Giving Priority to Autoselect Mode

This mode is selected when the **Auto Select** indicator **is** lit. If it is not lit, press the **Reception mode** Key under the indicator until it is lit.

- It will start ringing to allow you to answer the call. If you do not answer within a certain time, the machine will connect the caller to the fax machine.

Setting the Auto Ring Count

When the machine detects an incoming call, it will ring to attract your attention. While the machine is ringing you have a chance to answer the call, after ringing stops, the fax machine takes the line and you are no longer able to answer the call yourself. The Auto Ring Count is the number of ringings that the machine will ring.

1. Press the **Function** key and **6,2,2,2,6,1** using the ten keypad, then press the **Yes** key.

```
SET POLL ID Y/NEXT▶
```

2. Press the **▶** key until the opposite display appears.

```
SET NO. OF RINGS Y/ NEXT▶
```

3. Press the **Yes** key. The factory setting will appear. If you wish to change it, press the **No** key to delete it.

```
NO. OF RINGS Y/N  
08 RINGS
```

4. Enter the number of rings (Auto Ring Time).

```
NO. OF RINGS Y/N  
03 RINGS
```

5. Press the **Yes** key, then the **Function** key.

RECEIVING FAX MESSAGES

Connecting the Telephone Answering Machine (TAM) to Your Fax.

When you are in Auto Select Mode, you can connect a Telephone Answering Machine (TAM).

- This mode is useful if you have a telephone answering machine connected to the "TEL" jack on your machine.
- TAM mode ensures that your answering machine has the chance to respond to incoming telephone calls. If the call happens to be a fax message, the message will be given to the fax machine automatically.
- In the TAM Mode, the Auto Ring count must be set to one ring more than the number of rings that your answering machine waits before it takes the call. To check this number, have a friend call and do not answer the phone. Count the number of rings that you hear before the answering machine takes the call.

Giving Priority to Fax Messages (Fax Mode)

This mode is selected when the **Auto Select** indicator and **Manual Receive** indicators **are not** lit. If one of the reception mode indicators are lit, press the **Reception Mode** key under the indicators until the both lights go out. Your machine will treat each incoming call as if it comes from a fax machine.

- You do not have to be by the machine, as long as you have kept the power on. Use this setting if you have connected the machine to a special line used only for fax messages.

Giving Priority to Phone Calls (Manual Receive Mode)

This mode is selected when the **Manual Receive** indicator **is** lit. If it is not lit, press the **Reception Mode** key. This setting is useful if you wish to use your fax machine's handset to answer telephone calls coming in on the same line as fax messages.

- Your machine will not answer incoming calls automatically.
- You must answer every incoming call yourself and decide whether the incoming call is from a fax machine or from a telephone caller.

Receiving

Auto Select Mode

1. The machine start ringing.
2. You have two options:
 - Pick up the handset. If a person is at the other end, you can continue a normal conversation. However, if it is a fax machine, press the Start key then replace the handset to receive the message.
 - Do nothing. The machine keep ringing. After a number of rings (the auto ring time) the machine will begin to receive a message. You can change the number of rings (the auto ring time) - see page 49.

FAX Mode

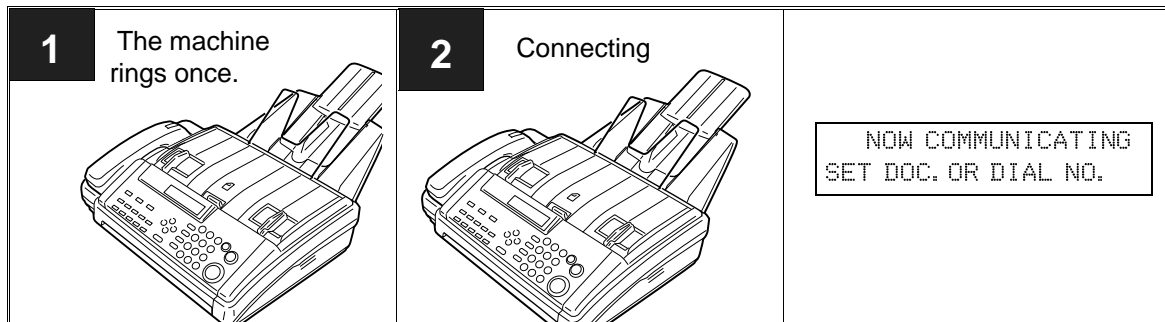

1. The telephone rings once.
2. The machine automatically starts to receive a fax message.

RECEIVING FAX MESSAGES

Tel Mode

1. The machine rings continuously until you answer the call. Pick up the handset.
2. Either:
 - If you hear a voice on the other end, speak in reply.
 - If you hear a tone every few seconds, the other end is a fax terminal (also, if you don't hear anything, the other end may be an older machine that doesn't send identification signals). Press the Start key to receive the fax message.
3. If the person at the other end wishes to send you a fax message, remove any documents, that are in the feeder. Press the **Start** key to receive the message. Then replace the handset. The machine will start to receive the messages.

When You Connect the Telephone Answering Machine

If the caller is another fax machine:

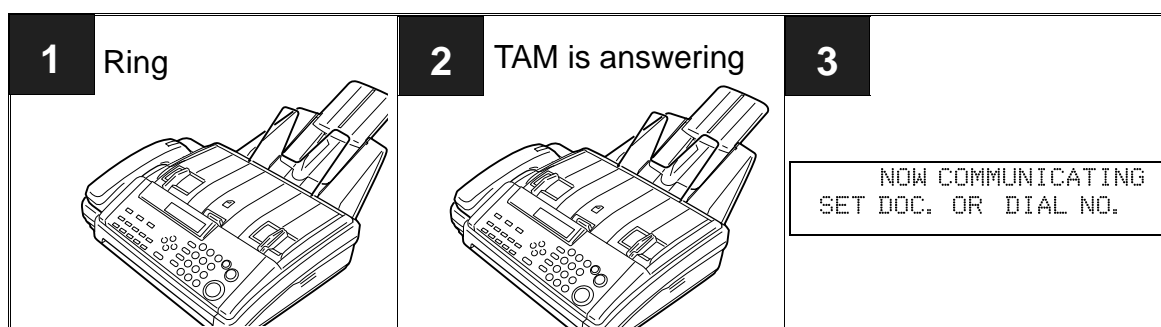

If the caller is a telephone caller:

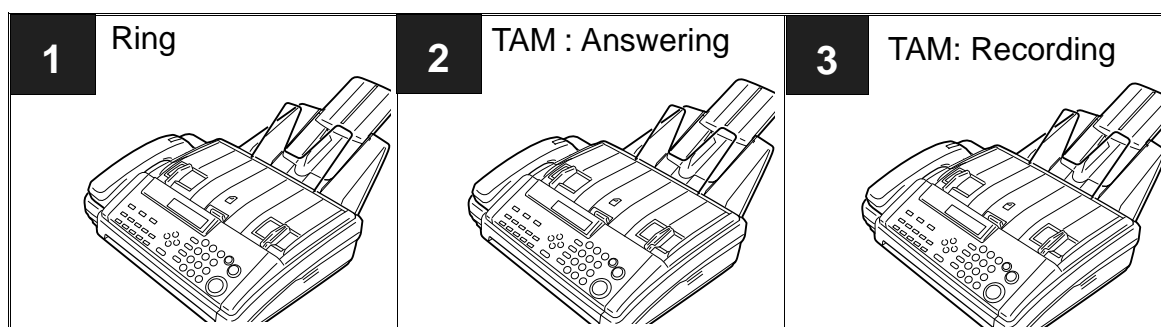

1. The phone rings until the Auto Ring Count is reached.
2. If you do not pick up the phone before the Auto Ring Count is reached, the answering machine takes the call (it starts recording).
3. If the fax machine hears a fax machine identification signal from the other end, it switches to fax mode automatically for this call. It immediately takes the line over from the answering machine and receives the fax message.

Receiving Fax Messages When There Is a Problem (Type I Only)



Over view



If the printer is jammed or out of supplies, you will still be able to receive fax messages; any messages coming in will be stored in the machine's memory. This is called **Substitute Reception**.

If the "Receive File" indicator is lit, a message has been stored in the memory using the Substitute Reception feature.

Check the following:

- The paper roll may be used up. If so, replace the paper : see page 93
- The printer paper may have jammed. If so, remove the jam: see page 95
- The cover is not closed properly. If so, close the cover.

The messages received into memory will be printed and erased once the machine has returned to normal operation after paper cycling.

Switching Substitute Reception On or Off

There are two conditions under which you may wish to disable this feature.

- If you do not like keeping received fax messages in memory: After your machine has received a fax message to memory, it sends an OK signal to the other end. However, if something happens to your machine and you lose the fax message before you have a chance to read it, the sender will not be informed. Therefore, you may not wish to use the Substitute Reception feature.
- If you do not wish to have your memory full of mail from unknown senders: If you have not enabled the Authorized Reception feature, you can receive fax messages from anybody. However, you can see who they are from because their Identification (the TTI) is printed at the top of each page. If the other party has not programmed its identification (perhaps in an attempt to hide their identity), you may not wish to receive their messages into memory because they would take up valuable memory space.

Cross-reference
ECM: see page 62.

Authorized Reception: see page 66.

RECEIVING FAX MESSAGES

If you wish to switch Substitute Reception on or off, do the following. If you need more information about the User Parameter Settings adjustment procedure (see page 102).

1. Press the **Function** key and **6,2,2,2,2,6,3** using the ten keypad, then press the **Yes** key.

```
SETTING?
PRINT LIST ◀ Y/◀
```

2. Press the **Yes** key. Press the **▶** key until the settings for Switch 05 are displayed.

```
                KPAD/Y/◀▶
SWITCH 05: 0000 0000
```

3. Change the settings of digit 0 and 1. The meanings of these setting are as follows:

```
                KPAD/Y/◀▶
SWITCH 05: 0000 0000
```

Digit 1 0

* indicates the factory settings.

Digit	Purpose
0	Substitute Reception 0: Off 1: On *
1	Reception to memory when no RTI or CSI identifiers were received from the other party 0 Enabled 1: Disabled *

4. If you wish to change the setting, press **0** or **1** using the ten keypad.
5. Press the **Yes** key, then press the **Function** key.

CHANGING RECEPTION MODE



This feature is useful because it lets you switch the reception mode quickly for just one call. For example, if you are in Telephone mode and an incoming call turns out to be a fax, you can instantly change over to Fax Mode and receive the message. Similarly, you may change:

- From Fax mode to Tel mode
- From Auto Mode to Fax mode
- From Tel mode to Fax mode

NOTE:

- This feature is only available when you are using Tone dial.
- In Asian, you can not swith over Fax Mode to Telephone Mode.
- In USA, you can switch over Fax Mode to Telephone Mode. After talking you can switch back Telephone mode to Fax mode.

Switching Reception Mode Switch Over On/off

1. Press the **Function** key and **6,2,2,2,2,6,3**, using the ten keypad, then press the **Yes** key.

```
SETTING?          Y/◀  
PRINT LIST ◀
```

- At this time, you can print a User Parameter List if you press the ▶ key, then press the Start key.

2. Press the **Yes** key. Then press the ▶ key until the settings for Switch 07 are displayed.

```
                KPAD/Y/◀▶  
SWITCH 07: 0000 0000
```

- The setting which is in the display is the current setting (normally seen in a machine just delivered from the factory).

3. The setting that you need to change is digit 5. If you wish to change it press **5** using the ten keypad.

```
                KPAD/Y/◀▶  
SWITCH 07: 0010 0000
```

Digit 5
0: Switch Over Off
1: Switch Over On

4. Finish : Press the **Yes** key and the **Function** key.

Using Reception Mode Switchover

1. Make sure that the machine is in One Touch Change Over Mode.
2. After ringing, hang up the handset, then press **2** twice on the separate handset's keypad.
3. The machine automatically changes the reception mode.

MAKING TELEPHONE CALLS

You can use your machine for dialing in the same way as you would use a telephone. This is useful when you would like to use this machine for faxing as well as for telephone conversations.

- You can dial using Quick Dial keys or Speed Dial Codes.
- With the On Hook Dial feature, you do not have to pick up the handset before dialing.
- You can send a fax message after finishing the conversation, without having to make a new call.

Cross-reference
Tel Mode (Manual Receive Mode) : see page 50.

Making a Telephone Call

Using On Hook Dial

Using On Hook Dial is like using the handset (see the next page), except that you do not have to pick it up before dialing. Just press the On Hook Dial key, and dial the number: When you hear the other party on the fax machine's built-in speaker, you can pick up the handset. This keeps both hands free for referring to telephone numbers while you are dialing. You can use this feature to talk before sending a fax, or to just make a telephone call.

1. Press the **On Hook Dial** key.



2. Dial.



See page 100 for how to dial.
Do not use the handset.



NOTE: Do not press the Start key.

If you wish to cancel the call,
press the **On Hook Dial** key
or the **Stop** key.

3. Listen to your machine's built-in speaker.
 - If you hear a voice, pick up the handset and speak to the other party. Later, if you want to send a fax message after the conversation, proceed to step 4, otherwise replace the handset to finish.
 - If you hear a high pitched tone instead of voice, you can send your fax message now. Go to step 4.
4. Place your document in the feeder then ask the other party to press their **Start** key.
5. When you hear a high pitched tone, press the **Start** key and replace the handset.

Using the Handset

Using the fax machine's built-in handset, you can use the fax machine in the same way as a normal telephone. Pick up the handset and dial on the fax machine's ten keypad (or use a Quick Dial key or a Speed Dial Code if you wish).

1. Pick up the handset.
2. Dial.

NOTE: Do not press the Start key.

3. Continue as for a normal telephone conversation.

Using the Redial Key

Use Redial Key if you wish to redial a number that you dialed correctly.

1. Press the **Pause/Redial** key, until the required number appears in the display, then press **Yes** key.
2. Press the **Start** key. The number will be dialed immediately.

REDIAL	Y/◀▶
08 ATLANTA OFFICE	

BASIC OPERATION

Answering the Telephone

If the telephone rings just once: A fax is coming in. Do not pick up the handset.

If the telephone rings continuously:

1. Pick up the handset and speak to the other party. If you hear a high-pitched tone, a fax is coming in. Press the **Start** key then hang up.
2. If the caller wants to send you a fax, press the **Start** key after speaking. Then hang up. If nothing happens after you press the Start key, the power may be switched off or the telephone may not be connected correctly.

To Talk Before Sending a Fax (On Hook Dial)

1. Press the **On Hook Dial** key
2. Dial.

NOTE: Do not use the handset and do not press the Start key.

3. If you hear a voice from the machine's built-in speaker, pick up the handset and speak to the other party.
 - If you hear a high-pitched tone instead of a voice, place your fax message in the feeder, then press the **Start** key.
4. When you are ready to send your fax message, place your message in the feeder, then ask the other party to press the **Start** key.
5. When you hear a high pitched tone, press the **Start** key.

ADVANCED FEATURES

TRANSMISSION

Storing an Often Used Document (Type I Only)

Overview

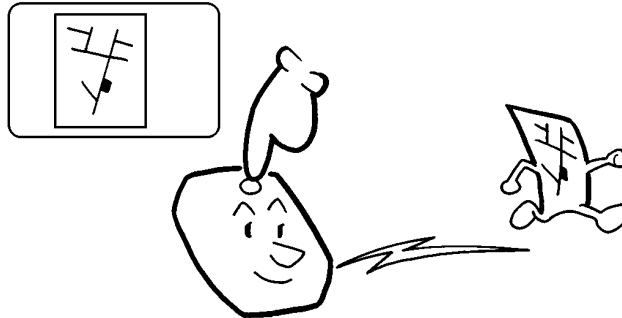

If you often find that you have to often send a particular page to people (for example, a map, a standard attachment or a set of instructions), store that page in memory in an Auto Document assigned to a Quick Dial Key. This feature is called **Auto Document**.

Then, when you need to send that page to somebody, press the Quick Dial key that you stored it in, place any other pages that you wish to send into the feeder, dial, and press Start. At the other end, the Auto Document will be printed first.

You can also program a destination for each Auto Document into the same Quick Dial Key.

Before installing, make sure that the ECM is switched on. (Function 62).

Storing an Auto Document

1. Make sure that the machine is in standby mode.
 - If you select Memory Transmission, "READY " on the display is replaced by " MEM TX"
2. Take the document that you want to be an Auto Document and place it into the feeder.
3. Press the **Function** key and **3,4** using ten keypad, then press the **Yes** Key.
4. Press the **Quick Dial** key that you wish to store the program in.
 - Example: Quick Dial key 04
 - Make sure that this key is vacant.

```
READY 100% 10:00AM
SET DOC. OR DIAL NO.
```

```
TRANSMIT OPTION▶
DIAL FAX NUMBER
```

```
1 QUICK/◀▶
PRINT LIST◀/SEARCH▶
```

```
04 PROGRAM? Y/◀▶
```

Printing the Contents of an Auto Document

1. Press the Function key and **5,3** using the ten keypad. Then press the **Yes** key.

1 QUICK/◀▶
 PRINT LIST ◀/SEARCH ▶

2. Press the **Quick Dial key** that holds the Auto Document that you wish to see.

04 Y/◀▶
 BRANCH MAP

3. Press the **Yes** key.

04 START/N
 BRANCH MAP

4. Press the **Start** key.

PRINT MEMORY FILE

Erasing a Program

When you wish to delete an Auto Document program, do the following.

1. Press the **Function** key and **3,4** using the ten keypad. Then press the **Yes** key.

1 QUICK /◀▶
 PRINT LIST ◀/SEARCH ▶

2. Press the **Quick Dial key** that holds the program that you wish to erase. Example : Press Quick Dial key 04

04 CHANGE? Y/◀▶
 USED AS AUTO DOC.

3. Press the **Yes** key.

04 Y/N
 PROGRAM LABEL?

4. Press the **No** key.

04 Y/N
 AUTO DOC. CLEAR?

5. To delete the program: Press the **Yes** key.

1 QUICK/◀▶
 PRINT LIST ◀/SEARCH ▶
6. Either:
 - Erase another program: **Go to step 2.**
 - Return to standby: Press the **Function** key.

Printing a List of Auto Documents

This procedure shows a list of programs programmed as Auto Documents.

1. Press the **Function** key and **4,4** using the ten keypad, then press the **Yes** key.

START
 PRINT PROGRAM LIST
2. To print : Press the **Start** key.

Tonal Signals

On this model the * key on the ten keypad is used as the Tone Key. Some organizations offer you a special service by telephone, which you can access by transmitting Touch Tone or DTMF tones. If your phone service provides only pulse dialing, or if you are calling over a digital network, the ability to generate Tonal Signals will allow you to access these services. First, dial the other party. When you are through to the other end, press the **Tone** key and enter the code number that is needed to access the required feature on the other terminal. You do not need to press the **Tone** key if your machine is set up for dialing in Tone Dial (DTMF) mode.

Operating the Tone Key

1. Make sure that the machine is in standby mode, and that there is no document in the feeder.
 2. Pick up the telephone handset, or press the **On Hook Dial** key.
 3. Dial the remote facility. Do not press the **Start** key.
 4. After your line is connected to the remote facility, do the following:
 - If your telephone Line type is DTMF (Tone Dial): Go to step 5.
 - If your telephone line type is Pulse Dial: Press the * key on the ten keypad. A dot appears on the display.
 5. Input the digits that you need to use the remote facility. These digits will depend on the remote facility.
- NOTE:** Do not press the Start key.
6. After you have finished your business with the remote facility, hang up.

Cross-reference
Tone Dial (Telephone Line Type): see page 21.

ECM (Error Correction Mode) and Page Retransmission (Type I Only)

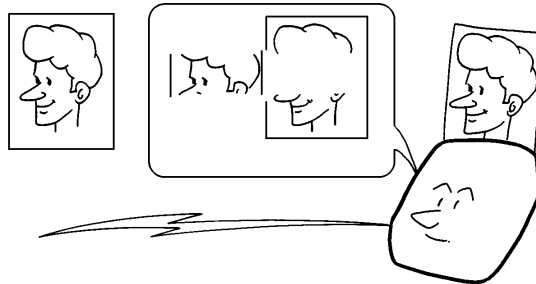

ECM is a signaling system that greatly reduces the chance of data being lost because of a bad telephone line. ECM is useful if you frequently communicate over poor telephone lines. With ECM switched on, the communication cost will increase if the line is bad, but the data will be sent much more reliably. If ECM is switched off, Page Retransmission will be used. The whole page will be resent (unless you used Immediate Transmission, in which case damaged data cannot be resent at all). ECM is more efficient because it only resends the damaged parts of the data, the maximum possible number of retransmission attempts is much higher, and it also works with Immediate Transmission. You can switch ECM on by following the procedure below.

1. Press the **Function** key and **6,2,2,2,2,6,2** using the ten keypad. Then press the **Yes** key.

SELECT LINE Y/NEXT ►

2. Press the ► key until "ECM ON/OFF" is displayed.

ECM ON/OFF Y/NEXT ►

3. Press the **Yes** key.

ECM ON ►OFF Y/◀►

4. Use the ◀ and the ► keys to switch this feature on or off.

ECM ►ON OFF Y/◀►

5. Press the **Yes** key to store your setting, then press the **Function** key.

Protection Against Wrong Connections

Preventing Transfer to a Wrong Connection

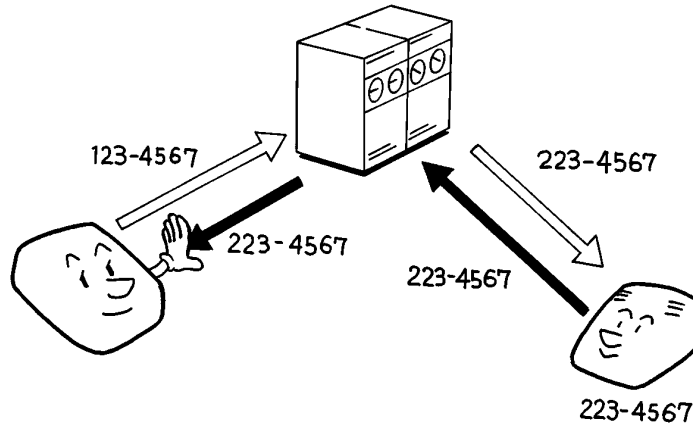

This feature prevents the automatic switching equipment in the telephone network from accidentally connecting you to the wrong terminal.

However, it does not help you if you dialed the wrong number yourself. So, even if this feature is switched on, you should still check your operation panel display to check whether you have reached the correct terminal, and be ready to press the Stop key if the wrong terminal's RTI or CSI is displayed.

Your machine compares the number that you dialed with the CSI received from the other end. If the CSI is not the same as the telephone number, the transmission is stopped.

This feature has to be switched on by a service technician.

NOTE: If you cannot send a message to a certain location while using this feature, contact the other end and make sure that they have stored their CSI correctly. (If the other party is using a machine made by another maker, they may not be familiar with the term CSI. Explain that you are interested in the telephone number that they stored in the machine for identification purposes)

Cross-references

CSI: see page 20.

ADVANCED
FEATURES

Preventing a Wrong Connection (ID Transmission)

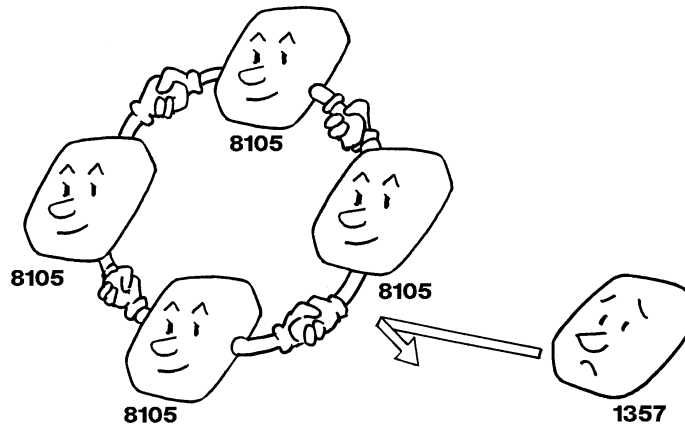

This feature helps to stop you from accidentally sending a fax messages to terminal that is outside your network. The ID codes of the communicating machine are checked. If they are not the same the communication is stopped. The ID code is the same as the polling ID.

1. Press the **Function** key and **6,2,2,2,2,6,3** using the ten keypad, then press the **Yes** key.

```
SETTING? Y/◀
PRINT LIST ◀
```

At this time, you can print a User Parameter List if you press the Start key.

2. Press the **Yes** key. then press the ◀ key until the settings for switch 6 are shown. The setting that you need to change is that for digit 2.

```
                KPAD/Y/◀▶
SWITCH 06: 0000 0000
```

3. If you wish to change the setting, press **2** using the ten keypad.

```
                KPAD/Y/◀▶
SWITCH 06: 0000 0100
```

Digit 2
0: ID Transmission Off
1: ID Transmission On

4. Finish: Press the **Yes** key, then press the **Function** key.

Cross-reference	Polling ID:See page 76
-----------------	------------------------

RECEPTION

Rejecting Messages from Certain Senders

Closed Network Reception

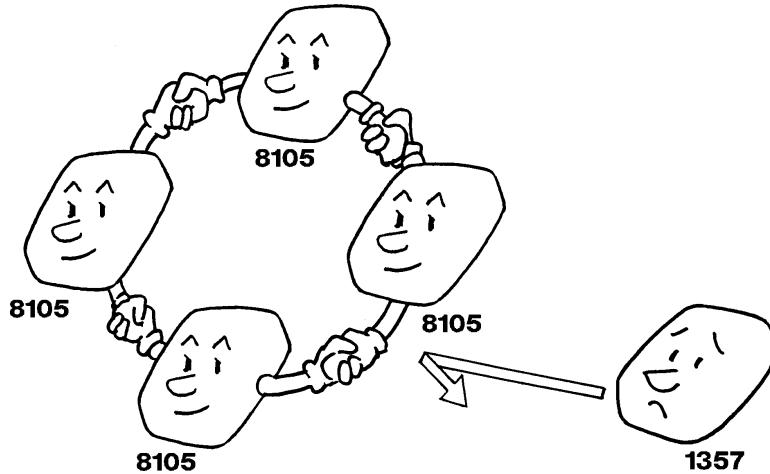

This feature may help you to prevent reception of excessive amounts of junk fax mail.

The ID Codes of the communicating machines are checked. If they are not the same, the communication is stopped.

Contact a service technician if you are interested in this feature.

NOTE: This feature may not be reliable if you are communicating with a terminal produced by a different manufacturer.

Cross-references

ID Transmission: see page 64.

ADVANCED
FEATURES

Rejection of Messages from Unidentified Senders



You can make the machine reject incoming messages that require storing in to your machine's memory, if they are not accompanied with an identifier such as the RTI or CSI. Features that would be affected are Substitute Reception and Forwarding.

The procedure is as follows (see page 102 if you need more information about the User Parameter Settings adjustment procedure).

1. Press the **Function** key and **6,2,2,2,2,6,3** using the ten keypad, then press the **Yes** key.

```
SETTING?          Y/◀  
PRINT LIST ◀
```

RECEPTION

2. Press the **Yes** key then press the **▶** key until Switch 05 is displayed.

```
          KPAD/Y/◀▶  
SWITCH 05: 0000 0000
```

3. If you wish to change the setting, press **1** using the ten keypad.

```
          KPAD/Y/◀▶  
SWITCH 05: 0000 0010
```

4. Finish: Press the **Yes** key, then press the **Function** key.

Digit 1
0: Messages are not rejected.
1: Messages are rejected

Cross-references

Substitute Reception: see page 53.

Forwarding: see page 70.

Authorized Reception



Overview

This feature helps you to reject junk fax mail.

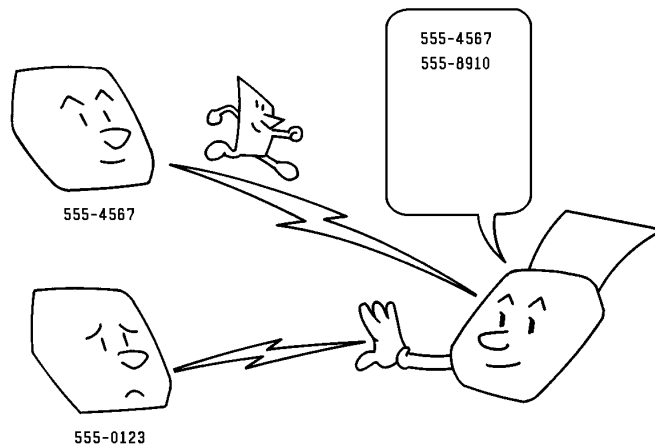

To authorize reception from a particular sender:

- Specify the senders whose messages you want to receive. Do this by programming the RTI or CSI of each sender (ask the sending party what their RTI/CSI is Or make a communication with that terminal, print a TCR and read off the RTI/CSI). If the other party is using a machine made by another maker, they may not be familiar with the terms RTI or CSI. Explain that you are interested in the telephone number that they stored in the machine for identification purposes. (Function 71)
- Switch Authorized Reception on. (Function 62)
- Select whether to accept (Function 63)
 - Only messages from Authorized Senders.
 - All messages except those from Authorized Senders.

If the RTI/CSI is not the same as any of those that you have programmed into this feature, the message will not be accepted.

The number of RTI/CSI's that you can store for use with this feature and the forwarding feature is limited to 30 for Type I Models and 10 Type II Models. However, you can use Wild Cards to extend the number of RTI/CSI's that you can specify.

NOTE: ☐ If you turn Authorized Reception on and you do not program any senders's RTI's / CSI's, your machine will not be able to accept any messages. If one of the authorized terminals changes their RTI/CSI, you have to change the stored RTI also. Otherwise, you will not be able to accept messages from that sender any more.

Cross-references

RTI and CSI: see pages 18 and 20.

TCR: see page 85.

Switching Authorized Reception On/Off

Before you use Authorized Reception, you have to switch it on using Function 62. If it is switched off, the machine will accept any incoming fax message.

1. Press the **Function** key and **6,2,2,2,2,6,2** using the ten keypad. Then press the **Yes** key.

```
SELECT LINE          Y/NEXT ▶
```

2. Press the **▶** key until "AUTHORIZED ON/OFF" is displayed.

```
AUTHORIZED ON/OFF  Y/NEXT ▶
```

3. Press the **Yes** key.

```
AUTHORIZED ON      Y/◀▶
                ▶OFF
```

4. Use the **◀** and the **▶** keys to switch this feature on or off.

```
AUTHORIZED ▶ON     Y/◀▶
                OFF
```

5. Press the **Yes** key to store your setting, then press the **Function** key.

ADVANCED
FEATURES

Selecting Whether to Exclude or Include Senders

1. Press the **Function** key and **6,2,2,2,2,6,3** using the ten key-pad, then press the **Yes** key.

```
SETTING?          Y/◀▶
PRINT LIST ◀
```

2. Press the **Yes** key, then press the **▶** key until the settings for switch 08 are displayed.

```
SWITCH 08: 0000 0000  KPAD/Y/◀▶
```

Forwarding (Type I Only)



Overview

This feature is known as "Follow Me". Using this feature, you can pass fax messages coming in from certain locations on to other fax machines. The terminals that receive your forwarded messages are called "Forwarding Stations". The senders whose incoming messages you want to pass on are called "Specified Senders". If other fax machines in your organization have this feature, you can use forwarding to set up distribution chains for incoming messages.

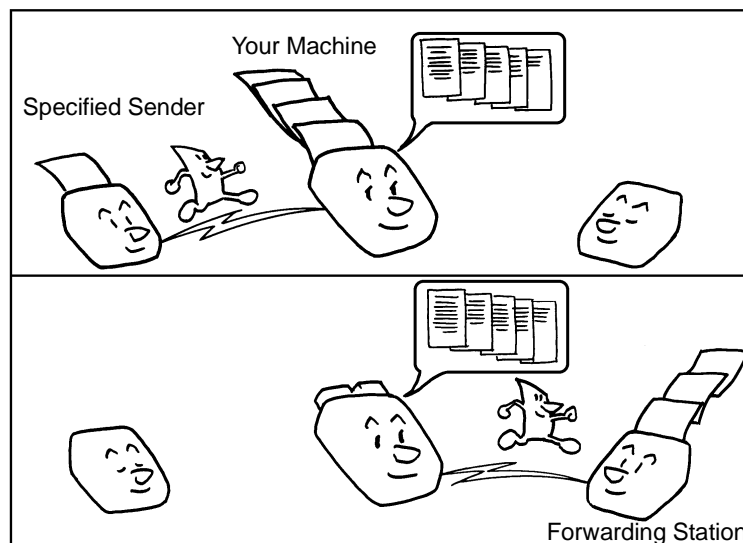

To set up Forwarding, program your machine as follows:

- Program the phone numbers of the Forwarding Stations that you will pass on messages to, together with the list of Specified Senders for each number (Function 72).
- Switch Forwarding on.
- Decide whether you want your machine to automatically print messages that it forwards. (This feature is called Local Printing, Function 63).
- Select how to treat the Specified Senders (Function 63). Either forward:
 - All messages except those from Specified Senders.
 - Only messages from Specified Senders.

In this machine, you can specify up to 5 forwarding stations. The number of RTI/CSI's that you can store for use with this feature and Authorized Reception is limited to 30. However, you can use Wild Cards to expand the number of RTI/CSI's that you can specify. If the RTI/CSI of the machine sending you a fax is not the same as any of those that you have programmed into this feature, the message will not be forwarded.

Cross-references

RTI and CSI: see page 18 and 20

TCR: see page 85.

8. Either:
 - Store this RTI as a Wild Card: Press the **Yes** key.
 - Otherwise: Press the **No** key
9. Either:
 - Input another RTI/CSI: Go to step 5.
 - Input another forwarding station number: Press the **No** key. Go to step 3.
 - Finish: Press the **Function** key.

Switching Forwarding On/Off

Before you use Forwarding, you have to switch it on using Function 62. After you switch Forwarding on, "FORWARD" is displayed when the machine is in standby mode.

1. Press the **Function** key and **6,2,2,2,2,6,2** using the ten keypad. Then press the **Yes** key.

SELECT LINE Y/NEXT ▶
2. Press the ▶ key until "FORWARDING ON/OFF" is displayed.

FORWARDING ON/OFF Y/NEXT ▶
3. Press the **Yes** key.

FORWARDING ON ▶OFF Y/◀▶
4. Use the ◀ and the ▶ keys to switch this feature on or off.

FORWARDING ▶ON OFF Y/◀▶
5. Press the **Yes** key to store your setting, then press the **Function** key.

FORWARD 100% 9:02 AM SET DOC. OR DIAL NO.

ADVANCED FEATURES

Selecting Which Message to Forward

1. Press the **Function** key and **6,2,2,2,2,6,3** using the ten keypad. then press the **Yes** key.

SETTING? PRINT LIST ◀ Y/◀▶
2. Press the **Yes** key, then press the ◀ and the ▶ keys until the settings for Switch 08 are displayed.

SWITCH 08: KPAD/Y/◀▶ 0000: 0000
3. First, change the setting of digit 7. If you to change digit 7, press **7** using the ten keypad .

SWITCH 08: KPAD/Y/◀▶ 1100 0000

Digit 7

0: Only forward messages from Specified Senders.

1: Forward all message except for those from Specified Senders
4. Finish: Press the **Yes** key, then press the **Function** key.

Switching Local Printing On/Off

When you switch Forwarding on, messages your machine forwards are not printed. If you wish, you can also print them from your machine.

1. Press the **Function** key and **6,2,2,2,2,6,3** using the ten keypad, then press the **Yes** key.
2. Press the **Yes** key, then press the **▶** key until the settings for Switch 11 are displayed. Change the setting of digit 6.
3. If you wish to change the setting, press **6** using the ten keypad.
4. Finish: Press the **Yes** key, then press the **Function** key.

```
SETTING?                Y/◀▶
PRINT LIST ◀
```

```
                KPAD/◀▶
SWITCH 11: 0000 0000
```

```
                KPAD/◀▶
SWITCH 11: 0100 0000
```

Digit 6
0: Local Printing Off
1: Local Printing On

NOTE: When turned on and your machine fails to forward a message (for example if the line is busy), you will still have printed copy.

Enabling and Disabling the Forwarding Mark

The forwarding mark is printed at the receiving end on the top of each page of the fax messages that are forwarded from your machine. This mark will help the operator at the other end to recognize messages that have been forwarded. If you wish, you can switch this mark off.

To switch the Forwarding Mark on or off, do the following procedure (See page 100 if you need more information about the User Parameter settings adjustment procedure).

1. Press the **Function** key and **6,2,2,2,2,6,3** using the ten keypad, then press the **Yes** key.
2. Press the **Yes** key, then press the **◀** and the **▶** keys until the settings for Switch 02 are displayed. Change the setting of digit 0.
3. If you wish to change the setting, press **0** using the ten keypad.
4. Finish: Press the **Yes** key, then press the **Function** key.

```
SETTING?                Y/◀▶
PRINT LIST ◀
```

```
                KPAD/◀▶
SWITCH 02: 0000 0000
```

```
                KPAD/◀▶
SWITCH 02: 0000 0001
```

Digit 0
0 Forwarding Mark Off
1 Forwarding Mark On

Wild Cards

This feature greatly enhances the effectiveness of the following features:

- Authorized Reception
- Forwarding

In each of these features, you have to store the RTI or CSI of various terminals that you normally receive fax messages from. Then, when your machine detects an incoming call, it checks the RTI and CSI of the other terminal, and acts accordingly. When you program RTI's for these features, you can program wild cards to greatly expand the number of terminals that you can specify.

Example:

If you store MAN as a wild card, and a terminal with an RTI that includes MANCHESTER, HUMAN or HUMANE calls you, your machine will recognize MAN as a wild card and accept and/or forward the message.

CAUTION:This feature cannot recognize spaces.

Cross-references

Authorized Reception: see page 66.

RTI and CSI: see page 18 and 20.

Forwarding: see page 70.

OTHER

Calling to Request a Message (Polling)

Overview

Polling means "picking up" a document that has been left for you at a remote fax terminal. You can also leave a document in your machine's memory (on Type I models) or in the document feeder (Type II models) for other machines to poll from you.

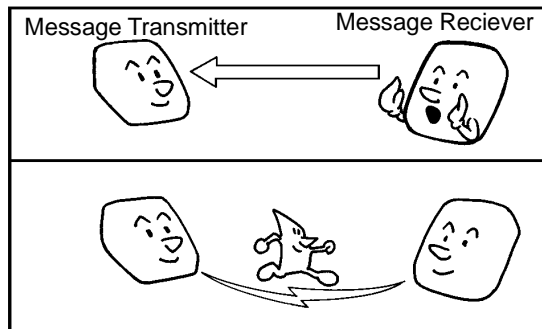

- With polling, telephone line costs are charged to the person receiving the message (the message receiver).
- Polling can only be used when both machines have the Polling feature.

Storing the ID Code

This code can be any four-digit code (using digits 0 to 9 and letters A to F), except 0000 and FFFF. This ID Code is also used ID for Transmission. (see page 64). Before programming the ID Code, agree with other users in your fax network on an ID Code.

1. Press the **Function** key and **6,2,2,2,2,6,1** using ten keypad, then press the **Yes** key.
2. If the above display has not appeared, press the **▶** key until the screen is as shown opposite.

```
SET POLLING ID      Y/NEXT▶
```

3. Press the **Yes** key.

```
POLLING ID          KPAD  
■■■■
```

4. Input the Polling ID that you will be using.
Example: 0917 , press 0,9,1,7 using the ten keypad.

```
POLLING ID          KPAD  
0917
```

5. Press the **Yes** key .
6. Finish: Press the **Function** key

Leaving Documents to Be Picked up by Others (Polling Transmission)

Use this feature when you wish to leave a document in the document feeder for callers to pick up. On Type I models only, you can store the documents in memory until someone picks them up. You cannot specify the telephone number of the message receiver (the polling terminal), but by using the ID Code there are ways to make sure that the message does not go to the wrong place, as explained below. There are three types of Polling Transmission:

Free Polling: Anybody can poll the message from the polled machine's memory.

Secured Polling: The message will only be sent out if the ID Code of the polling machine is the same as the ID Code stored in the polled machine.

Stored ID Override: There are two ways to use this feature:

- If your ID Code is different from that of the other terminal, you can use the other terminal's ID Code just for this transmission (ask the other terminal's operator what their ID Code is). Your machine's stored ID Code will be ignored.
- For extra security, both parties can specify an ID Code just for this communication. The ID Codes of both machines will be ignored. All communicating parties need to coordinate their ID Codes in this case.

Free Polling

1. Follow both steps in any order:

- Place your document in the feeder.



See page 79 for options that are available with Polling Transmission.

```
TRANSMIT OPTION▶
DIAL FAX NUMBER
```

- Press the **Function** key and **1,3** using the ten keypad, then press the **Yes** key.

```
FREE POLLING OPTION▶
SET DOCUMENT
```

2. Press the **Start** key.

- Your fax message is held on polling standby.

Secured Polling

1. Follow both steps in any order:

- Place your document in the feeder.



See page 79 for options that are available with Polling Transmission.

```
TRANSMIT OPTION▶
DIAL FAX NUMBER
```

- Press the **Function** key and **1,2** using the ten keypad, then press the **Yes** key.

```
POLLING TRANS OPT▶
SET DOCUMENT
```

OTHER

2. Press the **Start** key.

- Your fax message is held on polling standby.

NOTE: If you have not yet stored an ID Code using Function 61, you will be asked to enter an ID Code. Proceed in the same way as for step 4 in "Stored ID Override" below.

Stored ID Override

This procedure will override the ID Code stored in your machine. The override is only effective for this one transmission.

1. Follow both steps in any order:

- Place your document in the feeder.

 See page 79 for options that are available with Polling Transmission.

- Press the **Function** key and **1,2** using the ten keypad, then press the **Yes** key.

```
TRANSMIT          OPTION▶  
DIAL FAX NUMBER
```

```
POLLING TRANS     OPT▶  
SET DOCUMENT
```

2. Press the **▶** key until "SET POLLING ID?" is displayed, then press the **Yes** key.

```
SET OPTION        KPAD  
ID: ■■■■
```

3. Enter the **ID code** that you wish to use for this message. Example: 0824. Press 0,8,2,4 using the ten keypad.

```
SET OPTION        Y/N  
ID: 0824
```

4. Press the **Yes** key.

```
POLLING TRANS     OPT▶  
PUSH START
```

5. Press the **Start** key.

- Your fax message is held on polling standby.

Printing the Contents of Stored Polling Messages (Type I Only)

1. Press the **Function** key and **5,2** using ten keypad, then press the **Yes** key.

- To print list of files press the **◀** key, then press the **Start** key.

```
FILE NO. ■■■ KPAD/◀▶  
PRINT LIST◀/SEARCH▶
```

2. Either:

- Scroll through the files on the display: Press the **▶** key until the required file appears. Then press the **Yes** key.
- If you know the file number, input it directly: Enter the file number, then press the **Yes** key.

```
FILE NO. 004 START/N  
CHICAGO OFFICE
```

3. Press the **Start** key.

Canceling Polling Transmission Files

Type I Models

1. Press the **Function** key and **2,3** using the ten keypad, then press the **Yes** key.
 - To print a list of files, press the ◀ key and the Start key.
2. Either:
 - If you do not know the file number : Scroll though the file numbers with the ▶ key until the required file appears. Then press the **Yes** key.
 - If you know the file number: Input it directly. Example: File Number 013, press 0,1,3 using the ten keypad, then press the **Yes** key.
3. Either
 - Erase the file : Press the **Yes** key.
 - Keep the file : Press the **No** key.
4. Either:
 - Erase another file: Press the **Yes** key and go to step 2.
 - Finish: Press the **Function** key.

```
FILE NO. ■■■■ KPAD/◀▶
PRINT LIST ◀/SEARCH ▶
```

```
FILE NO. 013 Y/N
CLEAR?
```

Type II Models

When you want to use the machine when the document has been set in the document feeder: Take out the document from the document feeder. The transmission is automatically canceled.

Options for Polling Transmission

When you set a document in the document feeder or store the document in the memory for Polling Transmission, you also have the following options.

- TTI On/ Off
- Page Count

1. Press the ▶ key until the required option is displayed. Example: TTI option.

```
SET OPTION Y/▶
SET TTI PRINT?
```

2. Press the **Yes** key.

```
SET OPTION Y/◀▶
ON ▶OFF
```

OTHER

3. If you wish to switch something on or off, press the **Yes** key, then use the ◀ and the ▶ keys until the displayed setting is correct.
4. Finish : Press the **Yes** key.

```
SET OPTION      Y/◀▶
▶ON             OFF
```

Picking up Messages Stored Elsewhere (Polling Reception)

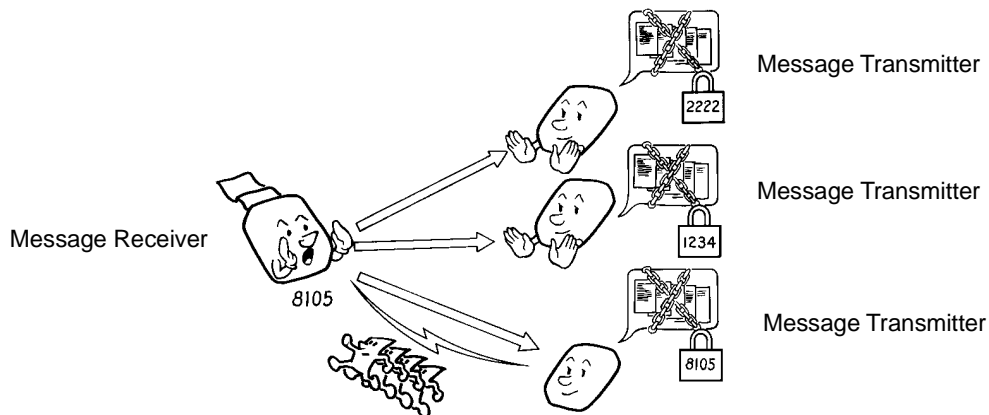

Use this feature when you wish to poll a message from another terminal. You can poll documents from many terminals with only one operation (use Groups to make the most out of this feature).

You have three options: Free Polling, Secured Polling and Stored ID Override, as described for Polling Transmission (see page 77).

The maximum number of terminals that you can poll in one operation is 10 for Type I Models and 1 for Type II Models .

Cross-references

Groups: see page 31.

Procedure

1. Press the **Function** key and **1,1** using the ten keypad, then press the **Yes** key.

```
POLLING RECV  OPTION▶
DIAL FAX NUMBER
```

2. Dial the number(s) and press the **Yes** key.
3. Press the **Start** key.

```
POLLING RECV  Y/START
3104719266
```



For how to use other options, such as Send Later for delayed polling, see page 82.

Stored ID Override Option

This procedure overrides the ID Code that is stored in your machine. The override is effective for this operation only.

1. Press the **Function** key and **1,1** using the ten keypad, then press the **Yes** key.

```
POLLING RECV  OPTION▶
DIAL FAX NUMBER
```

2. Press the **►** key until "SET POLLING ID" is displayed.

```
SET OPTION      Y/N
SET POLLING ID?
```

3. Press the **Yes** key.

```
SET OPTION      KPAD
ID: ■■■■
```

4. Enter the **ID Code** that you wish to use for this message.
Example: 0917. Press 0,9,1,7 using the ten keypad, then press the **Yes** key

5. Press the **Yes** key.

```
POLLING RECV  OPTION ►
DIAL FAX NUMBER
```

6. Dial and press the **Start** key.

? For how to use other polling options, such as Send Later for delayed polling, see page 81.

Canceling Polling Reception

1. Press the **Function** key and **2,2** using the ten keypad. Then press the **Yes** key.

```
FILE NO. ■■■■ KPAD/◀▶
PRINT LIST ◀/SEARCH ▶
```

2. Either:

- If you do not know the file number: Scroll through the file numbers with the **◀** and **▶** keys until the required file appears.
- If you know the file number: Input it directly.

```
FILE NO. 011 KPAD/◀▶
HEAD OFFICE
```

3. Press the **Yes** key twice.
4. Finish: Press the **Function** key.

Options for Polling Reception

When you are in the Polling Reception mode, only the send later option is available.

1. Press the **▶** key until "SEND LATER?" is displayed. 

2. Press the **Yes** key. 

3. Example: Send at 11:30 PM
Press 1,1,3,0,# using the ten keypad.
 To change AM to PM or the other way around, Press # key. Also the send later time cannot be more than 24 hours in the feature. 

Saving Paper

This will help you to reduce paper costs. When the machine prints a received message and copies some documents, it reduces the horizontal ratio to half length.

1. Press the **Function** key and **6,2,2,2,6,2** using the ten keypad. Then press the **Yes** key. 

2. Press the **▶** key until "SAVE PAPER ON/OFF" is displayed. 

3. Press the **Yes** key. 

4. Use the **◀** and the **▶** keys to switch this feature on or off. 

5. Press the **Yes** key to store your setting, then press the **Function** key.

RDS (Remote Diagnostic System)



Overview

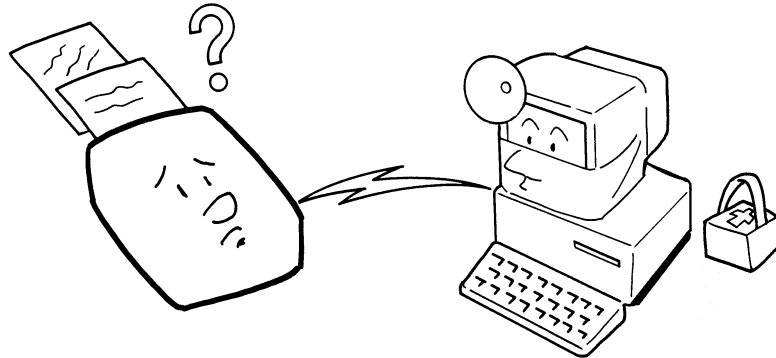

If your machine has a problem, a service technician can perform various diagnostic tasks over the telephone line from the service station to try to find out what is wrong with your machine. The service technician can also use RDS to change some of your machine's settings if you request it.

For RDS operations, it may be necessary to stay near the machine.

RDS is automatically switched off 24 hours after it has been switched on.

Switching RDS On/ Off

Use this function when the service technician has changed the factory setting. If you wish to switch RDS back on, you must switch it on yourself using the following procedure.

1. Press the **Function** key and **6,2,2,2,6,2** using the ten keypad. Then press the **Yes** key.
2. Press the **◀** key until "RDS ON/OFF" is displayed.
3. Press the **Yes** key.
4. Use the **◀** and the **▶** keys to switch this feature on or off.
5. Press the **Yes** key to store your setting, then press the **Function** key.

```
SELECT LINE      Y/NEXT ▶
```

```
RDS ON/OFF      Y/NEXT ▶
```

```
RDS
ON      ▶OFF      Y/◀▶
```

```
RDS
▶ON      OFF      Y/◀▶
```

AI Short Protocol (Type I Only)

This feature employs Artificial Intelligence (AI) to learn the communication characteristics of the machines programmed as Speed Dial or Quick Dials. AI Short Protocol helps you to reduce communication costs between machines produced by the same manufacturer. AI short Protocol works if you dial using the Quick Dial, Speed Dial or Redial Keys. The machine at the other end must have the AI Short Protocol Feature.

When you send a fax message, the two machines carry out a handshaking procedure, during which they establish the best way to communicate with each other. Using AI short Protocol, this handshaking procedure only takes place in full the first time you dial a particular number. Your machine remembers the optimum communication parameters for calling that number. The next time you dial that number, the machine will remember these parameters and the preliminary handshaking will be significantly reduced, saving communication costs.

Copying

If you need to make a copy of something, and there is no copier available, use your fax machine.

Copying an original is a good way to test contrast and resolution before sending a document, if you are not sure that the settings that you have chosen are appropriate. The copy made by your printer shows you how the message would look when received at the other end. If it does not look good, change the settings and try again.

1. Carefully place your original into the document feeder.

TRANSMIT OPTION ►
DIAL FAX NUMBER

2. Type I: Press the **Start** key.
Type II: Press the **Copy** key.

COPY MODE 1 SETS

3. If you wish, change the number of copies using the ten keypad.

COPY MODE 2 SETS

4. Press the **Start** key.

COPYING
P01. 01/01 SET

REPORTS

AUTOMATICALLY PRINTED REPORTS

Unless otherwise indicated, the automatic printing of these reports can be turned on or off by changing the user parameter settings.

TCR (Transmission Confirmation Report)

This report gives details on each communication made by your terminal. It is automatically output every 35 communications on Type I Models and every 10 communications on Type II Models.

Transmission Result Report

This report is printed out after every Immediate Transmission. It shows whether the transmission was successful or not. If you have switched this report off, a Communication Failure Report will be printed when a communication fails.

Communication Result Report (Type I Only)

This report is printed out after every Memory Transmission, showing whether it was successful or not. If you have switched this report off, a Communication Failure Report will be printed after an unsuccessful Memory Transmission.

Error Report

This report is printed after each unsuccessful communication (compare with the Communication Failure below, which is printed after an operation has been completed). So while doing a broadcast, the machine may print a number of error reports, and at the end, it prints a Communication Failure Report (or Transmission Result Report if it is switched on).

Check the report and retransmit any pages that were not sent. Keep any error reports that are printed, as they may be useful for a service technician if a particular problem continues or gets worse.

Communication Failure Report (Type I only)

This report is printed after executing an operation, whether it be a single transmission or a broadcast from memory, if a transmission failure occurred during that operation. It is only printed if the Transmission Result report or Communication Result Reports are switched off.

File Reserve Report (Type I only)

If you switch this report on, it is printed immediately after you store a document in memory for Memory Transmission or Polling. It gives the file number, the time it was stored, and the destinations (including any Group numbers that were selected).

SWITCHING REPORTS ON/OFF

Power Failure Report (Type I Only)

This report is printed if the machine's power was off long enough to erase the memory. The report gives details of the files that were lost. With this information, you may store messages for transmission again, and contact the senders of any received messages that were lost.



Polling Clear Report (Type I Model)

This is printed after a polling file has been erased from memory.

SWITCHING REPORTS ON/OFF

Some of these reports can be switched on or off. To switch a report on or off, do the following (see page 102 if you need more information about User Parameter settings adjustment procedure).

1. Press the **Function** key and **6,2,2,2,2,6,3** using the ten keypad, then press the **Yes** key.

```
SETTING?          Y/◀
PRINT LIST ◀
```

2. Press the **Yes** key. The settings for Switch 00 are now displayed.

```
                KPAD/Y/◀▶
SWITCH 00: 0000 0000
```

3. Press the ◀ and ▶ keys until the settings for Switch 03 are displayed. Each digit from 0 to 7 (except digit 1) controls a report.

```
                KPAD/Y/◀▶
SWITCH 03: 0000 0000
```

Switch 03

Digit	Purpose
0	Communication Result Report (Memory Transmission) (Type I Only) 0: Off 1: On
1	Do not change this setting.
2	File Reserve Report (Memory Transmission) (Type I Only) 0: Off 1: On
3	File Reserve Report (Polling Reception) 0: Off 1: On
4	Communication Result Report (Polling Reception) 0: Off 1: On
5	Transmission Result Report (Immediate Transmission) 0: Off 1: On
6	Polling Clear Report (Type I Only) 0: Off 1: On
7	TCR 0: Off 1: On

PRINTING A SAMPLE OF DATA ON THE REPORTS

4. If you wish to change the setting, press the appropriate key on the keypad.

```
          KPAD/Y/◀▶
SWITCH 03: 0000 0000
          digit 7 6 5 4 3 2 0
```

6. Finish: Press the **Yes** key, then press the **Function** key.

NOTE: To switch the Error Report on or off, contact a service technician.

PRINTING A SAMPLE OF DATA ON THE REPORTS



This feature is only available on the Type I model.

For reference purposes, the machine can print the first few inches of the fax message on the following reports:

- Communication Result Report
- File Reserve Report
- Communication Failure Report
- Polling Clear Report

The procedure to switch this feature on or off is as follows (see page 103 if you need more information about the User Parameter settings adjustment procedure):

1. Press the **Function** key and **6,2,2,2,6,3**, using the ten keypad, then press the **Yes** key.

```
SETTING?          Y/◀
PRINT LIST ◀
```

2. Press the **Yes** key. The settings for switch 00 are now displayed.

```
          KPAD/Y/◀▶
SWITCH 00: 0000 0000
```

3. Press the **◀** key until the settings for Switch 04 are displayed.

```
          KPAD/Y/◀▶
SWITCH 04: 0000 0000
```

4. The setting that you need to change is digit 7. If you wish to change the setting, press **7** using the ten keypad.

```
          KPAD/Y/◀▶
SWITCH 04: 1000 0000
```

6. Finish: Press the **Yes** key, then press the **Function** key.

Digit 7
0: This feature is Off
1: This feature is On

REPORT FORMATS

Example 1. Error Report

The following report means that the machine sent four pages but there were errors during the first two pages.

```

*** Error Report (Aug 24 1995 12:09PM) ***
      TTI      XYZ COMPANY
FILE  ADDRESS      MODE    TIME    PAGE  RESULT
0087  XYZ CO. NEW YORK  TES    0'29"  P.4   E

      PAGE NOT SENT
      P. 1
  
```

Example 2. TCR

```

*** TCR (Aug 24 1994 11:40AM) ***
      TTI      XYZ COMPANY

<TX>
DATE    TIME      ADDRESS      MODE    TIME    PAGE  RESULT  FILE
-----
APR 28  9:48AM    XYZ NEW YORK  TES    1'11"  P. 5   OK      005
          9:54AM    XYZ LONDON   TES    0'27"  P. 1   OK      007
          9:56AM    2125551234  TES    0'28"  P. 1   OK      009
          10:01AM  XYZ BERLIN   TES    0'24"  P. 1   OK      010

<RX>
DATE    TIME      ADDRESS      MODE    TIME    PAGE  RESULT  FILE
-----
APR 28  9:51AM    DR J ALVAREZ RS    0'24"  P. 1   OK      006
          9:58AM    2015551234  RES    0"27"  P. 1   OK      008
          10:56AM  XYZ PARIS   RES    0'28"  P. 1   OK      011
          11:01AM  M. JONES   RES    0"24"  P. 1   OK      012
  
```

In the Result column, some reports may have an "E" followed by a code, and there may be a message printed at the bottom of the report. This code and there may be a message printed at the bottom a problem occurred. The code are explained below.

Result	Message	Explanation
1	Hang up or line fail	The other party either hung up or had no message on polling standby. Alternatively, there could have been a problem with the line.
2	Busy	The machine at the other end was busy.
3	No answer	The line is dead (no dial tone was detected).
4	No connection	There is no facsimile machine at the other end.

REPORTS YOU CAN PRINT OUT YOURSELF

You can print these reports at any time by following the steps below.

TCR (Transmission Confirmation Report)

In addition to the automatic output of this report, you can print the TCR at any time.

1. Press the **Function** key and **4,1** using the ten keypad, then press the **Yes** key.
2. To print : Press the **Start** key.

```
PRINT TCR          START
```

File List (Type I Only)

This is a list of Memory Transmissions, Memory Receptions, and polling files still in the memory. It gives information about each stored operation, such as the fax numbers, start time, status and type of operation.

1. Press the **Function** key and **4,2** using the ten keypad, then press the **Yes** key.
2. To print : Press the **Start** key.

```
PRINT FILE LIST   START
```

Telephone Number List

This is a list of the telephone numbers and other items you have stored in the machine's Quick Dial Keys, Speed Dial Codes and Groups. Type II is only available for Quick Dial and Speed Dial list.

1. Press the **Function** key and **4,3** using the ten keypad, then press the **Yes** key.
2. Either:
 - To print all lists: Press the **Start** key.
 - To select the list: Press the **No** key until the lists you want to print are shown then press the **Yes** key for each one.
3. Press the **Start** key.

```
ALL LISTS?       START/N  
QUICK/SPEED/GRP
```

You can also print out each telephone number list using the following functions:

- To print a Quick Dial List : Function 31
- To print a Speed Dial List: Function 32
- To print a Group Dial List: Function 33

REPORTS YOU CAN PRINT OUT YOURSELF

Authorized Reception List

This is a list of all terminal names that you have specified for Authorized Reception, including Wild Cards.

1. Press the **Function** key and **6,2,2,2,2,7,1** using the ten keypad, then press the **Yes** key.
2. Press the **◀** key.
3. To print a list: Press the **Start** key.

```
SETTING? Y/◀  
PRINT LIST ◀ / SERCH ▶
```

```
START  
SPECIAL NUMBERS LIST
```

Program List (Type I Only)

This is a list of all names that you have programmed as Auto Documents.

1. Press the **Function** key and **4,4** using the ten keypad, then press the **Yes** key.
2. To print : Press the **Start** key.

```
START  
PRINT PROGRAM LIST
```

Forwarding List (Type I Only)

This is a list of all terminal names that you have specified for Forwarding.

1. Press the **Function** key and **6,2,2,2,2,7,2** using the ten keypad then press the **Yes** key.
2. Press the **◀** key.
3. To print a list: Press the **Start** key.

```
SETTING? Y/◀  
PRINT LIST ◀ / SEARCH ▶
```

```
START  
SPECIAL NUMBERS LIST
```

User Parameter List

This shows the current settings of the User Parameters.

1. Press the **Function** key and **6,2,2,2,2,6,3** using the ten keypad, then press the **Yes** key.
2. Press the **◀** key.
3. To print a list: Press the **Start** key.

```
SETTING? Y/◀  
PRINT LIST ◀
```

```
START  
USER PARAMETER LIST
```

Cross-references

Immediate Transmission: see page 36.
Quick Dial: see page 26.
Group Dial: see page 31.
Authorized Reception: see page 67.
User Parameters: see page 102.

Memory Transmission: see page 37.
Speed Dial: see page 29.
Polling Transmission: see page 77.
Forwarding: see page 70.

MAINTAINING YOUR MACHINE

DAILY CARE

- ❑ If the room is cold, refer to "Cold Weather Power-up" on page 8 before disconnecting the power cord.
- ❑ For Type I models only, before turning off the machine make sure that the remaining memory capacity is 100%. If the machine is disconnected, any fax messages in the memory may be lost.

Procedure

1. Check the Check display indicator. If it is blinking, correct the fault.
2. Check the copy quality.
 - 2-1) Place the document in the feeder.
 - 2-2) Type I Models: Press the **Start** key.
Type II Models: Press the **Copy** key.
3. Disconnect the power cord.
4. Clean the scanner and rollers:
 - 4-1) Open the operation panel.

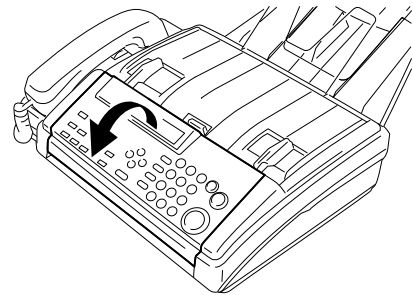

- 4-2) Pull up the green levers.

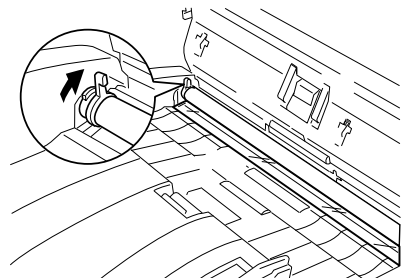

- 4-3) The Scanner glass [A] (shaded area), which is under the white rollers[B]. Clean the glass with a cotton swab and alcohol. Clean the feed roller [C] and separation pad [D] with water.

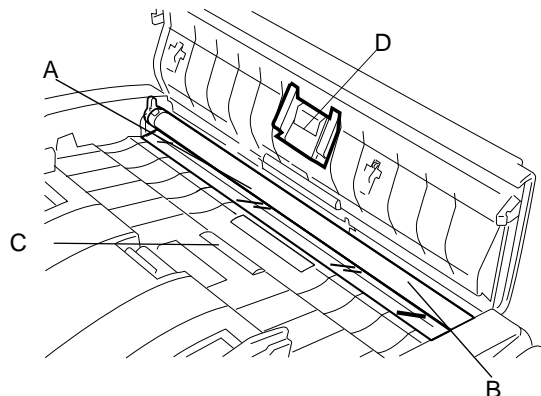

DAILY CARE

4-4) Push back down the green levers while pressing the white rollers down into place.

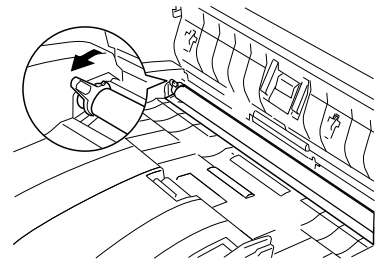

4-5) Make sure the levers are pulled down. Close the operation panel until it audibly locks into place.

NOTE: If you hear an unusual noise when you are closing the operation panel, check the green levers have been pulled down to the bottom.

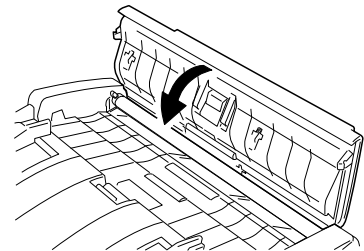

5. Clean the Thermal head.

5-1) Lift the catch to unlock the printer cover. Then, hold the paper guides and open the cover.

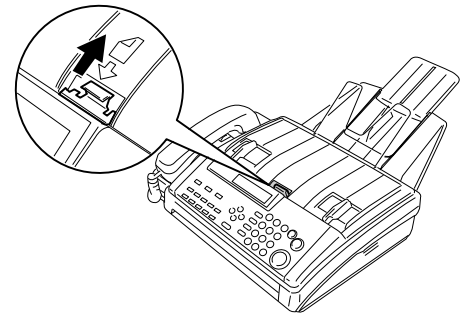

5-2) Gently wipe the thermal head [E] with the soft and damp cloth.

CAUTION: The black stripe above the head may be wiped, but do not rub it.

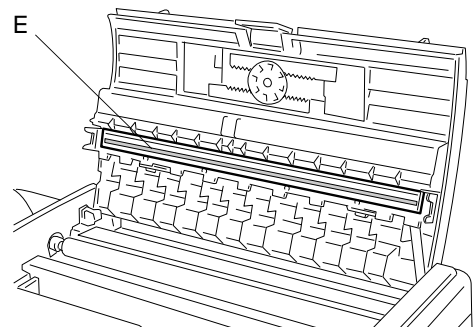

5-3) Reset the paper roll.

5-4) Close the printer cover until it audibly locks into place.

6. Clean the machine's exterior with a clean soft dry cloth.

NOTE: Do not use a cleaning agent such as benzene, washing liquid, etc.

REPLACING PAPER

When "REPLACE PAPER" is displayed, the roll is empty or it is not set correctly. Install a new roll or reset it .

Procedure

1. Lift the catch to unlock the printer cover. Then, hold the paper guides and open the cover.
2. Unpack the new thermal paper and insert the rod into the paper roll as shown, then set the roll into the machine. (Hold the roll in a direction so that it rolls away from you when pulled upwards.)

NOTE: Make sure the ends of the rod fit into the paper guides.

3. Pull out the leading edge until you can see it and feed the paper between the roller and the cover until it appears outside the back of the machine.

NOTE: Make sure that there is no slack paper inside the machine and the transparent strip that prevents paper curling is above the copy tray

4. Close the printer paper cover until it audibly locks into place.
5. The machine will tear off the excess paper. Press the **Start** key.

NOTE: If you forget this step, you can not receive or copy.

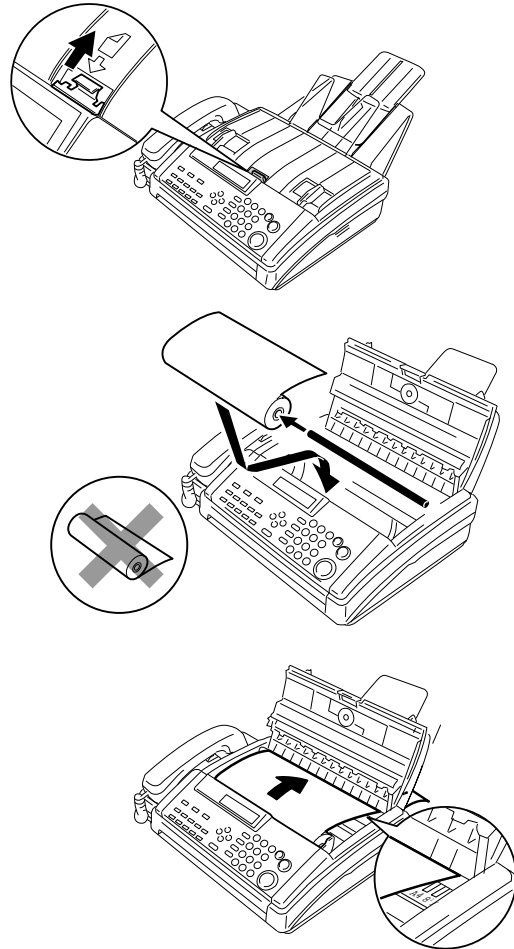

PAPER CYCLING

If "PUSH START" or "UNABLE USE PRINTER" is displayed, press the Start key.

The paper will cycle and any excess will be automatically cut off.

SOLVING PROBLEMS

DOCUMENT JAMS

If the Check Display indicator is lit, and the message "CLEAR ORIGINAL" appears on the display, there is a document jammed in the feeder. Do the following to remove the jam.

1. Carefully pull open the operation panel by pulling the top edge of the panel up and away from the machine

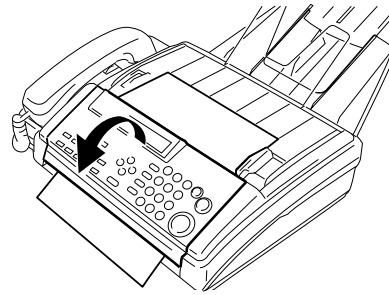

2. Take out the jammed document.

NOTE: □ When you pull out the paper in direction A, slant the operation panel a little.

- If the document will not come out, push forward the two green levers. After you have removed the document replace the levers.

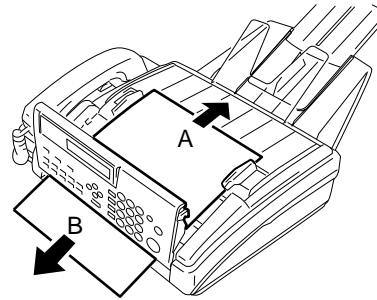

3. Close the cover until it audibly locks into place.

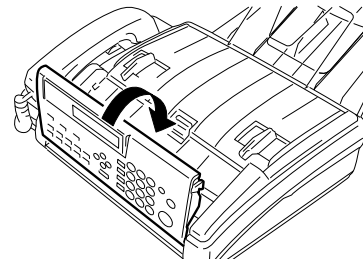

NOTE: If you hear an unusual noise when you are closing the operation panel, check the green levers have been pulled down to the bottom correctly.

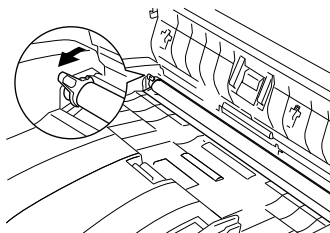

COPY JAMS

If the Check Display indicator is lit and "CLEAR COPY" appears on the display, there is a piece of paper jammed in the printer. Do the following to remove the jam.

1. Carefully Lift the catch to unlock the printer cover. Then, hold the paper guides and open the cover.

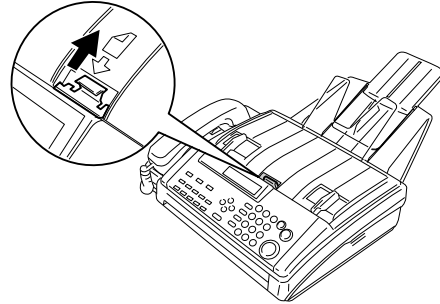

2. Remove the paper roll.
3. Pull out the jammed paper from inside the machine and cut off any damaged parts of the roll.
 - Do not leave any pieces inside the machine.

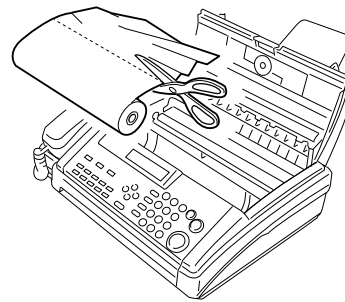

4. If the carriage is not in the home position, replace it to the left side.

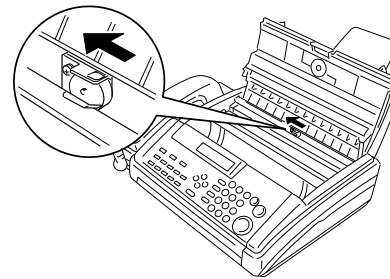

5. Install the paper roll. (Hold the roll so that it rolls away from you when pulled upwards.)

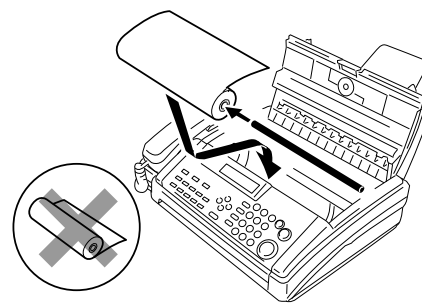

6. Pull out the leading edge until you can see it and feed the paper between the roller and the cover until it appears outside the back of the machine.

NOTE: Make sure the paper edges are aligned with the marks printed by the roller.

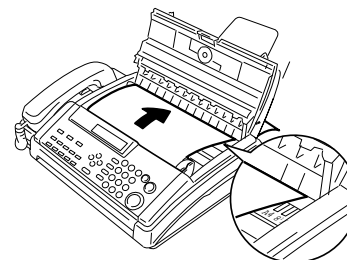

SOLVING PROBLEMS

COMMUNICATION PROBLEMS

- Close the printer paper cover until it audibly locks into place.

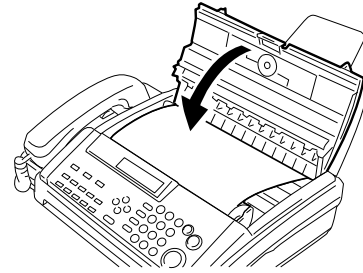

- Tear off the excess paper: Press the **Start** key.

COMMUNICATION PROBLEMS

If the Check Display indicator is lit and the message "ERROR PRESS STOP" appears on the display, a communication has just failed. Press the **Stop** key to return the machine to standby mode. If it was:

- An error during transmission: Resend the fax message. If the same problem happens again, call the other party to make sure that their fax machine is working.
- An error during reception: Call the sender and ask them to send the message again.

OPERATING DIFFICULTIES

Symptom	Required Action
The display is blank.	If the power indicator is not lit, check that the power cord is plugged in properly.
The machine cannot dial out from behind a PBX.	The number must contain the access code. A pause may also be necessary after the access code; if there is one already, try adding more pauses.
The telephone keeps ringing and no fax is printed.	You are in Manual (TEL) receive mode. Switch to Auto or Fax mode. The power cord is unplugged.
You cannot receive phone calls; the unit only rings then goes into fax receiving mode.	You are in Fax mode. Switch to Auto or Tel mode.
You cannot receive incoming calls; the unit does not ring.	Your machine's telephone line cord is disconnected.
Dialing is possible, but Secured Polling is not.	ID Codes do not match. Contact the other party and agree on an ID Code.
The Check Display indicator is lit	There is a problem, check the error display and correct the faults.
You hear an unusual noise when closing operation panel.	The green levers are not pulled down correctly. Pull down the levers to the bottom.

DISPLAYED ERROR MESSAGES

If an error occurs, one of the following messages may be displayed. The message may only be displayed briefly, so if you are watching for errors, stay by the machine and watch display.

Display	Required Action
CLOSE COVER/REPLACE PAPER	The Printer cover is not closed or the paper roll is out. Close the cover or replace the paper roll.
CLEAR ORIGINAL	The original is jammed in the feeder, remove the original document.
CLEAR COPY	There is a piece of paper jammed in the printer, remove the jam and perform paper cycling.
PUSH START UNABLE USE PRINTER	Your machine needs to cycle the paper or the paper roll is not set correctly. Press the Start key.
MEMORY OVER	There is not enough memory to store your fax message. Use a lower resolution, or send the message in several transmissions.
ERROR PRESS STOP KEY	There was an error during transmission or reception. Press the Stop key to return to standby mode. Check the Error Report.
CAN NOT PROGRAM	The limit of the number of group stations has been exceeded.
ALEADY INPUT	This number is already included in this group or this RTI/CSI has already been stored for use with this feature.
TOO MANY DIGIT	You have entered too many digits, check the number and try entering it again.
NOT PROGRAMMED	This Quick Dial or Speed Dial is not programmed.
NO FILE EXIST	Either there are no messages in memory waiting for transmission, or you have entered the wrong file number. Check the file number and try again.

ERROR CODES

Fax machines use a telephone line. The same types of problems you experience while making phone calls (such as noisy lines, crosstalk, disconnection during conversation, weak signals) also occur with faxing. Telephone callers can deal with the problems themselves (for example, by speaking a bit louder), but fax machines cannot. Therefore some errors and line failures are to be expected.

When an error occurs, an error report is printed. This report includes an error code. The following table lists common error codes and a few of the possible causes. If any of these or any other error codes are persistent and the machine does not work properly, contact a service technician.

NOTE: When an error occurs, it does not mean that you are doing anything wrong or that your machine needs service. Only if the problem persists should you call your service representative.

Code	Possible Cause
0-01	Printer empty or jammed at the other end.
0-04	Faulty machine at the other end. Poor line condition.
0-05	Poor line condition.
0-06	Incompatible or faulty terminal at the other end. Poor line condition.
0-07	The facsimile machine that you were sending to was disconnected during the call, either due to noisy phone lines, a paper jam or because it ran out of paper. Resend the page.
0-08	The machine at the other end received the page that you sent but there were errors on the page. You may want to resend the page in question. The other party's memory could also be full. Contact the other party and ask them to make room in their memory for your message.
0-14	Same as for code 0-06.
0-16	Same as for code 0-04.
0-20	Poor line condition.
0-21	Same as for code 0-04.
0-22	You have just received a fax message, but there were problems because of poor line condition. Ask the other party to resend.
0-23	Same as for code 0-22.
0-24	The memory is full, and there may be a problem with your printer, such as a jam. Wait for some space to become available in the memory, or solve the problem with your printer. If the memory was not full, substitute reception may have been disabled; switch substitute reception on.

Code	Possible Cause
1-00	Document jam. Improperly inserted document.
1-01	Document length exceeded the maximum limit. Same as for code 1-001.
2-XX	Possible fault in your machine.
4-00	The page took too long to send. Send again at a lower resolution, or without halftone. The line may be bad.
4-01	There is a bad line. The telephone line at the rear of the machine may be disconnected.
4-02	The received page was too long.
4-10	ID codes did not match. Co-ordinate ID codes with the other party.
5-20 5-21	Insufficient memory to receive the message. When the pages in memory have been printed, ask the other party to resend.
5-25	Fault in your machine.
6-01 6-02	Poor line condition or a problem with your machine.
6-05	Poor line condition, a problem with the machine at the other end, or a problem with your machine.
6-06	A problem with the machine at the other end, or a problem with your machine.
6-08	A problem with the machine at the other end.
6-09 6-10	A problem with the machine at the other end, or a problem with your machine.
9-17 9-20 9-22 9-23 9-24	There is a problem with your printer.

TECHNICAL REFERENCE

ENTERING TELEPHONE NUMBERS

When you want to dial a telephone number or store a number as a Quick Dial key or Speed Dial, type it into the machine using the ten keypad on the operation panel.

ENTERING NAMES AND LABELS

When ABC is displayed, you can use Quick Dial keys 01 to 09 to enter letters. Press a Quick Dial key and use the ◀ and ▶ keys to move through the alphabet to find the letter you want or press the same Quick Dial key continuously.

- To enter this character : Press the **Yes** key.
- To enter a blank space, symbol or punctuation mark : Press the **Quick Dial 09** key continuously until you see the symbol or punctuation mark that you need.
- To delete a character at the cursor : Move the cursor to the character that you wish to delete, then press the **Clear** key.
- To insert a character: Move the cursor to the insert position, then input the new character. The new character is inserted at the cursor position.
- If you press the ◀ and ▶ keys after pressing the Quick Dial, you may search through the alphabet.

1. If you want to store a letter, press the **Quick Dial key** for the letter.

Example: if you want to store K, press Quick Dial key 04, this will display the letter J.



2. Either:

- Press the **same Quick Dial key** until the the letter you need appears. Now the letter K is displayed.
- Press the ◀ and ▶ keys to scroll through the alphabet until you find the letter you need. Now the letter K is displayed.

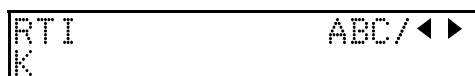

3. Press the **Yes** key to store the letter K.

Quick Dial	Letter	Quick Dial	Letter
01	A B C	06	P Q R
02	D E F	07	S T U
03	G H I	08	V W X Y Z
04	J K L	09	Symbol
05	M N O	10	Nothing

ON/ OFF SWITCHES AND USER PARAMETERS

Some of the features in this machine can be switched on or off, and some of them do not work unless they are switched on first. Other features can be adjusted in various ways. Each adjustment or on/ off switch is explained in the relevant sections of the manual.

There are two user functions to help you adjust these features and switch them on/off.

- Function 62 (On/ Off Switches)
- Function 63 (User Parameters)

On /Off Switches

This feature allows you to switch some of the major features of the machine on or off. The overall procedure is explained below. However, each of the adjustments that can be made using this procedure are explained in the relevant parts of the manual. As well as a series of on/ off switches, Function 62 allows access to many features (see the features table on the next page).

1. Press the **Function** key and **6,2,2,2,2,6,2**, at the ten keypad, then press **Yes** key.
2. Scroll through the list of features with the **▶** key until the required feature appears.
3. Press the **Yes** key.

```
SELECT LINE          Y/NEXT▶
```

4. Change the setting by using the **◀** and the **▶** keys.

```
SAVE PAPER ON/OFF  Y/NEXT▶
```

```
SAVE PAPER          Y/◀▶  
ON          ▶OFF
```

5. Press the **Yes** key to store this setting. The next switch will appear.

```
SAVE PAPER          Y/◀▶  
▶ON          OFF
```

- 6 Either :

- Select another feature : **Go to step 2.**
- Finish : Press the **Function** key.

```
AUTO CUTTER ON/OFF Y/NEXT▶
```

ON/ OFF SWITCHES AND USER PARAMETERS

A table showing the order of appearance of the switches is given below. Some of these switches may not be seen depending on the options that have been installed in the machine (* this feature is available only on Type I models).

Feature	Press ► key
Telephone Line Type	None
Authorized Reception	Once
Daylight Saving Time (USA Only)	twice
RDS	3 times
ECM *	4 times
Saving paper	5 times
Auto Cutter	6 times
Forwarding *	7 times

User Parameter Settings

A wide range of features can be switched on or off with the User Parameters. However, this feature is more difficult to use than the On/ Off Switches. The switches and adjustments are presented on the screen as rows of digits. Each digit can be either 0 or 1. Each feature is allocated one or more digit. The value of the digit determines the status of the feature.

The overall procedure is explained below. However, each of the adjustments that can be made using this procedure are explained in the relevant parts of the manual.

1. Press the **Function** key and **6,2,2,2,2,6,3** using the ten keypad, then press the **Yes** key.

```
SETTING?                                Y/◀
PRINT LIST ◀
```

- At this time, you can print a User parameter list.
Press the ◀ key, then press the Start key

2. Press the **Yes** key. The current settings for switch 00 are now displayed on the bottom line of the display. If the settings for this switch are the way that you want them, go to step 4.

```
                                KPAD/Y/◀▶
SWITCH 00: 00000000
```

3. To change the required setting, press a number from 0 to 7 using the ten keypad corresponding to the digit that you wish to change.

```
                                KPAD/Y/◀▶
SWITCH 00: 00000001
```

Example : Press 0. The value of digit 0 changes, in this case from 0 to 1.

NOTE: Each switch contains 8 digits, which act as on/off switches for various features. The digits are numbered from 0 to 7. the setting of digit 7 is shown at the left side of the display and digit 0 is at the right.



4. Either:

- Scroll through the switches with the ◀ and the ▶ keys until the required switch appears. Then go to step 3.
- Finish: Press the **Yes** key and the **Function** key.

The User Parameter switches are outlined as follows (* indicates the factory setting):

Switch 0 - Home position settings

Digit	Purpose
0 to 3	Do not change these settings.
4 to 5	Resolution (Type I Only)
	Digit 5 Digit 4 Setting
	0 0 Standard *
	0 1 Detail
6	Transmission mode:
	0:Memory Transmission Position.
	1:Immediate Transmission.*
7	Halftone mode 0:Off 1: ON*

Digit 01 - Home position settings

Digit	Purpose
0 to 6	Do not change these settings
7	If you change any of the resolution, transmission mode or Halftone settings before before making a transmission, then:
	0: The setting (s) will not return to the home position after the transmission. 1: The setting(s) will return to the home position after the transmission.*

Digit 02- Fowarding Mark

Digit	Purpose
0	Mark to be printed at the receiving side to distinguish messages that are sent from your machine when it is acting as a forwarding station (Type I Only). 0: Off 1: On*
1 to 2	Do not change these settings.

ON/ OFF SWITCHES AND USER PARAMETERS

Digit	Purpose
3	TSI Printing 0: Off* 1: On
4 to 7	Do not change these settings.

Digit 03 - Automatic printing of reports

Digit	Purpose
0	Communication Result Report (Type I Only) 0: Off *(ASIA) 1: On *(USA)
1	Do not change this setting.
2	File Reserve Report (Memory Transmission) (Type I Only) 0: Off * 1: On
3	File Reserve Report (Polling Reception) 0: Off * 1: On
4	Communication Result Report (Polling Reception) 0: Off 1: On*
5	Transmission result report (Immediate Transmission) 0: Off*(ASIA) 1: On *(USA)
6	Polling Clear Report (Type I Only) 0: Off * 1: On
7	TCR 0: Off 1: On*

Switch 04 - Automatic printing of reports

Digit	Purpose
0 to 6	Do not change these settings.
7	Inclusion of part of the image on the following reports : Transmission result report,Communication failure report (Type I Only) 0: Off 1: On *

Switch 05 - Options for reception

Digit	Purpose
0	Substitute reception (Type I Only) 0: Off 1: On *
1	Memory reception if no RTI or CSI received. 0:Enable 1: Disable*
2 to 7	Do not change these settings.

Switch 06 - Home position settings

Digit	Purpose
0	TTI Printing 0: Off 1: On *
1	Do not change these setting.
2	Closed Network Transmission 0: Off * 1: On
3 to 7	Do not change this setting.

Switch 07- One Touch Change Over

Digit	Purpose
0 to 4	Do not change this settings.
5	One Touch Change Over 0: Off 1: On *
6 to 7	Do not change this settings.

Switch 08 - Various Features with Authorized reception

Digit	Purpose		
0 to 1	Do not change this settings.		
2 to 3	Authorized reception		
	Digit 3	Digit2	Setting
	X	0	Off *
2 to 3	0	1	Receive messages only from the senders whose RTI/CSI's are programmed.
	1	1	Receive the messages only from senders whose RTI/CSI's are not programmed.
4 to 5	Do not change these settings.		
6 to 7	Forwarding		
	Digit 7	Digit6	Setting
	X	0	Off *
	0	1	Forwarded messages only from senders whose RTI/CSI's are programmed.
	1	1	Forwarded messages only from senders whose RTI/CSI's are not programmed.

Switch 09 - Do not use.

Switch 10- Halftone type

Digit	Purpose		
0 to 6	Do not change these settings.		
7	Halftone type	0: STD *	1: SPD

Switch 11 - Polling

Digit	Purpose		
0 to 5	Do not use these settings.		
6	Local printing (Type I Only)	0: Off	1: On *
7	Do not use these settings.		

Switch 12 - Do not use.

Switch 13

Digit	Purpose		
0	PSTN Access	0:Outline *	1:Inside line
1 to 6	Do not use these settings.		
7	Auto cutting leading edge	0: Off *	1: On

COUNTERS

These counters will help if you wish to keep a regular check on how many pages your machine has sent, received and copied.

- TX (Transmit) Counter:** The number of pages that your machine has sent.
- RX (Receive) Counter:** The number of pages that your machine has received.
- Scan Counter:** The number of pages that your machine has scanned (includes copy mode).
- PRINT Counter:** The number of pages that your machine has printed (includes copy mode and report/list printing).

1. Press the **Function** key and **6,2,2,2,2,8,2** using the ten keypad, then press the **Yes** key. First, the Transmission and Reception counters appear.
2. Press the **Yes** key, and the Scan and Print counter will appear.
3. When you have finished: Press the **Yes** key and the **Function** key.

TX	:	021911
RX	:	034407

SCAN	:	022705
PRINT	:	022798

DOING TWO THINGS AT ONCE (Dual Access) (Type I Only)

Dual Access means that even if the machine is already carrying out a task, you may be able to operate the machine. For instance, if your machine is currently receiving a long fax message but you want to send a message and go back to your desk without having to wait by the machine, you can place your message in the feeder, select the required transmission features, dial the number, and press the Start key. Your message will be scanned and stored to memory while the machine is still receiving. This means that you can take your fax back to your desk before it is actually sent. However, to be sure whether your transmission was successful or not, keep an eye open for Error Reports (or check the TCR). The following table shows which features can operate simultaneously on your machine.

Job Currently in progress	Next Operation							
	1.	2.	3.	4.	5.	6.	7.	8.
1. Storing to Memory	✓	✓	✗	✓	✗	✓	✓	✓
2. Printing from Memory	✓	✗	✗	✗	✗	✗	✗	✗
3. Copying	✗	✗	✗	✗	✗	✓	✗	✓
4. Printing an Automatic Report	✓	✗	✗	✗	✗	✗	✗	✗
5. Immediate Transmission	✗	✗	✗	✗	✗	✗	✗	✗
6. Memory Transmission	✓	✗	✓	✗	✗	✗	✗	✗
7. Receiving and Printing a Fax	✓	✗	✗	✗	✗	✗	✗	✗
8. Receiving a Fax to Memory	✓	✗	✓	✗	✗	✗	✗	✗

DOCUMENT TYPE

Before you send your document, make sure that it meets the following requirements.

Caution : Documents that do not meet these requirements can cause your machine to jam or may cause some components of the machine to become damaged or dirty.

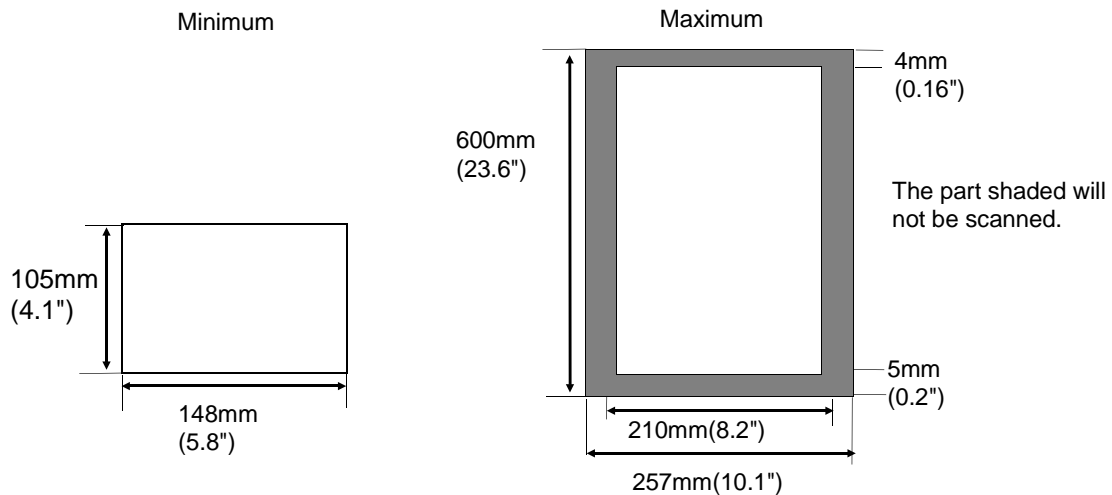

Correct Size for the Document Feeder

- Thickness: 2 to 8 mils (0.05 to 0.15 mm) (20 lb paper/80gm² paper)
- Length and Width: See the above diagram.
- If the page is too short, put it inside a document carrier or enlarge it with a copier
- If the paper is too long, divide it into two or more sheets.

Clearly Written

- Small faint characters may not be transmitted clearly.

Uniform Page Sizes

- Do not use different sizes of document in the same transmission.

Dry Ink

- All ink must be dry before you place the document in the feeder.

DOCUMENT TYPE

Page Condition

Do not place damaged pages in the automatic document feeder.

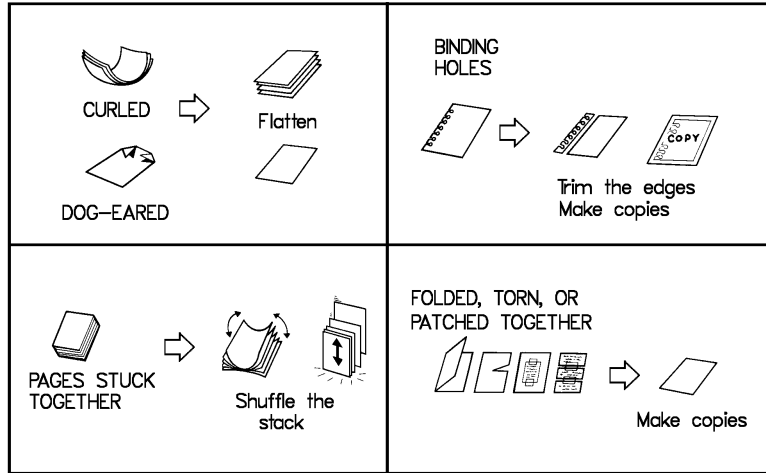

Originals that contain the following materials and photographs should not be placed in the document feeder. Make copies of these originals and scan the copies.

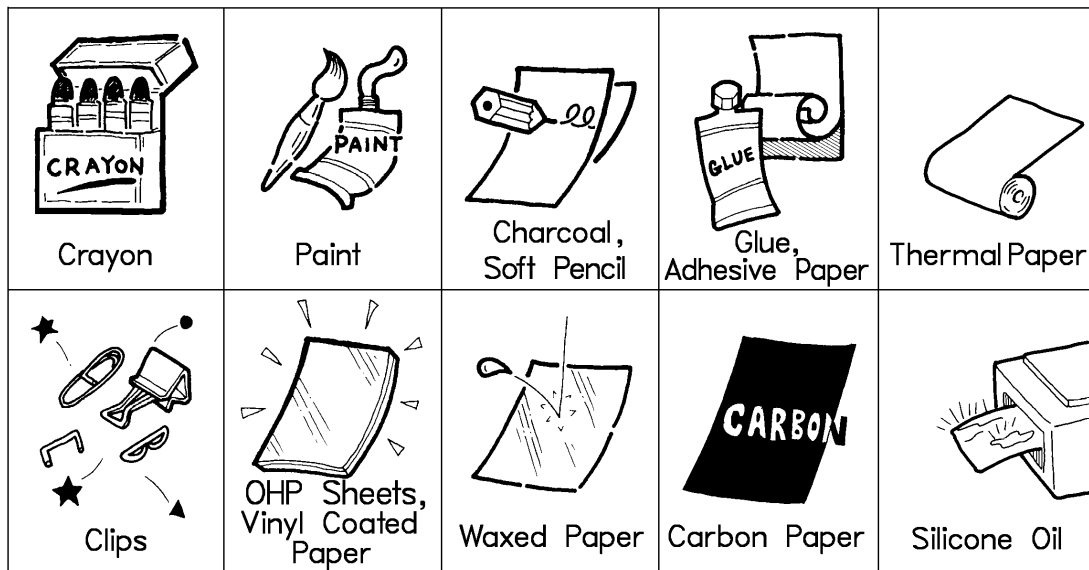

NOTE: Copies made with a copier that uses silicone oil may cause a misfeed. To avoid this, do not scan such copies until five or ten minutes after copying.

LIMITS ON THE USE OF STORED TELEPHONE NUMBERS

The following table show the limitations that the various features of your fax machine have.

1. Communication

Feature	Item
Broadcasting from memory (Type I Only)	Maximum number of destinations : 10
Polling reception	Maximum number of addresses that can be polled in one operation: 10 (Model Type I) 1 (Model Type II)

2. Programming

Feature	Item
Quick Dial keys	Number of Quick Dial keys: 10 (1 to 10) Maximum length of a name : 20 characters Maximum length of telephone or fax numbers : 240 digits
Speed Dial keys	Number of Speed Dial : Type I 50 (00 to 49) Type II 20 (00 to 19) Maximum length of a name : 20 characters Maximum length of telephone or fax numbers : 240 digits
Groups (Type I Only)	Number of Group Stations: 3 (1 to 3) Maximum length of a name : 20 characters Maximum length of telephone or fax numbers : 240 digits

SPECIFICATIONS

Dimensions: 396mm x281mm x108mm [15.6" x 11.06" x 4.25"] (W x D x H)

Weight: 4.6 Kg [9.8lbs] without thermal paper

Power Supply: North America:115 Vac, 60Hz; single phase
Saudi Arabia: 115 Vac, 60Hz; single phase/ 220 - 240 Vac,
50/60 Hz; single phase
Other areas: 220 - 240 Vac, 50/60 Hz; single phase

Power Consumption:

USA	Standby: 5.5±2W average Transmission: 11.5±4W average Reception: 19± 6W average Copying:28±8W average Maximum power consumption: 60.0±8W
Asia	Standby: 6.5±2W average Transmission: 14W±4W average Reception: 19± 6W average Copying: 26±8W average Maximum power consumption: 56W±8W

Acceptable Document : Width:148-257 mm
Dimensions: Length: 105-357 mm
Thickness: 0.05-0.15mm

ADF Capacity: 10 pages

Memory Capacity: 156 KB (ECM on)
216 KB (ECM Off)
(Type I Only) Measured using ITU -T#1 chart (Slerexe letter) at
standard resolution

Resolution: Standard: 8 x 3.85 dots per mm
Detail: 8 x 7.7 dots per mm
Fine: 8x 15.4 dots per mm

Transmission Speed: **Type I:** 9 seconds at 9,600bps (G3 ECM with memory
transmission)
for ITU-T#1 test document (Slerexe letter)
using Standard resolution
Type II: 15 second at 9,600bps (G3 transmission)
for ITU-T#1 test document (Slerexe letter)
using Standard resolution

Compatibility: G3

Paper roll: 115V Area: Thermal paper; 8.5" x 98.4' [216mm x 30m]
220V Area: Thermal paper; 210mm x 30m

GLOSSARY

ADF (Automatic Document Feeder):

A device which feeds the pages of a multi-page document one at a time, in the order that you arranged the pages in the stack.

Batch Numbering (Page Count):

This is a way of numbering pages that allows you to check whether you received all pages, and if not, which ones are missing. For example, if you receive two pages with P1/3 printed on one and P2/3 on the other, you have just received a three-page document but page 3 didn't make it.

BPS (Bits Per Second):

This is the data communication rate in G3 mode, your fax terminal digitizes documents, transforming them into 'bit'-binary digits- (an average page will produce about 200,000 of them), and then sends them out at a top speed of 2,400 to 9,600 bps, depending on the model.

Broadcasting:

In G3 fax communication terminology, broadcasting is the transmission of a document to more than one address in sequence, not simultaneously.

ITU-T:

This committee sets international standards for communication.

Communication:

Transmission or reception.

Copy:

When used as a noun, this refers to a printout, either in copy mode or receive mode.

Country Code:

In international dialing, this is the code that directs the call to the country where the terminal that you wish to send to is located.

CSI:

Called Subscriber Identification.

Default Setting:

See "Factory Setting".

Dial Pulses:

These are dialing signals that your terminal sends out if it uses pulse dialing.

Document:

This is the original page or set of pages that you wish to send.

DPI (Dots Per Inch), or L/mm (Lines Per Millimeter):

This is the unit of resolution. The scanner scans your document according to the selected resolution. An 8 1/2" x 11" page is broken down into about 1,728,000 dots if standard resolution is used. (Digital compression techniques for G3 convert these into about 200,000 bits.)

ECM (a Error Correction Mode):

This is signaling method that is designed to eliminate transmission errors on even the noisiest of telephone lines.

EFC:

This is a proprietary digital data compression technique. It shortens the time for sending a page.

Factory Setting:

The factory setting of a function is the state into which it was programmed at the factory; this will also be the state of that function in a new machine. It can also be referred to as "Default Setting".

File:

A Memory File or a Polling File.

Group 3:

This is an internationally-agreed signaling and data transfer method used for facsimile communication (approved by ITU-T). It is also known as G3.

Handset

This is the telephone that is connected to the jack marked "TEL 1" or "TEL2".

Home Position:

Some of your machine's features can be adjusted. The home position is the setting to which the machine always returns at the end of an operation.

International Dialing Codes:

This is the code that must be dialed at the beginning of the number if the destination is outside your country.

Memory File:

This is a document stored in the memory together with instructions (destinations, time of transmission) for sending that document.

Original:

Same as "Document".

Page Retransmission:

If the terminal you are sending to indicates that it did not properly receive the page you just sent, your terminal will resend that page from memory. This only works if you used Memory Transmission and if you are not using ECM (ECM is a more effective data retransmission method).

Polling File:

This is a set of instructions (destinations to be polled, time of polling) for polling reception.

Pulse Dialing

This method of dialing uses a string of pulses to represent each dialed digit.

Reception:

The act of receiving a document.

RTI

Remote Terminal Identification.

Sending:

Same as "Transmission", see below.

Standby Mode:

The terminal is said to be in standby mode when it is idle.

Terminal:

A facsimile terminal, such as your machine.

Tone Dialing:

This method of dialing uses a tone to represent each dialed digit.

Transmission:

The act of sending a document.

TTI:

Transmit Terminal Identification.

GLOSSARY

INDEX

A

AI Short Protocol, 84
Authorized Reception, 66
Authorized Reception List, 90
Auto Document, 58
Auto Ring Time, 49
Automatic Cutter, 22
Automatic Redialing, 47
Automatically printed reports, 85
Autoselect Mode, 49

B

Blocking Wrong Connection Reception, 65
Broadcasting, 38

C

Calling to request a message, 76
Chain Dial, 34
Changing Transmission Mode, 46
Closed Network Reception, 65
Cold Weather Power-Up , 8
Communication Failure Report, 85
Communication Problems, 96
Communication Result Report 85,86,87,104
Connecting Telephone Answering Mode, 50
Converting Transmission Mode, 46
Copy Jam, 95
Copying, 84
Counters, 106
CSI, 20
Cutting Paper, 22
Cutting the leading edge of the paper, 24

D

Daily Care, 91 - 92
Detail, Fine, Standard, 41
Date and Time, 17
Daylight Saving Time, 21
Document Type, 107 - 108
Doing Two Things at once, 106
Dual Access, 106
Document Jam, 94

E

ECM, 62
Entering Names and Labels, 100
Entering telephone number, 100
Error Code, 98 - 99
Error Messages, 97
Error Report, 85, 88
Extension Telephone System, 23

F

Fax Mode, 50
File List, 89
Forwarding, 70
Forwarding Mark, 74
Forwarding List, 90
Free Polling, 77
File Reserve Report 85,86,87,104

G

General Precaution, 9
Glossary, 111 - 114
Grounding, 7
Group Dial, 31,34,39
Group Dial List, 89

H

Halftone, 41
Homeposition Adjustments, 42

I

ID Transmission, 64
Identification Display, 18
Immediate Transmission, 36
Installation, 13

J

Journal, 85, 88 - 89

L

Limits On the Use of Stored Telephone Number, 109
Local Printing, 74
Location, 13

M

Machine's Identification, 18
Maintaining Your Machine , 91, 93
Manual Paper Cutting, 22
Manual Receive Mode, 50
Memory Transmission as your first choice, 46

O

On/Off Switches, 101
One Touch Change Over, 55
Operating Difficulties, 96
Operating Precautions, 9
Outline Telephone System, 23

P

Page Condition, 108
Page Header, 19
Page Number, 45
Page Retransmission, 62
Paper Precautions, 9

Paper Saver, 82
Polling, 76
Polling Clear Report, 86
Polling ID, 76
Polling Reception, 80
Polling reception, Stored ID override, 80
Polling Transmission, 77
Polling transmission, ID Override, 78
Power Failure Report, 86
Power Supply, 7, 15
Prefix Number, 23
Preventing transfer to a wrong connection, 63
Printing a sample of data on the reports, 87
Printing TTI , 46
Program List, 90
Pulse Dial, 21

Q

Quick Dial , 26
Quick Dial List, 89

R

RDS, 83
Receiving, 51
Receiving fax message when there is a problem, 53
Redial Key, 48
Redialing, 47 - 48
Rejection of Unidentified Sender, 65
Replacing The Paper , 93
Reports you can print out yourself, 89 - 90
Resolution, 41
RTI, 18

S

Scanning Quickly, 37
Secured Polling, 77
Send Later, 44
Sending Quickly, 36
Sending To More Than One Location, 38
Solving Problems, 94 - 95, 97, 99
Specifications, 110
Speed Dial, 29
Speed Dial List, 89
Storing an Often used Document, 58
Substitute Reception, 53

T

TCR, 85, 88 - 89
Technical Reference, 99 - 101, 103, 105, 107, 109, 111, 113
Telephone Answering Machine, 50
Telephone Call, 56 - 57
Telephone Directory, 43
Telephone Line Type, 21
Telephone Mode, 50

Telephone Number Display, 20
Telephone Number List, 89
Thunderstorms, 8
Tonal Signal, 61
Tone Dial, 21
Tone Key, 61
Transmission Result Report, 85
TTI, 19

U

User Parameter List, 90
User Parameter Settings, 102

W

Wild cards, 75

FUNCTION LIST

Type I Models

NO.	FUNCTION	PAGE
11	Polling Reception	80
12	Polling Transmission	77
13	Free Polling Transmission	77
21	Erasing Memory Files	38
22	Erasing Polling Reception Files	81
23	Erasing Polling Transmission Files	79
31	Programming Quick Dial / Printing The Quick Dial List	27
32	Programming Speed Dial / Printing The Speed Dial List	29
33	Programming Group Dial / Printing The Group Dial List	31
34	Storing and erasing an Auto Document	58
41	Printing the TCR	89
42	Printing the File List	89
43	Printing the Telephone Number List	89
44	Printing an Auto Document	58
51	Printing the contents of Memory Files	39
52	Printing the contents of Polling Files	78
53	Printing the contents of an Auto Document	60
Functions 60 and above can only be used after a password has been entered.		
61	System Set Up: Polling ID, RTI, TTI, CSI, PSTN Access Number, Auto Ring Time	19
62	On / Off Switches	102
63	Programming User Parameters / Printing a User Parameter List	103
71	Programming Authorized Senders / Printing an Authorized Senders List	67
72	Programming Forwarding / Printing the Forwarding List	71
81	Programming The Date And Time	17
82	Checking Counters	106

Type II Models

NO.	FUNCTION	PAGE
11	Polling Reception	81
12	Polling Transmission	78
13	Free Polling Transmission	78
21	Erasing Polling Reception Files	39
31	Programming Quick Dial / Printing The Quick Dial List	28
32	Programming Speed Dial / Printing The Speed Dial List	30
41	Printing the TCR	90
42	Printing the Telephone Number List	90
Function 60 and above can only be used after a password has been entered		
61	System Set Up: Polling ID, RTI, TTI, CSI, PSTN Access Number, Auto Ring Time	19
62	On / Off Switches	102
63	Programming User Parameters / Printing a User Parameter List	103
71	Programming Authorized Senders / Printing an Authorized Senders List	67
81	Programming The Date And Time	18
82	Checking Counters	107

Quick Reference Card

Basic Transmission Procedure [Type I Model]

	Memory Transmission	Immediate Transmission
1	Make sure that the machine is in standby mode.	
2	Check that the Memory indicator is lit. If it is not lit, press the Line Select key.	Check that the Memory indicator is not Lit. If it is lit, press the Line Select key.
3	Carefully place the document in the feeder.	
4	Select the resolution (and halftone if necessary)	
5	You may select one or more of the following options. To select an option, press the right arrow on the scroll key, then press one of the following combinations of keys. Send Later Page Count TTI On/ Off	
6	Enter the telephone number in one of the following ways	
	Quick Dial Speed Dial Group Dial Ten Key Pad Handset On Hook Dial	Quick Dial Speed Dial Ten Key Pad Handset On Hook Dial
7	Press the YES key.	Press the START key.
8	Either:Dial another number go to step 6. then Press the Start key. To dial another number, go to step 6. Otherwise, press the Start key .	
9	The machine stores your message in memory, then sends it to each terminal in sequence.	The machine dials, then your message is fed, scanned, and sent to the other terminal.

[Type II Model]

Immediate Transmission	
1	Make sure that the machine is in standby mode.
2	Carefully place the document in the feeder.
3	Select the resolution (and halftone if necessary)
4	You may select one or more of the following options. To select an option, press the right arrow on the scroll key, then press one of the following combinations of keys. Send Later Page Count TTI On/ Off
5	Quick Dial Speed Dial Ten Key Pad Handset On Hook Dial
6	Press the START key.
7	The machine dials, then your message is fed, scanned, and sent to the other terminal.

Clear File From Memory

1. Memory Transmission (Type I Only): Press the **Function** key and **2,1** using the ten keypad, then press the **Yes** key.
Polling Reception : Press the **Function** key and **2,2** using the ten keypad, then press the **Yes** key.
Polling Transmission (Type I Only): Press the **Function** key and **2,2** using the ten keypad, then press the **Yes** key.
2. Input the file number. If you do not know the file number, print a list of files or press the ► key until the required file appears.
3. Press the **YES** key **twice**.
4. Press the **Function** key.

ENERGY SAVING INFORMATION



As an Energy Star Partner, we have determined that this fax model meets Energy Star guidelines for energy efficiency.

This product was designed to reduce the environmental impact associated with this fax equipment. This is accomplished by means of energy saving features such as Low Power (Energy Saver) modes and Night Timer. Please see applicable sections of operating manual for details.



NOTE: This information is only for the Type I models.

When your machine receives a new voice message, it can call your programmed station automatically. You can choose a paging number or a telephone number as your station. If you choose the paging number and telephone number as your station, the machine will call only the paging number.

If you follow the procedure below, your pager will display the sender's telephone number and message numbers when your fax machine has received a voice message.

NOTE: You must program the paging telephone number first.

1. Press the **Function** key and **6,2,2,2,2,6,1** using ten keypad, then press the **Yes** key.



2. If the above display has not appeared, press the k key until the screen is as shown above.

3. Press the **Yes** key.



4. Input the paging telephone number that you wish to use.
Example: 7227050552 , press 7,2,2,7,0,5,0,5,5,2 using the ten keypad.

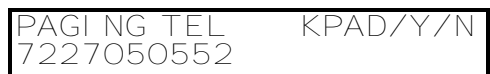

5. Press the **Yes** key .

6. Finish: Press the **Function** key

1. Press the **Function** key and **6,2,2,2,2,6,2** using the ten keypad. Then press the **Yes** key.



2. Press the k key until "PAGI NG ON/OFF" is displayed.



3. Press the **Yes** key.

PAGI NG	Y/j k
ON kOFF	

4. Use the **j** and the **k** keys to switch this feature on or off.

PAGI NG	Y/j k
kON OFF	

5. Press the **Yes** key to store your setting, then press the **Function** key.

When your fax machine receives a new voice message, it will make yur pager beep 10 times.

NOTE: You must program the telephone number first.

When the fax machine fail to call, It will automatically redial.

1. Press the **Function** key and **6,2,2,2,2,6,1** using ten keypad, then press the **Yes** key.

SET PAGI NG TEL NO.	Y/NEXTk
---------------------	---------

2 Press the **k** key until the screen is as shown opposite.

SET NOTI FY TEL NO.	Y/NEXTk
---------------------	---------

3.Press the **Yes** key.

NOTI FY TEL	KPAD

4. Input the paging telephone number that you wish to use.

NOTI FY TEL	KPAD/Y/N
3122620471	

Example: 3122620471 , press

3,1,2,2,6,2,0,4,7,1 using the ten keypad.

5. Press the **Yes** key .

6. Finish: Press the **Function** key

1. Press the **Function** key and **6,2,2,2,2,6,2** using the ten keypad. Then press the **Yes** key.

SELECT LI NE	Y/NEXT k
--------------	----------

2. Press the **k** key until "NOTI FYI NG ON/OFF" is displayed.

NOTI FYI NG ON/OFF	Y/NEXT k
--------------------	----------

3. Press the **Yes** key.

NOTI FYI NG	Y/j k
ON kOFF	

- Use the **j** and the **k** keys to switch this feature on or off.

NOTIFYING	Y/j	k
KON OFF		

- Press the **Yes** key to store your setting, then press the **Function** key.

When you go out, you can hear the received voice messages from your machine using this feature. This feature will work only if the following conditions have been met.

- When you use this feature from another place, You must be connected to a telephone line that can accept DTMF (tone dial) signals.
- Your machine's remote ID code must be programmed.
- Remote control must be switched on.

As a new machine has a Remote ID of 0000 when it leaves factory, we recommend that you store a new Remote ID immediately.

- Press the **Function** key and **6,2,2,2,2,6,1** using ten keypad, then press the **Yes** key.

SET PAGING TEL NO.	Y/NEXT	k
--------------------	--------	---

- Press the **k** key until the screen is as shown opposite.

SET REMOTE I D	Y/NEXT	k
----------------	--------	---

- Press the **Yes** key.

REMOTE CHANGE?	Y/N	
0000		

- Press the **Yes** key and the **No** key to clear.

REMOTE I D	KPAD	

- Input the Remote ID that you wish to use.
Example: 0826 , press 0,8,2,6 using the ten keypad.

REMOTE I D	Y/N	
0826		

- Press the **Yes** key .

- Finish: Press the **Function** key

- Press the **Function** key and **6,2,2,2,2,6,2** using the ten keypad. Then press the **Yes** key.

SELECT LINE	Y/NEXT	k
-------------	--------	---

- Press the **k** key until "REMOTE FUNC. ON/OFF" is displayed.

REMOTE FUNC. ON/OFF	Y/NEXT	k
---------------------	--------	---

3. Press the **Yes** key.

REMOTE FUNC.	Y/j k
ON kOFF	

4. Use the j and the k keys to switch this feature on or off.

REMOTE FUNC.	Y/j k
kON OFF	

5. Press the **Yes** key to store your setting, then press the **Function** key.

1. Dial your fax machine.
2. Immediately after hearing the telephone answering machine's message you must press the # key.
3. You enter your **Remote ID code**, then press the # key. A single high-pitched beep will be heard. This is an Ack tone (Acknowledgment).
4. After hearing the Ack tone, you must press **3,0** and the # key quickly.
- 5 You can hear the received voice messages from your machine. They will be played back from the new one.

NOTE: If you wish to play back again, press 3,0 and #.

If you wish to stop play back, press the # key twice.

6. When you have listened to all messages press the # key **twice**.

Sometimes during this feature you will hear one or more beeps.

Sound	Reason	Required Action
One high beep	Acknowledgment	No problem; keep going.
A short beep three times	Rejection	Operation error. Try again.
A high beep three times	Service code accepted	No problem; keep going.

When you go out, you can confirm whether your machine received new voice messages or not depending on the number of rings as shown in the following chart.

Number Of Calling	Meaning
2	Your machine received the voice messages.
5	Your machine did not receive the voice message.

If you hang up the telephone within 5 rings, you can save the telephone charges.

1. Press the **Function** key and **6,2,2,2,6,2** using the ten keypad. Then press the **Yes** key.

SELECT LINE Y/NEXT k

2. Press the **k** key until "TOLL SAVING ON/OFF" is displayed.

TOLL SAVING ON/OFF Y/NEXT k

3. Press the **Yes** key.

TOLL SAVING ON kOFF Y/j k

4. Use the **j** and the **k** keys to switch this feature on or off.

TOLL SAVING kON OFF Y/j k

5. Press the **Yes** key to store your setting, then press the **Function** key.

1. P.51

Giving Priority To Telephone Answering (TAM) Mode

This mode is selected when the Auto Select Indicator is lit just like Auto Select Mode. If you receive voice messages, start the indicator blinks. This mode ensures that the answering machine mode has a chance to respond to incoming telephone calls. If the call happens to be a fax message, the message will be given to the fax machine automatically.

If the other party calls you, a recorded message will be played automatically. The message is fixed at the factory.

Setting up the TAM mode

1. Press the Function key and **6,2,2,2,2,6,2** using the ten keypad. Then press the **Yes** key.

```
SELECT LINE          Y/NEXT ▶
```

2. Press the ▶ key until "SELECT AUTO RECEIVE MODE" is displayed.

```
SELECT AUTO RECEIVE  Y/NEXT ▶
```

3. Press the **Yes** key.

```
PRIORITY             Y/◀▶  
▶ AUTO              TAM
```

4. Press the ◀ and the ▶ key to switch TAM Mode on.

```
PRIORITY             Y/◀▶  
AUTO                ▶ TAM
```

5. Press the **Yes** key and the **Function** key.
6. Make sure that the Auto Select Indicator is lit. If it is not lit, press the **Reception** key until it is lit.

Sending a Recorded Message

When you are in TAM mode, you can choose whether to transmit the recorded voice message or not. The message is spoken in Chinese. You can not change this message.

1. Press the **Function** key and **6,2,2,2,2,6,3** using the ten keypad, then press the **Yes** key.

```
SETTING?             Y/◀  
PRINT LIST ◀
```

- At this time, you can print a User Parameter List if you press the ▶ key, then press the Start key.

2. Press the **Yes** key, then press the ◀ and the ▶ key until the setting for Switch 07 is shown.

```
                KPAD/Y/◀▶  
SWITCH 07: 0000 0000
```

3. Change the setting of digit 1. If you wish to change the settings press **1** using the ten keypad.

```
                KPAD/Y/◀▶  
SWITCH 07: 1000 0000
```

4. To finish: Press the **Yes** key, then press the **Function** key.

2. P89

TELEPHONE ANSWERING MACHINE

The Type I model has a useful internal Telephone Answering machine. You can access it by setting up your machine to TAM mode. You do not need to connect an extra telephone. This machine can record messages of up to about 6 minutes in all.

Keys

Listening to the received voice messages

1. Make sure that the machine is in TAM mode.

2. Press the **No** key, now you are in TAM standby mode.

```
01 MESSAGE(S) EXIT/▲  
ERASE-C >/>>-▶
```

3. Either:

- The number is displayed on the first line, you received messages: Go to step 4.
- "00 message(s)" is not displayed, you have not received any message: Go to step 5.

4. Press the ▶ key. The machine will start playing back from the first message, and the date and time of receiving will be displayed.

```
NO. 01: MAR. 25 11:35AM  
◀◀-◀ ◻-▲ >/>>-▶
```

- NOTE:**
- If you wish to stop playing, press the **No** key.
 - If you wish to skip a message, press the ▶ key.
 - If you wish to skip back a message, press the ◀ key.

5. After playing back all received messages, the beep tone is transmitted 5 times and it will return to standby mode.

Clearing All the All Received Messages

1. Make sure that the machine is in TAM mode.
2. Press the **No** key.

```
01 MESSAGE(S) EXIT/▲
ERASE-C >/>>-▶
```

3. Press the **Clear** key.

```
ERASE ALL MESSAGES? Y/N
```

4. Either:
 - Erase all received messages:
Press the **Yes** key.
 - Otherwise: Press the **No** key
5. Press the **Function** key.

Cancelling the TAM Mode

1. Press the **Function** key and **6,2,2,2,6,2** using the ten keypad. Then press the **Yes** key.

```
SELECT LINE Y/NEXT ▶
```

2. Press the **▶** key until "SELECT AUTO RECEIVE MODE" is displayed.

```
SELECT AUTO RECEIVE Y/NEXT ▶
```

3. Press the **Yes** key.

```
PRIORITY Y/◀▶
AUTO ▶ TAM
```

4. Press the **◀** and the **▶** keys to switch TAM Mode off.

```
PRIORITY Y/◀▶
▶ AUTO TAM
```

NOTE: If "ERASE ALL MESSAGES?" is displayed, you have not listened to all received messages yet. Press the **No** key and listen to them.

Put In The Batteries (type I Model Only)

All fax messages stored in the memory may be erased if power is switched off. If you wish to avoid this, please put two batteries into the machine.

NOTE: Do not turn on the machine.

1. Open the battery cover on the bottom of the machine.

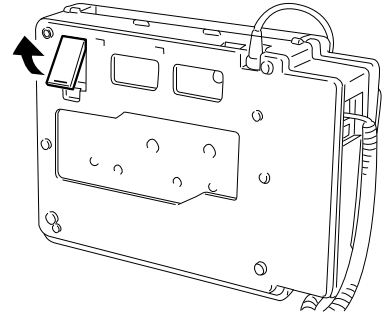

2. Put in the batteries making sure the terminals are the right way up. See the diagram.

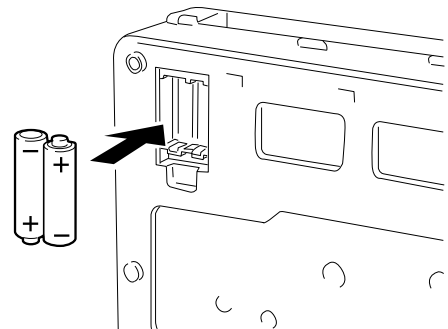

3. Replace the battery cover.

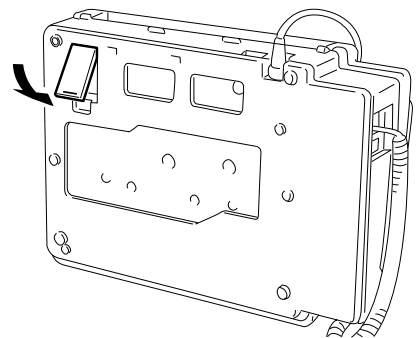

ERRATA

[P13] Accessories

One paper holder rod is also packed with the machine.

[P14] Installation Procedure

2-3) Set the paper guides [E] at each end to match the paper size. The paper roll must be set in the center.

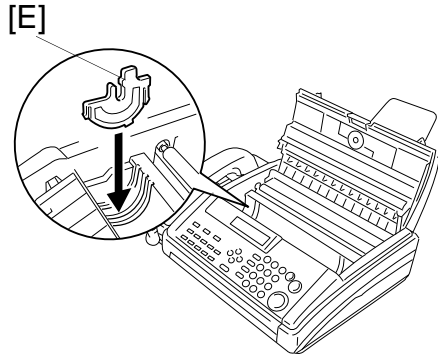

2-4) Insert the rod into the paper roll as shown, then set the roll into the machine (hold the roll in a direction so that it rolls away from you when the leading edge is pulled upward).

NOTE: Make sure the ends of the rod fit into the paper guides

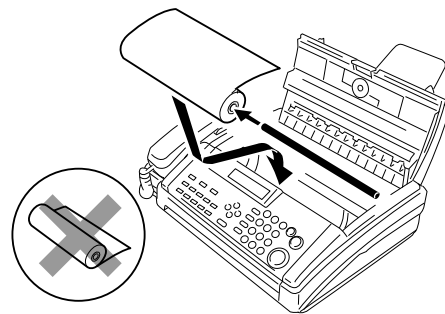

[P15]

Cut off excess paper after plugging in the power cord. Disregard step 2-7 and insert the following after step 3-3:

3-4) Press the start key to cut off the excess paper.

[P85, 86, 87 and 104]

Replace " Memory Storage Report" and "Polling Reserve Report" with "File Reserve Report ".

This report is printed after storage for memory transmission and/or polling reception.

Replace "Polling Result Report" with "Communication Result Report ". This report is printed after memory transmission and/or polling reception .

Part No. H0688690

ERRATA

WARNING: This equipment has been tested and found to comply with the limits for a Class B digital device, pursuant to Part 15 of the FCC Rules. These limits are designed to provide reasonable protection against harmful interference in a residential installation. This equipment generates, uses, and can radiate radio frequency energy and, if not installed and used in accordance with the instructions, may cause harmful interference to radio communications. However, there is no guarantee that interference will not occur in a particular installation. If this equipment does cause harmful interference to radio or television reception, which can be determined by turning the equipment off and on, the user is encouraged to try to correct the interference by one or more of the following measures:

- Reorient or relocate the receiving antenna.
- Increase the separation between the equipment and receiver.
- Connect the equipment into an outlet on a circuit different from that to which the receiver is connected.
- Consult the dealer or an experienced radio/TV technician for help.

Part No. H0688693

NOTICE TO USERS (New Zealand)

Equipment connected to the interface port shall be certified to meet the requirements of Reg. 18 of the New Zealand wiring Regulations 1976.

Telepermitted equipment may only be connected to the interface port.

The operation of this equipment on the same line as telephones or other equipment with audible warning devices or automatic ring detectors will give rise to bell tinkle or noise and may cause false tripping of the ring detector. Should such problems occur, the user is not to contact Telecom Faults Service.

Immediately disconnect the equipment should it ever suffer physical damage which results in their internal parts becoming accessible in normal use. Arrange for its disposal or have it repaired before it is reconnected.

Should it necessary to move the equipment, it is necessary to disconnect the Telecom network connection before disconnecting the Power lead or any separate earth lead. Similarly, when reconnecting the equipment it is necessary to connect the power lead or earth lead before connecting the telecom Network.

Not all standard telephones will respond to incoming ringing when connected to the extension socket.

IMPORTANT SAFETY INSTRUCTIONS

1. Read all of these instructions.
2. Save these instructions for later use.
3. Follow all warnings and instructions marked on the product.
4. Unplug this product from the wall outlet before cleaning. Do not use liquid cleaners or aerosol cleaners. Use a damp cloth for cleaning.
5. Do not use this product near water.
6. Do not place this product on an unstable cart, stand, or table. The product may fall, causing serious damage to the product or injuring the user.
7. Slots and openings in the cabinet and the back or bottom are provided for ventilation; to ensure reliable operation of the product and to protect it from overheating, these openings must not be blocked or covered. The openings should never be blocked by placing the product on a bed, sofa, rug or other similar surface. This product should not be placed in a built-in installation unless proper ventilation is provided.
8. This product should be operated from the type of power source indicated on the marking label. If you are not sure of the type of power available, consult an authorized sales person or your local power company.
9. This product is equipped with a 3-wire grounding type plug, a plug having a third (grounding) pin. This plug will only fit into a grounding-type power outlet. This is a safety feature. If you are unable to insert the plug into the outlet, contact your electrician to replace your obsolete outlet. Do not defeat the purpose of the grounding type plug. (This does not apply in countries in which the 2-wire, non-grounded type plug is used)
10. Do not allow anything to rest on the power cord. Do not locate this product where persons will walk on the cord.
11. If an extension cord is used with this product. Make sure that the total of ampere ratings of the products plugged into the extension cord do not exceed the extension cord ampere rating. Also, make sure that the total of all products plugged into the wall outlet does not exceed 15 amperes.
12. Never push objects of any kind into this product through cabinet slots as they may touch dangerous voltage points or short out parts that could result in a risk of fire or electric shock. Never spill liquid of any kind on the product.
13. Do not attempt to service this product yourself, as opening or removing covers may expose you to dangerous voltage points or other risks. Refer all servicing to qualified service personnel.
14. Unplug this product from the wall outlet and refer servicing to qualified service personnel under the following conditions:
 - A. When the power cord or plug is damaged or frayed.
 - B. If liquid has been spilled into the product.
 - C. If the product has been exposed to rain or water.
 - D. If the product does not operate normally when the operating instructions are followed. Adjust only those controls that are covered by the operating instructions since improper adjustment of other controls may result in damage and will often required extensive work by a qualified technician to restore the product to normal operation.
 - E. If the product has been dropped or cabinet has been damaged.
 - F. If the product exhibits a distinct change in performance, indicating a need for service.

Additional Information and Errata

[P51] Receiving with Auto Select mode

1. The machine starts ringing.
2. You have two options:
 - Pick up the handset.
If you hear a voice then continue a normal conversation.
If you hear a tone then the other end is a fax machine. Make sure the document feeder is empty, press the Start key to start receiving and replace the handset. If you do not replace the handset or press the Start key, after a few seconds the machine will automatically take the line and receive the message.
 - Do nothing. The machine will keep ringing. After a number of rings (the auto ring time) the machine will begin to receive a message. You can change the number of rings (the auto ring time) - see page 49.

[P14, 92, 93 and 95] Opening the printer cover

The printer cover catch is located in the center of the cover. To release the printer cover, you need to squeeze the catch backwards - see opposite. The cover will spring out a little. Then grasp the paper guides and raise the cover up.

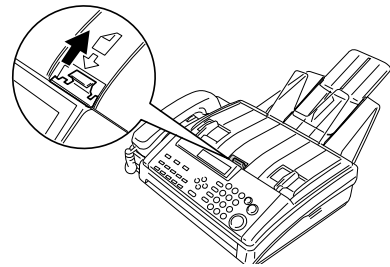

NOTE: The catch must be squeezed backwards. If you apply too much pressure in the opposite direction the catch will become detached from the machine. If this happens, follow the instructions below.

Reattaching the printer cover catch

If your printer cover catch becomes detached, it can easily be fixed. While holding the printer cover open, push the catch back into position in the direction shown opposite. The catch should click into place.

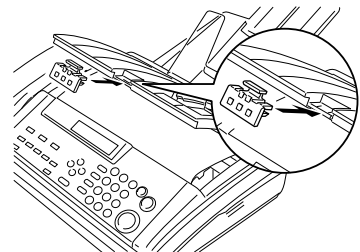

[P95] Replacing the carriage

If you close the printer cover and "REPLACE PAPER" or "CLEAR COPY" is still displayed, please check the position of the carriage. It should be on the left side. If it is not in that position, slide it back to the left.

NOTE: If the carriage sticks halfway, the transparent plastic strip may be blocking it - pull it out slightly from the rear of the machine to let it pass.

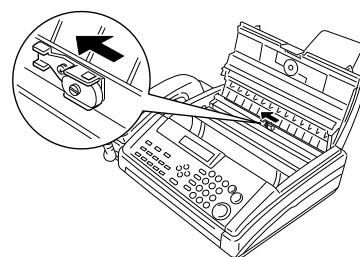
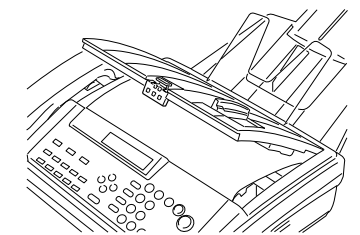

Part No. H0688697

Additional Information and Errata

[P51] Receiving with Auto Select mode

1. The machine start ringing.
2. You have two options:
 - Pick up the handset. If a person is at the other end, you can continue a normal conversation. However, if it its a fax machine (if you hear the tone), press the Start key, then replace the handset to receive the message.
 - Do nothing. The machine keep ringing. After a number of rings (the auto ring time) the machine will begin to receive a message. You can change the number of rings (the auto ring time) - see page 49.

[P15, 103, 103 and 105] Opening the printer cover

The printer cover catch is located in the center of the cover. To release the printer cover, you need to squeeze the catch Backwards -see opposite. the cover will spring out slightly allowing you to raise it up.

NOTE: The catch must be squeezed backwards. If you apply too much pressure in the opposite direction the catch will become detached from the machine. If this happens, follow the instructions below.

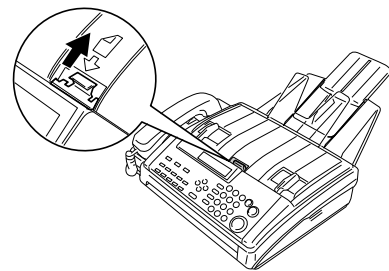

Reattaching the printer Cover Catch

If your printer cover catch becomes detached, it can be easily be fixed. While holding printer cover open, push the catch back into position in the direction shown opposite. The catch should click into place.

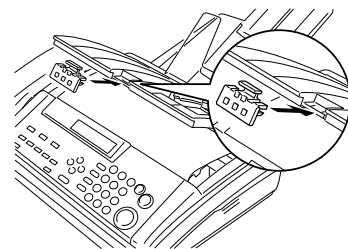

[P106] Replacing the carriage

When you close the printer cover, but the "REPLACE PAPER" or "CLEAR COPY" is still displayed, please check the position of the carriage. It should be left side. If it is not in that position, slide it back to the left.

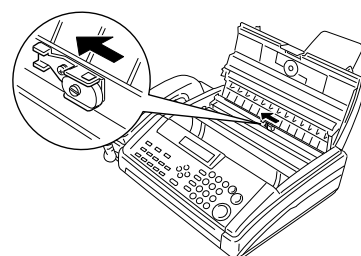

Part No. H0688698

Free Manuals Download Website

<http://myh66.com>

<http://usermanuals.us>

<http://www.somanuals.com>

<http://www.4manuals.cc>

<http://www.manual-lib.com>

<http://www.404manual.com>

<http://www.luxmanual.com>

<http://aubethermostatmanual.com>

Golf course search by state

<http://golfingnear.com>

Email search by domain

<http://emailbydomain.com>

Auto manuals search

<http://auto.somanuals.com>

TV manuals search

<http://tv.somanuals.com>