



**RICOH**

# ***RDC-5300***

## **DIGITAL CAMERA**

### **Operation Manual**

To ensure correct use of your digital camera, read this manual carefully before use. Keep the manual handy for future reference.

# Introduction

---

Thank you for purchasing a Ricoh digital camera. This manual explains the correct handling procedures and precautions for your camera. To ensure the best performance, please read the manual thoroughly before using the camera. Keep the manual handy for quick future reference.

Ricoh Co., Ltd.

## Test Shots

Check that your camera is recording the images correctly by taking a number of test shots.

## Copyright

Reproduction or alteration of copyrighted documents, magazines, music and other materials, other than for personal, home or similarly limited purposes, without the consent of the copyright holder is prohibited.

## Exemption from Liability

Ricoh Co., Ltd. assumes no liability for failure to record or play back images caused by malfunction of the digital camera.

## Warranty

This product is manufactured to local specifications and the warranty is valid within the country of purchase. Should the product fail or malfunction while you are abroad, the manufacturer assumes no responsibility for servicing the product locally or bearing the expenditure incurred therefor.

## Radio Interference

Operating the digital camera in the vicinity of other electronic equipment may adversely affect the performance of both devices. In particular, operating the camera close to a radio or television may lead to interference. If interference occurs, follow the procedures below.

- Move the camera as far away as possible from the TV, radio or other device
- Reorient the TV or radio antenna.
- Plug the devices into separate electrical outlets.

- This publication may not be reproduced in whole or part without the express written permission of Ricoh. ©1999 Ricoh Co., Ltd. All rights reserved.
- Ricoh reserves the right to change the contents of this publication without notice. Considerable care was taken in preparing this manual. If, however, you have questions about any part of the manual, or note mistakes or inaccuracies, please contact us at the address listed on the back cover.

Microsoft, MS and Windows are registered trademarks of Microsoft Corporation in the United States of America and other countries. Macintosh is a registered trademark of Apple Computer, Inc., in the United States of America and other countries. All trademarked company and product names mentioned in this manual are the property of their respective owners.

# Camera Features

---

## ● 2,300,000-pixel resolution compact camera

With a 2,300,000-pixel resolution CCD, the compact camera produces high-quality, high-resolution images (1792 × 1200). The camera is so light you can carry it with you anywhere.

## ● Immediate recording

Using the camera is as simple as clicking the shutter release button. Images thus shot are written to internal memory (8 MB) or a SmartMedia memory card (2/4/8/16/32/64 MB).

\* Internal memory allow you to take pictures without the need for SmartMedia card.

## ● Instant playback

You can instantly review recorded image files simply by switching to Play mode. You can also magnify the images zoom playback or display several images at once (6-image display).

\* SmartMedia memory cards let you exchange shot images with your friends.

## ● Multiple image recording modes

The RDC-5300 offers multiple image recording modes to suit your specific photographic needs, including F (Fine) mode, which puts the emphasis on image quality, N (Normal) and E (Economy) mode, which allows you to capture more images than any other mode.

## ● Wide shooting range

The 3.0 × zoom lens allows you to capture subjects in a variety of compositions, from close-ups to shots with a background.

## ● Natural colors

The white balance feature allows you to capture a subject in its natural colors under any lighting conditions, indoors or outdoors.

## ● Close-ups

Macro mode for taking close-up shots at distances up to 4 cm (1.6 inches) (at wide) is ideally suited for taking flowers and small objects, etc.

## ● Monitors images on the TV screen

Connect the digital camera to a TV set with the video interface cable supplied and you can display your image files on the TV screen. You can also connect the camera to a video deck or video printer to dub the images onto a videotape or make full color prints.

## ● Transfers images to a PC

You can transfer the images onto a PC using software compatible with the digital camera. When loaded onto a PC, the images can be printed on a color printer or color copier.

# Table of Contents

---

Camera Features .....	1
Table of Contents .....	2
Safety Precautions .....	5
Parts & Names .....	10
Explanation of LCD Monitor Displays .....	12
LCD Monitor .....	12
LCD Panel .....	14
Menus .....	17
Basic Operation/Quick Reference .....	20

## Chapter 1 GETTING STARTED

Before Using the Camera .....	26
Checking the Package Contents .....	26
Attaching the Wrist Strap .....	26
Powering the Camera .....	27
Loading the AA Batteries .....	27
Using an AC Adapter .....	29
SmartMedia Memory Cards .....	31
What is a SmartMedia Memory Card? .....	31
Inserting a SmartMedia Memory Card .....	32
Formatting a SmartMedia Memory Card .....	33
Before You Start Recording .....	35
Setting the Date and Time .....	35
Adjusting the LCD Monitor Brightness .....	37
How To Hold the Camera .....	37

## Chapter 2 BASIC SHOOTING

Basic Shooting .....	40
Operation Flow .....	40
Turning on the Camera .....	41
Selecting IN/CARD (Internal memory/SmartMedia memory card) Memory .....	42
Selecting PIC (Image quality) Mode .....	43
Selecting Recording Mode .....	44
Setting the Size of the Subject (Zoom) .....	46
How to View Images on the LCD Monitor .....	47
Shooting (Still Picture Mode) .....	48

## Chapter 3 **ADVANCED SHOOTING**

Changing Flash Modes .....	54
Changing the flash mode .....	55
Setting the Exposure Compensation .....	57
Setting the Exposure Compensation .....	57
Changing the White Balance Mode .....	59
Changing the White Balance Mode .....	59
Special Shooting Functions .....	61
Using the Self-Timer .....	61
Focus Lock Shooting .....	62
Focus Mode Shooting .....	63
Date Imprint Mode .....	65
Redeye Reduction Mode .....	66
Monochrome Mode (Black & White) Sepia .....	67
Interval (Time lapse) Shooting Mode .....	68
Using SOFT Mode .....	70
S Mode (Shutter Speed) .....	71
Using Auto Bracket .....	72
Macro Shooting (Close-up Shooting) .....	73

## Chapter 4 **PLAYBACK/ERASING**

Before Starting to Playback Recorded Images .....	76
Playback Display .....	76
Connecting to a TV .....	77
Playing Back a File .....	78
Operation Flow .....	78
Playing an Image File .....	79
Multi Image Playback .....	80
Zoom Playback .....	81
Auto Playback .....	82
Protecting a File .....	83
Copying Files .....	84
Playing a File Shot with Another Brand of Camera .....	86
Setting DPOF (Direct Print of File) .....	87
Setting a Printing Service .....	87
Setting Secret File .....	91

Erasing a File (Image) .....	94
Operation Flow .....	94
Erase .....	95
Erase All Images .....	96
Erase Selected Files (Images) .....	97

## **Chapter 5 MISCELLANEOUS**

Transferring Images to a PC .....	100
Changing Camera Settings .....	102
Beep Sound Setting .....	102
Auto Power Off Setting .....	103
Keep Settings .....	104
Formatting Internal Memory .....	105
Changing OSD (On-Screen Display) Language .....	106
Changing Video-Out Signal Method (NTSC/PAL) .....	107
Changing LCD Confirmation .....	108
Changing the LCD Setting .....	109
Initializing Settings .....	110
Changing File Names .....	111
Using the DISPLAY Button to Turn the Power ON and OFF .....	112
Checking the Version .....	113
Using the Remote Control .....	114
Shooting .....	114
Playing .....	115
Erasing .....	116
Accessories .....	118
Handling Precautions .....	119
Care and Storage .....	120
Troubleshooting .....	121
Using Your Digital Camera in Other Countries .....	124
About the Warranty and Servicing .....	125
Specifications .....	127
Recording Capacities .....	129
Ricoh Service Offices .....	131

# Safety Precautions

## Warning Symbols

Various symbols are used throughout this instruction manual and on the product to prevent physical harm to you or other people and damage to property. The symbols and their meanings are explained below.

 **Warning** This symbol indicates matters that may lead to death or serious injury if ignored or incorrectly handled.

 **Caution** This symbol indicates matters that may lead to injury or physical damage if ignored or incorrectly handled.

## Sample Warnings



The  symbol alerts you to actions that must be performed.



The  symbol alerts you to prohibited actions.

The  symbol may be combined with other symbols to indicate that a specific action is prohibited.

### ● Examples



Do not touch



Do not disassemble

Observe the following precautions to ensure safe use of this equipment.

## Warning



- Turn off the power immediately in the event of irregularity, such as the equipment emitting smoke or a strange smell. Remove the batteries as soon as possible, being careful to avoid electric shocks or burns. If you are drawing power from a household electrical outlet, be sure to unplug the power cord from the outlet to avoid fire or electrical hazards. Discontinue use of the equipment immediately if it is malfunctioning. Contact the nearest service center at your earliest convenience.

## Warning



- Turn off the power immediately if any metallic object, water, liquid or other foreign object gets into the equipment. Remove the batteries as soon as possible, being careful to avoid electric shocks or burns. If you are drawing power from a household electrical outlet, be sure to unplug the power cord from the outlet to avoid fire or electrical hazards. Discontinue use of the equipment immediately if it is malfunctioning. Contact the nearest service center at your earliest convenience.



- Avoid any contact with the liquid crystal inside the LCD monitor, should the monitor be damaged. Follow the emergency measures below in the following circumstances.
  - SKIN: If any of the liquid crystal gets on your skin, wipe it off and rinse the affected area thoroughly with water, then wash well with soap.
  - EYES: If it gets in your eyes, wash your eyes with clean water for at least 15 minutes and seek medical advice immediately.
  - INGESTION: If any of the liquid crystal is ingested, rinse the mouth out thoroughly with water. Have the victim drink a large amount of water and induce vomiting. Seek medical assistance immediately.



- Follow these precautions to prevent the batteries from leaking, overheating, igniting or exploding.
  - Do not use batteries other than those specifically recommended for the equipment.
  - Do not put the batteries in a fire, short-circuit the terminals, or attempt to disassemble, heat or recharge them. (Only nickel-cadmium (Ni-Cd) and nickel-metal-hydride (Ni-MH) batteries are rechargeable).
  - Do not use a mix of battery types. Avoid mixing different styles or classifications, batteries by different manufacturers, or old batteries with new.
  - Check that the batteries are loaded with the positive (+) and negative (–) terminals correctly oriented.
  - Do not solder the batteries.



- Do not mix rechargeable battery types or use batteries with substantially different charge statuses.



## Warning



- Keep the batteries used in this equipment out of the reach of children to prevent accidental ingestion of harmful substances. Consumption of battery fluid is extremely harmful to human beings. If swallowed, seek immediate medical assistance.



Never use batteries in the following condition as this could lead to leaks, overheating, ignition, explosions or short circuits.

- Do not use batteries with insulation missing from around the negative (-) terminal.

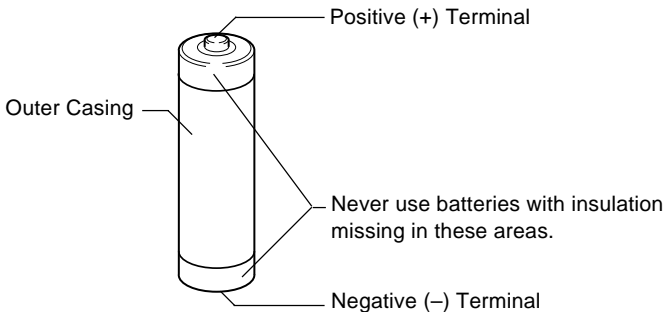

- Do not use batteries with outer casings that are damaged or missing.



- Keep the equipment out of the reach of children. Their inability to read and understand warnings and safety precautions may lead to accidents.



- Do not touch the internal components of the equipment if they become exposed as a result of being dropped or damaged. The high-voltage circuitry in the equipment could lead to an electric shock. Remove the batteries as soon as possible, being careful to avoid electric shocks or burns. Take the equipment to your nearest dealer or service center if it is damaged.



- Do not attempt to disassemble, repair or alter the equipment yourself. The high-voltage circuitry in the equipment poses significant electrical hazard.



- Do not use the equipment in the bathroom or shower as this could result in fire or electric shock.

## **Warning**



- Do not use the equipment near flammable gases, gasoline, benzine, thinner or similar substances to avoid the risk of explosion, fire or burns.
- Do not use the equipment in aircraft or other locations where usage is restricted or prohibited as this may lead to disasters or accidents.



- Wipe off any dust that accumulates on the electrical plug as this may lead to fire.
- Use only the specified AC adapters for this equipment (optional AC-3) in household electrical outlets. Other adapters pose the risk of fire, electric shock or injury.



- To avoid the risk of fire, electric shock or injury, do not use the AC adapter with commercially available electronic transformers when traveling abroad.

Observe the following precautions to ensure safe use of this unit.

## **Caution**



- Contact with fluid leaking from a battery can lead to burns. If part of your body comes in contact with a damaged battery, wash the area with water immediately. (Do not use soap.) If a battery starts to leak, remove it immediately from the equipment and wipe the battery chamber thoroughly before replacing it with a new battery.



- Plug the power cords securely into the electrical outlets. Loose cords pose a fire hazard.



- Do not allow the camera to get wet. In addition, do not operate it with wet hands. Both pose the risk of electric shock.



- Do not fire the flash at drivers of vehicles, such as bicycles, cars and trains, as this may cause the driver to lose control and result in a traffic accident.



- Do not grasp batteries with metallic tweezers as this may form a short circuit and lead to fire or electric shock.

## **Safety Warnings for Accessories**

- Safety warnings for the optional accessories, such as the AC adapter, are contained in the instruction manual provided with each product and should be read thoroughly before operating the equipment.

# Parts & Names

## ■ Camera Body

### Front

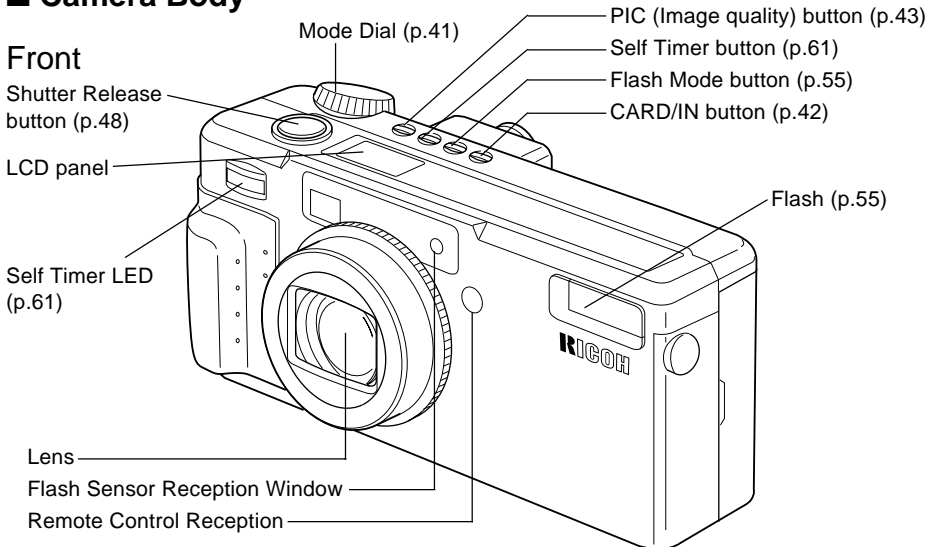

### Back

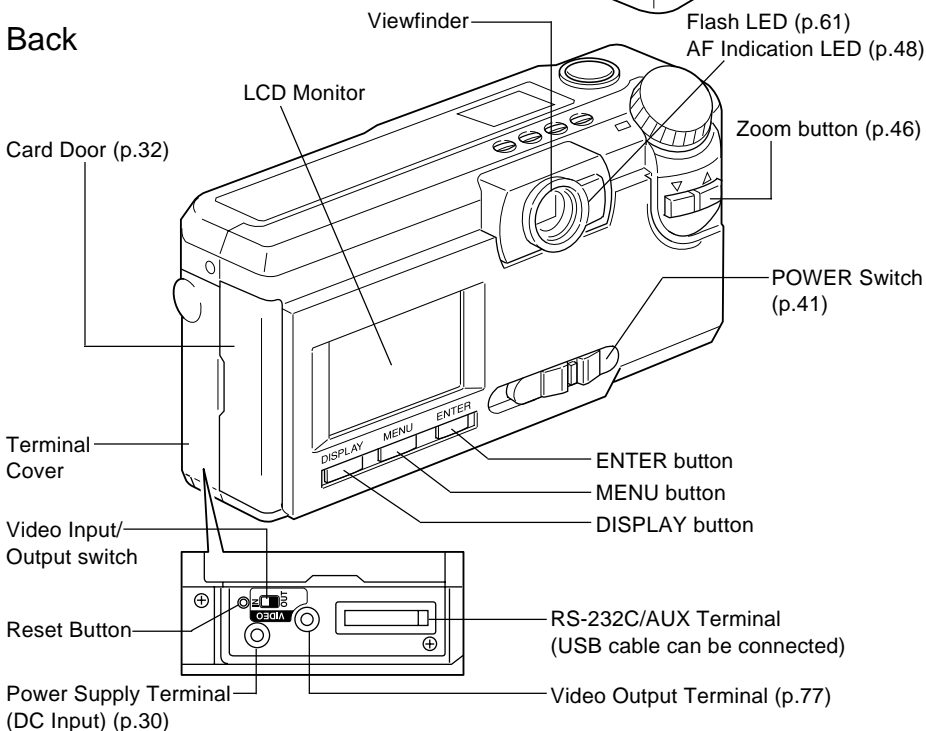

## Bottom

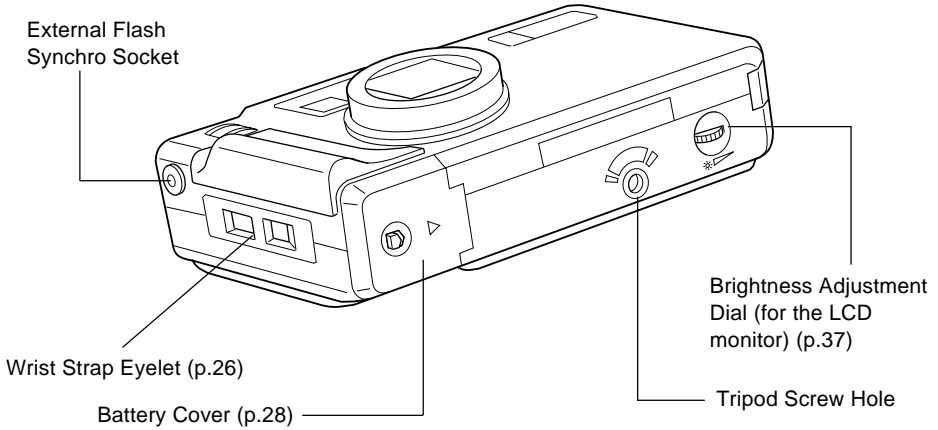

## ■ AC Adapter (optional)

- AC-3 (100V-240V)

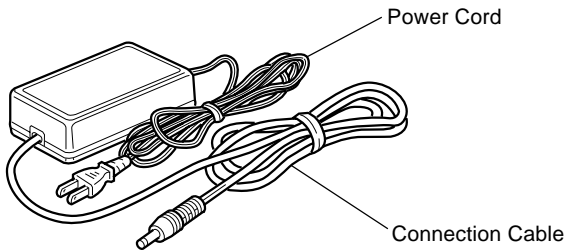

## ■ SmartMedia Memory Card (optional)

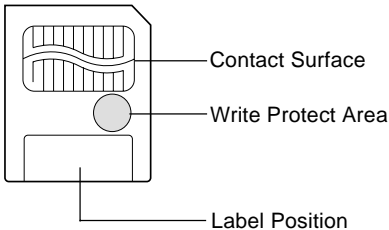

## ■ Remote Control Unit (optional) (DR-3)

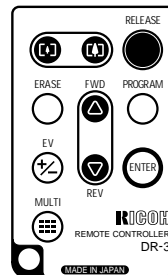

# Explanation of LCD Monitor Displays

The LCD monitor or the LCD panel displays symbols and figures showing the status of your digital camera, such as the battery level, the number of pictures that can be taken, and the mode settings.

## LCD Monitor

### Recording Mode Displays

Redeye reduction mode (p.66)

#### Flash Mode (p.55)

- Flash Off Mode (☺)
- Forced Flash Mode (☼)
- Slow Synchro Mode (⚡: flashing)
- Auto Flash Mode (☼)

#### Recording Mode (p.44)

- Quick shooting mode (⇒)
- Still Picture Mode (□)
- Text Mode (☐)

#### Focus (p.62)

AF•MF•SP

#### Auto Bracket (p.72)

#### Zoom Indication Bar (p.46)

#### Exposure compensation level

#### Message Display

Date & Time Display (p.35)

#### White Balance Indicator (p.59)

- Auto (no symbol)
- Daylight Mode [☀]
- Cloudy Mode (Overcast Mode) (☁)
- Tungsten Light mode (☼)
- Fluorescent Light Mode (☼)

#### IN/CARD (internal card) memory (p.42)

- Internal memory (LIN)
- SmartMedia (CAM)

#### Recording Data Indicator

Displays the remaining number of pictures.

#### PIC (Image quality) Mode (p.43)

- 1800 × 1200/900 × 600 Fine Mode [F]
- 1800 × 1200/900 × 600 Normal Mode [N]
- 1800 × 1200/900 × 600 Economy Mode [E]

#### Battery Symbol (p.13, 29)

#### Self-Timer Mode (p.61)

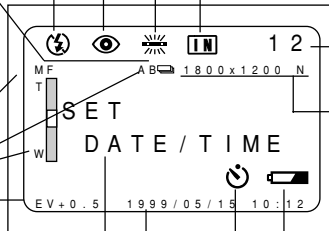

### Play Mode Displays

#### Source for playback (p.76, 79)

- Internal memory (LIN)
- SmartMedia (CAM)

#### PIC (Image quality) Mode (p.79)

- 1800 × 1200/900 × 600 Fine Mode [F]
- 1800 × 1200/900 × 600 Normal Mode [N]
- 1800 × 1200/900 × 600 Economy Mode [E]

#### Recording Data

No. of the image file displayed.

Total no. of files recorded.

#### Folder name/File name (xxx-000)

xxx: Folder name in which pictures are recorded.  
0000: File name of a picture

#### Image Protect Mark (p.83)

Secret mark (Om) (p.91)

#### Battery symbol

#### Shooting Date and Time

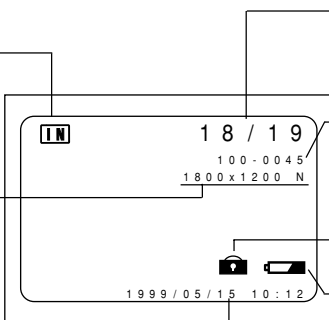



- All items of information are shown for illustration purposes. During actual camera operation, only the relevant items are displayed.

## ■ Warning Messages

If any of the warning messages listed below appears on the camera's LCD monitor, read the corresponding explanation and take the corrective action suggested.

Warning Message	Status	Explanation and Remedy	Reference Page
	Lit	Indicates low batteries. Have replacement batteries ready.	P. 27
NO CARD	Flashing	A SmartMedia memory card is out of position. Mount a SmartMedia memory card.	P. 32
WRITE PROTECTED	Flashing	A write-protected SmartMedia memory card is found. Remove the write protection label from the card to gain access to it.	P. 31
SECRET FILE	Flashing	The file you are attempting to erase is a secret file. Do not attempt to erase secret files.	P. 91
FILE PROTECTED	Flashing	You attempted to erase a protected file. Unprotect the file before erasing it.	P. 83
NO IMAGE	Lit	There are no files to play. Mount a SmartMedia memory card having files recorded on it.	P. 32
UNMATCHED FILE	Flashing	You attempted to play an unplayable file.	P. 76
FILE NUMBER OVER	Flashing	No more files can be recorded. Format the internal memory or insert a new SmartMedia memory card to continue recording. (Displayed when the file name becomes Rxxx 9999 during setting the sequential File No.)	P. 32, 105
SET DATE/TIME	Flashing	The date has not been set. Set the date before starting operations with the camera.	P. 35

## ■ Error Messages

If any of the error messages listed below appears on the camera's LCD monitor, read the corresponding explanation and take the corrective action suggested.

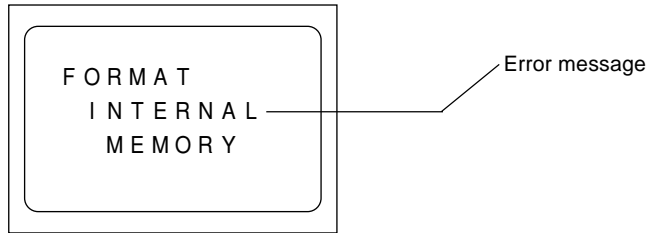

Error Message	Explanation and Remedy	Reference Page
FORMAT CARD	The SmartMedia memory card is unformatted. Format the card with the camera before using it.	P. 33
FORMAT INTERNAL MEMORY	Format the internal memory before using it.	P. 105
CARD ERROR	A SmartMedia memory card of this type is not supported by this camera.	—
ERROR XX-XX-XX-XX-XX	Slide the power switch to turn the power off and then on again.	—



If the error display does not clear, reset the LCD monitor to its factory default: How to reset: With the terminal cover open, press the reset button (p. 10). If the error display still won't clear, call your dealer or our service contact.

## LCD Panel

### ■ Initial display (SETUP mode)

The LCD panel appears blank.

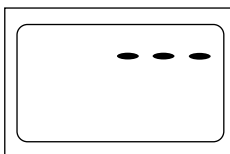



## ■ Displays Appearing during Recording

**Battery Symbol (p.12, 29)**

**Recording Destination (p.42)**

- Internal memory (IM)
- SmartMedia memory card (CARD)

**Built-in Flash (p.55)**

- Flash Off (⊗)
- Forced Flash (⚡)
- Slow Synchro (⚡: flashing)
- Auto Flash (no mark appearing)

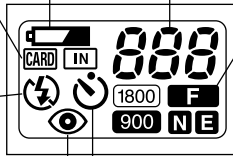

**Recording Data Indicator**  
Displays the available picture count.

**PIC Mode (p.43)**

- 1800/900 Fine Mode (F)
- 1800/900 Normal Mode (N)
- 1800/900 Economy Mode (E)

**Self-Timer (p.61)**

**Redeye Reduction Mode (p.66)**



- The recording information indicator uses the letter L to designate the 100s place in the remaining number of files when it is 1,000 or more.
- In shooting with the digital zoom function enabled, only F, N or E is displayed as a PIC mode.

## ■ Displays Appearing during Playback/Erase

**Battery Symbol (p.12, 29)**

**Source for Playback (p.76, 79)**

- Internal memory (IM)
- SmartMedia memory card (CARD)

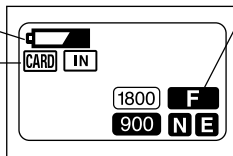

**PIC Mode (p.43)**

- 1800/900 Fine Mode (F)
- 1800/900 Normal Mode (N)
- 1800/900 Economy Mode (E)



- Either CARD or IN is displayed for files recorded on any other digital camera, such as a digital camera from the RDC-300/RDC-4000 Family (Ricoh) or one of non-Ricoh make.
- The PIC mode is not displayed when the multi-image playback or erase function is enabled.

## ■ Displays Appearing during Communication (Communication Mode)

- On an RS-232C cable connection

**Battery Symbol (p.12, 29)**

**Recording Destination (p.42)**

- Internal memory (IM)
- SmartMedia memory card (CARD)

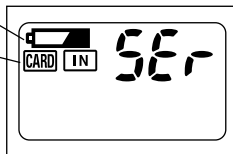

The LCD monitor displays the message "WAITING."

- On a USB cable connection

**Battery Symbol (p.12, 29)**

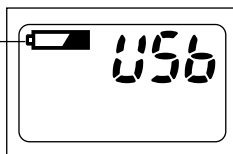

The LCD monitor displays nothing.

## ■ Error Displays and Contents

When one of the following errors appears on the LCD panel on top of the camera body, check the contents and take appropriate action.

Error display	Contents	Reference page
E-0 E-1 E-2 E-3 E-4 E-5	Slide the power switch on the camera body to turn the power source being used (battery, AC adapter) off and then on again. If a battery is being used, replace the battery with a new one.	—

**Note**

- If the error display does not clear, reset the LCD monitor to its factory default:  
How to reset: With the terminal cover open, press the reset button (P.10). If the error display still won't clear, call your dealer or our service contact.

# Menus

This camera features four menus which can be used to enter or change the settings for recording, playing or erasing image files.

## ■ SET UP Menu

With the camera turned on, set the mode dial to **[SET UP]**. To cancel the setup menu, turn the mode dial to select another mode.

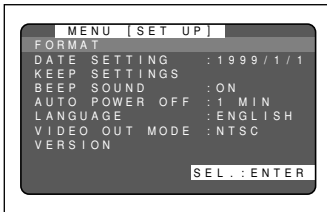

- FORMAT:** ..... Formats internal memory or a SmartMedia memory card. (p.33, 105)
- DATE SETTING:** ..... Sets the date and time. (p.35)
- KEEP SETTINGS:** ..... Saves camera settings. (p.104)
- BEEP SOUND:** ..... Switches the electronic beep on and off. (p.102)

### AUTO POWER

- OFF:** ..... Enables or disables the auto power-off feature, whereby the camera switches off automatically when left idle for about 5 minutes or longer. (p.103)

- LANGUAGE:** ..... Switches the LCD monitor display between Japanese and English. (p.106)

- VIDEO OUT MODE:** ... Switches the camera between NTSC and PAL when it is connected to a TV set. (p.107)

- VERSION:** ..... Displays current version information about the camera. (p.113)

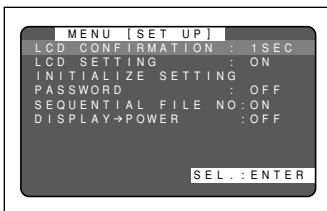

### LCD

- CONFIRMATION:** ..... Sets the confirmation time for images after shooting. (p.108)

- LCD SETTING:** ..... Selects whether to let the camera come up with the LCD monitor enabled or disabled when it is powered on in a recording mode. (p.109)

### INITIALIZE

- SETTING:** ..... Initialize all the settings. (p.110)
- PASSWORD:** ..... Sets a password for the secret function. (p.91)

- SEQUENTIAL FILE NO.:** ... Sets a sequential file NO. or not. (p.111)

- DISPLAY → POWER:** ... Sets whether to turn the power on/off by pressing the DISPLAY button. (p.112)

## ■ Record Menu

With the camera turned on, set the mode dial to [📷] and press the menu button. To exit the record menu, press the menu button again.

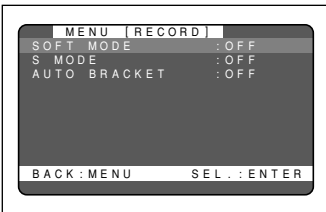
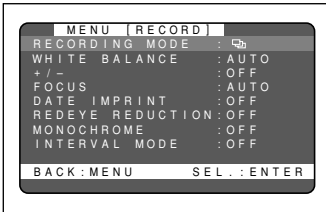

### RECORDING

**MODE:** ..... Switches between recording modes, such as text, quick shooting and still picture (p.44).

**WHITE BALANCE:** .... Switches between the white balance settings (p.59).

**+/- (Exposure compensation):** ..... Sets the exposure compensation (p.57).

**FOCUS:** ..... Switches between auto focus and manual focus (p.63).

**DATE IMPRINT:** ..... Records images with date. (p.65)

**REDEYE REDUCTION:**  
..... Reduces the red-eye when shooting live subjects with flash. (p.66)

**MONOCHROME:** ..... Records images in Black & White or sepia. (p.67)

**INTERVAL MODE:** ..... Switches interval (time lapse) setting on and off (p.68).

**SOFT MODE:** ..... Smooths the contours of the image. (p. 70)

**S MODE:** ..... Sets the shutter speed to a faster setting for shooting in dim light (p.71).

**AUTO BRACKET:** ..... Three frames are exposed: one frame at the current exposure compensation value, one at -0.5EV and another at +0.5EV. (p. 72)

## ■ Play Menu

With the camera turned on, set the mode dial to [▶] and press the menu button. To exit the play menu, press the menu button again.

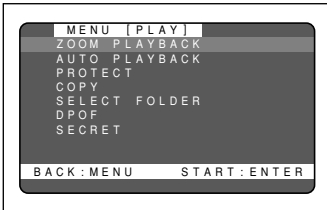

- ZOOM PLAYBACK: ...** Displays an enlarged image. (p.81)
- AUTO PLAYBACK: ...** Plays all images automatically within a preset length of time. (p.82)
- PROTECT: .....** Protects image files from erasure. (p.83)
- COPY: .....** Copies shot images from internal memory to a SmartMedia memory card, and vice versa. (p.84)
- SELECT FOLDER: ....** Displays files recorded with a digital camera other than RDC-5300 (another brand or other Ricoh products), except for digital camera RDC-1/RDC-2. (P.86)
- DPOF: .....** Select this function to generate recorded images for submission to digital printing services or other applications. (p.87)
- SECRET: .....** Sets secret so that files cannot be displayed unless a password is entered. (p.91)

## Erase Menu

With the camera turned on, set the mode dial to [🗑️]. To exit the erase menu, set the mode dial to another mode.



- ERASE SINGLE IMAGE:**  
..... Erases selected images one at a time (except protected images) (p.95).
- ERASE ALL IMAGES:**  
..... Erases all the files from the card (except protected images) (p.96).
- ERASE SELECTED IMAGES:**  
..... Erases multiple selected images (except for protected files) at once. (p.97)

\* Protected and secret files cannot be erased.



- The [PC] setting on the mode dial is used to transfer image files from the camera to a PC.

# Basic Operation/Quick Reference

This section provides introductory information about the Ricoh RDC-5300 digital camera. Further details can be found in the reference pages mentioned below.

## Preparations

### Loading the Batteries (p.27-29)

**① Load the batteries into the camera.**

- \* When using an AC adapter, connect it to the camera and then to the AC outlet. (p.29)

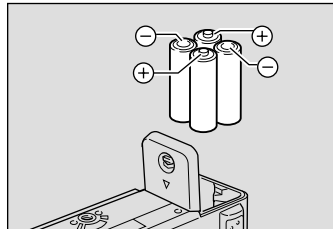
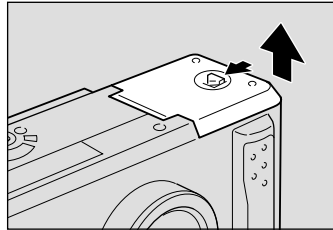

### Inserting a SmartMedia Memory Card (p.32-33)



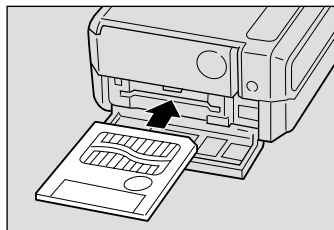
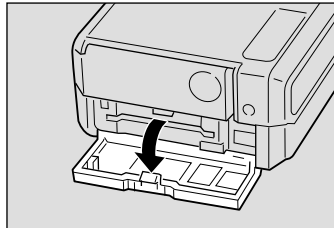

**① Make sure that the camera is turned off.**

**② Open the card door and insert a SmartMedia memory card.**

- Before using a new SmartMedia memory card, you must first format (initialize) it with the camera. (p.33)



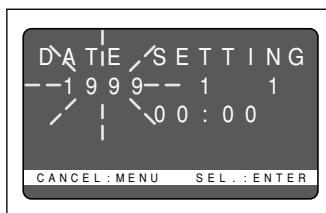
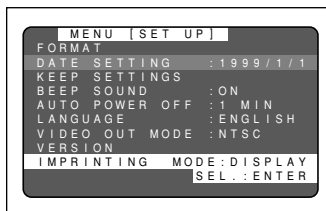

## Setting the Date and Time (p.35-37)

- 1 Slide the power switch and set the mode dial to [SET UP].
- 2 Press the  or  button to select [DATE SETTING].
- 3 Press the DISPLAY button to select the display method.
- 4 Press the ENTER button.
- 5 Press the  or  button to change the flashing digit.
- 6 Press the ENTER button.  
Repeat steps 5 and 6 above to complete the settings.  
\* Each time you press the ENTER button, the flashing digit changes, from year to month, day, hour and minute.
- 7 After you have set the number of minutes, press the ENTER button.



## Shooting

### Basic Shooting Procedure (p.40-51)

- 1 Slide the power switch and set the mode dial to [CAM].
- 2 Press the CARD/IN button to select where to record.
- 3 Press the PIC button to select a PIC (Image quality) mode.
- 4 Select a recording mode.
  - 1 Press the MENU button to display the record menu and select [RECORDING MODE].
  - 2 Press the ENTER button to select a recording mode and then press the MENU button to return to the original display.
- 5 Press the () or () button to select the desired size of the subject.  
\* Observe the position of the subject by looking through the viewfinder or at the LCD monitor.
- 6 Press the shutter release button to record the image.

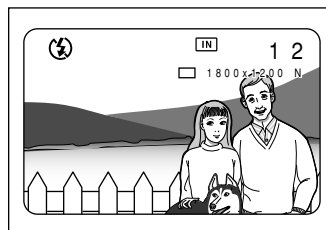
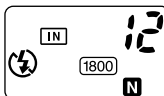
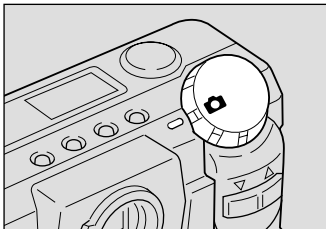

## Changing the Flash Mode (p.54-56)

- 1 Set the mode dial to [📷].
- 2 Press the flash mode button to select a flash mode.

You can choose Flash Off (🚫), Auto (⚡), Forced Flash (⚡), or Slow synchro mode (⚡).

The selected mark will be displayed on the LCD monitor or on the LCD panel.

- 3 Press the shutter release button to record the image.

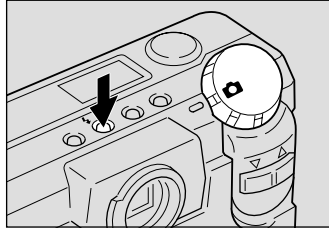
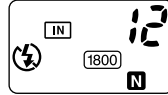

## Using the Self-Timer (p.61-62)

- 1 Set the mode dial to [📷].
- 2 Press the self timer button.

The self timer is now set.

The ⌚ mark will be displayed on the LCD monitor or on the LCD panel.

- 3 Press the shutter release button to record the image.

The self timer LED will start flashing and the shutter will be released after a delay of about 10 seconds.

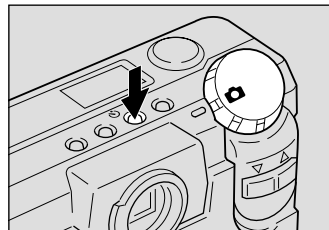
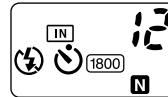

## Playback

### Playing Back Files (p.78-79)

- 1 Slide the power switch on and set the mode dial to [▶].
- 2 Press the CARD/IN button to select the playback destination.
- 3 Press the **◀** or **▶** button to select a file you wish to view

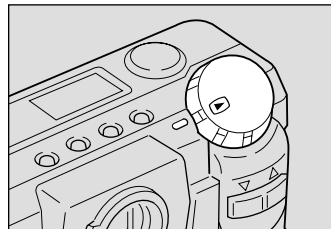

\* The multi-image and zoom playback features allow you to view several image files at once or magnify an image. (p.80, 81)





# Erasing



## Erasing Files (p.94-97)

- 1 Slide the power switch on and set the mode dial to [W].
- 2 Press the CARD/IN button to select the destination to be erased.
- 3 Press the  or  button to select the erase mode and press the ENTER button.

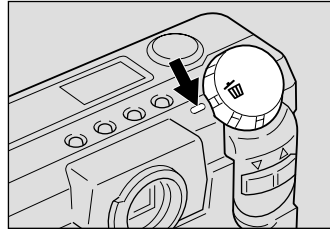
\* Remember that files cannot be restored once they are erased. Before starting to erase a file, make sure that you want to erase it.



If you selected [ERASE SINGLE IMAGE]

- 4 Press the  or  button to select a file you want to erase and press the shutter release button.

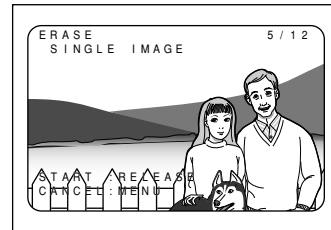



If you selected [ERASE ALL IMAGES]

- 4 Press the shutter release button.



If you selected [ERASE SELECTED IMAGES]

- 4 Press the  or  button to select a file you want to erase and press the ENTER button.

Repeat step 4, as needed, to erase additional files at a time. And press the ENTER button again to cancel the erasure setting.

- 5 Press the shutter release button.

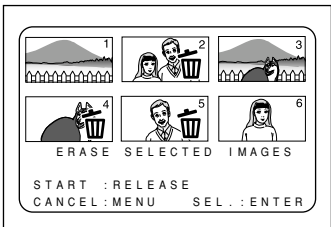



# GETTING STARTED Chapter

# 1

<b>Before Using the Camera .....</b>	<b>26</b>
<b>Checking the Package Contents .....</b>	<b>26</b>
<b>Attaching the Wrist Strap .....</b>	<b>26</b>
<b>Powering the Camera .....</b>	<b>27</b>
<b>Loading the AA Batteries .....</b>	<b>27</b>
<b>Using an AC Adapter .....</b>	<b>29</b>
<b>SmartMedia Memory Cards .....</b>	<b>31</b>
<b>What is a SmartMedia Memory Card? .....</b>	<b>31</b>
<b>Inserting a SmartMedia Memory Card .....</b>	<b>32</b>
<b>Formatting a SmartMedia Memory Card .....</b>	<b>33</b>
<b>Before You Start Recording .....</b>	<b>35</b>
<b>Setting the Date and Time .....</b>	<b>35</b>
<b>Adjusting the LCD Monitor Brightness .....</b>	<b>37</b>
<b>How to Hold the Camera .....</b>	<b>37</b>

# Before Using the Camera

## Checking the Package Contents

Check that your digital camera comes complete with all the accessories listed below. Read the warranty card and keep it in a safe place.

- Digital camera: ..... 1
- Video interface cable: ..... 1
- Soft case: ..... 1
- AA alkaline batteries: ..... 4
- Wrist strap: ..... 1
- Operation manual (this manual): ..... 1
- Warranty card: ..... 1
- PC connection cable (RS-232C) ..... 1
- Macintosh cable (AUX) ..... 1
- USB cable ..... 1
- Software CD-ROM ..... 1

## Attaching the Wrist Strap

Attach the wrist strap provided to prevent the camera from being dropped during use.

- 1 Pass the small loop of the strap through the wrist strap eyelet and pass the other end through the loop as illustrated.

**Important Note**

- Do not swing the camera around by its strap.

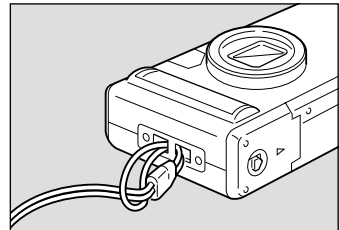

# Powering the Camera

This section explains how to load the batteries (AA alkaline batteries) into the camera and how to connect the AC adapter to power the camera from a household electrical outlet.

## Loading the AA Batteries

Mount AA batteries and operate the camera.



- If you use commercial batteries, use of rechargeable AA batteries (nickel-cadmium or nickel-metal-hydride batteries) is recommended.

### Rechargeable Batteries

- Before using commercially available rechargeable AA Ni-Cd or AA Ni-MH batteries, read the safety precautions in the accompanying manual.



- Use only the specified AA batteries.
- Never use batteries of an unrecommended type, such as manganese battery, as this could damage the camera or LCD monitor and cause them to fail.
- Certain types of batteries may become hot after an extended period of use. Allow them to cool before unloading them.
- Do not use commercially available batteries that are designed for specific kinds of equipment (such as those marked "For CD players only") in this product.
- When purchasing batteries, read the battery instructions carefully to make sure that they can be used for this product.
- Remove the batteries from the camera if you won't be using it for an extended period of time.

- 1 Check that the camera is turned off, and then open the battery cover by pressing the catch and sliding it in the direction shown.

**See** "Turning on the Camera" (p.41)

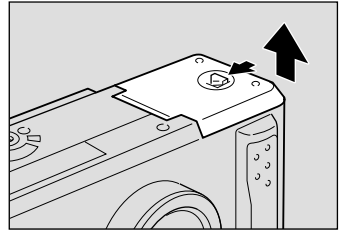

- 2 Load the batteries.



- Make sure that the batteries are loaded with the positive (+) and negative (-) terminals correctly oriented. Do not bring metallic objects, such as a needle, into contact with the battery contact surfaces or electrical connections. Electrostatic damage could result.

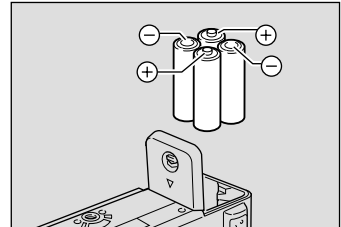

- 3 Close the battery cover

Close the battery cover until it clicks into position.

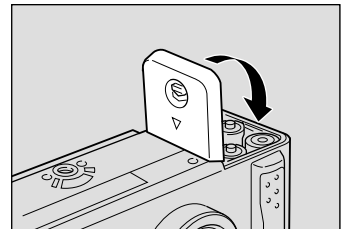

## ■ Economizing on Batteries

Use of rechargeable Size AA Ni-Cd or AA Ni-MH batteries is recommended for most applications.

If a power source is available nearby, you can economize on the batteries by using an AC adapter (optional).

In shooting pictures, having the LCD monitor display turned off will give your batteries longer life.

## ● Shooting and Playback Guidelines

The table below gives the approximate recording and playback times that are available with Size AA alkaline batteries, as measured under the following test conditions:

[Test conditions]

During shooting: Shoot continuously in a recording mode (shoot at an interval of 30 seconds, without turning off the camera in the middle, with the flash fired 50%, at a 25°C ambient temperature).

During playback: Leave the camera continuously turned on in a playback mode at a 25°C room temperature.

Battery type	Approximate Recording Time	Approximate Playback Time
Size AA alkaline batteries	60 minutes	90 minutes
Ni-Cd batteries (1000 mAh)	40 minutes	60 minutes

### Tips to Extend the Recording and Playback Times

- \* The battery lives indicated above may decrease depending on the ambient environment.
- \* In an extremely cold environment, warming the batteries by hand, for example, could allow you to take more pictures. Where the ambient temperature is extremely low, use of rechargeable Ni-Cd batteries is recommend for their cold resistance.
- \* Choose rechargeable batteries having as high a capacity as possible. (The capacity rating is marked in the unit mAh.)
- \* Increased use of the flash or zoom feature or the LCD monitor would speed up the exhaustion of the batteries. Reduce their usage to a minimum.
- \* The available picture count tends to increase when they are recorded in the 900 × 600 recording mode.
- \* Copying or erasing images repeatedly would also accelerate the exhaustion of the batteries.
- \* Wiping the contacts of the battery and camera body with a soft dry cloth can prolong battery life.



- You are advised to make spare batteries available when powering the camera from the internal batteries alone.
  - The battery symbol (⚡), when lit, indicates that the camera's internal batteries have a diminishing voltage. Be sure to have spare batteries on hand.
    - ( Rechargeable Size AA Ni-Cd and Ni-MH batteries have a tendency to shut off immediately when the battery symbol is lit. )
  - Do not use weak (exhausted) batteries (when ⚡ blinks, etc.) because this could result in camera misoperation (the LCD monitor, AF lamp, flash lamp and self-timer lamp blink or light).

## ■ Handling Precautions

- Do not use damaged batteries or batteries at the end of their service lives.
- Do not subject the batteries to strong impacts .

## Using an AC Adapter

When using the camera for extended periods of time to shoot or playback images, connect an AC adapter (optional) to the camera and power the camera from a household electrical source.

### Using the AC Adapter

Before using the AC adapter, be sure to read the safety precautions in the accompanying manual.

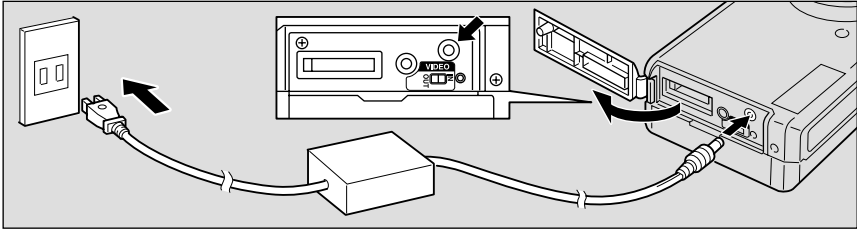

**1 Check that the camera is turned off, and then open the terminal cover.**

**See** “Turning on the Camera” (p.41)

**2 Connect the AC adapter cable to the power supply terminal (DC input) on the camera.**

**3 Insert the power plug into the electrical outlet.**

**Note**

- If batteries are loaded in the camera while it is connected to a household power source, the camera is powered from the AC source and not by the batteries.

**Important Note**

- Insert the power plug and connection cable securely. If the plug or cable works loose during recording, the data may be lost or damaged.
- If you connect or disconnect the AC adapter while operating the camera (recording, playback, or erasing), the camera will switch off to determine the power source. This may cause the data to be lost or damaged. To avoid this, connect or disconnect the AC adapter while the camera is turned off.



# SmartMedia Memory Cards

This section explains the types and usage of SmartMedia memory cards.

## What is a SmartMedia Memory Card?

Files are recorded as data on the SmartMedia memory card in your camera. The following types of SmartMedia memory card can be used:

- Capacity: ..... 2 MB, 4 MB, 8 MB, 16 MB, 32 MB, 64MB
- Operating voltage: .... 3.3 V

- Note**
- There are numerous types of SmartMedia memory cards. Before using a commercially available SmartMedia memory card, check with its manufacturer to be certain is compatible with your camera.
  - By using an optional PC card adapter or floppy disk adapter, you can insert a SmartMedia memory card directly into the PC card slot or floppy disk drive of your PC.

## ■ Protecting Against Accidental Writing

Attaching a write protect pad to a SmartMedia memory card will prevent accidental erasure or overwriting of recorded files.

Remove the write protect pad from the SmartMedia memory card to record or erase data.

- Note**
- If the write protect pad gets dirty, wipe it clean with a soft, dry cloth.

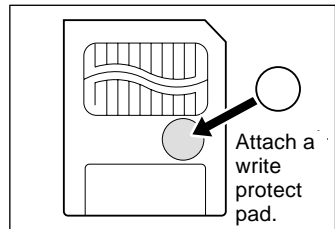

## ■ Handling Precautions

### ● SmartMedia Memory Cards

- Never remove the SmartMedia memory card while data is being recorded or erased.
- Do not bend, subject to strong force or shock, or drop the SmartMedia memory card.
- Avoid using or storing SmartMedia memory cards in environments that are subject to static electricity or electrical interference.
- Avoid using or storing SmartMedia memory cards in environments that are subject to high temperature and humidity, where dust accumulates, or in atmospheres where corrosive substances are present.
- Keep the contact surface of the SmartMedia memory card clean and free from dust and foreign matter. Should the contact surface get dirty, wipe it clean with a soft, dry cloth.

- Keep the SmartMedia memory card slot free from dust and foreign matter.
- To avoid possible hazards, keep SmartMedia memory cards away from flames and do not dispose of them in fire.
- SmartMedia memory cards have a limited service life. Cards that have been used over an extended period of time may fail to record additional files.

### ● Data

- Data recorded on a SmartMedia memory card may be lost by improper handling by the customer or a third party, by being subjected to electricity or electrical interference, or during camera malfunction or repair. Ricoh Co., Ltd. assumes no liability for damages incurred by such loss of recorded data.
- Do not remove the batteries from the camera, turn off the camera, or connect the AC adapter while data is being recorded on the SmartMedia memory card. The data stored on the SmartMedia memory card could be lost or damaged.
- You are advised to copy valuable data from the SmartMedia memory card onto other media, such as floppy disks or hard disks.

## Inserting a SmartMedia Memory Card

Check that the camera is turned off before inserting the SmartMedia memory card.



- Slide the power switch to turn the power off before inserting or ejecting smart media; otherwise, the contents of the smart media may be destroyed and the camera may malfunction.

### ■ Inserting Card

- 1 Check that the camera is turned off, and then open the card door.

**See** "Turning on the Camera" (p.41)

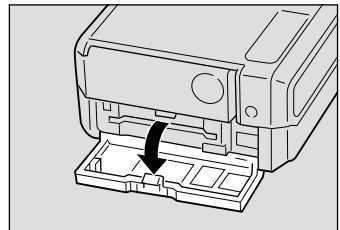

- 2 Insert the SmartMedia memory card into the card insert slot and close the card door.

Push the SmartMedia memory card fully into position, with the contact surface facing up.

Contact surface

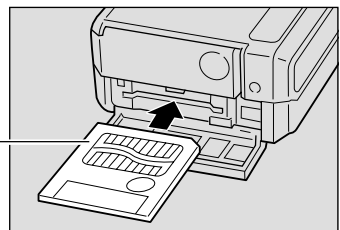



- Insert the SmartMedia memory card in the correct direction. Do not insert it at an angle.
- The camera will not turn on when the card door is open.

## ■ Removing Card

- 1 Check that the camera is turned off, and then open the card door.



“Turning on the Camera” (p.41)

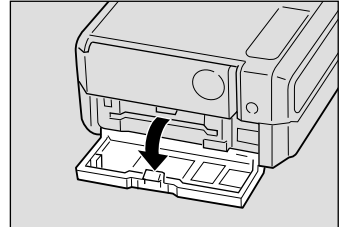

- 2 Press the button and pull the SmartMedia memory card straight out of the slot.

Pressing the button will cause the SmartMedia memory card to pop out a little. Then, pull it straight out of position.

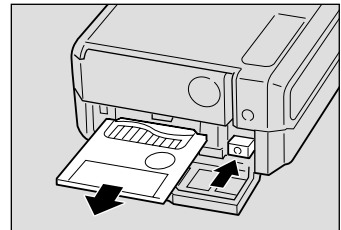

- 3 Close the card door.



- Never remove the SmartMedia memory card while data is being recorded or erased. The data stored on the card could be lost or damaged.
- When the SmartMedia memory card has been removed, place it in the antistatic case supplied or other protective cover.

## Formatting a SmartMedia Memory Card

Before using a new SmartMedia memory card or a SmartMedia memory card that has been used on another device (such as a PC), you need to format (initialize) it with the camera.



- Formatting will erase all the files recorded on the SmartMedia memory card (including protected files).
- Do not format SmartMedia memory cards on a PC.
- The SmartMedia formatted by other devices may not be used.

- 1 Insert the SmartMedia memory card and slide the power switch to turn on the camera.

**See** “Inserting a SmartMedia Memory Card” (p.32)  
“Turning On the Camera” (p.41)

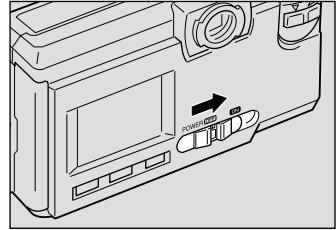

- 2 Set the mode dial to [SETUP].  
The setup menu will be displayed.

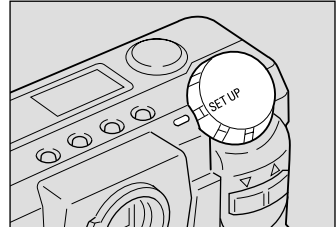

- 3 Press the **or** button to select [FORMAT] and press the ENTER button.

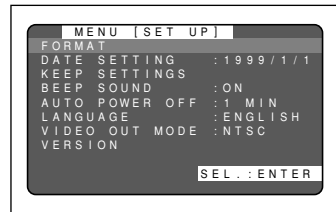

- 4 Press the **or** button to select [FORMAT MEMORY CARD] and press the ENTER button.

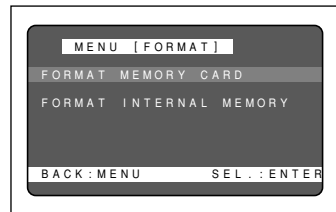

- 5 Press the shutter release button.  
The “FORMATTING” message is displayed while the camera is formatting the SmartMedia memory card.

When formatting is completed, the setup menu will reappear. Turn the mode dial to choose another mode.

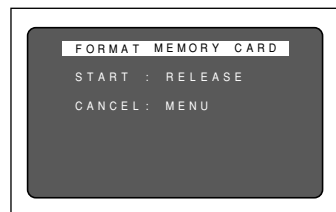

**Note** • A SmartMedia memory card with a write protect pad attached to it cannot be formatted. Remove the pad to format the SmartMedia memory card.

# Before You Start Recording

This section explains the initial camera adjustments and pointers you should know before starting to record pictures.

## Setting the Date and Time

The date and time are recorded when you shoot a picture. You will need to adjust these settings when you first use the camera and each time you change time zones on trips.

- Note**
- Use the yy/mm/dd format to set the date.
  - Time is displayed in the 24-hour clock format. Midnight is expressed as 00:00 and noon as 12:00.

**1** Slide the center button of power switch to turn on the camera.

- See** "Turning On the Camera" (p.41)

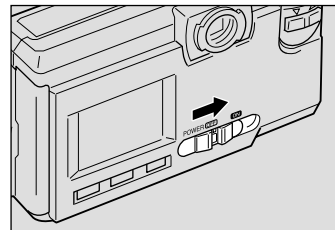

**2** Set the mode dial to [SETUP].

The setup menu is displayed.

- Note**
- To cancel the operation, turn the mode dial to another mode.

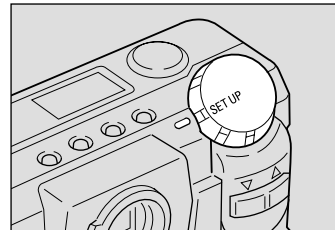

**3** Press the **or** button to select [DATE SETTING].

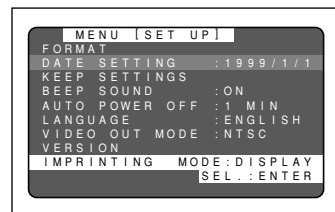

**4 Press the DISPLAY button to select the date display method.**

There are three methods available to display the date as follows:

1999/5/15 → May 15 1999 → 15 May 1999

Each time you press the DISPLAY button, the display method is switched from one position to the next in the sequence shown above. Press the DISPLAY button to select the desired date display method.

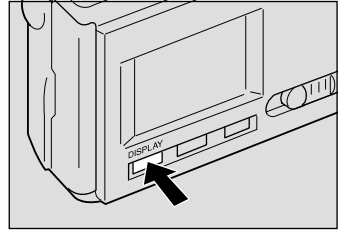

**5 Press the ENTER button.**

The date setting menu is displayed.

- Note** • To cancel the operation and return to the setup menu, press the MENU button.

**6 Press the  $\uparrow$  and  $\downarrow$  buttons to change the blinking numeral.**

Pressing the up ( $\uparrow$ ) button increments the numeral; pressing the down ( $\downarrow$ ) button decrements the numeral. Keep pressing the button changes the digit fast.

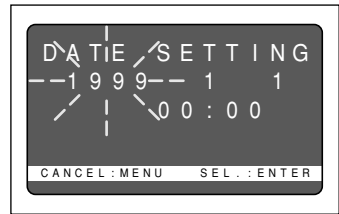

**7 Press the ENTER button to flash the digit you want changed.**

Repeat steps 6 and 7 above to make necessary corrections.

- Note** • Each time you press the ENTER button, the flashing digit changes, from year to month, day, hour and minute.
- Press the MENU button to cancel the operation.

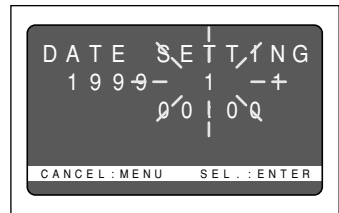

**8 After you have set the number of minutes, press the ENTER button again.**

The clock gets started and the LCD monitor returns to the SET UP menu. Turn the mode dial to select another mode.

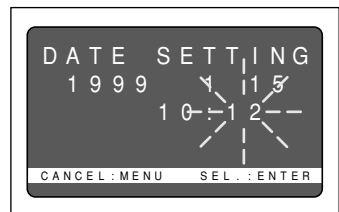

**Note**

- You can set the time correctly by pressing the ENTER button at the same time as a time signal sounds.
- The date and time settings are reset if the battery has been removed for about 3 minutes or longer, as at replacement. Set the date and time again.

**Tips****How to Verify the Date and Time**

Press the ENTER button to view the date and time settings in the LCD monitor for verification. See “LCD Monitor Display Function” (p.51).

## Adjusting the LCD Monitor Brightness

You can adjust the brightness setting of the LCD monitor.

- 1 Turn the brightness adjustment dial on the bottom of the camera, left or right to adjust the LCD monitor brightness to a favorable setting for viewing.

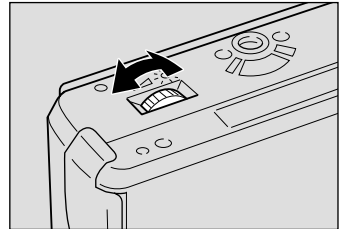

## How To Hold the Camera

Unintentional movement of the camera during shooting will result in blurred images. To keep the camera steady, hold the camera in the fashion prescribed below. Be particularly careful to keep the camera steady when taking telephoto zoom shots.

- 1 Hold the camera steady with both hands with the elbows lightly touching your body.
- When viewing through the viewfinder  
With the camera lightly pressed against your head, aim it at your subject and look through the viewfinder.



● **When viewing using the LCD monitor**

Hold the camera firmly in both hands, and aim it at your subject and look at the LCD monitor.

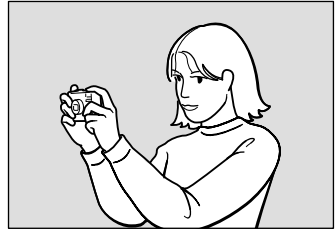

② **Press the shutter release button lightly with your fingertip.**

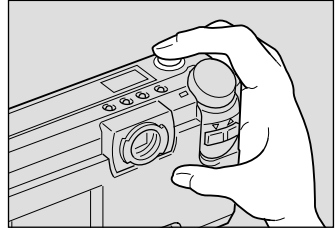

**Important Note**

- Pressing the shutter release button at once with the finger initially apart from it could result in a blurred image.

**Note**

- When an image of a subject that has been shot with the camera held in vertical position is played, the subject will appear sideways.

Be careful to keep the camera lens, flash, and the flash sensor reception window from being covered by your fingers or hair.

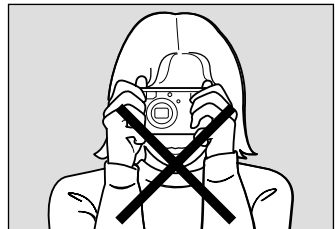



# BASIC SHOOTING Chapter

# 2

<b>Basic Shooting .....</b>	<b>40</b>
<b>Operation Flow .....</b>	<b>40</b>
<b>Turning on the Camera .....</b>	<b>41</b>
<b>Selecting IN/CARD (Internal memory/ SmartMedia memory card) Memory .....</b>	<b>42</b>
<b>Selecting PIC (Image quality) Mode .....</b>	<b>43</b>
<b>Selecting Recording Mode .....</b>	<b>44</b>
<b>Setting the Size of the Subject (Zoom) .....</b>	<b>46</b>
<b>How to View Images on the LCD Monitor .....</b>	<b>47</b>
<b>Shooting (Still Picture Mode) .....</b>	<b>48</b>

# Basic Shooting

This section explains the general flow of shooting operation, and provides basic shooting instructions.

## Operation Flow

To record an image, follow the steps below:

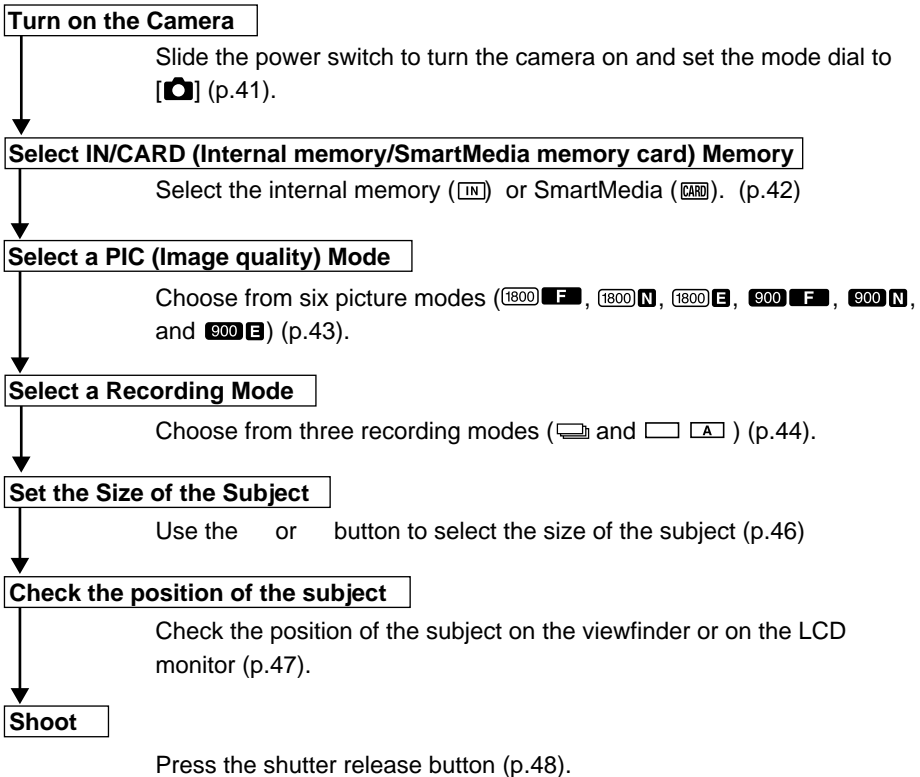

# Turning on the Camera

Slide the power switch to turn the camera on and slide the switch again to turn it off.

## 1 Slide the center button of power switch to on.

The camera will turn on and the monitor cover will open.



- The lens barrier will not open, even if the power switch is operated, when in a playback mode other than record or in the erase mode.
- Sliding the power switch again will turn off the power. And the lens barrier and monitor cover will open.

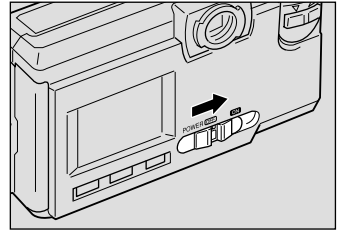

## 2 Set the mode dial to [CAMERA].

The LCD panel or the LCD monitor will display recording information.

### ● LCD Monitor Display

Press the DISPLAY button to switch displays appearing on the LCD monitor. If the LCD monitor is not used, press the DISPLAY button to save the batteries. Press the DISPLAY button again to enable the LCD monitor.

You may set the camera to come up with the LCD monitor disabled when it is powered on. See “Changing the LCD Setting” (p.109).

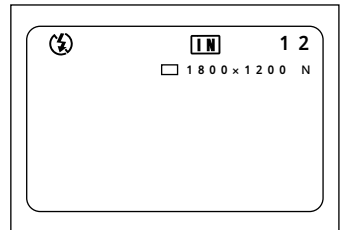
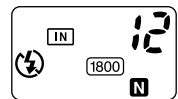
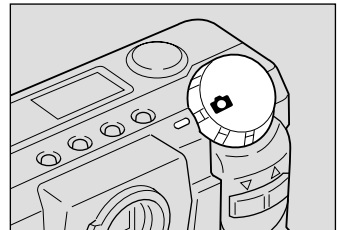

## ■ Using the DISPLAY button to turn the power on and off

The camera power can also be turned on and off by using the DISPLAY button. When the DISPLAY button is pressed for 2 sec. or more with the mode dial set to [CAMERA], the power will be turned on. Pressing the DISPLAY button again will turn the power off. Set the DISPLAY button beforehand. See “Using the DISPLAY Button to Turn the Power On and Off”. (p.112)



### Auto Power-Off

The camera will turn off automatically (auto power-off) to conserve the battery if it is left idle (no buttons, switches or other controls operated) for fixed time. To resume use, turn the power on again.

You can disable the auto power-off mode.

See “Auto Power Off Setting” (p.103).

\* The auto power-off mode does not function when the camera is powered by an AC adapter.



- If the keep settings function is enabled, the flash, exposure compensation, white balance, recording mode, date imprint, language, card/in, S mode settings, focus, soft mode and auto bracket in effect just before the camera was turned off are saved. See “Keep settings” (p.104).

## Selecting IN/CARD (Internal memory/SmartMedia memory card) Memory

Select whether to record photo files in internal memory or on the SmartMedia memory card mounted in the camera.

### Switching Modes

The mode screen changes in the following sequence as you switch the recording destination:

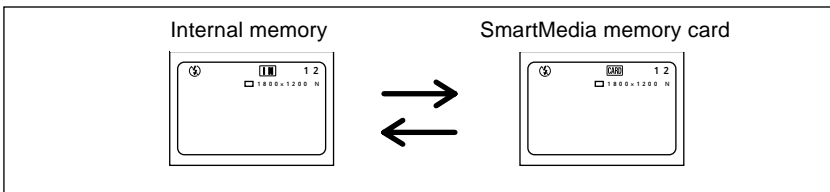

\* When the SmartMedia memory card is inserted, the **CARD** will be displayed.

### Selecting a Recording Destination

- 1 Press the **CARD/IN** button and select a recording destination (**IN** **CARD**).

The recording destination changes each time the **CARD/IN** button is pressed.

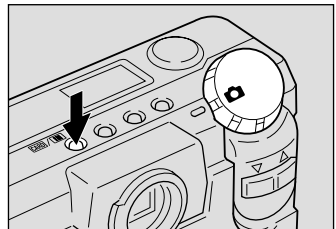

The selected destination will be displayed on the LCD monitor or on the LCD panel.

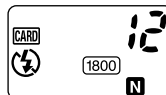

- Note** • If a SmartMedia memory card is mounted in the camera when it is turned on, the **CARD** mark appears on the LCD monitor or the LCD panel. Enable the save mode to set internal memory as a recording destination. See “Keep Settings” (p.104).

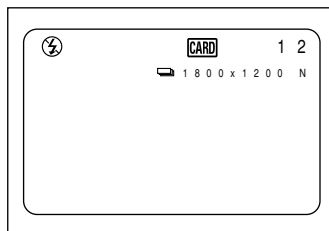

## Selecting PIC (Image quality) Mode

The camera offers six picture (PIC) modes – **1800 F** **1800 N** **1800 E** **900 F** **900 N** and **900 E** – to suit your photographic needs. Each mode has its own compression ratio.

### Switching PIC (Image quality) Modes

The mode screen changes in the following sequence as you switch the PIC mode:

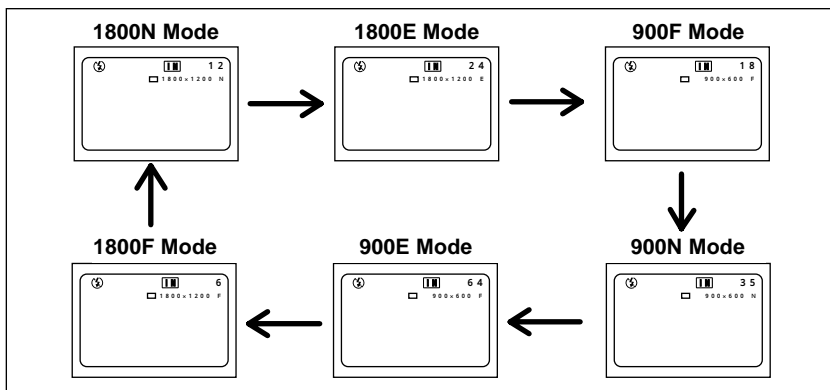

\* The recordable picture count varies as you switch the PIC mode.

\* The factory default setting is 1800 N (**1800 N**).

### Selecting a PIC (Image quality) Mode

- Press the PIC button and select a PIC (Image quality) mode (**1800 F** **1800 N** **1800 E** **900 F** **900 N** **900 E**).

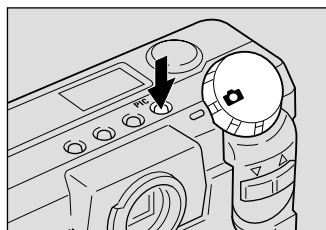

Pressing the PIC button displays the settings menu. The PIC (Image quality) mode changes each time the PIC button is pressed. Press the PIC button and make your choice.

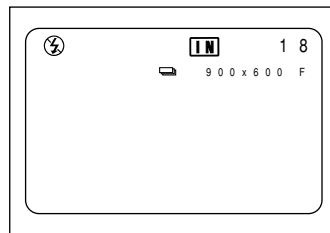
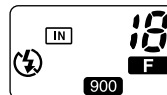

### ● Approximate File Sizes by PIC (Image quality) Mode

PIC Mode	Approx. File Size	PIC Mode	Approx. File Size
1800F	813 KB	900F	276 KB
1800N	410 KB	900N	141 KB
1800E	246 KB	900E	74 KB

- Note**
- Image sizes are 1792 × 1200 pixels and 896 × 600 pixels.
  - For the number of recordable images by SmartMedia memory card capacity and by PIC (Image quality) mode, see "Recording Capacities" (p.129).

## Selecting Recording Mode

The camera offers three recording modes – still, text and High Speed Shooting. Select the mode best suited to your photographic needs.

### ■ Switching Recording Modes

The mode screen changes in the following sequence as you switch the recording mode:

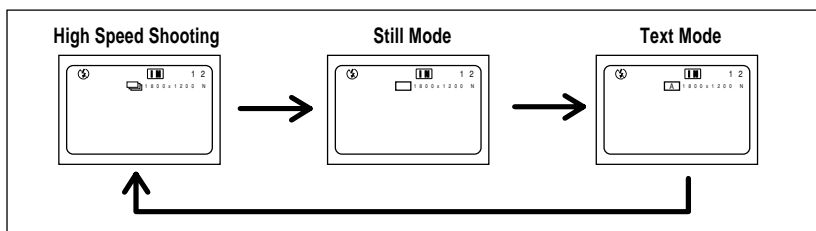

- Note**
- The factory default setting is .

### ● Quick shooting mode

A series of frames can be taken continuously at the rate of approximately 1 frame/sec. as long as the release button is pressed. Since the images are stored in the camera memory, the interval at which frames can be taken is shorter, so the next frame can be taken faster.

### ● Still image mode

One frame is taken each time the release button is pressed. The frames are stored one at a time.

### ● Text mode

Text can also be stored to memory. To record text clearly, blacks are made very black and then the surrounding colors are sensed. The frames are stored one at a time.

- Note** • Set Keep Setting to save the recording mode setting.  
See "Keep Settings". (p.104)

## ■ Selecting a Recording Mode (for the PIC mode)

This mode is used to record an image.

### ① Set the mode dial to [CAM] and press the MENU button.

The record menu will be displayed.

- Note** • To cancel an operation, press the MENU button.

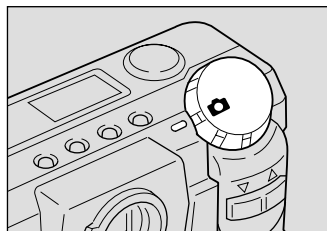

### ② Press the or button to select [RECORDING MODE].

### ③ Press the ENTER button to choose the recording mode ( • • ).

The recording mode changes each time you press the ENTER button.

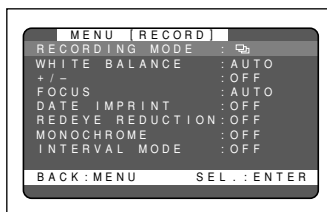

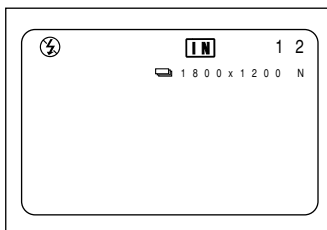

### ④ Press the MENU button to close the record menu.

The selected record mode will be displayed on the LCD monitor.



# Setting the Size of the Subject (Zoom)

By pressing the  or  button, you can vary the size of the subject on the LCD monitor without changing the distance between yourself and the subject (equivalent to 38 — 114 mm in 35 mm camera format).

## ■ Zooming In (Telephoto Setting)

### ① Press the button.

The subject will become larger (telephoto) and the zoom indication bar will appear on the LCD monitor. Press the  button to adjust the subject size to your liking.

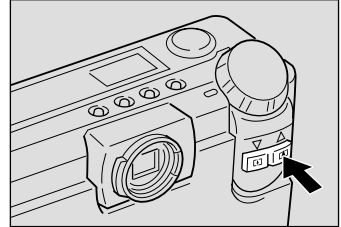

## ■ Zooming Out (Wide Angle Setting)

### ① Press the button.

The subject will become smaller (wide) and the zoom indication bar will appear on the LCD monitor. Press the  button to adjust the subject size to your liking.

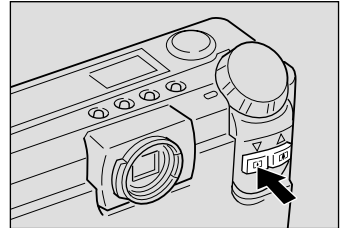

## ■ Digital Zoom Function

If you keep the  button for at least 2 seconds when the lens is set at the maximum telephoto position, the digital zoom function is triggered to add an enhanced telephotographic effect to your shot.

To disable the digital zoom function, press the  button.

When shooting, a frame appears on the LCD monitor as shown on the right, delineating the scope of the digital zoom. At playback, the shot will be played back in the same way as a normal shot.

Keep the button pressed for 2 seconds or more

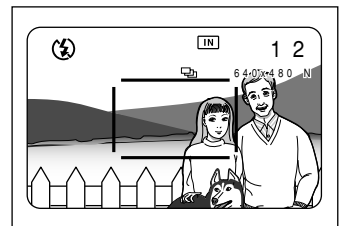
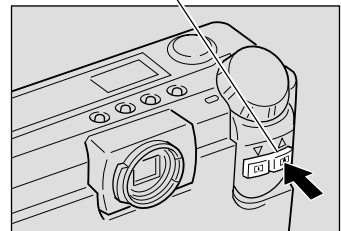

- Only the screen which is displayed on the LCD monitor is available. Press the DISPLAY button to display the screen.
- When the digital zoom function is enabled, shots taken will be recorded in 640 × 480 pixel format.



# How to View Images on the LCD Monitor

Check the position of your subject by looking through the viewfinder or at the LCD monitor.

## ■ Viewing Through the Viewfinder

Aim the camera at the subject while viewing through the viewfinder.

### ● Shooting Scope

Frame the subject within the viewfinder.



### ● Short-Distance Correction Frame

Compose your subject within this range when the distance to it is about 0.4 m (1.3 ft) and you are using the lens.



### ● Autofocus Field

Located at the center of the viewfinder screen and roughly corresponding to the area shown on the right, the autofocus field determines the focal distance.

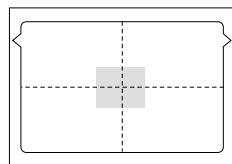

## ■ Viewing Through the LCD Monitor

Aim the camera at the subject while viewing through the LCD monitor.

### ● Shooting Scope

Frame the subject within the LCD monitor screen.



### ● Autofocus Field

Located at the center of the LCD monitor screen and roughly corresponding to the area shown on the right, the autofocus field determines the focal distance.

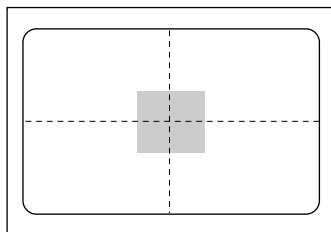

- The shaded area and dotted lines are shown for illustration purposes only and do not actually appear on the LCD monitor.

# Shooting (Still Picture Mode)

Basic shooting instructions are given below. Hold the camera correctly to keep it steady.

## 1 Aim the camera at your subject.

Set the wide angle and use macro mode to shoot subjects closer than 40 cm (15.8 inches).

**See** "Macro Shooting (Close-up Shooting)" (p.73)

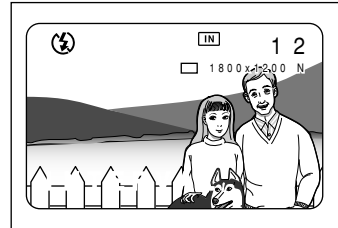

## 2 Press the or button to set the size of the subject.

**See** "Setting the Size of the Subject (Zoom)" (p.46)  
"How to View Images on the LCD Monitor" (p.47)

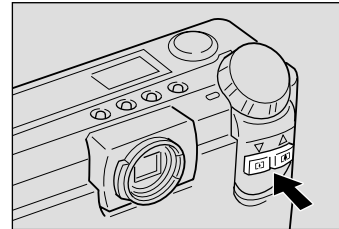

## 3 Press the shutter release button lightly with your fingertip.

The shutter release button works in a two-step action. When you press it lightly (halfway), the autofocus function is triggered to focus on the subject automatically. Keep the camera as steady as possible during this step to ensure correct focusing.

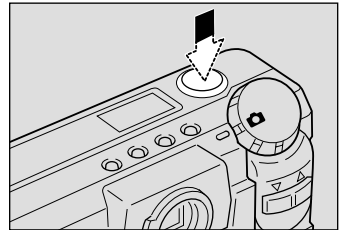

The AF indication LED (green) will light when the subject is in focus. The focus, exposure and white balance settings are set at this point.

### ● When the flash lamp lights

When the flash fires while taking photographs in dark places, etc., the flash lamp will light red when the release button is pressed lightly. During charging, the flash lamp will blink and the display on the LCD monitor will disappear. Photographs cannot be taken at this time.

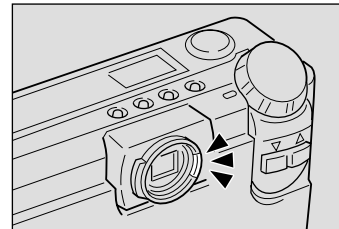

- A flashing AF indication LED indicates that the subject is out of focus. If this occurs, use the focus lock function. See “Focus Lock Shooting” (p.62).
- If the “SLOW SHUTTER” message appears on the LCD monitor, you are recommended to shoot with the flash enabled or in S mode to avoid camera shake that tends to occur in this situation. See “Changing Flash Modes” (p.55) and “S Mode (Shutter Speed)” (p.71).

#### 4 Press the shutter release button down fully without removing your finger.

A beep will sound and the picture will be taken.

- If the camera is moved before the buzzer sounds, blurring may occur.
- If recording fails, the buzzer will produce a beeping sound. In such cases, take the photograph again.

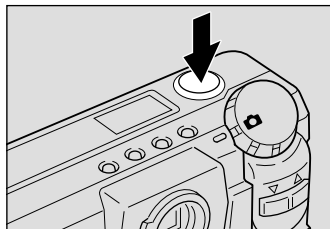

#### ● Quick shooting mode [ ]

As long as the release button is pressed, frames will be photographed at the rate of approximately one frame per second. The photographed images are temporarily saved to the memory inside the camera and are then recorded when picture taking is completed.

Picture taking stops when the finger is removed from the release button. The images photographed up to that point are temporarily saved to the memory inside the camera. When the release button is again pressed, the remaining frames will be exposed. The images stored inside the camera are recorded when the following occur.

- When the MENU button, PIC button or CARD/IN button is pressed
- When the mode dial is rotated
- When the power is turned off (AF lamp and flash lamp blinking)  
When there is no operation for 30 sec. after an exposure is made
- When the number of frames remaining is zero (0)/when all frames have been exposed
- When the [ ] mark appears on the LCD monitor

#### ● Still frame mode [ ]/text mode [ ]

When the release button is fully pressed, a photograph is taken and recorded. When set for the image to appear on the LCD monitor, the image will first be displayed and then recorded. Recording can be started immediately by pressing the or button. See “Changing LCD Confirmation”.

While the image is being displayed on the LCD monitor, recording can be canceled by pressing the MENU button. Messages are displayed during recording, so press the ENTER button.

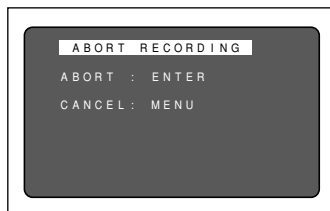



- Do not open the battery cover or card cover, or disconnect the AC adapter, while images are stored to the internal memory of the camera or while images are being recorded.

- Turning the power on and off, rotating the mode dial or changing the image quality sometimes increases the number of frames remaining.
- The flash does not fire in the Text mode.
- Depending on the image quality mode, the maximum number of frames that can be exposed continuously in the Quick shooting mode is as follows.

Recording mode	F mode	N mode	E mode
1800 × 1200	3 frames	5 frames	8 frames
900 × 600	7 frames	14 frames	29 frames

\* This is the maximum number of frames that can be exposed continuously at one time. Photographs can be taken continuously depending on the number of frames remaining in the smart media and built-in memory.

- The continuous mode cannot be used when the total number of file names reaches 9999. Format the smart media or the built-in memory before attempting to take more photographs.



### Using the Camera for Extended Periods of Time

The camera will switch off automatically (auto power-off) to conserve the battery if it is left idle (no buttons, switches or other controls operated) for fixed time. When you require more time to compose a shot, disable the auto power-off feature. Have spare batteries or an AC adapter handy before using the camera for an extended period of time. See “Auto Power Off Setting” (p.103).

## ■ When Focusing is Difficult

You may experience difficulty focusing on the following subjects:

- Objects with little or no contrast (such as the sky, white walls, and car hoods)
- Flat two-dimensional objects with only horizontal lines and no significant protrusions or indentations
- Fast-moving targets
- Low-brightness objects (in dark places)
- Strongly backlit objects and objects struck by strong reflected light
- Flickering objects (such as fluorescent lights)

When shooting subjects like these, focus on another subject that is located at about the same distance and then aim at the target with that focus setting.



“Focus Lock Shooting” (p.62). “Focus Mode Shooting” (p.63).



## LCD Monitor Display Function

Press the ENTER button to display recording information, such as the recording mode, picture mode, and recordable picture count, on the LCD monitor. Each time you press the ENTER button, the display will switch in the following order:

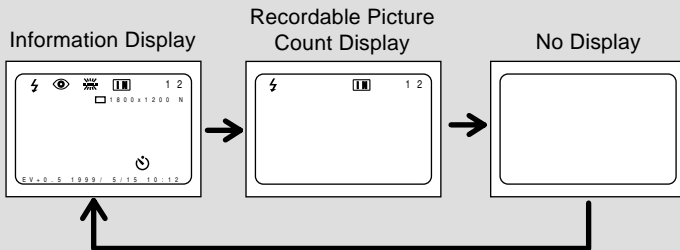



# ADVANCED SHOOTING Chapter

# 3

<b>Changing Flash Modes .....</b>	<b>54</b>
<b>Changing the flash mode .....</b>	<b>55</b>
<b>Setting the Exposure Compensation .....</b>	<b>57</b>
<b>Setting the Exposure Compensation .....</b>	<b>57</b>
<b>Changing the White Balance Mode .....</b>	<b>59</b>
<b>Changing the White Balance Mode .....</b>	<b>59</b>
<b>Special Shooting Functions .....</b>	<b>61</b>
<b>Using the Self-Timer .....</b>	<b>61</b>
<b>Focus Lock Shooting .....</b>	<b>62</b>
<b>Focus Mode Shooting .....</b>	<b>63</b>
<b>Date Imprint Mode .....</b>	<b>65</b>
<b>Redeye Reduction Mode .....</b>	<b>66</b>
<b>Monochrome Mode (Black &amp; White) Sepia ...</b>	<b>67</b>
<b>Interval (Time lapse) Shooting Mode .....</b>	<b>68</b>
<b>Using SOFT Mode .....</b>	<b>70</b>
<b>S Mode (Shutter Speed) .....</b>	<b>71</b>
<b>Using Auto Bracket .....</b>	<b>72</b>
<b>Macro Shooting (Close-up Shooting) .....</b>	<b>73</b>

# Changing Flash Modes

This section explains how to change the flash mode. Switch the flash mode to meet your photographic needs.

## ■ Flash Modes

The mode screen will change in the following sequence as you switch the flash mode:

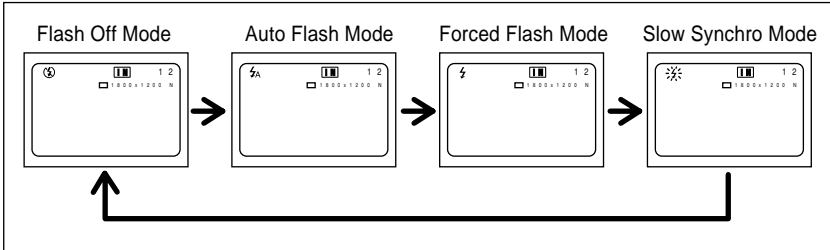

\* The factory default setting is flash off mode.

### ● Flash off mode

The flash will not fire, even in dark places. Use this mode in places where flash photography is prohibited and in bright indoor settings.

### ● Auto Flash mode

The flash will fire automatically in dark places and where there is backlighting.

### ● Forced Flash mode

Backlighting and strong light can produce dark shadows in photographs of the faces of subjects. Use this mode in such situations. The flash will always fire, regardless of the brightness.

### ● Slow synchro mode

The flash can be fired to illuminate the subject while a slow shutter speed correctly exposes the background. Use at indoor parties, etc., to clearly photograph the subjects while avoiding a dark background.

### Effective Range of the Flash

When you shoot with the flash activated, the flash has an effective range of about 0.4 to 3.0 m (1.3 ft to 9.9 ft) for the telephoto setting and 0.4 to 3.4 m (1.3 ft to 11.2 ft) for the wide-angle setting. The subject will appear dark in the picture if the light from the flash fails to reach it.



# Changing the flash mode

1 Set the Mode dial to [📷].

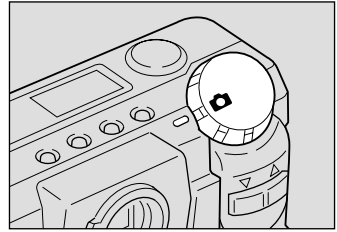

2 Press the Flash button to select the flash mode (🔼 • 🔼<sub>A</sub> • 🔼 Light • 🔼 Blink).

The flash mode will change each time the Flash mode button is pressed.

The flash mode will be displayed on the LCD panel and LCD monitor. In the Auto Flash mode, however, the 🔼<sub>A</sub> mark will be displayed only on the LCD monitor. This mark will not be displayed on the LCD panel.

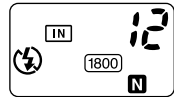
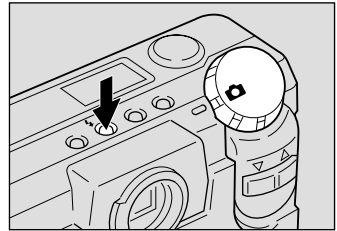

3 Press the release button to take the photograph.

**Note**

- When the flash fires, the flash lamp (red) will light when the release button is pressed lightly.
- When the flash is being recharged, the flash lamp will flash and the display will disappear from the LCD monitor. Photographs cannot be taken at this time.

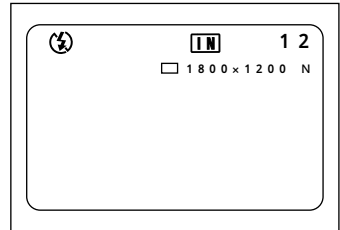

## How to Cancel a mode

Press the Flash button and switch to another mode.



- When using the flash for nearby subjects (approx. 0.4m (16 inches) or less), the light from the flash may appear to be reddish in some cases. This also causes overexposure so the subject may appear whitish in the photograph. At such times, select the No Flash mode.
- The shutter speed will automatically become slower in dark places. In such cases, either grip the camera firmly or mount the camera on a tripod to prevent hand jitter. Exercise special care when using Tele .



#### Using external flash

Recommended product: TOCAD COMPANY LIMITED

“SUNPAK Auto 544 (USA)”

“SUNPAK G4500 (Europe and Asia)”

#### Usage and connection cautions

- Exposure is determined by the external flash setting. Camera exposure compensation settings have no effect.
- Flash output is determined by the external flash setting. Photographed images can be checked using the LCD monitor. If exposure is incorrect, adjust the F value of the external flash and re-photograph.
- When the external flash is on, it will fire regardless of the flash mode to which the camera is set.
- When the Quick shooting mode is used, continuous photography may not be possible when the flash is charging and under certain photographic conditions.
- It is recommended that the camera flash be used for close-up photography.
- Clip-on type flashes cannot be connected. Use a flash that can be attached using the tripod socket. Do not apply excessive force when connecting.
- When connecting an external flash, adjust the end of the sync plug so that it can be firmly connected.

# Setting the Exposure Compensation

As long as the subject is centered in the shooting range, you can take the picture normally as the camera will automatically adjust the exposure compensation for backlighting. If there is a significant difference in brightness between the background and subject, however, the subject tends to be under- or over-exposed. Exposure compensation is useful in this situation. You can also use exposure compensation to produce intentionally under- or over-exposed images.

## ● Exposure Compensation Range

±2.0 EV (in 0.5 EV steps)

## ● Shooting Against the Light

The bright background will make the subject appear under-exposed. Set the exposure compensation level to a positive value to adjust the exposure.



- If the subject is not centered in the shooting range when taking a picture against the light, the camera will not assume that the subject is in a backlit state. Exposure compensation is required in this situation.

## ● Shooting a White Image

If you shoot an image that appears generally white, the shot will be under-exposed as a whole, with people appearing dark and white objects appearing gray. Set the exposure compensation level to a positive (+) value to adjust the exposure.

## ● Shooting a Black Image

If you shoot an image that appears generally black, the shot will be over-exposed as a whole, with people appearing white and black objects appearing gray. Set the exposure compensation level to a negative (-) value to adjust the exposure. Follow the same procedure when shooting a person under a spotlight, for example.

## Setting the Exposure Compensation

Set the exposure compensation level.

### ① Set the mode dial to [📷] and press the MENU button.

The record menu will be displayed.



- To cancel the operation, press the MENU button.

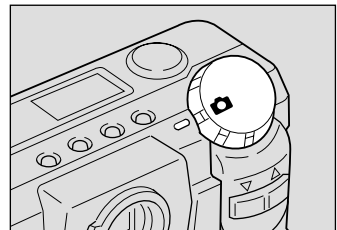



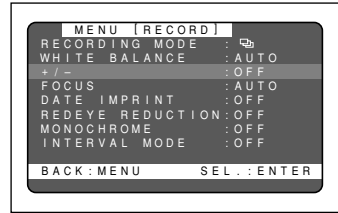

**2 Press the  or  button to select +/- [Exposure Compensation] and press the ENTER button.**

The exposure compensation settings menu will be displayed.

- Note** • To cancel the operation and return to the record menu, press the MENU button.



**3 Press the  or  button to change the compensation level.**

Pressing the () button increments the number of frames. Pressing the () button decrements the number of frames. Keep the button depressed to quickly scroll through the frames.

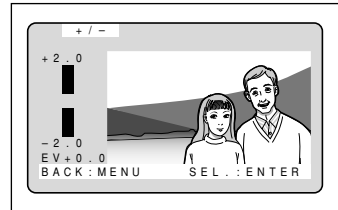

**4 Press the shutter release button to shoot the subject.**

When you press the shutter release button lightly (halfway), the LCD monitor switches to a normal display. Press down the shutter release button fully to shoot the subject.

When the shooting ends, the setup menu is displayed again on the LCD monitor. To accept the new adjustment level, press the ENTER button; to cancel it, press the MENU button to return to the record menu. Then, press the menu button once again to exit the record menu.

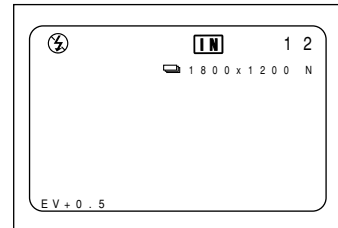

**How To Cancel the Exposure Compensation Setting**

Follow the above procedures and set the compensation level to [±0.0] in step **3**.

- Note** • To save the exposure compensation setting, set Keep Setting mode. See "Keep Settings". (p.104)
- Three frames will be exposed continuously: one at the exposure compensation value, one at -0.5EV and one at +0.5EV. This function is convenient for checking the exposure compensation value setting. See "Using Auto Bracket". (p.72)

# Changing the White Balance Mode

The white balance mode adjusts the white balance so that you can capture your subject in its natural colors regardless of the light source. The auto mode will suffice in most situations.

The auto mode automatically adjusts the white balance based on the white areas, ensuring that white is reproduced as white regardless of the light source.

Consequently, a subject that lacks in white tones as a whole or that is dominated by dark tones may not achieve an appropriate white balance. Change the white balance mode to shoot such subjects.

## ■ Switching White Balance Modes

The mode screen will change in the following sequence as you switch the white balance mode:

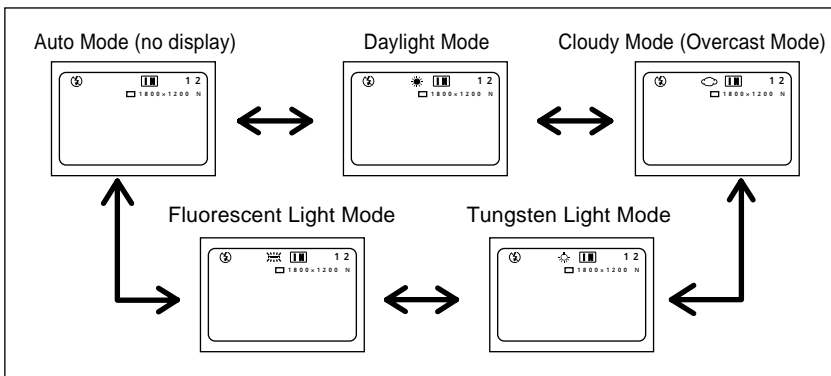

\* The factory default setting is auto mode.

### Subjects Difficult to Correct in Auto Mode

- Monochrome objects
- Objects lit by multiple light sources

3

Advanced Shooting



## Changing the White Balance Mode

- 1 Set the mode dial to [M] and press the MENU button.

The record menu will be displayed.

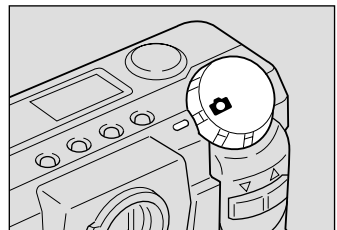
- Note** • To cancel the operation, press the MENU button.







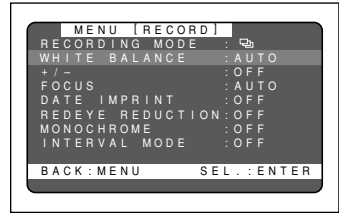

**2 Press the  or  button to select [WHITE BALANCE] and press the ENTER button.**

The setup menu will be displayed.

- Note** • To cancel the operation, press the MENU button to return to the record menu.



**3 Press the  and  buttons to select the white balance mode (   ).**

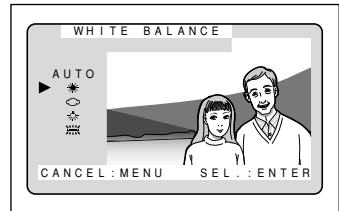

**4 Press the release button to take the photograph.**

When the release button is pressed halfway, the normal display will appear. Fully press the release button to take the photograph.

When picture taking is completed, the setup menu will return.

To check the mode setting, press the ENTER button to end operation. To cancel, press the MENU button to return to the recording menu and then press the MENU button again to exit the recording menu.

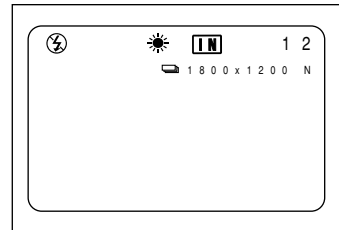

- Important Note** • Even with the same subject, colors may vary due to the weather conditions and light source.

### How to cancel the mode

Perform the same operations and use step **3** to select Auto white balance.

- Note** • In auto mode, subjects lacking in white tones may not achieve an appropriate white balance. When shooting such subjects, add a white object to the composition.
- White balance modes can only be set in recording mode and not in playback mode.
  - The flash will not fire in the following white balance modes: daylight, fluorescent light, tungsten light and cloudy (overcast) mode.
  - Enable the keep settings mode to save the white balance mode setting.

# Special Shooting Functions

This digital camera offers a variety of shooting techniques in addition to basic photography.

## Using the Self-Timer

The self-timer offers a convenient way to take group pictures with the photographer included. Mount the camera on a tripod or a flat, secure surface to shoot pictures with the self-timer.

### 1 Set the mode dial to [📷] and press the self timer button.

The self timer is now set.

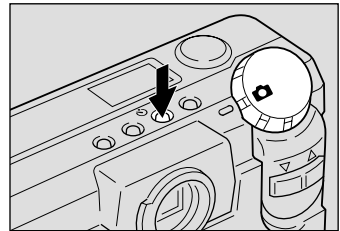

The self timer will be displayed on the LCD monitor or on the LCD panel.

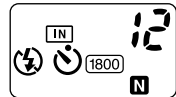

#### How to cancel the mode

Either press the selftimer button again or slide the power switch.

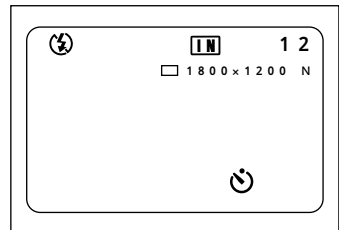

### 2 Decide the composition of the picture, position the camera securely, and press the shutter release button.

The self timer LED will start flashing and the shutter will be released with an approximate delay of 10 seconds. The self timer LED will stay lit for about 2 seconds before the shutter is released and the beep sound will be heard. The self-timer mode ends automatically when the shutter is released.

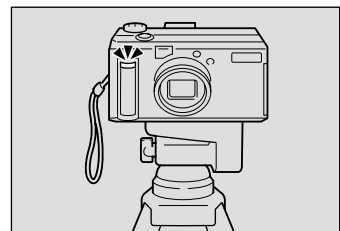

- Note**
- If the flash is charging, the self-timer will start when charging is completed.
  - When the release button is pressed, the focus is locked.



## Remote Control

To operate the camera from a remote position or when the camera is fixed in one spot, use the optional remote control unit.

## Focus Lock Shooting

Usually, the auto focus function focuses the camera on the subject that appears in the autofocus field on the LCD monitor or on the viewfinder. If the subject is located outside the autofocus field, it may appear blurred in the resulting shot. Use the focus lock to ensure accurate focusing on the subject.



“How to View Images on the LCD Monitor” (p.47)

### ■ When to Use the Focus Lock

If the subject is not positioned inside the autofocus field on the LCD monitor, a blurred image will result, since the background, not the subject, is in focus.

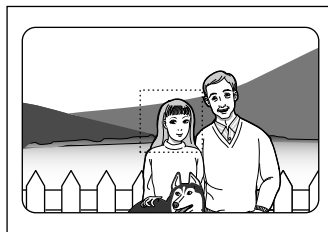

If an object other than the subject occupies a major portion of the autofocus field, the camera will focus on the background, producing a blurred image of the people.

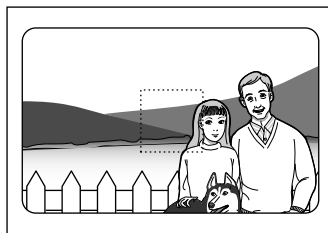

### ■ How to Use the Focus Lock

- 1 Press the **([↑])** or **([▲])** button to set the size of your subject.

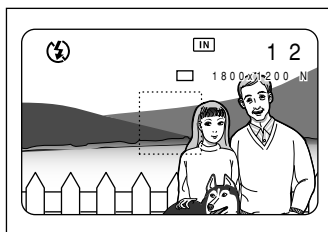



- ② Bring the subject on which you wish to focus into the autofocus field.

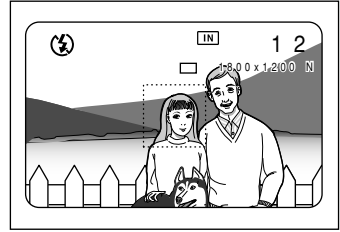

- ③ Press the shutter release button lightly and hold it.

The focus will be locked at this point.

The focus lamp (green) will light.

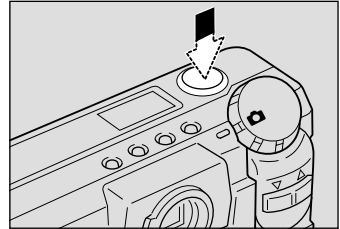

- ④ Decide the composition of the shot by moving the camera with the shutter release button held, and then press the shutter release button down fully.

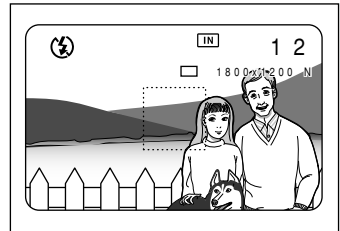

**Note**

- You can also use the manual focus to focus on the subject. See “Focus Mode Shooting” (p.63).

3

Advanced Shooting

## Focus Mode Shooting

This camera is capable of three types of focus (AF, MF, SP 🌸). Focusing can thus be performed for snapshots, landscapes, etc., in accordance with the photographic conditions.

AF: Focusing is performed automatically.

MF: Focusing is performed manually.

SP 🌸: Used to photograph subjects at larger than life size with normal macro photography using wideangle (in-focus (subject) distance = approx. 4.0cm - 40cm).

- 1 Set the **MODE** dial to [📷] and then press the **MENU** button.

The Recording menu will appear.

- Note** • Press the **MENU** button to cancel the operation.

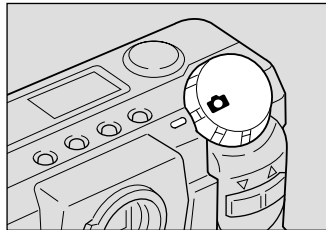

- 2 Press the **up** or **down** button to select **FOCUS**.

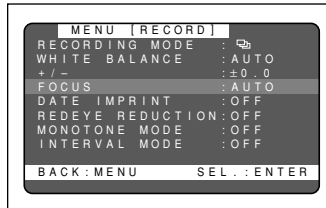

- 3 Press the **ENTER** button to select the type of focus (**MF**, **SP** (👁)) and then press the **MENU** button.

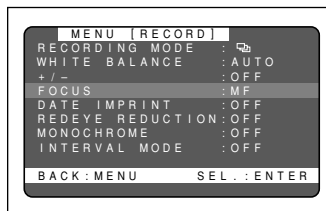

- 4 To make the subject appear larger, press the **up** (⬆) or **down** (⬇) button. In the case of **MF**, press the **release** button lightly. (Use is not possible with **SP** (👁)).

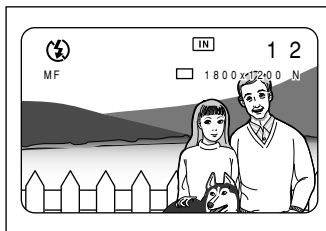

- 5 Press the **release** button to take the picture.

In the case of **MF**, use the **up** or **down** button to focus and then press the **release** button to take the picture.

### How To Cancel Focus Modes

Follow the above procedures and select **AF** in step 3.

- Note** • Enable the keep settings to save the Focus mode setting. See Keep Settings.
- When the **AF** focusing mode is used to photograph in dark locations, the auto focus lamp and focus display (**SP** (👁)) on the LCD monitor will blink and focus will be locked in the blinking mode. Either use the scale to set the distance to the subject or focus manually.

# Date Imprint Mode

Use this mode to record images imprinted with the date.



- If the date is not set in the setup menu, this function is not available. The date is displayed in the format that has been selected with the DATE SETTING option in the setup menu. See “Setting the Date and Time” (p.35).

## 1 Set the mode dial to [📷] and press the MENU button.

The record menu is displayed.



- To cancel the operation, press the MENU button.

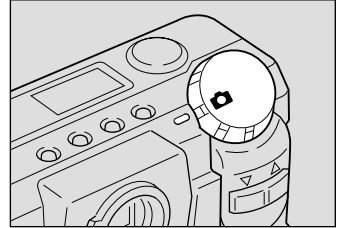

## 2 Press the or button to select [DATE IMPRINT].

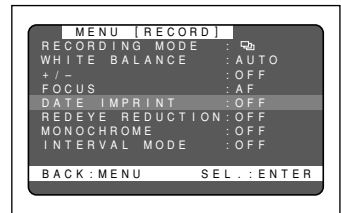

## 3 Press the ENTER button to select between [DATE] and [DATE/TIME]. And then press the MENU button.

The date (1999/5/15) is displayed if you have chosen [DATE], or the date and time (1999/5/15 10:12) is displayed if you have chosen [DATE/TIME].

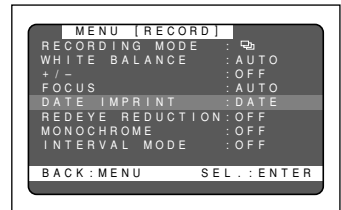

## 4 Press the shutter release button to shoot the subject.

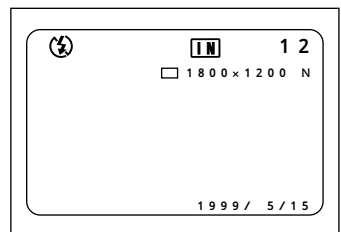

### How To Cancel Date Imprinting Mode

Follow the above procedures and select [OFF] in step 3.



- Enable the save mode to save the date imprinting mode setting. See “Keep Settings” (p.104).

# Redeye Reduction Mode

If you shoot a subject, with the flash activated, in a dark place, the eyes of the subject may appear red in the resultant picture. In redeye reduction mode, the flash will fire several times before the shutter releases to lessen the redeye phenomenon.

- 1 Set the mode dial to [📷] and press the **MENU** button.

The record menu is displayed.

- Note** • To cancel the operation, press the MENU button.

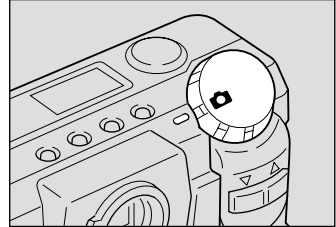

- 2 Press the **⏏** or **⏏** button to select "REDEYE REDUCTION".

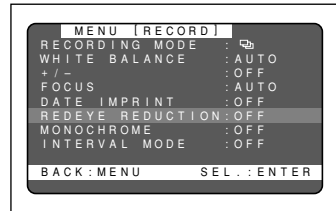

- 3 Press the **ENTER** button to select [ON] and press the **MENU** button.

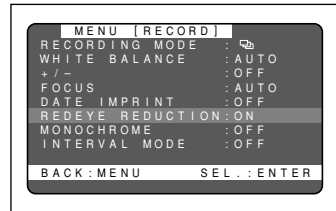

- 4 Press the shutter release button to shoot the subject.

When you press the shutter release button, the flash will fire several times in succession preliminarily before firing last when the shutter releases.

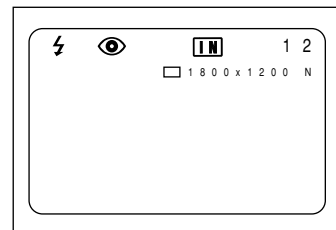
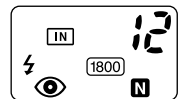

**Important Note**

- The shutter takes about 1 second to release after you press the shutter release button. Hold the camera steady meanwhile to shoot.

## How To Cancel Red-eye Reduction Mode

Follow the procedures on the previous page and select [OFF] in step ③.

**Note** • Red-eye reduction mode does not work when the flash is disabled from firing.

## Monochrome Mode (Black & White) Sepia

Shoots subjects in black & white or sepia images.

- ① Set the mode dial to [📷] and press the MENU button.

The record menu is displayed.

**Note** • To cancel the operation, press the MENU button.

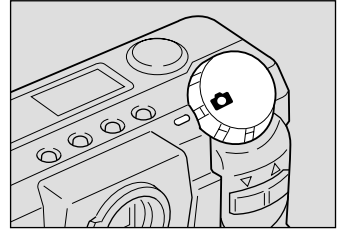

- ② Press the **or** button to select [MONOCHROME].

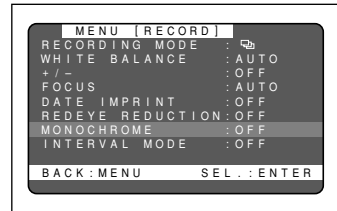

- ③ Press the ENTER button to select between [B&W] and [SEPIA] and press the MENU button.

Select [B&W] to shoot in black & white images or [SEPIA] to shoot in sepia images. The monochrome mode is now set.

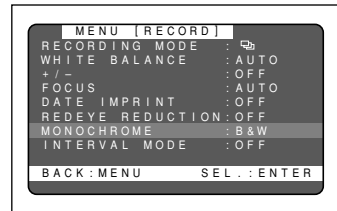

- ④ Press the shutter release button to shoot the subject.

**Note** When you choose monochrome mode, the white balance mode does not function.

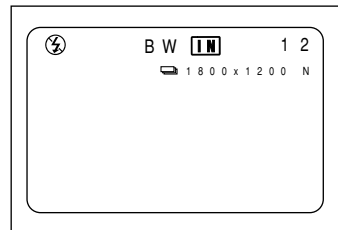

## How To Cancel Monotone Mode

Follow the above procedures and select [OFF] in step ③.

# Interval (Time lapse) Shooting Mode

The camera can be set to take pictures automatically at preset times. The times can be set in steps of 30 seconds from 30 seconds to 3 hours. For example, if you set a time of 1 hour, the camera will release the shutter every hour, taking pictures continuously until the SmartMedia memory card runs out of available memory.



- Check the remaining number of pictures that can be stored on the SmartMedia memory card and the internal memory card before starting interval (time lapse) shooting.
- The auto power off will be activated after 24 hours.

## 1 Set the mode dial to [CAMERA] and press the MENU button.

The record menu will be displayed.



- To cancel the operation, press the MENU button.

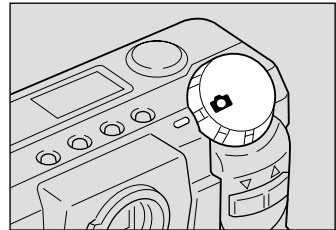

## 2 Press the [MENU] or [RECORD] button to select [INTERVAL MODE] and press the ENTER button.

The interval timer (time lapse) settings menu will be displayed.



- To cancel the operation, press the MENU button. The screen returns to record menu.

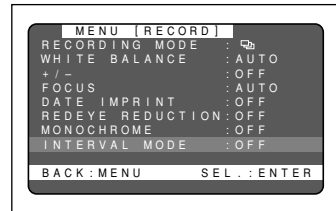

## 3 Press the ENTER button until the digit you want to set starts to flash.



- Each time you press the ENTER button, the flashing digit will change, from the hour to the minute to the second.

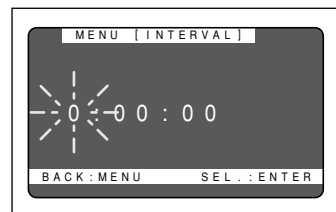

**4 Press the  $\leftarrow$  or  $\rightarrow$  button to change the value of the digit that is flashing.**

Pressing the ( $\leftarrow$ ) button increments the numeral. Pressing the ( $\rightarrow$ ) button decrements the numeral. Keep pressing the button changes the numerals fast. Follow the procedures 3 and 4 above to perform the settings. The times can be set in steps of 30 seconds.

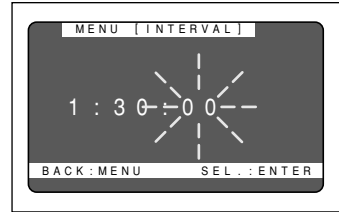

**5 Press the ENTER button again after setting the digit of second.**

The interval timer (time lapse) function is now enabled and the record menu is displayed.

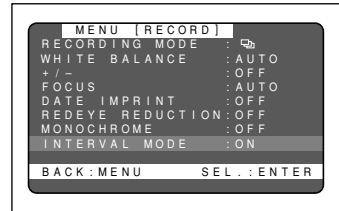

**6 Press the MENU button.**

The record menu will close and exit to the normal display, and the "INTERVAL" message will appear on the LCD monitor.

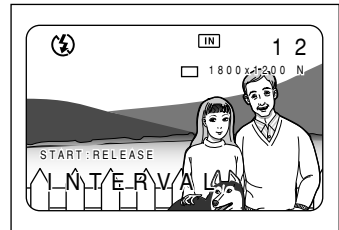

**7 Press the release button.**

The first photograph will be taken and then additional photographs will be taken at the set time interval. When picture taking starts, the focus will be locked so do not move the camera from that location.

The message "Interval" will blink during interval photography. Picture taking will end when the smart media or internal memory is full.

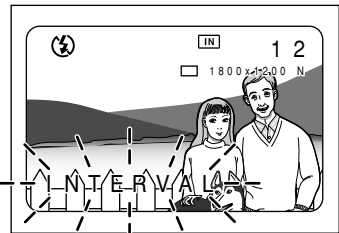

- Normal picture taking is possible during interval photography by pressing the shutter release. The set time interval will not change.
- The time interval may become longer than the set interval, depending on the image quality mode and flash mode.
- When the battery is used, it is possible for the battery to become exhausted during interval photography. It is recommended that the AC adapter be used.

### How To Cancel Interval Shooting

If the "INTERVAL" message lights up on the LCD monitor, take the following procedures:

- Follow the procedures on the previous page and set the interval (time lapse) timer to [0:00:00].
- Slide the power switch off.
- Set the mode dial to switch to another mode.

### How To Cancel Shooting

The "INTERVAL" message flashes on the LCD monitor while interval (time lapse) shooting is in progress. To cancel shooting while in progress, take the following procedures:

- Slide the power switch off.
- Set the mode dial to switch to another mode.

## Using SOFT Mode

Smooths the contours when photographing flat objects such as people, faces, walls, etc.

- 1 Set the MODE dial to [📷] and then press the MENU button.

The Recording menu will appear.

- Note** • Press the MENU button to cancel the operation.

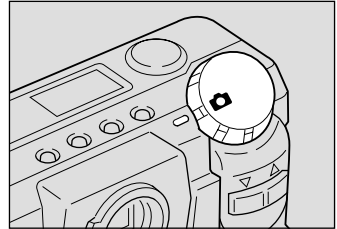

- 2 Press the up or down button to select SOFT MODE on the second screen.

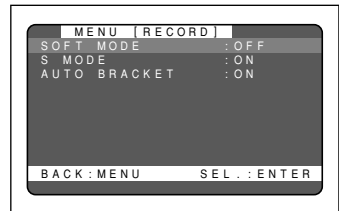

- 3 Press the ENTER button to select ON and then press the MENU button.

- 4 Press the release button to take the picture.

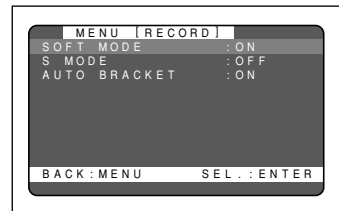

### How To Cancel SOFT Mode

Follow the above procedures and select OFF in step 3.





- Enable the keep settings to save the SOFT Mode setting. See Keep Settings. (p.104)

## S Mode (Shutter Speed)

Using S mode, the shutter is released faster to make low light shots possible. If the “SLOW SHUTTER” message appears on the LCD monitor when you point the camera at a dark subject and press the shutter release button lightly, S mode will help reduce camera shake that tends to occur in this situation.



- Pictures taken in S mode may occasionally have some noise.

### 1 Set the mode dial to [📷] and press the MENU button.

The record menu will be displayed.



- To cancel the operation, press the MENU button.

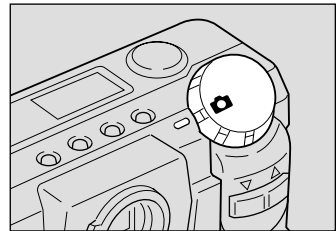

### 2 Press the **▲** or **▼** button to select [S MODE].

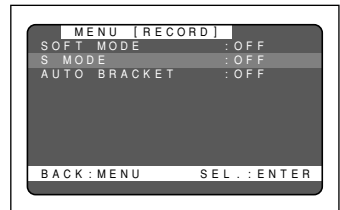

### 3 Press the ENTER button to select [ON] and press the MENU button.

The S mode is now set.

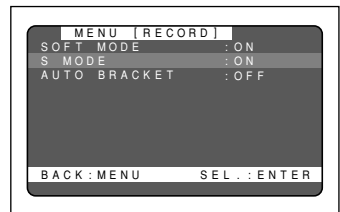

### 4 Press the shutter release button to take the picture.

The camera will automatically determine whether to shoot in S mode or not according to the brightness of the subject. If the “SLOW SHUTTER” message appears on the LCD monitor when you press the shutter release button lightly, the shot will be taken in S mode.

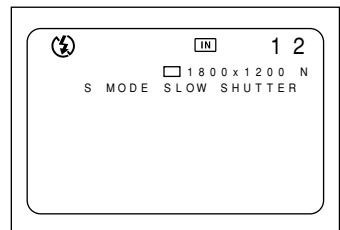

- Note** • Moving the camera before the beep sounds, after pressing the shutter release button, could result in a blurred image.

### How To Cancel the S Mode

Follow the above procedures and select [OFF] in step ③.

- Note** • S mode works only when the flash is disabled from firing.  
• Enable the keep settings to save the S mode setting. See “Keep Settings” (p.104).

## Using Auto Bracket

This function takes three continuous frames: one each at the set exposure and at -0.5EV and +0.5EV. This feature makes it possible to obtain correct exposure under difficult conditions.

Mount the camera on a tripod or level surface to prevent the camera from moving.

- ① **Set the MODE dial to [📷] and then press the MENU button.**

The Recording menu will appear.

- Note** • Press the MENU button to cancel the operation.

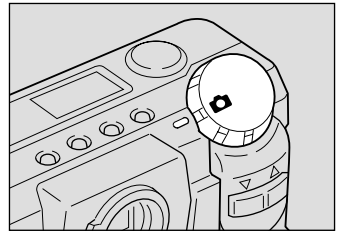

- ② **Press the up or down button to turn AUTO BRACKET to ON.**

Press the ENTER button to select ON when in OFF and then press the MENU button.

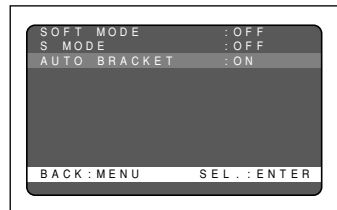

- ③ **Press the release button to take the picture.**

When the release button is pressed, three frames will be taken at the set exposure of -0.5EV, 0, +0.5EV.

### How To Cancel Auto Bracket

Follow the above procedures and select OFF in step ③.



- The flash will not fire when Auto Bracket is used.
- Enable the keep settings to save the Auto Bracket. See Keep Settings. (p.104)
- The digital zoom function is not available when Auto Bracket is used.
- The continuous mode cannot be set when Auto Bracket is used.

## Macro Shooting (Close-up Shooting)

Macro photography allows you to take a closeup picture of a subject. Macro photography up to about 4 cm (1.5 inches) away is made possible by setting the lens to the widest angle position. With the lens set at another position, macro photography as close as about 40 cm (15.8 inches) is possible.

- 1 Set the mode dial to [📷].

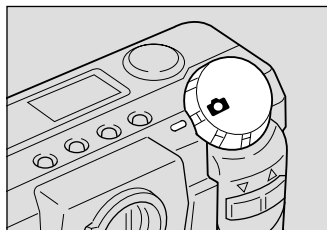

- 2 Bring the camera close to the subject and decide the composition of the picture. Press the shutter release lightly to set the focus.

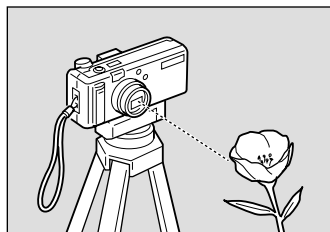

- 3 Gently press the shutter release button down fully to take the picture.



- The focusing range is so small in macro mode that the focus can be lost if the camera is moved. Make sure the camera is firmly positioned by mounting it on a tripod, for example, to keep it steady when shooting.
- Light from the flash may appear red in shots taken in flash mode. The subject may also appear white in the resultant shot due to over-exposure.
- Since the field of view through the viewfinder and the shooting range are shifted by a wide margin, take pictures by confirming the shooting range through the LCD or with the camera connected to a TV monitor.



### **Focal Range for Macro Shooting**

The macro range is when the subject is located at a distance between 4.0cm and 40cm (wideangle).

### **Shutter Release Button**

The optional remote control unit is convenient to use when the camera is mounted on a tripod or similar device and the shutter release button is difficult to press.



- To photograph a subject at larger than life size, set SUPER MACRO (🌸) and move close to the subject when taking the picture.

# PLAYBACK/ERASING Chapter

# 4

<b>Before Starting To Playback Recorded Images ...</b>	<b>76</b>
<b>Playback Display .....</b>	<b>76</b>
<b>Connecting to a TV .....</b>	<b>77</b>
<b>Playing Back a File .....</b>	<b>78</b>
<b>Operation Flow .....</b>	<b>78</b>
<b>Playing an Image File .....</b>	<b>79</b>
<b>Multi Image Playback .....</b>	<b>80</b>
<b>Zoom Playback .....</b>	<b>81</b>
<b>Auto Playback .....</b>	<b>82</b>
<b>Protecting a File .....</b>	<b>82</b>
<b>Copying Files .....</b>	<b>84</b>
<b>Playing a File Shot with Another Brand of     Camera .....</b>	<b>86</b>
<b>Setting DPOF (Direct Print of File) .....</b>	<b>87</b>
<b>Setting a Printing Service .....</b>	<b>87</b>
<b>Setting Secret File .....</b>	<b>91</b>
<b>Erasing a File (Image) .....</b>	<b>94</b>
<b>Operation Flow .....</b>	<b>94</b>
<b>Erase .....</b>	<b>95</b>
<b>Erase All Images .....</b>	<b>96</b>
<b>Erase Selected Files (Images) .....</b>	<b>97</b>



# Before Starting to Playback Recorded Images

This section explains the preparations for playing back recorded images and how to read the playback display.

## Playback Display

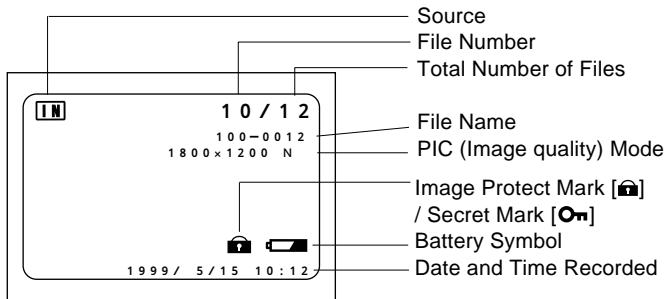
Information about a recorded file, including its number and type, will be displayed when you select PLAY mode.



<b>Source</b>	Internal memory or SmartMedia memory card	
		Internal memory
		SmartMedia
<b>File Number</b>	Number of the file being played	
<b>Total Number of Files</b>	Total number of files recorded	
<b>File name</b>	Name of the file being played. For use when the file is submitted to digital printing services or other applications. When a file that does not conform to the DCF (Design rule for Camera File system) image file format is played, "□□□□□□□□" will appear. *File names changed on a PC may not be displayed correctly on the camera.	
<b>PIC Mode</b>	Displays the PIC mode of the file being played.	
<b>Image Protect Mark</b>	Indicates that a protected file is being played.	
<b>Secret Mark</b>	Displayed when playing back a file to which the Secret has been set.	
<b>Battery Mark</b>	Displays the status of exhaustion of the battery loaded in the camera.	
<b>Date and Time Recorded</b>	Displays the date and time at which the file was recorded.	

- Note** • Recorded images are played back assuming that the camera was held horizontally to shoot them. Accordingly, pictures shot with the camera held vertically will be displayed sideways.



### LCD Monitor Display Function

Press the ENTER button to display information, such as the date and time recorded, on the LCD monitor. Each time you press the ENTER button, the display will change in the following sequence:

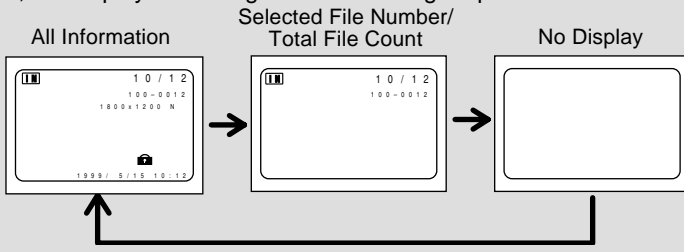

## Connecting to a TV

Connect the camera to a TV set with the video interface cable supplied to play recorded image files on the TV screen. You may also connect the cable to a VCR to record your images on videotapes.



- Please refer to the instruction manual for the equipment to which the camera is connected.

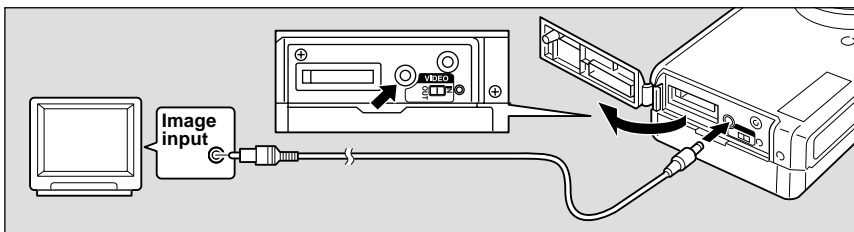

- 1 Check that both the camera and the TV are turned off.
- 2 Open the camera's terminal cover and connect the video interface cable to the video in/out terminal.
- 3 Connect the other end of the video interface cable to the Video In terminal on the TV.

### Using the Camera for Extended Periods of Time

Supplying power to the camera from a household AC outlet using an optional AC adapter is recommended for shooting over extended periods of time. See "Using an AC Adapter" (p.29).

- Make sure that the camera is turned off before connecting the AC adapter.



- When you are away on overseas trips, you may view recorded image on a PAL TV set. See "Changing Video-out Signal Method (NTSC/PAL)" (p.107).
- You may use this camera as a monitor for a video printer or other video gear (NTSC only). Set the video I/O switch to [IN] and connect the video cable to the video output terminal of the video gear. The LCD monitor would appear blank when the video cable is connected to video gear after the video I/O switch is changed to PAL.
- The LCD monitor would appear blank if you connect the video interface cable to the camera when its video I/O switch is set to PAL.

# Playing Back a File

This section provides instructions for playing back recorded image files.

## Operation Flow

To play back an image file, follow the steps below:

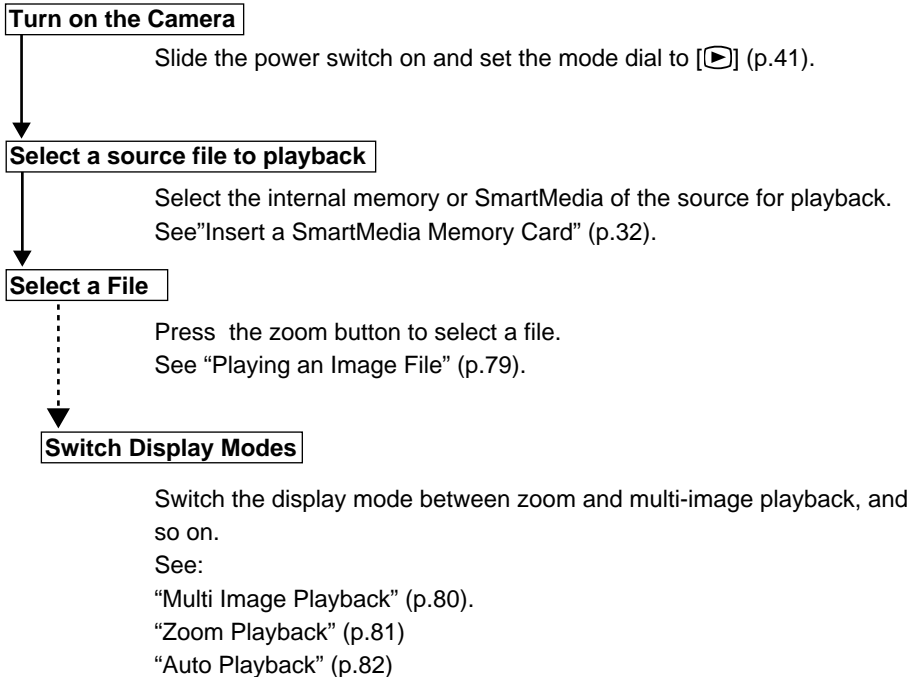

## ■ Files That Can Be Played on the Camera

The following kinds of files can be played on this camera:

- Files recorded on this camera
- Files transferred from a PC using software compatible with this camera
- Files shot with another brand of camera

See "Playing a File Shot with Another Brand of Camera" (p.86)



- The "UNMATCHED FILE" message will be displayed if an unplayable file is encountered.
- Data recorded on the Ricoh RDC-300Z/RDC-4300, 4200, RDC-5000 digital camera can also be displayed (but Multi Image Playback, zoom playback, sound file or NC file playback is not possible).



# Playing an Image File

Follow the procedure below to play files recorded in still picture text mode or Quick shooting mode.

**1 Set the mode dial to [▶].**

The most recently recorded file is played back on the LCD monitor.

**See** “Playback Display” (p.79)

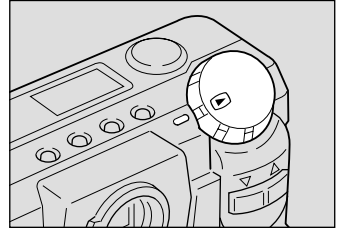

**2 Press the CARD/IN button to select the source for playback.**

**3 Press the or button to select the file to be played back.**

The next file is displayed when the button is pressed. The previous file is displayed when the button is pressed.

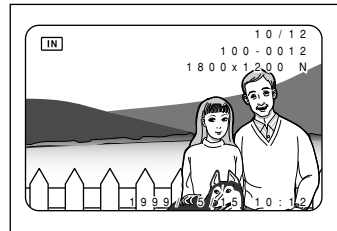

**● Playback Display**

If pictures are taken in the following image sizes, their playback displays will appear as shown below.

1800 × 1200

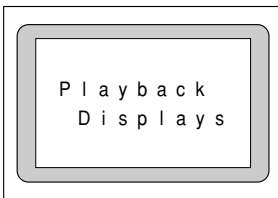

900 × 600

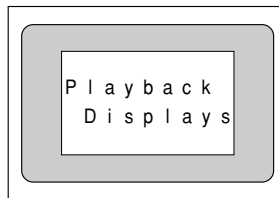

640 × 480

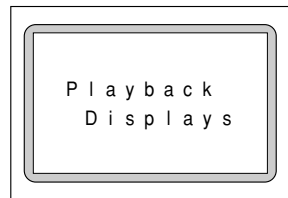

- Note**
- Files may take long to play after the camera is turned on or the mode dial is set, depending on the capacity of the SmartMedia memory card mounted.
  - Files that have been recorded in continuous shooting mode are recorded as a single file and therefore can be played the same way as regular files.
  - It is possible to set secret files that cannot be erased or displayed on the screen. See “Protecting a File” (p.83). See “Setting Secret Files” (p.91).

# Multi Image Playback

Multi-image playback lets you view six images at once on the LCD monitor for quick searching.

❶ Set the mode dial to [▶].

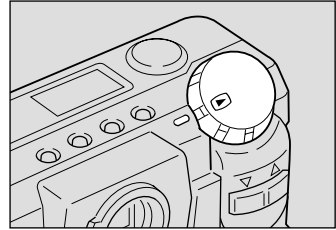

❷ Press the DISPLAY button.

The multi-image playback function is now set.

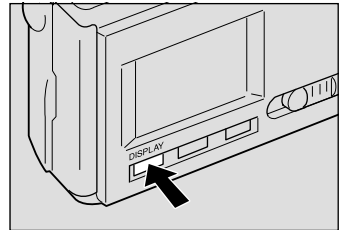

❸ Press the or button to select the file to be played back.

The frame number display position is fixed and groups of 6 files each are displayed one at a time on the LCD monitor.

Selected file names are displayed highlighted.

Press the button to move to the previous file. Press the button to move to the next file.

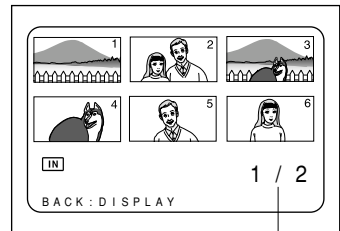

Displays the first of the two images.

❹ Press the DISPLAY button.

The normal screen will be displayed. And the file of the reversed number will be displayed in the single-image mode.

## Note

- Unplayable files recorded on other equipment will be displayed on a blue background.
- Press the button while the cursor is on the last (lower right) file, will display the next set of six files; press the button while the cursor is on the first (upper left) file will display the previous set of six files.

# Zoom Playback

An image file that is played is displayed twice the height and width of the original.



- Note** • Only images recorded in sizes of 1800 × 1200 (F/N/E) and 900 × 600 (F/N/E) can be played zoomed.

**1 Set the mode dial to [▶] and press the MENU button.**

The play menu will be displayed.

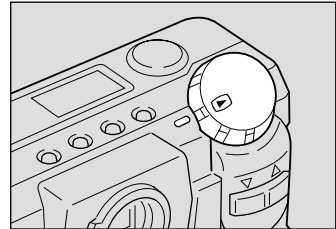
- Note** • To cancel the operation, press the MENU button.





**2 Press the  or  button to select [ZOOM PLAYBACK] and press the ENTER button.**

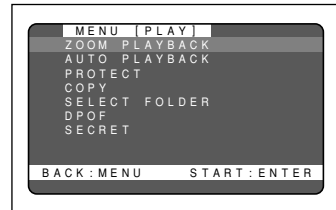

- Note** • To cancel the operation, press the MENU button. The screen returns to play menu.

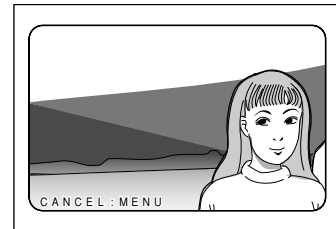

The file is then displayed in an magnified image.



**3 Press the  or  button to verify the image file.**

Press the  button to shift the playback position as shown by the solid line in the illustration shown on the next page; press the  button to shift the playback position as shown on the next page by the dotted line.

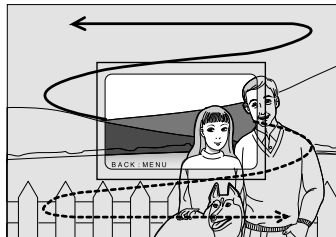

**4 After confirming the image file, press the MENU button to cancel the zoom playback mode. The play menu will be displayed.**

Press the MENU button again to cancel the operation.

# Auto Playback

This function automatically plays all the files stored in internal memory or on the SmartMedia memory card.

- 1 Set the mode dial to [▶] and press the **MENU** button.

The play menu will be displayed.

- Note** • To cancel the operation, press the MENU button.

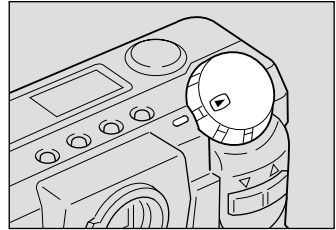

- 2 Press the **▲** or **▼** button to select [AUTO PLAYBACK] and press the **ENTER** button.

The setup menu is displayed.

- Note** • To cancel the operation and return to the play menu, press the MENU button.

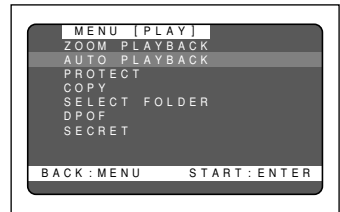

- 3 Press the **▲** and **▼** buttons to select the playback time (1 sec., 5 sec., 10 sec., 30 sec.) and then press the **ENTER** button.

The time used to select files is not included in the playback time.

When the ENTER button is pressed, auto playback starts at the set time interval. Auto playback will then continue until canceled.

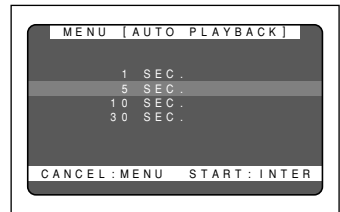

## How To Cancel Auto Playback

Press any button, such as the shutter release button or zoom button, to cancel an auto playback in progress.

# Protecting a File

You can protect valuable files from being erased accidentally.



- Formatting the SmartMedia memory card will erase protected, as well as unprotected, files.
- The protect mark will not be displayed when the SECRET mode is set.

## 1 Set the mode dial to [▶] and press the MENU button.

The play menu will be displayed.



- To cancel the operation, press the MENU button.

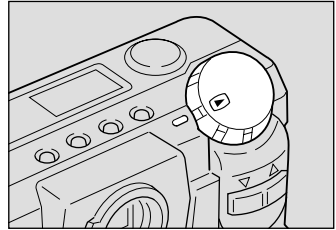

## 2 Press the or button to select [PROTECT] and press the ENTER button.

The setup menu will be displayed.



- To cancel the operation and return to the play menu, press the MENU button.

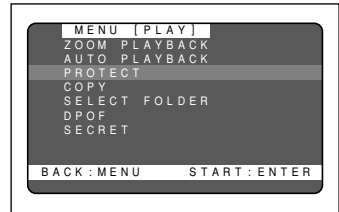

## 3 Press the or button to select the file you wish to protect and press the ENTER button.

The selected file will be protected and the  mark will be displayed. If you keep the setting, repeat step 3.

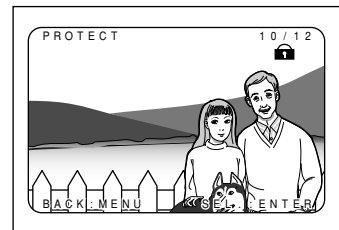

## 4 Press the MENU button to cancel the protect setting.

The screen returns to the play menu. Press the MENU button again to cancel the operation.



- Protected files cannot be erased until the protection setting is cancelled.
- Files displayed in multi-image playback mode cannot be protected. Switch to a single-image mode to carry out protection setting. See "Multi Image Playback" (p.80).

## How To Cancel the Setting

Choose a protected file in step ③ above and press the ENTER button to erase the  mark.

## Copying Files

Files can be copied from the built-in memory to SmartMedia or from SmartMedia to the built-in memory.



- When a protected file is copied, the new file will not be set as protected.
- Secret files cannot be copied.
- The only files that can be copied are files created with this camera.
- If there is insufficient space at the copy destination, the message "INSUFFICIENT" will be displayed.

Press the release button to copy the remainder of the file. Press the MENU button to cancel.

### ① Set the Mode dial to [▶] and press the MENU button.

The playback menu will be displayed.



- Press the MENU button to exit the operation.

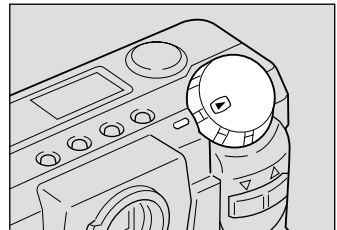

### ② Press the and buttons to select Copy and then press the ENTER button.

The setup menu will be displayed.

- Copying all images → P.84
- Copying selected images → P.85

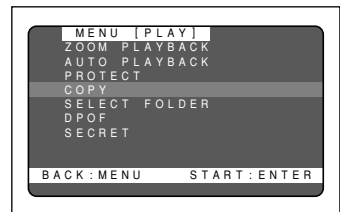

## ■ Copying all images

### ① Press the CARD/IN button and select the copy source.

Pressing the CARD/IN button will alternate the setting between CARD → IN and IN → CARD.

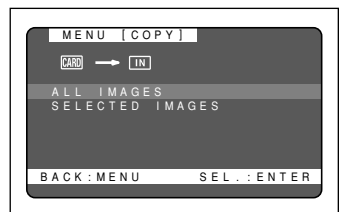

- Press the **or** button to select **[ALL IMAGES]** and press the **ENTER** button.

**Note** • To cancel the operation and return to the play menu, press the **MENU** button.

- Press the **shutter release** button.

All the image files are copied in a batch. And the setup menu will be displayed. When the copying is complete, press the **MENU** button to exit the operation.



## ■ Copying Selected Image

- Press the **CARD/IN** button and select the **copy source**.

Pressing the **CARD/IN** button will alternate the setting between **CARD → IN** and **IN → CARD**.

- Press the **or** button to select **[SELECTED IMAGES]** and press the **ENTER** button.

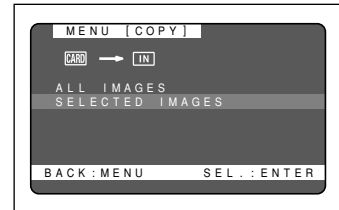

**Note** • To cancel the operation and return to the play menu, press the **MENU** button.

- Press the **or** button to select the **file to copy** and press the **ENTER** button.

The **C** mark is displayed in the image file thus selected. To copy more files, repeat steps ② as many times as needed.

**Note** • To cancel copying a file bearing the **C** mark, press the **ENTER** key again.

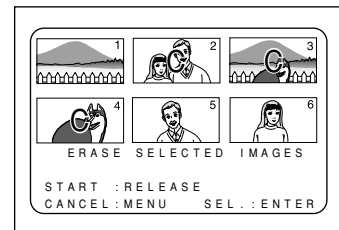

- Press the **release** button.

The selected images is copied. And the setup menu will be displayed. When the copying is complete, press the **MENU** button to exit the operation.

# Playing a File Shot with Another Brand of Camera

Files recorded with a non-Ricoh camera can be played if the non-Ricoh camera conforms to the DCF (\*) image file format.

\* DCF is the abbreviation of the standard "Design rule for Camera File system" which was standardized by the JEIDA.

## 1 Mount a SmartMedia memory card in the camera.

**See** See "Inserting a SmartMedia Memory Card" (p.32).

## 2 Set the mode dial to [▶] and press the MENU button.

The play menu is displayed.

**Note** • To cancel the operation, press the MENU button.

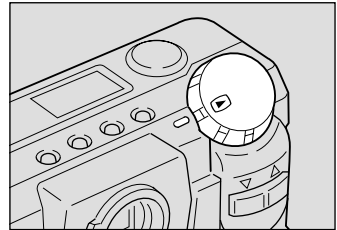

## 3 Press the or button to select [SELECT FOLDER] and press the ENTER button.

The setup menu is displayed.

**Note** • To cancel the operation and return to the play menu, press the MENU button.

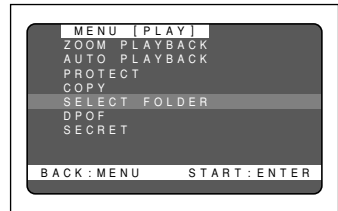

## 4 Press the or button to select a folder and press the ENTER button.

The image files in the folder are displayed.  
Press the or button to select files to play.

**See** See "Playing an Image File" (p.79).

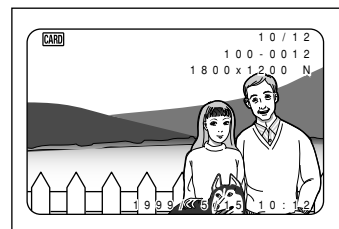
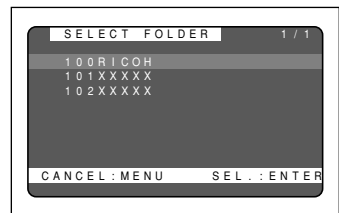



## Setting DPOF (Direct Print of File)

DPOF is a special feature built into your camera that allows you to assign information to your images for use by digital printing services, desktop printers that accept memory cards or devices that allow direct to print from your camera. By assigning DPOF information to an image, you may designate the quantity of images you wish to have printed or have an index of selected images printed directly from the memory card or image file.

When submitting recorded images to digital printing services or other applications, set the number of copies of the images to print and that of copies of the index. This setting is possible only when you select the RICOH folder.

## Setting a Print Service

When having prints made by a digital print service, set the number of prints and number of indexes.

- Note**
- Only the files in the Ricoh folder can be set for print service.
  - Leave enough space for 1 - 2 prints on the smart media so the print service settings can be saved.
  - After making the print service settings, do not change the record, erase, etc., settings. If this is done, reset playback.

❶ Rotate the mode dial to [▶] and press the CARD/IN button to select [CAM].

❷ Press the MENU button.

The playback menu will be displayed.

- Note**
- Press the MENU button to cancel the operation.

❸ Press the **▲** and **▼** buttons to select [DPOF] and then press the ENTER button.

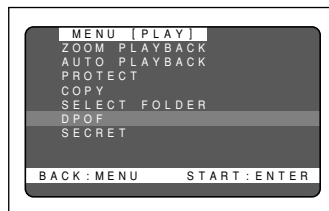
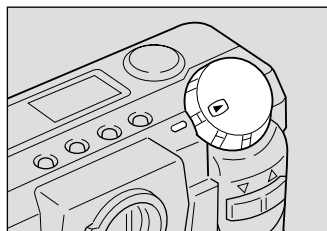

The Setting menu will be displayed.

- Specify the number of prints. → P.88
- Specify the number of indexes. → P.89
- Cancel the DPOF settings. → P.90



● **When previous DPOF settings exist**  
 If DPOF settings have already been made, the screen shown to the right will be displayed. Press the release button to clear the settings. New print settings are not possible unless the previous settings are first cleared.



## ■ Specifying the number of prints

① Press the **▲** and **▶** buttons to select **STANDARD PRINT** and then press the **ENTER** button.

The screen will change to 6-screen display.

**Note** • Press the MENU button to exit the operation and return to the Playback menu.

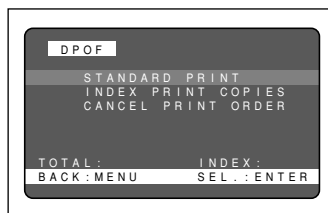

② Press the **▲** and **▶** buttons to select the file that specifies the number of prints, then press the **ENTER** button.

The file under the specified number will be displayed on one screen.

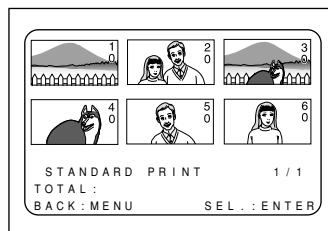

③ Press the **▲** and **▶** buttons to specify the number of prints, then press the **ENTER** button.

The number of prints will be set and the 6-screen display will return. To continue setting the number of prints, repeat the operations in procedures ② - ③.

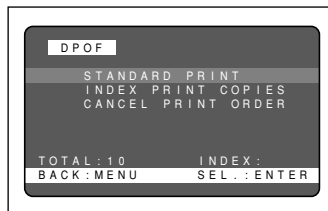
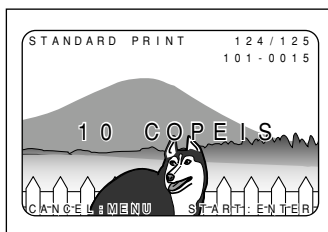

#### 4 Press the MENU button.

The setup menu will return. Press the MENU button to return to the Playback menu. Press the MENU button again to exit the operation.



- Rotating the mode dial to the setting menu (DPOF settings) shown to the right will clear the settings. Always press the MENU button repeatedly until the Playback menu returns.

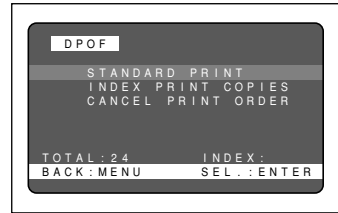

#### How to cancel the settings

Perform the same operations described in step 3. The number of prints value will be reset to zero (0).



- Use Clear All to clear all settings. → See “Canceling DPOF settings”.

### ■ Specifying the number of indexes

All of the files in the Ricoh folder can be reduced and printed. These are called index prints. These are convenient for making a list of the files in the Ricoh folder and for specifying the number of prints.

#### 1 Press the and buttons to select [INDEX PRINT COPIES] and then press the ENTER button.



- Press the MENU button to exit the operation and return the Playback menu.

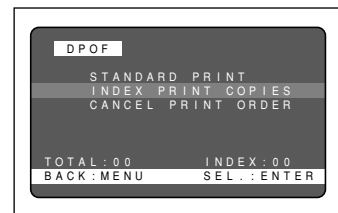

#### 2 Press the and buttons to specify the number of indexes, then press the ENTER button.

The number of indexes will be specified and the setup menu will return.



### 3 Press the MENU button.

The Playback menu will return. Press the MENU button again to exit the operation.



- Rotating the mode dial to the setting menu (DPOF settings) shown to the right will clear the settings. Always press the MENU button repeatedly until the Playback menu returns.

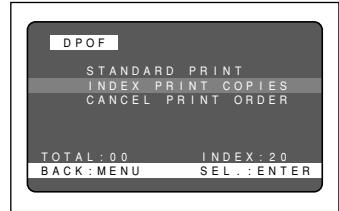

#### How to cancel the settings

Perform the same operations described in step 2. The number of indexes value will be reset to zero (0).



- Use Clear All to clear all settings. See “Canceling DPOF settings”.

## ■ Canceling DPOF settings

### 1 Press the and buttons to select CANCEL PRINT ORDER, then press the MENU button.



- Press the MENU button to exit the operation and return to the Playback menu.

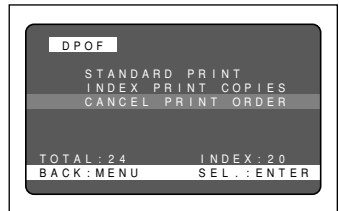

### 2 Press the release button.

All of the settings will be cleared and the Settings menu will return.

### 3 Press the MENU button.

The Playback menu will return. Press the MENU button again to exit the operation.



# Setting Secret File

The Secret File setting is used to prevent files being displayed on the screen. When set to Secret, files are displayed on the screen in black during playback.



- Secret File can only be set for the built-in memory.

## ■ Setting a password

This is used to set a password before using the Secret File mode. Secret File cannot be selected unless a password is set first.

### ① Set the MODE dial to SETUP.

The SETUP menu will appear.



- To cancel the operation, rotate the MODE dial.

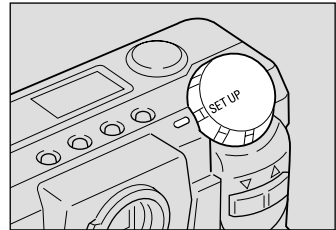

### ② Press the up or down button to select PASSWORD and then press the ENTER button.



- Press the MENU button to cancel the operation. The SETUP menu will return.

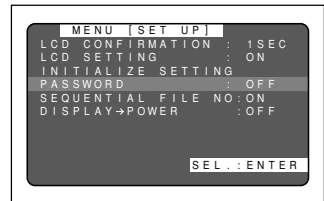

### ③ Use the up or down button to change the flashing numeral and then press the ENTER button.

The up button increments the numeral and the down button decrements the numeral.



The password is displayed as asterisks (\*). Repeat the above procedures and enter a 4-digit number.



- 0000 cannot be set as the password.

**4 To confirm, press the up or down button and re-enter the password.**

The password will be set and the SETUP menu will return.

- Setting Secret File → page 91

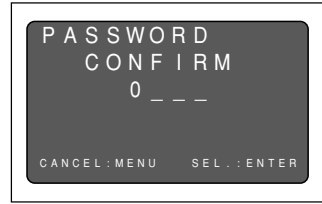

**When you forget your password**

Press the reset button to cancel the password.

**How to Cancel a password**

Perform the same operations and enter a password setting in the previous password in step 3, then enter 0000. Password setting will be turned off.



- If the batteries are not loaded for more than 3 minutes, the password will be canceled.

## ■ Setting secret files

Use this only after setting a password. Refer to page 91 Password Setting.



- Formatting the built-in memory deletes all secret files.
- If an attempt is made to set Secret without setting a password, the message “Set a password” will be displayed. Secret can now be set, but only the [On] mark will be displayed until a password is set. The screen display will not become black.

**1 Set the MODE dial to [▶] and then press the CARD/IN button to select [IN].**

**2 Press the MENU button.**

The PLAYBACK menu will appear.



- Press the MENU button to cancel operation.

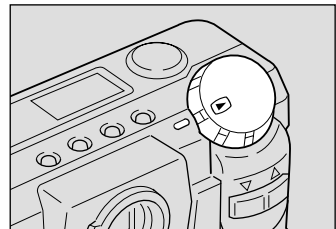

**3 Use the up or down button to select SECRET and then press the ENTER button.**



- Press the MENU button to cancel operation. The PLAYBACK menu will return.

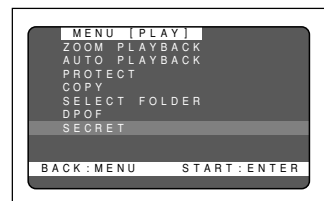

● **When Secret File is already set**

If Secret File has already been set, the screen shown to the right will appear. Input a password. Secret File cannot be selected unless a password is entered.



④ **Use the up or down button to select the file to be made secret and then press the ENTER button.**

Secret will be set and the **On** mark will be displayed. Repeat procedure ③ to set another secret file.

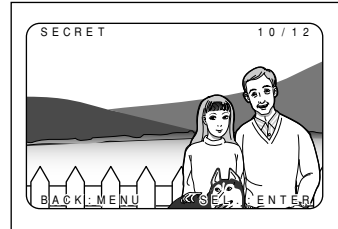

⑤ **Press the MENU button.**

The PLAYBACK menu will return. Press the MENU button again to end the operation.

After the camera power is turned off, it will no longer be possible to display the secret files on the screen. When the ENTER button is pressed to change the screen, the **On** mark will appear to confirm.

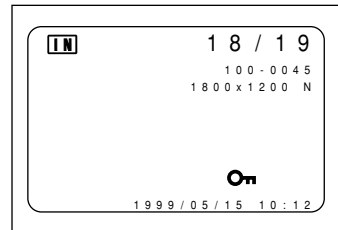

**How To Cancel settings**

Perform the same operations to select the file to be made secret using procedure ④ and then press the ENTER button. The **On** mark will disappear.

**How to Display Secret File**

Perform the same operations and enter a password as described in procedure ③. The secret files can be displayed on the screen until the power is turned off or by pressing the MENU button to end operation.

**Note** • Secret files cannot be copied or deleted. Cancel the secret setting before attempting to perform these operations.

# Erasing a File (Image)

This section explains how to erase recorded files. There are three ways to erase files:

- (1) erase, one selected file is erased at a time
- (2) erase all, all files are erased at once, and
- (3) format, files on a SmartMedia memory card that have been used on another device are erased and the card is formatted for use with this camera.



- Files on a write-protected SmartMedia memory card cannot be erased unless the write protect pad is removed from the card. See “Protecting Against Accidental Writing” (p.31).  
Only the pictures that have been taken with this camera can be erased.
- Depending on the SmartMedia capacity, it may take a short time to erase a file after turning on the power or changing the mode dial.

## Operation Flow

To erase image files, follow the steps below:

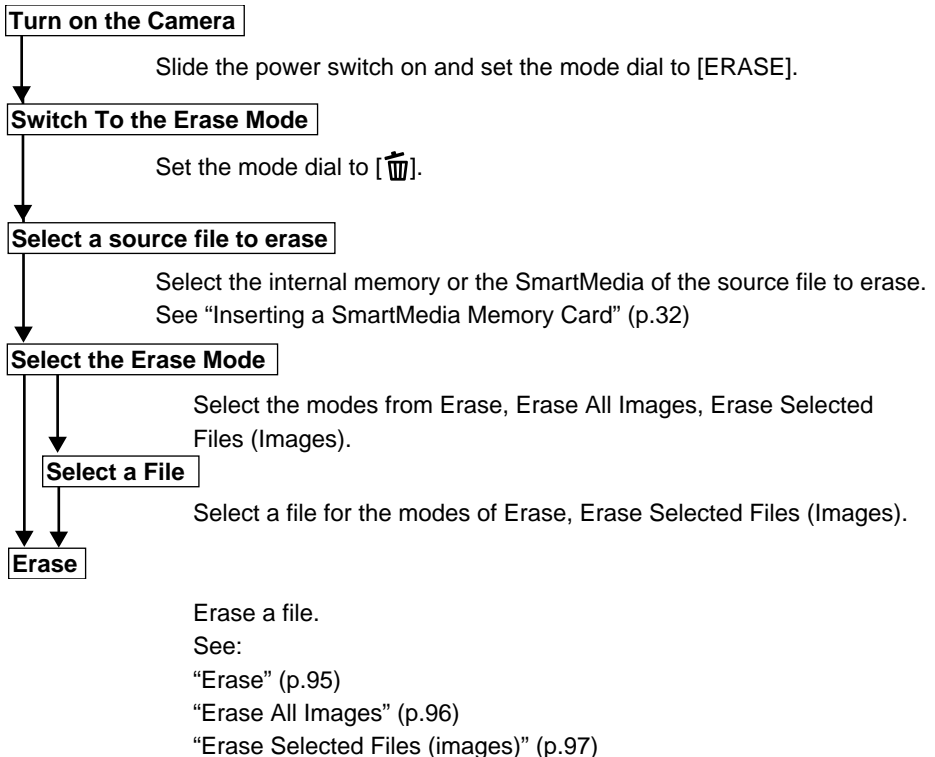



# Erase

The selected file is erased.



- Remember that files cannot be restored once they are erased. Before starting to erase a file, make sure that you want to erase it.

- 1 Set the mode dial to [ ] and press the CARD/IN button to select a source file to be erased.**

An erase menu is displayed.

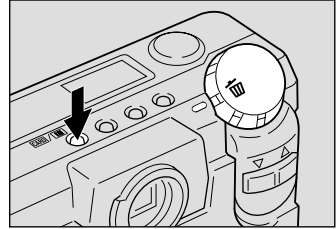

- 2 Press the [ ] or [ ] button to select [ERASE SINGLE IMAGE] and press the ENTER button.**

The erase single image menu is displayed.



- To cancel the operation, set the mode dial to another mode.

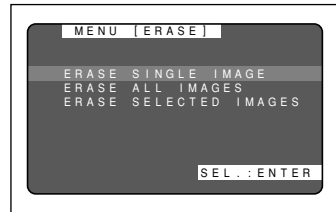

- 3 Press the [ ] or [ ] button to select an image file to erase.**



- To cancel the operation, press the MENU button. The erase menu is displayed.

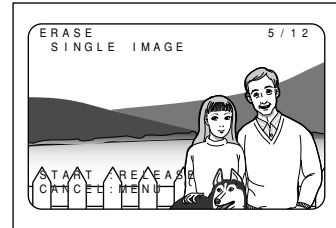

- 4 Press the shutter release button.**

The image file selected is erased. If you want to erase more files, repeat steps 3 and 4 above.

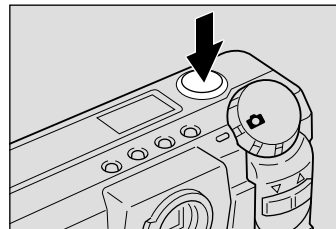

- 5 Press the MENU button.**

The erase menu is displayed again. Then, turn the mode dial to select another mode.



- When a lower numbered file is erased, the higher numbers are reassigned.
- Erasing may take longer with some types of SmartMedia memory cards and files.
- Files which have been set in Protect mode or Secret mode cannot be erased until they are unprotected. See "Protecting a File" (p.83).

# Erase All Images

All recorded files are erased.



- Remember that files cannot be restored once they are erased. Before starting to erase files, make sure that you want to erase them.

- 1 Set the mode dial to [TV] and press the CARD/IN button to select a source file to be erased.**

An erase menu is displayed.

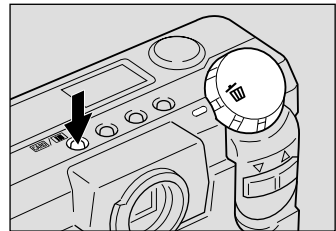

- 2 Press the or button to select [ERASE ALL IMAGES] and press the ENTER button.**

The erase all images menu is displayed.



- To cancel the operation, set the mode dial to another mode.

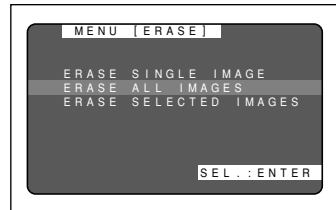

- 3 Press the shutter release button.**

The “ERASING” message is displayed, and all the files are erased.



- To cancel the operation, press the MENU button. The erase menu is displayed.



The erase menu is displayed again after erasing all the images. Then, turn the mode dial to select another mode.



- High-capacity SmartMedia cards or larger number of files may take long time to erase.
- Files which have been set in Protect mode or Secret mode cannot be erased until they are unprotected. See “Protecting a File” (p.83).

# Erase Selected Files (Images)

Erases multiple selected image files.



- Files, once erased, cannot be restored. Before erasing files, check that you are sure you want to erase them.

- 1 Set the mode dial to [ ] and press the CARD/IN button to select a source file to be erased.**

An erase menu is displayed.

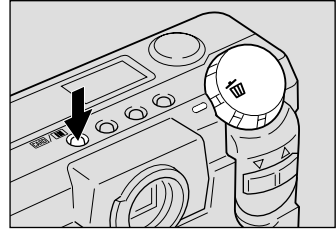

- 2 Press the [ ] or [ ] button to select [ERASE SELECTED IMAGES] and press the ENTER button.**

The erase selected images menu is displayed.



- To cancel the operation, set the mode dial to another mode.



- 3 Press the [ ] or [ ] button to select an image file to erase and press the ENTER button.**

The image file having the image number reversed is designated by the [ ] mark. To select more files, repeat step 3 as many times as needed.



- To cancel copying a file bearing the [ ] mark, press the ENTER key again.

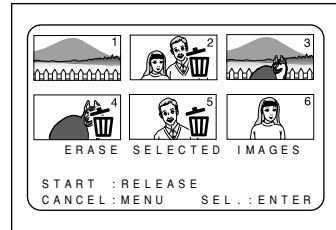

- 4 Press the shutter release button.**

The image files selected are erased.

The erase menu is displayed again after erasing the selected files. Then, turn the mode dial to select another mode.

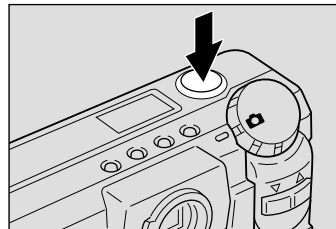

- Files may take time to erase, depending on the type of the SmartMedia memory card mounted and the file type.
- Files which have been set in Protect mode or Secret mode cannot be erased until they are unprotected. See "Protecting a File" (p.83). See "Setting Secret File" (p.91).



# MISCELLANEOUS Chapter

# 5

Transferring Images to a PC .....	100
Changing Camera Settings .....	102
Beep Sound Setting .....	102
Auto Power Off Setting .....	103
Keep Settings .....	104
Formatting Internal Memory .....	105
Changing OSD (On-Screen Display)	
Language .....	106
Changing Video-Out Signal Method	
(NTSC/PAL) .....	107
Changing LCD Confirmation .....	108
Changing the LCD Setting .....	109
Initializing Settings .....	110
Changing File names .....	111
Using the DISPLAY Button to Turn the	
Power ON and OFF .....	112
Checking the Version .....	113
Using the Remote Control .....	114
Shooting .....	114
Playing .....	115
Erasing .....	116
Accessories .....	118
Handling Precautions .....	119
Care and Storage .....	120
Troubleshooting .....	121
Using Your Digital Camera In Other Countries ...	124
About the Warranty and Servicing .....	125
Specifications .....	127
Recording Capacities .....	129
Ricoh Service Offices .....	131

# Transferring Images to a PC

You can transfer recorded files to a personal computer by using a serial cable and software bundled with the camera.

## ■ Installing Camera Utility Software

Install the CD-ROM-based software (Camera utility Windows/Macintosh) (Ricoh Camera Utility) bundled with the camera.

### ● PC Operating Platforms and Installation Instructions

#### ○ Windows

- Operating system : Microsoft Windows 95/98/NT4.0
- PC : PC running Microsoft Windows 95/98
- CPU : Pentium or more
- Memory :
  - Windows95 : 16 MB or more (recommended 32 MB or more)
  - Windows98/NT4.0 : 32 MB or more (recommended 48 MB or more)
- Hard drive space : 6 MB or more
- Display resolution : 640 × 480 dots or more (recommended 800 × 600 dots or more)
- Display colors : 256 or more (recommended 32,000 or more)
- CD-ROM drive : CD-ROM drive supported by Microsoft Windows 95/98

- Note** • The Camera utility software does not run under Windows NT3.51.  
• The Camera utility software does not run under Windows 3.1.

#### ○ Installation

Run the setup.exe file in the Camera utility for Windows (tentative name) folder on CD-ROM (Ricoh Digital Camera Software Suite) and install the Camera utility software as instructed by onscreen guidance messages.

- Note** Likewise, install other software than the Camera utility for Windows (tentative name) in Ricoh Digital Camera Software Suite by running the setup.exe file in each folder.

#### ○ Macintosh

- Macintosh PC : Note or desktop Macintosh II or more
- CPU : 68040 or faster, or PowerPC
- Internal memory : 24 MB or more
- Required memory : 2 MB of uncompressed application memory space (recommended 4 MB or more)
- Hard drive space : 6 MB or more
- Display resolution : 640 × 480 dots or more (recommended 800 × 600 dots or more)
- Display colors : 256 or more (recommended 32,000 or more)
- Keyboard mouse : Keyboard and mouse connectable to the Macintosh PC used
- CD-ROM drive : CD-ROM drive supported by the Macintosh PC used

#### ○ Installation

Copy the Camera utility icon CD-ROM (Software CD Suite) to the Macintosh HDD.

- Note** Likewise, install other software than the Software CD Suite by copying each icon to the Macintosh HDD.

## ■ Connecting the Camera to a PC

Use the interface serial cable bundled with the RDC-5300 to connect it to a personal computer.

- 1 Turn off the PC.
- 2 Turn off the camera.
- 3 Connect the camera and the PC using the interface cable.

**Note**

- Avoid operating the camera on battery power during connection to PC. If possible, run it via an AC adapter. Otherwise if the power shuts off while you are operating the camera, you would have to retry.
- Do not connect or disconnect the AC adapter to or from the AC outlet while the camera is turned on.

Typical Windows connection

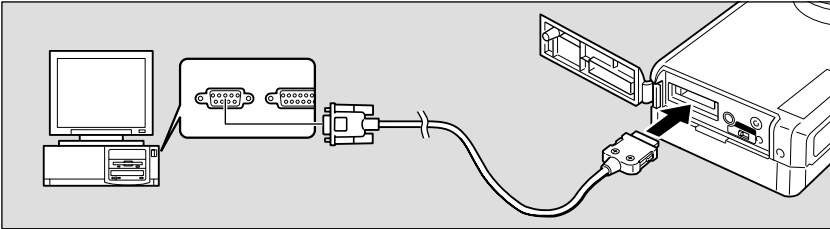

Typical Macintosh connection

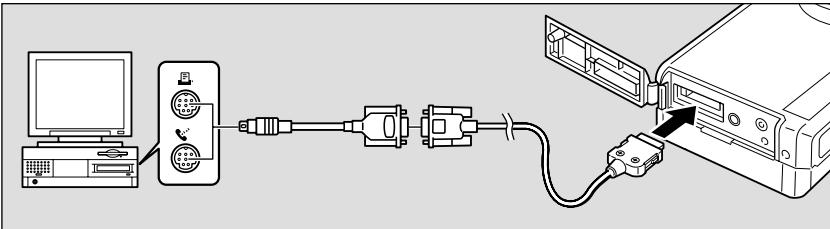

The above diagrams illustrate typical connections to the Ricoh digital camera RDC-5300.

- 4 Turn on the camera and set the mode dial to [PC].

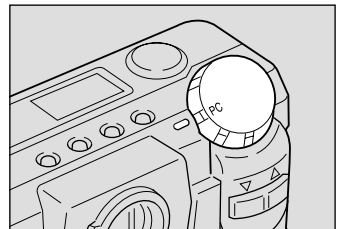

- 5 Turn on the PC and run the utility software.

# Changing Camera Settings

This camera enables you to change camera settings to meet your applications.

## Beep Sound Setting

This camera beeps to alert you when it records a picture. You can disable the beep by following these steps.

### 1 Set the mode dial to [SETUP].

The setup menu is displayed.

- Note** • To cancel the operation, set the mode dial to another mode.

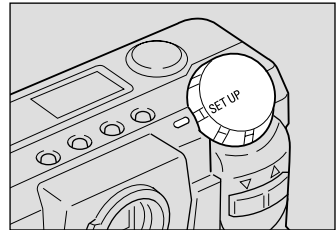

### 2 Press the **▲** or **▼** button to select [BEEP SOUND].

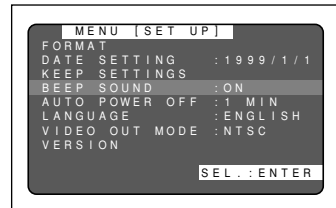

### 3 Press the **ENTER** button to select [OFF].

The beep is now disabled. When the setting is complete, set the mode dial to select another mode.

- Note** • An error beep is not suppressed even when [BEEP SOUND] is set to [OFF].

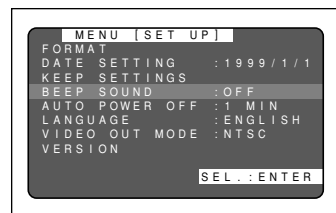

### How To Cancel the Setting

Follow the above procedures and select [ON] in step 3. And the beep will be enabled.



# Auto Power Off Setting

The camera will turn off automatically (auto power-off) in the recording and play modes to conserve the battery if it is in idle (no buttons or switches manipulated) for a length of time. The auto power-off mode can be disabled by setting it to off in either the record or play mode.

## ❶ Set the mode dial to [SETUP].

The setup menu is displayed.

- Note** • To cancel the operation, set the mode dial to another mode.

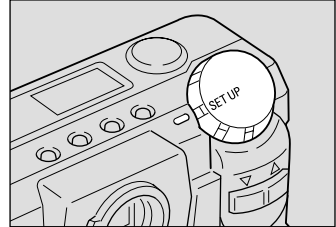

## ❷ Press the **or** button to select [AUTO POWER OFF].

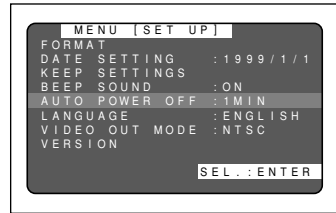

## ❸ Press the ENTER button and select the setting time (1 min., 3 min., 5 min.)

To end setting, rotate the mode dial and switch to another mode.

- Note** • Select OFF to disable the password.

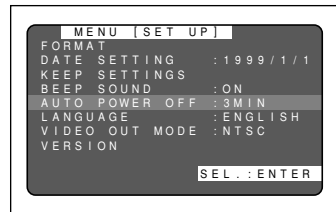

### How To reset settings

Perform the same operations as in step ❸ to change the setting time.

- Note** • Slide the power switch to reactivate the camera if it shuts off in auto power-off mode.
- When using an AC adapter, the auto power-off function is disabled even if you have set the auto power-off mode to on. (Except when performing interval shooting)

# Keep Settings

The keep settings mode is for preserving settings after the power is turned off. Each setting is saved and becomes effective when the camera is powered. The following settings can be saved.

- Flash (p.54)
- Recording mode (p.44)
- Date Imprint (p.65)
- CARD/IN (p.42)
- FOCUS (p.63)
- SOFT Mode (p.70)
- Exposure Compensation (p.57)
- White Balance (p.59)
- Language (p.106)
- S Mode (p.71)
- AUTO BRACKET (p.72)

## 1 Set the mode dial to [SETUP].

The setup menu is displayed.

- Note** • To cancel the operation, set the mode dial to another mode.

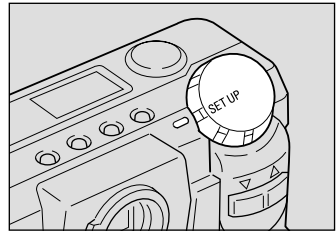

## 2 Press the **MENU** button or **SETUP** button to select [KEEP SETTINGS] and press the ENTER button.

The setup menu will be displayed.

- Note** • To cancel the operation and return to the setup menu, press the MENU button.

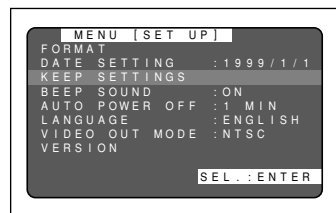

## 3 Press the **RIGHT** button or **DOWN** button to select a mode for setting the keep settings.

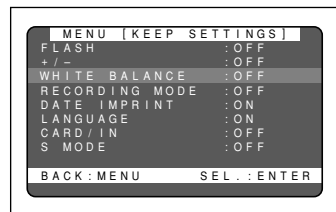

## 4 Press the ENTER button to change the setting to [ON].

With [REC Mode], press the ENTER button to select a mode to keep.

Keep Setting will be programmed. To program more items, repeat steps 3 and 4 as many times as needed.

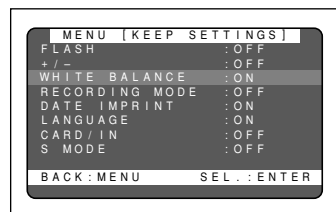

The settings of the items for which Keep Setting is programmed will be retained even when the camera is turned off.

**5 After confirming the setting, press the MENU button.**

The setup menu will be displayed. Set the mode dial to another mode.

**How To Cancel the Settings**

Follow the above procedures, changing the setting to [OFF] in step 4. The settings will now revert to their defaults when the power is shut off.

## Formatting Internal Memory

When internal memory becomes full, format it.



- Formatting internal memory will erase all the files recorded in it, whether they are protected or unprotected. Copy files to the SmartMedia memory card as needed before formatting internal memory. See “Copying Files” (p.84)

**1 Set the mode dial to [SETUP].**

The setup menu is displayed.



- To cancel the operation, set the mode dial to another mode.

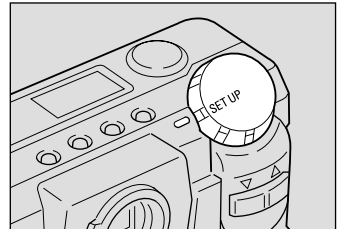



**2 Press the  or  button to select [FORMAT] and press the ENTER button.**

The format setup menu is displayed.

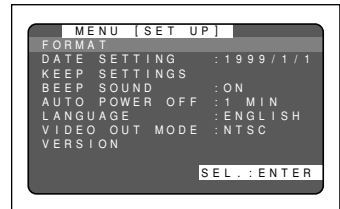

- To cancel the operation and return to the setup menu, press the MENU button.



**3 Press the  or  button to select [FORMAT INTERNAL MEMORY] and press the ENTER button.**

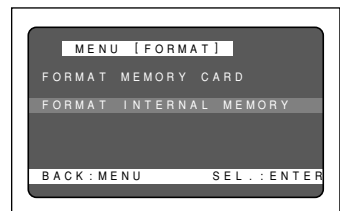

#### 4 Press the shutter release button.

The message "FORMATTING" is displayed and formatting of internal memory begins.

When the formatting is complete, the setup menu is displayed again. Set the mode dial to select another mode.

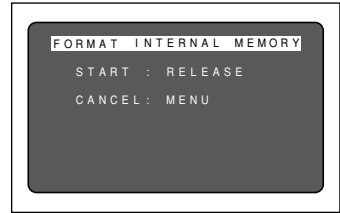

## Changing OSD (On-Screen Display) Language

The display of data on the liquid crystal can be switched between Japanese and other languages.

#### 1 Set the mode dial to [SETUP].

The setup menu is displayed.

- Note** • To cancel the operation, set the mode dial to another mode.

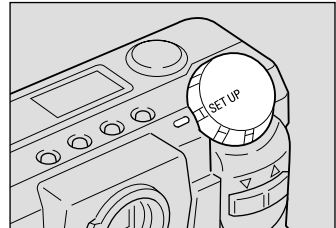

#### 2 Press the or button to select [LANGUAGE] and press the ENTER button.

- Note** • To cancel the operation and return to the setup menu, press the MENU button.

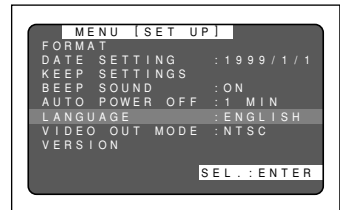

#### 3 Press the or button to select a language and press the ENTER button.

The display language setting is updated and the setup menu is displayed again.

When the setting is complete, set the mode dial to select another mode.

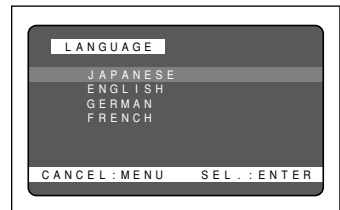

## How To Cancel the Setting

Follow the above procedures and select the other language in step ③ above. The display on the LCD monitor will then change accordingly.

- Note**
- Enable the save mode to save the language setting. See “Keep Settings” (p.104).

## Changing Video-Out Signal Method (NTSC/PAL)

Switches the video system for connecting the camera to a TV set to play record images on TV.

- See**
- See “Connecting to a TV”.
  - See “Using Your Digital Camera in Other Countries” (p.124).

### ① Set the mode dial to [SETUP].

The setup menu is displayed.

- Note**
- To cancel the operation, set the mode dial to another mode.

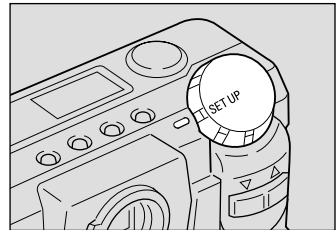

### ② Press the or button to select [VIDEO OUT MODE].

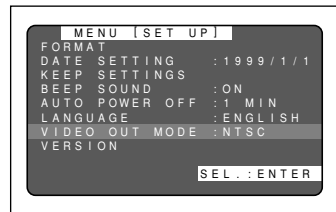

### ③ Press the ENTER button and select between [NTSC] and [PAL].

The video system setting is updated.

When the setting is complete, set the mode dial to select another mode.

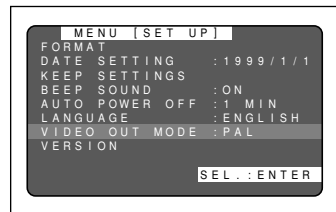

## How To Cancel the Setting

Follow the above procedures and select the other video system in step ③.



- When setting to PAL, this camera cannot be used as a monitor for the video printer, etc.
- The LCD monitor would appear blank when the video cable is connected to video gear.

## Changing LCD Confirmation

When you press the shutter release button to take a picture, the shot image appears on the LCD monitor, accompanied by a beep, before it is recorded. You can select the image confirmation time from among 0 second, 1 second, 2 seconds, and 3 seconds.

### ① Set the mode dial to [SETUP].

The SETUP menu will open.



- To cancel the operation, turn the mode dial.

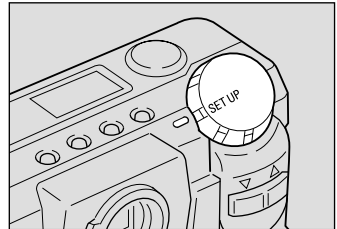

### ② Press the or button to select [LCD CONFIRMATION].

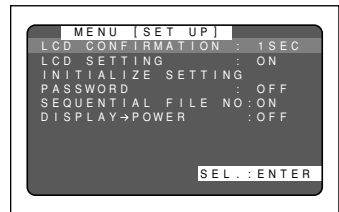

### ③ Press the ENTER button and select the image check time (0 sec., 1 sec., 2 sec., 3 sec.).

To end setting, rotate the Mode dial and switch to another mode.



- Images are not displayed when the image confirmation time is set to 0 sec. The images are recorded immediately after the photograph is taken.

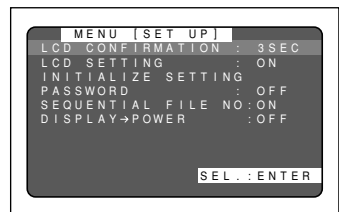

## Restoring the Setting

Select [0 SEC] in step ③ above.

# Changing the LCD Setting

The camera comes up with the LCD monitor enabled or disabled when it is powered on in a recording mode. You may set the camera to have the LCD monitor disabled when it is powered on, to save the batteries.

## 1 Set the mode dial to [SETUP].

The SETUP menu will open.

- Note** • To cancel the operation, turn the mode dial.

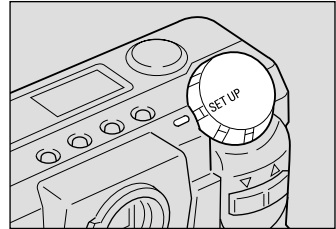

## 2 Press the **▲** or **▼** button to select [LCD SETTING].

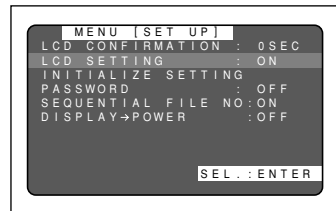

## 3 Press the ENTER button to select [OFF].

The camera, when powered on in a recording mode, will now come up with the LCD monitor disabled. Press the DISPLAY button to switch the monitor display. See “LCD Monitor Display” (p.41).

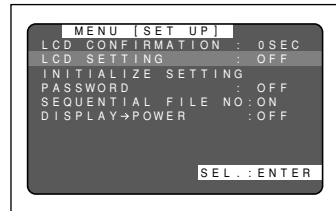

When the setting is complete, turn the mode dial to switch to another mode.

### Restoring the Setting

Select [ON] as an LCD initial display option in step 2.

# Initializing Settings

You can reset all settings, except for the date and the password.



- Data set by Keep Settings will also be initialized to its factory defaults.

## 1 Set the mode dial to [SETUP].

The SETUP menu will open.



- To cancel the setting, turn the mode dial to choose another mode.

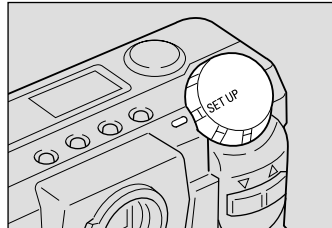

## 2 Press the or button to choose [INITIALIZE SETTING] and press the ENTER button.



- To cancel the operation, press the MENU button to return to the SETUP menu.

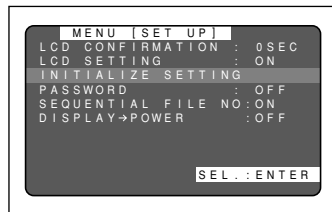

## 3 Press the shutter release button.

The settings will be reset to their factory defaults. Recorded files are preserved intact even when the settings are initialized.

When the initialization is complete, the SETUP menu appears again. Turn the mode dial to choose another mode.

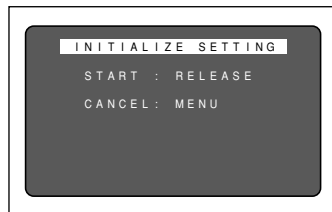



# Changing File Names

When SmartMedia is being used for recording, sequential numbers are assigned as the file names. When a file name other than a sequential number is preferred for each SmartMedia, change the setting as follows.

## ● With sequential numbering on (initial setting)

The file names R001 0001 to R999 9999 are assigned to the files.

Since the camera remembers the last file name assigned, the numbers will still be assigned in sequence, even when a new SmartMedia is used.

If the SmartMedia contains a number larger than the last file name remembered by the camera, however, the numbers assigned will continue from the last number in the SmartMedia.

- \* Continuous file names will be assigned even when a different SmartMedia is loaded. There is no duplication of file names.
- \* The file names within one SmartMedia may not be continuous in some cases.
- \* To reset the numbers, initialize the setting (page 110) and load a SmartMedia containing no images.

## ● When continuous numbering is off

The file names RIMG0001 to RIMG9999 will be assigned to the files.

When a new SmartMedia is loaded, the file names will be assigned in sequence, starting with RIMG0001. If a full SmartMedia is loaded, the consecutive numbers in the SmartMedia will be assigned.

- \* File names are assigned starting with RIMG0001 for each SmartMedia.
- \* When the file name becomes RIMG9999, "FILE NUMBER OVER" will be displayed. (p.13)

- Note**
- It is only possible to set whether or not consecutive numbers are to be used as file names when a SmartMedia is used. In the case of built-in memory, file names will be assigned starting with RIMG0001.
  - Using consecutive numbering for file names prevents is recommended when the images are to be used on a personal computer or in conjunction with a digital print service.
  - To reset the numbers to zero (0), either initialize the setting or load a smart media containing no images.

## ① Set the MODE dial to [SETUP].

The SETUP menu will appear.

- Note**
- Rotate the MODE dial to cancel the operation.

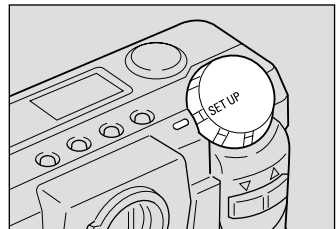

- ② Use the up or down button to select [SEQUENTIAL FILE NO].

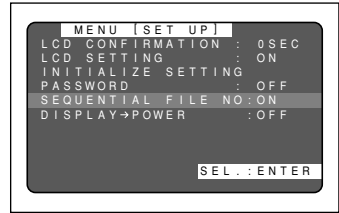

- ③ Press the ENTER button to select OFF.

When set to OFF, consecutive file names starting with RIMG0001 will be assigned to the files.

When the settings are complete, rotate the MODE dial to change to another mode.

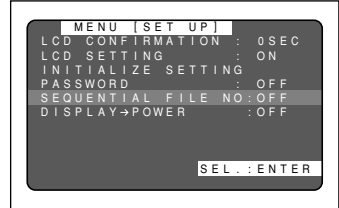

#### How To Cancel the settings

Follow the above procedures and select consecutive numbering to ON.

## Using the DISPLAY Button to Turn the Power ON and Off

Perform the following to use the DISPLAY button to turn the camera power on and off.

- ① Set the MODE dial to [SETUP].

The SETUP menu will appear.

- Note** • Rotate the MODE dial to cancel the operation.

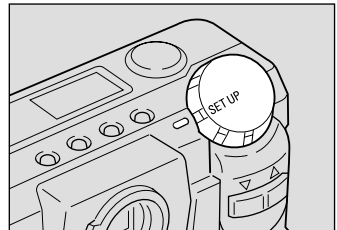

- ② Use the up or down button to select [DISPLAY → POWER].

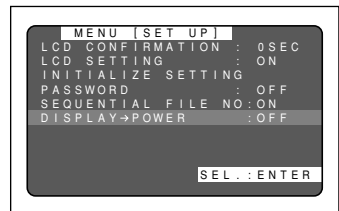

### 3 Press the ENTER button to select on.

When the settings are complete, rotate the MODE dial to change to another mode.

When the MODE dial is set to [📷], pressing the DISPLAY button for 2 or more seconds will turn the camera power on. Pressing the DISPLAY button again for 2 or more seconds will turn the power off. → Page 41

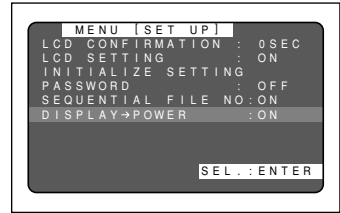

#### How To Cancel the Settings

Follow the above procedures and use DISPLAY → POWER in step 3 to select OFF.

## Checking the Version

It is possible to check the version of your camera.

### 1 Rotate the mode dial to [SETUP].

The Setup menu will be displayed.

- Note** • Rotate the mode dial to end the operation.

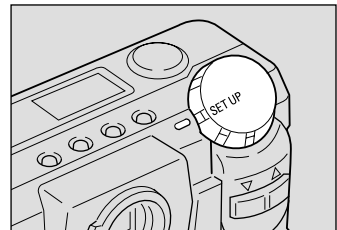

### 2 Press the and buttons to select [VERSION], then press the ENTER button.

The version data will be displayed.

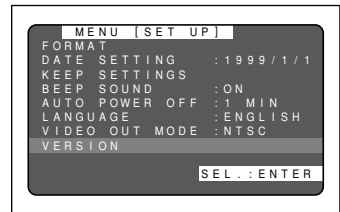

### 3 After checking the version, press the MENU button.

The Setup menu will return. Rotate the mode dial and switch to another mode.

# Using the Remote Control

The DR-3 remote control unit (optional) makes it possible to record and play back images from a remote location.



- The remote control receiver is located on the right side of the lens. Operate the remote control unit by pointing it at the remote control receiver.



- For instructions on replacing the batteries and maintaining the remote control unit, refer to the accompanying manual.
- Some procedures differ when performed on the remote control unit and on the camera itself. Follow the instructions below to use the remote control unit.

## Shooting

The remote control unit can be used to operate the camera. It is particularly convenient when the camera is set up at a remote location or is in a fixed position.

- 1 **Set the mode dial to [📷] and press the CARD/IN button to select a recording destination.**

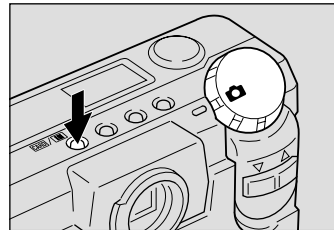

- 2 **Decide the composition of the picture and press the RELEASE button on the remote control unit.**

When the camera is set to the Still mode, the self-timer lamp will blink and recording will start approximately 2 sec. later. In the Continuous mode, recording will start immediately after the RELEASE button is pressed.

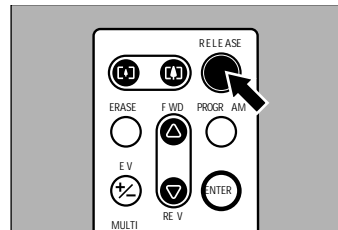

- Use the zoom buttons to vary the size of the subject. The [📷] button magnifies the subject (telephoto), while the [📷] button decreases the size of the subject (wide angle).

## Setting Exposure Compensation

### ● Starting setting

Press the EV (+/-) button on the remote control unit.

### ● Setting the exposure compensation level

Set the exposure compensation level using the FWD ( ) or REV ( ) button and press the ENTER button on the remote control unit. And then press the RELEASE button to take a picture.

### ● Canceling the setting

Set the exposure compensation level to  $\pm 0.0$ .

## Shooting in Manual Focus Mode

### ● Entering the mode

Press the ERASE button on the remote control unit.

### ● Focusing

Focus on the subject using the FWD ( ) or REV ( ) button. Press the RELEASE button to take a picture.

### ● Canceling the mode setting

Press the ERASE button again.

## Playing

Use the remote control unit to playback recorded files.

- 1 Set the mode dial to [▶] and press the CARD/IN button to select a recording destination.

The most recently recorded file will be played back.

**See** "Playback Display" (p.76)

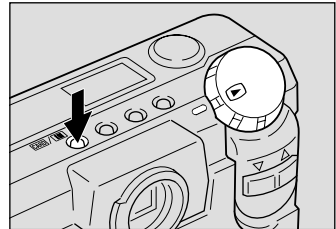

- 2 Choose a file by pressing the FWD ( ) or REV ( ) button on the remote control unit.

**Note** • The remote control unit buttons are operated in the same way as the buttons on the camera.

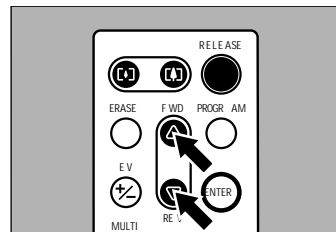

## Magnifying an Image (Zoom Playback)

### ● Entering the mode

Press the PROGRAM button on the remote control unit.

### ● Moving the playback position

Press the FWD ( ) or REV ( ) button.

### ● Canceling the mode setting

Press the ENTER button to return to the normal playback display.

## Displaying Multiple Images (Multi Image Playback)

### ● Entering the mode

Press the MULTI button on the remote control unit.

### ● Moving the selected file

Press the FWD ( ) or REV ( ) button.

### ● Canceling the mode setting

Press the ENTER button and the selected file will appear on the normal playback display screen.

## Erasing

You can use the remote control unit to erase a recorded file at a time.



- Remember that files cannot be restored once they are erased. Before starting to erase files, make sure that you want to erase them.

- 1 Set the camera's mode dial to [ ]. And press the CARD/IN button to select a source file to erase.

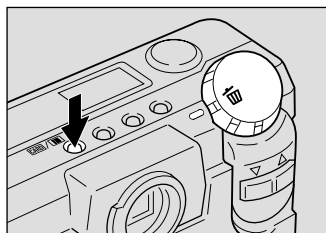

- 2 The erase menu will open. Use the FWD ( ) or REV ( ) button to select an erase mode.

Select [ERASE SINGLE IMAGE] from the erase menu to erase selected images one at a time.

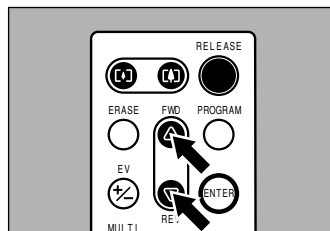

- ③ **Select a file to be erased by pressing the FWD ( ) or REV ( ) button on the remote control unit.**

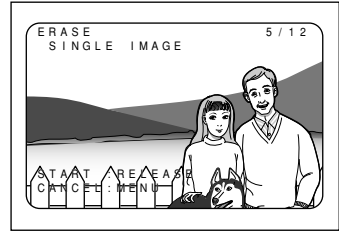

- ④ **Press the RELEASE button on the remote control unit.**

The file will be erased. To erase more files, repeat steps ③ and ④ as often as required.

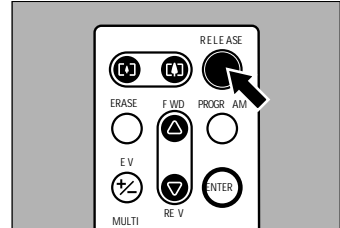

When erasure is completed, turn the mode dial to switch to another mode.

- Note** • If you select [ERASE ALL IMAGES] or [ERASE SELECTED IMAGES] in step ②, you can work with the remote controller the same way as you do with the camera.

### Clearing all files

- **Display the Clear All menu.**

Select Clear All in step ②.

- **Erase the files.**

Press the RELEASE button.

To cancel the operation, press the MENU button on the camera.

### Deleting multiple files

- **Display the Select Erase menu.**

Select Select Erase in step ②.

- **Specify the files to be erased.**

Press the FWD ( ) and REV ( ) buttons to specify the files to be erased, then press the ENTER button.

- **Erasing the files**

Press the RELEASE button.

Press the MENU button on the camera to exit the operation.

# Accessories

Item	Model	Remarks
AC Adapter	AC-3	For drawing power directly from a household electrical outlet. See "Using an AC Adapter" (p.29).
Remote Control Unit	DR-3	For remote operation of the camera's recording and playback functions.
SmartMedia Memory Cards		A postage stamp-sized storage media with a thickness of 0.76 millimeters.
4 M	FS-4	Capable of storing a maximum of (9) images recorded in 1800N mode.
8 M	FS-8	Capable of storing a maximum of (19) images recorded in 1800N mode.
16 M	FS-16	Capable of storing a maximum of (38) images recorded in 1800N mode.
32 M	FS-32	Capable of storing a maximum of (76) images recorded in 1800N mode.
PC Card Adapter	FS-B53	Used to insert the SmartMedia memory card directly into the PC card slot.
Floppy Disk Adapter	FS-B10	Used to insert the SmartMedia memory card directly into the PC floppy disk drive.

- Microsoft<sup>®</sup>, MS and Windows<sup>®</sup> are registered trademarks of Microsoft Corporation in the United States of America and other countries.
- Macintosh is a registered trademark of Apple Computer, Inc., in the United States of America and other countries.
- All trademarked company and product names mentioned in this manual are the property of their respective owners.
- SmartMedia<sup>™</sup> is a registered trademark of Toshiba Corporation.



# Handling Precautions

- This camera is not waterproof. Keep away from water, rain, beverages, etc. Consult your nearest Ricoh service office if any liquid gets into the camera.
- Be careful not to drop the camera or subject it to impacts.
- Do not use the flash more than necessary in continuous shots to avoid overheating.
- Never look through the viewfinder directly at the sun or intense light. Your eyesight may be impaired.
- Do not fire the flash close to a baby or infant's eyes.
- Do not fire the flash by aiming the camera at a driver behind the wheel. A traffic accident may result.
- Exercise caution to prevent sand or dust from getting into the camera in such environments as beaches or work sites.
- Do not leave the camera for any length of time in particularly hot or humid places, such as an automobile with the windows closed, beaches or bathrooms.
- Verify that the camera power is off before you attach the AC adapter.
- Direct sunlight and strong light striking the LCD monitor or the LCD panel will reflect white light, making it difficult to view.
- The LCD monitor or the LCD panel may contain some pixels that always or never illuminate and the brightness of some areas of the monitor may appear uneven. These are typical LCD performance characteristics and do not constitute malfunctions.
- Do not force any of the external moving parts, such as the card door, terminal cover or battery cover.
- Do not lift the camera by the hard cover, terminal cover or battery cover.
- Do not impede movement of the lens barrier while turning on the power.
- Be careful not to hit the lens unit or the LCD monitor while carrying the camera.
- Extreme temperature differentials may cause condensation to form inside the camera body and lens unit, reducing performance. To avoid this, place the camera in a plastic bag and let it slowly acclimate to the new temperature before exposing it.

## Potential Causes of Condensation

- Transporting the camera from a cold place to a warm place.
- Storing or using the camera in places subject to high humidity.
- Bringing the camera into a recently heated room or leaving it directly in the path of air conditioning.

# Care and Storage

---

## ■ Care

- Fingerprints or dirt on the lens will reduce performance so take extra care not to get it dirty.
  - Do not wipe dust or smears off the lens with your fingers. Use a lens blower, readily available at most photographic suppliers, to blow dust off, or a very soft cloth to wipe it lightly.
  - Be particularly diligent in cleaning the lens after use at the beach or around chemicals.
  - If your camera should malfunction, contact the Ricoh service center. This product generates high voltages and disassembly is hazardous. Under no circumstances should you attempt to disassemble it yourself.
  - Never use solvents, benzine, insecticides or other volatile substances on the equipment as this may deform or dissolve it.
  - Be careful not to let objects rub against the LCD monitor or the LCD panel as it is readily susceptible to scratching.
  - To clean the LCD monitor or the LCD panel, wipe it gently with a soft cloth that has been moistened in diluted detergent and well-wrung. Wipe off any moisture with a soft, dry cloth.
- \* Remove the batteries and AC adapter from the camera before commencing any of the above.

## ■ Storage

To prevent possible failures, avoid storing the camera in places that are:

- Hot and damp, or subject to sharp temperature or humidity changes.
- Sandy or dusty.
- Subject to strong vibrations.
- In contact with chemicals, such as insecticides, or rubber or PVC products for extended periods of time.
- Near sources of strong electromagnetism (such as motors, transformers, and magnets).

# Troubleshooting

Refer to the pointers listed below before submitting the equipment for repairs. If the problem persists after trying the suggestions, contact the Ricoh service center listed at the back of this manual.

## ■ Power Source

Problem	Cause	Solution	Page
Power will not come on	Batteries dead, improperly installed or missing	Insert the batteries correctly or replace them.	27
	AC adapter not attached correctly	Attach correctly again.	29
	Card door open	Close the card door and retry starting.	32
Power cuts out	No buttons touched so auto power-off function was activated	Restart camera.	41
	Dead batteries	Replace with new batteries.	27
Battery quickly consumed	Camera operated in extremely high or low temperature location	–	–
	Camera operated in dark area requiring frequent use of the flash	–	–

## ■ Recording and Playback

Problem	Cause	Solution	Page
Shutter release button pressed but no image recorded	Batteries dead, improperly installed or missing	Replace or reposition batteries.	27
	No power, or mode dial is not set	Slide power on and set mode dial to [📷]	41
	Shutter release button only pressed halfway	Press shutter release button all the way.	48
	SmartMedia memory card not formatted (initialized)	Format SmartMedia memory card.	33
	No space on SmartMedia memory card	Erase unimportant files or replace SmartMedia memory card.	32, 94
	No space on internal memory	Erase unimportant files	94
	SmartMedia memory card not working (service life exceeded)	Replace SmartMedia memory card.	32
	Card door open	Ensure that card door is securely closed.	32
	Self-timer on	Press the self timer button to disengage the self timer recording mode.	61
	Flash is charging	Wait until flash LED ceases flashing.	48
SmartMedia memory card contact surface dirty	Clean contact surface with soft dry cloth.	31	
Cannot confirm a shot picture	The image confirmation time is too short.	Make the image confirmation time longer.	108
No image on the LCD monitor	The LCD monitor is turned OFF.	Press the DISPLAY button to turn ON the LCD monitor, or set [LCD Initialization] to [ON].	41, 109
	The video I/O switch is set on [IN].	Set video I/O switch is set on [OUT].	77
	Either set the NTSC video system or disconnect the video cable.	A video cable is connected when the video system is set to PAL.	107
Autofocus is on but camera not focusing	Dirty lens	Clean lens with blower or soft dry cloth.	–
	Subject not in the center of the autofocus field	Use focus lock	62
	Subject difficult to focus	Use focus lock or switch to manual focus.	62, 63

Problem	Cause	Solution	Page
Flash won't fire, or won't charge	Camera not set to PIC mode	Use record menu to set record to PIC mode.	44
	Camera set to flash off mode	Cancel the flash off mode with flash button.	55
	White balance mode set to setting other than auto	Use record menu to set the white balance to auto.	59
	Batteries dead	Replace batteries.	27
Image dark even with flash	Subject farther than approx. 3.0 m (9.9 feet) with the zoom on telephoto or approx. 3.4 m (11.2 feet) with the zoom on wide angle	Move closer to subject.	54
Image is too bright	The camera is too close to the subject.	Retake picture without flash.	55
	Over-exposed	Use record menu to adjust exposure compensation.	57
	Brightness setting of LCD monitor not adjusted	Adjust brightness adjustment dial.	37
Image is too dark	Shot in low light area with camera set to flash off mode	Press the flash button disengage flash off mode.	55
	Under-exposed	Use record menu to adjust exposure compensation.	57
	Brightness setting of LCD monitor not adjusted	Adjust brightness adjustment dial.	37
Unnatural coloration of image	Shooting conditions difficult for white balance in auto mode	Place a white object near the subject, use the flash or select one of the manual white balance modes.	55, 59
Date and other recording data will not display	Screen display set to off	Press the ENTER button to switch screen display mode.	50
Can't playback or image won't appear	Camera not set to play mode	Set mode dial to [D].	79
	The playback source is different	Press the CARD/IN button to change the playback source	79
	SmartMedia memory card not installed or doesn't contain any files	Insert a SmartMedia memory card with recorded images.	32
	Use of a SmartMedia memory card not formatted by your camera	Use a SmartMedia memory card that has been formatted and recorded by your camera.	32
	SmartMedia memory card contains incorrectly recorded files	Insert a SmartMedia memory card containing pictures properly recorded by the camera.	32
	SmartMedia memory card contains files in a format not read by the camera.	Check the format type	76
	Card door open	Ensure that card door is securely closed.	32
	Video interface cable poorly connected	Check connection.	77
	Source of interference, such as electric motor, nearby	Relocate camera away from source.	-
	SmartMedia memory card contact surface dirty	Clean contact surface with soft dry cloth.	31
	The video I/O switch is set on [IN].	Set video I/O switch is set on [OUT].	77
Replay is not clear	Error in internal memory in the camera	Copy required files from internal memory to the SmartMedia memory card and format internal memory.	84, 105
	Error with SmartMedia memory card	Test camera with another SmartMedia memory card. If second card displays well, problem is with card not camera.	-

Problem	Cause	Solution	Page
Display shut off	Dead batteries	Replace batteries.	27
	Auto power-off activated	Slide power on again.	41
Remote control unit will not work	Obstruction between the remote control unit and camera sensor	Remove the obstruction. (Sensor is on the left side of the lens.)	–
	Dirty remote control transmitter or camera sensor	Clean with a soft dry cloth.	–
	Dead remote control batteries	Replace CR2032 lithium batteries.	–
LCD monitor brightness changes during autofocus operation	Area captured by autofocus field and the surrounding area have contrasting light levels or the entire subject is dark.	There is no malfunction.	–
Vertical lines appear on image	Phenomenon occurring with pictures of bright subjects, known as the smudge phenomenon	There is no malfunction. Never shoot the Sun, etc.	–

## ■ Miscellaneous

Problem	Cause	Solution	Page
SmartMedia memory card will not fit into slot	Wrong type of SmartMedia memory card	Use a SmartMedia memory card specified for the camera.	32
	SmartMedia memory card incorrectly oriented	Insert the SmartMedia memory card the correct way.	32
Camera will not operate even when buttons and switches are manipulated	Dead batteries	Replace batteries.	27
	Camera malfunction	Slide the power off and on once. Turn the mode dial to [📷] or [📷]. If the problem persists, (1) reset the camera by sliding the power switch after removing the main batteries, and (2) reinstall the batteries and try to operate the camera again.	–
Date and time are wrong	Date and time setting is incorrect	Reset the date and time.	35
Date and time were set but disappeared	Battery removed	The date setting is reset if the battery has been removed for about 3 minutes or longer. Set the date again.	35
File won't erase or SmartMedia memory card won't format	Camera not set to erase mode	Turn the mode dial to [🗑️].	94
	Write protect pad on SmartMedia memory card	Remove pad from SmartMedia memory card.	31
	File protected	Use the play menu to reset the file's protection setting.	83, 91
Power switch off or auto power-off activated.	Power switch off or auto power-off activated.	Slide power on and retry.	103
	Batteries have been removed	Reset mode.	102
Auto power-off will not activate	Auto power-off setting is disabled	Enable setting.	103
	Camera powered by AC adapter (auto power-off is automatically disabled when powered by an AC adapter)	–	–
Beep will not sound	Beep disabled	Set beep sound to [ON] on the SETUP menu.	102
	No image on the TV screen	Set video I/O switch is set on [OUT].	77
The television system setting is incorrect.	The television system setting is incorrect.	Select the correct television system.	107
	The output video gear has an incorrect video I/O switch setting.	Check to see if the output video gear has a correct video I/O switch setting.	–

# Using Your Digital Camera in Other Countries

## Ricoh AC-3 AC adapter (optional)

- The AC-3 AC adapter adjusts automatically to voltages ranging from 100V to 240V AC and frequencies of 50Hz to 60Hz.
- Some countries use electrical outlets which have different shapes. Before leaving on a trip, obtain the necessary plug adapter from a travel agent or electric store.

## Using a Local TV Receiver for Playing Pictures

- You can play pictures taken with this camera on a TV receiver (or monitor) furnished with a video input terminal. Use the video interface cable supplied.
- This camera supports two television systems: NTSC and PAL. Switch your camera's video system to meet the local video environment. See "Changing Video-Out Signal Method (NTSC/PAL)" (p.107).
- If you plan to take the camera with you on a trip abroad, identify the local television system beforehand.

# About the Warranty and Servicing

1. The Ricoh RDC-5300 camera is backed by a one-year limited warranty. During the warranty period, which starts from the date of purchase, any defective parts will be repaired free of charge. In the event of a camera malfunction, contact the dealer from which you purchased the camera or contact the nearest Ricoh service office. Please note that you will be charged for the cost of shipping the camera from the Ricoh service office to your residence.
2. This warranty does not cover any damage resulting from:
  - ① Failure to follow the instructions in this instruction manual;
  - ② Repair, modification or overhaul not conducted by an authorized service center;
  - ③ Fires or natural disaster;
  - ④ Improper storage, such as exposing the camera to high temperatures, humidity, or mothballs; storing it with leaking batteries; storing the camera in a dirty condition so that it becomes moldy; or otherwise insufficiently caring for the camera.
  - ⑤ Submergence; exposure to floods or spilled alcoholic or other beverages; allowing sand or mud to enter the camera; exposure to physical shocks; or dropping of the camera.
3. After a full year has passed from the purchase date, you will become responsible for all repair fees, including those incurred at an authorized service center.
4. You will be responsible for all repair fees, even within the warranty period, if the warranty card is not attached or if the distributor's name or the purchase date have been changed or are not indicated on the card.
5. Expenses for overhauls and thorough inspections as a result of a customer's special request will be charged to the customer, whether or not they are incurred during the warranty period.
6. This warranty only applies to the camera and not to the accessories, such as the hard case and wrist strap, nor does it apply to the consumables provided, such as batteries.
7. Any consequential damage arising from the failure of this camera, such as expenses for taking pictures or loss of expected profit, will not be reimbursed whether it occurs during the warranty period or not.
8. The above provisions refer to repairs offered free of charge, and do not limit your legal rights. The intention of the above provisions is also described in the warranty card provided with this camera.
9. Parts essential to the servicing of this camera - that is, components required to maintain the functions and quality of this camera - will be available for a period of seven years after the camera is discontinued. However, as some of those parts are kept for a longer period, do not hesitate to contact your distributor or the nearest Ricoh service representative even after the seven-year period.
10. Please note that, if the camera is seriously damaged from flooding, submergence, infiltration of sand or mud, violent shocks or dropping, the camera may not be repairable, and restoration to its original condition may be determined to be impossible.

**Note**

- Before sending the camera in for repair, check the batteries and read this instruction manual again to ensure proper operation.
- Some repairs require a significant amount of time to be completed. Please allow sufficient time for repairs.
- When sending the camera to a service representative, please include a note which describes the defective part and the problem as precisely as possible.
- Remove all accessories not related to the problem before sending the camera to a service representative.
- Before taking any important pictures (such as at weddings, on trips abroad, etc.) test the camera to check its operation and ensure proper functioning. We recommended that you keep this manual and spare batteries on hand.



# Specifications

## ■ General

- **Video Signal Protocol** : PAL/NTSC
- **Power Source and Voltage** : Batteries: 6 volts  
AC: 5 volts
- **Dimensions (W × H × D)** : 131.1 × 68.8 × 54.0 mm (5.17" × 2.71" × 2.13")  
(excluding grips)
- **Weight** : Approximately 350 g (12 oz.) (excluding batteries)
- **Operating Range - Temperature** : 0° to 40° C (32° to 104 F)
- **Operating Range - Relative Humidity** : 85% or less
- **Storage** : -20° to 60°C (-4° to 140°F)

## ■ Camera

- **CCD** : 2,310,000 million square pixels (effective: 2,160,000 million)
- **Lens** : Zoom lens F=3.2 - 3.7
  - Focal length : f=8 - 24 mm (equivalent to 38-114 mm on 35mm camera format)
  - Minimum shooting range : Approximately 4.0 cm (1.6") (macro)
- **Viewfinder**
  - Type : Real image
  - Magnification : Telescope 0.35X, standard 0.57X, wide angle 1.00X
  - Parallax correction : No
  - Diopter : -1 dpt
- **Monitor**
  - Display Size : 1.8"
  - Drive System : TFT Active Matrix System
  - Picture Elements : Approximately 110,000 pixels
- **White Balance** : Auto/Preset (Daylight, Cloudy (Overcast), Fluorescent Light, Tungsten Light)
- **Exposure Compensation**
  - Light Metering System : Centerweighted
  - Exposure Value Memory System : Auto backlighting detection  
Manual compensation, ±2.0 EV (in 0.5 EV increments)
  - Metering : TTL-CCD method
  - Flash Automatic Exposure : Yes (daylight synchro)
  - Shutter Speed : 1-1/500
  - Minimum diaphragm setting : F 15.0 – F 17.2
  - ISO Sensitivity : Approximately equivalent to 100
- **Distance Adjustment**
  - Autofocus Method : TTL-CCD AF
  - Autofocus Range : Approximately 4.0 cm (1.6") to infinity

## ● Built-in Flash

- Type : Auto
  - Range : About 4.0 cm to 3.0 m (telescope)  
About 4.0 cm to 3.4 m (wide angle)
  - Modes : Off/On (Forced flash/Slow synchro)/Auto/Red-eye reduction
- External strobe socket : built-in (conforms to JIS B7102)

## ■ Image Data Recording and Playback

- Image Resolution : 1792 × 1200, 896 × 600, 640 × 480 pixels
- File Format : JPEG (Exif2.1)
- Camera : DCF is the abbreviation of the standard "Design rule for Camera File system" which was standardized by the JEIDA
- Compression Format : JPEG baseline method
- Approximate File Sizes
  - 1792 × 1200 : F mode: approx. 813 KB, N mode: approx. 410 KB, E mode: approx. 246 KB,
  - 896 × 600 : F mode: approx. 276 KB, N mode: approx. 141 KB, E mode: approx. 74 KB
  - 640 × 480 : F mode: approx. 157 KB, N mode: approx. 82 KB, E mode: approx. 45 KB

## ■ Input/Output Terminal

- Power input : 5 V (AC adapter)
- Video output : 1.0 Vp - p (75 W)
- RS-232 C/AUX/USB : Exclusive

## ■ Body

### ● Tripod Screw Hole

- : Tapped (1/4-20 UNC)
- : Length: less than 5.7 mm (0.22")

## ■ Power Supply

### ● Main Batteries

- Type : AA alkaline batteries  
: AA Ni-MH batteries  
: AA Ni-Cd batteries
- Voltage : 6 volts (1.5 volts × 4 batteries)

### ● Date backup battery

- : About 3 minutes

### ● Auto Power-Off

- : Activated after more than 1, 3, 5 minutes

## ■ Internal Memory

- Capacity : 8 MB

## ■ Compatible Memory Cards for Recording and Playback

- Type of Memory : SmartMedia memory card
- Capacity : 2, 4, 8, 16, 32, 64 MB
- Operating Voltage : 3.3 volts

# Recording Capacities

The table below gives approximate recording picture counts available by SmartMedia memory card capacity and by PIC mode.

Type	PIC Mode	Recording Mode	Approximate Recording Picture counts
2MB	1800 × 1200	F	2
		N	4
		E	7
	900 × 600	F	7
		N	14
		E	26
	640 × 480	F	12
		N	23
		E	41
4MB	1800 × 1200	F	4
		N	9
		E	15
	900 × 600	F	14
		N	27
		E	49
	640 × 480	F	24
		N	45
		E	82
8MB	1800 × 1200	F	9
		N	19
		E	32
	900 × 600	F	29
		N	55
		E	99
	640 × 480	F	49
		N	90
		E	165

Type	PIC Mode	Recording Mode	Approximate Recording Picture counts
16MB	1800 × 1200	F	19
		N	38
		E	62
	900 × 600	F	58
		N	110
		E	199
	640 × 480	F	99
		N	166
		E	332
32MB	1800 × 1200	F	39
		N	76
		E	124
	900 × 600	F	117
		N	221
		E	399
	640 × 480	F	199
		N	332
		E	665
64MB	1800 × 1200	F	79
		N	153
		E	249
	900 × 600	F	235
		N	443
		E	799
	640 × 480	F	399
		N	665
		E	1331



- The picture size of 640 × 480 is available with the digital zoom function enabled.
- Internal memory is similar to an 8 MB SmartMedia memory card.



### Declaration of Conformity

“The Product complies with the requirements of the EMC Directive 89/336/EEC.”

## INFORMATION TO THE USER

### USA FCC Part15 Class B

The equipment has been tested and found to comply with the limits for a Class B digital device, pursuant to part 15 of the FCC Rules. These limits are designed to provide reasonable protection against harmful interference in a residential installation. This equipment generates, user, and can radiate radio frequency energy and if not installed and used in accordance with the instructions, may cause harmful interference to radio communications. However, there is no guarantee that interference will not occur in a particular installation. In this equipment does cause harmful interference to radio or television reception, which can be determined by turning the equipment off and on, the user is encouraged to try to correct the interference by one or more of the following measures:

- Reorient or relocate the receiving antenna.
- Increase the separation between the equipment and receiver.
- Connect the equipment to outlet on a circuit different from that to which the receiver is connected.
- Consult the dealer or an experienced radio/TV technician for help. (FCC 15.105B)

Changes or modifications not expressly approved by the party responsible for compliance could void the user's authority to operate the equipment. (FCC 15.21)

Properly shielded and grounded cables and connectors must be used for connection to a host computer in order to comply with FCC emission limits. (FCC 15.27)

An AC adapter with a ferrite core must be used for RF interference suppression.

### COMPLIANCE INFORMATION STATEMENT

Product Name: Ricoh Digital Camera

Model Number: RDC-5300

This device complies with Part 15 of the FCC Rules.

Operation is subject to the following two conditions:

- (1) This device may not cause harmful interference, and
- (2) This device must accept any interference received, including interference that may cause undesired operation.

RICOH CORPORATION

5 Dedrick Place, West Caldwell NJ, 07006 Tel.: 1-800-225-1899

### Note to Users in Canada

**Note:** This Class B digital apparatus complies with Canadian ICES-003

### Remarque Concernant les Utilisateurs au Canada

Avertissement: Cet appareil numérique de la classe B est conforme a la norme NMB-003 du Canada

IMPORTANT SAFETY INSTRUCTIONS-SAVE THESE INSTRUCTIONS DANGER-TO REDUCE THE RISK OF FIRE OR ELECTRIC SHOCK, CAREFULLY FOLLOW THESE INSTRUCTIONS.

# Ricoh Service Offices

---

Ricoh Co., Ltd.  
Ohmori NM Building  
1-1 Ohmori-Kita 2-chome  
Ota-ku, Tokyo  
143-0016 JAPAN  
<http://www.ricoh.com>

Ricoh Factory Service Center  
3235 Sunrise Blvd.,  
Suite2 Rancho Cordova,  
CA 95742  
<http://www.ricohcpg.com/>

Ricoh Europe B.V.  
Photo Products Division  
P.O. Box 75640  
1118 ZR Schiphol  
The Netherlands  
<http://www.ricoh-red.com/>  
<http://www.ricoheurope.com/>  
E-mail:camera@ricoh.nl

Ricoh Europe B.V.  
European Digital Solution Center  
Oberrather Straße 6  
D-40472 Düsseldorf  
Germany

Ricoh Photo Products (Asia), Ltd.  
Unit D, E & F  
24/F., China Overseas Building  
139 Hennessy Road, Wan Chai  
Hong Kong

Ricoh Australia Pty. Ltd.  
148 Highbury Road  
Burwood, Victoria, 3125  
Australia  
<http://www.ricoh-aust.com.au>



**RICOH CO., LTD.**

Ohmori NM Building  
1-1 Ohmori-kita 2 chome  
Ota-ku, Tokyo  
143-0016 Japan  
L 2102546C

Download from [Www.Somanuals.com](http://Www.Somanuals.com). All Manuals Search And Download.

## Free Manuals Download Website

<http://myh66.com>

<http://usermanuals.us>

<http://www.somanuals.com>

<http://www.4manuals.cc>

<http://www.manual-lib.com>

<http://www.404manual.com>

<http://www.luxmanual.com>

<http://aubethermostatmanual.com>

Golf course search by state

<http://golfingnear.com>

Email search by domain

<http://emailbydomain.com>

Auto manuals search

<http://auto.somanuals.com>

TV manuals search

<http://tv.somanuals.com>