

RICOH

Small Cubic Type

UXGA CCD

Monochrome PoCL Camera Link Camera

FV-L200B1

User's Guide

RICOH COMPANY, LTD.

Table of Contents

1	Connector Specifications	3
1.1	Camera Link Connector	3
1.2	Power-I/O Connector	4
2	Camera Output Timing Charts	5
2.1	Normal Mode (Setting 10H: 1XX0XXXX)	5
2.1.1	Horizontal Timing	5
2.1.2	Vertical Timing	6
2.1.2.1	Normal Full Scanning (Setting 10H: 1XX00XXX, 11H: X000X000)	6
2.1.2.2	Partial Full Scanning (Setting 10H: 1XX01XXX, 11H: X000X000)	6
2.1.2.3	1/2 Partial Scanning (setting 10H: 1XX01XXX, 11H: X000X001)	7
2.1.2.4	1/4 Partial Scanning (Setting 10H: 1XX01XXX, 11H: X000X010)	7
2.1.2.5	Variable Partial Scanning (setting 10H: 1XX01XXX, 11H: X000X111)	8
2.2	Binning Mode (setting 10H: 1XX1XXXX)	9
2.2.1	Horizontal Timing	9
2.2.2	Vertical Timing	10
2.2.2.1	Binning Full Scanning (setting 10H: 1XX10XXX, 11H: X000X000)	10
2.2.2.2	Binning Partial Full Scanning (setting 10H: 1XX11XXX, 11H: X000X000)	10
2.2.2.3	Binning 1/2 Partial Scanning (setting 10H: 1XX11XXX, 11H: X000X001)	11
2.2.2.4	Binning 1/4 Partial Scanning (setting 10H: 1XX11XXX, 11H: X000X010)	11
2.3	Data Order on the Camera Link Output	12
2.4	1 Taps Transferring Image (1X-1Y)	13
2.5	Pixel Transferring Image	13
3	Camera Operational Mode	14
3.1	Normal Mode	14
3.1.1	Frame Exposure	14
3.1.2	Electric Shutter	14
3.2	Pulse Width Trigger Mode	15
3.2.1	Pulse Width Trigger Mode (V-Reset)	15
3.2.2	Pulse Width Trigger Mode (Non-Reset)	16
3.2.3	Exposure Timing	16
3.3	Edge Preset Trigger Mode	17
3.3.1	Edge Preset Trigger Mode (V-Reset)	17
3.3.2	Edge Preset Trigger Mode (Non-Reset)	18
3.3.3	Exposure Timing	18
3.4	H Reset Mode	19
4	Communication Protocol	20
4.1	Communication Method	20
4.2	Communication Settings	20
4.3	Communication Format	20
4.4	Camera Control Command	23
4.4.1	Camera Command List	23
4.4.2	Descriptions of the Camera Control Commands	25

1 Connector Specifications

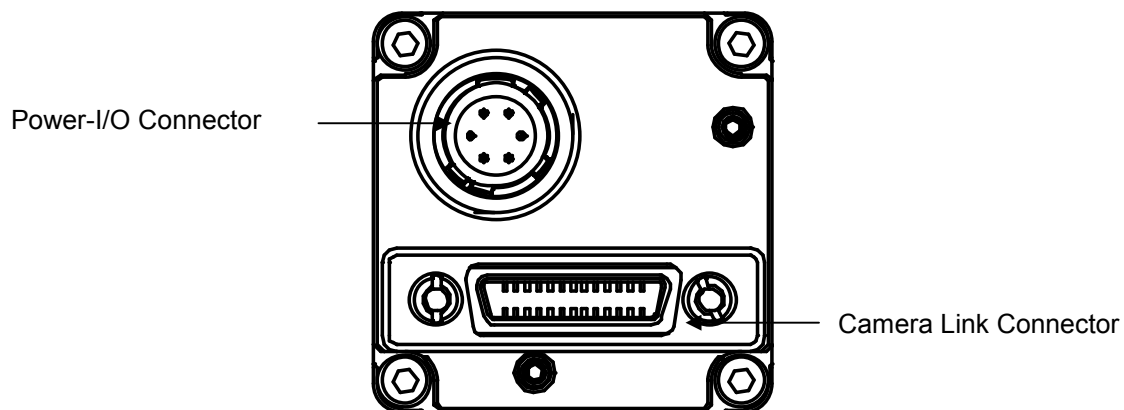

1.1 Camera Link Connector

SDR (3M) or equivalent

This product is a PoCL type.

When a frame grabber board is PoCL compliant, DO NOT SUPPLY POWER FROM THE I/O CONNECTOR.

When a frame grabber board is NOT PoCL compliant, supply power from the I/O connector.

Pin Assignment

Pin No.	Signal Name	Pin No.	Signal Name
1	+12V	14	GND
2	X0-	15	X0+
3	X1-	16	X1+
4	X2-	17	X2+
5	Xclk-	18	Xclk+
6	X3-	19	X3+
7	SerTC+	20	SerTC-
8	SerTFG-	21	SerTFG+
9	CC1-(TRG)	22	CC1+(TRG)
10	CC2+	23	CC2-
11	CC3-	24	CC3+
12	CC4+	25	CC4-
13	GND	26	+12V

1.2 Power-I/O Connector

- HR10A-7R-6PB (Hirose) or equivalent
- This connector is for the power supply (12Vdc) and input /output signals.
- Use HR10A-7P-6S (Hirose) or equivalent for the cable side.

Pin Assignment

Pin No.	Signal Name	IN / OUT	Voltage		
				Low Voltage	High Voltage
1	GND	IN	0V		
2	I/O-1	IN	0 to +0.5	+2.5 to +5.0V	
		OUT	0V	+3.3V	
3	I/O-2	IN	0 to +0.5	+2.5 to +5.0V	
		OUT	0V	+3.3V	
4	I/O-3	IN	0 to +0.5	+2.5 to +5.0V	
		OUT	0V	+3.3V	
5	I/O-4	IN	0 to +0.5	+2.5 to +5.0V	
		OUT	0V	+3.3V	
6	+12Vdc	IN	+12Vdc		

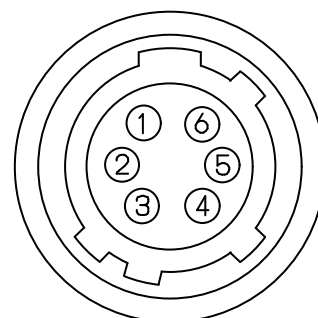

- Input/output signals can be assigned through the camera setting communication (see table 4).
- Trigger input signal can be assigned either on Camera Link connector (CC1) or on the No. 2 pin of the IO connector through the camera setting communication.

IO Signal Patterns

	Command No.		HR10A-7R-6PB (Hirose)			
	F0H[3..0]	11H[7]	No.2 Pin	No.3 Pin	No.4 Pin	No.5 Pin
			I/O-1 (SP4)	I/O-2 (SP3)	I/O-3 (SP2)	I/O-4 (SP1)
Option 0 (Initial Setting)	0H	0 (initial setting)	IN/TRG	IN/-	IN/-	OUT/ STROBE
		1	IN/TRG	OUT/VD	OUT/HD	OUT/ STROBE
Option 1	1H	-	For Test Use Only			
Option 2	2H	-	OUT/CC4	OUT/CC3	OUT/CC2	OUT/CC1
Option 3	3H	-	OUT/FVAL	OUT/XSG	OUT/XSUB	OUT/CC1
Option 4	4H	-	OUT/FVAL	OUT/LVAL	OUT/DVAL	OUT/PIC_D9 (MSB)
Option 5	5H	-	OUT/XHD (high-active)	OUT/EXPDUR (Exposure)	OUT/TRG	OUT/CC1
Option 6	6H	-	OUT/VD	N/A	N/A	OUT/HD
Others	7H-FH	-	For Test Use Only			

2 Camera Output Timing Charts

2.1 Normal Mode (Setting 10H: 1XX0XXXX)

	Normal Full Scanning			Partial Full Scanning			1/2 Partial Scanning			1/4 Partial Scanning		
Clock Speed (MHz)	Normal	x1/2	x1/4	Normal	x1/2	x1/4	Normal	x1/2	x1/4	Normal	x1/2	x1/4
Frame Rate (Hz)	15.3	7.6	3.8	15.4	7.7	3.9	30.6	15.3	7.7	61.3	30.6	15.3

※Clock Speed: 36.8181 MHz (Normal), 18.40905 MHz (x1/2) , 9.204525 MHz (x1/4)

2.1.1 Horizontal Timing

1 CLK = 108.6422 ns at 3.8fps
 1 CLK = 54.3211 ns at 7.6fps
 1 CLK = 27.1605 ns at 15.3fps

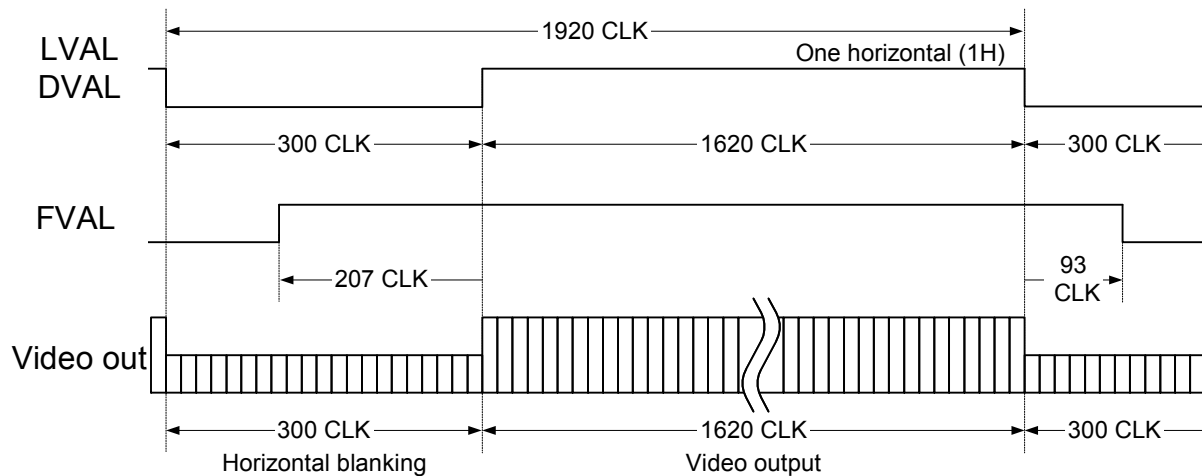

2.1.2 Vertical Timing

2.1.2.1 Normal Full Scanning (Setting 10H: 1XX00XXX, 11H: X000X000)

1 H = 208.5963 μ s, 3.8291 Hz at 3.8fps
 1 H = 104.2968 μ s, 7.6582 Hz at 7.6fps
 1 H = 52.1484 μ s, 15.3164 Hz at 15.3fps

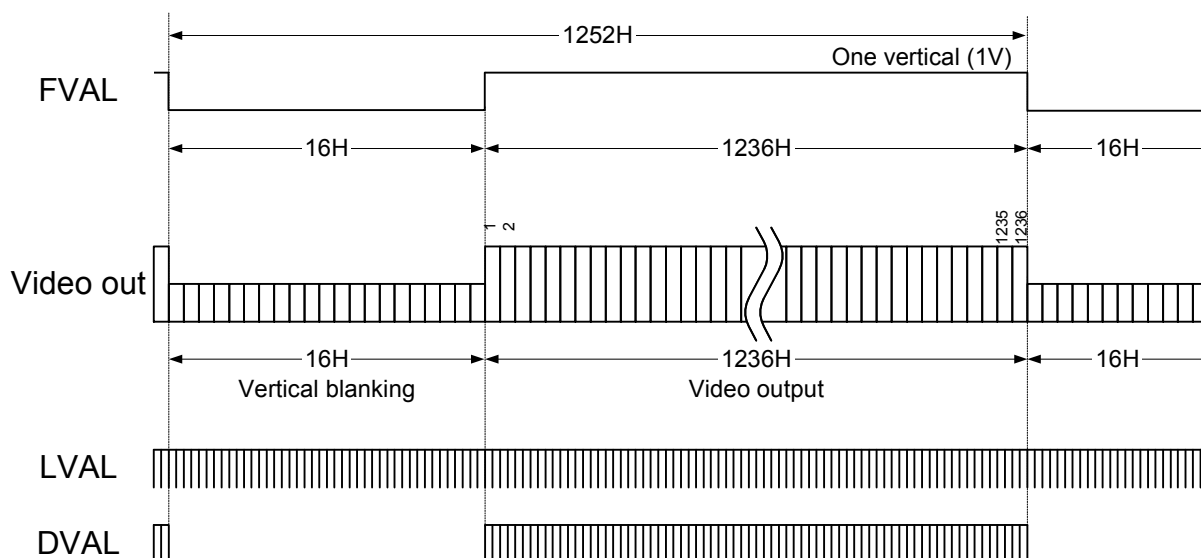

2.1.2.2 Partial Full Scanning (Setting 10H: 1XX01XXX, 11H: X000X000)

1 H = 208.5963 μ s, 3.8599 Hz at 3.8fps
 1 H = 104.2968 μ s, 7.7199 Hz at 7.6fps
 1 H = 52.1484 μ s, 15.4397 Hz at 15.3fps

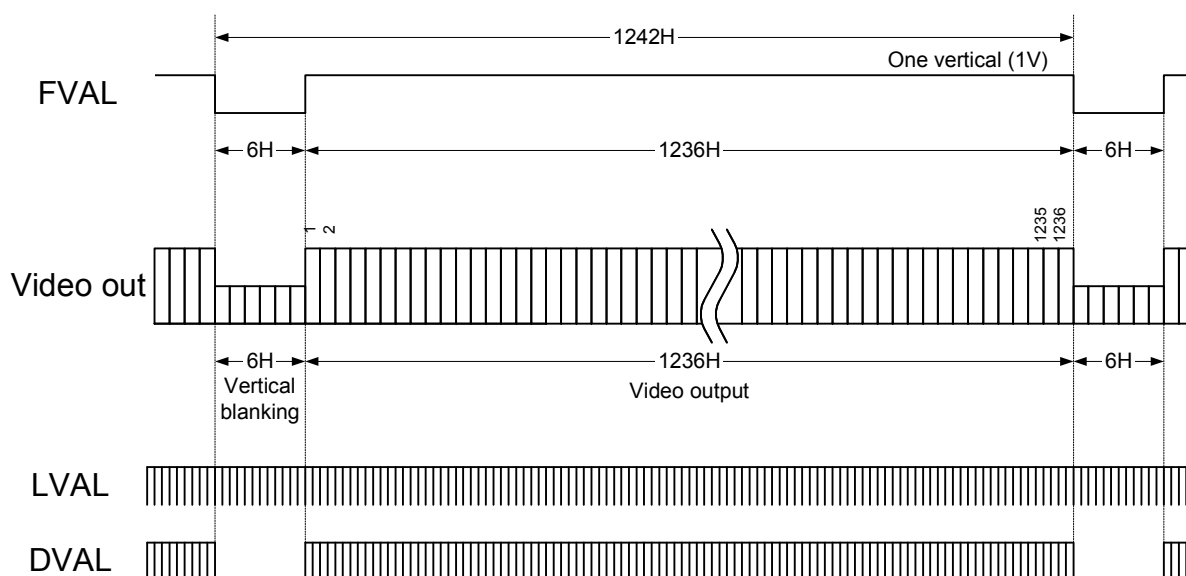

※ By transferring the blanking period pixels at a high rate, the frame rate of the partial full scanning can be increased compared to that of the normal full scanning.

2.1.2.3

1/2 Partial Scanning

(setting 10H: 1XX01XXX, 11H: X000X001)

1 H = 208.5963 μ s, 7.6582 Hz at 3.8fps
 1 H = 104.2968 μ s, 15.3164 Hz at 7.6fps
 1 H = 52.1484 μ s, 30.6328 Hz at 15.3fps

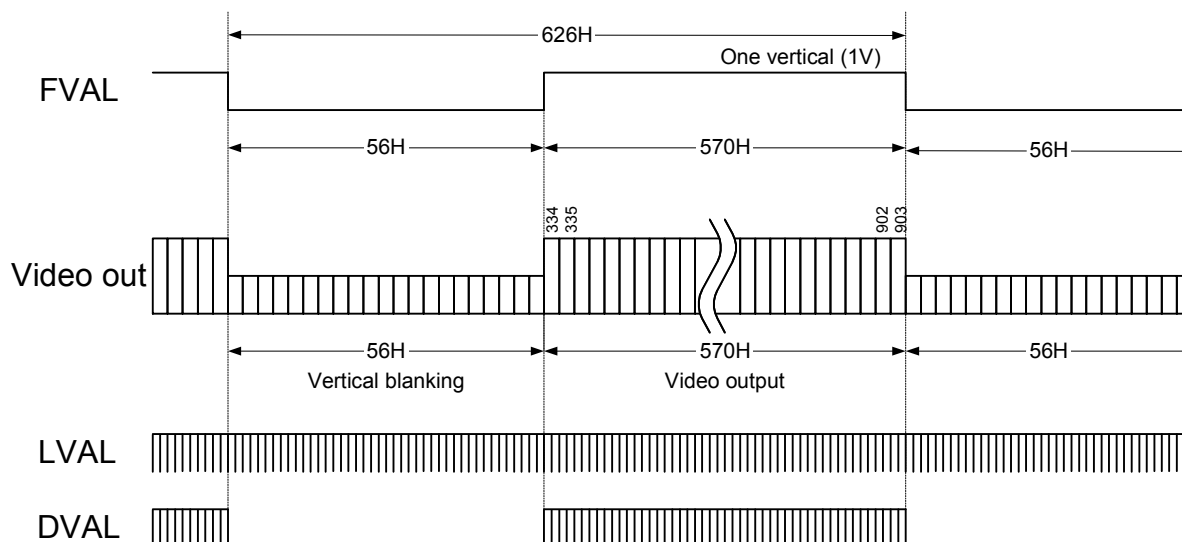

2.1.2.4

1/4 Partial Scanning

(Setting 10H: 1XX01XXX, 11H: X000X010)

1 H = 208.5963 μ s, 15.3164 Hz at 3.8fps
 1 H = 104.2968 μ s, 30.6328 Hz at 7.6fps
 1 H = 52.1484 μ s, 61.2656 Hz at 15.3fps

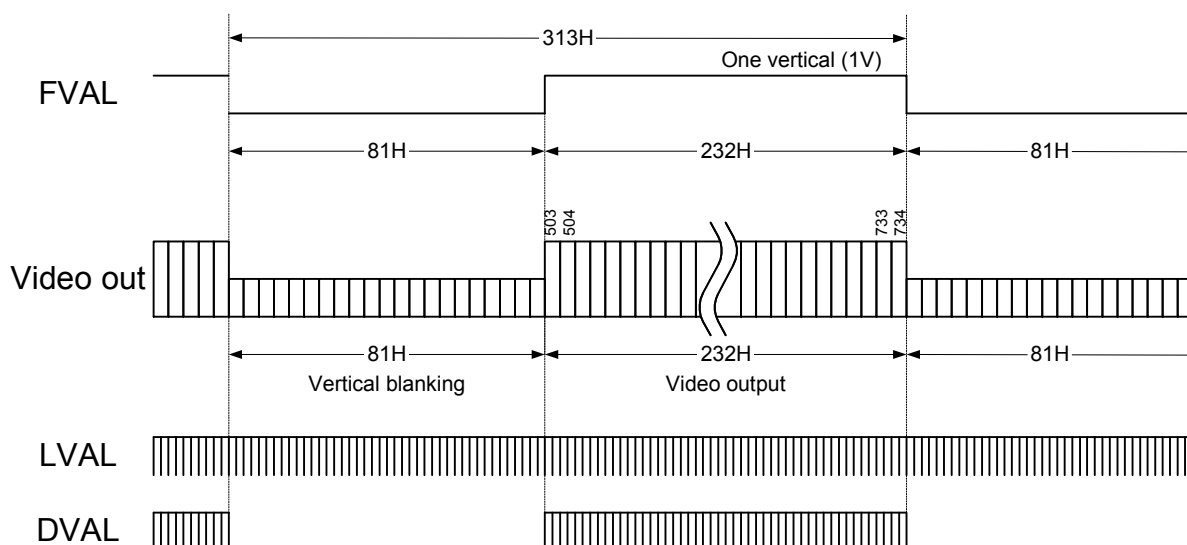

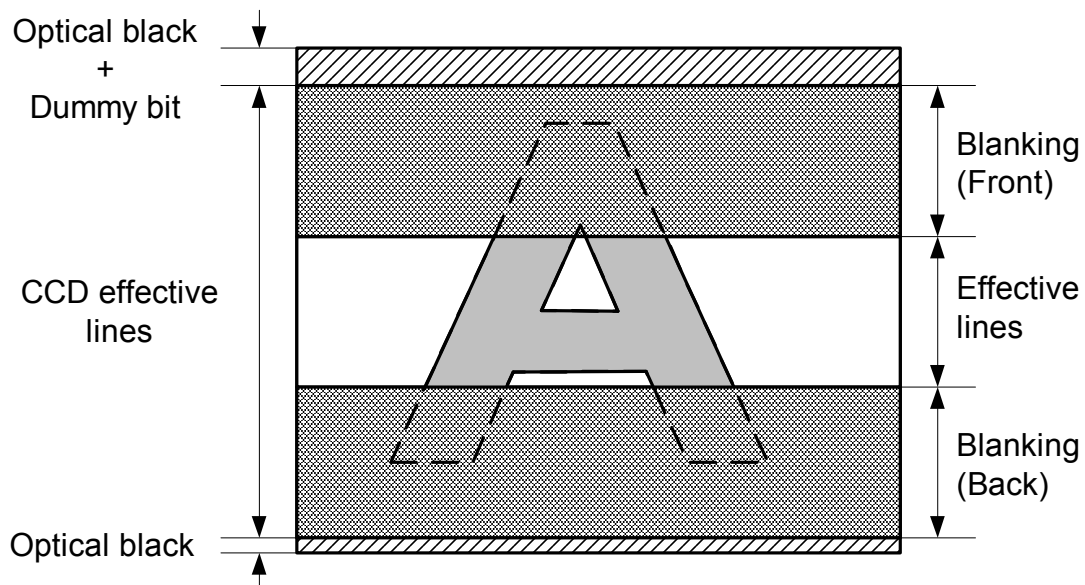
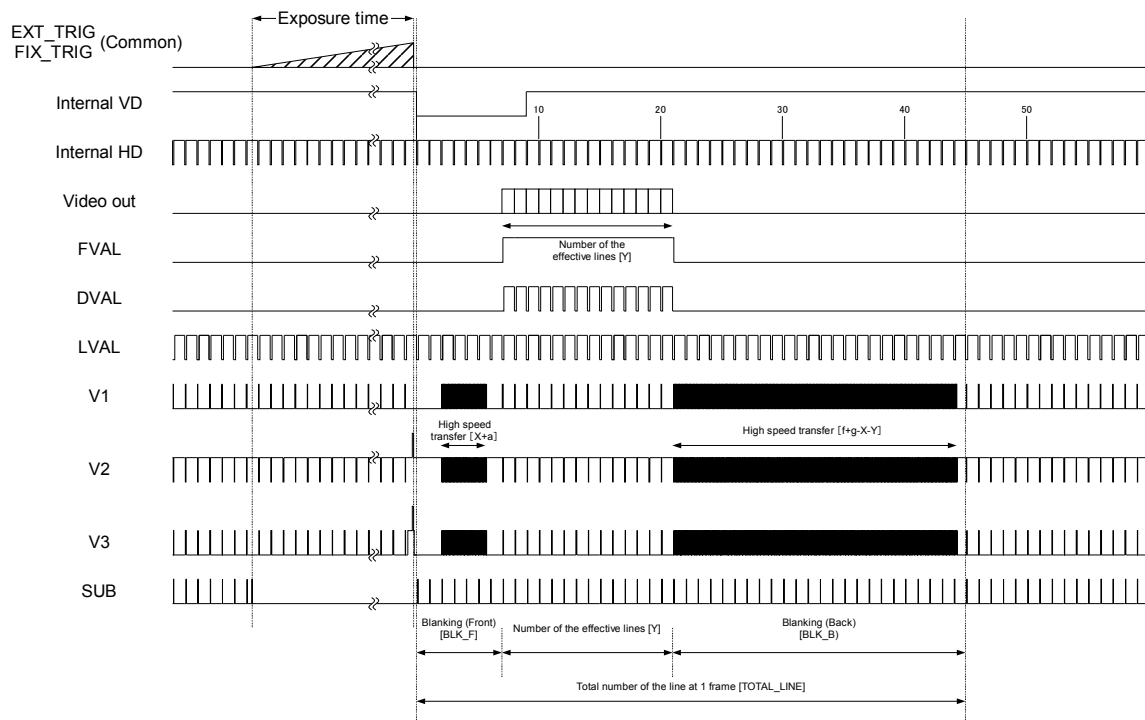

2.2 Binning Mode

(setting 10H: 1XX1XXXX)

Clock Speed (MHz)	Binning Full Scanning			Binning Partial Full Scanning			Binning 1/2 Partial Scanning			Binning 1/4 Partial Scanning		
	Normal	x1/2	x1/4	Normal	x1/2	x1/4	Normal	x1/2	x1/4	Normal	x1/2	x1/4
Frame Rate (Hz)	30.6	15.3	7.6	30.7	15.4	7.7	56.2	28.1	14.0	97.3	48.7	24.3

※Clock Speed: 36.8181 MHz (Normal), 18.40905 MHz (x1/2) , 9.204525 MHz (x1/4)

2.2.1 Horizontal Timing

1 CLK = 108.6422 ns at 3.8fps

1 CLK = 54.3211 ns at 7.6fps

1 CLK = 27.1605 ns at 15.3fps

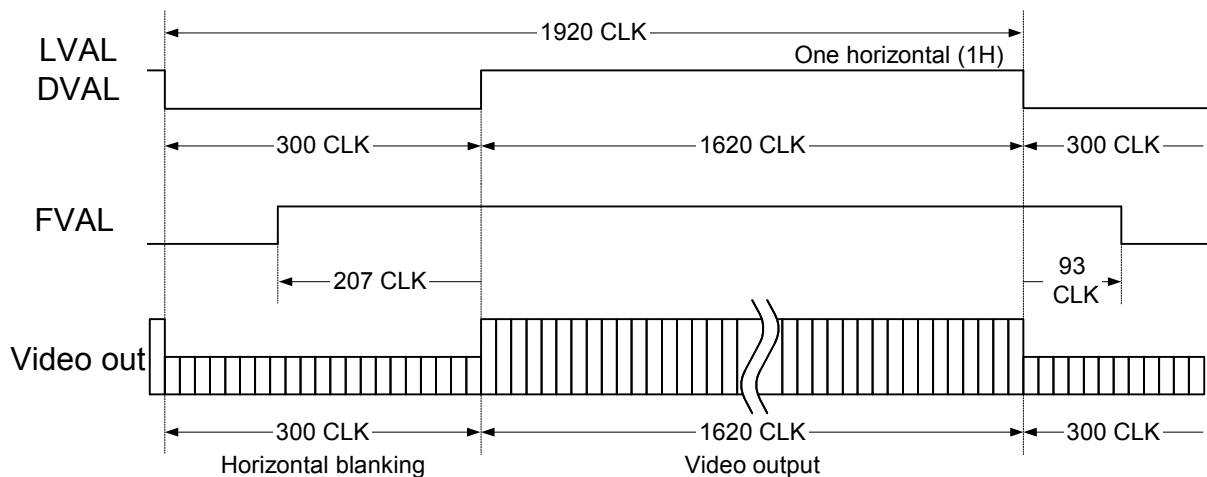

2.2.2 Vertical Timing

2.2.2.1 Binning Full Scanning

(setting 10H: 1XX10XXX, 11H: X000X000)

1 H = 208.5963 μ s, 7.6582 Hz at 3.8fps

1 H = 104.2968 μ s, 15.3164 Hz at 7.6fps

1 H = 52.1484 μ s, 30.6328 Hz at 15.3fps

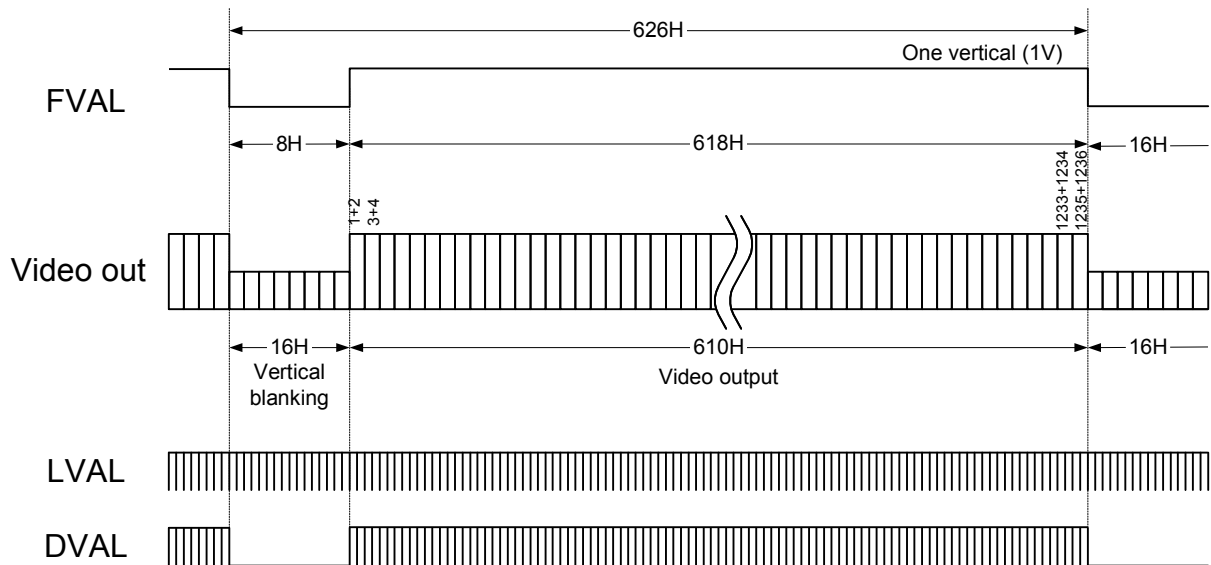

2.2.2.2 Binning Partial Full Scanning

(setting 10H: 1XX11XXX, 11H: X000X000)

1 H = 208.5963 μ s, 7.6828 Hz at 3.8fps

1 H = 104.2968 μ s, 15.3655 Hz at 7.6fps

1 H = 52.1484 μ s, 30.7310 Hz at 15.3fps

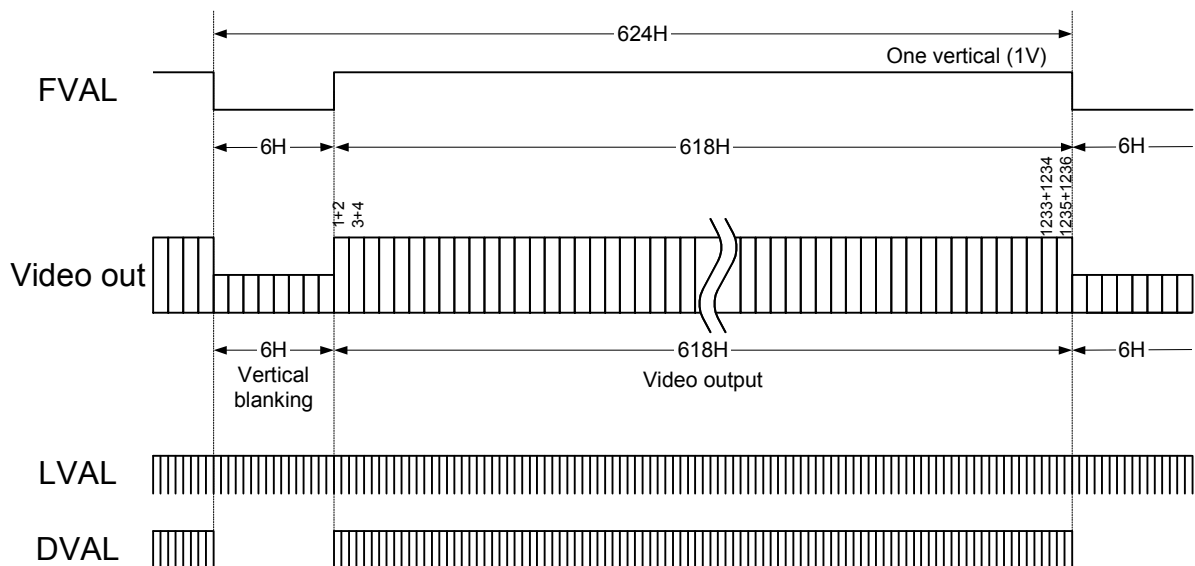

2.2.2.3

Binning 1/2 Partial Scanning

(setting 10H: 1XX11XXX, 11H: X000X001)

1 H = 208.5963 μ s, 14.0588 Hz at 3.8fps

1 H = 104.2968 μ s, 28.1175 Hz at 7.6fps

1 H = 52.1484 μ s, 56.2350 Hz at 15.3fps

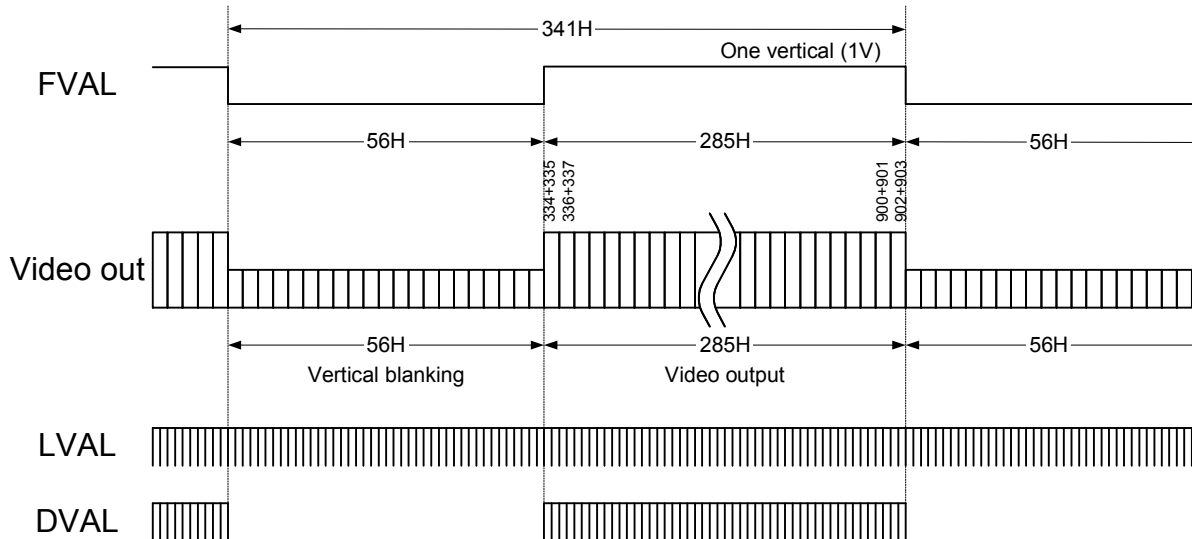

2.2.2.4

Binning 1/4 Partial Scanning

(setting 10H: 1XX11XXX, 11H: X000X010)

1 H = 208.5963 μ s, 24.3352 Hz at 3.8fps

1 H = 104.2968 μ s, 48.6704 Hz at 7.6fps

1 H = 52.1484 μ s, 97.3408 Hz at 15.3fps

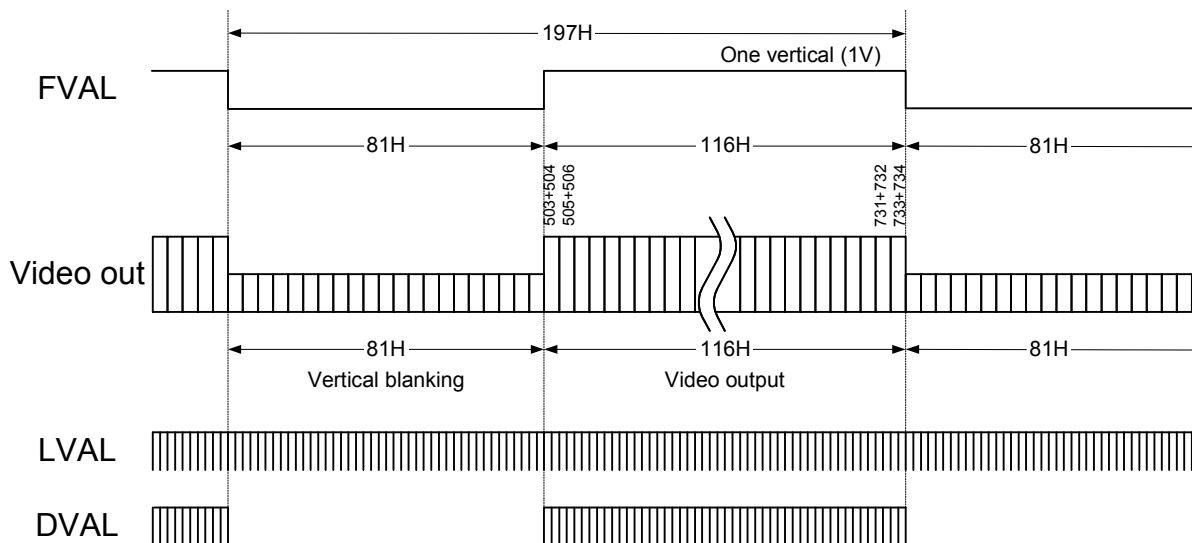

2.3 Data Order on the Camera Link Output

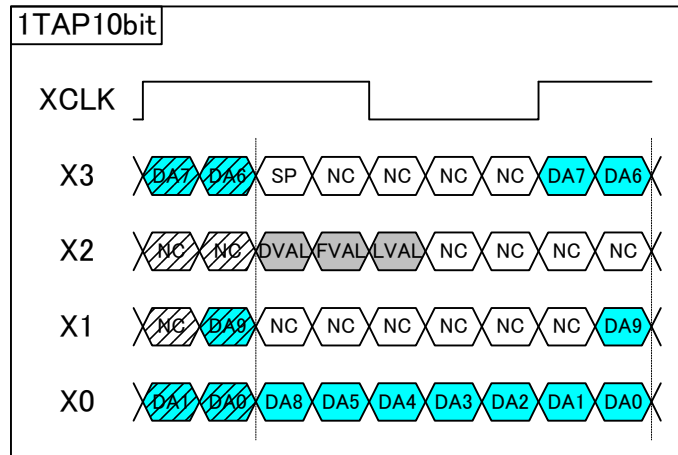

DA0~DA9: 10 bit data for one pixel

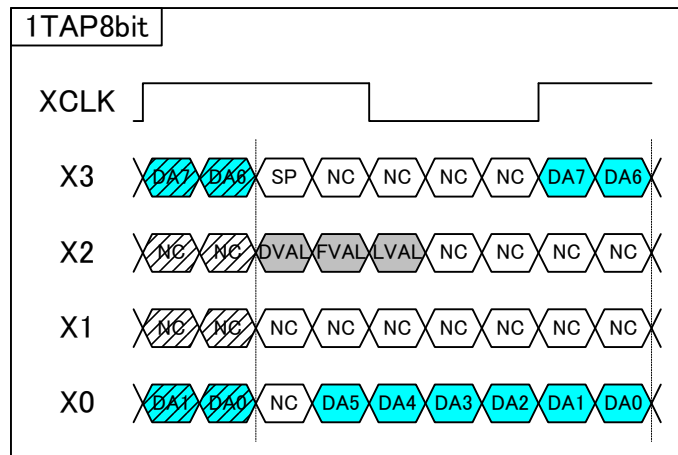

DA0~DA7: 8bit data for one pixel

2.4 1 Taps Transferring Image (1X-1Y)

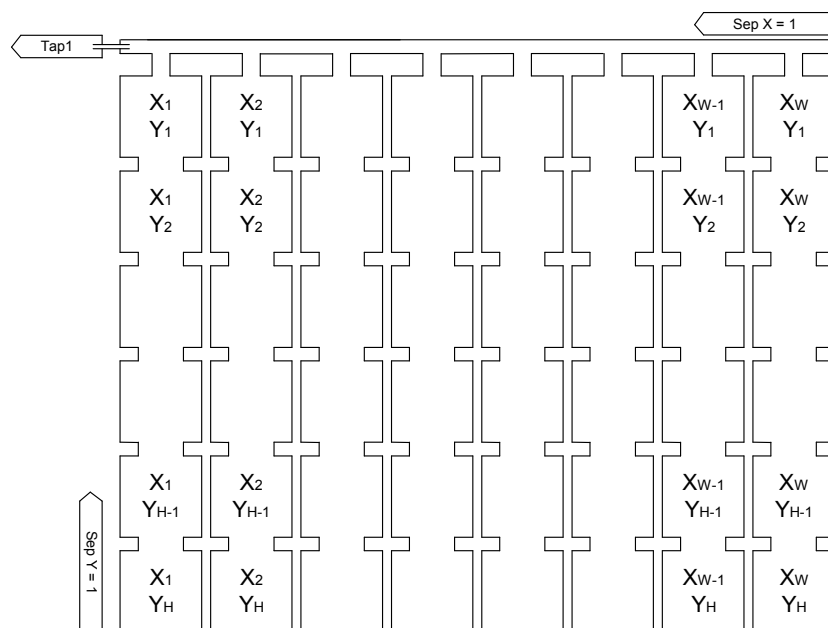

2.5 Pixel Transferring Image

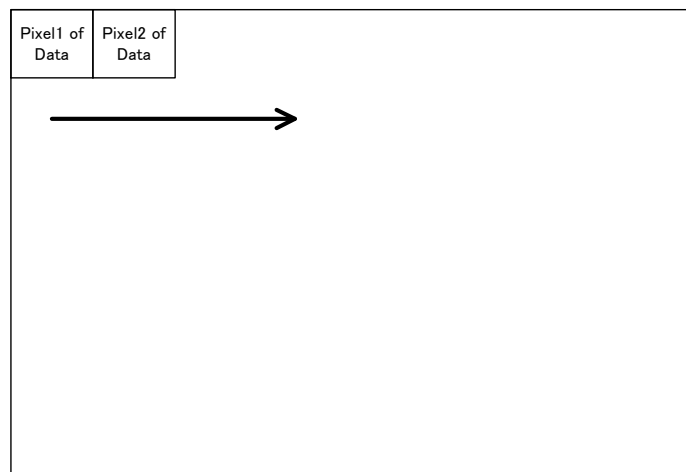

Pixeln of Data: nth pixel being transferred

3 Camera Operational Mode

3.1 Normal Mode

In this mode, the images are output continuously.

3.1.1 Frame Exposure

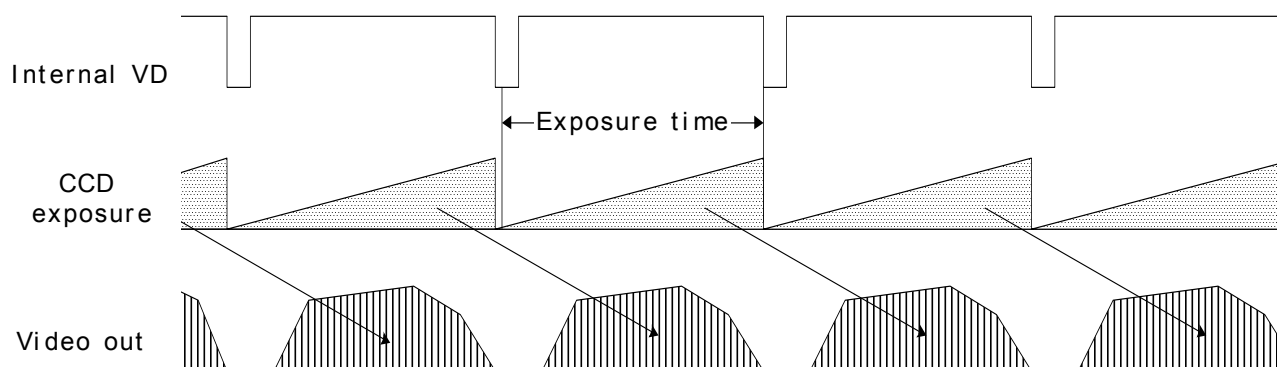

3.1.2 Electric Shutter

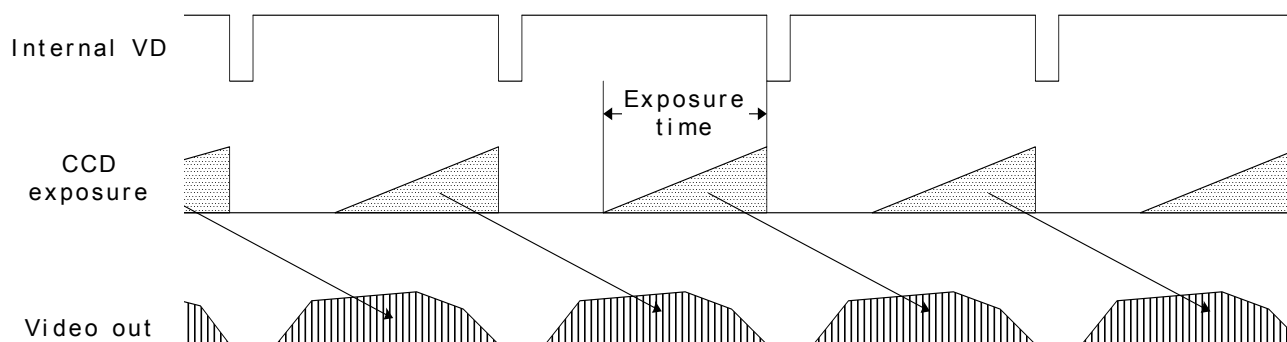

3.2 Pulse Width Trigger Mode

In this “pulse width trigger mode” with positive polarity, the camera exposure starts at the rising edge of the trigger signal and stops at the falling edge of the trigger signal. Therefore, in the case that the exposure positive polarity is selected, the actual exposure occurs when the trigger signal is at high state.

3.2.1 Pulse Width Trigger Mode (V-Reset)

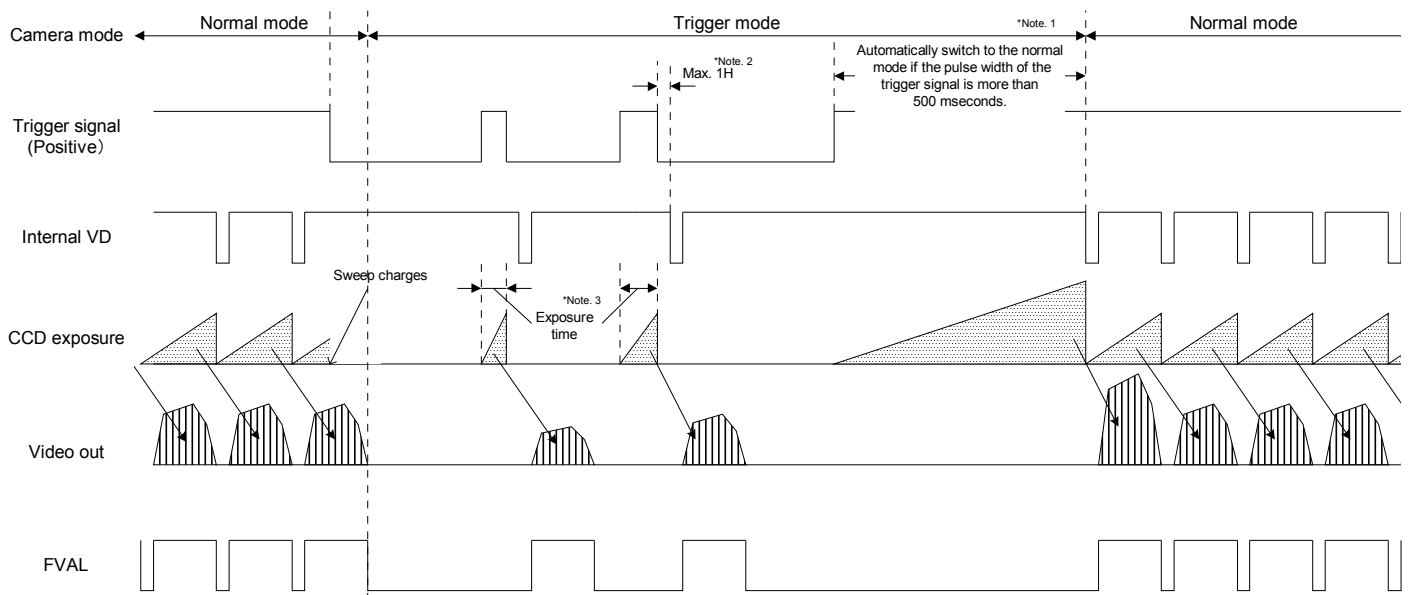

Note 1: The camera does NOT switch to normal mode when the long exposure mode is selected.

This timing chart shows when the long exposure mode selected.

Note 2: The internal VD signal is reset immediately after the exposure is finished as depicted, and the video output original is sent out according to that reset VD timing.

Note 3: The exposure time is controlled by the pulse width of the trigger signal as depicted.

3.2.2 Pulse Width Trigger Mode (Non-Reset)

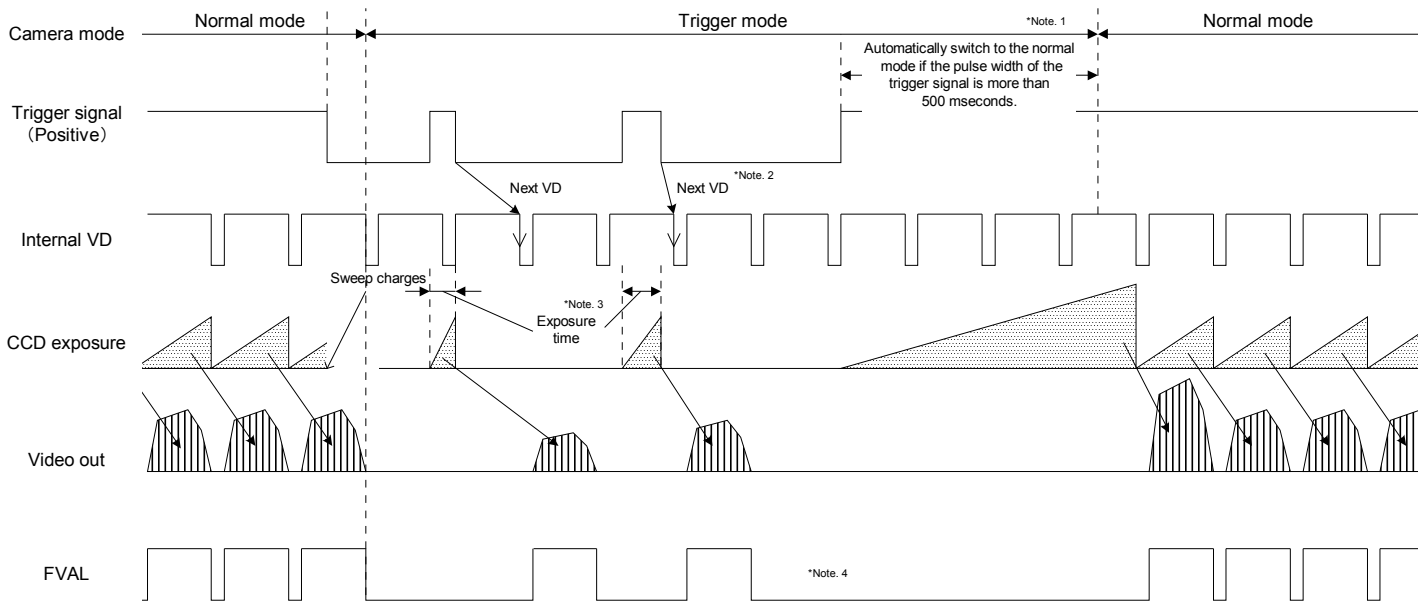

Note 1: The camera does NOT switch to normal mode when the long exposure mode is selected. This timing chart shows with the long exposure mode selected.

Note 2: The internal VD signal does not reset by the trigger signal. The video output signal is sent out at the next internal VD timing.

Note 3: The exposure time is controlled by the pulse width of the trigger signal as depicted.

Note 4: The FVAL signal does not output when the exposure by the trigger signal does not exist.

3.2.3 Exposure Timing

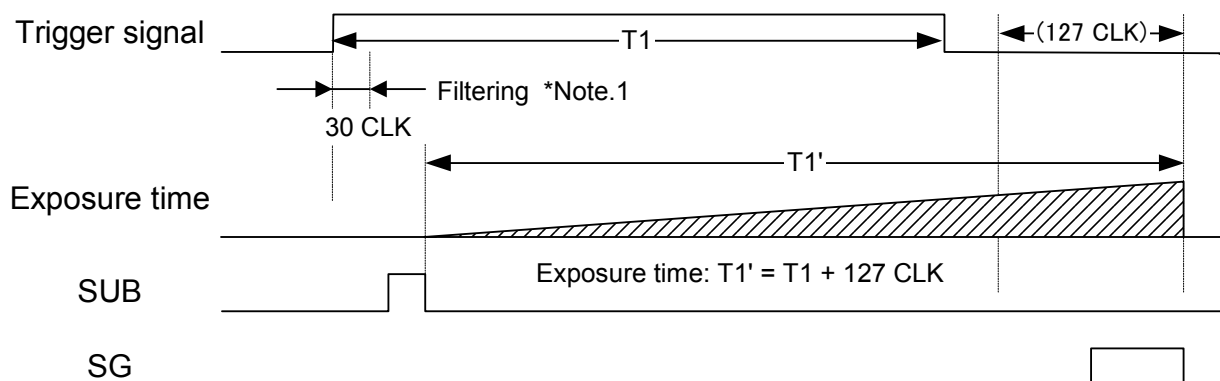

Notes: The trigger signal equal to or shorter than 30 CLK is removed by the filtering system. Input trigger signal has to be more than 31 CLK pulse width. The exposure starts 101 CLK after the rising edge of the trigger signal.

3.3 Edge Preset Trigger Mode

In this “edge preset trigger mode”, the camera exposure starts at the rising edge of the trigger signal like the “pulse width trigger mode” in the previous sections. However, in this mode, the exposure duration time is based on the preset value stored by the by the camera setting communication.

3.3.1 Edge Preset Trigger Mode (V-Reset)

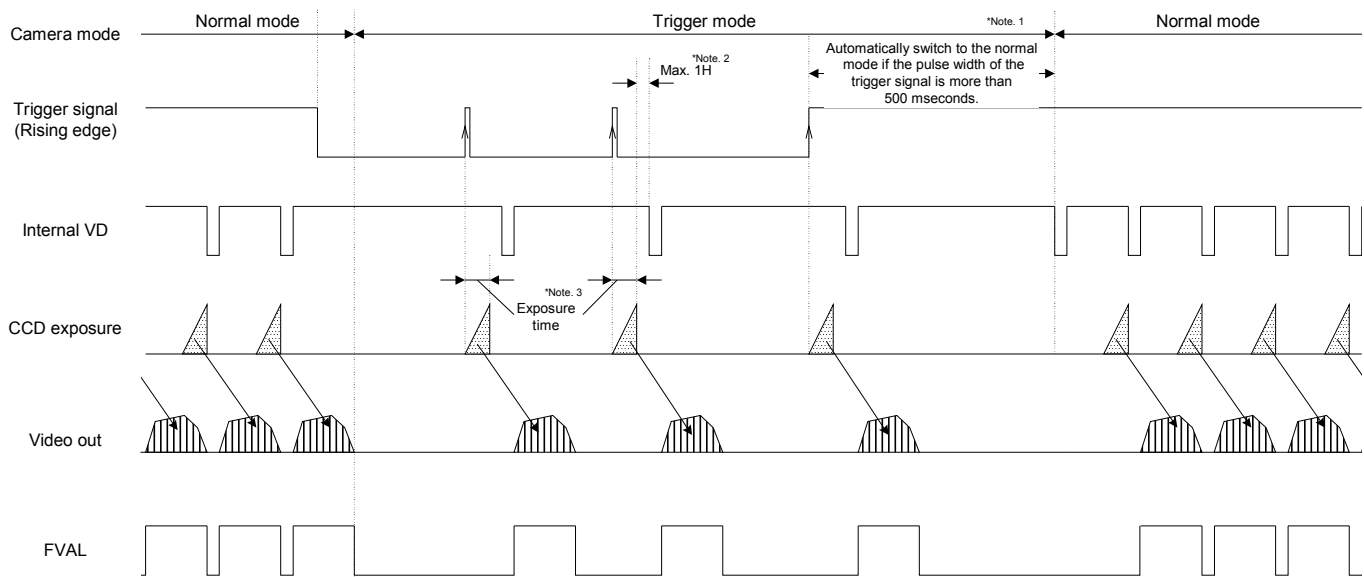

Note 1: The camera does NOT switch to the normal mode when the long exposure mode is selected.

This timing chart shows when the long exposure mode is selected.

Note 2: The internal VD signal is reset immediately after the exposure is finished as depicted and the video output signal is sent out according to the reset VD timing.

Note 3: The exposure time is preset by the camera setting communication as “shutter speed”.

3.3.2 Edge Preset Trigger Mode (Non-Reset)

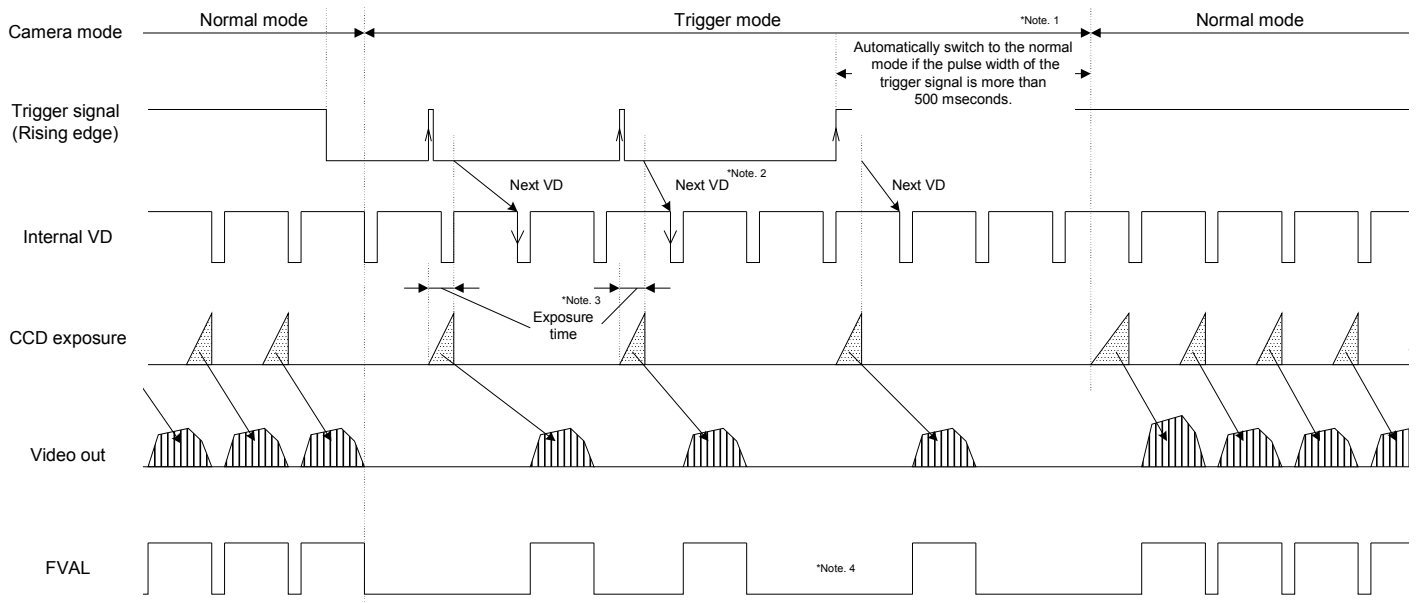

Note 1: The camera does NOT switch to normal mode when the long exposure mode is selected. This timing chart shows when the long exposure mode selected.

Note 2: The internal VD signal does not reset by the trigger signal. The video output signal is sent out at the next internal VD timing.

Note 3: The exposure time is preset by the camera setting communication as "shutter speed".

Note 4: The FVAL signal does not output when the exposure by the trigger signal does not exist.

3.3.3 Exposure Timing

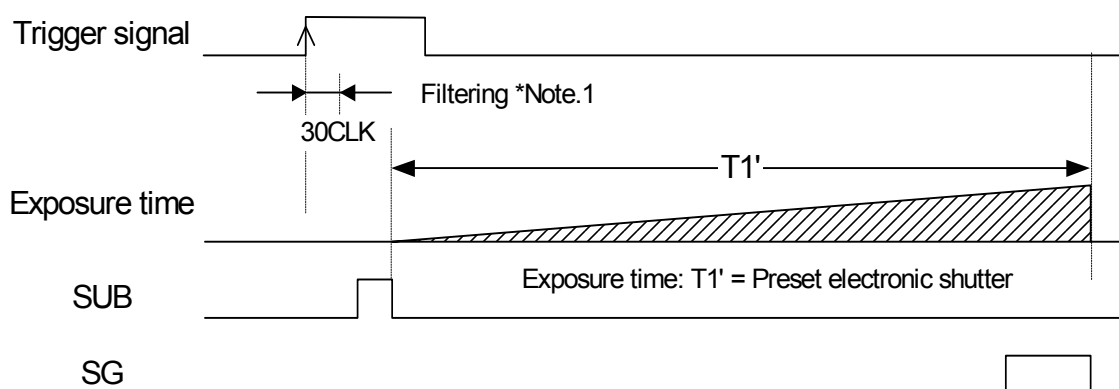

Notes: The trigger signal equal to or shorter than 30 CLK is removed by the filtering system. Input trigger signal has to be more than 31 CLK pulse width. The exposure starts 101 CLK after the rising edge of the trigger signal.

3.4 H Reset Mode

Normally, video noise appears when the beginning of trigger signal is applied before finishing the video read-out of the previous frame. This noise is caused by the SUB pulse, which is activated to clear all residual charges on the CCD prior to a new exposure. By selecting this "H. Reset Mode", the camera automatically holds the actual activation of trigger until the next horizontal blanking period. By doing this, the SUB pulse is activated during the horizontal blanking period and the noise in image can be avoided.

Note: Due to the principal of this operation, there can be maximum "1 H" of delay of actual trigger signal.

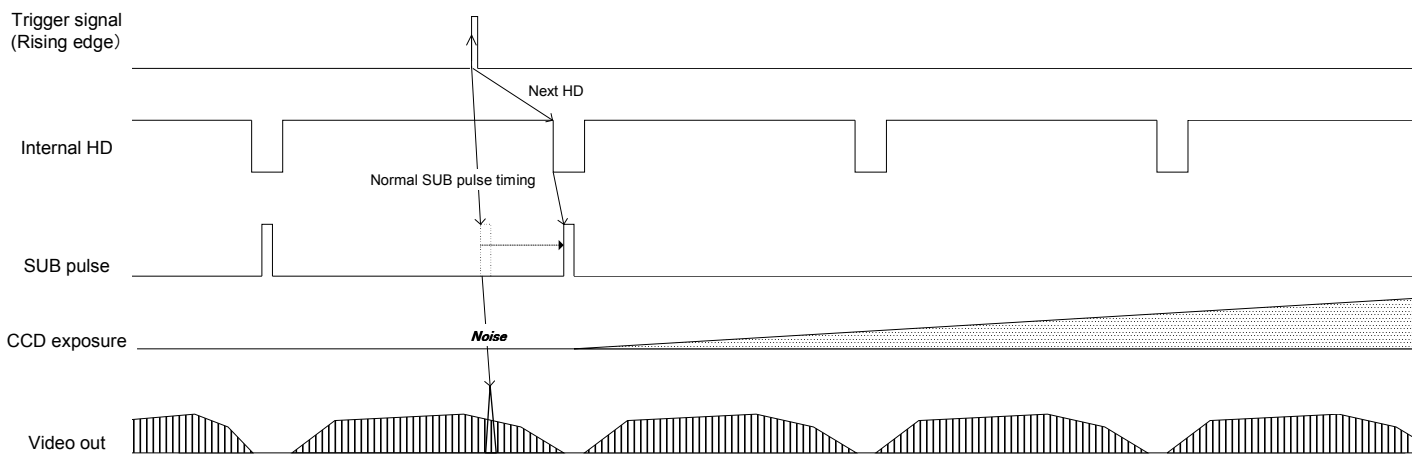

4 Communication Protocol

This camera has a communication function that enables external devices, such as a PC, to control the camera's functions.

Please use the "R-CLinkCtrl" communication software, or the following communication protocol to communicate to the camera:

4.1 Communication Method

UART (RS232C) , binary communication

4.2 Communication Settings

	Settings
Baud Rate	9,600 bps / 38,400 bps / 57,600 bps / 115,200 bps
Data Bit	8 bit
Parity	None
Stop Bit	1 bit
Flow Control	None

4.3 Communication Format

The Sending data format from the PC to the camera is as follows:

SOF	Device Code	Read/Write	Page Selection	Command Code	Data Length	Data	EOF
(8bit)	(6bit)	(1bit)	(1bit)	(8bit)	(8bit)	(R: 1 byte) (W: n bytes)	(8bit)

The Receiving Data format from the camera is as follows:

- After sending the Read Command:

SOF	Data Length	Data	EOF
(8bit)	(8bit)	(n bytes)	(8bit)

- After sending the Write Command:

SOF	Data Length	Receiving Code	EOF
(8bit)	(8bit) "00"	(1 byte)	(8bit)

The description of the format is as follows.

Name	Descriptions
SOF	Start of Frame. Always set or receive the value as "02H"
Device Code	This indicates the destination of communication. Set "000000" when accessing the camera's function settings Set "100000" when accessing the camera's extended function settings. Please refer to the "Camera Command List" and "Description of the Camera Control Commands".
Read / Write	This specifies "Read" or "Write" to command numbers. Set (or receive) "0" to send the read command. Set (or receive) "1" to send the write command.
Page Selection	This specifies page selection (access selection to registers or EEPROM) of command. Set "0" to access the command register of the camera. Read command: To obtain the current data from the command register. Write command: To set a data into the command register. <u>The previously stored data is replaced by this data. However, the data in the EEPROM is not replaced.</u> Set "1" to access the EEPROM of the camera. Read command: To read stored data from the EEPROM. Write command: To store data into the EEPROM as default value. The camera returns the receiving code "01H" to the PC after storing data in the EEPROM.
Command Code	This indicates the contents of the data sent or received. Refer to the following page for the details.
Data Length	This indicates the data length (unit: byte). Receiving Frame: The data length is dependent on each read command sent. The data length is defined as "00H" when sending the write command. The data length of error response is defined as "00H". Sending frame: The data length is 1 byte dummy data when sending the read command, and that data is not referenced. The data length is dependent on each "write command" sent.
Data	This indicates write data or read data according to command type.
EOF	End of Frame. Always set or receive the value as "03H"
Receiving Code	This indicates results of the command sent 01H: OK (ACK), 10H: NG (NAC), 11H: Connection error with peripheral device 12H: Command number error (Not matching), 13H: Communication frame error, 14H: Time out error, 17H: EEPROM write error

【Example Code】 Reading the data from the command 00H

- Command to send: 02H, 00H, 00H, 01H, 00H, 03H

SOF	Device Code	Read/Write	Page Selection	Command Code	Data Length	Data	EOF
(8bit)	(6bit)	(1bit)	(1bit)	(8bit)	(8bit)	(1byte)	(8bit)
02H	00H			00H	01H	00H	03H

- Command to receive upon a successful communication: 02H, 01H, 00H, 03H (assuming the data is 00H)

SOF	Data Length	Data	EOF
(8bit)	(8bit)	(n bytes)	(8bit)
02H	01H	00H	03H

【Sequence for the saving commands to the EEPROM】

Please use the following sequence for saving the commands to the EEPROM.

- 1) Set "1" to the 80H.0 to enable writing to the EEPROM.
- 2) Send the save data with the page selection "1".
- 3) The camera sends back one of the following receiving codes after writing the EEPROM.
 - 01H: OK
 - 17H: EEPROM write error
- 4) 80.0H is cleared to "0" automatically after writing the EEPROM.

Note1: The data cannot be saved to the EEPROM when 80H.0 is "0".

Note2: When saving the consecutive sequence of commands, the above steps, 1) to 4), are necessary only once.

i.e.) saving the commands "10H, 11H, 12H, 13H", or "22H, 23H, 24H", etc.

Note3: When saving the non-consecutive sequence of commands, the above steps, 1) to 4), are necessary for the same number of times.

i.e.) saving the commands "10H, 13H, 19H, 1BH" or "20H, 23H, 25H", etc.

4.4 Camera Control Command

4.4.1 Camera Command List

- The data unit of the each command is 1 byte (8bit).
- The data can be saved to the EEPROM if there is an “X” in the “Save to EEPROM” column in the following list.
- The camera initializes based on the stored data in the EEPROM when the power is applied.

Command No.	R/W	Save to EEPROM	Function	Initial Data	Data Range
00 to 0FH			<i>Reserved</i>	-	-
10H	R/W	X	<i>Camera function mode 1 (8bit: D[7...0])</i>	9	0 to 255
11H	R/W	X	<i>Camera function mode 2 (8bit: D[7...0])</i>	0	0 to 255
12H	R/W	X	<i>Camera function mode 3 (8bit: D[7...0])</i>	0	0 to 255
13H			<i>Reserved</i>	-	-
14H	R/W	X	<i>Communication mode (8bit: D[7...0])</i>	1	0 to 3
15 to 1BH			<i>Reserved</i>	-	-
1CH	R/W	X	<i>AGC max (8bit: D[7...0])</i>	255 (FFH)	0 to 255
1DH	R/W	X	<i>ALC luminance target level (8bit: D[7...0])</i>	128 (80H)	0 to 255
1EH	R/W	X	<i>ALC mode (8bit: D[7...0])</i>	0	0 to 3
20H	R/W	X	<i>Exposure time (H) of the electronic shutter (16bit: D[7...0])</i>	0	0 to 4095
21H	R/W	X	<i>Exposure time (H) of the electronic shutter (16bit: D[15...8])</i>		
22H	R/W	X	<i>Exposure time (CLK) of the electronic shutter (16bit: D[7...0])</i>	0	0 to 1919
23H	R/W	X	<i>Exposure time (CLK) of the electronic shutter (16bit: D[15...8])</i>		
24H	R/W	X	<i>Start line of the variable partial scanning (16bit: D[7...0])</i>	0	0 to 1235
25H	R/W	X	<i>Start line of the variable partial scanning (16bit: D[15...8])</i>		
26H	R/W	X	<i>Effective lines of the variable partial scanning (16bit: D[7...0])</i>	1236 (4D4H)	0 to 1236
27H	R/W	X	<i>Effective lines of the variable partial scanning (16bit: D[15...8])</i>		
28H	R/W	X	<i>Delay time for the trigger (16bit: D[7...0])</i>	0	0 to 65535
29H	R/W	X	<i>Delay time for the trigger (16bit: D[15...8])</i>		
2A-2FH			<i>Reserved</i>	-	-
30H	R/W	X	<i>CDS gain (8bit: D[7...0])</i>	0	0 to 255
31H	R/W	X	<i>Digital gain</i>	The Factory Adjusted Value	0 to 255
32H	R/W	X	<i>Gain offset (8bit: D[7...0])</i>		0 to 255
33 to 37H			<i>Reserved</i>	-	-
38H	R/W	X	<i>Clamp level (8bit: D[7...0])</i>	0	0 to 31
39 to 3DH			<i>Reserved</i>	-	-
3EH	R/W	X	<i>Test pattern level (10bit: D[7...0])</i>	768 (300H)	0 to 1023
3FH	R/W	X	<i>Test pattern level (10bit: D[9...8])</i>		
40 to 53H	R/W	X	<i>Reserved</i>	-	-
54H	R/W	X	<i>Strobe Delay (us) (24bit: D[7..0])</i>	0	0 to 2000000
55H	R/W	X	<i>Strobe Delay (us) (24bit: D[15..8])</i>		
56H	R/W	X	<i>Strobe Delay (us) (24bit: D[23..16])</i>		
57H		X	<i>Reserved</i>	-	-
58H	R/W	X	<i>Strobe polarity (8bit: D[7...0])</i>	0	0 to 1
59 to 77H		X	<i>Reserved</i>	-	-

Command No.	R/W	Save to EEPROM	Function	Initial Data	Data Range
78H	R/W	X	Test pattern selection (8bit: D[7..0])	0	0 to 31
79H	R/W	X	Image effect selection (8bit: D[7..0])	0	0 to 255
7A to 7FH			Reserved		
80H	R/W		EEPROM control (8bit: D[7...0])	0	0 to 1
81 to 8FH			Reserved	-	-
94H	R/W	X	Strobe active period (us) (24bit: D[7..0])	0	0 to 2000000
95H	R/W	X	Strobe active period (us) (24bit: D[15..8])		
96H	R/W	X	Strobe active period (us) (24bit: D[23..16])		
97 to 9FH			Reserved	-	-
A0H	W	X	Pixel defect correction mode (8bit: D[7..0])	0	0 to 7
A1H	W	X	Pixel defect correction index (8bit: D[7..0])	0	0 to 15
A2H	W	X	PDC X coordinate (Write) (16bit: D[7..0])	0	0 to 65535
A3H	W	X	PDC X coordinate (Write) (16bit: D[15..8])		
A4H	W	X	PDC Y coordinate (Write) (16bit: D[7..0])	0	0 to 65535
A5H	W	X	PDC Y coordinate (Write) (16bit: D[15..8])		
A6H	R	X	PDC X coordinate (Read) (16bit: D[7..0])	0	-
A7H	R	X	PDC X coordinate (Read) (16bit: D[15..8])		
A8H	R	X	PDC Y coordinate (Read) (16bit: D[7..0])	0	-
A9H	R	X	PDC Y coordinate (Read) (16bit: D[15..8])		
AA–BFH			Reserved	-	-
C0H	R/W	X	Auto exposure min (16bit: D[7..0])	1	0 to 4095
C1H	R/W	X	Auto exposure min (16bit: D[15..8])		
C2H	R/W	X	Auto exposure max (16bit: D[7..0])	4095 (FFFH)	0 to 4095
C3H	R/W	X	Auto exposure max (16bit: D[15..8])		
C4H			Reserved	-	-
C5H	R/W	X	Look-up table (Gamma) (8bit: D[7..0])	0	0 to 6
C6H	R/W	X	ALC Speed (8bit: D[7..0])	0	0 to 255
C7 to EFH			Reserved	-	-
F0H	R/W		IO connector signals1 (8bit: D[7...0])	0	0 to 15
F1 to FFH			Reserved	-	-

Command No.	Command Descriptions
20H: SVR[7...0] 21H: SVR[15...8]	<p>[Exposure time (H) of the electronic shutter] Initial Data: SVR[15...0] = 0, Data Range: 0 to 4095</p> <p>Sets the preset shutter speed (or CCD exposure time) for electronic shutter.</p> <p>The preset shutter speed is defined by the following formula.</p> $\text{Exposure time (shutter speed)} = \text{SVR}[15...0] \times (1\text{H cycle time}) + \text{SHR}[15...0] \times (1\text{CLK cycle time})$ <p>Notes:</p> <ol style="list-style-type: none"> 1. The camera works with the shutter off position (maximum frame exposure time) when both SVR and SHR are set at "0". 2. The camera works with the minimum shutter speed when this value is set to 0 and the value of SHR is set between 1 and 306. 3. The value is replaced with 4095 automatically when the value set greater than 4095.
22H: SHR[7...0] 23H: SHR[15...8]	<p>[Exposure time (CLK) of the electronic shutter] Initial Data: SHR[15...0] = 0, Data Range: 0 to 1919</p> <p>Sets the preset shutter speed (or CCD exposure time) for electronic shutter.</p> <p>The previous section, the preset shutter speed is defined by the following formula:</p> $\text{Preset shutter speed} = \text{SVR}[15...0] \times (1\text{H cycle time}) + \text{SHR}[15...0] \times (1\text{CLK cycle time})$ <p>Note 1: The camera works with the shutter off position (maximum frame exposure time) when both SVR and SHR are set at "0".</p> <p>Note 2: The camera works with the minimum shutter speed when SVR is set to 0 and this value is set between 1 and 306.</p> <p>Note 3: The value replaces by 1919 automatically when the value set greater than 1919</p>
24H: PSR[7..0] 25H: PSR[15...8]	<p>[Start line of the variable partial scanning] Initial Data: PSR[15...0] = 0, Data Range: 0 to 1235</p> <p>This sets the start line number of the variable partial scanning area.</p> $\text{Actual start line of the partial scanning} = \text{this value} + 1$ <p>Note 1: The camera works with full scanning mode when the value of (PSR[] + PWR[]) is greater than 494.</p> <p>Note 2: The value replaces by 1235 automatically when the value set greater than 1235</p>
26H: PWR[7...0] 27H: PWR[15...8]	<p>[Effective line numbers in the variable partial scanning] Initial Data: PWR[15...0] = 494, Data Range: 0 to 1236</p> <p>This sets the number of the total effective lines (image height) in the variable partial scanning mode.</p> <p>Notes:</p> <ol style="list-style-type: none"> 1. The value replaces by 1236 automatically when the value set greater than 1236. 2. The camera works with full scanning mode when the value of (PSR[] + PWR[]) is greater than 2058.

Command No.	Command Descriptions								
28H: DLY[7...0] 29H DLY[15...8]	[Delay time for the trigger] Initial Data: DLY[7...0] = 0, Data Range: 0 to 65,535 Sets the delay time from the trigger input signal to the start of the exposure. At 15.3 fps: Delay time (us) = 74 x 0.0271606 * DLY[7...0] = 2.0099 (us) * DLY[7...0], At 7.6 fps: Delay time (us) = 74 x 0.0407408 * DLY[7...0] = 4.0198 (us) * DLY[7...0], At 3.8 fps: Delay time (us) = 74 x 0.0814816 * DLY[7...0] = 8.03952 (us) * DLY[7...0], where CLK = pixel clock.								
30H PGA[7...0]	[CDS gain] Initial Data: PGA[7...0] = 0, data range: 0 to 255 Sets the CDS gain (programmable analog gain). CDS gain (dB) = ((PGA[7..0] + GOFS[7..0]) * 2 * 0.0351) + 6 *GOFS[7...0]: The gain offset (The value of the address 32H)								
31H DGB[7...0]	[Digital gain] Initial Data: The factory adjusted value, data Range: 0 to 255 Output level = (input level - CLAMP[7...0]) * (1 + DGB[7..0] / 128) + clamp level *CLAMP[7...0]: clamp level (The value of the address 38H)								
32H GOFS[7...0]	[Gain offset] Initial Data: The factory adjusted value, data range: 0 to 255								
38H: CLAMP[7...0]	[Clamp level] Initial Data: CLAMP[7...0] = 9, Data Range: 0 to 255 This sets the clamp level value of the black level. At 12-bit output: Clamp level = CLAMP[7...0] x 8 + 56 At 10 bit output: Clamp level = (CLAMP[7...0] x 8 + 56) / 4 At 8-bit output: Clamp level = (CLAMP[7...0] x 8 + 56) / 16								
3EH: TP0[7...0] 3FH: TP0[9...8]	[Test pattern level] Initial data: 768 (300H), data range: 0 to 1023 Sets the output level of the test pattern 4: Raster (variable level) in 10-bit output format.								
54H: STRBDLY[7..0] 55H: STRBDLY[15..8] 56H: STRBDLY[23..16]	[Delay time (us) for the strobe signal] Initial data: STRBDLY[23..0] = 0, data range: 0 to 2,000,000								
58H: STRBPOL[7..0]	[Strobe signal polarity] Initial data: IOSIGNAL_POL[7..0] = 00H, Sets the strobe signal polarity. D[7..0] <table border="1" style="margin-left: 20px;"> <tr> <td>D7</td><td>D6</td><td>D5</td><td>D4</td><td>D3</td><td>D2</td><td>D1</td><td>D0</td> </tr> </table> D7 to D1 No Function <u>Always set as "0000000"</u> D0: Strobe signal polarity <u>0: Non-invert</u> 1: Invert	D7	D6	D5	D4	D3	D2	D1	D0
D7	D6	D5	D4	D3	D2	D1	D0		

Command No.	Command Descriptions								
A0H: PDC0[7...0]	<p>[Pixel defect correction mode] Initial data: PDC0[7..0] = 0 D[7..0]</p> <table border="1"> <tr> <td>D7</td> <td>D6</td> <td>D5</td> <td>D4</td> <td>D3</td> <td>D2</td> <td>D1</td> <td>D0</td> </tr> </table> <p>D7: Write the correction index <u>0</u> → 1 *Writes the coordinates of the command, A2 to A5, to the index number specified by the command A1. *This bit is cleared to "0" automatically after the execution of the command.</p> <p>D6: Read the correction index <u>0</u> → 1 *Reads the coordinates of the index number specified by A1 and loads them to the command, A6 to A9. *This bit is cleared to "0" automatically after the execution of the command.</p> <p>D5: Save to the EEPROM <u>0</u> → 1 *Writes the coordinates of all 16 index numbers to the EEPROM. *This bit is cleared to "0" automatically after the execution of the command.</p> <p>D4 to D2: No function <u>Always set as "000"</u></p> <p>D1: Correction indices display <u>0: OFF</u> 1: ON</p> <p>D0: Pixel defect correction <u>0: OFF</u> 1: ON</p>	D7	D6	D5	D4	D3	D2	D1	D0
D7	D6	D5	D4	D3	D2	D1	D0		
A1H: PDC0[7...0]	<p>[Pixel defect correction index number] Initial data: PDC1[7..0] = 0, data range: 0 to 15 D[7..0]</p> <table border="1"> <tr> <td>D7</td> <td>D6</td> <td>D5</td> <td>D4</td> <td>D3</td> <td>D2</td> <td>D1</td> <td>D0</td> </tr> </table> <p>D7 to D4: No function <u>Always set as "0000"</u></p> <p>D3 to D0: Index number</p>	D7	D6	D5	D4	D3	D2	D1	D0
D7	D6	D5	D4	D3	D2	D1	D0		
A2H: PDC_WX[7...0] A3H PDC_WX[15...8]	<p>[PDC X coordinate (Write)] Initial data: PDC_WX[15..0] = 0, data range: 0 to the number of horizontal pixels of the effective area Set the X coordinate of pixel defect.</p>								
A4H: PDC_WY[7...0] A5H PDC_WY[15...8]	<p>[PDC Y coordinate (Write)] Initial data: PDC_WY[15..0] = 0, data range: 0 to the number of vertical pixels of the effective area Sets the Y coordinate of pixel defect.</p>								
A6H: PDC_RX[7...0] A7H PDC_RX[15...8]	<p>[PDC X coordinate (Read)] Initial data: PDC_RX[15..0] = 0, data range: 0 to the number of vertical pixels of the effective area The X coordinate of pixel defect will be loaded when reading.</p>								
A8H: PDC_RY[7...0] A9H PDC_RY[15...8]	<p>[PDC Y coordinate (Read)] Initial data: PDC_RY[15..0] = 0, data range: 0 to the number of vertical pixels of the effective area The Y coordinate of pixel defect will be loaded when reading.</p>								
C0H: [7...0] C1H: [7...0]	<p>[Lower limit of the electronic shutter] Initial data: 1; data range: 0 to 4,095 Sets the upper limit of the electronic shutter in horizontal lines when using AE (auto exposure).</p>								
C2H: [7...0] C3H: [7...0]	<p>[Upper limit of the electronic shutter] Initial data: 4,095; data range: 0 to 4,095 Sets the upper limit of the electronic shutter in horizontal lines when using AE (auto exposure).</p>								

Command No.	Command Descriptions																		
C5H: [7...0]	<p>[Look-up table (Gamma)] Initial data: [7..0] = 00H D[7..0]</p> <table border="1" data-bbox="325 427 871 465"> <tr> <td>D7</td><td>D6</td><td>D5</td><td>D4</td><td>D3</td><td>D2</td><td>D1</td><td>D0</td> </tr> </table> <p>D7 to D3: No function <u>Always set as "00000"</u></p> <p>D2: Look-up table (RAM) <u>0: OFF</u> 1: Load</p> <p>D1: Look-up table upload <u>0: RAM only</u> 1: RAM and ROM</p> <p>D0: No function <u>Always set as "0"</u></p>	D7	D6	D5	D4	D3	D2	D1	D0										
D7	D6	D5	D4	D3	D2	D1	D0												
F0H:[7...0]	<p>[Signal selection for the I/O connector] Initial data: [7...0] = the value of 00H, data range: 0 to 15 Sets the signals of the I/O connector. D[7..0]</p> <table border="1" data-bbox="325 846 871 884"> <tr> <td>D7</td><td>D6</td><td>D5</td><td>D4</td><td>D3</td><td>D2</td><td>D1</td><td>D0</td> </tr> </table> <p>D7 to D4: No function <u>Always set as "0000"</u></p> <p>D3~D0: The signals of the I/O connector selection</p> <table data-bbox="975 958 1500 1171"> <tr> <td><u>0H: Option 0</u></td> <td>1H: Option 1</td> </tr> <tr> <td>2H: Option 2</td> <td>3H: Option 3</td> </tr> <tr> <td>4H: Option 4</td> <td>5H: Option 5</td> </tr> <tr> <td>6H: Option 6</td> <td></td> </tr> <tr> <td>7H to FH: No function</td> <td></td> </tr> </table> <p>(Prohibited settings. Do not set these values)</p> <p>Please refer to the table 3 I/O Connector Settings for the details.</p>	D7	D6	D5	D4	D3	D2	D1	D0	<u>0H: Option 0</u>	1H: Option 1	2H: Option 2	3H: Option 3	4H: Option 4	5H: Option 5	6H: Option 6		7H to FH: No function	
D7	D6	D5	D4	D3	D2	D1	D0												
<u>0H: Option 0</u>	1H: Option 1																		
2H: Option 2	3H: Option 3																		
4H: Option 4	5H: Option 5																		
6H: Option 6																			
7H to FH: No function																			

Revision History

Rev	Date	Changes	Note
1.00	2012/06/20	● Initial Release	
1.01	2012//07/13	● Updated Document Title Communication Protocol 20-21H SVR 28-29H DLY 78H Test pattern, 79H Pasteurization Deleted F1H command due to test use only	

RICOH COMPANY, LTD.

URL http://www.ricoh.com/fa_security/

Free Manuals Download Website

<http://myh66.com>

<http://usermanuals.us>

<http://www.somanuals.com>

<http://www.4manuals.cc>

<http://www.manual-lib.com>

<http://www.404manual.com>

<http://www.luxmanual.com>

<http://aubethermostatmanual.com>

Golf course search by state

<http://golfingnear.com>

Email search by domain

<http://emailbydomain.com>

Auto manuals search

<http://auto.somanuals.com>

TV manuals search

<http://tv.somanuals.com>