

# Caplio R2

RICOH

## Camera User Guide

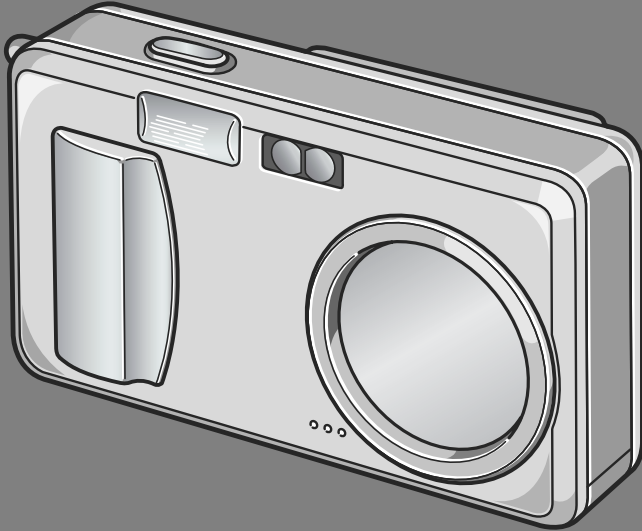

The serial number of this product is given on the bottom face of the camera.

- 1 Quick Guide
- 2 A Variety of Shooting Techniques/Playback
- 3 Changing Camera Settings
- 4 Installing Software
- 5 Troubleshooting



## Caution!

### Do not connect the USB cable yet!

If you connect the camera to a computer through the USB cable before installing the provided software on the computer, the software required for connection between camera and computer may not be installed appropriately.

Be sure to connect the camera to your computer after installing the provided software.

For how to install the software, see P.131.

### About other documentation

Detailed explanations on how to use the provided software can be found in "Software User Guide" (PDF format file) included on the supplied CD-ROM.

For how to display the PDF file, see P.135.

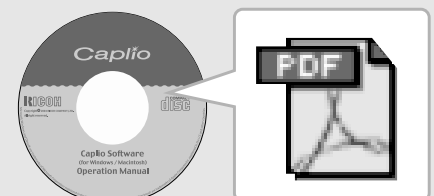
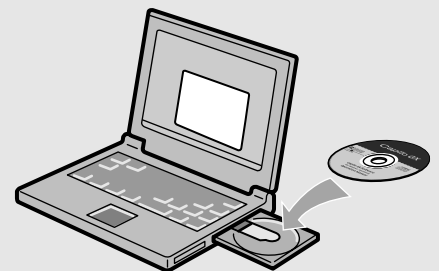

# Preface

This manual provides information on how to use the shooting and playback functions of this product, as well as warnings on its use. To make the best use of this product's functions, read this manual thoroughly before use. Please keep this manual handy for ease of reference.

Ricoh Co., Ltd.

<b>Safety Precautions</b>	For the safe use of your camera, be sure to read the safety precautions thoroughly.
<b>Test shooting</b>	Please be sure to do some test shooting to make sure it is recording properly before normal use.
<b>Copyright</b>	Reproduction or alteration of copyrighted documents, magazines, music and other materials, other than for personal, home or similarly limited purposes, without the consent of the copyright holder is prohibited.
<b>Exemption from Liability</b>	Ricoh Co., Ltd. assumes no liability for failure to record or play back images caused by malfunction of this product.
<b>Warranty</b>	This product is manufactured to local specifications and the warranty is valid within the country of purchase. Should the product fail or malfunction while you are abroad, the manufacturer assumes no responsibility for servicing the product locally or bearing the expenditure incurred thereof.
<b>Radio Interference</b>	Operating this product in the vicinity of other electronic equipment may adversely affect the performance of both devices. In particular, operating the camera close to a radio or television may lead to interference. If interference occurs, follow the procedures below. <ul style="list-style-type: none"><li>• Move the camera as far away as possible from the TV, radio or other device.</li><li>• Reorient the TV or radio antenna.</li><li>• Plug the devices into separate electrical outlets.</li></ul>

- This publication may not be reproduced in whole or in part without the express written permission of Ricoh.  
© 2005 RICOH CO.,LTD. All rights reserved.
- The contents of this document may be changed in the future, without prior notice.
- This booklet was created with thorough attention to its content. If, however, you have a question, spot an error, or find a description lacking, please refer to the end of this booklet for information on how to contact us.

Microsoft, MS, Windows and DirectX are registered trademarks of Microsoft Corporation in the United States of America and other countries.

Adobe and Adobe Acrobat are trademarks of Adobe Systems Incorporated.

All trademarked company and product names mentioned in this manual are the property of their respective owners.

# Key Features

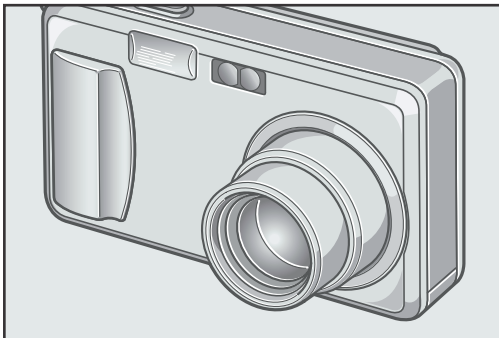

## Equipped with a wide zoom lens in 4.8x high magnification

This product has a compact body only 25 mm thick, featuring a 28 to 135mm\* wide 4.8x lens that applies to most normal shooting. The lens supports the shooting of various indoor and outdoor scenes.

\* Equivalent to that on a 35mm camera



## Rapid shutter response to capture a moment (P.31)

The shutter release time lag is as short as 0.1 seconds.

Ricoh's patented hybrid auto focusing system technology even keeps action shots looking good.



## 1-cm macro (P.37) and close flashing for 13 cm (for Telephoto) or 20 cm (for Wide-angle) (P.38)

The unsurpassed macro function allows you to capture details from a very close distance at only 1 cm. The camera also has a built-in flash for very close shots within 13 cm (for Telephoto) and 20 cm (for Wide-angle). This combination will give you clear macro shots even under low light conditions.

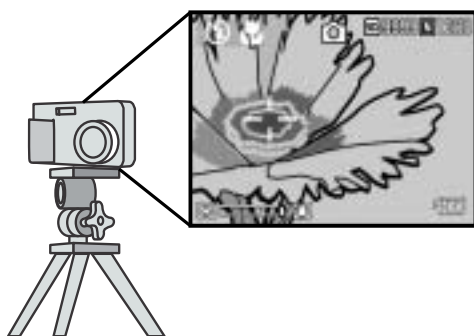

## AF target shift function for easy focus lock even on a tripod (P.83)

The camera has an AF target shift function. At macro shooting, the AF target shift function allows you to lock the focus by button operation, without moving the camera itself.

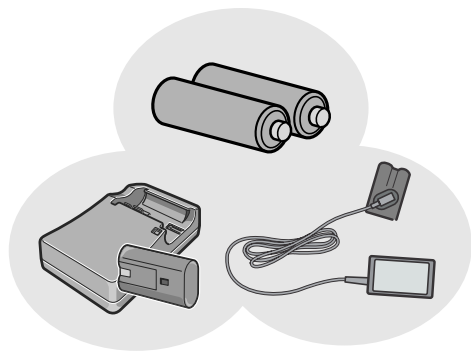

## Choice of three power sources makes sure you won't miss any shooting opportunities (P.16)

The camera can be used with one of three power supplies: Dedicated large-capacity rechargeable battery, an AA alkaline battery easily available anywhere (available in stores), and an economical AC adapter (sold separately) useful for transfer to a computer.

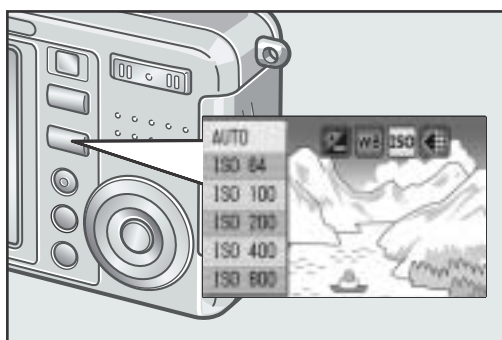

## Adjust (ADJ.) button for easy customizing to optimum setting (P.57)

The ADJ. button reduces button operation steps. It allows you to quickly adjust the exposure, white balance, and ISO sensitivity with minimum steps. You can also assign a function as required.



## High-quality movie with sound of 30 or 15 frames/second (P.89)

A high-quality movie of 320 x 240 pixels can be shot at 30 frames/second with sound.



## Scene mode for easy and beautiful shooting (P.39)

In Scene Mode, you need only to select from among six types of shooting modes for shooting with optimal settings for the scene.

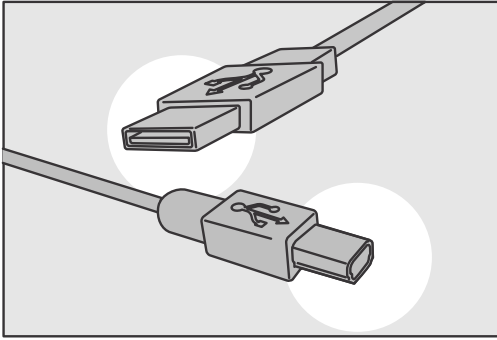

## **Instant transfer to PC through the USB cable**

If the provided software is installed on your computer, just connecting the camera to your computer with the provided USB cable will automatically transfer images to your computer.



## **Provided with multi-functional software "ImageMixer" that helps in not only managing shot images in an album, but also editing images and sounds, and creating video CDs**

For the integrated handling of images, this software has a input function to download still images, movies, and sounds from a digital camera or music CD, an album function to manage captured contents, an edit function to edit movies by MPEG-1, a layout function to create layouts using still image contents, and a disk creation function to create video CDs.

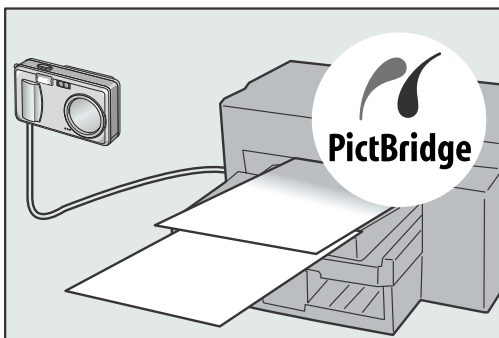

## **Direct printing without requiring any computer (P.52)**

A direct print compatible printer can be connected to the camera with the USB cable for direct transfer. This allows for easy printing without using a computer.

# Contents

## Chapter 1 Quick Guide

<b>Before Shooting</b> .....	<b>10</b>
Packing List.....	10
Names of parts.....	12
About LCD Monitor Display.....	14
<b>Getting Ready to Shoot</b> .....	<b>16</b>
About the Batteries.....	16
Batteries (Cells) Not Acceptable.....	17
Battery level indication.....	18
About an SD Memory Card (available in stores).....	19
Charging the Rechargeable Battery.....	20
Loading the Rechargeable Battery and SD Memory Card.....	21
Inserting Dry Cells (available in stores).....	23
Turning the Power On/Off.....	24
Setting the language.....	25
Setting the date and time.....	26
Changing the Display.....	27
Maximizing the LCD Monitor Brightness.....	27
Histogram Display.....	28
<b>Basic Shooting</b> .....	<b>29</b>
How to Hold the Camera.....	29
Preventing camera shake.....	30
Capturing the Moment Shooting (Full-press).....	31
Checking the Focus and Shooting (Half-press).....	32
When the Subject is not Centered (Shooting with Focus-lock).....	34
Using the Zoom Function.....	36
Shooting Close-Ups (Macro-Mode).....	37
Using the Flash.....	38
Shooting with Scenery-Matching.....	39
<b>Playing Back</b> .....	<b>41</b>
Checking the image you just took (Quick Review).....	41
Viewing Your Images.....	42
Playing back in the three-frame view.....	43
Thumbnail Display.....	45
Magnifying Images.....	46
<b>Viewing on a Television</b> .....	<b>47</b>
<b>Erasing</b> .....	<b>49</b>
Erasing Unwanted Images.....	49
Erasing Multiple Frames at One Time.....	50

## Chapter 2 A Variety of Shooting Techniques/Playback

<b>Direct Printing</b> .....	<b>52</b>
Direct Print Function.....	52
Connecting the Camera to a Printer.....	52
Printing Still Images.....	53

<b>A Variety of Shooting Techniques .....</b>	<b>57</b>
Using the ADJ. (Adjust) Button.....	57
Shooting Setting Menu .....	58
Using the Shooting Setting Menu.....	59
Choosing Picture Quality Mode/Image Size (PIC QUALITY/SIZE) .....	60
Manual Focus Shooting (FOCUS).....	62
Changing the Light Metering (PHOTOMETRY) .....	65
Changing the Edge Quality of Still Images (SHARPNESS) .....	66
Setting Color Depth (COLOR DEPTH).....	67
Shooting Consecutively with Different Exposures (AUTO BRACKET) .....	68
Shooting Consecutively with Different White Balance (WHITE BALANCE BRACKET) .....	69
Using Long Time Exposure (TIME EXPOSURE) .....	71
Shooting Pictures Automatically at Set Intervals (INTERVAL).....	72
Shooting a Still Image with Sound (IMAGE WITH SOUND) .....	74
Inserting the Date into a Still Image (DATE IMPRINT).....	75
Changing the Exposure (EXPOSURE COMP.).....	76
Using Natural and Artificial Lighting (WHITE BALANCE).....	77
Changing Sensitivities (ISO SETTING).....	79
Limiting the Shutter Release Speed (SLOW SHUTTER LMT).....	80
Returning the Shooting Setting Menu Settings to their Defaults (RESTORE DEFAULTS) .....	81
Changing Shading for Shooting Text (DENSITY) .....	82
Using the AF Target Shift Function .....	83
Using the Self-Timer.....	84
<b>Shooting with Multi-Shot.....</b>	<b>85</b>
CONT .....	87
SCONT (S Multi-Shot).....	87
MCONT (M Multi-Shot).....	87
Viewing an S Multi-Shot or M Multi-Shot Still Image in Enlarged Display Mode .....	88
<b>Shooting/Playing Back Movies .....</b>	<b>89</b>
Shooting Movies .....	89
Setting the Frame Rate .....	90
Playing Back Movies .....	91
<b>Recording/Playing Back Sound.....</b>	<b>92</b>
Recording Sound (Voice Memo) .....	92
Playing Back Sound .....	93
<b>Other Functions Available in Playback Mode .....</b>	<b>94</b>
Playback Setting Menu.....	94
Using the Playback Menu.....	94
Showing Photos in Order Automatically (SLIDE SHOW).....	95
Write-protecting Your Images (PROTECT) .....	96
Using a Printing Service (DPOF: Dee-Pof) .....	99
Changing the Image Size (RESIZE).....	102
Copying the Contents of Internal Memory to a Memory Card (COPY TO CARD) .....	103

## **Chapter 3      Changing Camera Settings**

<b>Changing Camera Settings .....</b>	<b>106</b>
SETUP Menu .....	106
Using the SETUP Menu .....	107
Getting the SD Memory Card Ready for Use (FORMAT [CARD]) .....	108
Formatting Internal Memory (FORMAT [INT. MEM.]) .....	109
Adjusting the Brightness of the LCD Monitor (LCD BRIGHTNESS) .....	110

Setting a Function to the ADJ. Button (ADJ BTN.SET.).....	111
Changing Auto Power-Off Settings (AUTO POWER OFF) .....	112
Changing the Beep Sound Setting (BEEP SOUND) .....	113
Changing the Beep Sound Volume (Volume Setting) .....	114
Changing Image Confirmation Time (LCD CONFIRM.) .....	115
Changing File Name Settings (SEQUENTIAL NO.) .....	116
Setting the Date and Time (DATE SETTINGS).....	117
Changing the Display Language (LANGUAGE/ 言語 ) .....	118
Changing the Playback Method for Viewing on TV (VIDEO OUT MODE) .....	119
Changing the Setting of Step Zooming (STEP ZOOM).....	120
Displaying a Setting Change Warning (SHTG STGS WARNG.).....	121
Changing the USB Communication System (USB Connection).....	122
Enlarging Icon Display (ENLGE PHOTO ICON) .....	126

## **Chapter 4 Installing Software**

---

<b>Installing the Provided Software (For Windows) .....</b>	<b>128</b>
System Requirements for Using the Provided Software .....	130
Installing the Software on Your Computer.....	131
Connecting the Camera to Your Computer .....	133
Installing Acrobat Reader .....	135
Installing DirectX .....	136
Uninstalling the Software.....	137
Uninstalling the ImageMixer .....	138
<b>Installing the Provided Software (For Macintosh) .....</b>	<b>139</b>
System Requirements for Using the Provided Software .....	141
Installing the Software on Your Computer (Mac OS 8.6 to 9.2.2) .....	142
Installing the Software on Your Computer (Mac OS X 10.1.2 to 10.3).....	143

## **Chapter 5 Troubleshooting**



---

<b>Troubleshooting.....</b>	<b>146</b>
Troubleshooting the Camera.....	146
Warning Messages Under Windows XP Service Pack 2 .....	151
<b>Appendices.....</b>	<b>153</b>
A. Specifications .....	153
B. Optional Accessories .....	155
C. Combination of Scene Mode and Function.....	156
D. Menu Items By Mode.....	157
E. Functions Whose Defaults will be Restored upon Power-off .....	158
F. Number of Images That Can be Stored in Internal Memory/SD Memory Card.....	159
G. Using Your Camera Abroad .....	160
H. Cautions on Use .....	161
I. Care and Storage .....	162
J. Error Messages .....	163
K. Warranty and Servicing.....	164
Index.....	166



# Using Manuals

The two manuals included are for your Caplio R2.

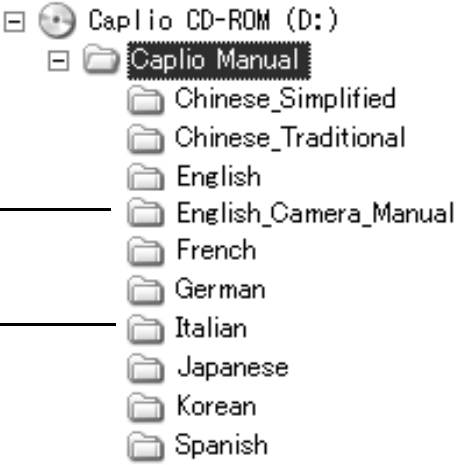
	<p><b>Camera User Guide (This booklet)</b></p> <p>This guide explains the usage and functions of the camera. You will also see how to install the provided software on your computer.</p> <p>*The Software User Guide (English edition) is available from the provided CD-ROM as a PDF file.</p>
	<p><b>Software User Guide (PDF file)</b></p> <p>This guide explains how to download images from the camera to your computer, and display and edit them on your computer.</p> <p>*The Software User Guide is available from the following folder on the provided CD-ROM.</p> <div data-bbox="911 972 1369 1435"><ul style="list-style-type: none"><li>Caplio CD-ROM (D:)<ul style="list-style-type: none"><li>Caplio Manual<ul style="list-style-type: none"><li>Chinese_Simplified</li><li>Chinese_Traditional</li><li>English</li><li>English_Camera_Manual</li><li>French</li><li>German</li><li>Italian</li><li>Japanese</li><li>Korean</li><li>Spanish</li></ul></li></ul></li></ul></div> <p>"Software User Guide (English edition)" (PDF file)</p> <p>Each language has its own Software User Guide in the respective folder.</p>

## To copy the Software User Guide onto your hard disk

Copy the PDF file from the above folder.



## Reference

The camera is provided with software (ImageMixer) that allows you to display and edit images from your computer. For how to use ImageMixer, click the [?] button on the ImageMixer window and see the displayed manual.

For more information on the ImageMixer, contact the Customer Support Center below.

North America (Los Angeles) TEL: +1-213-341-0163  
Europe (U.K.) TEL: +44-1489-564-764  
Asia (Philippines) TEL: +63-2-438-0090  
China TEL: +86-21-5450-0391  
Registration time: 9:00 - 17:00





## How to Use This Guide

---

Chapter 1 explains the basic operations of this product.

If you are using the camera for the first time, read from this chapter.

The following symbols are also used in this guide:

 Important	This indicates important notices and restrictions for using this camera.
 Note	This indicates supplementary explanations and useful tips about camera operations.
 Term	This indicates terms that are useful for understanding the explanations.
 Reference	This indicates page(s) relevant to a particular function.

The LCD Monitor Display examples may be different from actual display screens.

# Chapter 1

## Quick Guide

If you are using the camera for the first time, read from this chapter.

<b>Before Shooting</b> .....	<b>10</b>
<b>Getting Ready to Shoot</b> .....	<b>16</b>
<b>Basic Shooting</b> .....	<b>29</b>
<b>Playing Back</b> .....	<b>41</b>
<b>Viewing on a Television</b> .....	<b>47</b>
<b>Erasing</b> .....	<b>49</b>

# Before Shooting

## Packing List

Open the package and make sure all the items are included.

- Caplio R2



- AV Cable

Used when viewing your images on a TV unit.

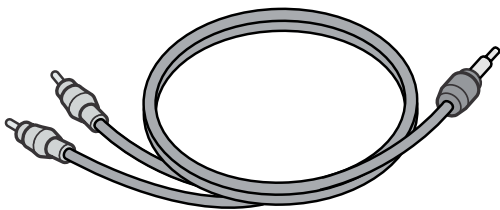

- USB Cable

Used to connect the camera to a computer or Direct Print supported printer.

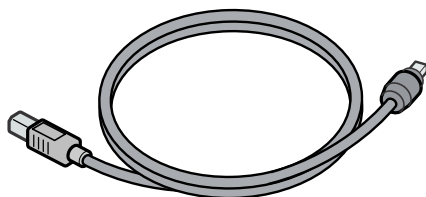

- Handstrap

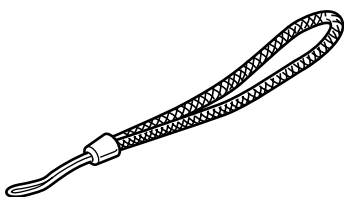

- Rechargeable Battery

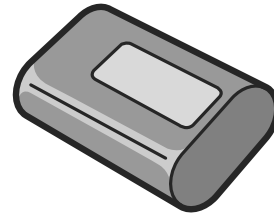

- Battery Charger

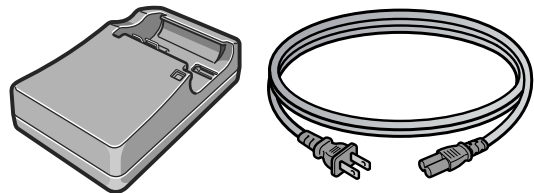

### Note

#### Attaching the hand strap to the camera

Thread the tips of the strap through the camera's strap eyelet and loop them as shown.



The serial number of this product is given on the bottom face of the camera.

- Camera User Guide  
(This booklet)



- Warranty

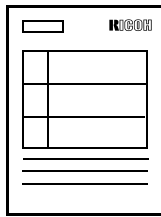

- Safety Precautions



- Caplio Software CD-ROM  
The provided software and the Software User Guide are included on this CD-ROM.



## Optional Accessories

- AC Adapter (AC-4b)  
Used for power supply from a home outlet to the camera. Connect this adapter for long time play or image transfer to a personal computer.

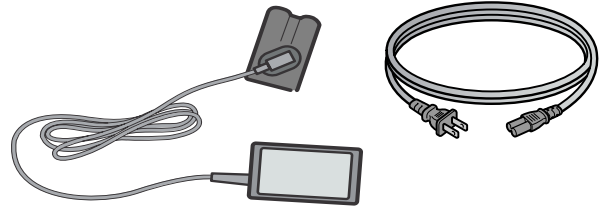

- Rechargeable Battery (DB-50)

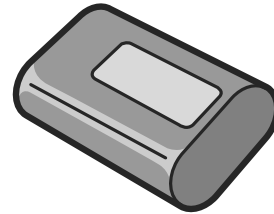

- PC Card Adapter (FM-SD53)  
For when you want to load an SD Memory Card directly into your computer's PC Card Slot.
- SD Memory Card (available in stores)

## Reference

For the latest information about accessories, access Ricoh home page (<http://www.ricohpmmc.com>).

# Names of parts

## Camera

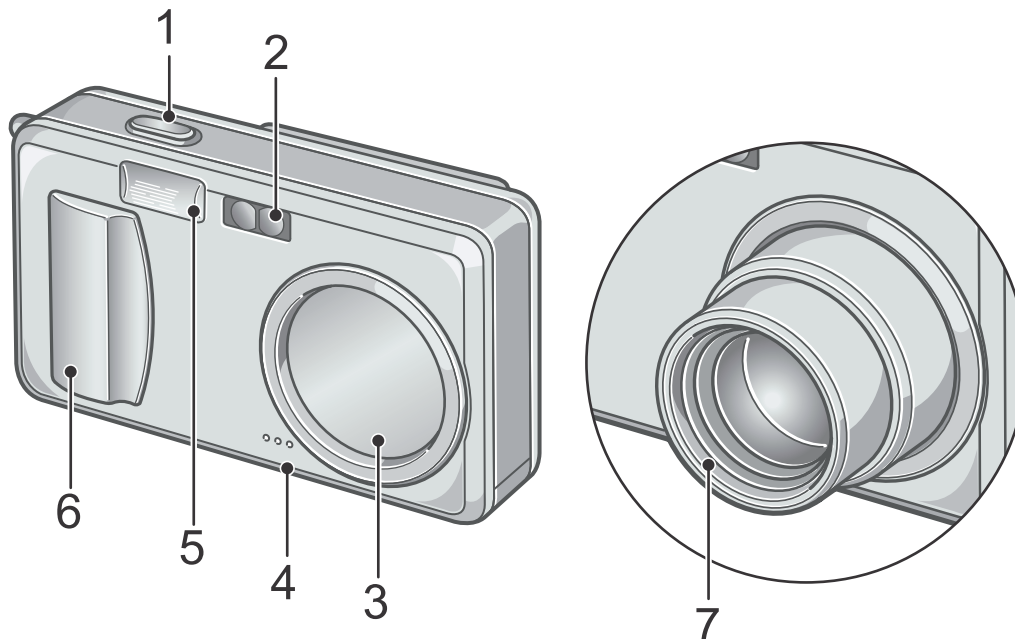

## Front View

	Item Name	Refer to
1	Shutter Release Button	P.29
2	AF Window	-
3	Lens Cover	-
4	Microphone	P.92
5	Flash	P.38
6	Power Switch	P.24
7	Lens	P.29

## Mode Selector

You can select one of the three modes with the mode selector.

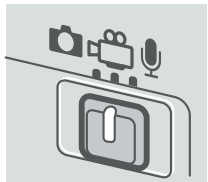
	Still Image Mode	Allows you to shoot still images.
	Movie Mode	Allows you to shoot movies.
	Voice Memo Mode	Allows you to record sounds.

## Rear View

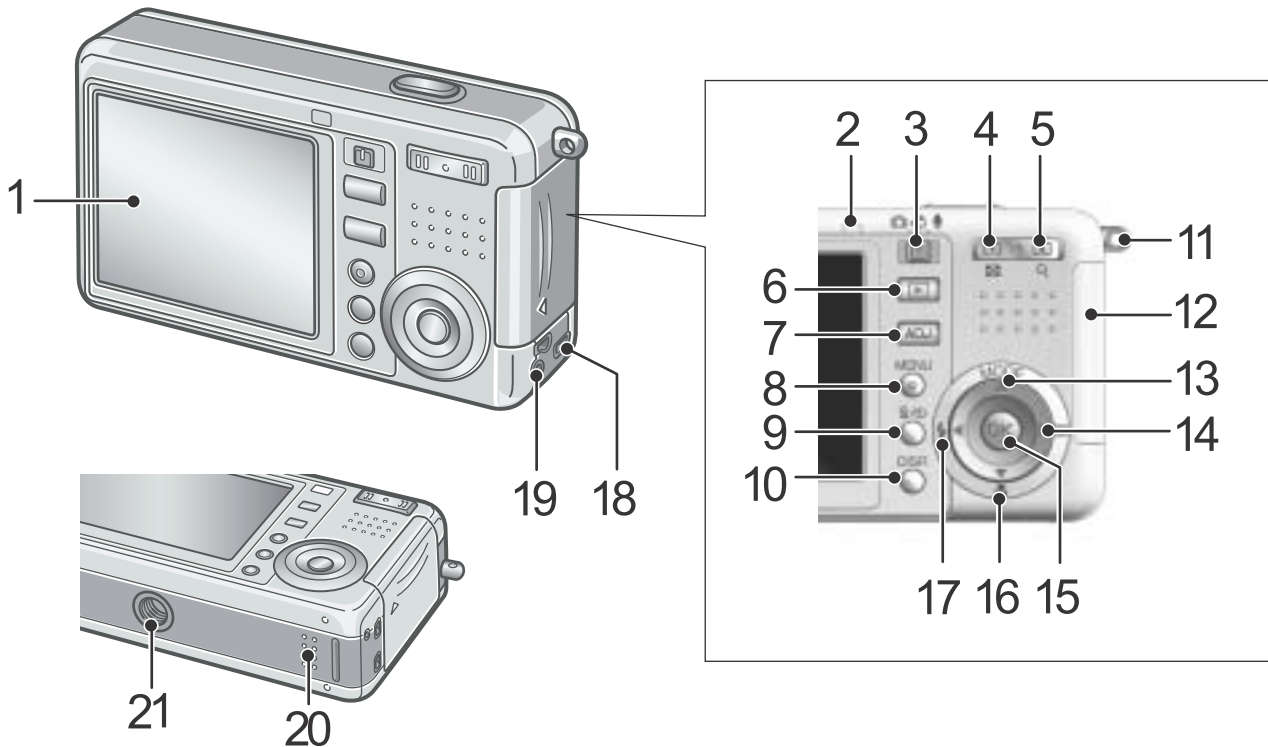

	Item Name	Refer to		Item Name	Refer to
1	LCD Monitor	-	12	Battery/Card Cover	-
2	Auto Focus/ Flash Lamp	P.32 P.38	13	▲/MODE Button	P.39
3	Mode Selector	P.12	14	▶/⌂(Quick Review)Button	P.41
4	⌂ (Wide-angle) / 🖼️ (Thumbnail Display) Button	P.36 P.45	15	OK Button	-
5	⌂ (Telephoto)/ 🔍 (Enlarged View) Button	P.36 P.46	16	▼/🌸 (Macro) Button	P.37
6	Playback Button	P.41	17	⬅️/⚡(Flash) Button	P.38
7	ADJ. Button	P.57	18	USB Terminal	P.133
8	MENU Button	P.59 P.94 P.106	19	AV Output Terminal	P.47
9	🗑️ (Delete) / ⌚ (Self-timer) Button	P.49 P.84	20	Speaker	P.91 P.93
10	DISP. Button	P.27	21	Tripod Screw Hole (underside)	-
11	Strap Eyelet	P.10			

# About LCD Monitor Display

## Screen Examples when Shooting Pictures

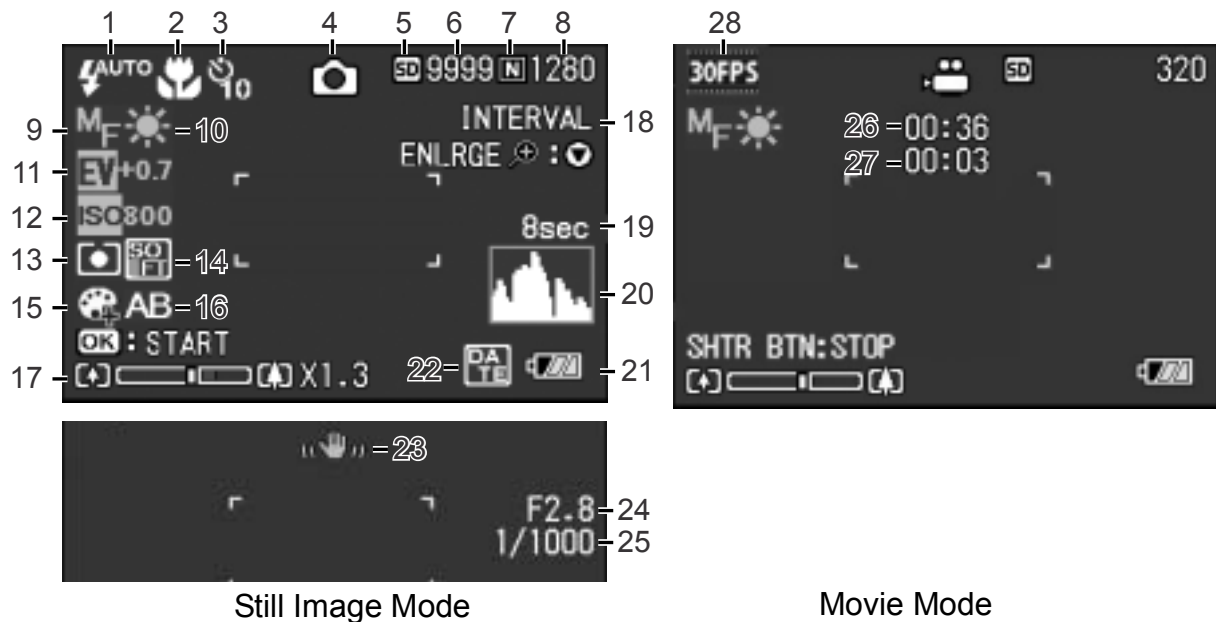

Still Image Mode

Movie Mode

Item Name	Refer to	Item Name	Refer to
1 Flash	P.38	15 Color Depth	P.67
2 Macro Shooting	P.37	16 Auto Bracket	P.68
3 Self-timer	P.84	17 Zoom Bar	P.36
4 Mode Types	-	18 Interval	P.72
5 Recording Destination	P.19	19 Time Exposure	P.71
6 Remaining Number of Still Images	P.159	20 Histogram	P.28
7 Picture Quality	P.60	21 Battery	P.16
8 Image Size	P.60	22 Date/Time	P.75
9 Focus	P.62	23 Camera Shake	P.30
10 White Balance	P.77	24 Aperture Value	P.32
11 Exposure Comp.	P.76	25 Shutter Speed	P.32
12 ISO Setting	P.79	26 Remaining Recording Time	P.159
13 Photometry	P.65	27 Recording Time	P.159
14 Sharpness	P.66	28 Frame Rate	P.90



### Note

- The number of remaining shots available may differ from the actual number of shots, depending on the subject.
- Even between cards of the same capacity, the number of remaining shots and other values may vary with the manufacturer, type, and shooting condition.
- The continuous shooting (recording) time depends on the card type, capacity, and performance.
- When the number of remaining shots is 10,000 or more, "9999" is displayed.



## The Screen During Playback

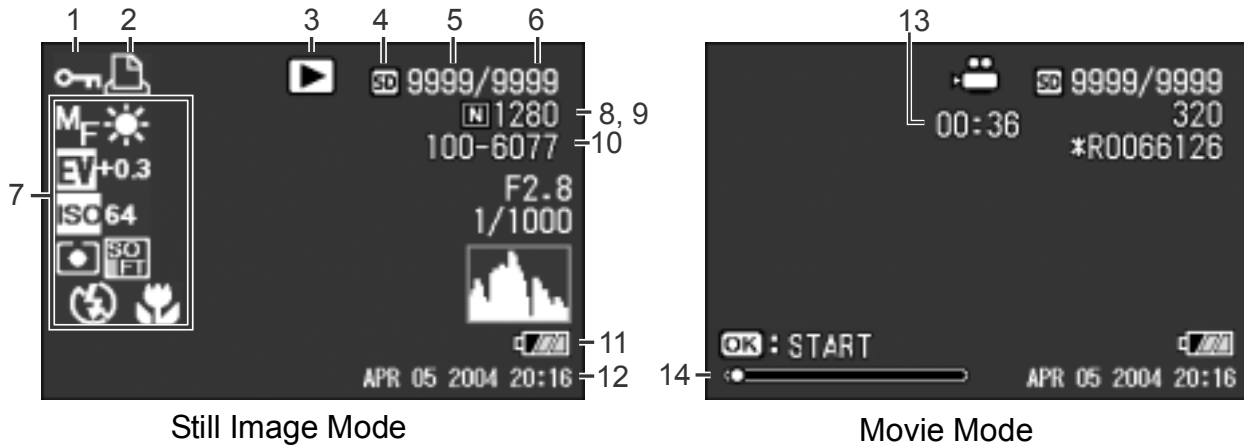

	Item Name	Refer to		Item Name	Refer to
1	Protect	P.96	8	Picture Quality	P.60
2	DPOF	P.99	9	Image Size	P.60
3	Mode Types	-	10	File No.	-
4	Playback Data Source	P.42	11	Battery	P.16
5	Number of Playback Files	-	12	Date at Shooting	P.75 P.117
6	Total Number of Files	-	13	Recording Time or Lapsed Time	-
7	Setting at Shooting (Recording)	-	14	Indicator	-



### Note

The LCD monitor may display messages to inform you of operational instructions or the camera's status while in use.

# Getting Ready to Shoot

Turn the power on and get ready to shoot.

## Note

If you have already used this camera, follow the steps below to make sure it is turned off before removing or loading batteries.

1. Make sure the LCD monitor is turned off.
2. Make sure the lens cover is closed.

For how to turn the camera off, see P.24.

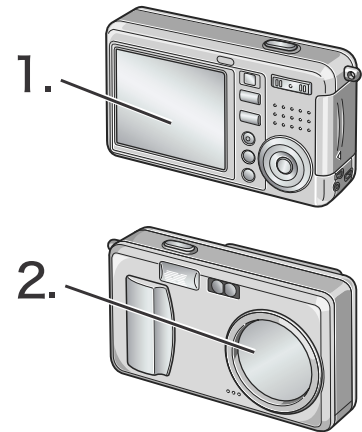

## About the Batteries

The following batteries can be used in the camera. Please choose which kind to use according to your needs.

### • Rechargeable Battery DB-50 (Included)

This is a lithium-ion battery. This is economical because you can recharge it using the battery charger and use it over and over again. They last a long time, so they are convenient for travel.

### • AA Alkaline Batteries (LR6) (available in stores)

You can obtain them anywhere, so they are convenient for travel.

However, in a low-temperature environment the number of shots you can take will decrease. Warm the batteries before use. It is recommended that you use the rechargeable battery when using the camera for a long time.

### • AA Nickel Batteries (available in stores)

These batteries are not rechargeable. However, they last a long time as compared with AA Alkaline Batteries when used with a digital camera.

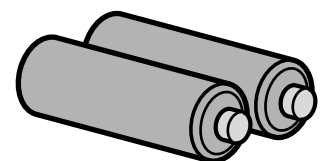
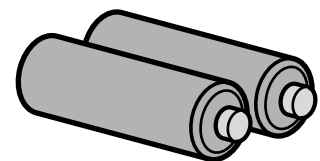
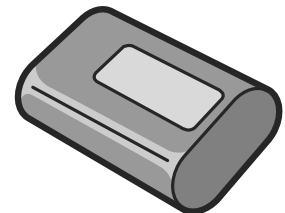

- **Nickel-Hydrogen Battery (available in stores)**

This is economical because you can recharge and use it over and over again. Use a charger (available in stores) for charging.

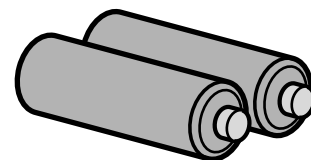

The battery may be inert and consequently it may not supply power immediately after it is purchased or left unused for more than a month. In such a case, recharge the battery two or three times before use. The battery self-discharges with time even if the camera is not used, so recharge it before use.

- **AA-size Oxide (oxy nickel hydroxide) dry cell (available in stores)**

This cell has a longer life than an AA-size alkaline dry cell.

In addition to the batteries, you can use the AC Adapter (P.155).

## Batteries (Cells) Not Acceptable

The camera does not accept the following batteries (cells):  
Manganese dry cell (R6), Ni-Cd battery, CR-V3



### Note

#### Indication of the number of images you can take

Battery Type	Number of Shots
Rechargeable Battery (DB-50)	Approx. 500
AA Alkaline Batteries (LR6)	Approx. 200

- Based on CIPA standard (Temperature: 23 degrees Celsius, LCD on, 30 seconds between shots, changing the zoom setting from telephoto to wide or wide to telephoto for each shot, 50% flash usage, turning the power off after each 10 shots).
- Number of shots of the AA Alkaline Batteries (LR6), it is using the AA Alkaline Batteries by Matsushita Battery Industrial Co., Ltd.
- If you set the camera to the Power-Save or Synchro-Monitor mode, the number of shots you can take will increase.
- The number of shots is for reference only. If the camera is used for long periods of time for setting and playback, the shooting time (the number of shots) will decrease.



### Reference

- For how to insert the Rechargeable Battery, see P.21.
- For how to use the AC Adapter, see P.155.





## Caution

- Please remove the batteries if you are not going to use the camera for a long period of time.
- The life of an AA alkaline battery (LR6) depends on the brand and the storage time from the date of production. In addition, the life of an alkaline battery becomes shorter at low temperatures.
- The Nickel-Hydrogen Battery is not factory-charged. Charge it before use. Immediately after the purchase or after a long storage, the battery may not be charged fully. Repeat charging and discharging before use. For details, see the documentation that came with the battery or charger.
- The battery may become very hot immediately after operation. Turn the camera off and leave it to cool down sufficiently before removing the battery.





## Battery level indication

A battery mark appears at the lower left of the LCD monitor to indicate the battery level. Prepare new batteries before the batteries wear out.

Battery Mark	Description
	Sufficient battery charge
	Low remaining charge: Prepare new batteries.
	No remaining charge: Replace the batteries.



## Caution

- If you are using nickel metal hydride batteries,  may not appear or  or  may appear immediately depending on the battery type and environmental conditions. Check the batteries at hand before use.
- If you are using the AC Adapter,  may appear. This does not indicate malfunction and you can continue to use the camera.



## About an SD Memory Card (available in stores)

You can store still images you have taken either in the camera's internal memory or on an SD Memory Card (available in stores). The internal memory capacity is 28 MB.

When you want to record a lot of still images, movies or sounds at high resolutions, use a high-capacity SD Memory Card.

### Note

#### Where images are recorded

When no SD memory card is inserted, the camera records images in the internal memory; when an SD memory card is inserted, it records images on the memory card.

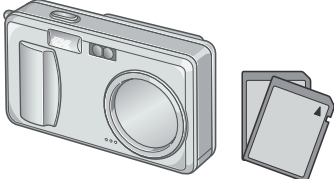
When no memory card is loaded	When an SD Memory Card is loaded
	
Records to internal memory	Records to the SD memory card

### Caution

- If an SD memory card is loaded, the camera will not record to the internal memory, even if the card is full.
- Take care not to get the metal parts of the card dirty.

### Note

#### Write-protecting your images

If you move the card's write-protection switch to LOCK, your still images cannot be accidentally erased and the memory card cannot be formatted. If you release the protection (by returning the switch to its original position), it is once again possible to erase images and format the card.

So it's a good idea to switch to LOCK when you have some important data recorded. Note that you cannot shoot images in the LOCK state because no data can be recorded on the card. Unlock the card when shooting.

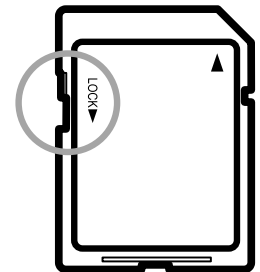

### Reference

- For switching between the SD Memory Card and internal memory during playback, see P.42.
- For recording capacities, see P.159.

# Charging the Rechargeable Battery

The rechargeable battery needs to be charged before use.

- 1. Insert the battery, making sure that the ⊕ and ⊖ markings on the battery match with those on the battery charger.**

The battery label should face up.



## Caution

Be careful not to reverse the ⊕ and ⊖ sides.

- 2. Plug the power cord into an outlet.**

Charging starts and the charger lamp shows you the progress as shown below. Once charging has finished, unplug the power cable from the power outlet.

Depending on the battery level, the charging time differs:

Charger Lamp	Description
Lit	Charging started
Unlit	Charging complete
Flashing	Battery charger or battery may be faulty (Unplug the power cable from the power outlet and remove the battery from the battery charger.)

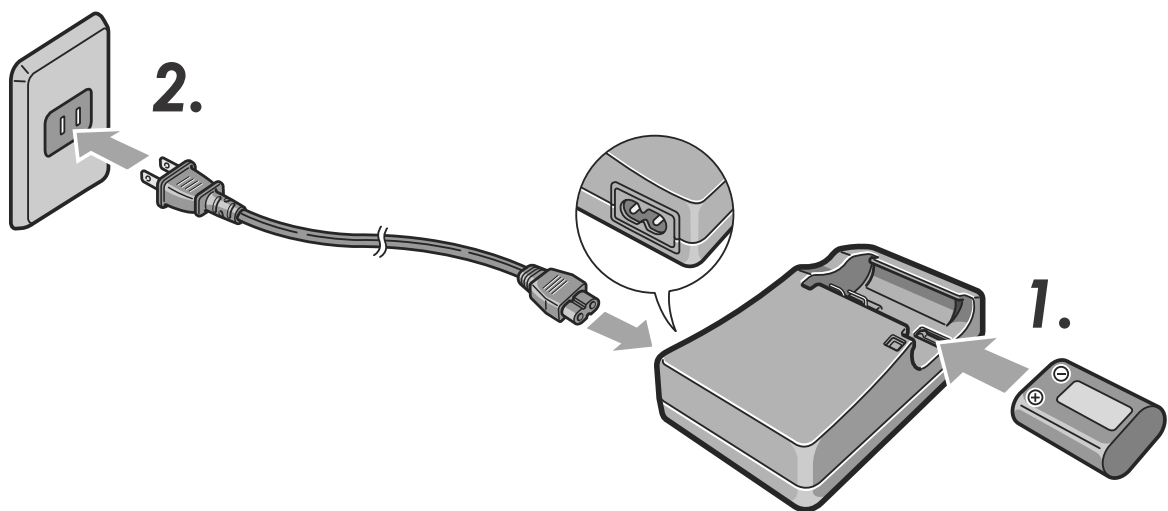

## Loading the Rechargeable Battery and SD Memory Card

The rechargeable battery (DB-50) is another option for powering this camera. This battery is convenient because it can be used over and over again by recharging, and the battery power lasts long. If you have already used this camera, make sure it is turned off before loading batteries.

### 1. Open the battery/card cover.

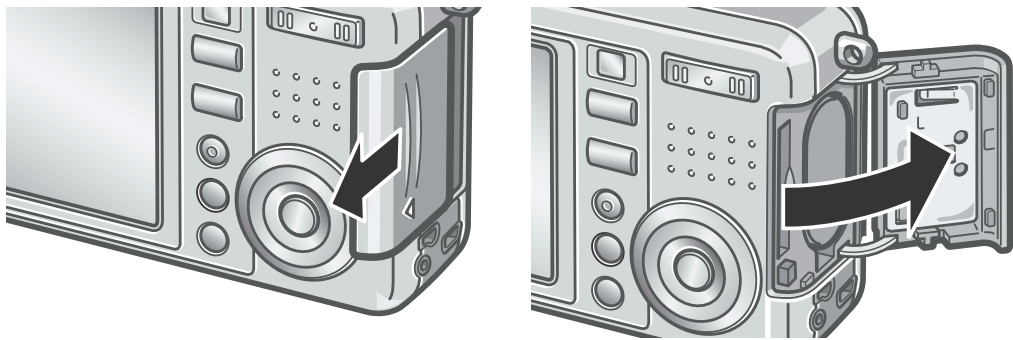

### 2. Make sure the card is facing the right way and then push the card all the way in until it clicks.

The rechargeable battery may be inserted first.

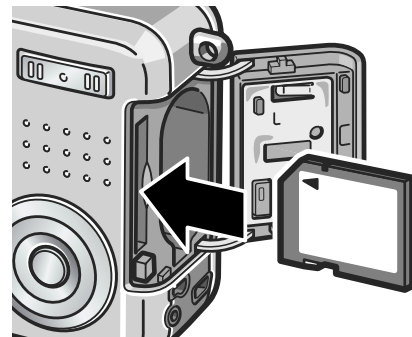

### 3. Insert the rechargeable battery.

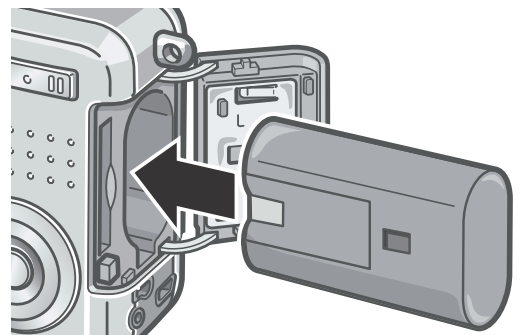

#### 4. Close the battery/card cover and slide it back into place.

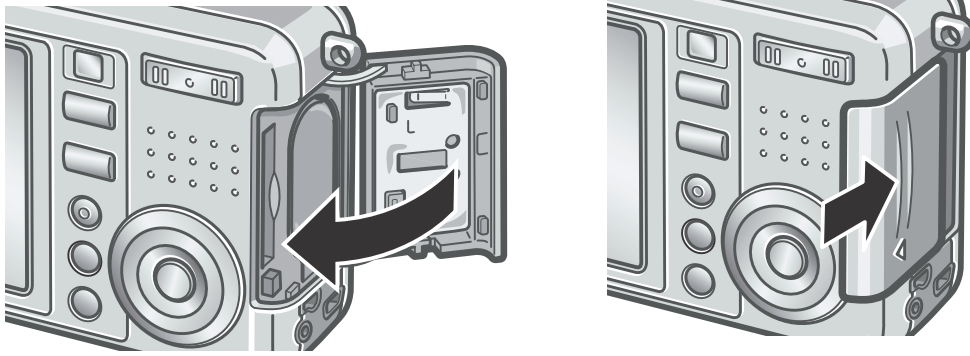

#### Caution

- Please remove the rechargeable batteries if you are not going to use the camera for a long period of time.
- Store the removed battery in a dry cool place.
- Use the battery charger (sold separately) to recharge the battery.

#### Rechargeable battery charging time

DB-50

About three hours (25°C)

#### Reference

For how to format an SD memory card, see P.108.



## Inserting Dry Cells (available in stores)

If you have already used this camera, make sure it is turned off before loading batteries and memory card.

### 1. Open the battery/card cover.

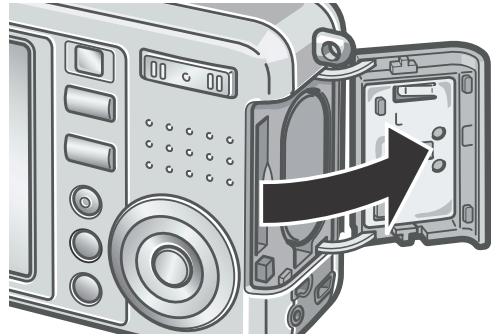
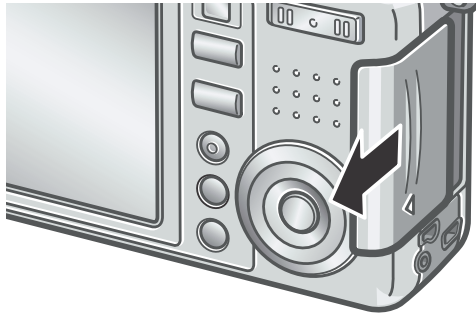

### 2. Insert the two batteries, making sure they are facing the correct way.

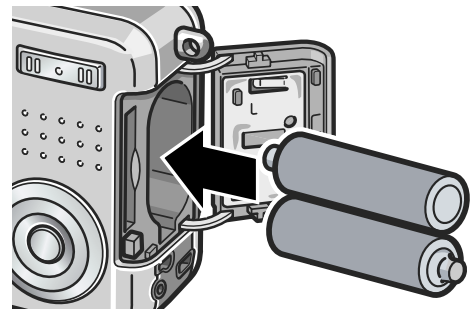

### 3. Close the battery/card cover and slide it back into place.

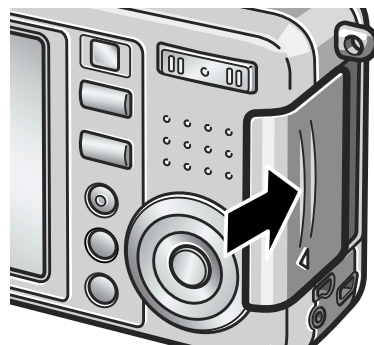
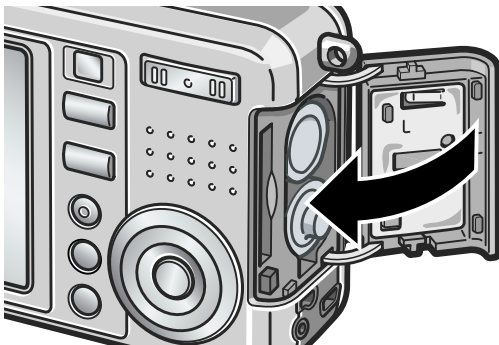

## Turning the Power On/Off

To turn the power on:

1. **Slide the power switch to open the lens cover.**

After the start sound, the auto-focus/flash lamp blink for several seconds.

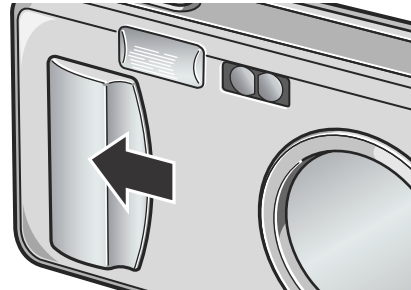

### Using the Camera in Playback Mode

If the Playback button is pressed with the lens cover closed, the power is turn on in Playback Mode and the camera can be used in this mode.

To turn the power off:

1. **Slide the power switch to close the lens cover.**

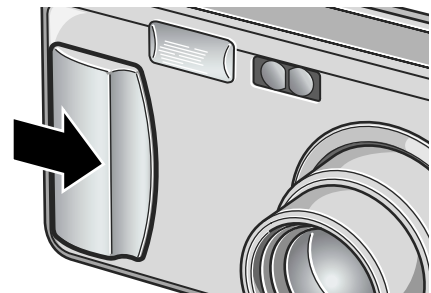

### Caution

It takes longer from power-on until the camera becomes ready for shooting when the flash is enabled than when it is disabled.



### Note

#### Auto Power Off

If the camera goes unused for a set period of time, it will automatically turn itself off to save power. To continue on using the camera, slide the power switch to close the lens cover once (power-off) and slide it again to open (power-on).



### Reference

For how to change the Auto Power Off setting, see P.112.

## Setting the language

When the power is turned on for the first time, the language setting screen appears (for the LCD monitor display language). After setting the language, go on to the date/time setting (for printing the date and time on your photos).

You can shoot without these settings. However, be sure to set the language, and the date/time later. Use the SETUP screen for these settings.



### Note

To display the SETUP screen, turn the mode dial to SETUP.

### 1. Turn the power on for the first time after purchase.

The language selection screen appears.

To skip language setting, press the MENU button.

When the MENU button is pressed, the language setting is cancelled and the video signal format-setting screen appears.

### 2. Press the ▲▼◀▶ buttons to select a language.

### 3. Press the OK button.

The display language is set, and the date/time setting screen appears.



### Reference

For how to set the display language and date/time on the SETUP screen, see "Changing the Display Language (LANGUAGE)" and "Setting the Date and Time (DATE SETTINGS)" in this guide.



## Setting the date and time

When the power is turned on for the first time and the language setting is completed, the date/time setting screen appears.

### 1. Press the ▲▼◀▶ buttons to set the year, month, date and time.

Change the value with ▲▼ and move the frame with ◀▶.

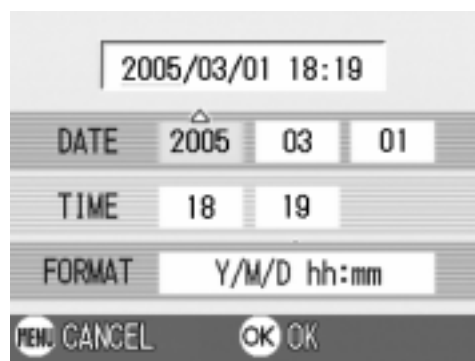

Setting at shipping

### 2. In [FORMAT], choose the Date and Time format.

Select the format with ▲▼.

### 3. Check the display on the bottom of the screen and then press the OK button.

The date is set.

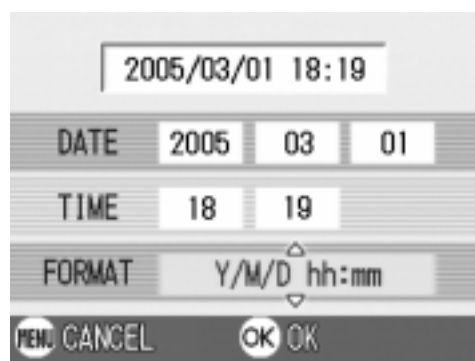

### Note

If the batteries are removed for more than one week, the date and time settings will be lost. These settings must be made again. Any other changes you made with the Setup mode and Shooting setup menu will also be reset.



### Reference

- For how to correct the date and time, see P.117.
- For how to put a date stamp on each frame, see P.75.

DISP.

## Changing the Display

If you press DISP., you can change the screen display mode, such as switching between display/no display of symbols, etc. Every time you press the DISP. button, the view cycles in the order of Histogram On, Grid Guide, No Display, LCD Monitor Off, and Normal Symbol Display.

Normal Symbol Display



Histogram On



Grid Guide

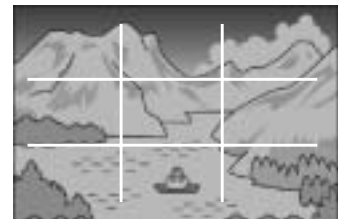

LCD Monitor Off  
(Synchro-Monitor Mode)

Switches screens with the  
DISP button



No Display

## Maximizing the LCD Monitor Brightness

Hold the DISP. button down to maximize the display brightness. When the brightness is maximal, holding the DISP. button down returns the brightness to the level set in [LCD BRIGHTNESS] (P.110).

### Term

#### Grid Guide

Displays auxiliary lines on the LCD monitor to help shooting. These lines are not recorded with images.

#### Synchro-Monitor Mode

Keeps the LCD monitor off except when the camera is operated. This mode is effective for saving power consumption. With this mode, half-pressing the shutter release button turns the LCD monitor on. Subsequently, full-pressing the shutter release button displays the shot image on the LCD monitor, and then turns the LCD monitor off.

# Histogram Display

When histogram display is on, a histogram appears in the lower right corner on the LCD monitor screen.

A histogram is a graph indicating the number of pixels on the vertical axis and the brightness on the horizontal axis. The brightness is shadow (dark), halftone, and highlight (light) from the left.

By using the histogram, you can judge the brightness of an image without being affected by the brightness around the LCD monitor. This also helps preventing voids and solids.

If the histogram has only peaks on the right side without anything else, this picture is over-exposed with too many pixels only for highlight sections.



If the histogram has only peaks on the left side without anything else, this picture is under-exposed with too many pixels only for shadow sections.

Correct the exposure to an appropriate level.



## Note

- The histogram displayed on the LCD monitor is for reference only. Depending on the shooting condition (flashing is required, the surrounding light is dark, and so on), the exposure level indicated in the histogram may not correspond to the brightness of the shot image.
- Exposure compensation has its limitation. It does not necessarily achieve the best possible result.
- The histogram having peaks in the center part does not necessarily provide the best result to suit your particular requirements.  
For example, an adjustment is required if you want to intentionally achieve under or over exposure.



## Reference

For details about exposure correction, see P.76.

# Basic Shooting

Now you are ready. Let's shoot!

## How to Hold the Camera

Hold the camera as illustrated below for best results.

1. **Hold the camera with both hands and lightly press both elbows against your body.**

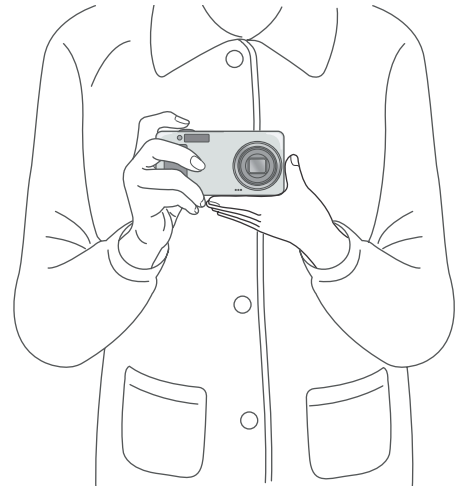

2. **Put your finger on the shutter button.**

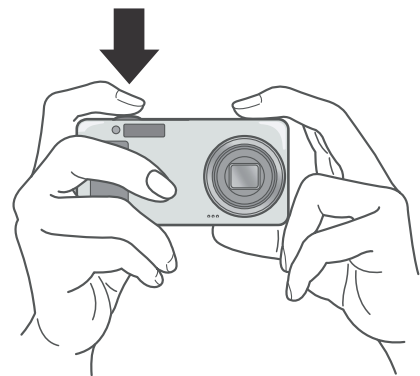

### Note

Be careful when you are shooting not to get a finger, your hair, or the strap in front of the lens or the flash.

## Preventing camera shake

---

If the camera moves when you press the shutter button, the still image might not come out clearly (due to camera shake). The  mark displayed on the LCD monitor indicates that camera shake should be avoided under the current shooting condition.

To prevent camera shake, use a tripod or hold the camera securely with both hands when you shoot.

Note that camera shake tends to occur in the following cases:

- When shooting in a dark place without using the flash
- When shooting in Slow Sync Mode (P.38)
- When using the Zoom function

If the camera shake mark (  ) is displayed, try the following:

- Using the flash (Set the camera to Forced Flash Mode) (P.38).
- Raising the ISO sensitivity (P.79).
- Using the self-timer (P.84).





## Capturing the Moment Shooting (Full-press)

The shutter release button works in two steps.

There are two methods of using the shutter button; pressing the shutter button all the way down at once (full-press) and pressing it halfway (half-press).

Full-press the shutter release button for quick focusing not to miss a shooting opportunity.

1. **To turn the power on, slide the power switch to open the lens cover.**

For how to turn the power on, see P.24.

2. **Switch the Mode Selector to .**

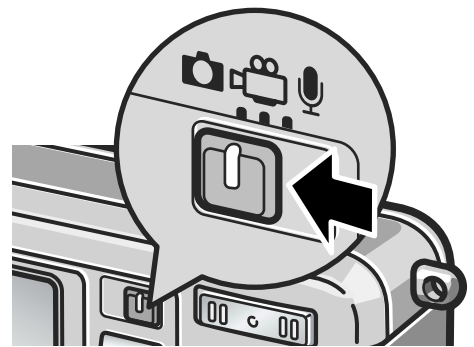

3. **Put the subject of your photo right in the middle of the LCD monitor and press the shutter release button half-way.**



4. **Put the subject of your photo right in the middle and press the shutter release button fully.**

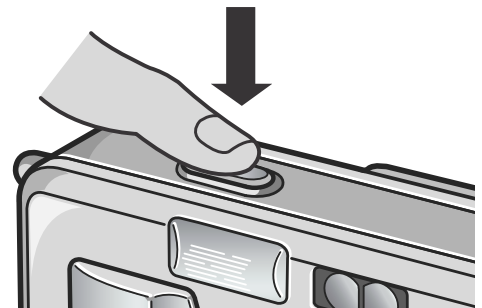

### Note

- The still image you have taken freezes for a moment on the LCD Monitor and is recorded. (P.115)
- Full-press is apt to cause camera shake. Hold the camera firmly with both hands and shoot.



## Checking the Focus and Shooting (Half-press)

When you press the shutter release button halfway (half-press), the autofocus function is triggered to determine the focal distance. Subsequently press it all the way down (full-press) to shoot. This is useful when the subject is not in the middle (see P.34).

1. To turn the power on, slide the power switch to open the lens cover.

For how to turn the power on, see P.24.

2. Switch the Mode Selector to .
3. Compose your shot by looking at the LCD Monitor.

4. Since the focus is adjusted at the center of the screen, position the subject at the center of the screen and half-press the shutter.

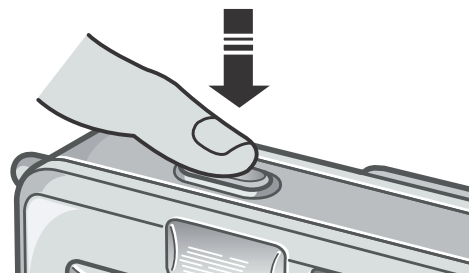
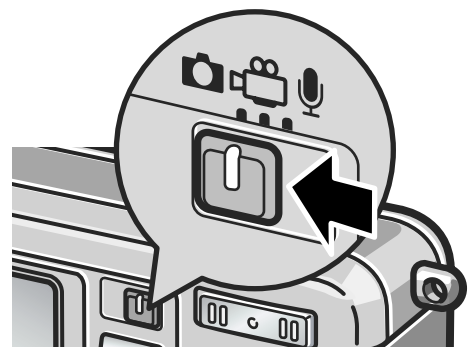

Once focused, the exposure and white balance are fixed.

If the automatic focusing fails, the frame in the center of the LCD monitor turn red and the auto-focus/flash lamp in the upper right of the LCD Monitor blinks in green.

Auto Focus/Flash Lamp

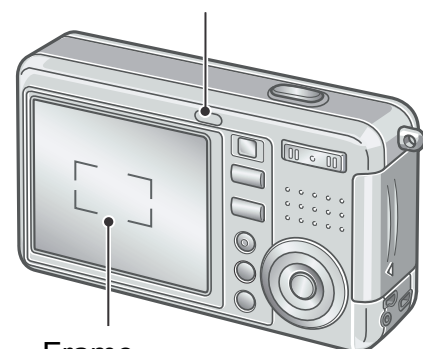

Frame

	Frame color	Auto Focus/Flash Lamp
Before focusing	White	Off
Focused	Green	On (green)
Focusing failure	Blink (red)	Blink (green)

A frame of green is displayed at the focus position.  
In some cases, several frames may appear.



## Reference

When specifying a focus position at macro shooting, use the AF target shift function. (P.83)

### 5. Gently press the shutter button all the way.

The still image you have taken freezes for a moment on the LCD Monitor and is recorded.

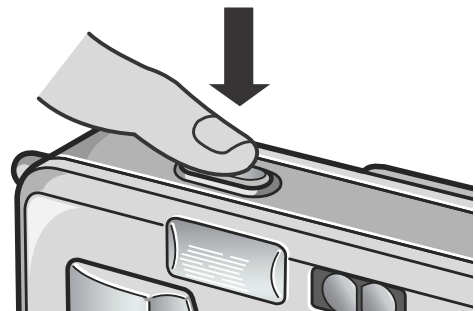

## Note

- Press gently to prevent camera shake when you press the shutter release button.
- The  mark indicates that blurring may occur. Hold the camera still and focus the camera again.
- When shooting in a dark place, the camera raises the focusing performance (auto focus precision) by preliminary flashing immediately before shooting. This preliminary flashing is skipped for shooting in no-flash mode.
- When the [LCD CONFIRM] is set to OFF in the setup screen, the still image shot will not be displayed on the LCD monitor.

## Reference

For how to change the image confirmation time, see P.115.

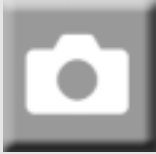

## When the Subject is not Centered (Shooting with Focus-lock)

When your subject is not in the center of your composition, compose your photo after focusing. (Focus-lock)

Example: Taking a photograph of the castle in the background with the camera focused on a person in front.

Shooting range

Subject to be focused on

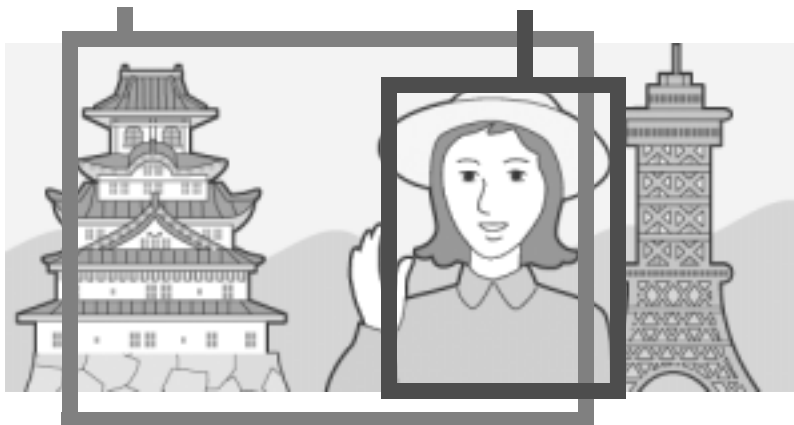

Final still image

- 1. To turn the power on, slide the power switch to open the lens cover.**  
For how to turn the power on, see P.24.
- 2. Switch the Mode Selector to .**
- 3. Put the subject of your photo right in the center of the LCD Monitor or the Viewfinder and press the shutter button half-way.**

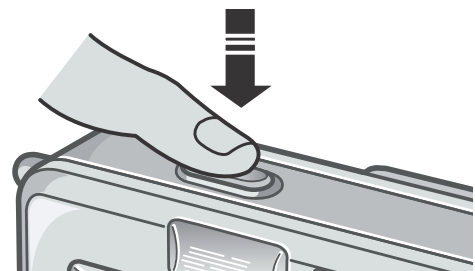

4. With the shutter half-pressed, move the camera and compose your shot.



5. Gently press the shutter button all the way.

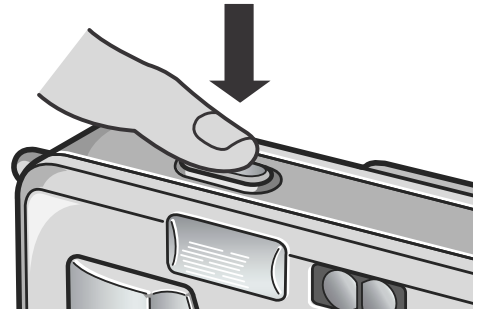

### Note

At macro shooting, the AF target shift function allows you to lock the focus without moving the camera. This function is useful when a tripod is used.



### Reference

- For details about macro shooting, see P.37.
- For details about the AF target shift function, see P.83.



## Using the Zoom Function

If you use the [↶] (Wide angle)/ [↷] (Telephoto) button, you can alter the size of the subject in your photo without having to change your distance from it.

By pressing the [↶] button, the field in the LCD monitor and the viewfinder becomes wider. By pressing the [↷] button, the subject you see in the LCD monitor and the viewfinder becomes larger.

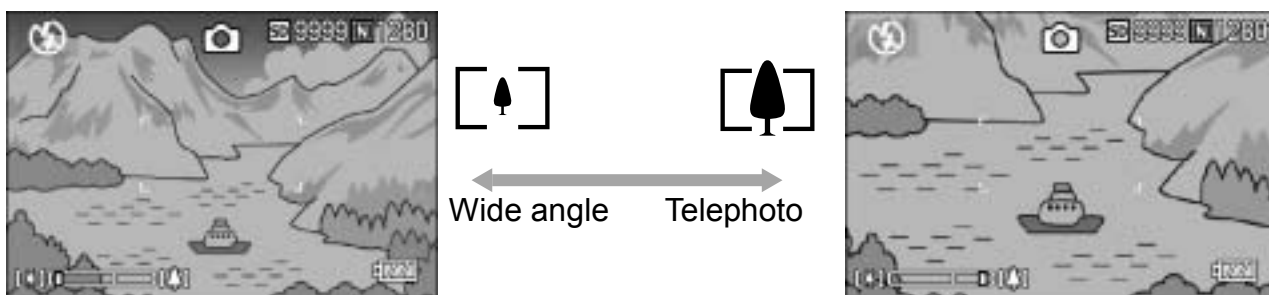

1. **With the camera ready to shoot, press the [↶] button or the [↷] button.**

You can check the Zoom status on the Zoom Bar of the LCD monitor.

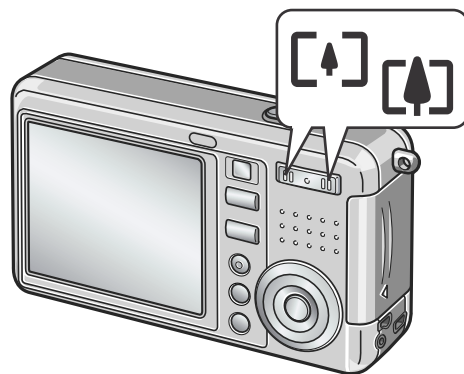

2. **Compose your picture and half-press the shutter release button.**
3. **Press the shutter release button all the way.**



### Note

#### Using the Digital Zoom

Digital zooming enables you to enlarge the subject more than the maximum magnification (x4.8) that can be specified by pressing the [↷] (Telephoto) button (up to x3.6).

For digital zooming, release the [↷] button once when the zoom reaches the limit on the [↷] (Tele) end on the Zoom Bar, and then hold the button down again.



## Shooting Close-Ups (Macro-Mode)

Using the  (Macro) button allows you to take a tight close-up (Macro Photo).

It is good for shooting small subjects because you can get up to one centimeter (1/2 inch) away.



- 1. With the camera ready to shoot, press the  button.**

 is displayed momentarily in a large size at the center of the LCD monitor and then at the upper part.

- 2. Compose your picture and half-press the shutter release button.**

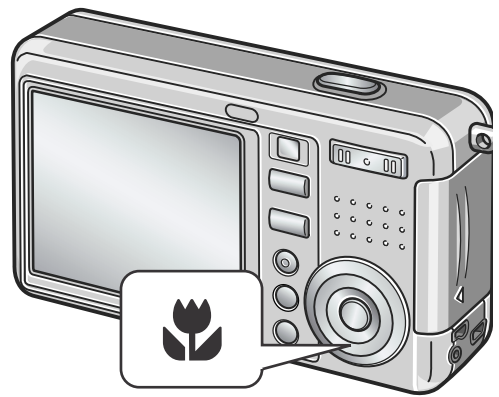

- 3. Press the shutter release button all the way.**

To get out of Macro Mode, press the  button again.



### Note





- When using the zoom, you can shoot close-ups within the following distances from the front of the lens:
  - In Wide-Angle (W): About 1 cm from the front of the lens
  - In Telephoto (T): About 13 cm from the front of the lens
- During Macro Shooting, the Viewfinder cannot be used. Use the LCD Monitor.
- The AF target shift function enables you to lock the focus for macro shooting only by button operation without moving the camera. This function is useful for shooting on a tripod. (P.83)



## Using the Flash

Press the  (Flash) button to switch between flash modes. By default, your camera is set to Flash Off. From the front edge of the lens, flashlight reaches about 0.2 to 2.7 m (W) or about 0.13 to 2.1 m (T) when ISO sensitivity is set to AUTO.

### Flash Modes

	Flash Off	The flash will not fire.
	Auto	When your subject is poorly lit or backlit, the flash fires automatically.
	Red-eye reduction	Reduces the red-eye phenomenon, in which people's eyes appear red when shooting images of people.
	Forced Flash	The flash fires, whatever the light conditions are, when you shoot.
	Slow Synchro	The flash fires with the shutter speed slowed. This is suitable when taking portrait pictures in a nightscape. It is recommended to use a tripod.

**1. Switch the Mode Selector to .**

**2. Press the  (Flash) button to switch between flash modes.**

The Flash mode mark appears momentarily in a large size at the center of the LCD monitor and then is displayed at the upper left.

During flash charging, the flash lamp keeps blinking. Once the flash is charged, the lamp goes off and it is possible to shoot.



### Note







- The settings are saved until you press the  (Flash) button to change them.
- When shooting movies or in Multi-Shot mode, the flash turns off.
- When shooting in a dark place, the camera raises the focusing performance (auto focus precision) by preliminary flashing immediately before shooting. This preliminary flashing is skipped for shooting in no-flash mode.
- If you are using a battery other than a lithium ion type, the LCD Monitor is turned off during flash charging.





## Shooting with Scenery-Matching



If you use the Scene Mode, you can select from among six types of still image modes and shoot automatically with optimal settings for that kind of scene.

	PORTRAIT	Use when taking portrait pictures.
	SPORT	Use when taking pictures of moving objects.
	LANDSCAPE	Use when you are taking scenery pictures with abundant greens or blue sky.
	NIGHTSCAPE	Use when shooting night scenes. You can also shoot with persons in the frame.
	TEXT MODE	Use when capturing text images, for example, notes written on the whiteboard at a meeting.
	HIGH SENSITIVITY	Use when taking pictures in dimly lit places. Also, LCD monitor becomes brighter.

1. Switch the Mode Selector to .
2. Press the  button.

The still image mode selection screen appears.



3. Press the  button to move to the SCENE menu.
4. Press the   buttons to move the orange rectangle to the mode you want to select.



## 5. Press the OK button.

The Mode's symbol is displayed on the upper part of the LCD monitor.



## 6. Press the shutter release button.

If you press the ▲ button, the still image mode selection screen appears and you can change the mode.

To return to ordinary shooting mode, on the still image mode selection screen, press the ▲ button to select [NRML SHT], and then press the OK button.

### Note

In Nightscape Mode, the flash works when all of the following conditions are satisfied:

- The flash is set to Auto.
- Flash is judged to be necessary because it is dark around.
- There is a figure or any other object nearby.

### Reference

- For how to change PIC QUALITY/SIZE, see P.60.
- For how to change to density in TEXT Mode, see P.82.
- For the list of Shooting Setting menu items in Scene Mode, see P.157.
- For combination of Scene Mode and the functions, see P.156.

# Playing Back









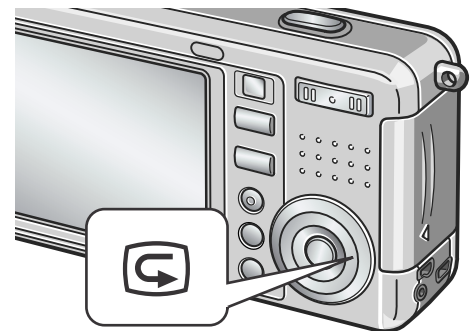



## Checking the image you just took (Quick Review)

You can view the image you just took on the LCD monitor. If you are not pleased with the way the photo came out, you can erase it then and there.

1. **While still in the Still Image Mode, press the  (Quick Review) button.** The last image you took is displayed on the LCD monitor.



In Quick Review	
 Button	Returns to Shooting Mode.
 Button	Enlarges the displayed still image. You can move around on the displayed image by pressing the     buttons.
 Button	Reduces the displayed still image enlarged by pressing the  button.
OK Button	Displays the still image at the maximum available ratio by pressing the  button. When displayed for the maximum size, it returns to a whole display.
 Button	Deletes the currently displayed file. When the  button is pressed, a warning message about deleting the file appears. Select [DELETE] and press the OK button.



### Note

- Once the power is turned off, the image you took cannot be displayed in the still image mode even if you press the  button.
- If you use Quick Review to view the image taken in Text mode (see P.39), the displayed image may have slightly lower quality than the recorded one.



## Viewing Your Images

In the Playback Mode you can check still images you have taken. You can also delete or zoom in on them.

### 1. Press the Playback button.

The camera switches to Playback mode and the last still image you took is displayed.

You can view your pictures in order by using the ◀▶ button.

To switch the camera from playback mode to still image mode (or movie or voice memo mode), press the Playback button again.

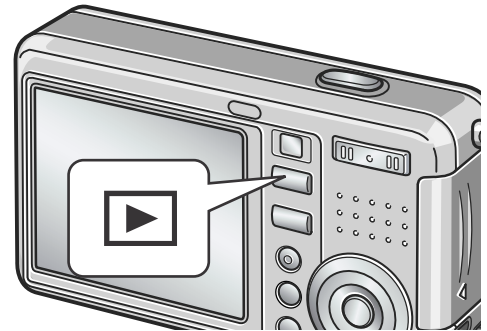

### Note

#### About power-on in playback mode

When you press the Playback button while the camera is turned off (the lens cover is closed), the camera is turned on in playback mode with the lens cover still closed.

In this status, you can playback still images or make settings in the Setup Menu, while shooting is not possible.

#### Where images are played back from

When no SD memory card is inserted, the camera plays back from the internal memory.

When an SD memory card is inserted, it plays back from the SD memory card.



### Reference

- For how to playback movies, see P.91.
- For how to playback sounds, see P.93.
- For how to playback still images with voice memo, see P.74.



## Playing back in the three-frame view

A playback view can be divided into three frames. The three-frame view allows you to select a still image to enlarge or delete it.

### 1. Press the Playback button.

The last image you took is displayed.

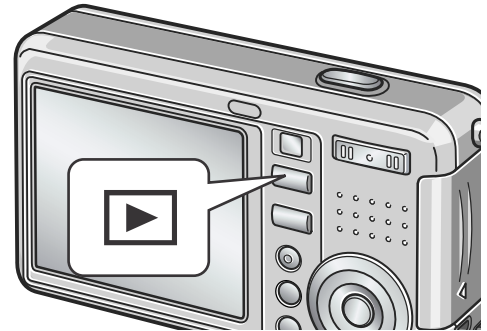

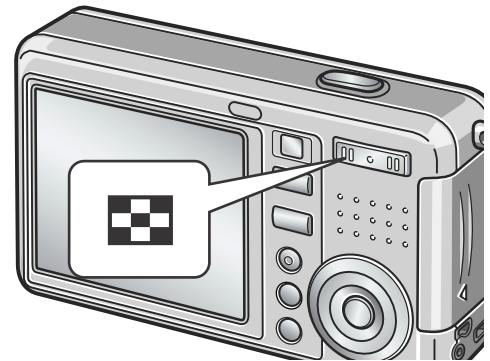

### 2. Press the (Thumbnail Display) button.

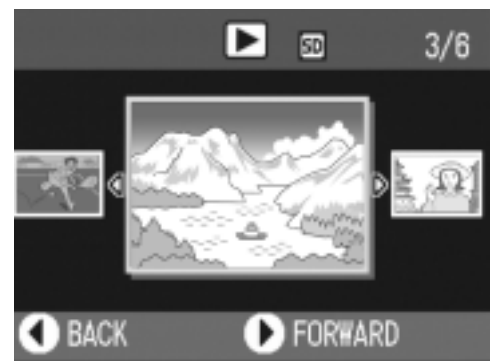

The screen changes to the three-frame view. The large frame at the center displays the still image now selected. A file shot in Text Mode appears surrounded by the blue rectangle.



To switch to single-picture display:

1. Press the   buttons to select a still image.
2. Press the  (Enlarge) button or the OK button.

## About Screen Switching at Playback

The playback screen changes as follows:



### Note

If one of the following operations is performed on the three-frame view, the display returns to the ordinary playback screen (single-picture display) and the operation is executed.

- Deletion (P.49)
- Menu display (P.94)
- Movie playback (P.91)
- Sound playback (P.93)

### Reference

For how to erase unwanted Images, see P.49.



## Thumbnail Display

You can view your images in sets of 12.  
You can then select an image to erase or magnify.

### 1. Press the Playback button.

The last image you took is displayed.

### 2. Press the (Thumbnail Display) button.

The screen changes to three-frame view.

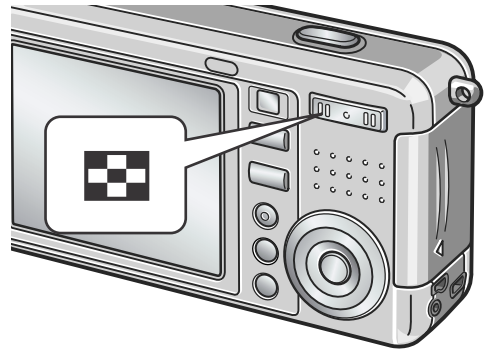

### 3. Press the (Thumbnail Display) button.

The screen is divided into 12 frames and displays 12 still images at once.

Selected still image

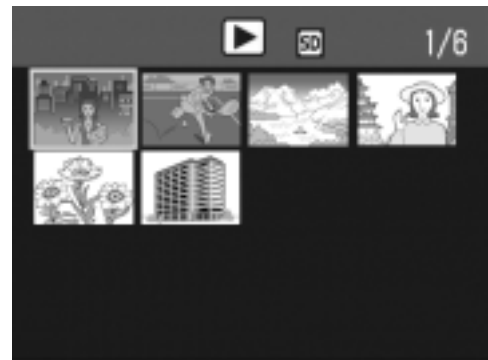

## To display just one photo

1. Use the     buttons to select an image.
2. Press the  (Enlarge) button twice, or press the OK button.



## Reference

- For how to erase the selected image, see P.49.
- For how to switch to the three-frame view, see P.43.



## Magnifying Images

You can enlarge a still image displayed on the LCD Monitor.

An image can be enlarged up to 8 times when its size is 2560x1920 or 2048x1356, up to 6.7 times when its size is 1280x960, and up to 3.4 times when its size is 640x480.

### 1. Press the Playback button.

The last image you took is displayed.

### 2. Press the ◀▶ buttons to display the still image you want to enlarge.

### 3. Press the 🔍 (Enlarged View) button.

The still image is enlarged.

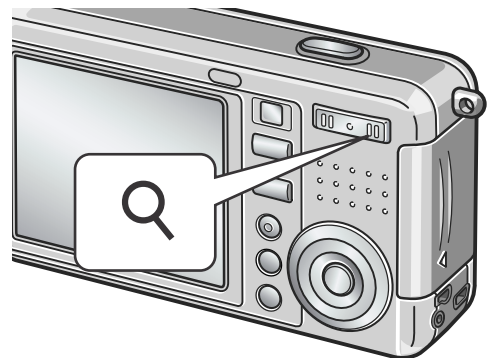

#### In Enlarged View

🔍 Button	Enlarges the displayed still image. You can move around on the displayed image by pressing the ▲▼◀▶ buttons.
🔍 Button	Reduces the displayed still image enlarged by pressing the 🔍 button.
OK Button	Displays the still image at the maximum available ratio or returns it to its original size.



# Viewing on a Television

You can view still images you have taken on a TV screen. The camera displays everything on the TV screen just as it would on the LCD Monitor.

To use your television for viewing, connect your camera to the television with the AV cable that came with your camera.

To view still images on a television, follow the steps below.

**1. Securely connect the AV cable to the Video In terminal on the television.**

Connect the white plug of the AV cable to the audio input terminal (white) of the TV unit and the yellow plug to the video input terminal (yellow).

Video input terminal (yellow)

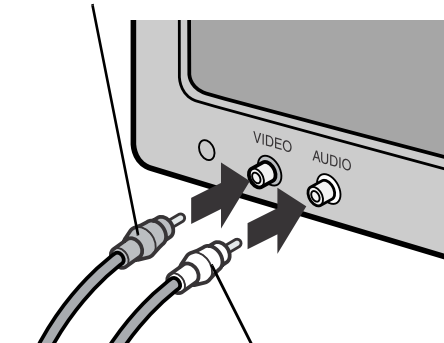

Audio input terminal (white)

**2. Make sure the camera power is off.**

**3. Securely connect the AV cable to the Video Out terminal.**

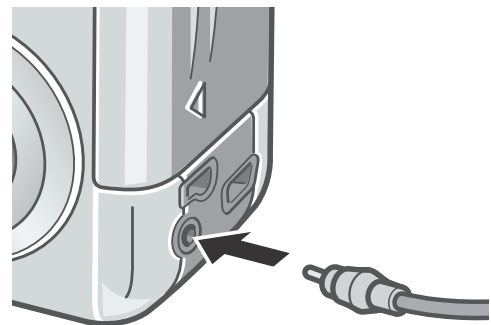

**4. Set the television to "Video" mode. (Set the input to "Video".)**

For details, see the documentation that came with the television.

**5. To turn the power on, slide the power switch to open the lens cover or press the Playback button.**

Connecting the AV cable to the camera turns off the LCD monitor display and the speaker output.

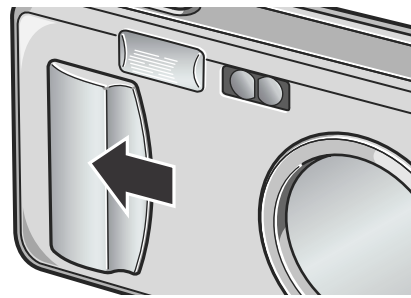

### **Note**

- If you connect the AV cable to your video recorder's In terminal, you can record what you have shot onto video.
- Your camera is set to NTSC playback format (used in Japan and other countries) for use with television equipment, etc. If the equipment you want to connect to uses PAL format (used in Europe and else-where), then switch your camera to PAL format in the Setup Menu before connecting.



### **Reference**

For how to change the video out mode, see P.119.

# Erasing



## Erasing Unwanted Images

You can erase unwanted images from the internal memory or SD Memory Card.

You can erase them in the following three ways:

- One file at a time
- Deleting all frames at once
- Select multiple frames and erase together

1. Press the **Playback** button.
2. To erase images one at a time, press the ◀▶ buttons to display the image you want to erase.
3. Press the 🗑️ (Delete) button.
4. Press the ▲▼ buttons to select **[DELETE ONE]** or **[DELETE ALL]**.  
If you selected **[DELETE ONE]**, you can also change the image for deletion with the ◀▶ buttons.
5. Press the **OK** button.

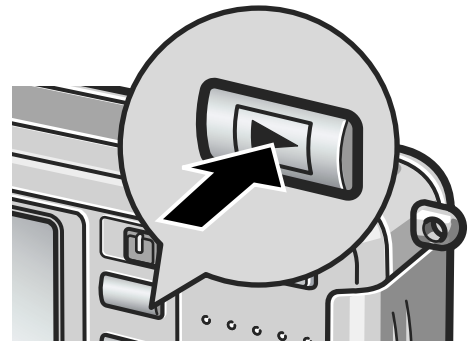

### If you selected **[DELETE ONE]**:

The display indicates deletion is in progress; once finished, it returns to the screen in step 4.

### If you selected **[DELETE ALL]**:

You will be prompted to confirm that you want to erase; if so, press the ▶ button to select **[Yes]**, and then press the **OK** button.



### Note

In the three-frame view (see P.43), you can display a still image at the center and press the 🗑️ (Delete) button to delete it.





## Erasing Multiple Frames at One Time

1. Press the Playback button.
2. Press the  (Thumbnail) button twice.

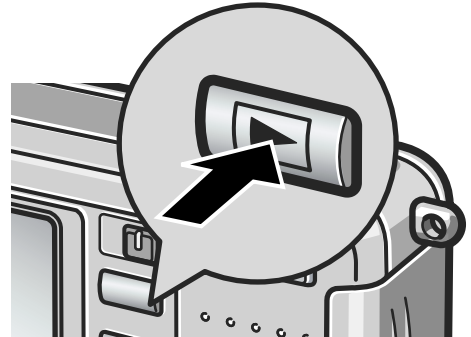
The screen is divided into 12 frames and displays 12 still images at once.





3. Press the     buttons to select the image you want to erase and press the  (Delete) button.

The trash symbol is displayed in the upper left corner of the image.



4. Repeat Step 3. to select all the still images you wish to erase.

If you selected an image by mistake, you can deselect it by selecting the image and pressing the  (Delete) button again.

5. Press the OK button.
6. Press the  button to select [YES] and then press the OK button.

The display indicates deletion is in progress; once finished, the Thumbnail Display screen returns.

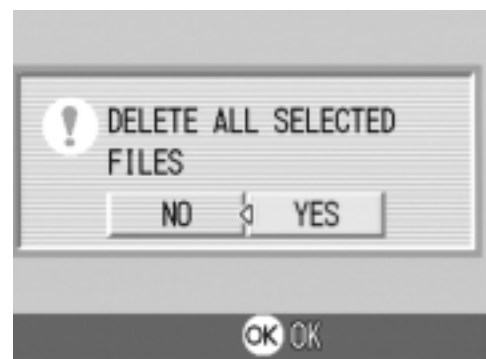

# Chapter 2

## A Variety of Shooting Techniques/Playback

Direct Printing .....	52
A Variety of Shooting Techniques .....	57
Shooting with Multi-Shot .....	85
Shooting/Playing Back Movies.....	89
Recording/Playing Back Sound .....	92
Other Functions Available in Playback Mode.....	94

# Direct Printing

## Direct Print Function

---

The Direct Print standard enables direct printing from a camera to a printer, by connecting them via a USB cable. Photos can be printed quickly and easily from your digital camera without using a computer.



### Caution

- You cannot print movies (.AVI) with this function. For still images with sounds (.JPG and .WAV), only the still images (.JPG) are printed.
- Some printer does not support images taken in Text mode (TIFF). Even when TIFF images are printed, their printed contents cannot be guaranteed.



### Note

- This camera uses PictBridge, an industry standard for Direct Printing.
- Your printer must comply with the PictBridge to use the Direct Print function. For support information, see the documentation that came with the printer.
- For direct printing on a printer supporting both Direct Print and PictBridge, select [Original] for [USB Connection].

## Connecting the Camera to a Printer

---

Connect your camera to a printer using the USB cable provided.

- 1. Make sure the camera power is off.**
- 2. Make sure the printer power is off.**  
Load paper into the printer and check that the printer is ready to print.
- 3. Connect one end of the USB cable provided to the USB port of your printer.**
- 4. Connect the other end of the USB cable to the USB terminal on your camera.**
- 5. Turn the printer power on.**

## Note

To disconnect the camera from the printer, check that the power is off on both units before disconnecting the USB cable between them.

## Printing Still Images

You can send still images from the camera to a PictBridge compatible printer to print them.

Still images are sent from the internal memory when no SD memory card is loaded or from an SD memory card when one is loaded.

## Caution

Do not disconnect the USB cable during printing.

## Note

If a printer error message appears during transmission, check the condition of the printer, and take the appropriate action.

## Printing One or All Still Images

### 1. Check that the printer is ready for printing.

The "Connecting" screen appears.

### 2. Press the ADJ. button.

When the connection between the printer and the camera is established, the Direct Print playback mode screen appears.

### 3. Press the ◀▶ buttons to select an image for printing.

### 4. Press the ADJ. button.

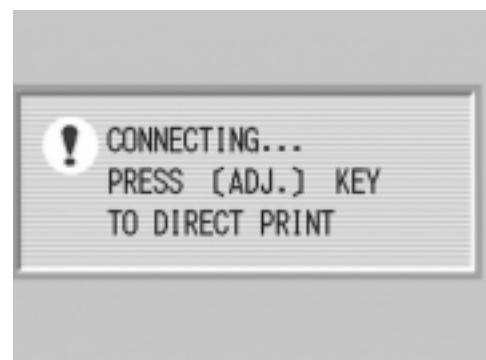

5. Press the ▲▼ button to select [1 FILE] or [ALL FILES].

6. Press the OK button.

The Direct Print menu appears.



7. Press the ▲▼ buttons to select an item, and then press the ► button to display the detailed options screen.

If there are no options available for an item, the detailed options screen does not appear even if you press the ► button. Also, items that are not available on the printer do not appear.

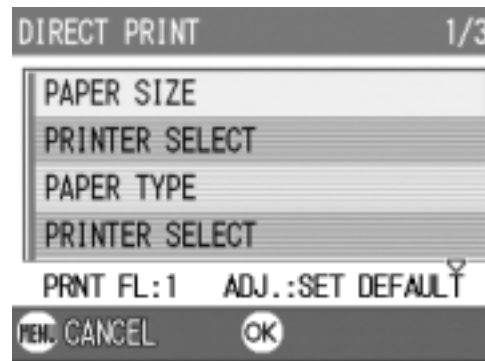

The following items can be selected. Each item is displayed only when supported by the printer.

Item Name	Function
PAPER SIZE	Sets the paper size.
PAPER TYPE	Sets the paper type.
LAYOUT	Sets the number of images printed on a sheet of paper.
DATE PRINT	Selects whether to print the date (shooting date). The date format can be set using the date/time option in the <b>SETUP</b> Mode.
FILE NAME PRINT	Selects whether to print the file name.
OPTIMIZE IMAGE	Selects whether to optimize the image data (still image) prior to printing on the printer.
FIXED-SIZE PRINT	Setting the print image size.
PRINT QUALITY	Setting the print quality.
FORMS PRINT	Printing forms.

8. Press the ▲▼ buttons to select the detailed item, and then press the OK button.

The display returns to the Direct Print menu.

9. Repeat steps 7 and 8 to change the settings as required.



## Note

To specify the set value as the default selected at the next connection, click the ADJ. button on the screen of Step 7. Upon appearance of the screen at right, select [Set] and press the OK button. Select [Cancel] to return to the default setting.

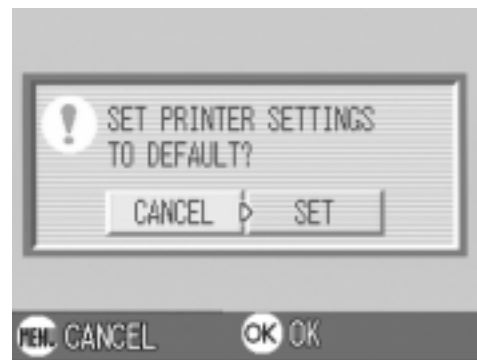

## 10. Press the OK button.

The selected still images are sent to the printer and the "Connecting" screen appears.

Press the MENU button to cancel the operation.

At the end of transmission, the display returns to the Direct Print playback mode screen and printing starts.

## Printing Several Still Images

### 1. Check that the printer is ready for printing.

The "Connecting" screen appears.

### 2. Press the ADJ. button.

When the connection between the printer and the camera is established, the Direct Print playback mode screen appears.

### 3. Press the (Thumbnail) button twice.

The screen is divided into 12 frames and displays 12 still images at once.

### 4. Press the buttons to select an image for printing.

### 5. Press the OK button.

### 6. Press the buttons to set the number of copies to print.

Press the  button to increase the number, or the  button to decrease it.

### 7. Press the buttons to select an image for printing.

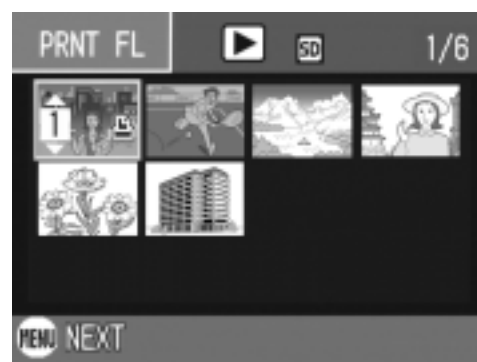
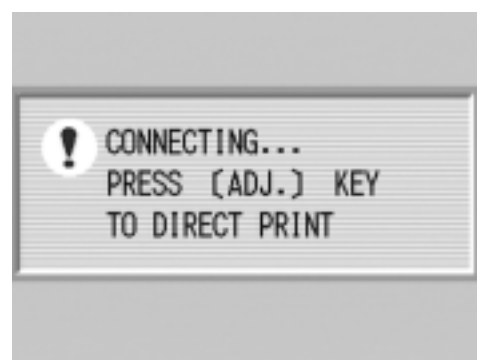

8. Press the ▲▼ buttons to set the number of copies to print.
9. Repeat steps 7 and 8 to select all the still images to be printed and the number of copies for each.

### 10. Press the MENU button.

The Direct Print menu appears.

### 11. Press the ▲▼ buttons to select an item, and then press the ► button to display the detailed options screen.

If there are no options available for an item, the detailed options screen does not appear even if you press the ► button.

Also, items that are not available on the printer do not appear.

For settings available, see P.54.

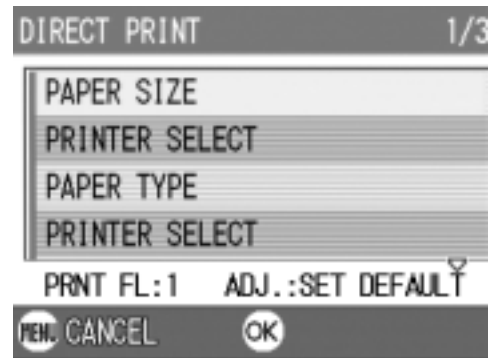

### 12. Press the ▲▼ buttons to select the detailed item, and then press the OK button.

The display returns to the Direct Print menu.

### 13. Repeat steps 11 and 12 to change the settings as required.

### 14. Press the OK button.

The selected still images are sent to the printer and the "Connecting" screen appears.

Press the MENU button to cancel the operation.

When all the selected still images have been sent from the camera to the printer, the camera display returns to the Direct Print playback mode screen.



#### Note

- Only images with a printer mark (  ) are printed. When you cancel printing and then try to print again, make sure that the printer mark is on the images you want to print.
- The same still image can also be printed several times on a single sheet.
- The items available vary depending on the functions of the printer.
- To print images using the printer's default settings, select Printer Setting on the detailed options screen.

# A Variety of Shooting Techniques

## Using the ADJ. (Adjust) Button

The ADJ button allows exposure correction, white balancing, and ISO sensitivity setting by fewer operations. You can also register a function other than these adjustment functions to the ADJ button. If a frequently used function is registered, they can be set easily by fewer button operations.

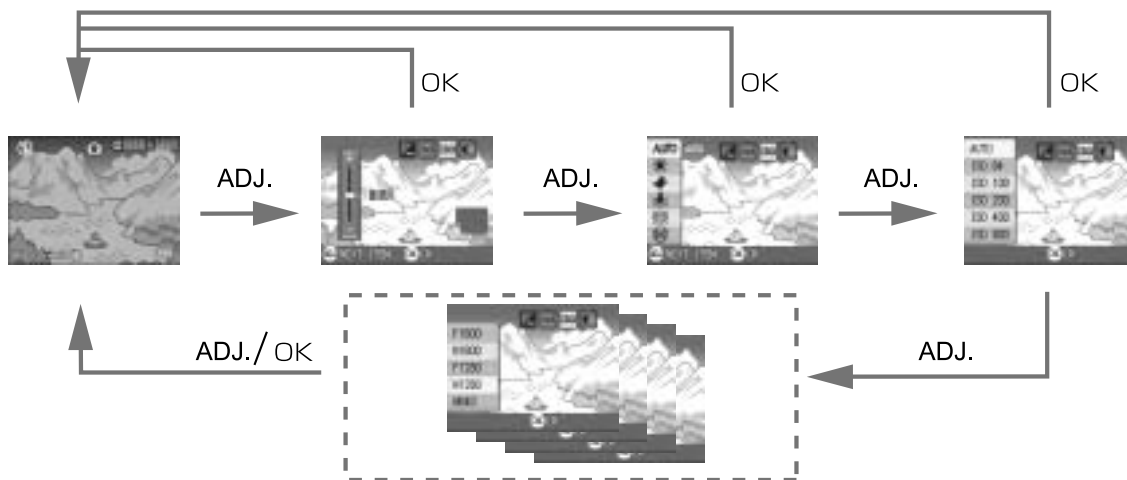

Use the SETUP menu to register a function to the ADJ button (P.111).

## Adjustments Using the ADJ. Button

Adjustments that can be made with the ADJ. button differ between SCENE mode and Movie mode.

Still Image Mode	Exposure control, white balance, ISO sensitivity
Movie Mode	White Balance
Scene Mode (Text Mode)	Density
Scene Mode (other than Text Mode)	Exposure control, white balance



### Reference

- Exposure Comp, see P.76.
- White Balance, see P.77.
- ISO Setting, see P.79.
- Text Density, see P.82.
- For how to set a function to the ADJ. button, see P.111.

# Shooting Setting Menu

The Shooting Setting menu enables you to shoot pictures by setting the items listed in the table below.



\*Among the choices listed in the table below, default values at purchase are enclosed in [ ].

Setting	Option	Refer to
PIC QUALITY/SIZE	F2560, N2560, F2048, N2048, F1280, [N1280], N640	P.60
FOCUS	[AF], MF, SNAP, ∞	P.62
PHOTOMETRY	[MULTI], CENTER, SPOT	P.65
SHARPNESS	SHARP, [NORMAL], SOFT	P.66
CONT. MODE	[OFF], CONT, SCONT, MCONT	P.85
COLOR DEPTH	VIVID, [NORMAL], NEUTRAL, B&W	P.67
AUTO BRACKET	[OFF], ON, WB-BKT	P.68
TIME EXPOSURE	[OFF], 1, 2, 4, 8 seconds	P.71
INTERVAL	[0 s], 5 seconds to 3 hours	P.72
IMAGE WITH SOUND	[OFF], ON	P.74
DATE IMPRINT	[OFF], DATE, TIME	P.75
EXPOSURE COMP.	-2.0 to +2.0	P.76
WHITE BALANCE	[AUTO],  (Daylight),  (Overcast),  (Tungsten light),  (Tungsten light 2),  (Fluorescent light),  (One Push)	P.77
ISO SETTING	[AUTO], ISO64, ISO100, ISO200, ISO400, ISO800	P.79
SLOW SHUTTER LMT	[OFF], ON	P.80
RESTORE DEFAULTS	_____	P.81

## Note

The SETUP menu can be accessed from within the Shooting Setting menu. For details, see P.106.

## Reference

For the list of Shooting Setting menu items in Movie and Scene Modes, see P.157.

# Using the Shooting Setting Menu

**1. With the camera ready to shoot, press the MENU button.**  
The Shooting Setting menu appears.

**2. Press the ▲▼ buttons to select the desired item.**

The setting items are provided on 4 screens.

When the ▼ button is pressed at the bottom item, the next screen appears.

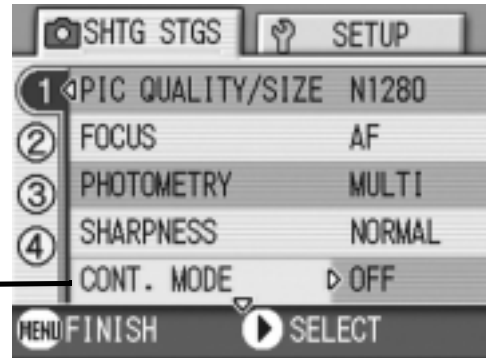

**To select a screen by screen number:**

1. Press the ◀ button to select a screen number on the left of the screen.
2. With the screen number selectable, press the ▲▼ buttons to switch between screens.
3. After selecting the screen, press the ▶ button to return to the setting item selection step.

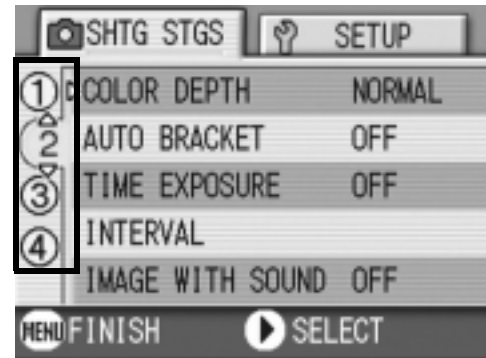

**3. After selecting a setting item, press the OK or ▶ button.**  
Choices for the setting item are displayed.

**4. Press the ▲▼ buttons to select a choice.**

**5. Press the OK or ◀ button.**



**6. If you pressed the ◀ button in step 5, press also the MENU button.**

The Shooting Setting menu disappears and the camera becomes ready for shooting.

# Choosing Picture Quality Mode/Image Size (PIC QUALITY/SIZE)

The size of a stored still image and movie file depends on picture quality and size settings.

In Picture Quality Mode, there are two types, N (Normal) and F (Fine).

Types of Modes You Can Select		
Symbol	Mode	Description
	Normal Mode	The compression ratio is high, resulting in a small file. Normally, shooting is done in this mode.
	Fine Mode	The compression ratio is low, resulting in a large file, but the picture quality is better than in Normal Mode.

## Combining Picture Quality Mode and Image Size.

		Size			
		2560 X 1920	2048 X 1536	1280 X 960	640 X 480
Mode	F (Fine)	<b>F2560</b>	<b>F2048</b>	<b>F1280</b>	-
	N (Normal)	<b>N2560</b>	<b>N2048</b>	<b>N1280</b>	<b>N640</b>
Uses		Suitable for downloading images to your computer and correcting the images or printing them in large sizes.	Suitable for printing images in large sizes.	Suitable for shooting many pictures.	Capable of recording the greatest number of pictures on a single SD memory card. Suitable for attaching images to e-mail messages or using them on Web pages.

Figures inside the bold frame indicate those shown on the screen.

In Movie Mode, 320 X 240 or 160 X 120 can be selected.



## Reference

For internal memory/SD memory card recording capacities, see P.159.

1. Switch the Mode Selector to .

2. Press the MENU button.

The Shooting Setting menu appears.

3. Press the  button to select [PIC QUALITY/SIZE] and press the OK or  button.

4. Press the   buttons to select a picture quality/size.

5. Press the OK or  button.

Picture Quality/Image Size settings are completed.

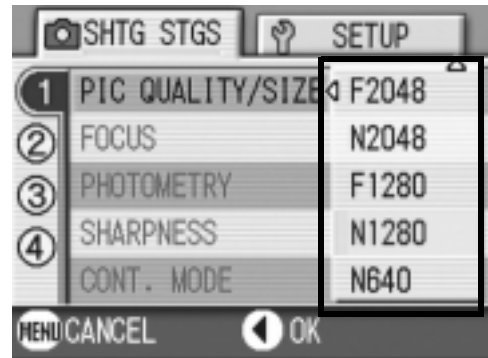

Still Image Mode

6. If you pressed the  button in step 5, press also the MENU button.

The shooting setting menu disappears and the LCD monitor displays the set values.

This setting will be used for shooting until you change it.

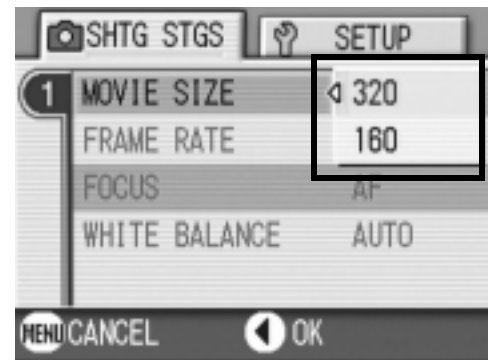

Movie Mode

# Manual Focus Shooting (FOCUS)

When Auto-Focus does not focus as desired, you can focus manually (Manual Focus).

Manual focusing allows shooting at a fixed distance. When using a fixed shooting distance, it can be set to either Snapshot or Infinity ( $\infty$ ).



## Note

- Manual focus cannot be used in Scene Mode.
- Manual focusing can focus the camera also on an object that requires macro shooting.
- In manual focus, the Macro Mode cannot be used.

## Setting Manual Focusing

1. Switch the Mode Selector to

2. Press the MENU button.

The Shooting Setting menu appears.

3. Press the button to select [FOCUS] and press the OK or button.

4. Press the buttons to select [MF].

5. Press the OK or button.

Focus settings are complete.

6. If you pressed the button in step 5, press also the MENU button.

The Menu closes and "MF" is displayed on the screen.

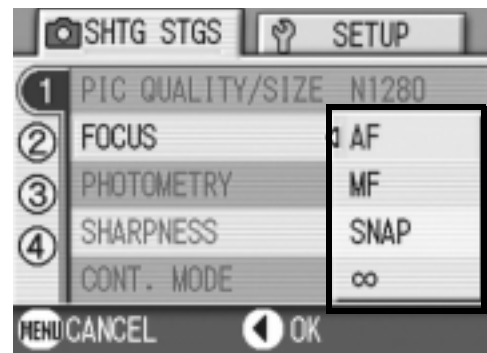



## Shooting with Manual Focusing

### 1. Press the ▼ button as required.

Pressing the ▼ button enlarges the display for easy focusing.

### 2. Press the OK button to set the focus bar/zoom bar display to the focus bar.

Each time the OK button is pressed, the focus bar and the zoom bar appear alternately.



### 3. Press the [▲] and [▼] buttons for focusing.

Pressing [▲] button moves the focus away from you.

Pressing the [▼] button brings the focus closer to you.

Until the setting is changed the next time, pictures are shot by manual focusing.

### 4. Press the shutter button for shooting.



#### Note

- When the zoom bar is displayed, you can operate the zoom bar with the [▲][▼] buttons.
- At interval shooting, the OK button cannot be used to operate zooming or switch to manual focusing.

## Shooting at a Fixed Distance

The shooting distance can be set to short distance or infinity. Infinity is useful to shoot a distant view.

To shoot with the shooting distance fixed, follow the steps below.

1. **Switch the Mode Selector to .**
2. **Press the MENU button.**  
The Shooting Setting menu appears.
3. **Press the ▼ button to select [FOCUS] and press the OK or ► button.**

4. **Press the ▲▼ buttons to select [SNAP] or [∞] (Infinity).**

Selecting [SNAP] will fix the shooting distance to 2.5 meters.

Selecting [∞] will fix the shooting distance to infinity.

5. **Press the OK or ◀ button.**

Focus settings are complete.

6. **If you pressed the ◀ button in step 5, press also the MENU button.**

The Shooting Setting menu closes and the setting value appears on the screen.

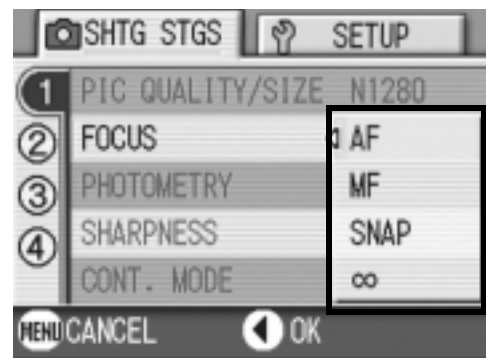

This setting will be used for shooting until you change it.



# Changing the Light Metering (PHOTOMETRY)

You can change the metering method (the range to use for metering) to determine the exposure value.

There are three Light Metering Methods available: MULTI, CENTER, and SPOT.

Types of Modes You Can Select		
Symbol	Mode	Description
(No Symbol)	MULTI	The entire shooting range is divided into 256 partitions, and subjected to photometry for overall decision.
	CENTER	The light metering is determined by a measurement of the whole, with the central part emphasized. Use this when the brightness of the center and surroundings are different.
	SPOT	Light metering is determined by measuring only the central part. Use this setting when you want to use the brightness of the center. It is useful if there is marked difference in contrast or backlighting.

1. Switch the Mode Selector to .

2. Press the MENU button.

The Shooting Setting menu appears.

3. Press the ▼ button to select [PHOTOMETRY] and press the OK or ► button.

4. Press the ▲▼ buttons to select the desired setting.

5. Press the OK or ◀ button.

Light Metering Method setting is complete.

6. If you pressed the ◀ button in step 5, press also the MENU button.

The shooting setting menu disappears and the LCD monitor displays the set values.

This setting will be used for shooting until you change it.

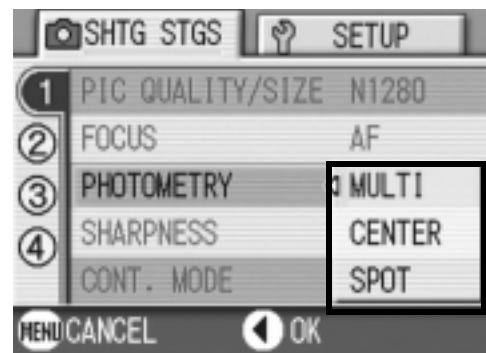

# Changing the Edge Quality of Still Images (SHARPNESS)

You can change the definition of your still images to either sharp or soft.

1. Switch the Mode Selector to .

2. Press the MENU button.

The Shooting Setting menu appears.

3. Press the  button to select [SHARPNESS] and press the OK or  button.

4. Press the   buttons to select the desired setting.

5. Press the OK or  button.

Sharpness settings are complete.

6. If you pressed the  button in step 5, press also the MENU button.



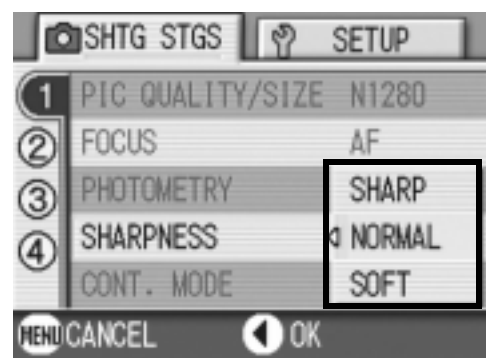

The shooting setting menu disappears and the LCD monitor displays the set values.

This setting will be used for shooting until you change it.



# Setting Color Depth (COLOR DEPTH)

Color depth of the shot still image can be selected from Normal, Natural, Neutral, and B&W.

1. Switch the Mode Selector to .
2. Press the MENU button.  
The environment setting menu is displayed.
3. Press the  button to select [COLOR DEPTH]. Then press the OK or  button.
4. Press the  buttons to select the color depth.
5. Press the OK or  button.  
This completes the color depth setting.

6. If the  button was pressed in Step 5, press the MENU button.  
The shooting setting menu disappears. If other than [Normal] is set, the LCD monitor displays the set values.  
The set values are used for shooting until they are changed the next time. The LCD monitor also reflects the values.

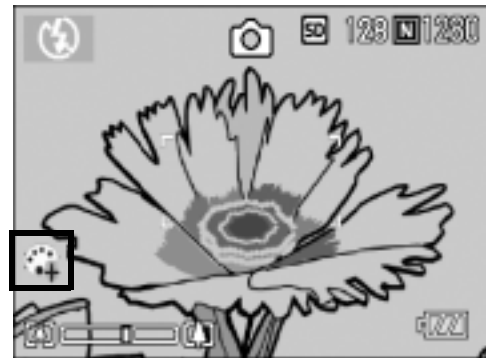
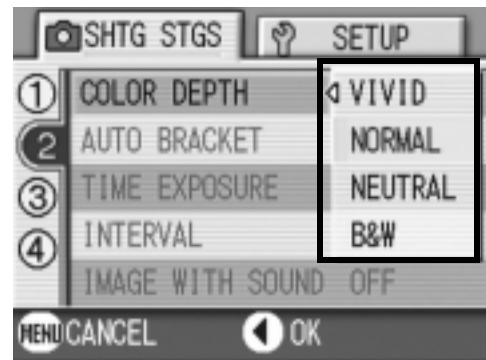



# Shooting Consecutively with Different Exposures (AUTO BRACKET)

The Auto Bracketing function automatically shoots three consecutive shots, with the specified exposure value as standard, at three exposure levels, at -0.5EV,  $\pm 0$ , and +0.5EV.



## Note

This function is not available when shooting with sound.

1. **Switch the Mode Selector to .**
2. **Press the MENU button.**  
The Shooting Setting menu appears.
3. **Press the  button to select [AUTO BRACKET] and press the OK or  button.**

4. **Select [ON] and then press the OK or  button.**

5. **If you pressed the  button in step 4, press also the MENU button.**

The shooting setting menu disappears and the LCD monitor displays [AB].

6. **Press the shutter release button.**

Three consecutive shots are taken, with the specified Exposure Compensation value as the standard, at -0.5EV,  $\pm 0$ , and +0.5EV.

After shooting, three still images are displayed on the LCD Monitor. They are, from the left, at -0.5EV (darker), standard compensation, and +0.5EV (brighter).

This setting will be used for shooting until you change it or you turn the power off.

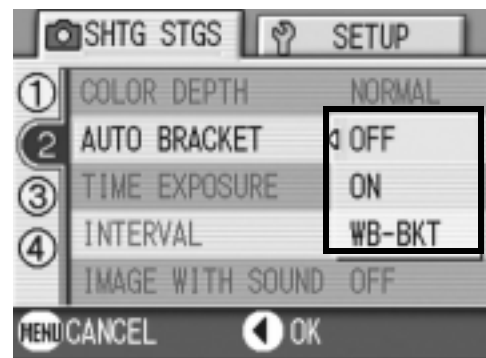

## Reference

- For how to change the Exposure Compensation, see P.76.
- For how to change the White Balance, see P.77.

# Shooting Consecutively with Different White Balance (WHITE BALANCE BRACKET)

Three images are automatically recorded - a reddish image, a bluish image, and an image of the current white balance.

This is useful if the appropriate white balance cannot be judged.

1. Switch the Mode Selector to .

2. Press the MENU button.

The Shooting Setting menu appears.

3. Press the ▼ button to select [AUTO BRACKET] and press the OK or ► button.

4. Press the ▲▼ buttons to select [WB-BKT].

5. Press the OK or ◀ button.

White Balance Bracket settings are complete.

6. If you pressed the ◀ button in step 5, press also the MENU button.

The Shooting Setting menu disappears and the screen displays [WB-BKT].

7. Press the shutter release button.

Three images (reddish, bluish, and equal to the current white balance) are automatically recorded.

This setting will be used for shooting until you change it or you turn the power off.

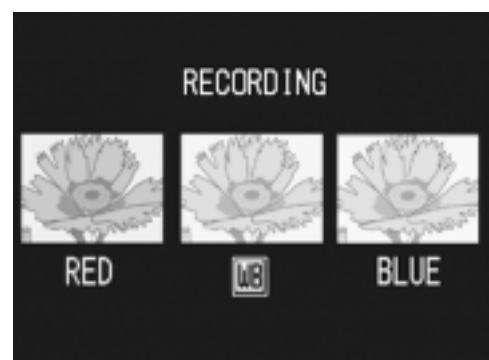
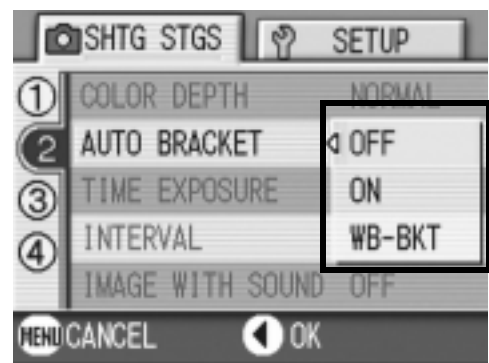



## Note

- This function is not available for Multi-Shot shooting (P.85) and Auto Bracket shooting (P.68).
- The flash cannot be used.
- Time Exposure (P.71) is set to OFF.
- If [B&W] is set for [COLOR DEPTH], the white balance bracket can be set but does not become valid.



## Reference

For how to change the White Balance, see P.77.



# Using Long Time Exposure (TIME EXPOSURE)

You can select an exposure time of 1, 2, 4 or 8 seconds. By using long time exposure, you can capture the track of moving subjects such as fireworks and car lights, when you shoot a night scene.

1. **Switch the Mode Selector to .**

2. **Press the MENU button.**

The Shooting Setting menu appears.

3. **Press the ▼ button to select [TIME EXPOSURE] and press the OK or ► button.**

4. **Press the ▲▼ buttons to select the exposure time.**

5. **Press the OK or ◀ button.**

This completes the setting of time exposure.

6. **If you pressed the ◀ button in step 5, press also the MENU button.**

The shooting setting menu disappears and the LCD monitor displays the set values.

This setting will be used for shooting until you change it.



## Note

- When using long time exposure, the shutter speed may go down and images may be blurred. Hold the camera securely by both hands or use a tripod for shooting.
- While shooting with long time exposure, the LCD Monitor display turns off.

# Shooting Pictures Automatically at Set Intervals (INTERVAL)

You can set the camera to automatically take pictures at fixed intervals.

You can set the shooting interval at any length from 5 seconds to 3 hours, in increments of 5 seconds.

1. Switch the Mode Selector to .



2. Press the MENU button.



The Shooting Setting menu appears.

3. Press the  button to select [INTERVAL] and press the OK or  button.



4. Press the   buttons to specify the length of time.

5. Press the  button to move to the minutes setting, then use the   buttons to set the minutes.

6. Press the  button to move to the seconds setting, then use the   buttons to set the seconds.

7. Press the OK button.

Interval shooting is set and the LCD monitor displays "Interval".

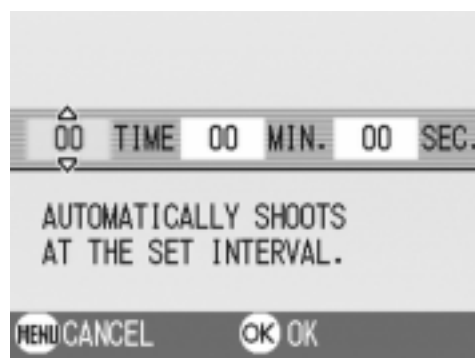

## 8. Press the shutter release button.

A picture is taken every time the fixed interval elapses.

## 9. To stop shooting, press the OK button.

Interval Shooting settings are cleared when the power is turned off.



### Caution

If the time until the next shooting is set longer on the shooting menu than the time for interval shooting, the shooting interval becomes longer than that for interval shooting.



### Note

- In step 5, press and hold either the ▲ or ▼ button to quickly raise or lower the setting value for minute.
- If you use batteries for power, you may exhaust the batteries. Using the AC Adapter (sold separately) is recommended.
- Even during Interval Shooting, if you press the shutter button, the camera will shoot as usual. However, Interval Shooting Mode is unaffected. After shooting, once the time specified in Interval Shooting elapses, the next shot is taken.
- When Interval Shooting is on, even when Multi-Shot is set to [CONT] or [MCONT], consecutive shooting is automatically switched off.

## Shooting a Still Image with Sound (IMAGE WITH SOUND)

You can shoot a still image with a voice memo. Voice recording can continue for up to eight seconds.

1. Switch the Mode Selector to .

2. Press the MENU button.

The Shooting Setting menu appears.

3. Press the  button to select [IMAGE WITH SOUND] and then press the OK or  button.

4. Press the   buttons to select [ON].

5. Press the OK or  button.

6. If you pressed the  button in step 5, press also the MENU button.

The Shooting Setting menu disappears.

7. Press the shutter release button for shooting.



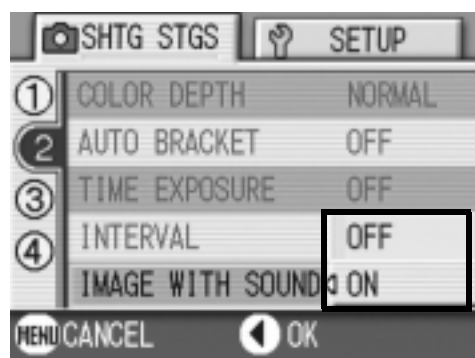

After shooting, the voice mark appears on the screen to indicate the recording status.

8. Press the shutter release button to stop recording.



### Note

When playing back a still image with sound, display the image in the same way as an ordinary image without voice. Pressing the OK button plays back the sound.

Press the   buttons to display the volume adjustment bar, where you can adjust the volume with the   buttons.

### Reference

For how to display still images, see P.42.

# Inserting the Date into a Still Image (DATE IMPRINT)

You can insert the date (YY/MM/DD) or the date and time (YY/MM/DD hh:mm) at the lower right of a still image.

1. Switch the Mode Selector to .

2. Press the MENU button.

The Shooting Setting menu appears.

3. Press the  button to select [DATE IMPRINT] and then press the OK or  button.

4. Press the   buttons to select the desired setting.

5. Press the OK or  button.

The Date Imprint settings are completed.

6. If you pressed the  button in step 5, press also the MENU button.

The shooting setting menu disappears

and the LCD monitor displays .

This setting will be used for shooting until you change it.



## Note

- If the date and time have not been set, DATE IMPRINT cannot be used. First make the date and time settings (P.117).
- DATE IMPRINT cannot be used with movies.
- A thumbnail image is not displayed with a date.

# Changing the Exposure (EXPOSURE COMP.)

The exposure setting allows you to select brightness levels for your shots. Normally, if your subject is centered, backlight compensation is automatically activated, and you can shoot with correct exposure. However, in the following cases, or when you intentionally want to change the exposure, you can change the exposure setting. Exposure can be specified in the range from -2.0 to +2.0. Setting the level higher (+) makes pictures brighter and lower (-) makes pictures darker.

## For Backlighting

When the background is particularly bright, the subject will be dark (underexposure). In this case, set the exposure level higher (+).

## When your subject is whitish

It will turn out entirely dark (underexposure). Set the exposure level higher (+).

## When your subject is darkish

It will turn out entirely bright (overexposure). Set the exposure level lower (-). The same happens when you take photos of people in a spotlight.

To change the setting, use either the Shooting Setting menu or the ADJ. button. This section explains easy ways with the ADJ. button. When using the Shooting Setting menu, see "Using the Shooting Setting Menu" ( P.59).

### 1. Switch the Mode Selector to .

### 2. Press the ADJ. button.

The Exposure Compensation bar appears.

### 3. Press the buttons and specify a value.

### 4. Press the OK button.

The setting of exposure compensation is completed and the LCD monitor displays the set values.









## Note





When shooting in particularly bright places, you may fail in preventing overexposure. In that case, the [!AE] symbol will be displayed.

# Using Natural and Artificial Lighting (WHITE BALANCE)

Adjust the white balance so that a white subject may be reproduced as white. At purchase, the White Balance is set to "AUTO"; normally you do not need to change the setting, but if the camera is having difficulty determining the white balance when shooting an object of a single color or under several light sources, you can change the setting.

Types of Modes You Can Select		
Symbol	Mode	Description
AUTO	Auto	Make adjustments automatically.
	Daylight	Select when shooting outdoors (Sunny) and White Balance fails to adjust properly.
	Overcast	Select when shooting in cloudy weather or shade and the White Balance fails to adjust properly.
	Tungsten light	Select when shooting under tungsten light and White Balance fails to adjust properly.
	Tungsten light 2	Shooting under tungsten light (slightly reddish, compared with Tungsten light Mode)
	Fluorescent light	Select when shooting under fluorescent light and White Balance fails to adjust properly.
	One-push	Manually set White Balance.

To change the setting, use either the Shooting Setting menu or the ADJ. button. This section explains easy ways with the ADJ. button. When using the Shooting Setting menu, see "Using the Shooting Setting Menu" ( P.59).

- 1. Switch the Mode Selector to .**
- 2. Press the ADJ. Button three times.**  
The White Balance menu appears.
- 3. Press the   buttons to select a mode other than .**  
You can also press the shutter button in this state.
- 4. Press the OK button.**  
White Balance settings are completed and the symbol appears on the screen. This setting will be used for shooting until you change it.





## Setting the White Balance Manually (One Push)

1. Switch the Mode Selector to .

2. Press the ADJ. Button twice.

The White Balance menu appears.

3. Press the   buttons to select  (One Push).

4. Point the camera at a piece of paper or something white under the lighting conditions for your picture.

5. Press the MENU button.

White Balance is set.

6. Press the OK button.

The setting of white balance is completed and the LCD monitor displays a marking. This setting will be used for shooting until you change it.

If you press the MENU button in step 5, the screen refreshes to show the White Balance settings made. If the result is not as expected, repeat steps 4 and 5 to change the settings as many times as required.



### Note

In Auto Mode, white balance may not be adjusted correctly for a subject that is mostly dark. In this case, add something white as the subject.



### Caution

When shooting with flash, white balance may not be adjusted correctly. In this case, switch to Auto Mode for shooting with flash.



# Changing Sensitivities (ISO SETTING)



The ISO sensitivity indicates how sensitive to light the film is. A greater value means higher sensitivity. High sensitivity is suitable for shooting an object in a dark place or moving fast and suppresses blurring. However, the images become rough.

For higher or lower sensitivity, you can select from the following six levels:

AUTO, ISO64, ISO100, ISO200, ISO400, ISO800

A digital camera can automatically vary the sensitivity according to the distance, brightness, zoom, and macro (AUTO). Usually use your camera in the AUTO mode.

To change the setting, use either the Shooting Setting menu or the ADJ. button. This section explains easy ways with the ADJ. button. When using the Shooting Setting menu, see "Using the Shooting Setting Menu" ( P.59).

- 1. Switch the Mode Selector to .**
- 2. Press the ADJ. Button three times.**  
The ISO Sensitivity menu appears.
- 3. Press the   buttons to select an ISO setting.**  
You can also press the shutter button in this state.
- 4. Press the OK button.**

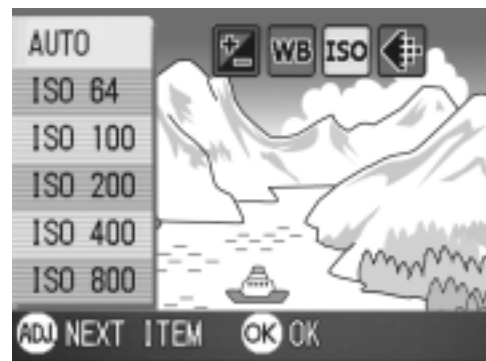

## Note

In Wide-angle Zoom mode, when the ISO Sensitivity is set to Auto, the sensitivity is equivalent to ISO160 with flash or ISO100 without flash.

## Limiting the Shutter Release Speed (SLOW SHUTTER LMT)

By setting this function to [ON], the maximum shutter release speed can be limited to the following:

In Wide-Angle (W): 1/8 second

In Telephoto (T): 1/30 second

When the function is set to [OFF], the maximum shutter release speed is 1 second.

1. Switch the Mode Selector to .

2. Press the MENU button.

The Shooting Setting menu appears.

3. Press the  button to select [SLOW SHUTTER LMT] and press the OK or  button.

4. Press the   buttons to select [ON] or [OFF].

5. Press the OK or  button.

The setting of shutter release speed limit is complete.

6. If you pressed the  button in step 5, press also the MENU button.

The shooting setting menu disappears and the LCD monitor displays the set values.

This setting will be used for shooting until you change it.

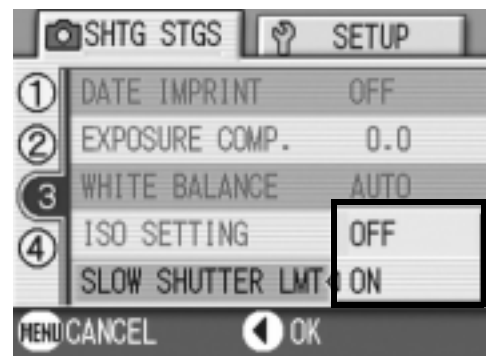

### Note

- When Time Exposure is set to ON, priority is given to Time Exposure.
- When Nightscape is selected in Scene Mode, priority is given to Nightscape.
- When the flash is in Slow Synchro mode, the longest shutter speed is one second.

# Returning the Shooting Setting Menu Settings to their Defaults (RESTORE DEFAULTS)

To return the Shooting Setting menu settings to their defaults, follow the steps below.

1. Switch the Mode Selector to .
2. Press the MENU button.
3. Press the ▲▼ buttons to select [RESTORE DEFAULTS] and press the OK or ► button.
4. Make sure that [YES] is selected, and then press the OK button.

The display indicates the camera is restoring the initial settings; once it is finished, the display returns to the Mode screen.



## Reference





For a list of functions whose settings are not cleared by power-off, see P.158.

# Changing Shading for Shooting Text (DENSITY)



You can change the shading of text for shooting in Text Mode of Scene Mode.

You can select from DEEP, NORMAL and LIGHT.

To change the setting, use either the Shooting Setting menu or the ADJ. button.  
This section explains easy ways with the ADJ. button.  
When using the Shooting Setting menu, see "Using the Shooting Setting Menu" ( P.59).

1. Switch the Mode Selector to .
2. Press the  button.  
The still image mode selection screen appears.
3. Press the  button to move to the SCENE menu.
4. Press the   buttons to select the text mode and then press the OK button.



5. Press the ADJ. button.  
The Text Density menu appears.
6. Press the   buttons to select the desired density setting.  
You can also press the shutter button in this state.
7. Press the OK button.



Text Density settings are completed.

The Text Density setting value does not appear on the screen. This setting will be used for shooting until you change it.

## Reference

For how to shoot text, see P.39.

# Using the AF Target Shift Function

At macro shooting, the AF target shift function allows you to lock the focus (P.34) by using the ▲▼◀▶ buttons on the camera without moving the camera.

This is useful for macro shooting on a tripod with locked focus.

The AF target shift function allows you to shift the cross at the center of the LCD monitor to the subject with the ▲▼◀▶ buttons for focusing.

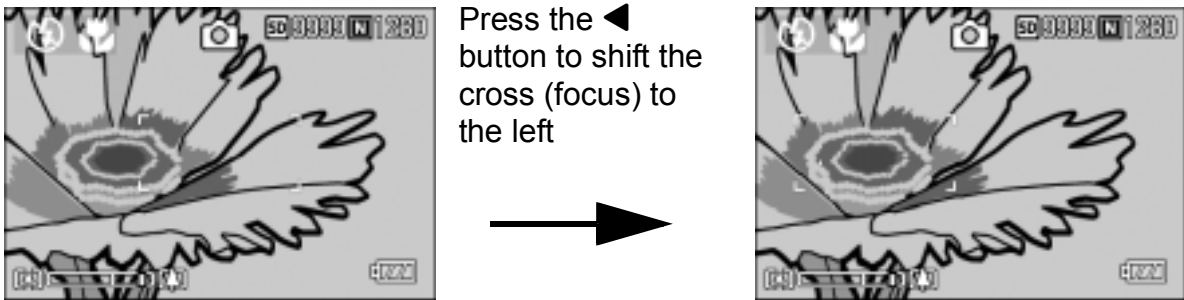

## 1. With the camera ready to shoot, press the button.

The Macro symbol is displayed at the top of the screen.

## 2. Press the ADJ. Button four times.

Press five times if the ADJ. button has the fourth function.

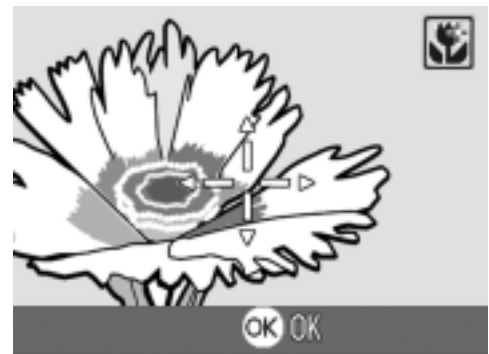

## 3. Shift the cross to the subject with the ▲▼◀▶ buttons for focusing.

## 4. Press the OK button.

## 5. Half-press the shutter button

The camera focuses on the cross.

## 6. Gently press the shutter button all the way.

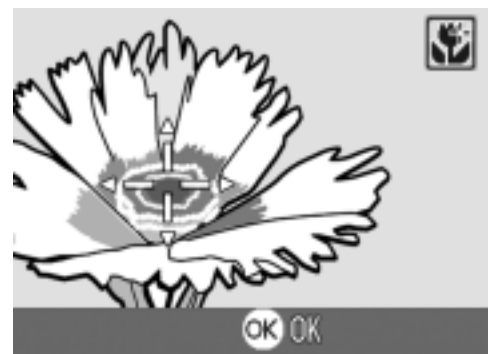

Until you get out of the Macro mode, the AF target shift function automatically focuses the camera on the set position.

## ☺ Using the Self-Timer

You can set the Self-timer to shoot after either two or ten seconds. A setting of two seconds is useful for preventing camera shake.

**1. Switch the Mode Selector to .**

**2. Press the ☺ (Self-timer) button.**

The Self Timer mark appears momentarily in a large size at the center of the LCD monitor and then is displayed at the upper left.

The "10" to the right of the symbol indicates the number of seconds. In this case, if you press the shutter button, the camera will shoot after 10 seconds.



**3. Press the shutter release button.**

The focus is locked, the flash goes on, and the self-timer starts. Once the picture is taken, the self-timer mode is cleared.



### Note

- Each press of the ☺ (Self-timer) button, it selects a function in the following sequence: 10 sec, 2 sec, Self-timer Off, 10 sec, 2 sec.
- Self-timer settings are released when the power is turned off.
- When the self-timer is set to 2 seconds, the flash indicator for self-timer does not fire.

# Shooting with Multi-Shot

If you switch to Multi-Shot, you can shoot consecutive images. Multi-shot can be classified into the following types:

## CONT (Multi-Shot)

As long as you hold the shutter button down, pictures continue to be taken. The still images are recorded one file each, just as in normal shooting.

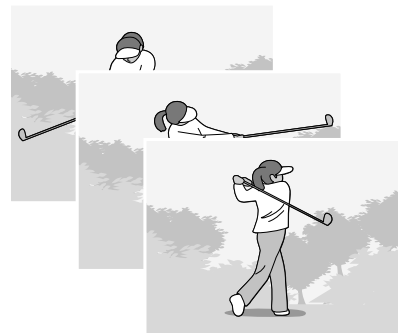

## S (Stream) Multi-Shot

With just one full-press of the shutter, you can take 16 consecutive shots at intervals of 1/7 second (in about 2.2 seconds). The 16 still images are grouped together as a set and are recorded as one image file (2560 x 1920 pixels).

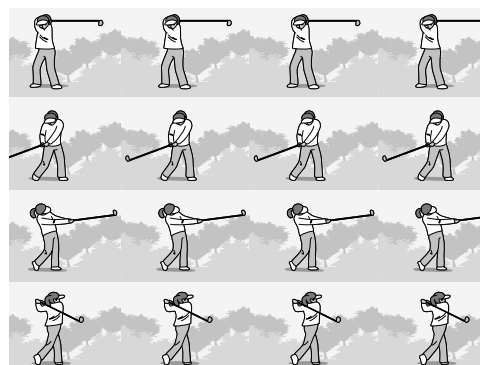

## M (Memory-reversal) Multi-Shot

The camera memorizes the scene while you hold the shutter release button down, and once you release it the previous 2.2 seconds of shots are recorded.

The 16 still images are grouped together as a set and are recorded as one image file (2560 x 1920 pixels).

2. The camera records for about 2.2 seconds ahead

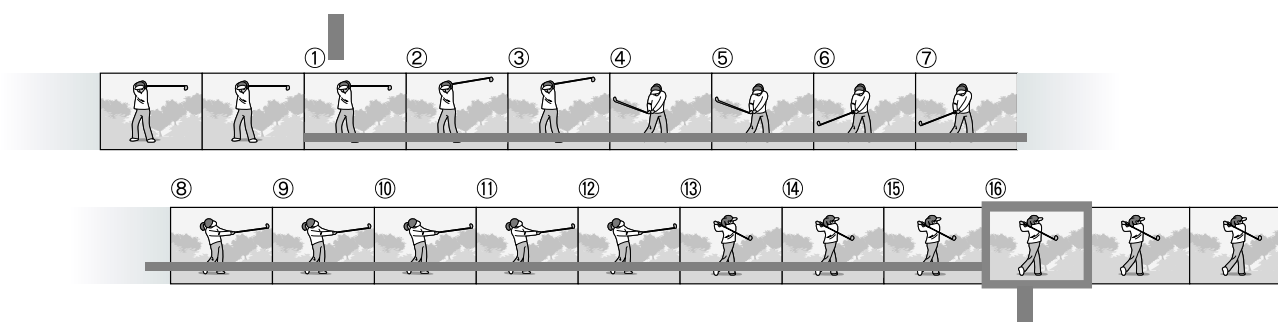

1. If you release the shutter release button here...



## Note

- When shooting with S Multi- or M Multi-Shot, the ISO sensitivity is fixed to AUTO even if it is set to 64,100.
- The maximum number of images that can be shot in the Multi-Shot mode depends on the image size setting as follows:

F2560	N2560	F2048	N2048	F1280	N1280	N640
3	3	3	3	13	13	13

**1. Switch the Mode Selector to .**

**2. Press the MENU button.**

The Shooting Setting menu appears.

**3. Press the ▼ button to select [CONT] and press the OK or ► button.**

**4. Press the ▲▼ buttons to select [CONT], [SCONT], or [MCONT].**

**5. Press the OK or ◀ button.**

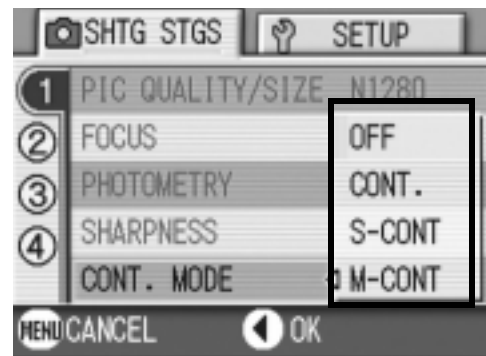

**6. If you pressed the ◀ button in step 5, press also the MENU button.**

The Shooting Setting menu closes and the symbol is displayed at the top of the screen.





## **CONT**

---

### **7. Compose your picture, then press and hold the shutter button.**

As long as you hold the shutter button down, pictures continue to be taken.

### **8. Release your finger from the shutter release button to stop recording.**

To playback consecutive images shot in Multi-Shot mode, turn the camera to playback mode (see P.42) and select the still image with the ◀▶ buttons for playback.

## **SCONT (S Multi-Shot)**

---

### **7. Compose your picture, then press the shutter button.**

16 pictures are taken automatically.

## **MCONT (M Multi-Shot)**

---

### **7. Compose your picture, then press and hold the shutter button.**

The camera memorizes the scene while you hold the shutter release button down.

### **8. Release your finger from the shutter release button.**

The camera stops memorizing and the previous 16 still images (in about 2.2 seconds) are recorded as one still image.

### **Note**

- When you want to return to normal single-shot shooting, follow step 1 through 3, select [OFF] in step 4, and press the OK button.
- In MCONT mode, if you release the shutter button within 2.2 seconds from the time you first pressed it, the shots from the time you pressed the shutter until you released it will be recorded (the number of consecutive shots will be less than 16).
- Flash is switched to OFF.

# Viewing an S Multi-Shot or M Multi-Shot Still Image in Enlarged Display Mode

While still images (16 frames in a file) taken by SCONT or MCONT are displayed, one of the 16 frames can be displayed in an enlarged view. While viewing an enlarged frame image, you can switch between frames.

To view a shot from S Multi-Shot or M Multi-Shot still images in Enlarged Display Mode, follow the steps below.

## 1. Press the Playback button.

The last shot taken is displayed.

## 2. Press the ◀▶ buttons to display an S Multi-Shot or M Multi-Shot still image.



## 3. Press the Q (Enlarged Display) button.

The first frame of consecutive images is displayed in Enlarged Display Mode.

The shot position bar appears at the lower part of the LCD monitor.

Press the ◀▶ buttons to feed the shot.

To return to the 16-shot display, press the OK button.

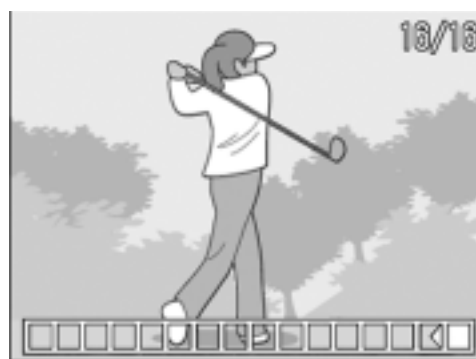

### Note

Press the DISP. button to turn on or off the bar display at the lower part of the LCD moitor.



### Reference

For how to shoot images in S Multi-Shot or M Multi-Shot mode, see P.85.

# Shooting/Playing Back Movies

## Shooting Movies

You can shoot movies with sound.

You can select the image size, either 320 x 240 or 160 x 120 pixels.

You can select number of frames shot per second (frame rate), either 30 or 15.

Each movie you shoot is recorded as one AVI file.

- 1. Switch the Mode Selector to  (Movie Mode).**
- 2. Press the shutter release button.**

The camera starts recording.  
Recording continues until you press the shutter button again.
- 3. Pressing the shutter button again stops recording.**



### Caution

- While shooting movies, operation sounds may be recorded.
- The maximum recording time per shooting depends on your card. Even within the maximum recording time, some cards may end shooting.

### Note

- The flash cannot be used.
- While shooting movies, only Digital Zoom can be used.
- At the time you press the shutter button in Step 2, the shot comes into focus and the white balance is automatically fixed.
- The remaining recording time may not change uniformly because it is recalculated from the remaining memory capacity during movie recording.

### Reference

- For how to change the image size for movies, see P.60.
- For how to change the frame rate, see P.90.
- For how to use the Digital Zoom, see P.36.
- For the list of shooting setup menu items available in Movie mode, see P.157.

# Setting the Frame Rate

The number of shot frames per second (frame rate) in Movie Mode can be selected from 30 and 15.

1. **Switch the Mode Selector to .**
2. **Press the MENU button.**  
The shooting setting menu appears.
3. **Press the ▼ button to select [FRAME RATE]. Then press the OK or ► button.**
4. **Press the ▲▼ button to select [30 FPS] or [15 FPS].**
5. **Press the OK or ◀ button.**  
This completes the frame rate setting.
6. **If the ◀ button was pressed in Step 5, press the MENU button.**  
The shooting setting menu disappears and the LCD monitor displays the set values.  
The set values are used for shooting until they are changed the next time.

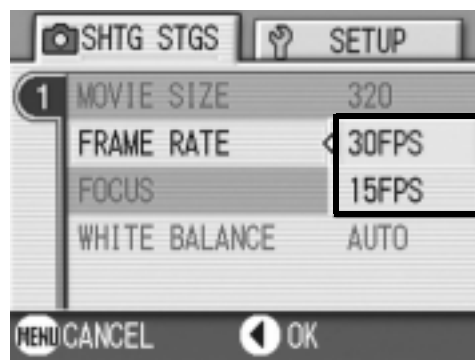

## Note

The movie recording time depends on the capacity of the SD memory card. The recording time is as shown below.

	IN	32MB	64MB	128MB	256MB	512MB	1GB
15FPS 320 X 240	1 min 23 s	1 min 27 s	2 min 57 s	5 min 59 s	11 min 56 s	24 min 4 s	46 min 17 s
30FPS 320 X 240	42 s	44 s	1 min 30 s	3 min 2 s	6 min 4 s	12 min 13 s	23 min 30 s
15FPS 160 X 120	5 min 1 s	5 min 18 s	10 min 51 s	21 min 57 s	43 min 44 s	88 min 7 s	169 min 27 s
30FPS 160 X 120	2 min 38 s	2 min 48 s	5 min 45 s	11 min 37 s	23 min 10 s	46 min 42 s	89 min 48 s

# Playing Back Movies

To playback movies, follow the steps below.

## 1. Press the Playback button.

The last shot taken is displayed.

For movies, the first frame is displayed as a still image.

## 2. Move to the movie you want to view using the ◀▶ buttons.

Press the ▶ button to display the next file.

Press the ◀ button to display the previous file.

## 3. Press the OK button.

Playback begins.

The elapsed playback indicator or the elapsed time is displayed on the LCD Monitor.



Fast Forward	Press the [▲] button during playback.
Rewind	Press the [▼] button during playback.
Pause/Playback	Press the OK button.
Slow Playback	Keep pressing the [▲] button during pause.
Slow Rewind	Keep pressing the [▼] button during pause.
Next Frame	Press the [▲] button during pause.
Previous Frame	Press the [▼] button during pause.
Volume Adjustment	Press the ▲▼ buttons during playback.

## Term

### Movie Frames

A movie frame is also called a frame. Movies consist of many frames whose images appear to be moving when displayed at high speed.

# Recording/Playing Back Sound

## Recording Sound (Voice Memo)

You can record sound.

Recorded data is stored as a WAV file.

1. **Switch the Mode Selector to  (Voice Memo Mode).**

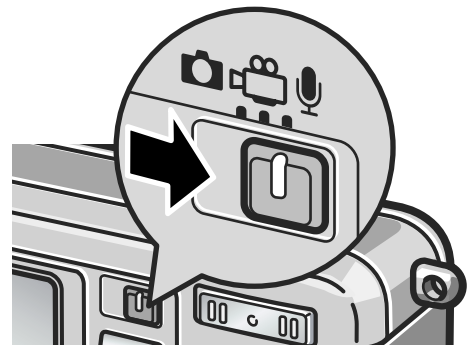

2. **Press the shutter release button.**  
Sound recording starts.
3. **Release your finger from the shutter release button to stop recording.**

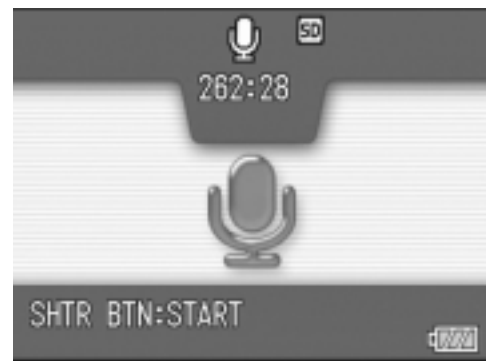

### Note

The voice recording time depends on the capacity of the SD memory card. The table below shows the available recording time.

Capacity	Recording Time
28MB (Internal memory)	61 min 32 s
32MB	64 min 38 s
64MB	132 min 13 s
128MB	267 min 17 s
256MB	532 min 38 s
512MB	1073 min 11 s

# Playing Back Sound

To playback sounds, follow the steps below.

## 1. Press the Playback button.

The last shot taken is displayed.

## 2. Press the ◀▶ buttons to select a sound file for playback (speaker icon).

Press the ▶ button to display the next file.

Press the ◀ button to display the previous file.

## 3. Press the OK button.

Playback begins.



Fast Forward	Press the [▲] button during playback.
Rewind	Press the [▼] button during playback.
Pause/Playback	Press the OK button.
Volume Adjustment	Press the ▲▼ buttons during playback.

# Other Functions Available in Playback Mode

## Playback Setting Menu

The Playback menu provides the functions shown in the table below:

Setting	Option	Refer to
SLIDE SHOW	_____	P.95
PROTECT	Select/Deselect 1 FILE, Select/Deselect ALL FILES, Select Multi-files	P.96
DPOF	Select/Deselect 1 FILE, Select/Deselect ALL FILES, Select Multi-files	P.99
RESIZE	1280, 640	P.102
COPY TO CARD	_____	P.103

### Note

The SETUP menu can be accessed from within the Playback Setting menu. For details, see P.106.

## Using the Playback Menu

- 1. Press the Playback button to Switch the camera to playback mode.**
- 2. Press the MENU button.**  
The Playback menu appears.
- 3. Press the ▲▼ buttons to select the desired setting.**
- 4. After selecting a setting item, press the OK or ► button.**  
Each function screen appears.





# Showing Photos in Order Automatically (SLIDE SHOW)

You can show the recorded still images, movies, and sound files sequentially on the LCD Monitor. This function is called a slide show. To view a slide show, follow the steps below.

## 1. Press the Playback button.

The last shot taken is displayed.

## 2. Press the MENU button.

The Playback menu appears.

## 3. Make sure that [SLIDE SHOW] is selected, and then press the OK or ► button.

The slide show starts and files are played back in order.

If you want to stop the slide show in progress, press any button on the camera.

Until stopped, the slide show will repeat itself.



### Note

- Still images are displayed for 3 seconds each.
- For movies, not just one frame, but the entire movie you shot is displayed.
- Sound files are also played back.

# Write-protecting Your Images (PROTECT)

You can protect files from being accidentally deleted.

## Caution

Protected files cannot be deleted normally. However, they will be deleted completely if you format the memory where the files are stored.

## Protecting Files

### 1. Press the Playback button.

The last shot taken is displayed.

### 2. Press the ◀▶ buttons to display the file you want to protect.

### 3. Press the MENU button.

The Playback Setting menu appears.

### 4. Press the ▼ button to select [PROTECT] and press the OK or ▶ button.

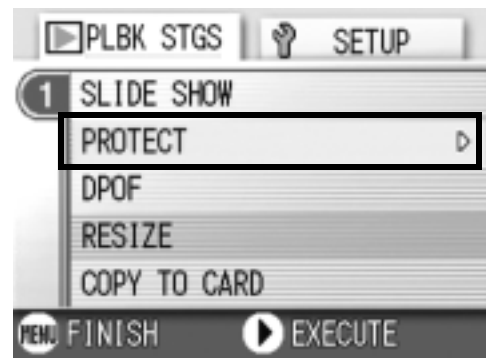

### 5. Make sure that [1 FILE] is selected, and then press the OK button.



Protection is applied and the Protect symbol appears in the upper-left corner of the screen.



## Protecting All Files

To protect all your files, follow the steps below.

- 1. Press the Playback button.**
- 2. Press the MENU button.**  
The Playback menu appears.
- 3. Press the ▼ button to select [PROTECT] and press the OK or ► button.**
- 4. Press the ▲▼ button to select [ALL FILES].**



- 5. Make sure that [SELECT] is selected, and then press the OK button.**

Protection is applied and the Protect symbol appears in the upper-left corner of the screen.

To remove protection from all your files, select [CANCEL] in step 5.



### Note

You can remove protection from all or multiple files at once.

## Protecting Multiple Files at Once

To protect selected files all at once, follow the steps below.

**1. Press the Playback button.**

**2. Press the  (Thumbnail) button twice.**

The screen is divided into 12 frames and displays 12 still images at once.

**3. Press the     buttons to select the first file of the selection.**

**4. Press the MENU button.**

The Playback menu appears.

**5. Press the  button to select [PROTECT] and press the OK or  button.**

**6. Press the     buttons to select the next file of the selection, and then press the OK button.**

The Protect symbol appears in the upper-right corner of the file.

**7. Repeat Step 6 to select all the files you wish to protect.**

If you selected a file by mistake, you can deselect by selecting the file and pressing the OK button again.

**8. Press the MENU button.**

The display indicates that the selected images are being processed; once finished, the display returns to the Thumbnail Display screen.



### Note

To remove protection from multiple files, follow the same steps described above to select them and remove protection.



### Reference

For details on thumbnail display, see P.45.

# Using a Printing Service (DPOF)

The still images recorded on an SD Memory Card can be printed out if you take them to a shop that offers a digital camera print service. To use a print service, it is necessary to make settings required for printing. These settings are called DPOF (Dee-Pof) settings. The DPOF setting specifies one print per still image. However, if multiple images are selected for batch setting, you can specify the number of copies to print.

## Setting DPOF for the Still Image Displayed

1. Press the Playback button.
2. Display the still image you want to specify.
3. Press the MENU button.  
The Playback Setting menu appears.
4. Press the ▼ button to select [DPOF] and press the OK or ► button.



5. Make sure that [1 FILE] is selected, and then press the OK button.

Once the DPOF setting is made, the DPOF symbol appears in the upper-left portion of the screen.



### Note

Removing the DPOF setting for one photo at a time is done in the same way as setting it.

## Setting DPOF for All Still Images

To apply DPOF settings to all your still images, follow the steps below.

1. **Press the Playback button.**
2. **Press the MENU button.**  
The Playback menu appears.
3. **Press the ▼ button to select [DPOF] and press the OK or ► button.**
4. **Press the ▲▼ buttons to select [ALL FILES].**
5. **Make sure that [SELECT] is selected, and then press the OK button.**

Once the DPOF setting is made, the DPOF symbol appears in the upper-left portion of the screen.



















### Note

- To remove the DPOF setting from all your still images, select [CANCEL] in step 5.
- You can remove all or multiple still image DPOF settings at once.

## Setting DPOF for Multiple Still Images

To make the DPOF setting for selected still images all at once, follow the steps below.

1. **Press the Playback button.**
  2. **Press the  (Thumbnail) button twice.**  
The screen is partitioned into twelve segments to display the thumbnails of files.
  3. **Press the     buttons to select the first still image for which you wish to make the DPOF setting.**
  4. **Press the MENU button.**  
The Playback menu appears.
  5. **Press the  button to select [DPOF] and press the OK or  button.**
- 
6. **Press the   buttons to set the number of copies to print.**  
Press the  button to increase the number, or the  button to decrease it.
  7. **Press the   buttons to select the next still image for which you wish to make the DPOF setting.**
  8. **Press the   buttons to set the number of copies to print.**  
Press the  button to increase the number, or the  button to decrease it.
  9. **Repeat Steps 7 and 8 to select all the still images for which you wish to make the DPOF setting.**
  10. **Press the MENU button.**  
The display indicates that the selected images are being processed; once finished, the display returns to the Thumbnail Display screen.

# Changing the Image Size (RESIZE)

You can reduce the image size of a shot still image to additionally create a file of a different image size.



## Caution

You can resize only still images and still images with voice memos. Movies cannot be resized.



## Note

The following types of resizing are possible:

Original	Resized	
F2560/N2560/F2048/N2048	N1280	N640
F1280/N1280		N640

To change the image size, follow the steps below.

- 1. Press the Playback button.**
- 2. Press the MENU button.**  
The Playback Setting menu appears.
- 3. Press the ▼ button to select [RESIZE] and press the OK or ► button.**
- 4. Press the ▲▼ buttons to select [1280] or [640].**
- 5. Press the OK button.**  
The image size is changed and the resized still image is displayed.

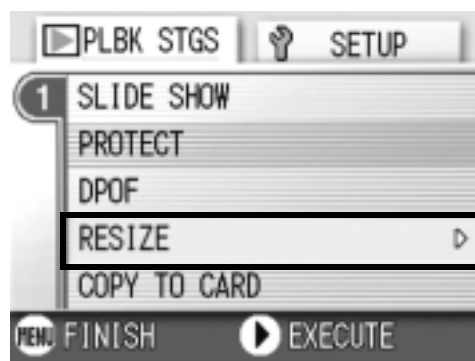

## Reference

For how to change the image size at shooting, see P.60.



## Copying the Contents of Internal Memory to a Memory Card (COPY TO CARD)

You can copy all movies, still images, and sound data stored in internal memory onto an SD Memory Card at once.

1. Turn the Camera Off.
2. Insert an SD Memory Card.
3. Turn the camera on.
4. Press the Playback button.
5. Press the MENU button.  
The Playback Setting menu appears.
6. Press the ▼ button to select [COPY TO CARD] and press the OK or ► button.

The display indicates copying is in progress; once finished, the display returns to the playback screen.



### Note

- If the capacity of the SD Memory Card you are copying to is insufficient, a message will be displayed indicating there is not enough capacity. To copy only the number of shots that will fit into the available capacity, select [YES] and then press the OK button. To cancel copying, select [NO] and then press the OK button.
- It is not possible to copy from SD Memory Card to internal memory.



# Chapter 3

## Changing Camera Settings

Changing Camera Settings .....	106
--------------------------------	-----



# Changing Camera Settings

## SETUP Menu

You can change camera settings by displaying the SETUP menu from the Shooting Setting menu (see P.58) or Playback Setting menu (see P.94).

The SETUP menu enables you to set the items listed in the table below.



Setting	Option	Refer to
FORMAT [CARD]	_____	P.108
FORMAT [INT. MEM.]	_____	P.109
LCD BRIGHTNESS	_____	P.110
ADJ. BUTT. SET.	[OFF], PIC QUALITY (  ), AF/ MF, SHARP, PHOTOMETRY (  )	P.111
AUTO POWER OFF	OFF, [1], 5, 30 Minutes	P.112
BEEP SOUND	[ALL], SHUTTER	P.113
OPE. ALERT VOL.	OFF ( <input type="checkbox"/> <input type="checkbox"/> <input type="checkbox"/> ), Small ( <input checked="" type="checkbox"/> <input type="checkbox"/> <input type="checkbox"/> ), [Medium] ( <input checked="" type="checkbox"/> <input checked="" type="checkbox"/> <input type="checkbox"/> ), Large ( <input checked="" type="checkbox"/> <input checked="" type="checkbox"/> <input checked="" type="checkbox"/> )	P.114
LCD CONFIRM.	OFF, [1], 2, 3 Seconds	P.115
SEQUENTIAL NO.	ON, [OFF]	P.116
DATE SETTINGS	_____	P.117
LANGUAGE	日本語, [ENGLISH], DEUTSCH, FRANÇAIS, ITALIANO, ESPAÑOL, 简体中文, 繁体中文, 한국어	P.118
VIDEO OUT MODE	[NTSC], PAL	P.119
STEP ZOOM	ON, [OFF]	P.120
SHTG STGS WARNG.	[ON], OFF	P.121
USB CONNECTION	MASS STR, [ORIGINAL]	P.122
ENLGE PHOTO ICON	[OFF], ON	P.126

# Using the SETUP Menu

To display and use the Setup menu, follow the steps below.



## Note

For some functions, the choice selection method may not be as explained here. For detailed operation, see the explanation of each function.

### 1. Press the MENU button.

The Shooting Setting menu (or the Playback menu) appears.

### 2. Press the ► button.

The setup menu appears.

### 3. Press the ▲▼ buttons to select the desired setting.

The setting items are provided on 4 screens.

When the ▼ button is pressed at the bottom item, the next screen appears.



#### To select a screen by screen number:

1. Press the ◀ button to select a screen number on the left of the screen.
2. With the screen number selectable, press the ▲▼ buttons to switch between screens.
3. After selecting the screen, press the ► button to return to the setting item selection step.

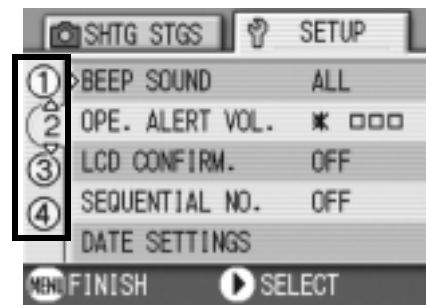

### 4. After selecting a setting item, press the OK or ► button.

Choices for the setting item are displayed.

### 5. Press the ▲▼ buttons to select a choice.

### 6. Press the OK or ◀ button.

### 7. If you pressed the ◀ button in step 6, press also the MENU button.

The menu disappears and the camera becomes ready for shooting and playing back.

# Getting the SD Memory Card Ready for Use (FORMAT [CARD])

If the error message "This card cannot be used" is displayed, or if you have formatted a card with a computer or some other device, it will be necessary to format the SD Memory Card prior to use. Formatting is the process of preparing a card so image data can be written on it.

## Caution

If you format a card that still has images stored on it, the images will be lost.

## Reference

For how to format internal memory, see P.109.

To format a card, follow the steps below.

### 1. Display the setup menu.

For detailed operation, see P.107.

### 2. Press the ▲▼ button to select [FORMAT [CARD]] and press the OK or ► button.

A screen appears to confirm formatting.

### 3. Press the ◀▶ button to select [YES] and then press the OK button.

Formatting starts. When it is done, the display returns to the SETUP menu.

If no SD Memory Card is inserted, a message will be displayed.

After turning the power off, load an SD Memory Card and repeat the formatting process again.

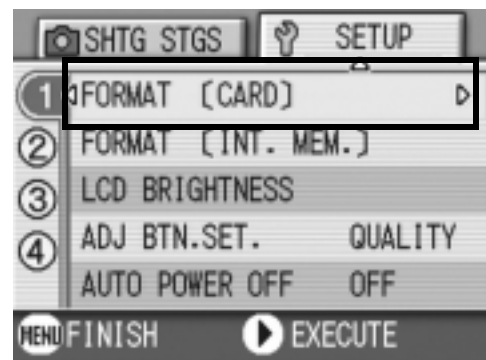

## Note

### Protecting your images from being deleted

If you move the card's write-protection switch to LOCK, your still images cannot be accidentally erased and the card cannot be formatted.

If you release the protection (by returning the switch to its original position), it is once again possible to erase images and format the card.

# Formatting Internal Memory (FORMAT [INT. MEM.])

If an error message "Format the internal memory" is displayed, it will be necessary to format the internal memory prior to use.



## Caution

Formatting the internal memory erases all of the images recorded in the memory. If you have images that you do not want to erase stored on the internal memory, please contact the Ricoh Service offices prior to formatting it.

To format internal memory, follow the steps below.

### 1. Display the setup menu.

For detailed operation, see P.107.

### 2. Press the ▲▼ button to select [FORMAT [INT. MEM.]] and then press the OK or ► button.

A screen appears to confirm formatting.

### 3. Press the ◀▶ buttons to select [YES] and then press the OK button.

Formatting starts. When it is done, the display returns to the SETUP menu.

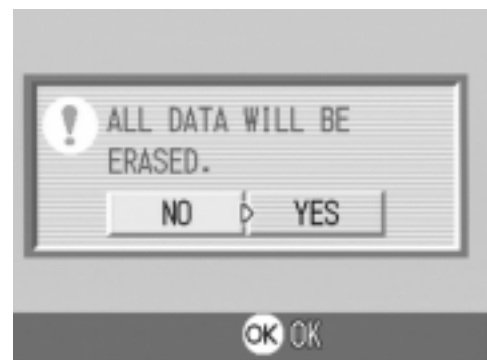
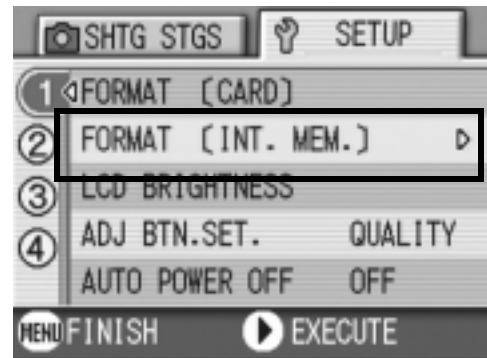

# Adjusting the Brightness of the LCD Monitor (LCD BRIGHTNESS)

To adjust the brightness of the LCD Monitor, follow the steps below.

## 1. Display the setup menu.

For detailed operation, see P.107.

## 2. Press the ▲▼ button to select [LCD BRIGHTNESS] and press the OK or ► button.

The LCD Brightness Adjustment bar appears.

## 3. Press the ▲▼ buttons to adjust the brightness.

Moving it to the ☀ side makes it darker.

Moving it to the ☀ side makes it brighter.

The brightness of the screen behind the bar changes as you alter the setting.

## 4. When you attain the desired brightness, press the OK button.

The display returns to the SETUP screen.

This setting will be used until you change it.

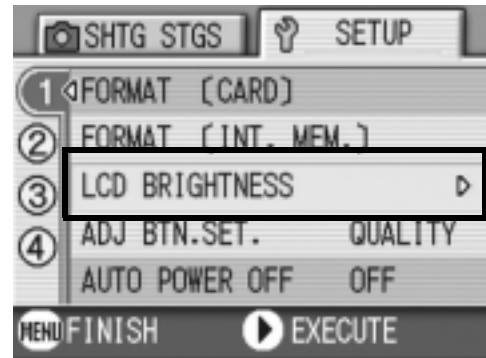



# Setting a Function to the ADJ. Button (ADJ BTN.SET.)

Each time the ADJ. button is pressed, the camera displays the setting screen in the order of exposure, white balance, and ISO sensitivity.

By using the [ADJ BTN.SET.] option, you can set a function to be activated when the ADJ. button is pressed the fourth time.

Possible Settings	(Refer to)
OFF *Setting upon purchase	
QUALITY (PIC/QUALITY)	P.60
AF/MF (FOCUS)	P.62
SHARP (SHARPNESS)	P.66
PHOTOMETRY	P.65

To assign a function to the ADJ. button, follow the steps below.

## 1. Display the setup menu.

For detailed operation, see P.107.

## 2. Press the ▲▼ button to select [ADJ BTN.SET.] and press the OK or ► button.

## 3. Press the ▲▼ buttons to select the desired setting.

## 4. Press the OK or ◀ button.

## 5. If you pressed the ◀ button in step 4, press also the MENU button.

This setting will be used until you change it.

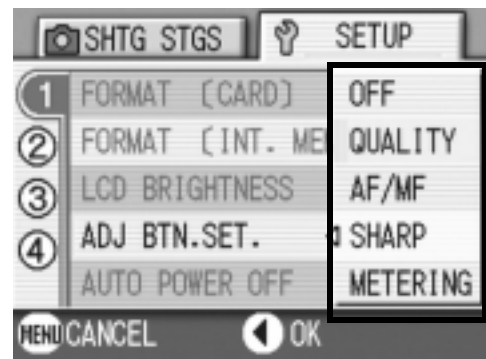

### Note

If a function is set with [ADJ BTN.SET], the AF target shift function (P.83) available from the ADJ. button at Macro shooting is activated when the ADJ. button is pressed the fifth time.

### Reference

For how to use the ADJ. button, see P.57.

# Changing Auto Power-Off Settings (AUTO POWER OFF)

If you do not operate the camera for the set period of time, it will shut off automatically (Auto Power-off) to conserve battery power.

At the time of purchase, Auto Power-Off is set to one minute, but you can change this setting.

Possible Settings
OFF (The Auto Power-Off function does not work)
1 Minute *Setting upon purchase
5 Minutes
30 Minutes

To change the Auto Power-Off setting, follow the steps below.

## 1. Display the setup menu.

For detailed operation, see P.107.

## 2. Press the ▲▼ button to select [AUTO POWER OFF] and press the OK or ► button.

## 3. Press the ▲▼ buttons to select the desired setting.

## 4. Press the OK or ◀ button.

## 5. If you pressed the ◀ button in step 4, press the MENU button.

This setting will be used until you change it.



### Note

- To continue on using the camera after auto power-off, slide the power switch to close the lens cover once (power-off) and slide it again to open (power-on). When the Playback button is pressed, the lens cover does not open but the camera is turned on for use in Playback Mode.
- The Auto Power-off function does not work when the camera is connected to a computer.
- When shooting with Interval Shooting, settings made here are not valid and Auto Power-Off does not work.

# Changing the Beep Sound Setting (BEEP SOUND)

During operation, the camera generates four types of sounds: start sound, shutter release sound, focus sound, and beep sound.

- Start sound : Sound when the camera power is turned on.
- Shutter release sound : Sound when the shutter button is pressed.
- Focus sound : When the focus is set, the camera generates the focus sound.
- Beep Sound : If an impossible operation is attempted, the camera generates the beep sound.

Possible Settings
SHUTTER (Shutter release sound, Beep Sound)
ALL (all sounds on) *Setting upon purchase

To change the beep sound settings, follow the steps below:

## 1. Display the setup menu.

For detailed operation, see P.107.

## 2. Press the ▲▼ button to select [BEEP SOUND] and press the OK or ► button.

## 3. Press the ▲▼ buttons to select the desired setting.

## 4. Press the OK or ◀ button.

## 5. If you pressed the ◀ button in step 4, press also the MENU button.

This setting will be used until you change it.

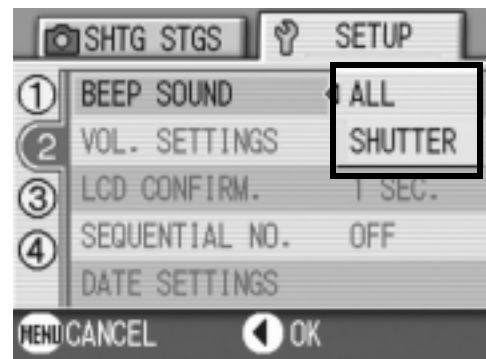

## Reference

For how to adjust volume, see P.114

# Changing the Beep Sound Volume (VOL. SETTINGS)

The beep sound volume can be changed.

Possible Settings	
<input type="checkbox"/> <input type="checkbox"/> <input type="checkbox"/>	(Mute)
<input checked="" type="checkbox"/> <input type="checkbox"/> <input type="checkbox"/>	(Small)
<input checked="" type="checkbox"/> <input checked="" type="checkbox"/> <input type="checkbox"/>	(Medium) *Setting upon purchase
<input checked="" type="checkbox"/> <input checked="" type="checkbox"/> <input checked="" type="checkbox"/>	(Large)

To change the beep sound volume, follow the steps below:

## 1. Display the setup menu.

For detailed operation, see P.107.

## 2. Press the ▲▼ button to select [VOL. SETTINGS] and press the OK or ► button.

## 3. Press the ▲▼ buttons to select the desired setting.

## 4. Press the OK or ◀ button.

## 5. If you pressed the ◀ button in step 4, press also the MENU button.

This setting will be used until you change it.



# Changing Image Confirmation Time (LCD CONFIRM.)

Immediately after pressing the shutter button, the still image taken is displayed for a moment so you can check it.

At purchase, Confirmation Time is set to one second, but this can be changed.

Possible Settings
OFF (Photo not displayed for confirmation)
1 Second *Setting upon purchase
2 Seconds
3 Seconds

To change Confirmation Time, follow the steps below.

- 1. Display the setup menu.**  
For detailed operation, see P.107.
- 2. Press the ▲▼ button to select [LCD CONFIRM.] and press the OK or ► button.**
- 3. Press the ▲▼ buttons to select the desired setting.**
- 4. Press the OK or ◀ button.**
- 5. If you pressed the ◀ button in step 4, press also the MENU button.**  
This setting will be used until you change it.



# Changing File Name Settings (SEQUENTIAL NO.)

When you shoot a still image, it is stored on an SD Memory Card or in internal memory, with a consecutively numbered file name automatically assigned. When you are switching SD Memory Cards, you can set your camera to continue consecutive numbering from the previously loaded SD Memory Card.

Possible Settings	
ON (Continue numbering)	File names will be automatically assigned to still images you take, in the format of "R" followed by 7 digits, from R0010001.jpg to R9999999.jpg. With this setting, even when one SD Memory Card is switched with another, consecutive file numbering from the previous card is continued.
OFF (Do not continue numbering) *Setting upon purchase	Every time a new card is loaded, file numbering is assigned, from RIMG0001.jpg to RIMG9999.jpg. If numbering exceeds RIMG9999, further recording is not possible

To make changes to file numbering, follow the steps below.

## 1. Display the setup menu.

For detailed operation, see P.107.

## 2. Press the ▲▼ button to select [SEQUENTIAL NO.] and press the OK or ► button.

## 3. Press the ▲▼ buttons to select the desired setting.

## 4. Press the OK or ◀ button.

## 5. If you pressed the ◀ button in step 4, press also the MENU button.

This setting will be used until you change it.

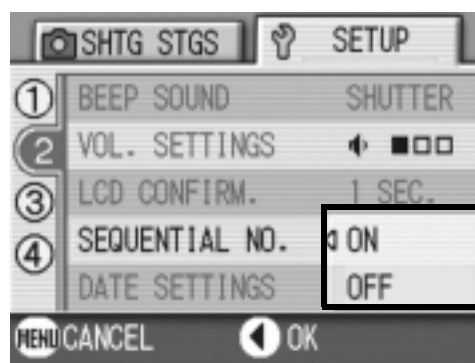

### Note

- When you are recording to internal memory, file names are assigned just as when [SEQUENTIAL NO.] is set to [OFF].
- When transferring images to a computer, if a file already exists with the same name in the destination folder, your image is renamed before saving to avoid overwrite problem.
- When transferring images to a computer via the provided USB cable, the files are assigned names like RIMG\*\*\*\*.jpg (\*\*\*\* indicates the number of the image), even if [SEQUENTIAL NO] is set to ON.

# Setting the Date and Time (DATE SETTINGS)

You can take still images with the time or date stamped onto the picture.

The date/time setting on the SETUP menu is explained here.

## 1. Display the setup menu.

For detailed operation, see P.107.

## 2. Press the ▲▼ button to select [DATE SETTINGS] and press the OK or ► button.

## 3. Press ▲▼◀▶ to set the year, month, date and time.

If you hold down the ▲ or ▼ button, you can increase/decrease the value quickly.

## 4. In [FORMAT], choose the date and time format.

## 5. Check the display on the bottom of the screen and then press the OK button.

Once you have set the date and time, the display returns to the Setup menu.

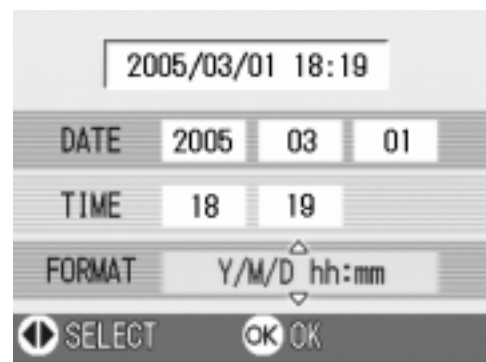
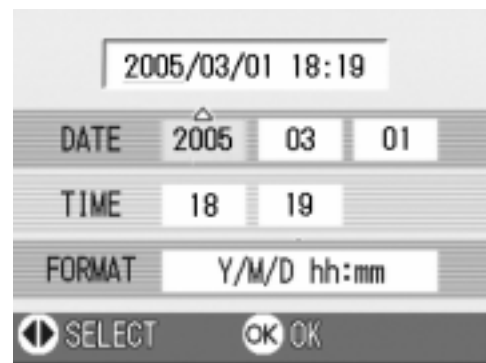
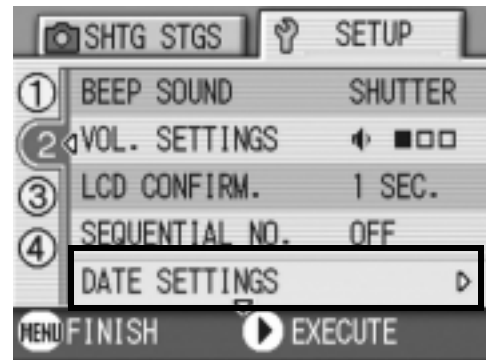

### Note

If the batteries are removed for more than one week, the date and time settings will be lost. These settings must be made again.

# Changing the Display Language (LANGUAGE/ 言語 )

You can change the language displayed on the LCD Monitor.

Possible Settings
日本語 (Japanese)
ENGLISH (English) *Setting upon purchase
DEUTSCH (German)
FRANÇAIS (French)
ITALIANO (Italian)
ESPAÑOL (Spanish)
簡体中文 (Simplified Chinese)
繁体中文 (Traditional Chinese)
한국어 (Korean)

To change the display language, follow the steps below.

## 1. Display the setup menu.

For detailed operation, see P.107.

## 2. Press the ▲▼ button to select [LANGUAGE/言語] and press the OK or ► button.

The language selection screen appears.

## 3. Press the ▲▼◀▶ buttons to select the desired setting.

## 4. Press the OK button.

This setting will be used until you change it.





## Changing the Playback Method for Viewing on TV (VIDEO OUT MODE)

You can view your still images and movies on a television screen by connecting your camera to a television with the AV cable that came with your camera.

Your camera is set to NTSC video format (used in Japan and other countries) for use with television equipment, etc. If the equipment you want to connect to uses PAL format (used in Europe and elsewhere), then switch your camera to PAL format before connecting.

Possible Settings
NTSC *Setting upon purchase
PAL

To change the playback format, follow the steps below.

### 1. Display the setup menu.

For detailed operation, see P.107.

### 2. Press the ▲▼ button to select [VIDEO OUT MODE] and press the OK or ► button.

### 3. Press the ▲▼ buttons to select the desired setting.

### 4. Press the OK or ◀ button.

### 5. If you pressed the ◀ button in step 4, press also the MENU button.

This setting will be used until you change it.



### Note

Connecting the AV cable to the camera turns off the LCD monitor display.

### Reference

For how to view still images on your television screen, see P.47.

# Changing the Setting of Step Zooming (STEP ZOOM)

The focal length with optical zooming can be fixed to any of five levels (28, 35, 50, 85, and 135 mm as converted equivalent to 35 mm cameras) (Step Zoom).

Possible Settings
OFF *Setting upon purchase
ON

To set whether to use step zooming (ON) or not (OFF), follow the steps below.

## 1. Display the setup menu.

For detailed operation, see P.107.

## 2. Press the ▲▼ button to select [STEP ZOOM] and press the OK or ► button.

## 3. Press the ▲▼ buttons to select the desired setting.

## 4. Press the OK or ◀ button.

## 5. If you pressed the ◀ button in step 4, Press the MENU button.

This setting will be used until you change it.



### Note

For step zooming in Macro Mode, the focal length changes in four steps (35, 50, 85, and 135 mm as converted equivalent to 35 mm).

### Reference

For how to use zoom, see P.36.

# Displaying a Setting Change Warning (SHTG STGS WARNG.)

You can set the icon of a changed function blink or a warning message indicating a change will be displayed at power-on for about 5 seconds if the initial settings are changed for the following functions.

- White Balance
- Focus
- ISO Setting
- Exposure Comp.
- Time Exposure

If you operate a camera button, the icon is changed from blinking to steady.

If you operate a camera button during warning message display, the message disappears.

Possible Settings
OFF
OFF *Setting upon purchase

To set whether to enable (ON) or disable (OFF) the shooting setting alert, follow the steps below.

## 1. Display the setup menu.

For detailed operation, see P.107.

## 2. Press the ▲▼ button to select [SHTG STGS WARNG.] and press the OK or ► button.

## 3. Press the ▲▼ buttons to select the desired setting.

## 4. Press the OK or ◀ button.

## 5. If you pressed the ◀ button in step 4, press also the MENU button.

This setting will be used until you change it.



# Changing the USB Communication System (USB Connection)

## Changing the USB Communication System (USB Connection)

If the USB communication system is changed (by selecting [MASS STR] at [USB CONNECTION] on the Setup menu), files in the camera can be browsed and transferred from the camera to your computer through the USB cable without installing the accessory application or USB driver.

Usually, select [ORIGINAL]. When [ORIGINAL] is set, images can be transferred to your computer by using the attached RICOH Gate La or Caplio Transfer Software.

Mode	Mass Storage	Original
Download Method	The SD memory card or built-in memory of the camera can be operated directly as an external drive for file processing.	RICOH Gate La allows automatic transfer to your computer. Caplio Transfer Software allows transfer to Ricoh Desk 2000 Lt (Windows only). The mounter allows transfer to your computer. (Mac OS)
Installation from Caplio CD-ROM	Unnecessary	Necessary
Supported OS		
Windows 98/98 SE	X	○
Windows 2000 Professional	○	○
Windows Me	○	○
Windows XP Home Edition	○	○
Windows XP Professional	○	○
Mac OS 8.6	X	○
Mac OS 9.0 to 9.2.2	○	○
Mac OS X 10.1.2 to 10.3	○	○
For those:	Familiar with OS file operations Not willing to install a USB driver or other	Willing to automate downloading to a computer Using Windows 98/98 Second Edition Using Mac OS 8.6



## Caution

- At [MASS STR], RICOH Gate La or Caplio Transfer Software cannot be used for file transfer.
- At [MASS STR], files can only be read from the camera and cannot be written into or deleted from the camera.
- For direct printing on a printer supporting both Direct Print and PictBridge, select [Original] at [USB CONNECTION].

To change the USB communication system, follow the steps below:

### 1. Display the setup menu.

For the operating procedure, see P.107.

### 2. Press the ▲▼ button to select [USB CONNECTION]. Then press the OK or ► button.

### 3. Press the ▲▼ button to select a value.

### 4. Press the OK or ◀ button.

### 5. If the ◀ button was pressed in Step 4, press the M button.

These settings are used until they are changed the next time.



## Reference

For how to transfer images by connecting the camera to your computer with the USB cable, see the Software User Guide.

To transfer images in Mass Storage Mode, follow the steps below:

1. Change [USB CONNECTION] to [MASS STR] on the Setup menu.
2. Make sure that the camera power is off.
3. Connect the accessory USB cable to a USB port of your computer.
4. Connect the USB cable to the USB terminal of the camera.

The camera power becomes on.

Your computer automatically reads a file necessary for recognizing the camera as a drive.

After this preparation, the camera is displayed as a drive at My Computer (Windows) or Desktop (Macintosh).

5. From the displayed drive, copy a file to the desired destination.

The figure at right shows the folder configuration in a drive.

When the contents of the built-in memory are displayed, the drive name is RICOHDCI.



Example of the Windows XP screen

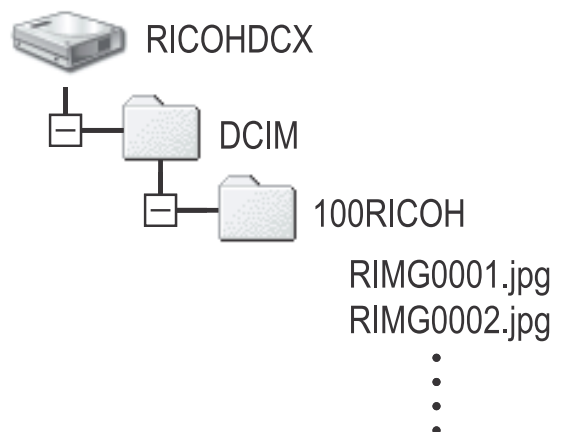

### Caution

During transfer, do not disconnect the USB cable.



### Note

When a SD memory card is inserted, its files are displayed. Otherwise, files in the built-in memory are displayed.

## Disconnecting the Camera from Your Computer (Windows)

This display is an example for Windows XP. The terms are different for other OS but the operations are the same.

1. Click the **Remove Hardware Safely** icon at the right end of the task bar.
2. Select **[USB Large-capacity Storage Device]** and click **[Stop]**.
3. Check that **[USB Large-capacity Storage Device]** is selected and click **[OK]**.
4. Click **[OK]**.



## Disconnect the Camera from Your Computer (Macintosh)

1. Put the displayed drive in the **Recycle Bin**.

## Enlarging Icon Display (ENLGE PHOTO ICON)

Icons on the shooting screen are enlarged.

Under this setting, the following icons are enlarged:

- Flash
- Macro Shooting
- Self Timer
- White Balance
- Focus
- Exposure Compensation
- ISO Sensitivity

If icons are enlarged, the following items are not displayed:

- Zoom Bar/Focus Bar
- Date/Time
- Sharpness
- Color Depth

To enlarge icons on the shooting screen, follow the steps below:

### 1. Display the setup menu.

For the operating procedure, see P.107.

### 2. Press the ▲▼ button to select [ENLGE PHOTO ICON]. Then press the OK or ► button.

### 3. Press the ▲▼ button to select [ON].

### 4. Press the OK or ◀ button.

The setting of shooting icon enlargement is completed.

### 5. If the ◀ button was pressed in Step 4, press the MENU button.

These settings are used until they are changed the next time.





# Chapter 4

## Installing Software

Installing the Provided Software (For Windows)..	128
Installing the Provided Software (For Macintosh) .....	139

# Installing the Provided Software (For Windows)

You need to install software for transferring images to your computer before you can download images from the camera.



## Reference

For how to download images from the camera into your computer, see the Software User Guide available from the Caplio Software CD-ROM. For how to display the Software User Guide, see P.129.



## Caution

Be sure to install the software before you connect the camera to your computer with the cable.

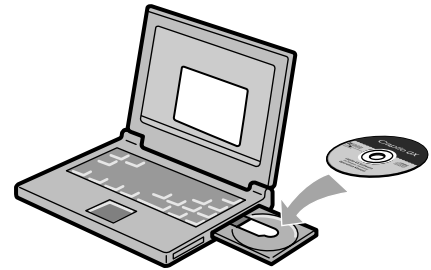

## Software that can be installed from the Caplio Software CD-ROM

Once you insert the Caplio Software CD-ROM in the CD-ROM drive, the following screen appears automatically:



Item Name	Description	(Refer to)
Install Caplio Software	Use this button to install software required for handling the camera and images.	P.131
View Software User Guide	Use this button to display the Software User Guide (PDF).	P.129
Browse CD-ROM	Use this button to display the list of files contained on the CD-ROM.	P.129

# When [Install CaplioSoftware ] is clicked: (P.131)

The following software will be installed:

Software	Windows		Description
	XP	98	
RICOH Gate La	<input type="radio"/>	<input type="radio"/>	Downloads images.
ImageMixer	<input type="radio"/>	<input type="radio"/>	Shot images can be displayed or edited and video CDs can be created. DirectX (see P.136) is necessary for handling movies.
USB Driver	<input type="radio"/>	<input type="radio"/>	Connects the camera to your computer.
WIA Driver	<input type="radio"/>	-	Downloads images.
Mounter	-	-	Connects the camera to your computer.
List Editor	<input type="radio"/>	<input type="radio"/>	Not used by this model but used by other models of Caplio camera.
Caplio Setting	<input type="radio"/>	<input type="radio"/>	
Caplio Server	<input type="radio"/>	<input type="radio"/>	

XP:Windows XP

98:Windows 98/98SE/Me/2000



## Reference

The camera is provided with software ImageMixer that allows you to display and edit images from your computer. For how to use ImageMixer, click the [?] button on the ImageMixer window and see the displayed manual. For more information on the ImageMixer, contact the Customer Support Center below. For the latest information about the ImageMixer, access the Web page of Pixela Co., Ltd. (<http://www.imagemixer.com>).

# When [View Software User Guide] is clicked:

The Software User Guide (PDF file) on the Caplio Software CD-ROM can be displayed on your computer screen. If you are a Windows user and have Acrobat Reader installed on your computer, simply double-click [View Software User Guide]. If not installed, Acrobat Reader should be installed (see P.135).

## Click [Browse CD-ROM].

You can check folders and files on the CD-ROM.

The CD-ROM contains not only the Caplio software but also the following software. These software products run on Windows.

For the installation of each software product, see the Reference page in the table below.

Software	Description	Refer to
Acrobat Reader	Required for viewing the Software User Guide.	P.135
DirectX	Necessary for playing movies by the ImageMixer.	P.136



## Reference

- For details about the Acrobat Reader, see Help for the Acrobat Reader.
- To install ImageMixer alone, double-click Setup.exe in the ImageMixer folder.

# System Requirements for Using the Provided Software

The following environments are necessary for using the provided software. Please check your computer, or the computer's user manual.

Operating Systems Supported	Windows 98/98 Second Edition
	Windows 2000 Professional
	Windows Me
	Windows XP Home Edition/Professional
CPU	Pentium 3: 500MHz or more
Memory	Windows 98/98SE: 128MB or more
	Windows 2000: 128MB or more
	Windows Me: 128MB or more
	Windows XP: 256MB or more
Hard drive space required for installation	Windows 98/98SE: 500MB or more
	Windows 2000: 500MB or more
	Windows Me: 500MB or more
	Windows XP: 500MB or more
Display resolution	800 x 600 pixels or greater
Display colors	65000 colors or greater
CD-ROM drive	A CD-ROM drive compatible with the above-mentioned computer body
USB port	A USB port compatible with the above-mentioned computer body



## Caution

- If your computer has an upgraded OS, the USB function may not work normally, so it cannot be supported.
- Problems may arise due to changes made to the OS, such as through patches or a service package release.
- The camera does not support connection to a USB port added by using an extension function (PCI bus or other).
- If used in conjunction with a hub or other USB devices, the software may not work properly.
- When dealing with movies and other large files, a larger memory environment is recommended.



## Reference

For how to download images to your computer using an SD Memory Card, see the Software User Guide.

# Installing the Software on Your Computer



## Caution

- Do not connect your camera to the computer until indicated. If you happened to connect your camera to the computer (resulting in the [Add New Hardware Wizard] screen appearing), simply click [Cancel], and after disconnecting your camera, install the software on your computer.
- If a message is displayed during installation to uninstall the old Caplio software before installing the new one, uninstall the old Caplio software once and install the new one again by following the message instructions. Even with the new Caplio software, however, the image downloading and other functions of the old model can still be used as before. (For how to uninstal the software, see P.137.)
- For Windows XP or Windows 2000, Administrator privileges are required to install the software.



## Note

Here is an example of the Windows XP screen.

### 1. Start your computer and insert the Caplio CD-ROM in the CD-ROM drive.

The screen shown on the right appears automatically.

### 2. Click [Install CaplioSoftware].

After a while, the [Select Setting Language] screen appears.

### 3. Confirm the language, and then click [OK].

After a few moments, the [Welcome to InstallShield Wizard] screen appears.

### 4. Click [Next].

After a few moments, the [Select Installation Destination] screen appears.

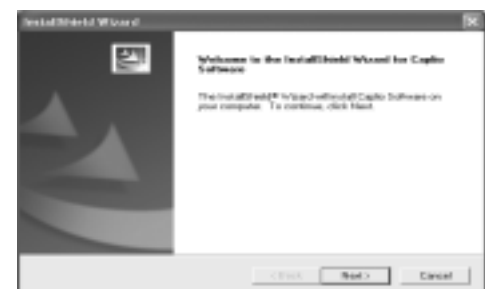

**5. Confirm where you want to install and then click [Next].**

The [Select Program Folder] screen appears.

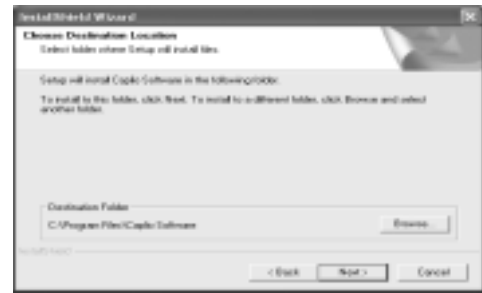

**6. Confirm where you want to install and then click [Next].**

Then the ImageMixer installer starts up successively.

**7. Click [Finish].**

**8. Restart your computer.**



 **Reference**

For how to remove (uninstall) the software, see P.137.

# Connecting the Camera to Your Computer

After installing the software on your computer, connect your camera to it.

1. **Make sure the camera power is off.**
2. **Connect the USB cable to the USB port of your computer.**

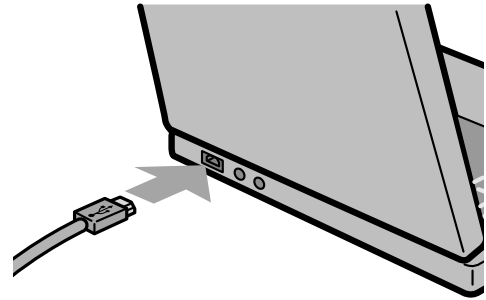

3. **Connect the USB cable to the USB terminal of your camera.**  
Your camera turns on.

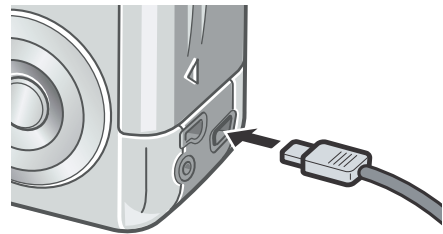

4

Installing Software

## For Windows XP

The first time you connect your camera to the computer using a USB cable, the [Found New Hardware Wizard] screen will appear.

1. **Select [Install the software automatically (Recommended)].**

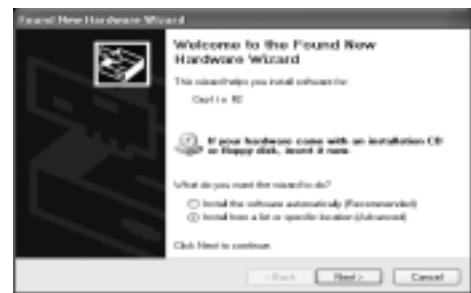

2. **Insert the Caplio Software CD-ROM into the CD-ROM drive on your computer.**

Installation of the WIA Driver automatically starts. If the CD-ROM is already on your computer when the [Found New Hardware Wizard] window is displayed, simply click [Next] to start installation.

## Note

By default, the WIA driver is installed in the following location:

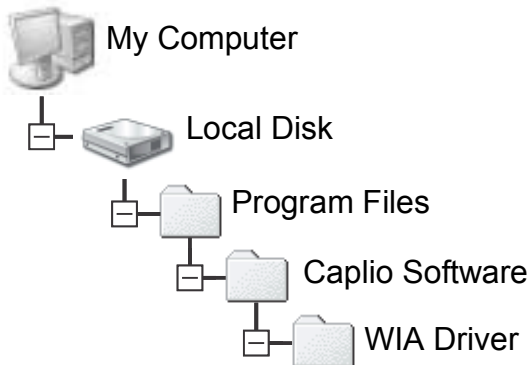

3. Select **[RICOH Gate La]**, check **[Always use this program for this action]** check box, and then click **[OK]**.

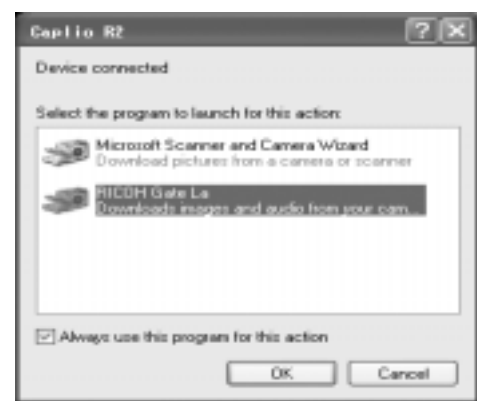

To load images from the camera with assistance from the Windows XP Scanner and Camera Wizard, select [Scanner and Camera Wizard]. Leaving the [Always use this program for this action] check box unchecked will cause the [Caplio R2] screen to be displayed each time you transfer images from the camera, thereby allowing you to choose whether to use RICOH Gate La or the Scanner and Camera Wizard for image transfers.

If your PC is installed with Windows XP Service Pack2 and a warning message is displayed, see P.151.

## Disconnecting the Camera from Your Computer:

1. Turn your camera off by pressing the power button.
2. Unplug the USB cable.

## Note

It is recommended that you use the AC Adapter (sold separately) when you are downloading images from your camera.



# Installing Acrobat Reader

Acrobat Reader is required to display the operation manual (PDF file).

If the computer is running under Windows, Acrobat Reader can be installed.

Acrobat Reader need not be installed if already installed on your computer.

## Caution

- Do not install the software when the camera is connected to your computer with a USB cable.
- For Windows XP or Windows 2000, Administrator privileges are required to install the software.

### **1. Start your computer, and insert the included Caplio Software CD-ROM into the CD-ROM drive.**

The following screen appears automatically.

### **2. Click [Browse CD-ROM].**

The files on the CD-ROM are listed.

### **3. Double-click the [Acrobat] folder.**

### **4. Double-click the [English] folder.**

### **5. Double-click [ar500enu] (ar500enu.exe).**

### **6. Install Acrobat Reader by following the messages displayed.**

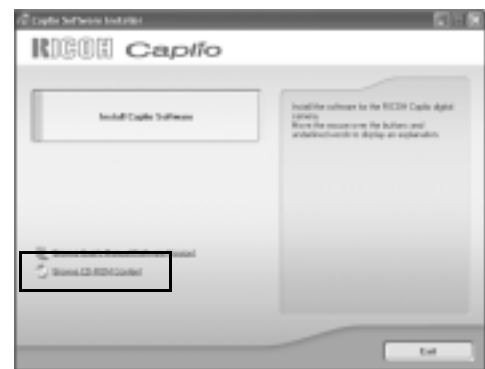

# Installing DirectX

---

DirectX is a program to play a movie file by the ImageMixer. This camera requires DirectX 8.1 or later to play movie files in Windows. If you have an earlier version installed, please install the updated version available on the accompanying CD-ROM. For Windows XP, installation of DirectX is not needed because the updated version is already installed.



## Caution

- Do not install the software when the camera is connected to your computer with a USB cable.
- For Windows XP or Windows 2000, Administrator privileges are required to install the software.

- 1. Start your computer, and insert the included Caplio Software CD-ROM into the CD-ROM drive.**
- 2. Click [Browse CD-ROM].**
- 3. Double-click the [DirectX] folder.**
- 4. Double-click the [English] folder.**
- 5. Double-click the following file:**

Windows98/98SE/Me	[DX81xxx.exe] in the [Win98Me] folder
Windows2000	[DX81NTxxx.exe] in the [Win2000] folder

# Uninstalling the Software

---



## Caution

- For Windows 2000/XP, Administrator privileges are required to uninstall the software.
- If any other program is active or unsaved data remains, save the data and terminate the program before uninstalling.

- 1. Click [Start] on the Windows task bar.**
  - 2. Select [Settings]-[Control Panel] ([Control Panel] for XP).**
  - 3. Double-click the [Add/Remove Programs] icon (or the [Add Or Remove Programs] icon in Windows XP).**
  - 4. Select [Caplio Software] and then click [Change/Remove].**
  - 5. Confirm file deletion and click [OK].**
- The [Shared File Detected] dialog box appears.
- 6. Select the [Don't display this message again.] check box, and then click [OK].**

The uninstallation process begins. When it is finished, close the displayed window.

# Uninstalling the ImageMixer

---



## Caution

- For Windows 2000/XP, Administrator privileges are required to uninstall the software.
- If any other program is active or unsaved data remains, save the data and terminate the program before uninstalling.

- 1. Click [Start] on the Windows task bar.**
- 2. Select [Settings]-[Control Panel] ([Control Panel] for XP).**
- 3. Double-click the [Add/Remove Programs] icon (or the [Add Or Remove Programs] icon in Windows XP).**
- 4. Select [ImageMixer] and then click [Change/Remove].**
- 5. Confirm file deletion and click [OK].**
- 6. Select the [Don't display this message again.] check box, and then click [OK].**

# Installing the Provided Software (For Macintosh)

You need to install software for transferring images to your computer before you can download images from the camera.



## Reference

For how to download images from the camera into your computer, see the Software User Guide available from the Caplio Software CD-ROM. For how to display the Software User Guide, see P.140.



## Caution

Be sure to install the software before you connect the camera to your computer with the cable.

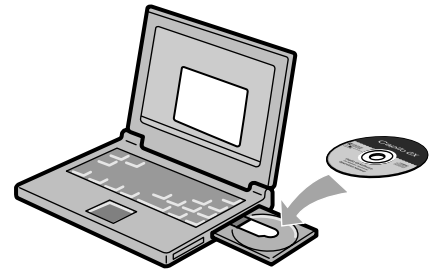

## Software that can be installed from the Caplio Software CD-ROM

Once you insert the Caplio Software CD-ROM in the CD-ROM drive, the following screen appears automatically:



Item Name	Description	(Refer to)
Install Caplio Software	Use this button to install software required for handling the camera and images.	P.142
View Software User Guide	Use this button to display the Software User Guide (PDF).	P.140
Browse CD-ROM	Use this button to display the list of files contained on the CD-ROM.	P.140

## When [Install CaplioSoftware ] is clicked:

The following software will be installed:

Software	Mac		Description
	9	X	
RICOH Gate La	<input type="radio"/>	-	Downloads images.
USB Driver	<input type="radio"/>	<input type="radio"/>	Connects the camera to your computer.
Mounter	<input type="radio"/>	<input type="radio"/>	Connects the camera to your computer.

9: Mac OS 8.6 to Mac OS 9.2.2

X: Mac OS X 10.1.2 to 10.3

## When [View Software User Guide] is clicked:

The Software User Guide (PDF file) on the Caplio Software CD-ROM can be displayed on your computer screen.

If not installed, Acrobat Reader should be installed.

## By clicking [Browse CD-ROM], ...

you can check folders and files on the CD-ROM.

# System Requirements for Using the Provided Software

The following environments are necessary for using the provided software.

Please check your computer, or the computer's user manual.

Operating System	Mac OS 8.6 to 9.2.2 / Mac OS X 10.1.2 to 10.3	
Macintosh	A USB port standard-equipped Apple Macintosh Series	
Internal Memory	Mac OS 8.6 to 9.2.2	96 MB or more (128 MB or more recommended)
	Mac OS X 10.1.2 to 10.3	128 MB or more (256 MB or more recommended)
Application Allocated Memory (For Mac OS 8.6 to 9.2.2)	Without using the compression utility, 16MB or more (24 MB or more is recommended) as Application Memory	
Hard Disc Drive Capacity	Mac OS 8.6 to 9.2.2	10 MB or more (at installation)
	Mac OS X 10.1.2 to 10.3	100 MB or more (at installation)
	100 MB or more (at operation)	
Display resolution	640 x 480 pixels or greater (800 x 600 or greater recommended)	
Display colors	256 colors or greater (32000 or greater recommended)	
CD-ROM drive	A CD-ROM drive compatible with the above-mentioned Macintosh machine	
USB port	A USB port compatible with the above-mentioned computer body	



## Caution

- Problems may arise due to changes made to the OS environment setting.
- Connection to a USB port retrofitted using an extended function (PCI bus, etc.) cannot be supported.
- If used in conjunction with a hub or other USB devices, the software may not work properly.



## Note

- When dealing with movies and other large files, a larger memory environment is recommended.
- For Mac OS 8.6 to 9.2.2, use a larger memory environment, as well as allocating extra application memory.
- While the software can be operated at 256 colors or more for the Display Color, it is strongly recommended that 32,000 or more be used.



## Reference

For how to download images to your computer using an SD Memory Card, see the Software User Guide.

# Installing the Software on Your Computer (Mac OS 8.6 to 9.2.2)

1. Turn on your Macintosh and insert the Caplio Software CD-ROM in the CD-ROM drive.
2. Select the OS 9 folder.  
The [Caplio Installer] icon appears.
3. Double-click [Caplio Installer].  
The "Caplio Installer" window opens.



Caplio Installer

4. Click [Install CaplioSoftware].
5. Click [OK].
6. Click [Install].

When installation finishes, a message appears to inform you that it is necessary to restart your Macintosh.



7. Click [Continue].

The software is installed and after a while the Installation Complete message appears.

8. Click [Restart].

Your Macintosh restarts.



## Note

### To remove (uninstall) the software:

To remove (uninstall) the software from your Macintosh, drag and drop the installed file into the Trash.

File Name	Folder Name
RICOH Gate La	System Folder: Control Panels
RICOH Gate La Prefs	System Folder: Preferences
Caplio Mounter	System Folder: Extensions
Caplio Mounter Prefs	System Folder: Preferences
Caplio USB Driver	System Folder: Extensions



# Installing the Software on Your Computer (Mac OS X 10.1.2 to 10.3)

1. Turn on your Macintosh and insert the Caplio CD-ROM in the CD-ROM drive.

2. Open the Mac OS X folder.

The [Caplio Mounter.pkg] icon appears.

3. Double-click [Caplio Mounter.pkg].

The Installer starts. A screen appears prompting you to enter the administrator's password.



Caplio Mounter

4. Click the key icon.

An authentication window appears.



5. Enter the administrator's name and password, and then click [OK].



6. Click [Continue].

The [Select a Destination] screen appears.



**7. Click the destination volume you want, and then click [Continue].**



**8. Click [Install].**

When installation finishes, a message appears to inform you that it is necessary to restart your Macintosh.

**9. Click [Continue Installation].**

The software is installed, and after a while an Installation Complete message appears.



**10. Click [Restart].**

Your Macintosh restarts.



## Note

**To remove (uninstall) the software:**

1. Start [Caplio Mounter] in [Applications] folder.
2. Select [Uninstall] in [File] menu.

The uninstallation process begins.

# Chapter 5

## Troubleshooting

Troubleshooting .....	146
Appendices .....	153

# Troubleshooting



## Troubleshooting the Camera

### Power Supply

Symptom	Cause	Remedy	Refer to
The power does not come on.	Batteries are not loaded. Or they are exhausted.	Load the batteries correctly. Recharge or use the AC Adapter.	P.20 P.21 P.155
	The battery is unacceptable.	Replace the battery with an acceptable one.	P.16
	The AC Adapter is not connected correctly.	Reconnect it properly.	P.155
	The camera is automatically turned off by Auto Power-off.	Slide the power switch to close the lens cover once (power-off) and slide it again to open (power-on).	P.24
The power cuts out during use.	The camera was left unattended and unused, so Auto Power-Off shut it off.	Slide the power switch to close the lens cover once (power-off) and slide it again to open (power-on).	P.24
	Batteries are running low.	If using alkaline batteries, replace the batteries with a new set. If using rechargeable batteries, recharge or use the AC Adapter.	P.16
	An unacceptable battery (manganese dry cell or other) is used.	Replace the battery with an acceptable one.	P.16
The power does not go off.	Camera malfunction.	Remove batteries once and load them again. Reconnect the AC adapter cable properly, if using.	P.20 P.21 P.155
Although the battery is new, a battery marking is displayed to indicate a low battery level. Although the battery is new, pressing the shutter release button retracts the lens. Although the battery is new, pressing the shutter release button turns the power off.	An unacceptable battery (manganese dry cell or other) is used.	Replace the battery with an acceptable one.	P.16
Cannot recharge the batteries.	Battery life.	Replace the batteries with a new set.	P.16
Batteries run out quickly.	They are being used in extreme high or low temperatures.	-	-
	Many shots are being taken in dark places inside, requiring flash.	-	-

# Shooting

Symptom	Cause	Remedy	Refer to
The camera does not shoot even if you press the shutter release button.	Batteries are not loaded. Or they are exhausted.	If using alkaline batteries, replace the batteries with a new set. If using rechargeable batteries, recharge or use the AC Adapter.	P.16 P.20 P.155
	The power is not on. The camera is not in Still Image, Movie, or Sound (Voice Memo) Mode.	Turn on the camera by sliding the power switch to open the lens cover. If the auto power-off function is enabled, the power may have been turned off automatically even when the lens cover is open. In that case, slide the power switch to close the lens cover once (power-off) and slide it again to open (power-on).	P.24
	The camera is in Playback Mode.	Set the mode selector to a shooting mode (Still Image Mode, Movie Mode, or Voice Mode) and press the Playback button.	P.31 P.32
	The shutter button is not pressed all the way.	Press the shutter button all the way.	P.31 P.32
	The Memory Card is not formatted.	Format the card.	P.108
	The Memory Card does not have any free space.	Load a new card, or delete unwanted files.	P.21 P.49
	End of Memory Card life.	Load a new memory card.	P.21
	The flash is recharging.	Wait until the flash lamp stops blinking.	P.38
	The SD Memory Card is "locked".	Release the "Lock (write-protection)".	P.19
	The SD Memory Card's contact surfaces are dirty.	Wipe off with a soft, dry cloth.	-
Failed to confirm the shot image.	The image confirmation time is too short.	Lengthen the image confirmation time.	P.115
Images do not appear on the LCD Monitor.	The power is not on. Or the LCD Monitor is dark.	Turn the power on. Or adjust the brightness of the LCD Monitor.	P.24 P.110
	The VIDEO/AV cable is connected.	Disconnect the VIDEO/AV cable.	P.47
	The screen display status is in [SYNCHRO-MONITOR MODE].	Press the DISP. button and switch display.	P.27
Although it is set to Auto Focus, it does not focus.	The lens or AF Window is dirty.	Wipe clean with a soft, dry cloth.	P.12
	The subject is not in the center of the shooting range.	Shoot with Focus Lock.	P.34
	It is a hard-to-focus subject.	Shoot with Focus Lock or Manual Focus.	P.34 P.62

Symptom	Cause	Remedy	Refer to
A picture is blurred.	You moved the camera when pressing the shutter release button.	Hold the camera with your elbows tight on your body. Or use a tripod.	P.29
	When shooting in a dark place (ex. indoor), the shutter speed slows down and pictures become easily blurred.	Use the flash. Or, raise the ISO sensitivity.	P.38 P.79
The flash does not fire. Or the flash cannot recharge.	Flashing is prohibited in the following statuses: - White Balance Bracket enabled - Continuous Shooting Mode - Movie Mode In some Scene Modes, flashing may be prohibited by default. (see P.156)	For shooting with the flash, change the settings or mode.	P.12 P.69 P.85 P.89 P.156
	The flash is set to Flash Off.	Deselect the Flash Off with the  button.	P.38
	Batteries are running low.	If using alkaline batteries, replace the batteries with a new set. If using rechargeable batteries, recharge or use the AC Adapter.	P.16
Even though the flash fired, the picture is dark.	The distance to the subject is greater than 2.1 meters in Telephoto or greater than 2.7 meters in Wide-angle.	Get closer to your subject and shoot.	P.38
	The subject is dark.	Correct exposure. (Exposure correction also changes the light quantity of the flash.)	P.76
The image is too bright.	The light quantity of the flash is not appropriate.	Move a little away from the subject or light up the subject for shooting without flashing.	P.38
	It is over-exposed.	Use exposure compensation. Cancel Exposure Time.	P.71 P.76
	The brightness of the LCD monitor is not appropriate.	Adjust the brightness of the LCD Monitor.	P.110
The image is too dark.	The shot was taken in a dark place while set to  (Flash Off).	Deselect the Flash Off with the  button.	P.38
	It is under-exposed.	Use exposure compensation. Set to Exposure Time.	P.71 P.76
	The brightness of the LCD monitor is not appropriate.	Adjust the brightness of the LCD Monitor.	P.110
The image lacks natural color.	The picture was shot in conditions that are hard for Auto White Balance to adjust to.	Add a white object to the composition. Or use a White Balance setting other than Auto.	P.77
The date, or recording information does not appear.	The screen display function is set to No Display.	Press the DISP. button and switch display.	P.27

Symptom	Cause	Remedy	Refer to
The brightness of the LCD Monitor changes during AF.	You are using it in a dark place or when Auto Focus range and surrounding brightness are different.	This is normal.	-
There is a vertical smear on the image.	This is a phenomenon that occurs when a bright subject is shot. It is called the smear phenomenon.	This is normal.	-

## Playback/Deleting

Symptom	Cause	Remedy	Refer to
Cannot Playback. Or the Playback screen does not come out.	The camera is not in Playback Mode.	Press the Playback button.	P.41
	The VIDEO/AV cable is not connected properly.	Reconnect it properly.	P.47
	The video format is set wrong.	Set to correct format.	P.119
The contents of SD Memory Card cannot be replayed. Or the Playback screen does not come out.	No memory card is loaded. Or a Memory Card with no stored images is loaded.	Load a card with stored images.	P.21
	You played back a Memory Card that was not formatted by this device.	Load a card that was formatted and stored on by this device.	P.21 P.108
	You played back a Memory Card that was not recorded normally.	Load a normally recorded card.	-
	The SD Memory Card's contact surfaces are dirty.	Wipe off with a soft, dry cloth.	-
	There is something wrong with the Memory Card.	Play another card and if there is nothing wrong with it, the camera is OK. There may be something wrong with the card, so do not use it.	-
An image disappeared.	Batteries are running low.	If using alkaline batteries, replace the batteries with a new set. If using rechargeable batteries, recharge or use the AC Adapter.	P.16
	The camera was left unattended and unused, so Auto Power-Off shut it off.	Turn the power back on.	P.24
Files cannot be deleted.	The file has been set to protect.	Release the protection.	P.96
	The SD Memory Card is "locked".	Release the "Lock (write-protection)".	P.19
Cannot format a Memory Card.	The SD Memory Card is "locked".	Release the "Lock (write-protection)".	P.19

## Other Problems

Symptom	Cause	Remedy	Refer to
Cannot load the Memory Card.	The card is facing the wrong way.	Load correctly.	P.21
Even when the camera's buttons are pressed, it does not operate.	Batteries are running low.	If using alkaline batteries, replace the batteries with a new set. If using rechargeable batteries, recharge or use the AC Adapter.	P.16 P.20 P.155
	Camera malfunction.	Slide the power switch to close the lens cover once (power-off) and slide it again to open (power-on).	P.24
		Remove batteries once and load them again. Reconnect the AC adapter cable properly, if using.	P.21 P.23 P.155
The date is wrong.	The correct date/time are not set.	Set the correct date/time.	P.117
The date set has disappeared.	The batteries were removed.	If the batteries are removed for about one week, the date setting will be lost. Make the settings again.	P.117
Auto Power-Off does not work.	Auto Power-Off is set to OFF.	Set the time for Auto Power-Off.	P.112
The beep does not sound.	The camera is set to silent.	Mute is set at [Volume Setting].	P.114
Images do not appear on the TV.	The video format is set wrong.	Set to correct format.	P.119
	The cable is not connected.	Reconnect the cable properly.	P.47
	The TV in/out switch is incorrectly set.	Check that the TV in/out switch is set correctly.	-



# Warning Messages Under Windows XP Service Pack 2

When software for Ricoh's digital camera is used on a PC with Windows XP Service Pack 2 installed, the following warning message may appear at software activation or USB connection.

With this in mind, refer to the following:

1. Check the information provided on the message screen to make sure that it comes from a reputable source, and then click the [Unblock] button.

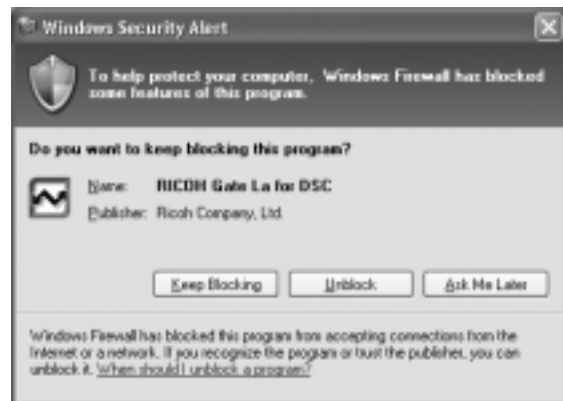

## Caution

If you do not recognize the program, you should block it because it may be a virus. Click the [Keep Blocking] button to prevent the program from connecting to the Internet.

## If you clicked the [Keep Blocking] button:

Follow the steps below to check to see the Windows Firewall settings.

1. Click [Start] and then [Control Panel].
2. Double-click [Windows Firewall].

If [Windows Firewall] is not displayed, click [Switch to Classic Display] at the upper left of the window.



Windows  
Firewall

3. Click the [Exceptions] tab.
4. Check that the software is in [Programs and Services].
5. Click the [Add Program] button to add software that uses the network.

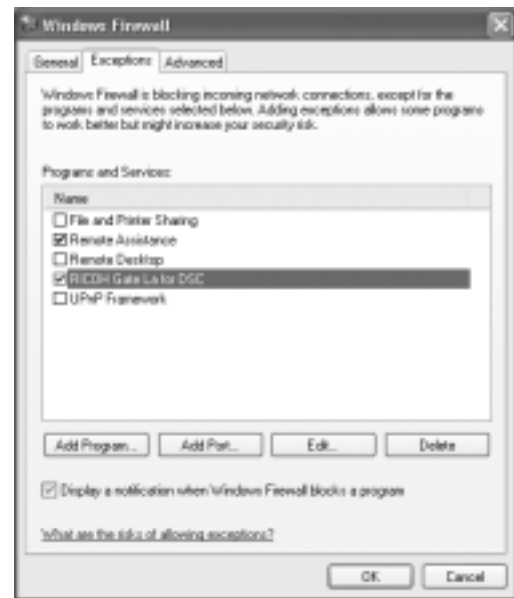

## If you clicked the [Ask Me Later] button:

Each time the program is activated, the [Critical Warning about Windows Security] window appears. Then you can select [Unblock].

# Appendices

## A. Specifications

---

### General

Video Signal Format	NTSC, PAL
Power Source Voltage	Rechargeable Battery (3.7 V) x 1 External Part (AC Adapter); 3.8 V
External Dimensions Weight	100.2mm (W) x 55.0mm (H) x 25.8mm (D) (excluding projecting parts)
Weight	Camera: Approximately 150 g (Excluding the battery, SD memory card, and strap) Accessories: Approximately 45g (Battery, SD memory card, and strap)
Operating Temperature Range	0 °C to 40 °C
Operating Humidity Range	85% or less
Storage Temperature Range	-20 °C to 60 °C

### Camera Parts

Image Pickup Used	Total 5.19 million pixels (effective pixels 5.02 million)
Lens	
• Lens	4.8 x Optical Zoom lens: F3.3 to 4.8
• Focal Length	F: 4.6 to 22.2 mm (35 mm equivalent, 28 to 135 mm)
• Shooting distance	Approximately 0.3 mm to $\infty$ from the front of the lens
• Macro shooting distance	Approximately 0.01 m to $\infty$ (Wide) or 0.13 m to $\infty$ (Tele) from the front of the lens
• Digital Zoom	3.6 times
Monitor Display Parts	
• Screen Size	2.5"
• Type	Transparent Amorphous Silicon TFT LCD
• Pixel Count	Approx. 114,000
• White Balance	AUTO/Fixed (Daylight, Overcast, Tungsten light, Tungsten light 2, Fluorescent light, One Push)
Exposure Adjustment	
• Light Metering Sensitivity Distribution	Multi Light Metering (256 segments), Center-weighted Light Metering, Spot Metering
• Exposure Compensation	Exposure Compensation +/-2.0EV (1/3EV Steps)
• Metering Method	TTL-CCD Metering Method
• Flash AE	Yes (In Daylight Synchro: On)

• Shutter	Still image: 8, 4, 2, 1 to 1/2000 seconds Movie: 1/30 to 1/2000 seconds
• ISO Sensitivity	AUTO, ISO64, ISO100, ISO200, ISO400, ISO800
Distance Control	
• AF Method	Normal Shooting: External Passive / CCD method; Macro: CCD method
• AF Measurement Range	Normal: approx. 0.3 m - infinity. Macro: approx. 0.01 m - infinity
Internal Flash	
• Method	Flashmatic
• Shooting Distance	Approx. 0.2 to 2.7 m (W), Approx. 0.13 to 2.1 m (T) (ISO:AUTO)
• Operating Modes	Flash Off/Forced flash/Auto/Slow synchro/Red-eye reduction
• Date Maintain Time	Approx. 1 week

## Image Data Record/Replay Part

### Pixels

• Still Images	2560 X 1920, 2048 X 1536, 1280 X 960, 640 X 480
• Text	2560 X 1920, 2048 X 1536
• Movies	320 X 240, 160 X 120

### File Formats

• Still Images	Compressed; JPEG (Exif Ver.2.21))
• Text	TIFF (MMR Method ITU-T.6)
• Movies	AVI (Open DML Motion JPEG Format Compliant)
• Sounds	WAV (Exif Ver.2.21 $\mu$ law)

Camera File System Standard DCF (DCF is an abbreviation for "Design rule for Camera File system", a JEITA standard)

Compression Format JPEG Baseline Format Compliant (Still, Movie)

### Image Size

• 2560 X 1920	N; approx. 1032 KB/Screen, F; approx. 1806 KB/ Screen
• 2048 X 1536	N; approx. 673 KB/Screen, F; approx. 1346 KB/ Screen
• 1280 X 960	N; approx. 326KB/Screen, F; approx. 626KB/ Screen
• 640 X 480	N; approx. 83KB/ Screen

## I/O Terminals

DC In	3.8 V (AC Adapter)
Video Out	1.0 Vp-p (75 $\Omega$ )

## Memory Cards that can Record, Playback

Memory Type	SD Memory Card, Multi-Media Card
-------------	----------------------------------

## B. Optional Accessories

The Caplio R2 can be used with the items (sold separately) listed below.

Item	Model	Remarks
AC Adapter	AC-4b	Used for power supply from a home outlet to the camera.
PC Card Adapter	FM-SD53	For when you want to load an SD Memory Card directly into your computer's PC Card Slot.
Rechargeable Battery	DB-50	Available for this camera.
Rechargeable Battery Set	BS-5	Includes the Rechargeable Battery (DB-50) and Battery Charger.

### Using the AC Adapter (sold separately)

When shooting or viewing still images for a long time, or when connecting to your computer, using the AC Adapter (sold separately) is recommended.

If you have already used this camera, make sure it is turned off before loading the AC Adapter Battery.

- 1. Open the battery/card cover.**
- 2. Insert the AC Adapter Battery.**
- 3. Open the power (DC input) cable cover and take the cable out.**
- 4. Close the battery/card cover and slide it back into place.**
- 5. Plug the power cord into an outlet.**

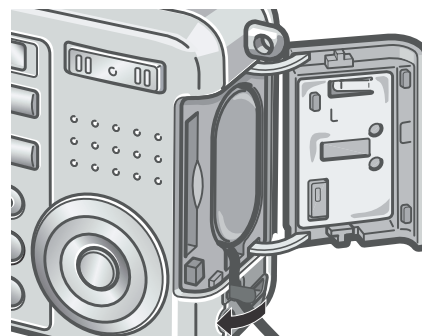
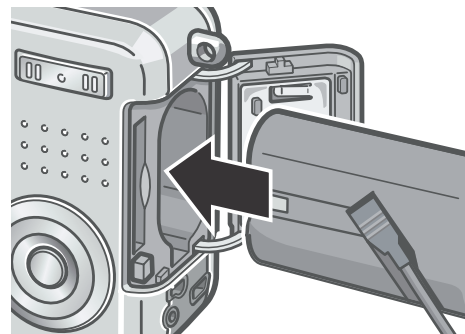

## Removing the AC Adapter

Make sure the camera is turned off before removing the AC Adapter.

1. **Unplug the power plug from the outlet.**
2. **Slide the battery/card cover toward the rear side to open it.**
3. **Remove the battery.**
4. **Close the battery/card cover and slide it back into place.**



### Caution

- Be sure to firmly attach cables and plug in cords.
- When you are not using the camera, unplug the AC Adapter from the camera and the power outlet.
- While in use, if you detach the AC Adapter or unplug it from the outlet, data may be lost.
- When using the AC Adapter, the battery level indication may not reach the full area.







## C. Combination of Scene Mode and Function

Depending on the Scene Mode, the way functions work may differ from when in normal shooting mode. Refer to the table below.







Mode Name	Flash	Macro Shooting
PORTRAIT	Initial setting: Flash Off	Disabled
SPORTS	Initial setting: Flash Off	Disabled
LANDSCAPE	Fixed on Flash Off	Disabled
NIGHTSCAPE	Forced flash is disabled	Disabled
	Initial setting: Auto	
TEXT MODE	Fixed on Flash Off	Enabled
HIGH SENSITIVITY	Fixed on Flash Off	Enabled

## D. Menu Items By Mode

### Shooting Menu (Movie Mode)

Setting	Option	Refer to
MOVIE SIZE	[320], 160	P.60
FRAME RATE	15 FPS, [30 FPS]	P.90
FOCUS	[AF], MF, SNAP, ∞	P.62
WHITE BALANCE	[AUTO],  (Daylight),  (Overcast),  (Tungsten light),  (Tungsten light 2),  (Fluorescent light),  (One Push)	P.77

### Shooting Menu (Scene Mode, except in Text Mode)

Setting	Option	Refer to
PIC QUALITY/SIZE	F2560, N2560, F2048, N2048, F1280,[N1280], N640	P.60
FOCUS	[AF], SNAP, ∞ (except in Landscape)	P.62
IMAGE WITH SOUND	ON, [OFF]	P.74
DATE IMPRINT	[OFF], DATE, TIME	P.75
EXPOSURE COMP.	-2.0 to +2.0	P.76
WHITE BALANCE	[AUTO],  (Daylight),  (Overcast),  (Tungsten light),  (Tungsten light 2),  (Fluorescent light),  (One Push)	P.77
SLOW SHUTTER LMT	[OFF], ON	P.80

### Shooting Menu (Text Mode)

Setting	Option	Refer to
DENSITY	DEEP, [NORMAL], LIGHT	P.82
SIZE	2560, [2048]	P.60
IMAGE WITH SOUND	ON, [OFF]	P.74
DATE IMPRINT	[OFF], DATE, TIME	P.75
SLOW SHUTTER LMT	[OFF], ON	P.80

## E. Functions Whose Defaults will be Restored upon Power-off

Power-off may reset some function settings to their defaults. The table below indicates whether or not the function will be reset to its defaults upon power-off.

Mode	Function	The current setting is kept:O, Restored:X
Setup	DATE SETTINGS	O
	AUTO POWER OFF	O
	BEEP SOUND	O
	SEQUENTIAL NO.	O
	LCD CONFIRM.	O
	VOL. SETTINGS	O
	LCD BRIGHTNESS	O
	LANGUAGE	O
	VIDEO OUT MODE	O
	ADJ. BUTT. SET.	O
	STEP ZOOM	O
	USB CONNECTION	O
	SHTG STGS WARNG.	O
	Shooting	CONT. MODE
EXPOSURE COMP.		O
WHITE BALANCE		O
COLOR DEPTH		O
PIC QUALITY/SIZE		O
FOCUS		O
PHOTOMETRY		O
ISO SETTING		O
SHARPNESS		O
AUTO BRACKET		X
TIME EXPOSURE		O
INTERVAL		X
DATE IMPRINT		O
IMAGE WITH SOUND		X
SELF-TIMER		X
FLASH		O
MACRO SHOOTING		X



Mode	Function	The current setting is kept:O, Restored:X
	DENSITY (Text Mode)	○
	SLOW SHUTTER LMT	○
	ENLGE PHOTO ICON	○
	MOVIE SIZE (Movie Mode)	○
	SIZE (Text Mode)	○
	Maximum brightness	○
Playback	VOLUME	○

## F. Number of Images That Can be Stored in Internal Memory/SD Memory Card

The following table shows the approximate number of images that can be recorded onto an SD memory card at various image size and picture quality settings.

Mode	Picture Quality	Image Size	IN	32MB	64MB	128MB	256MB	512MB	1GB
Still Image	F	2560 X 1920	14	15	31	63	126	255	491
	N	2560 X 1920	24	25	52	105	210	424	816
	F	2048 X 1536	19	20	41	83	166	334	643
	N	2048 X 1536	37	39	80	163	325	654	1259
	F	1280 X 960	36	38	79	159	318	641	1233
	N	1280 X 960	69	72	149	301	600	1209	2324
	N	640 X 480	300	315	645	1304	2600	5239	10072
TEXT MODE		2560 X 1920	37	39	80	163	325	654	1259
		2048 X 1536	69	72	149	301	600	1209	2325
Movie	15FPS 320 X 240		1 min 23 s	1 min 27 s	2 min 57 s	5 min 59 s	11 min 56 s	24 min 4 s	46 min 17 s
	30FPS 320 X 240		42 s	44 s	1 min 30 s	3 min 2 s	6 min 4 s	12 min 13 s	23 min 30 s
	15FPS 160 X 120		5 min 1 s	5 min 18 s	10 min 51 s	21 min 57 s	43 min 44 s	88 min 7 s	169 min 27 s
	30FPS 160 X 120		2 min 38 s	2 min 48 s	5 min 45 s	11 min 37 s	23 min 10 s	46 min 42 s	89 min 48 s
Sound (Voice Memo)			61 min 32 s	64 min 38 s	132 min 13 s	267 min 17 s	532 min 38 s	1073 min 11 s	2063 min 27 s



## Note

- The number of remaining shots displayed on the LCD monitor may differ from the actual number of shots, depending on the subject.
- The maximum number of pictures and other numeric values may be different even for cards of the same capacity if the manufacturer, type, or shooting conditions are different.
- The continuous shooting (recording) time depends on the card type, capacity, and performance.

## G. Using Your Camera Abroad

### AC Adapter (Model AC-4b)

Can be used in regions with a current of 120V, 50Hz/60Hz.

If you are going to travel to a country that uses a different shaped wall outlet/plug, please consult your travel agent on a plug adapter suitable for wall outlets in your country of destination.

### Warranty

This product is for domestic use. The warranty is only valid domestically.

Should the product fail or malfunction while you are abroad, the manufacturer assumes no responsibility for servicing the product locally or bearing the expenditure incurred therefore.

### Using Playback on Television in other Regions

Playback is possible on televisions (or monitors) equipped with a video input terminal. Please use the video cable provided.

This camera is compatible with both NTSC and PAL television formats. Switch the video format on the camera to match the television environment in the region.

When you go overseas, set your camera to the local video format.

## H. Cautions on Use

---

- This product is for domestic use. The warranty is only valid domestically.
- Should the product fail or malfunction while you are abroad, the manufacturer assumes no responsibility for servicing the product locally or bearing the expenditure incurred therefore.
- Be sure not to drop or apply any sudden force to the camera.
- Firing the flash consecutively may heat the firing unit. Do not fire it consecutively more than necessary.
- Do not fire the flash near eyes. It could cause visual impairment (particularly for infants).
- Do not fire the flash near the driver of a vehicle to avoid causing accidents.
- The batteries may become hot after extended use. Touching the batteries immediately after use could result in burns to your fingers.
- If the LCD monitor or panel is exposed to sunlight, they may become washed out and images may become hard to view.
- The LCD monitor and panel may contain some pixels that do not remain lit up continually in part or at all. Also, the brightness may become uneven because of the characteristics of LCDs. These are not failures.
- While you are carrying the camera, be careful not to hit it against other objects.
- In an environment where the temperature changes suddenly, condensation may occur in the camera, resulting in troubles such as fogging of the glass surface or malfunctions of the camera. If this occurs, place the camera in a bag to slow the temperature change as much as possible. Take it out of the bag after the temperature difference from the atmosphere has decreased to a fairly small amount.
- To avoid damaging the connectors, do not put any objects into the camera's microphone or speaker holes.



### Note

#### **Conditions in which condensation may easily occur:**

When the camera is moved to an environment where the temperature differs greatly.

- In humid places
- In a room immediately after being heated, or when the camera is exposed directly to cooled air from an air-conditioner or another similar appliance

# I. Care and Storage

---

## Care

- Please note that if fingerprints, dirt, etc. get onto the lens, picture quality will suffer.
- When dust or dirt does get on the lens, do not touch it directly with your fingers, and either use a blower (available in stores) to blow it off, or a soft cloth to gently dust it off.
- After use at the beach or around chemicals, wipe it off particularly carefully.
- In the unlikely event that your camera fails to work properly, please consult your Ricoh Repair Center.

There are high voltage circuits in this camera. As this is dangerous, do not dismantle this camera under any circumstances.

- Do not get volatile substances, such as thinner, benzene, or pesticides on your camera. This may cause a change in quality, paint to peel, etc.
- As the surface of the LCD Monitor is easily scratched, do not rub hard objects against it.
- Please clean the surface of the LCD Monitor with solvents available on the market specially for cleaning LCD display surfaces. Gently wipe with a soft cloth dampened with a little cleaner.

## Storage

- Please avoid storing your camera in the following kinds of places, as breakdown may result.
  - In high heat and humidity, or where there is severe change in temperature or humidity.
  - Places with a lot of dust, dirt or sand.
  - Places with severe vibration.
  - In places of direct contact with vinyl products, rubber or chemicals, such as insect repellent, etc.
  - Places with strong magnetic fields (monitors, next to strong magnets, etc.).
- If you are using a battery or batteries, remove them if you are not going to use the camera for a long period of time.

## Precautions regarding care of your camera

1. Be sure to turn the power off.
2. Remove the batteries or AC Adapter before caring for your camera.

## J. Error Messages

If an error message is displayed on the LCD Monitor, take the corresponding action.

Error Message	Cause and Action	Page
INSERT CARD	No card is loaded. Insert a card.	P.21
SET THE DATE ON THE SETUP MENU	The date is not set. Set the date.	P.117
FILE NUMBER OVER	The file number limit has been exceeded. Please use another card, or delete unwanted files.	P.116
UNMATCHED FILE	The camera cannot display this file. Check the file contents on your computer, and then delete the file.	-
INSUFFICIENT MEMORY. CONTINUE?	Because there is not sufficient capacity on the card, all the files cannot be copied. Use another card.	P.19
PROTECTED	You are trying to delete a protected file.	P.96
THE CARD IS WRITE-PROTECTED.	The card is "Locked (write-protection)". Unlock the card.	P.19
PRINT SETTINGS CANNOT BE SET FOR THIS FILE	This file (movies and other) cannot be selected for printing.	-
INSUFFICIENT MEMORY	Files cannot be stored. Make sure there is enough free space, or delete files.	P.49, P.108, P.109
	The image print number limit has been exceeded. Select an image and set the number to 0.	-
FORMAT INTERNAL MEMORY	It is necessary to format internal memory.	P.109
FORMAT CARD	The card is not formatted.Format the card.	P.108
CARD ERROR	Please reformat. If, after doing so, the error message still appears, the card may be faulty. Do not use the card.	P.108
WRITE TO CARD	Writing file to memory. Wait until writing finishes.	-
NO FILE	There are no files that can be played back.	-
CANNOT RECORD	The Number of remaining shots is 0. Switch to another card or internal memory.	-
INSUFFICIENT MEMORY CANNOT RECORD	Files cannot be stored. Make sure there is enough free space, or delete files.	P.49, P.108, P.109

## K. Warranty and Servicing

---

1. This product is backed by a limited warranty. During the warranty period mentioned in the Warranty supplied with your camera, any defective parts will be repaired free of charge. In the event of a camera malfunction, contact the dealer from which you purchased the camera or your nearest Ricoh service office. Please note that you will be not be reimbursed for the cost of bringing the camera to the Ricoh service office.
2. This warranty does not cover any damage resulting from:
  - 1) failure to follow the instructions in the instruction manual;
  - 2) repair, modification or overhaul not conducted by an authorized service center listed in the instruction manual;
  - 3) fire or natural disaster;
  - 4) improper storage, such as exposing the camera to high temperatures, humidity, or moth-balls; storing it with a leaking battery; storing the camera in a dirty condition so that it becomes moldy; or otherwise insufficiently caring for the camera;
  - 5) submergence; exposure to floods or spilled alcohol or other beverages; allowing sand or mud to enter the camera; exposure to physical shocks; or dropping the camera.
3. After the warranty period has passed, you will be liable for all repair fees, including those incurred at an authorized service center.
4. You will be liable for all repair fees, even within the warranty period, if the warranty card is not attached or if the distributor's name or the purchase date have been changed or are not indicated on the card.
5. Expenses for overhaul and thorough inspection by special request of the customer will be charged to the customer, whether or not they are incurred during the warranty period.
6. This warranty only applies to the camera and not to the accessories, such as the case and strap, nor does it apply to the battery and other consumables provided.
7. Any consequential damages arising from failure of the camera, such as expenses incurred in taking pictures or loss of expected profit, will not be reimbursed whether they occur during the warranty period or not.
8. The warranty is only valid domestically.
  - \*The above provisions refer to repairs offered free of charge, and do not limit your legal rights.
  - \*The intention of the above provisions is also described in the warranty card provided with this camera.
9. Parts essential to the servicing of the camera (that is, components required to maintain the functions and quality of the camera) will be available for a period of five years after the camera is discontinued.
10. Please note that if the camera is seriously damaged by flooding, submergence, infiltration of sand or mud, violent shocks or dropping, it may not be repairable, and restoration to its original condition may be impossible.



### Note

- Before sending the camera in for repair, check the battery and read the instruction manual again to ensure proper operation.
- Some repairs require a significant amount of time to be completed.
- When sending the camera to a service center, please include a note which describes the defective part and the problem as precisely as possible.
- Remove all accessories not related to the problem before sending the camera to the service center.
- Before taking any important pictures (such as at weddings, on trips abroad, etc.), test the camera to check operation and ensure proper functioning. We recommend that you keep this manual and spare battery on hand.
- This warranty does not apply to data stored on an SD Memory Card or in internal memory.

# INFORMATION TO THE USER

## USA FCC Part15 Class B

The equipment has been tested and found to comply with the limits for a Class B digital device, pursuant to part 15 of the FCC Rules. These limits are designed to provide reasonable protection against harmful interference in a residential installation. This equipment generates, uses, and can radiate radio frequency energy and if not installed and used in accordance with the instructions, may cause harmful interference to radio communications. However, there is no guarantee that interference will not occur in a particular installation. If this equipment does cause harmful interference to radio or television reception, which can be determined by turning the equipment off and on, then user is encouraged to try to correct the interference by one or more of the following measures:

- Reorient or relocate the receiving antenna.
- Increase the separation between the equipment and receiver.
- Connect the equipment to an outlet on a circuit different from that to which the receiver is connected.

• Consult the dealer or an experienced radio/TV technician for help. (FCC 15.105B)

Changes or modifications not expressly approved by the party responsible for compliance could void the user's authority to operate the equipment. (FCC 15.21)

Properly shielded and grounded cables and connectors must be used for connection to a host computer in order to comply with FCC emission limits. (FCC 15.27)

An AC adapter with a ferrite core must be used for RF interference suppression.

## COMPLIANCE INFORMATION STATEMENT

Product Name: DIGITAL CAMERA

Model Number: Caplio R2

This device complies with Part 15 of the FCC Rules.

Operation is subject to the following two conditions:

- (1) This device may cause harmful interference, and
- (2) This device must accept any interference received, including interference that may cause undesired operation.

RICOH CORPORATION

5 Dedrick Place, West Caldwell NJ, 07006 Tel.: 1-800-225-1899

## Note to Users in Canada

Note: This Class B digital apparatus complies with Canadian ICES-003

## Remarque Concernant les Utilisateurs au Canada

Avertissement: Cet appareil numerique de la classe Best conforme a la norme NMB-003 du Canada

IMPORTANT SAFETY INSTRUCTIONS-SAVE THESE INSTRUCTIONS

DANGER-TO REDUCE THE RISK OF FIRE OR ELECTRIC SHOCK, CAREFULLY FOLLOW THESE INSTRUCTIONS.



Declaration of Conformity

"The Product complies with the requirements of the EMC Directive 89/336/EEC."

# Index

---

## A

AC Adapter .....	11, 155
Acrobat Reader .....	129
ADJ BTN.SET. ....	111
ADJ. Button .....	57
Auto Bracket .....	68
AUTO POWER OFF .....	112
Auto Power Off .....	24
AV Cable .....	10, 47

## B

BEEP SOUND .....	113
Browse CD-ROM .....	129

## C

Caplio Software CD-ROM .....	11, 128, 139
CONT (Multi-Shot) .....	85
COPY TO CARD .....	103

## D

DATE IMPRINT .....	75
DENSITY .....	82
Digital Zoom .....	36
Direct Print .....	52
DirectX .....	129
DPOF .....	99

## E

Erasing .....	49
Error Message .....	163
EXPOSURE COMP. ....	76

## F

Flash .....	38
FOCUS .....	62
Focus-lock .....	34
FORMAT - CARD .....	108
FORMAT - INT. MEM. ....	109
Full-press .....	31

## G

Grid Guide .....	27
------------------	----

## H

Half-press .....	32
Handstrap .....	10
How to Hold the Camera .....	29

## I

Image Size .....	60
------------------	----

IMAGE WITH SOUND .....	74
INTERVAL .....	72
ISO SETTING .....	79

## L

LCD BRIGHTNESS .....	110
LCD CONFIRM. ....	115

## M

Macro-Mode .....	37
Magnifying Images .....	46
Mounter .....	129, 140
M (Memory-reversal) Multi-Shot .....	85

## N

Number of Images That Can be Stored in Internal Memory/SD Memory Card .....	159
---	-----

## P

Packing List .....	10
PHOTOMETRY .....	65
PIC QUALITY/SIZE .....	60
PictBridge .....	52
Picture Quality Mode .....	60
PROTECT .....	96

## R

Rechargeable Battery .....	10, 11
RESIZE .....	102
RESTORE DEFAULTS .....	81
RICOH Gate La .....	129, 140

## S

Scene .....	39
SD Memory Card .....	19
Self-timer .....	84
SEQUENTIAL NO. ....	116
Sharpness .....	66
Shooting Menu (Movie Mode) .....	157
SLIDE SHOW .....	95
SLOW SHUTTER LMT .....	80
Specifications .....	153
Synchro-Monitor Mode .....	27
S (Stream) Multi-Shot .....	85

## T

Thumbnail Display .....	45
TIME EXPOSURE .....	71
Trouble .....	146
Troubleshooting .....	146

## U

Uninstalling .....	137
--------------------	-----



USB Cable .....10  
USB Driver ..... 129, 140

## **V**

Voice Memo .....92

## **W**

Warranty and Servicing .....164

WAV file .....92

White Balance .....77

White Balance Bracket .....69

WIA Driver .....129

## **Z**

Zoom .....36



# Telephone Support Numbers in Europe

UK	(from within the UK)	02073 656 580
	(from outside of the UK)	+44 2073 656 580
Deutschland	(innerhalb Deutschlands)	06331 268 438
	(außerhalb Deutschlands)	+49 6331 268 438
France	(à partir de la France)	0800 91 4897
	(en dehors de la France)	+49 6331 268 409
Italia	(dall'Italia)	02 696 33 451
	(dall'estro)	+39 02 696 33 451
España	(desde España)	91 406 9148
	(desde fuera de España)	+34 91 406 9148
Nederland	(binnen Nederland)	0800 022 9494
	(vanuit het buitenland)	+49 6331 268 443

<http://www.service.ricohpmmc.com/>

# From environmental friendliness to environmental conservation and to environmental management

Ricoh is aggressively promoting environment-friendly activities and also environment conservation activities to solve the great subject of management as one of the citizens on our precious earth.





To reduce the environmental loads of digital cameras, Ricoh is also trying to solve the great subjects of "Saving energy by reducing power consumption" and "Reducing environment-affecting chemical substances contained in products."

## If a problem arises

First of all, see "Troubleshooting" in this manual. If the issues still persist, please contact a Ricoh office.

Ricoh Offices	
Ricoh Company, Ltd.	3-2-3, Shin-Yokohama Kohoku-ku, Yokohama-shi 222-8530, Japan <a href="http://www.ricoh.co.jp/r_dc">http://www.ricoh.co.jp/r_dc</a>
Ricoh Corporation	5 Dedrick Place West Caldwell, NJ 07006, USA 1-800-22RICOH <a href="http://www.ricoh-usa.com">http://www.ricoh-usa.com</a>
RICOH EUROPE B.V. (EPMCC)	Oberrather Straße 6, D-40472, Düsseldorf, Germany <a href="http://www.ricohpmmc.com">http://www.ricohpmmc.com</a>
RICOH UK LTD. (PMMC UK)	Ricoh House, 1 Plane Tree Crescent, Feltham, Middlesex, TW13 7HG, England
RICOH FRANCE S.A. (PMMC FRANCE)	383, Avenue du Général de Gaulle – BP 307-931-13 Clamart Cédex, France
RICOH ESPANA, S.A. (PMMC SPAIN)	Av. Litoral Mar, 12-14, 08005 Barcelona, Spain
RICOH EUROPE B.V. (PMMC BENELUX)	Koolhovenlaan 35, 1119 NB Schiphol-Rijk, The Netherlands
Ricoh Italia S.p.A. (PMMC ITALY)	via Ponchielli,3 20063 Cernusco S/N Milano Italy
RICOH HONG KONG LIMITED Personal Multimedia Products Center	21/F., Tai Yau Building, 181 Johnston Road, Wan Chai, Hong Kong
Ricoh Australia Pty. Ltd.	8 Rodborough Road Frenchs Forrest, N.S.W.2086 Australia <a href="http://www.ricoh.com.au">http://www.ricoh.com.au</a>
<b>About ImageMixer</b>	North America (Los Angeles): TEL: +1-213-341-0163 Europe (U.K.): TEL: +44-1489-564-764 Asia (Philippines): TEL: +63-2-438-0090 China: TEL: +86-21-5450-0391 Registration time: 9:00 - 17:00

Ricoh Company, Ltd.  
Minato-ku, Tokyo 107-8544, Japan  
2005 March

EN  GB  AE   
Printed in China



\* L 7 2 2 2 9 7 1 B \*

## Free Manuals Download Website

<http://myh66.com>

<http://usermanuals.us>

<http://www.somanuals.com>

<http://www.4manuals.cc>

<http://www.manual-lib.com>

<http://www.404manual.com>

<http://www.luxmanual.com>

<http://aubethermostatmanual.com>

Golf course search by state

<http://golfingnear.com>

Email search by domain

<http://emailbydomain.com>

Auto manuals search

<http://auto.somanuals.com>

TV manuals search

<http://tv.somanuals.com>