

Caplio 500SE

RICOH

Camera User Guide

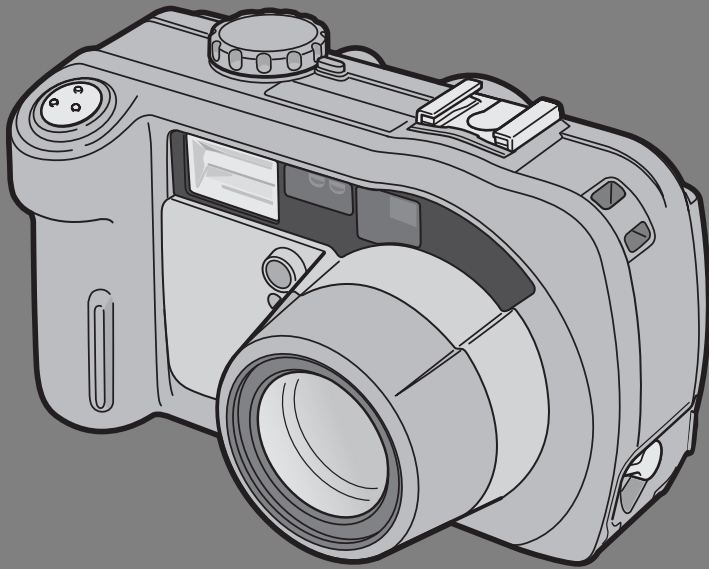

The serial number of this product is given on the bottom face of the camera.

Basic Operations

If you are using the camera for the first time, read this section.

This section provides a basic overview of how to turn on the camera, take pictures and play back pictures.

Advanced Operations

Read this section when you want to learn more about the different camera functions.

This section provides more detailed information about the functions used to take pictures and play back pictures, as well as information on how to customize the camera settings, print pictures, and use the camera with a computer.

Note

Do not connect the USB cable yet!

If you connect the camera to a computer through the USB cable before installing the provided software on the computer, the software required for connection between camera and computer may not be installed correctly. Be sure to connect the camera to your computer after installing the provided software. (P.128)

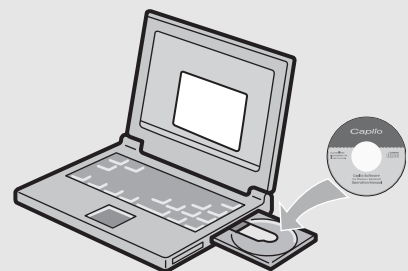

Preface

This manual provides information on how to use the shooting and playback functions of this product, as well as warnings on its use.

To make the best use of this product's functions, read this manual thoroughly before use. Please keep this manual handy for ease of reference.

Ricoh Co., Ltd.

Safety Precautions	For the safe use of your camera, be sure to read the safety precautions thoroughly.
Test Shooting	Please be sure to do some test shooting to make sure it is recording properly before normal use.
Copyright	Reproduction or alteration of copyrighted documents, magazines, music and other materials, other than for personal, home or similarly limited purposes, without the consent of the copyright holder is prohibited.
Exemption from Liability	Ricoh Co., Ltd. assumes no liability for failure to record or play back images caused by malfunction of this product.
Warranty	This product is manufactured to local specifications and the warranty is valid within the country of purchase. Should the product fail or malfunction while you are abroad, the manufacturer assumes no responsibility for servicing the product locally or bearing the expenditure incurred thereof.
Radio Interference	Operating this product in the vicinity of other electronic equipment may adversely affect the performance of both devices. In particular, operating the camera close to a radio or television may lead to interference. If interference occurs, follow the procedures below. <ul style="list-style-type: none">• Move the camera as far away as possible from the TV, radio or other device.• Reorient the TV or radio antenna.• Plug the devices into separate electrical outlets.

This publication may not be reproduced in whole or in part without the express written permission of Ricoh.
© 2006 RICOH CO., LTD. All rights reserved.

The contents of this document may be changed in the future, without prior notice.

This booklet was created with thorough attention to its content. If, however, you have a question, spot an error, or find a description lacking, please refer to the end of this booklet for information on how to contact us.

Microsoft, MS, Windows and DirectX are registered trademarks of Microsoft Corporation in the United States of America and other countries.

Macintosh, Power Macintosh, and Mac OS are registered trademarks of Apple Computer, Inc. in the United States of America and other countries.

Adobe and Adobe Acrobat are trademarks of Adobe Systems Incorporated.

All trademarked company and product names mentioned in this manual are the property of their respective owners.

Bluetooth® is a trademark owned by Bluetooth SIG, Inc. and licensed to Ricoh Co., Ltd.



Telephone Support Numbers in Europe

UK	(from within the UK)	02073 656 580
	(from outside of the UK)	+44 2073 656 580
Deutschland	(innerhalb Deutschlands)	06331 268 438
	(außerhalb Deutschlands)	+49 6331 268 438
France	(à partir de la France)	0800 91 4897
	(en dehors de la France)	+49 6331 268 409
Italia	(dall'Italia)	02 696 33 451
	(dall'estero)	+39 02 696 33 451
España	(desde España)	91 406 9148
	(desde fuera de España)	+34 91 406 9148

<http://www.service.ricohpmmc.com/>

Using the Manuals

The following two manuals are included with your Caplio 500SE.

	<p>“Camera User Guide” (This booklet)</p> <p>This guide explains the usage and functions of the camera. It also explains how to install the provided software on your computer.</p> <p>* The “Camera User Guide” (English edition) is available from the provided CD-ROM as a PDF file.</p>
	<p>“Software User Guide” (PDF file)</p> <p>This guide explains how to download images from the camera to your computer and display and edit them on your computer.</p> <p>* The “Software User Guide” is available in the following folders on the provided CD-ROM.</p> <p>Each language has its own “Software User Guide” in the respective folder.</p> <div style="display: flex; align-items: center;">  <div style="margin-left: 20px;"> <p>“Camera User Guide” (English edition) (PDF file)</p> </div> </div> <p>To copy the Software User Guide onto your hard disk, copy the PDF file from the above folder directly to your hard disk.</p>

The camera is provided with the ImageMixer software that allows you to display and edit images on your computer. For details on how to use ImageMixer, click the [?] button on the ImageMixer window and see the displayed manual.

For more information on ImageMixer, contact the Customer Support Center below.

North America (Los Angeles)	TEL: +1-213-341-0163
Europe (U.K.)	TEL: +44-1489-564-764
Asia (Philippines)	TEL: +63-2-438-0090
China	TEL: +86-21-5450-0391

Business hours: 9:00 AM to 5:00 PM

Key Features

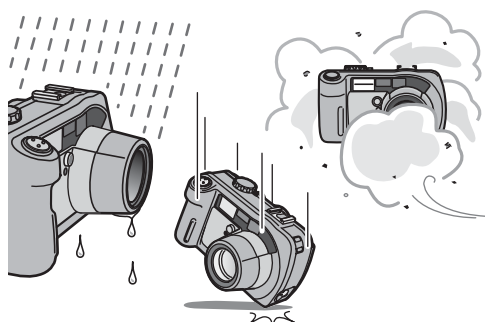

Rugged camera body stands up to water, dust and shocks

The camera body is water resistant (JIS protection grade 7, IEC IP67), dust resistant (JIS protection grade 6, IEC IP67) and shock resistant when dropped from a height of up to 1 meter.

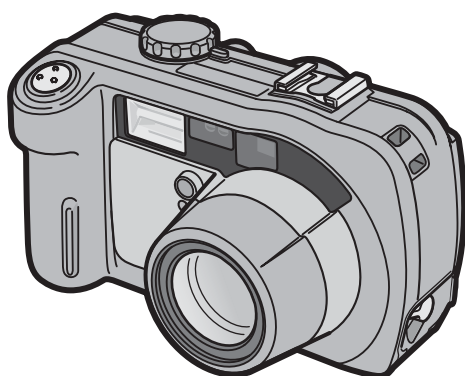

Wide-angle zoom lens can capture wide-angle pictures

The camera comes with a wide-angle optical zoom (3.0×) lens for a wide shooting range of between 28 mm and 85 mm*. Add the optional wide conversion lens to extend the shooting range to 22 mm* for even wider angle shooting.

*Equivalent to that on a 35mm camera

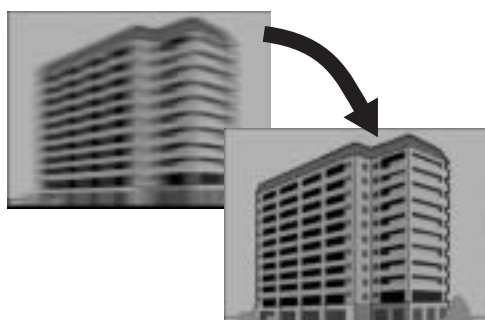

Antiblur function minimizes blurring (P.63)

Turn on the antiblur function to raise the ISO setting and minimize blurring when shooting.

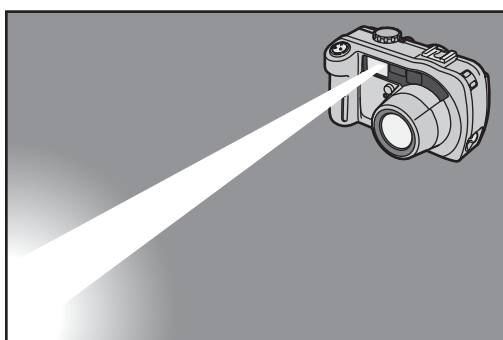

Built-in flash with a maximum range of 10 m (P.39)

The built-in flash has a maximum range of 10 m when used in wide-angle mode and 6.5 m when used in telephoto mode. This enables you to take a wider variety of pictures. You can also attach an external flash.

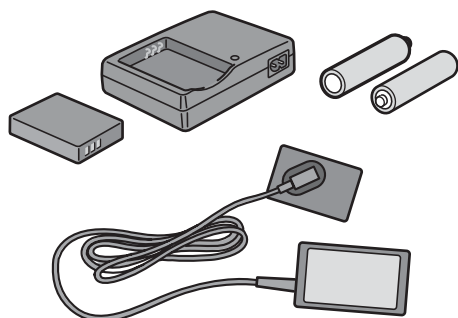

Power your camera in one of three ways (P.20)

You can power the camera using the optional rechargeable battery, AA alkaline or nickel-hydrogen batteries, or the optional AC adapter for convenient shooting anytime, anywhere.

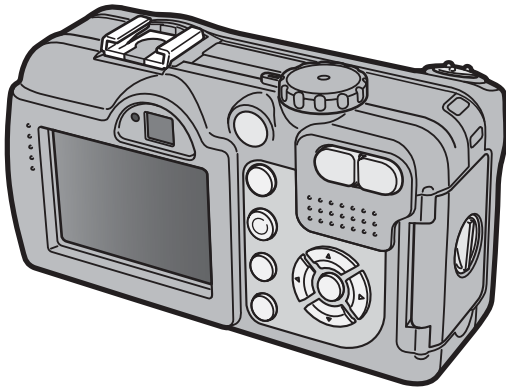

Large LCD monitor and optical viewfinder

Depending on the subject and shooting conditions, you can use either the 2.5-inch LCD monitor or the real optical viewfinder to compose your shots. Taken pictures can be viewed on the large, bright LCD monitor.

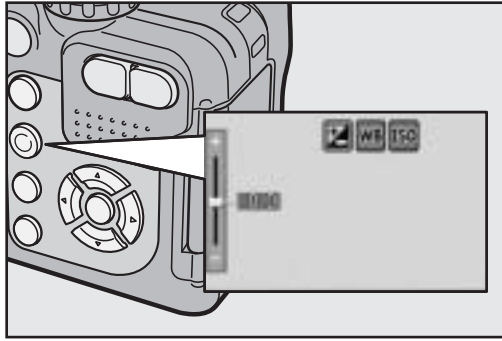

ADJ. (Adjust) button enables easier camera operations (P.56)

The ADJ. button simplifies the camera setting procedures. It allows you to make adjustments with minimum steps for settings, such as the exposure compensation and white balance. You can also assign a function as required.

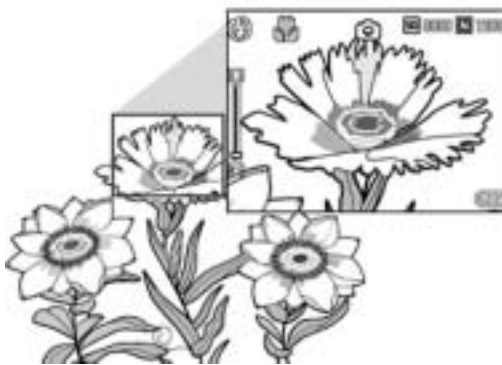

Take close-up shots 1 cm (5 mm from the very front of the camera) away (P.38)

The unsurpassed macro shooting function allows you to capture details from a very close distance at only approximately 1 cm (5 mm from the very front of the camera).



Skew correction mode helps straighten skewed images (P.40)

In skew correction mode, a rectangular object shot at an angle can be straightened to look as if it were shot squarely. With the simple touch of a button, you can straighten skewed images of objects such as a message board, a display panel, or a name card.



High sensitivity mode for shooting in dimly lit places (P.40)

The high sensitivity mode enables shooting in dark places. The LCD monitor becomes brighter, making it easier to compose the shot.

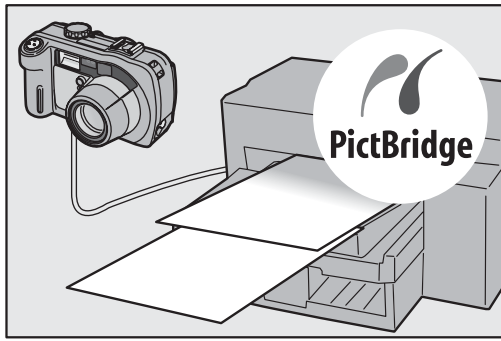

Direct printing without the use of a computer (P.98)

A Direct Print-compatible printer can be connected to the camera with the USB cable to directly transfer images to the printer. This allows for easy printing without using a computer.

You can also print reports and camera memos.



Camera memos enable easy sorting, searching and management of images

Load memo items preset with a computer and add them to shot still images. There are two types of camera memos: text and voice memos.

For details about camera memos, refer to the "Software User Guide" (PDF file P.24).

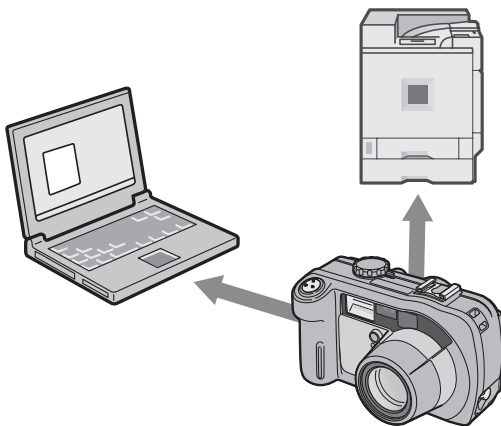

Bluetooth® function for wireless connectivity (P.154)

The integrated Bluetooth® function allows you to wirelessly send still images to a Bluetooth®-enabled computer and wirelessly print still images on a Bluetooth®-enabled printer.



Shoot with GPS information (P.180)

You can connect the camera to a Bluetooth®-enabled GPS receiver or external GPS module and shoot still images with latitude/longitude, position and distance information.

Shot images can be used with various GIS (Geographic Information System) applications.



Access point

Wireless LAN function (Only for Caplio 500SE-W) (P.191)

You can send images to wireless LAN-enabled computers. Send images as e-mail attachments or send them to the FTP server.

Contents

Using the Manuals	1
Key Features	2
Contents	5

Basic Operations

11

If you are using the camera for the first time, read this section.

Packing List	12
Names of Parts	14
How to Use the Mode Dial	16
LCD Monitor Display	17
Getting Ready	20
About the Battery	20
SD Memory Card (available in stores)	22
Charging the Rechargeable Battery (sold separately)	24
Loading the Battery and SD Memory Card	25
Using the AC Adapter (sold separately)	27
Turning the Power On/Off	29
Setting the Language	30
Setting the Date and Time	31
Basic Shooting	32
Holding the Camera	32
Shooting	34
Using the Zoom Function	37
Shooting Close-Ups (Macro Shooting)	38
Using the Flash	39
Shooting with Optimal Settings According to Shooting Conditions	40
Shooting in CALS Mode	44
☺ Using the Self-Timer	45
Playing Back Images	46
Reviewing the Image You Just Took (Quick Review)	46
Viewing Your Images	47
Three-frame View/List View (Thumbnail Display)	48
Magnifying Images	50
Deleting Files	51
Deleting a File	51
Deleting All Files	51
Deleting Multiple Files at One Time	52
Changing the Display with the DISP. Button	54
Maximizing the LCD Monitor Brightness	54

Read this section when you want to learn more about the different camera functions.

1 Various Shooting Functions 56

Using the ADJ. Button	56
Settings by Mode	56
Changing the Text Density (SCENE)	57
Shifting the AF Target (Macro)	58
Shooting Setting Menu	59
Using the Menu	60
Choosing Picture Quality Mode/Image Size (PIC QUALITY/SIZE)	61
Shooting with the Antiblur Function (ANTIBLUR)	63
Changing the Focusing Mode (FOCUS)	64
Manual Focus Shooting (MF)	65
Changing the Light Metering (PHOTOMETRY)	67
Changing the Edge Quality of Still Images (SHARPNESS)	68
Shooting with Multi-Shot (S-CONT/M-CONT)	69
Viewing an S-CONT or M-CONT Still Image in Enlarged Display Mode	71
Setting the Color Depth (COLOR DEPTH)	72
Using Long Time Exposure (TIME EXPOSURE)	73
Shooting Pictures Automatically at Set Intervals (INTERVAL)	74
Shooting a Still Image with Sound (IMAGE WITH SOUND)	76
Inserting the Date into a Still Image (DATE IMPRINT)	77
Changing the Exposure (EXPOSURE COMP.)	78
Using Natural and Artificial Lighting (WHITE BALANCE)	79
Setting the White Balance Manually (MANUAL SETTINGS)	80
Changing the Sensitivity (ISO SETTING)	81
Returning the Shooting Setting Menu Settings to their Defaults (RESTORE DEFAULTS)	82

2 Shooting/Playing Back Movies 83

 Shooting Movies	83
Setting the Frame Rate (FRAME RATE)	84
Playing Back Movies	85

3 Recording/Playing Back Sound 86

 Recording Sound	86
Playing Back Sound	87

4 Other Playback Functions 88

Playback Setting Menu.....	88
Using the Menu.....	88
Displaying Photos in Order Automatically (SLIDE SHOW)	89
Write-protecting Files (PROTECT).....	90
Protecting a File	90
Protecting All Files	91
Protecting Multiple Files at Once	92
Using a Printing Service (DPOF).....	93
Setting DPOF for the Displayed Still Image	93
Setting DPOF for All Still Images	94
Setting DPOF for Multiple Still Images.....	95
Changing the Image Size (RESIZE).....	96
Copying the Contents of the Internal Memory to an SD Memory Card (COPY TO CARD).....	97

5 Direct Printing 98

Direct Print Function.....	98
Connecting the Camera to a Printer	99
Printing Still Images.....	100
Printing One or All Still Images	100
Printing Several Still Images	102
Printing Reports	104
Printing a Camera Memo on a Report	105

6 Changing Camera Settings 106

SETUP Menu	106
Using the SETUP Menu	107
Preparing the SD Memory Card (FORMAT [CARD])	109
Formatting the Internal Memory (FORMAT [INT. MEM.].....	110
Adjusting the Brightness of the LCD Monitor (LCD BRIGHTNESS).....	111
Assigning a Function to the ADJ. Button (ADJ BTN. SET.).....	112
Changing the Auto Power Off Setting (AUTO POWER OFF) ...	113
Changing the Beep Sound Setting (BEEP SOUND)	114
Changing the Beep Sound Volume (VOL. SETTINGS).....	115
Changing Image Confirmation Time (LCD CONFIRM.)	116
Changing File Name Settings (SEQUENTIAL NO.)	117
Setting the Date and Time (DATE SETTINGS).....	119
Changing the Display Language (LANGUAGE/言語)	120
Changing the Step Zooming Setting (STEP ZOOM).....	121

Displaying a Settings Change Warning (SHTG STGS WARNG.).....	122
Changing the USB Setting (USB CONNECTION).....	123
Enlarging Icon Display (ENLGE PHOTO ICON)	125
Registering the Power-on Settings (REG. MY SETTINGS)	126
Changing the Startup Settings (START SETTINGS)	127

7 Downloading Images to Your Computer 128

For Windows	128
Using the Caplio Software CD-ROM.....	129
System Requirements for Using Caplio Software CD-ROM	133
Installing the Software Required for Handling the Camera and Images on Your Computer.....	134
Installing the DeskTopBinder Lite	136
Installing Other Software on Your Computer	138
Uninstalling the Software	140
For Macintosh.....	142
Using the Caplio Software CD-ROM.....	142
System Requirements for Using the Caplio Software CD-ROM	144
Installing the Software Required for Handling the Camera and Images on Your Computer (Mac OS 8.6 to 9.2.2).....	145
Installing the Software Required for Handling the Camera and Images on Your Computer (Mac OS X 10.1.2 to 10.4.6).....	146
Uninstalling the Software	148
Connecting the Camera to Your Computer	149
Using the Caplio Software to Download Images.....	150
Downloading Images in Mass Storage Mode.....	151
Disconnecting the Camera from Your Computer	153

8 Using the Bluetooth® Function 154

About the Bluetooth® Function	154
Expanded Settings Menu	155
Using the Expanded Settings Menu.....	155
Sending Still Images to a Printer (PRINT)	157
Printing One or All Still Images	157
Printing Several Still Images	159
Entering an Authentication Passkey for a Destination Device	162
Sending Still Images to Your Computer (FILE SEND)	166
Sending One or All Still Images	167
Sending Several Still Images	169
Sending Images in Shooting Mode (QUICK SEND MODE).....	171
Setting Up Quick Review Send (QUICK SEND MODE)	171
Using Quick Review Send	172

Making Advanced Bluetooth® Settings.....	175
Registering an Authentication Passkey for a Device (PASS KEY)	175
Changing the Number of Discoverable Devices (SEARCH COUNT) ...	176
Connecting to Several Devices at the Same Time (MASTER/SLAVE).....	177
Selecting the Size of Images to Be Sent (IMAGE FILE SIZE)	178
Automatically Deleting Sent Images (AUTO DEL)	179

9 Using the GPS Function 180

About the GPS Function.....	180
Obtaining GPS Information	181
Manually Connecting to a Device (BT SERIAL).....	181
Automatically Connecting to a Previously Connected Device (BT AUTO CONN)	183
Displaying GPS Information	185
LCD Monitor Display	186
Shooting with GPS Information	187
Playing Back a Still Image with GPS Information.....	187
Advanced GPS Information Settings	188
Setting the Datum (GPS DATUM).....	188
Setting the Display Standard (GPS DISP MODE)	189
Locking the GPS Information (GPS LOCK)	190

10 Using the Wireless LAN Function (Only for Caplio 500SE-W) 191

About the Wireless LAN Function	191
Overview of Transfer Process via a Wireless LAN	192
Selecting the Communication Method (CHANGE COM)	193
Making Advanced Wireless LAN Settings for Sending Files	194
Detailed Setups Tab Settings	196
Setting Up a Caplio-only FTP Server.....	199
Creating a Communication List and Transferring it to the Camera.....	202
Importing a Communication List from an SD Memory Card (READ COM SETTING)	205
Confirming and Editing the Destination Setting on the Camera.....	207
Sending Still Images, Movies, and Sound Files (FILE SEND).....	209
Sending One or All Files	210
Sending Several Files	212
Sending Files in Shooting Mode (Quick Review Send)	214
Setting Up Quick Review Send (QUICK SEND MODE)	214
Using Quick Review Send	215

Specifying a Destination on the Camera Beforehand	219
Hiding the [SEND TO] Screen (SEND CONDITION).....	219
Specifying a Destination (SEND TO)	220
11 Appendices	221
<hr/>	
Troubleshooting.....	221
Error Messages.....	221
Camera Troubleshooting	225
Software and Computer Troubleshooting	230
Specifications	232
Number of Images That Can be Stored in Internal Memory/ SD Memory Card	235
Optional Accessories.....	236
Using a Wide Conversion Lens.....	236
Using the External Flash	237
Functions Whose Defaults are Restored When Camera is Turned Off.....	238
About Scene Mode	240
Shooting Setting Menu Items by Scene Mode	240
Using Your Camera Abroad	241
Cautions on Use	242
Care and Storage	244
Warranty and Servicing	246
Index	250

Basic Operations

If you are using the camera for the first time, read this section.

Packing List	12
Names of Parts	14
How to Use the Mode Dial ...	16
LCD Monitor Display	17
Getting Ready	20
Basic Shooting	32
Playing Back Images	46
Deleting Files	51
Changing the Display with the DISP. Button.....	54

Packing List

Open the package and make sure all the items are included.

Caplio 500SE

The serial number of the camera is provided on the bottom face of the camera.

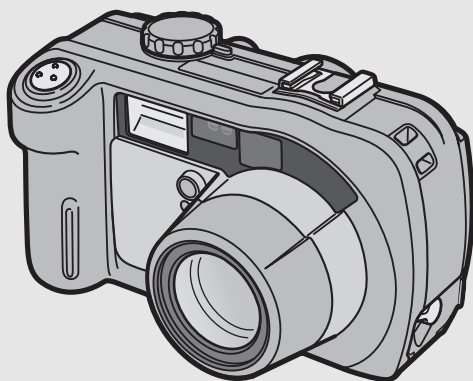

USB Cable

Used to connect the camera to a computer or Direct Print-compatible printer.

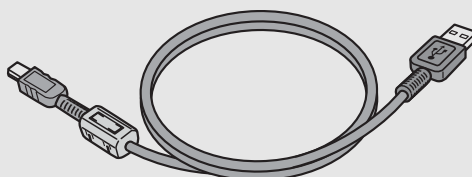

Neck Strap

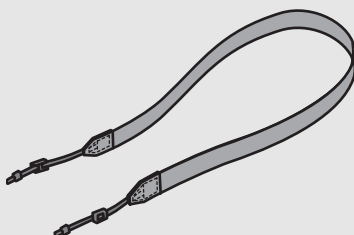

Note

Attaching the neck strap to the camera

Thread the small end of the strap through the strap eyelet on the camera and loop the ends as shown.

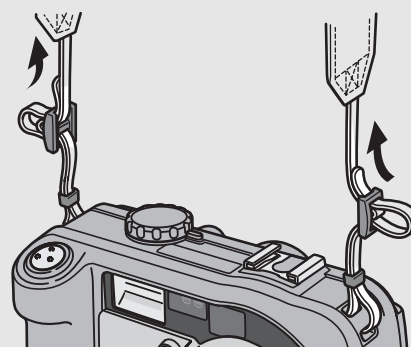

If you are using the camera for the first time, read this section.

Camera User Guide



(This booklet)

Warranty

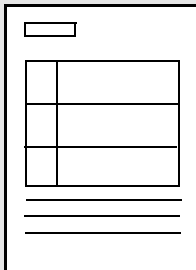

Safety Precautions



Caplio Software CD-ROM

The provided software and the “Software User Guide” are included on this CD-ROM.



Optional Accessories

AC Adapter (AC-4d)

Used for power supply from a household outlet to the camera. Use this adapter for long periods of playback or when transferring images to a computer.

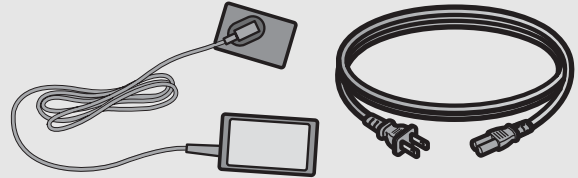

Rechargeable Battery (DB-43)

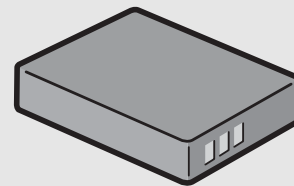

Battery Charger (BJ-2e)

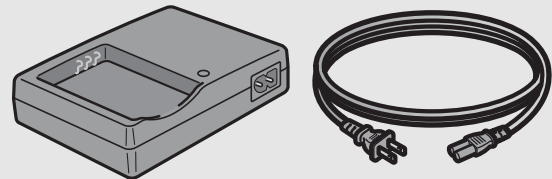

Wide Conversion Lens (DW-5)

Soft Case (SC-500)

Rechargeable Battery Set (BS-3e)

Includes the rechargeable battery (DB-43) and battery charger (BJ-2e).



Caution

Operations are not guaranteed when using a rechargeable battery or battery charger other than that specified in this manual.



Note

For the latest information about accessories, visit the Ricoh website at <http://www.ricohpmmc.com>.

If you are using the camera for the first time, read this section.

Names of Parts

Camera

Front View

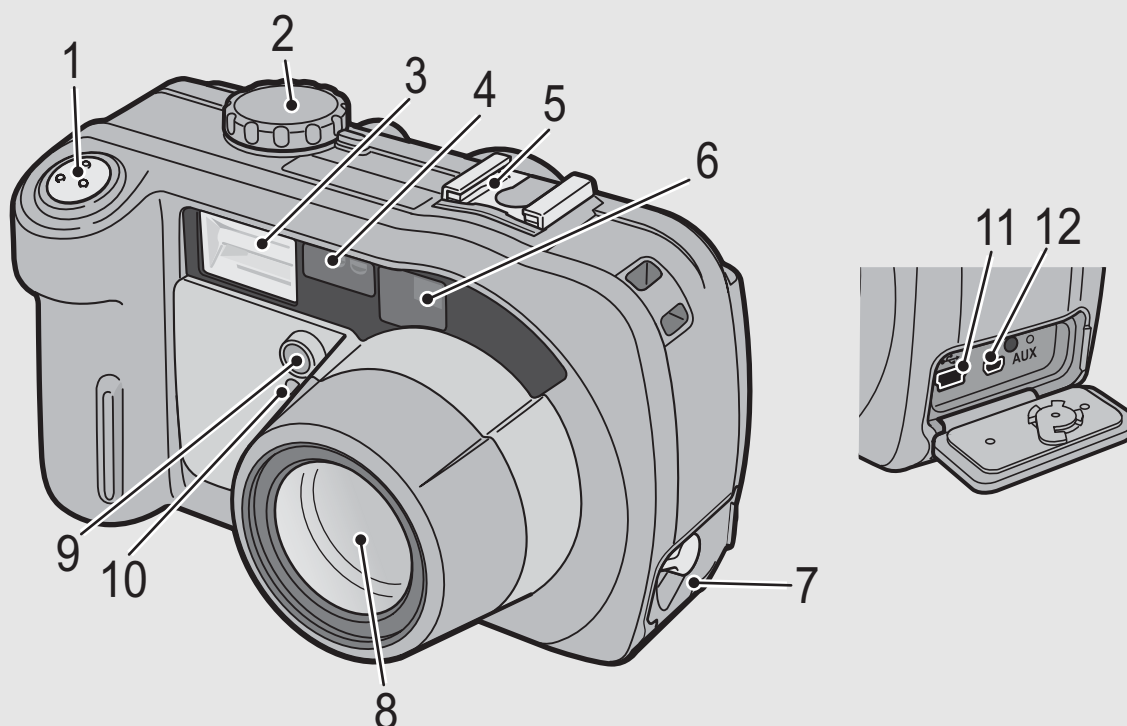

	Item Name	Refer to
1	Shutter Release Button	P.34
2	Mode Dial	P.16
3	Flash	P.39
4	AF Window	-
5	Accessory Shoe	P.237
6	Viewfinder	P.32
7	Terminal Cover	P.99, 149
8	Lens	P.32
9	Flash Compensation	-
10	AF Auxiliary Light	-
11	USB Terminal	P.99, 149
12	AUX Terminal	-

If you are using the camera for the first time, read this section.

Rear View

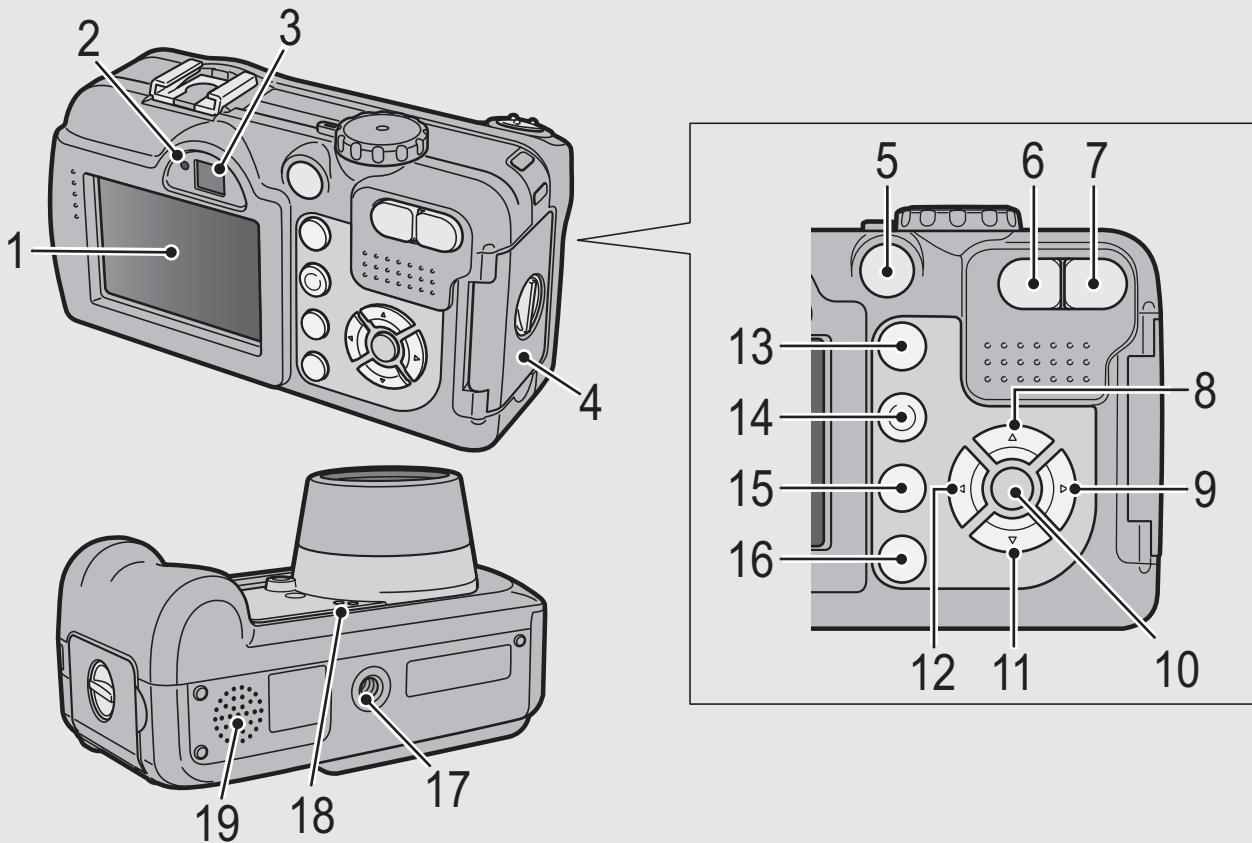

	Item Name	Refer to
1	LCD Monitor	P.17
2	Auto Focus/Flash Lamp	P.35, 39
3	Viewfinder	P.32
4	Battery/Card Cover	P.25, 27
5	Power Button	P.29
6	[⬆] (Wide-angle)/[🖼️] (Thumbnail Display) Button	P.37, 48
7	[⬇] (Telephoto)/[🔍] (Enlarged View) Button	P.37, 48
8	▲/SCENE Button	P.40
9	▶/⚡ (Flash) Button	P.39
10	MENU/OK Button	P.60, 88, 107
11	▼/🌸 (Macro) Button	P.38
12	◀/📺 (Quick Review) Button	P.46
13	▶ (Playback) Button	P.47
14	ADJ./MEMO Button	P.56
15	🗑️ (Delete)/⌚ (Self-timer) Button	P.51, 45
16	DISP. Button	P.54
17	Tripod Screw Hole	P.232
18	Microphone	P.86
19	Speaker	P.85, 87

If you are using the camera for the first time, read this section.



How to Use the Mode Dial

Turn the mode dial to the desired mode before shooting or recording.

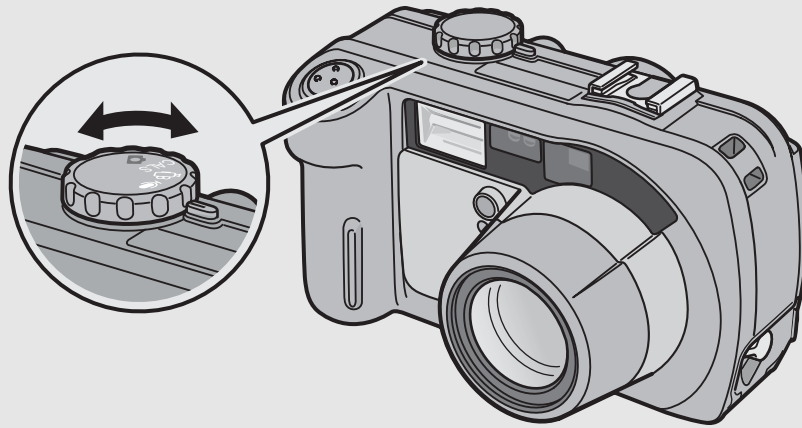
- 1** Turn the mode dial to the symbol of the function you want to use.



Mode Dial Symbols and Descriptions

Symbol	Function	Description
	Still Image Mode	Allows you to shoot still images.
CALS	CALS Mode	Fixes [PIC QUALITY/SIZE] to [N1280] when shooting construction images.
	Movie Mode	Allows you to shoot movies with sound.
	Voice Memo Mode	Allows you to record sounds.

If you are using the camera for the first time, read this section.

LCD Monitor Display

Example of LCD Monitor Display when Shooting Pictures

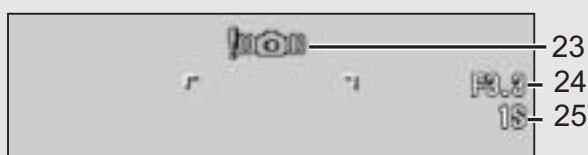
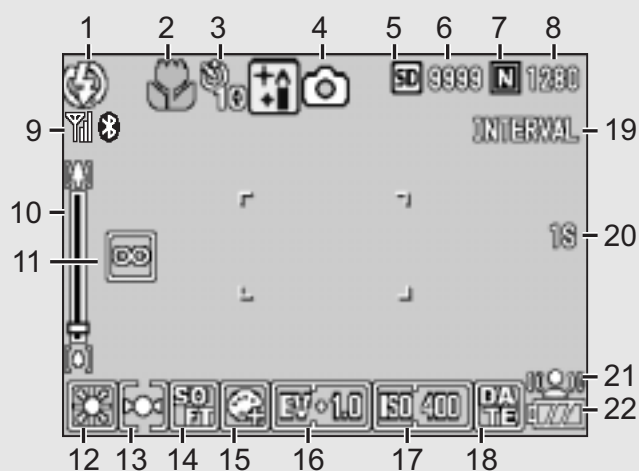

Still Image Mode

Movie Mode

	Item Name	Refer to		Item Name	Refer to
1	Flash	P.39	15	Color Depth	P.72
2	Macro Shooting	P.38	16	Exposure Compensation	P.78
3	Self-timer	P.45	17	ISO Setting	P.81
4	Mode Types	P.16, 40	18	Date Imprint	P.77
5	Recording Destination	P.22	19	Interval	P.74
6	Remaining Number of Still Images	P.235	20	Time Exposure	P.73
7	Picture Quality	P.61	21	Antiblur	P.63
8	Image Size	P.61	22	Battery Mark	P.19
9	Bluetooth® antenna, Wireless LAN antenna (Only for Caplio 500SE-W)	P.154 P.191	23	Camera Shake Warning Mark	P.33
10	Zoom Bar	P.37	24	Aperture Value	P.232
11	Focus	P.64	25	Shutter Speed	P.232
12	White Balance	P.79	26	Frame Rate	P.84
13	Photometry	P.67	27	Remaining Recording Time	P.235
14	Sharpness	P.68	28	Recording Time	P.235

If you are using the camera for the first time, read this section.



Note

- The number of remaining shots available may differ from the actual number of shots, depending on the subject.
- Movie and sound recording time and the maximum number of still pictures may vary depending on the capacity of the recording destination (internal memory or SD memory card), shooting conditions, and the type and manufacturer of the SD memory card.
- When the number of remaining shots is 10,000 or more, “9999” is displayed.

Example of LCD Monitor Display During Playback

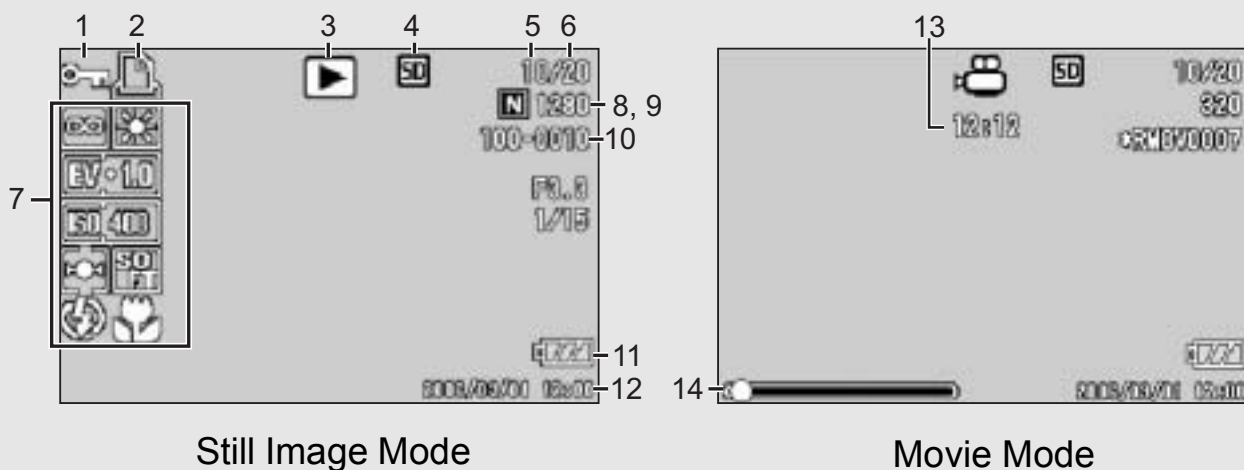

	Item Name	Refer to		Item Name	Refer to
1	Protect	P.90	8	Picture Quality	P.61
2	DPOF	P.93	9	Image Size	P.61
3	Mode Types	-	10	File No.	-
4	Playback Data Source	P.47	11	Battery Mark	P.19
5	Number of Playback Files	-	12	Date at Shooting	P.77 P.119
6	Total Number of Files	-	13	Recording Time or Lapsed Time	-
7	Setting at Shooting (Recording)	-	14	Indicator	-





Note

The LCD monitor may display messages to inform you of operational instructions or the camera’s status while in use.





Battery Level Indication

A battery mark appears at the lower right of the LCD monitor to indicate the battery level. Recharge the battery before it is depleted or exchange with new batteries.

Battery Mark	Description
 Green	The battery is sufficiently charged.
	The battery level begins to drop. Recharging is recommended. Recharging the battery or exchanging with new batteries is recommended.
	The battery level is low. Recharge the battery. Recharge the battery or exchange with new batteries.



Caution

- If you are using nickel-hydrogen batteries, depending on the type of batteries and usage conditions,  may not appear, or  or  may instantaneously appear. Check your batteries beforehand.
- If you are using the AC adapter,  may appear. This does not indicate malfunction and you can continue to use the camera.

If you are using the camera for the first time, read this section.

Getting Ready

Turn the power on and get ready to shoot.



Note

- If you have already used this camera, make sure it is turned off before inserting or removing the battery.
- For information on how to turn the camera off, see P.29.

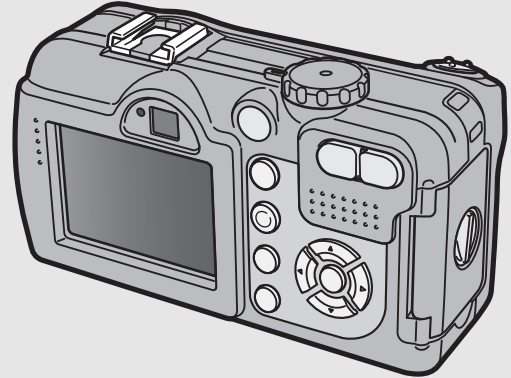

About the Battery

Rechargeable Battery DB-43 (optional)

This is a lithium-ion battery. It is economical because you can recharge it using the battery charger and use it over and over again. The battery lasts a long time, so it is convenient when traveling.

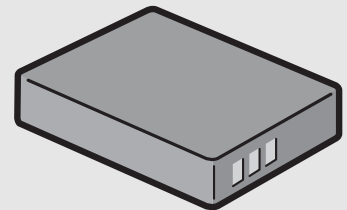

Note

The following types of batteries can also be used.

- **AA Alkaline Batteries (available in stores)**
You can obtain them anywhere, so they are convenient for travel. However, in a low-temperature environment the number of shots you can take will decrease. Warm the batteries before use. It is recommended that you use the rechargeable battery when using the camera for a long time.
- **Nickel-Hydrogen Batteries (available in stores)**
These batteries are economical because you can recharge and use them over and over again. Please use a battery recharger available in stores.

If you are using the camera for the first time, read this section.



Number of shots you can take -----

- Approximate number of shots you can take on a single charge

Battery Type	Number of Shots (Normal Mode)
Rechargeable Battery (DB-43)	approx. 400
AA Alkaline Batteries (available in stores)	approx. 80

- Based on CIPA standard (Temperature: 23 degrees Celsius, LCD monitor on, 30 seconds between shots, changing the zoom setting from telephoto to wide-angle or wide-angle to telephoto for each shot, 50% flash usage, turning the power off after each 10 shots).
- Set the camera to synchro-monitor mode to increase the number of shots you can take. (👉 P.54)
- The number of shots is for reference only. If the camera is used for long periods of time for setting and playback, the shooting time (the number of shots) will decrease.



Caution -----

- The nickel-hydrogen batteries available in stores are not factory-charged. Charge them before use.
- When using nickel-hydrogen batteries, use only those batteries that have been charged together. Do not mix different types of batteries.
- The nickel-hydrogen batteries may be inert and consequently may not supply power immediately after they are purchased or when left unused for more than a month. In such a case, recharge the batteries two or three times before use. The batteries self-discharge with time even if the camera is not used, so recharge them before use.
- The life of an AA alkaline battery depends on the brand and the storage time from the date of production. In addition, the life of an AA alkaline battery becomes shorter at low temperatures.
- Other batteries, such as manganese dry cell and Ni-Cd, cannot be used.
- The battery may become very hot immediately after operation. Turn the camera off and leave it to cool down sufficiently before removing the battery.
- Please remove the batteries if you are not going to use the camera for a long period of time.
- Use of the rechargeable battery (DB-43) is recommended when using the Bluetooth[®] function or wireless LAN function (only for Caplio 500SE-W).
- If you want to use a lithium-ion battery, use the rechargeable battery (DB-43) made exclusively for this camera. Do not use a rechargeable battery other than that specified by Ricoh.

If you are using the camera for the first time, read this section.

SD Memory Card (available in stores)

You can store still images you have taken either in the camera's internal memory or on an SD memory card (available in stores). The internal memory capacity is 26 MB. To record a lot of still images, movies or sounds at high resolutions, use a high-capacity SD memory card.

Where images are recorded-----
 When no SD memory card is loaded, the camera records images to the internal memory; when an SD memory card is loaded, it records images to the SD memory card.

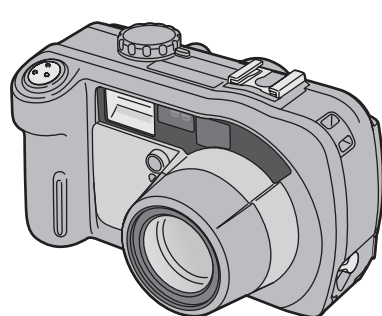
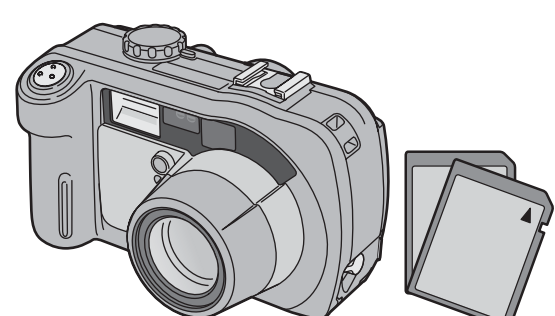
<p>When no SD memory card is loaded</p> 	<p>When an SD memory card is loaded</p> 
<p>Records to the internal memory</p>	<p>Records to the SD memory card</p>

Caution-----

- If an SD memory card is loaded, the camera will not record to the internal memory, even if the card is full.
- Take care not to get the contacts of the card dirty.

Write-protecting your images -----

Move the write-protection switch on the SD memory card to LOCK to prevent your still images from being accidentally erased or the card from being formatted. If you unlock the card (by returning the switch to its original position), it is once again possible to erase images and format the card. It is recommended to move the write-protection switch to LOCK when you have some important data recorded. Note that you cannot shoot images on a locked card because no data can be recorded to the card. Unlock the card before shooting.

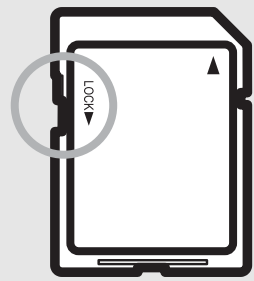



Note

- For information on switching between the SD memory card and internal memory during playback, see P.47.
- Movie and sound recording time and the maximum number of still pictures varies depending on the capacity of the SD memory card. (👉 P.235)
- Before using a new SD memory card, be sure to format it with this camera. (👉 P.109)
- When using an SD memory card previously used with another camera, be sure to back up any necessary data on the card before formatting it.
- An SD High-Capacity (SDHC) memory card cannot be used in this camera.

If you are using the camera for the first time, read this section.

Charging the Rechargeable Battery (sold separately)

The rechargeable battery needs to be charged before use.

If you are using the camera for the first time, read this section.

1 Insert the battery, making sure that the \oplus and \ominus markings on the battery match those on the battery charger.

- The battery label should face up.



Caution-----

Be careful not to reverse the \oplus and \ominus sides.

2 Connect the electrical power cord to the battery charger and then plug the power cord into an outlet.

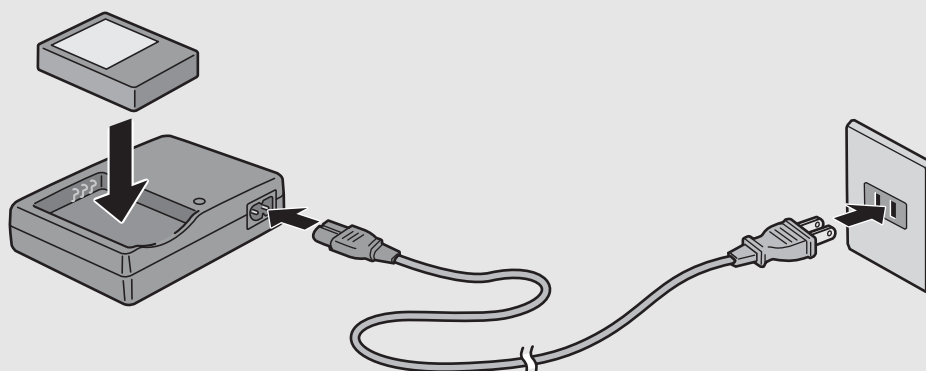

- Use the battery charger (BJ-2e) to recharge the battery.
- Charging starts, and the charger lamp indicates the progress, as shown below.

Once charging has finished, unplug the power cable from the power outlet.

Charger Lamp	Description
Lit red	Charging started
Lit green	Charging complete
Flashing	Battery charger or battery may be faulty (unplug the battery charger from the power outlet and remove the battery from the battery charger).

- Depending on the battery level, the charging time differs.

Rechargeable battery charging time	
DB-43	About 220 minutes (25 °C)

Loading the Battery and SD Memory Card

The rechargeable battery (DB-43) can be used to power this camera. This battery is convenient because the battery power lasts long and it can be used over and over again by recharging. If you have already used this camera, make sure it is turned off before loading the battery and card.

1 Turn the battery/card cover knob toward the  mark to open the cover.

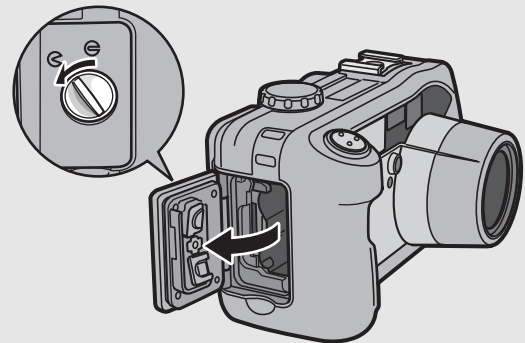

2 Make sure the SD memory card is facing the right way and then push the card all the way in until it clicks.

- The rechargeable battery may be inserted first.

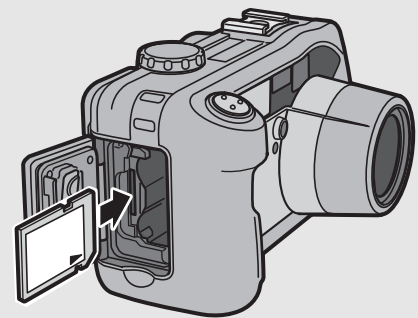

3 Insert the rechargeable battery.

- Lift the latch with the battery and insert the battery all the way into the battery compartment.
- When the rechargeable battery is loaded in place, it is locked with the latch.

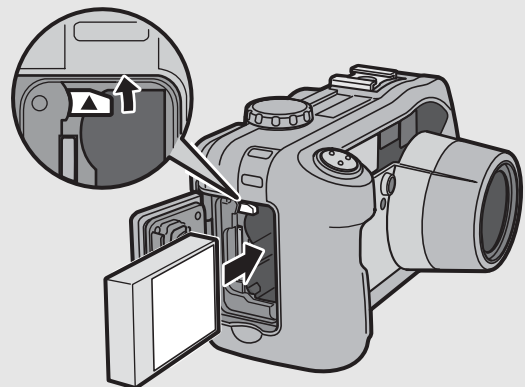

Loading AA alkaline batteries (available in stores)

- Insert the batteries in the direction shown.
- Insert the top battery while using the battery to lift the latch.

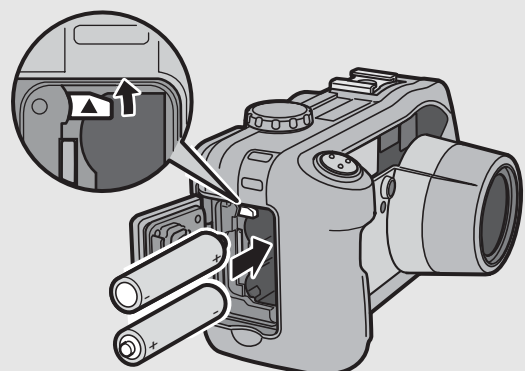

If you are using the camera for the first time, read this section.

4 Close the battery/card cover and turn the knob toward the ⊖ mark.

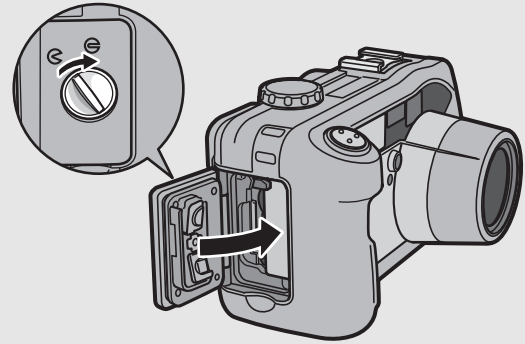

If you are using the camera for the first time, read this section.

Removing the SD Memory Card

Turn the battery/card cover knob toward the ⊖ mark to open the cover. Push in the SD memory card and gently release to eject it. Pull the card out of the camera.

Removing the Rechargeable Battery

Turn the battery/card cover knob toward the ⊖ mark to open the cover. Press and release the latch. The battery will be ejected. Pull the battery out of the camera. Be careful not to drop the battery when removing it from the camera.

Removing the AA Alkaline Batteries

Turn the battery/card cover knob toward the ⊖ mark to open the cover. Press and release the latch. The batteries will be ejected. Pull the batteries out of the camera. Be careful not to drop the AA alkaline batteries when removing them from the camera.





Caution

- Close the battery/card cover and terminal cover securely. Water and dust may get inside the camera.
- Before opening or closing the battery/card cover or terminal cover, be sure to remove any water, sand or mud adhering to the camera, and avoid opening and closing the cover in places where such contaminants may get inside the camera.
- Remove the batteries if you are not going to use the camera for a long period of time. Store the removed batteries in a dry cool place.
- Make sure that the rechargeable battery and SD memory card are facing the right way when inserted into the camera. Inserting the rechargeable battery or SD memory card in the wrong direction and forcing close the battery/card cover may damage the camera, rechargeable battery or SD memory card.

Using the AC Adapter (sold separately)

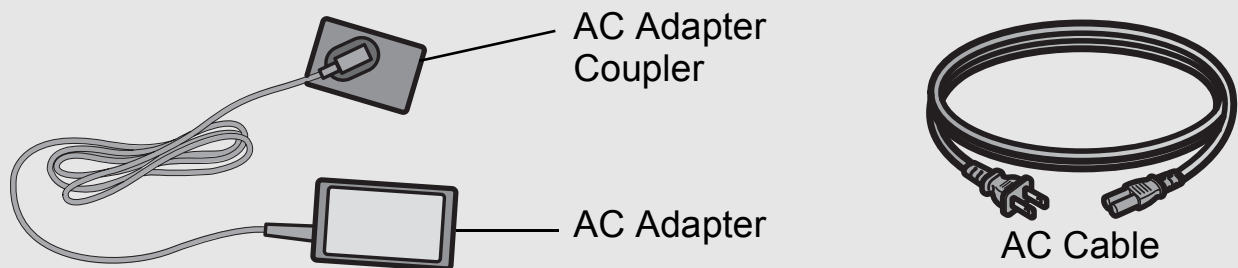
When shooting or viewing still images for a long time, or when connecting to your computer, use of the AC adapter (sold separately) is recommended. If you have already used this camera, make sure it is turned off before loading the AC adapter coupler.



1 Turn the battery/card cover knob toward the  mark to open the cover.

2 Lift the latch with the AC adapter coupler and insert the coupler all the way into the battery compartment.

- Insert the AC adapter coupler all the way in until the latch locks.

3 Connect the AC cable to the AC adapter and then plug the power cord into an outlet.

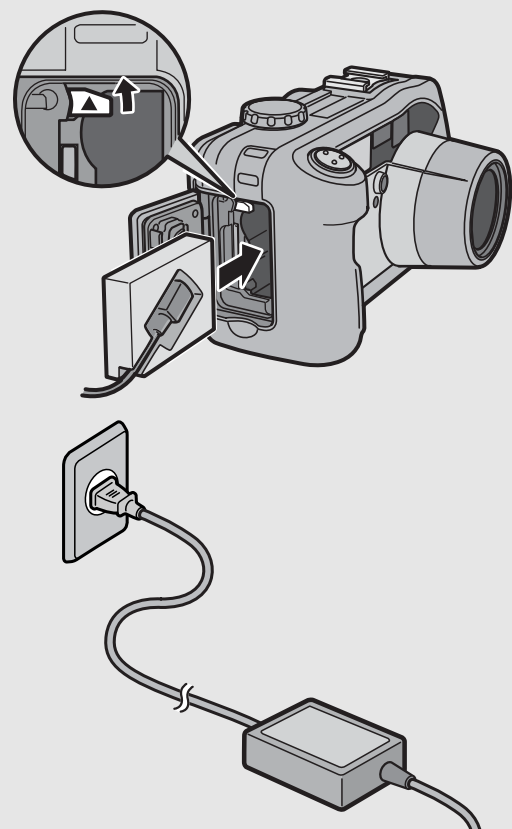

If you are using the camera for the first time, read this section.



Caution-----

- Be sure to attach the AC cable and plug the power cord into the outlet firmly.
- When you are not using the camera, unplug the AC adapter from the camera and the power outlet.
- While in use, if you detach the AC adapter or unplug the power plug from the outlet, data may be lost.
- Use the AC adapter with the battery/card cover open.
- When using the AC adapter, the battery level indication may not reach the full area.
- Do not use the AC adapter in a location where it may be exposed to water or lots of dust.

Disconnecting the AC Adapter

Make sure the camera is turned off before disconnecting the AC adapter.

1

Unplug the power plug from the outlet.

2

Press and release the latch. The AC adapter coupler will be ejected. Pull the coupler out of the camera.

3

Close the battery/card cover and turn the knob toward the ⊖ mark.



Caution-----

Before opening or closing the battery/card cover or terminal cover, be sure to remove any water, sand or mud adhering to the camera, and avoid opening and closing the cover in places where such contaminants may get inside the camera.

Turning the Power On/Off

To turn the power on:

1 Press the power button.

- After the start sound, the auto focus/flash lamp blinks for several seconds.

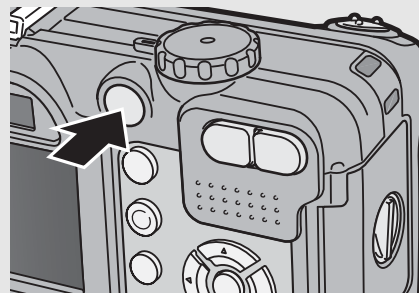

Using the Camera in Playback Mode

- Pressing the  (Playback) button for more than one second turns on the camera in playback mode, allowing you to start playback at once.

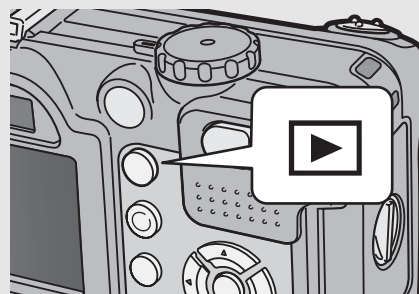

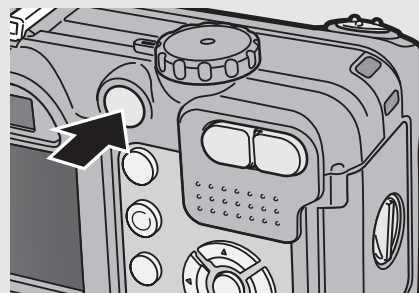

To turn the power off:

1 Press the power button.



Caution-----

- When the camera is turned on with the  (Playback) button, pressing the  (Playback) button again switches playback mode to recording mode.
- After the camera is turned on, it takes longer for the camera to become ready for shooting when using the flash than when not using the flash.



Auto Power Off-----

- If the camera goes unused for a set period of time, it will automatically turn itself off to save power. (Auto Power Off)
- The Auto Power Off setting can be changed. ( P.113)

If you are using the camera for the first time, read this section.

Setting the Language

When the power is turned on for the first time, the language setting screen appears (for the LCD monitor display language). After setting the language, go on to the date/time setting (for printing the date and time on your photos).

You can shoot without these settings. However, be sure to set the language, and the date/time later. Use the SETUP menu for these settings.

1 Turn the power on for the first time after purchase.

- The language selection screen appears.
- To skip language setting, press the MENU/OK button.

2 Press the ▲▼ buttons to select a language.

3 Press the MENU/OK button.

- The display language is set, and the date/time setting screen appears.

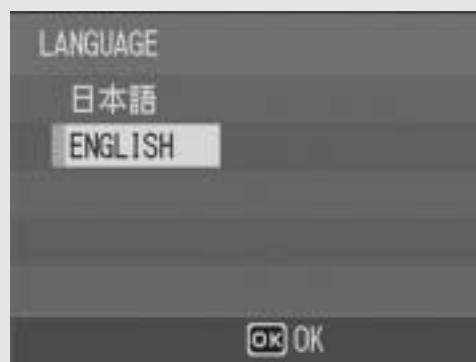

Note

For how to set the display language and date/time on the SETUP menu, see “Changing the Display Language (LANGUAGE/言語)” (P.120) and “Setting the Date and Time (DATE SETTINGS)” (P.119) in this guide.

Setting the Date and Time

When the power is turned on for the first time, the date/time setting screen appears.

1 Press the ▲▼◀▶ buttons to set the year, month, date and time.

- Change the value with ▲▼ and move the frame with ▶◀.

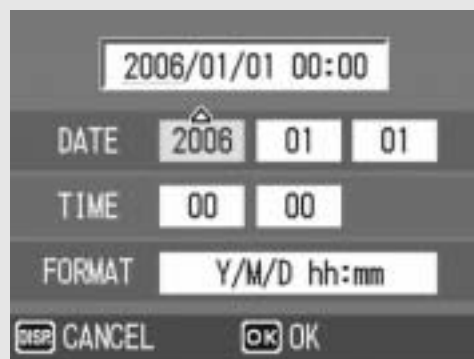

Setting at shipping

2 In [FORMAT], choose the date and time format.

- Select the date and time format with ▲▼.

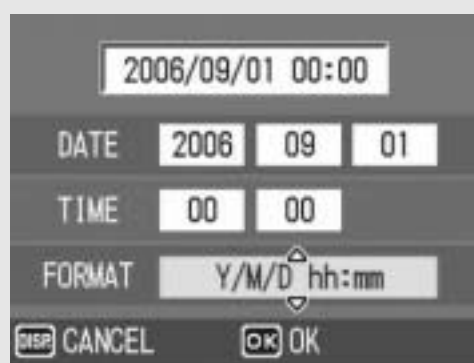

3 Check the display and then press the MENU/OK button.

- The date is set.
- Pressing the DISP. button on this screen allows you to cancel the setting.



Note

- If the battery is removed for more than one week, the date and time settings will be lost. These settings must be made again.
- To retain the date and time settings, load a battery with adequate remaining power for more than two hours.
- The set date and time can be changed later. (👉 P.119)
- The date and time can be inserted into images. (👉 P.77)

If you are using the camera for the first time, read this section.

Basic Shooting

Now you are ready.

Holding the Camera

Hold the camera as shown below for best results.

- 1** Hold the camera with both hands and lightly press both elbows against your body.

Shooting while viewing
the LCD monitor



Shooting while using
the viewfinder



- 2** Put your finger on the shutter release button.

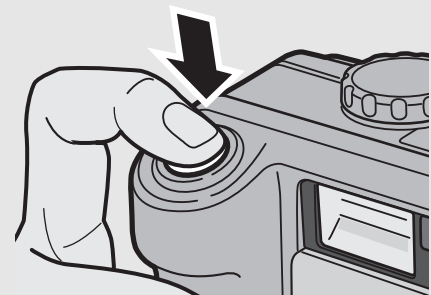

Caution

- When you are shooting, be careful not to obstruct the lens or flash with your fingers, hair, or the strap.
- Be careful not to obstruct the Bluetooth[®] antenna with your fingers when communicating. (👉 P.154)

If you are using the camera for the first time, read this section.



Preventing Camera Shake-----

If you move the camera when pressing the shutter release button, the still image might not come out clearly due to camera shake.

Camera shake tends to occur in the following cases:

- When shooting in a dark place without using the flash
- When using the zoom function
- When shooting using long time exposure (👉 P.73)

When the  mark appears on the LCD monitor, this indicates that camera shake may occur. To prevent camera shake, try any of the following.

- Using the antiblur function (👉 P.63)
- Set the flash to [AUTO] or [FLASH ON]. (👉 P.39)
- Raising the ISO setting (👉 P.81)
- Using the self-timer (👉 P.45)

If you are using the camera for the first time, read this section.

Shooting

The shutter release button works in two steps. You can press the shutter release button halfway down (half-press) and press it all the way down (full-press).

Quickly Shooting Pictures (Full-press)

Full-press the shutter release button for quick focusing, so as not to miss a shooting opportunity.

- 1** Press the power button to turn the camera on, and turn the mode dial to /CAL.S.

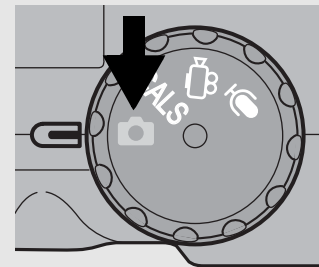

- 2** Compose your shot by looking at the LCD monitor or through the viewfinder, make sure the subject is centered, and gently press the shutter release button fully.

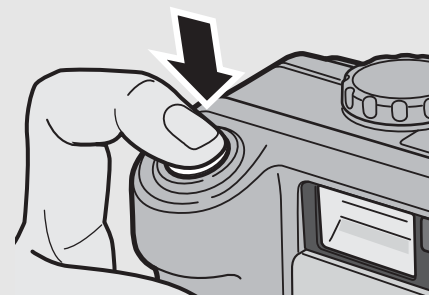

- The still image you have taken appears momentarily on the LCD monitor and is recorded to the internal memory or SD memory card.



Caution

Full-press is likely to cause the camera to shake. Hold the camera firmly with both hands and shoot.



Note

You can set the time the still image you have taken appears on the LCD monitor. You can also set the image not to appear after it is taken. (👉 P.116)

If you are using the camera for the first time, read this section.

Checking the Focus and Shooting (Half-press/Focus Lock)

When you press the shutter release button halfway (Half-press), the auto-focus function is triggered to determine the focal distance. Next, press it all the way down (Full-press) to shoot. When your subject is not in the center of your composition, compose your photo after focusing. (Focus Lock)

- 1** Press the power button to turn the camera on, and turn the mode dial to /CAL.S.

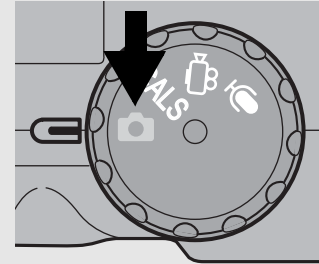

- 2** Put the subject of your photo in the center of the screen and press the shutter release button halfway.

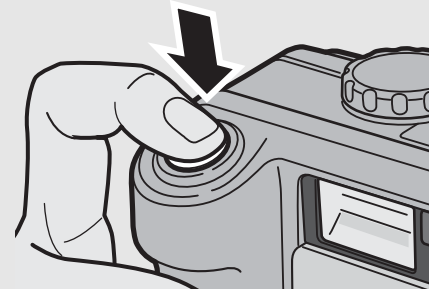

- The camera focuses on the subject and the exposure is fixed.
- If automatic focusing fails, the frame in the center of the LCD monitor turns red and the auto focus/flash lamp in the upper right of the LCD monitor blinks in green.
- The focal distance is measured at a maximum of five points. Green frames appear to indicate the positions that are in focus.

Auto Focus/Flash Lamp

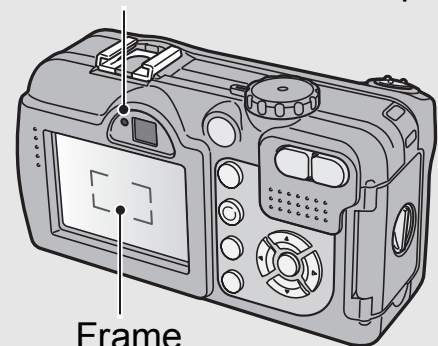

Frame

If you are using the camera for the first time, read this section.

3 To take a picture with the subject in the foreground in focus against a background, half-press the shutter release button to focus on the subject, and then compose your shot.

Subject to be focused on

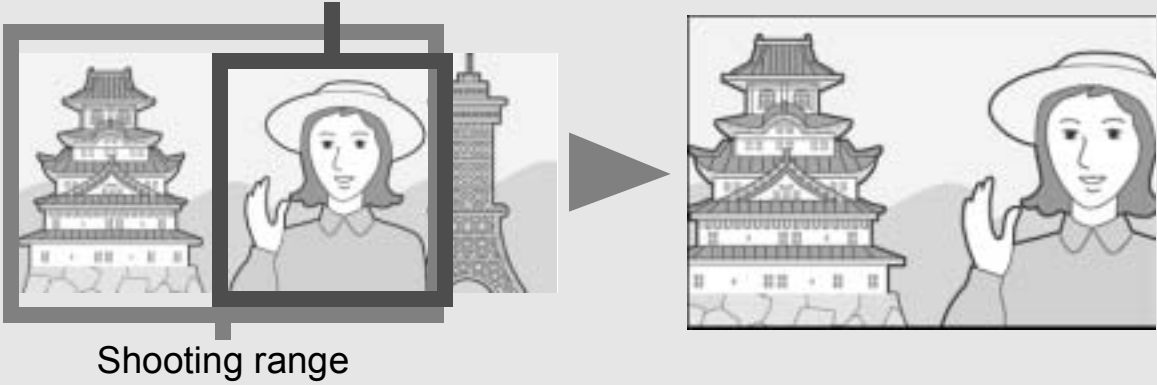

4 Gently press the shutter release button all the way.

- The still image you have taken appears momentarily on the LCD monitor and is recorded to the internal memory or SD memory card.

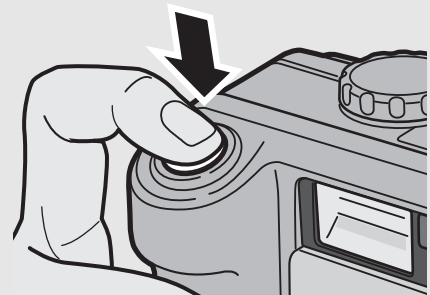



Focusing-----

The frame in the center of the LCD monitor and the auto focus/flash lamp indicate whether the subject is in or out of focus.

Focus Status	Frame Color	Auto Focus/Flash Lamp
Before focusing	White	Off
Subject in focus	Green	On (green)
Subject not in focus	Blinks (red)	Blinks (green)



Note -----

- Press the shutter release button gently to prevent camera shake.
- The  mark indicates that camera shake may occur. Hold the camera still and focus the camera again. You can also turn on the antiblur function to minimize blurring. ( P.63)
- The flash fires twice to increase the AE/AF (Auto Exposure/Auto Focus) accuracy.

Using the Zoom Function

Pressing the [▲] (Wide-angle) button allows you to take a wide-angle picture. Pressing the [▼] (Telephoto) button allows you to take a close-up picture of the subject.

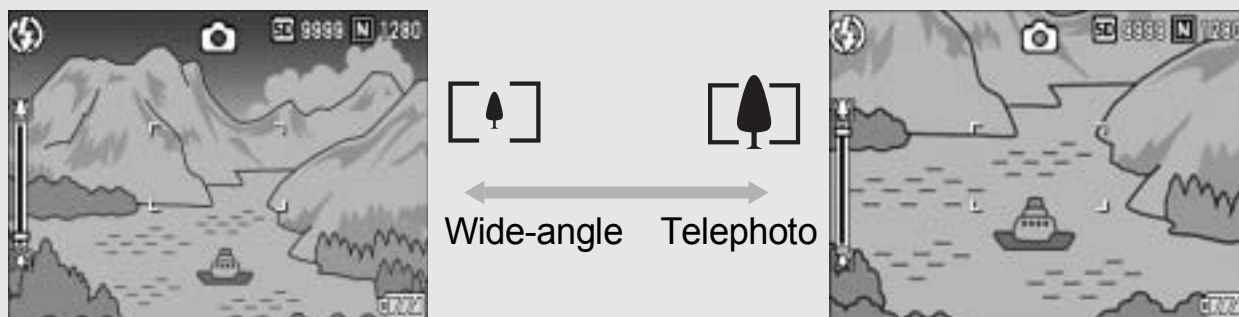

1 With the camera ready to shoot, press the [▲] (Wide-angle) button or the [▼] (Telephoto) button.

- You can check the zoom status on the zoom bar of the LCD monitor.

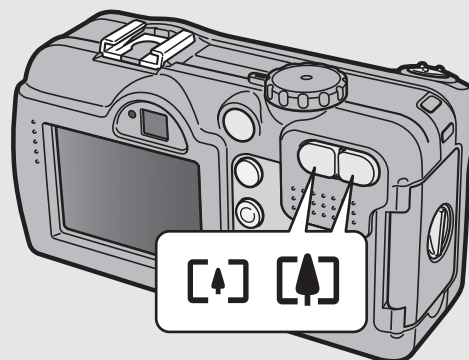

2 Compose your picture and half-press the shutter release button.

3 Full-press the shutter release button.



Using the Digital Zoom

Digital zooming enables you to enlarge the subject more than the maximum magnification of the optical zoom (3.0×) specified by pressing the [▼] (Telephoto) button (up to 4.0×).

For digital zooming, release the [▼] button once when the zoom reaches the limit on the [▼] (Telephoto) end on the zoom bar, and then hold the [▼] button down again.

If you are using the camera for the first time, read this section.



Shooting Close-Ups (Macro Shooting)

Using the  (Macro) button allows you to take a tight close-up of the subject. (Macro shooting)

This is good for shooting small subjects because you can shoot up to approximately 5 mm (0.2 in.) (from the very front of the camera) away.

If you are using the camera for the first time, read this section.

1 With the camera ready to shoot, press the  (Macro) button.

-  is displayed momentarily at the center of the LCD monitor and then a  is displayed at the top of the screen.

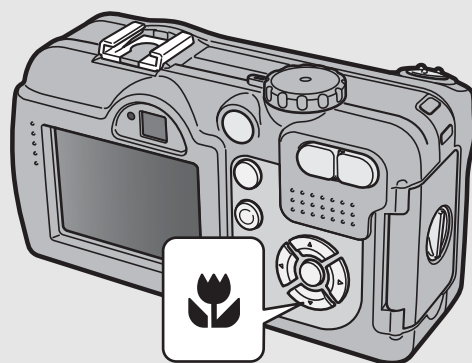

2 Compose your picture and half-press the shutter release button.

3 Full-press the shutter release button.

- To cancel macro mode, press the  (Macro) button again.

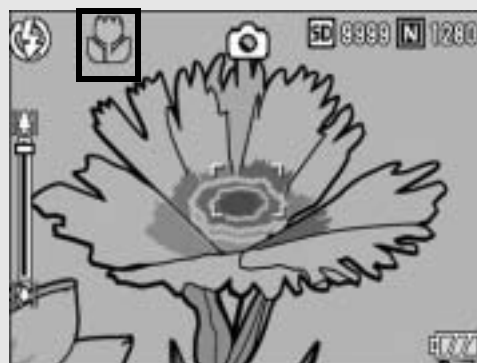

Note

- When using the zoom, you can shoot close-ups within the following distances:

	Distance	Shooting range
Wide-Angle	About 5 mm (from the very front of the camera)	Approx. 27 mm × 20 mm
Telephoto	About 10 cm (from the very front of the camera)	Approx. 51 mm × 38 mm (when digital zoom is not used)
		Approx. 12.8 mm × 9.5 mm (when 4.0× digital zoom is used)





- The AF target shift function enables you to lock the focus for macro shooting with the simple touch of a button without moving the camera. This function is useful for shooting on a tripod. (👉 P.58)
- To take a further close-up picture during macro shooting, use [ZOOM MACRO] in scene mode. (👉 P.40)

Using the Flash

Press the  (Flash) button to change the flash mode. At the time of purchase, the camera is set to [FLASH OFF].

From the front edge of the lens, the flash light reaches about 0.2 to 10.0 m (7.9 in. to 32.8 ft.) (Wide-angle) or about 0.2 to 6.5 m (7.9 in. to 21.3 ft.) (Telephoto) when the ISO setting is set to [AUTO].

Flash Modes

	FLASH OFF	The flash will not fire.
	AUTO	The flash fires automatically when the subject is poorly lit or backlit.
	RED-EYE FLASH	Reduces the red-eye phenomenon, in which people's eyes appear red in pictures.
	FLASH ON	The flash fires regardless of the lighting conditions.
	FLASH SYNCHRO.	The flash fires with the shutter speed slowed. This is useful when taking portrait pictures in a nightscape. Camera shake may occur, so the use of a tripod is recommended.

1 Turn the mode dial to /CAL.S.

2 Press the  (Flash) button to change the flash mode.

- The flash mode mark is displayed momentarily at the center of the LCD monitor and then a smaller mark is displayed at the upper left of the screen.
- The auto focus/flash lamp blinks while the flash charges. Once the flash is charged, the lamp turns off and the camera is ready to shoot.

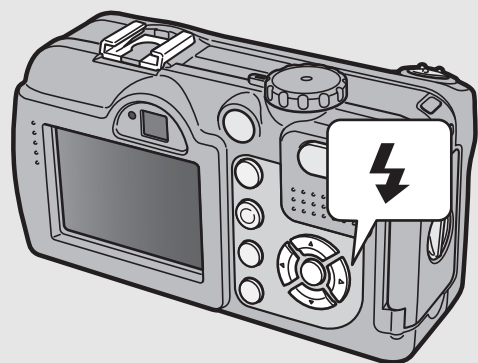

Note

- The flash mode setting is saved until you press the  (Flash) button again.
- The flash does not fire when shooting movies or in Multi-shot mode.
- The flash fires a pre-flash to increase the AE/AF (Auto Exposure/Auto Focus) accuracy.
- When shooting close-ups with the flash, there may be a shadow in the lower left part of the picture due to the convex lens.





If you are using the camera for the first time, read this section.

Shooting with Optimal Settings According to Shooting Conditions

You can use scene mode to select from among five still image modes and shoot with settings automatically optimized for shooting conditions.

If you are using the camera for the first time, read this section.

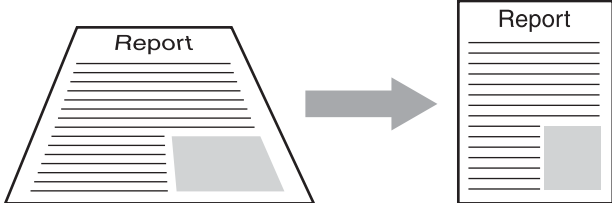
Scene Modes

 <p>HIGH SENS</p>	<p>Use when taking pictures in dimly lit places. The LCD monitor also becomes brighter.</p>
 <p>FIREFIGHTING</p>	<p>Use to capture images under difficult conditions such as the scene of a fire. The focal length is fixed to 2.5 m, allowing you to take clear pictures in a situation where the auto focus would normally produce blurred images due to flames, smoke and water vapor. Increasing the ISO sensitivity extends the range of the flash, and prevents camera shake by controlling the shutter speed even when the flash is not used. The sharpness level is also increased in this mode and the LCD monitor becomes brighter and is suited for firefighting.</p>
 <p>SKEW COR MODE</p>	<p>Use to straighten a rectangular object, such as a message board or business card, shot at an angle to make it look as if it were shot squarely. For detailed operations, see P.42.</p> <div style="text-align: center;">  </div> <p>In skew correction mode, choose from [F1280], [N1280], and [N640] for [PIC QUALITY/SIZE]. (P.61)</p>
 <p>TEXT MODE</p>	<p>Use when capturing text images, for example notes written on a whiteboard at a meeting. You can also change the shading of text. (P.57) You can set the image size to either 3264 × 2448 or 2048 × 1536 pixels. (P.61)</p>
 <p>ZOOM MACRO</p>	<p>Use when taking a further close-up picture during macro shooting. Using the digital zoom allows you to take a larger close-up than with normal macro shooting. For detailed operations, see P.43. The optical zoom cannot be used in this mode. You can shoot close-ups within the following distances. When digital zoom is not used: About 5 mm from the very front of the camera (Shooting range: Approx. 27 mm × 20 mm) When 4.0× digital zoom is used: About 5 mm from the very front of the camera (Shooting range: Approx. 6.8 mm × 5 mm)</p>



Note

For information on Shooting Setting menu items and function restrictions in scene mode, see "Appendices". (P.240)

1 Turn the mode dial to .

2 Press the **SCENE** button.

- The scene mode selection screen appears.

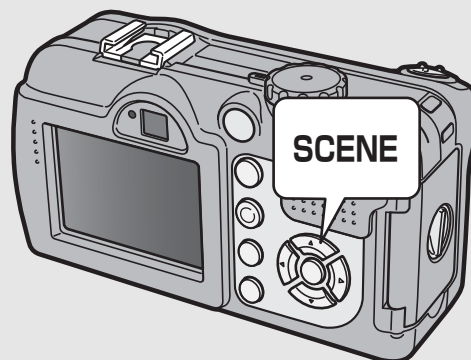

3 Press the **▲▼** buttons to select the scene mode.



4 Press the **MENU/OK** button.

- The scene mode type is displayed at the top of the LCD monitor.

5 Press the shutter release button to shoot the picture.



Changing Scene Mode

Press the SCENE button to display the scene mode selection screen, and select a different scene mode.

Returning to Normal Shooting Mode

1 Press the **SCENE** button to display the scene mode selection screen.

2 Press the **▲▼** buttons to select **[NRML SHT]**.

3 Press the **MENU/OK** button.

If you are using the camera for the first time, read this section.

Using the Skew Correction Mode

1 Turn the mode dial to .

2 Press the **SCENE** button.

- The scene mode selection screen appears.

3 Press the **▲▼** buttons to select **[SKEW COR MODE]**.

4 Press the **MENU/OK** button.

5 Press the shutter release button to shoot the picture.

- The display indicates that the image is being corrected and the area recognized as the correction range is displayed with an orange frame. Up to five areas can be recognized.
- If the target area cannot be detected, an error message appears. The image before correction remains recorded.
- To select another correction area, move the orange frame to the target area by pressing the **▶** button.
- To cancel skew correction, press the **▲** button. Even if you cancel skew correction, the image before skew correction remains recorded.

6 Press the **MENU/OK** button.

- The display indicates that the image is being recorded and the corrected image is recorded. The image before correction is also recorded.



Caution-----

When **[SKEW COR MODE]** is selected, note the following:

- To shoot the subject as large as possible, position it so that the entire portion of the subject is visible on the LCD monitor.
- The camera may fail to recognize the subject in the following cases:
 - When the image is out of focus
 - When four edges of the subject are not clearly visible
 - When it is hard to distinguish between the subject and background
 - When the background is complicated
- Two images, one before correction and the other after correction, are recorded. If the number of remaining shots is less than two, you cannot shoot the subject.

Shooting in Zoom Macro Mode

- 1** Turn the mode dial to .
- 2** Press the **SCENE** button.
 - The scene mode selection screen appears.
- 3** Press the **▲▼** buttons to select **[ZOOM MACRO]**.
- 4** Press the **MENU/OK** button.
- 5** Press the **[◀]** (Wide-angle) or **[▶]** (Telephoto) button.
 - The zoom level appears on the LCD monitor.
- 6** Compose your picture and half-press the shutter release button.
- 7** Full-press the shutter release button.

If you are using the camera for the first time, read this section.

Shooting in CALS Mode

In CALS mode, [PIC QUALITY/SIZE] is fixed at [N1280] (Normal 1280 × 960) suitable to be submitted as official public works pictures (based on Japanese standards).

With simple operation of the mode dial, you can shoot photos in a construction environment without being distracted by setting the picture quality mode or image size.

If you are using the camera for the first time, read this section.

1 Turn the mode dial to CALS.

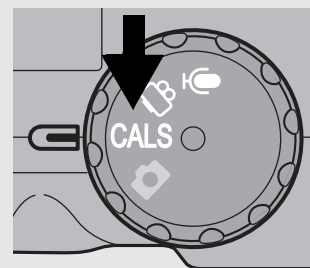

- The symbol appears on the screen.



2 Press the shutter release button to shoot the picture.

- Images are recorded with [PIC QUALITY/SIZE] set to [N1280].
- When the mode dial is set to a mode other than **CALS**, [PIC QUALITY/SIZE] returns to the setting in the previous mode.



Note

When shooting with S-CONT or M-CONT in CALS mode, [PIC QUALITY/SIZE] is fixed at [N3264] (Normal 3264 × 2448).

🕒 Using the Self-Timer

You can set the Self-timer to shoot after either two or ten seconds. A setting of two seconds is useful for preventing camera shake.

1 Turn the mode dial to /CAL.S.

2 Press the 🕒 (Self-timer) button.

- The Self-timer symbol appears on the screen.
- The [10] to the right of the symbol indicates the number of seconds. In this case, if you press the shutter release button, the camera will shoot after 10 seconds.
- Each press of the 🕒 (Self-timer) button changes the self-timer setting in the following order: 10 sec, 2 sec, and Self-timer Off.



3 Press the shutter release button.

- The focus is locked, and the AF auxiliary light blinks when the self-timer starts.



Note

- Once the picture is taken, the self-timer turns off.
- When the self-timer is set to 2 seconds, the AF auxiliary light does not blink.

If you are using the camera for the first time, read this section.

Playing Back Images







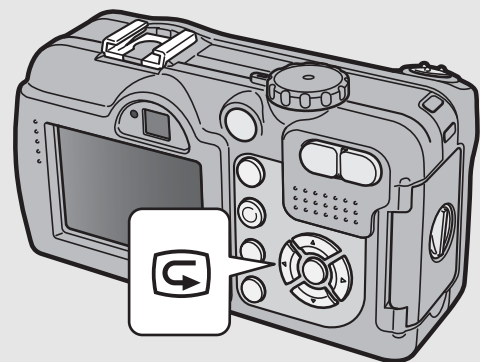

Reviewing the Image You Just Took (Quick Review)

You can view the image you just took on the LCD monitor. If you are not pleased with the way the photo came out, you can delete it then and there.

1 In shooting mode, press the (Quick Review) button.

- The last image you took is displayed on the LCD monitor.



In Quick Review	
 Button	Returns to shooting mode.
 Button	Enlarges the displayed still image. You can move the displayed still image by pressing the  buttons.
 Button	Reduces the displayed still image enlarged by pressing the  button.
MENU/OK Button	Enlarges the displayed still image enlarged by pressing the  button to the maximum available magnification. Pressing this again returns the still image to its original size.
 Button	Deletes the currently displayed file. When the  button is pressed, a warning message about deleting the file appears. Select [DELETE] and press the MENU/OK button.



Note



- Once the power is turned off, the image you took cannot be displayed in still image mode even if you press the  (Quick Review) button.
- If you use Quick Review to view the image taken in [TEXT MODE] of scene mode ( P.40), the displayed image may have a slightly lower quality than the recorded one.

If you are using the camera for the first time, read this section.

Viewing Your Images

In playback mode, you can check still images you have taken. You can also delete or zoom in on the images.

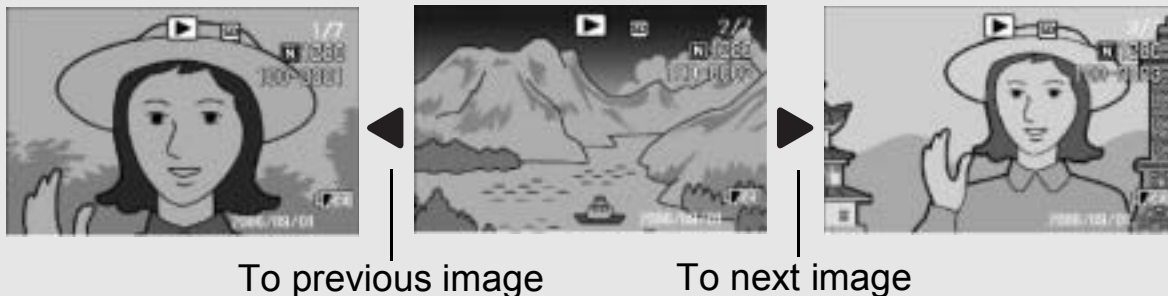
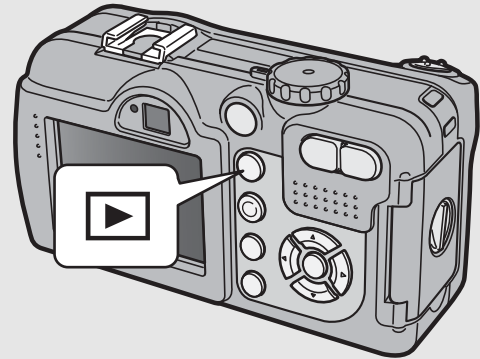

1 Press the (Playback) button.

- The camera switches to playback mode and the last still image you took is displayed.
- You can view your pictures in order by using the   buttons.
- To switch the camera from playback mode to shooting mode (or voice memo mode), press the  (Playback) button again.



Turning on the camera in playback mode-----

When the camera is off, pressing the  (Playback) button for more than one second turns the camera on. (The camera starts up in playback mode.)

When the camera has been turned on with the  (Playback) button, pressing the  (Playback) button again switches playback mode to shooting mode.

Where images are played back from-----

When no SD memory card is loaded, the camera plays back from the internal memory.
When an SD memory card is loaded, it plays back from the SD memory card.

If you are using the camera for the first time, read this section.

Three-frame View/List View (Thumbnail Display)

When playing back images on the LCD monitor, the playback screen can be divided into three frames (three-frame view) or 12 frames (list view). The three-frame view and list view allow you to select a still image to enlarge or delete.

The playback screen changes as follows:



1 Press the (Playback) button.

- The last image you took is displayed.

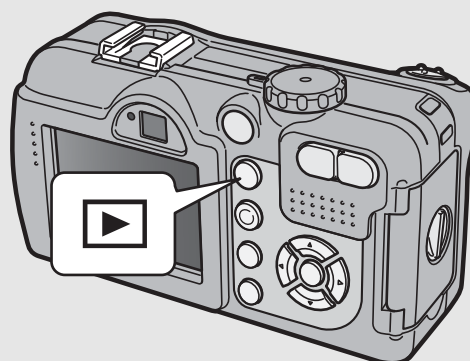

2 Press the (Thumbnail Display) button.

- The screen changes to three-frame view. The large frame at the center of the screen displays the currently selected still image.

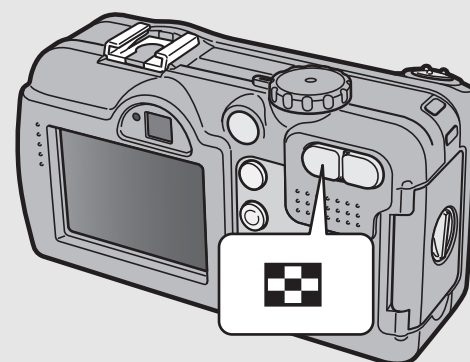

If you are using the camera for the first time, read this section.

3 Press the (Thumbnail Display) button again during three-frame view.

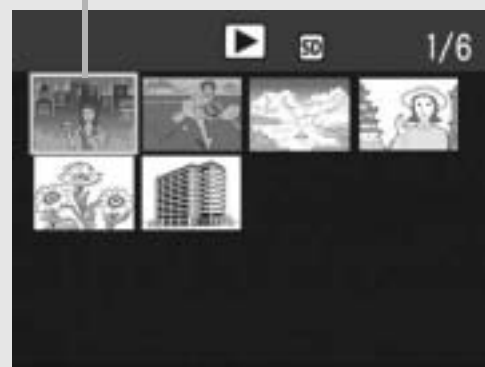

- The screen is divided into 12 frames and the list of still images is displayed.

Selected still image



Switching to Single-Picture Display

● In three-frame view

- 1** Press the   buttons to select a still image.
- 2** Press the  (Enlarged View) button or the MENU/OK button.





● In list view

- 1** Press the     buttons to select a still image.
- 2** Press the  (Enlarged View) button twice.



Note -----

If any of the following operations is performed in the three-frame view, the display returns to the ordinary playback screen (single-picture display) and the operation is executed.

- Deletion ( P.51)
- Menu display ( P.88)
- Movie playback ( P.85)
- Sound playback ( P.87)

If you are using the camera for the first time, read this section.

Magnifying Images

You can enlarge a still image displayed on the LCD monitor.

Image Size	Enlarged View (maximum magnification)
3264 × 2448, 2592 × 1944, 2048 × 1536	8 times
1280 × 960	6.7 times
640 × 480	3.4 times

1 Press the  (Playback) button.





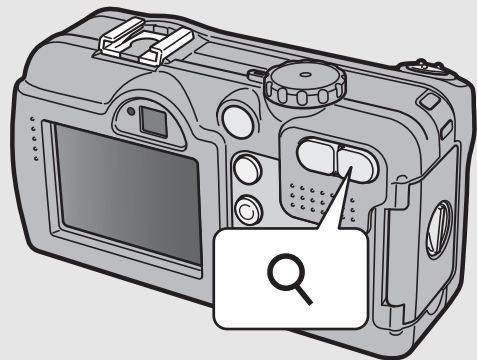

- The last image you took is displayed.

2 Press the   buttons to display the still image you want to enlarge.

3 Press the  (Enlarged View) button.

- The still image is enlarged.



In Enlarged View	
 Button	Enlarges the displayed still image. You can move the displayed still image by pressing the     buttons.
 Button	Returns the enlarged still image to its original size.
MENU/OK Button	Displays the still image at the maximum magnification. Pressing this again returns the still image to its original size.



Note -----

- Enlarged view is also available in the quick review mode.
- Movies cannot be enlarged.

Deleting Files

You can delete unwanted or failed files from the SD memory card or internal memory.

Deleting a File

- 1** Press the  (Playback) button.
- 2** Press the  buttons to display the file you want to delete.
- 3** Press the  (Delete) button.
- 4** Press the  buttons to select [DELETE ONE].
 - You can change the image for deletion with the  buttons.
- 5** Press the MENU/OK button.
 - The display indicates that the files are being deleted; once finished, it returns to the screen in Step 4.

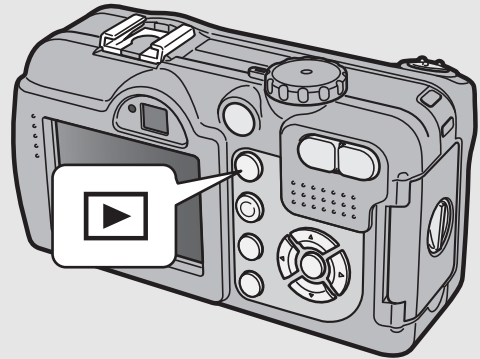

Deleting All Files

- 1** Press the  (Playback) button.
- 2** Press the  (Delete) button.

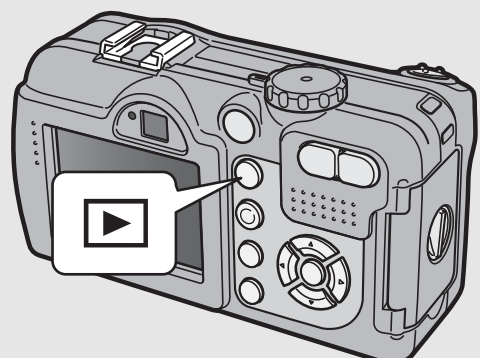

If you are using the camera for the first time, read this section.



3 Press the ▲▼ buttons to select [DELETE ALL].

4 Press the MENU/OK button.

- You will be prompted to confirm that you want to delete all images. If so, press the ► button to select [YES], and then press the MENU/OK button.



Note -----

You can also delete files by pressing the  (Delete) button during three-frame view ( P.48).

Deleting Multiple Files at One Time

1 Press the  (Playback) button.

2 Press the  (Thumbnail Display) button twice.

- The screen is divided into 12 frames and thumbnails are displayed.

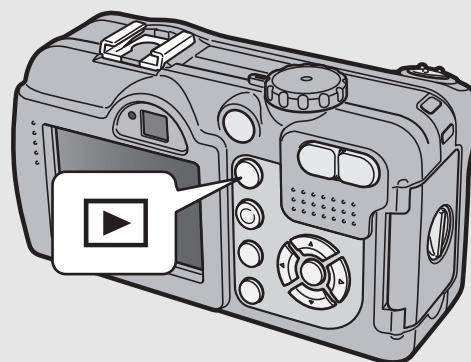

3 Press the ▲▼◀▶ buttons to select the file you want to delete and press the  (Delete) button.

- The trash symbol is displayed in the upper left corner of the file.

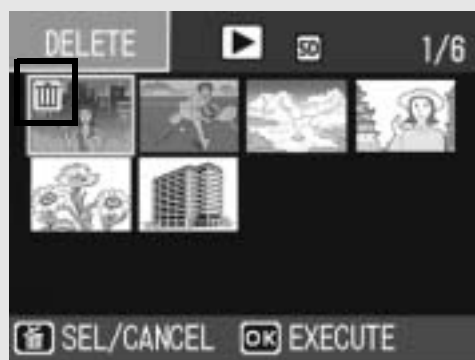

4 Repeat Step 3 to select all the files you want to delete.

- If you selected a file by mistake, you can deselect it by selecting the file and pressing the  (Delete) button.

5 Press the MENU/OK button.

6 Press the ◀▶ buttons to select [YES] and then press the MENU/OK button.

- The display indicates that the files are being deleted; once finished, it returns to the thumbnail display screen.



If you are using the camera for the first time, read this section.

Changing the Display with the DISP. Button

If you are using the camera for the first time, read this section.

Pressing the DISP. button allows you to change the screen display mode and toggle the information displayed on the LCD monitor. Each time you press the DISP. button, the display changes in the following order: Grid Guide, No Display, LCD Monitor Off, and Normal Symbol Display.

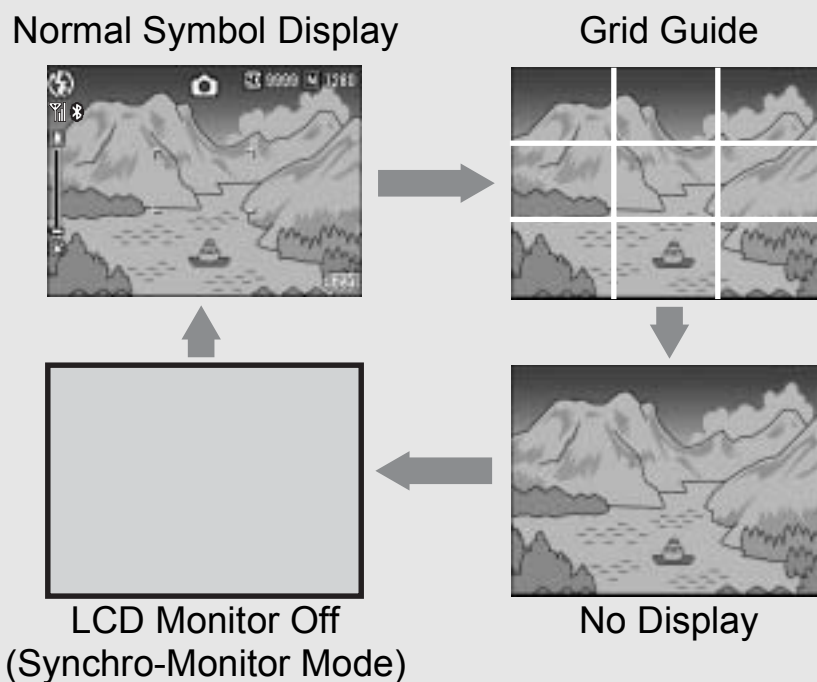

Grid Guide -----

This displays auxiliary lines on the LCD monitor to help you compose your picture. These lines are not recorded with images.

Synchro-Monitor Mode -----

This turns the LCD monitor off except when the camera is operated. This mode is effective for saving power consumption. In this mode, pressing the shutter release button halfway turns the LCD monitor on. Subsequently, pressing the shutter release button fully displays the shot image on the LCD monitor and then turns the LCD monitor off.

Maximizing the LCD Monitor Brightness

Hold the DISP. button down to maximize the display brightness. When the brightness is at the maximum setting, holding the DISP. button down returns the brightness to the level set in [LCD BRIGHTNESS] (☞ P.111).

Advanced Operations

Read this section when you want to learn more about the different camera functions.

1	Various Shooting Functions	56
2	Shooting/Playing Back Movies	83
3	Recording/Playing Back Sound	86
4	Other Playback Functions	88
5	Direct Printing.....	98
6	Changing Camera Settings	106
7	Downloading Images to Your Computer	128
8	Using the Bluetooth[®] Function	154
9	Using the GPS Function	180
10	Using the Wireless LAN Function (Only for Caplio 500SE-W).....	191
11	Appendices	221

1

2

3

4

5

6

7

8

9

10

11

1 Various Shooting Functions

Using the ADJ. Button

You can use the ADJ. button to adjust the exposure compensation, white balance, and other settings with fewer operations. Two functions other than exposure compensation and white balance can also be assigned to the ADJ. button. Use the SETUP menu to assign functions to the ADJ. button. (P.112) By assigning a frequently used function to the ADJ. button, you can more easily set that function with fewer button operations.

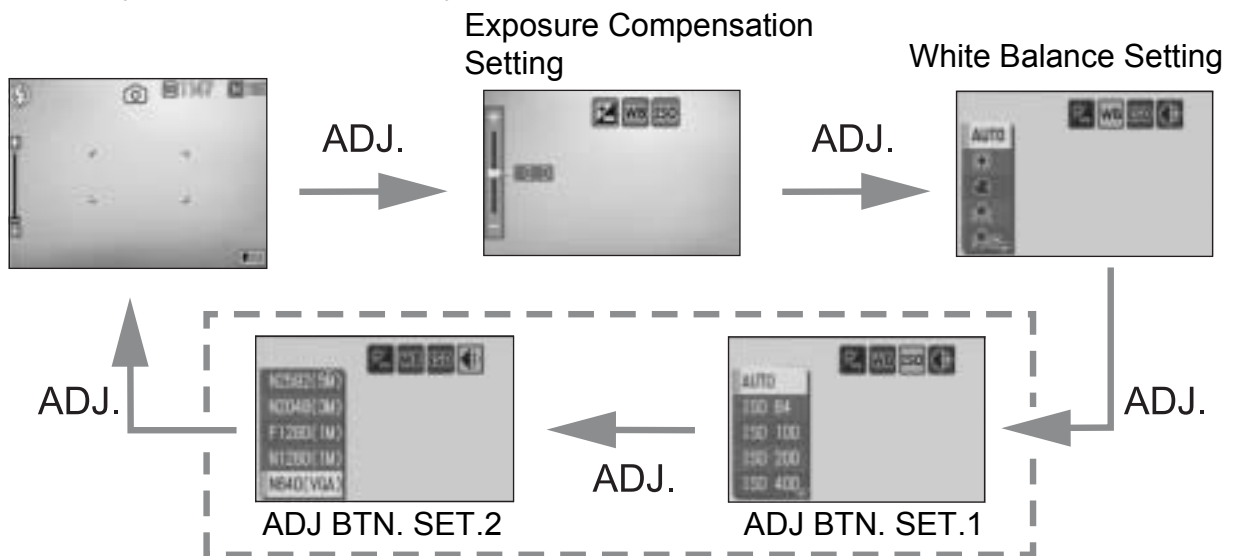

The screenshots above are examples of the screen display when functions are assigned to [ADJ BTN. SET. 1] and [ADJ BTN. SET. 2]. Press the ADJ. button until the screen with the desired function appears. Adjust the settings with the ▲▼ buttons and press the MENU/OK button to set.

Settings by Mode

The settings that can be made with the ADJ. button differ among scene mode, movie mode and still image mode. The following settings can be made with the ADJ. button.

Mode	Available Settings
Still Image Mode	Exposure compensation, white balance, functions assigned to the ADJ. button
Movie Mode	White balance
Scene Mode ([TEXT MODE])	Text density
Scene Mode (other than [TEXT MODE])	Exposure compensation, white balance

Functions That Can Be Assigned to the ADJ. Button

ISO (ISO SETTING), QUALITY (PIC QUALITY/SIZE), FOCUS, SHARP (SHARPNESS), METERING (PHOTOMETRY), CONT MDE (CONT.MODE), ANTIBLUR (Default setting for [ADJ BTN.SET.1])



Note

When using a camera memo, the settings on P.56 cannot be set with the ADJ. button.
(☞ “Software User Guide”)

Changing the Text Density (SCENE)

You can change the shading of text for shooting with [TEXT MODE] (☞ P.40) in scene mode.

You can select from [DEEP], [NORMAL] and [LIGHT].

To change the setting, use the Shooting Setting menu or the ADJ. button. This section explains easy ways to change the shading setting with the ADJ. button.

To use the Shooting Setting menu, see “Using the Menu” (☞ P.60) and “Shooting Setting Menu Items by Scene Mode” (☞ P.240).

1 Turn the mode dial to .

2 Press the SCENE button.

- The scene mode selection screen appears.

3 Press the ▲▼ buttons to select [TEXT MODE] and then press the MENU/OK button.



4 Press the ADJ. button.

- The text density menu appears.

5 Press the ▲▼ buttons to select the desired density setting.

- You can also press the shutter release button to shoot the picture.

6 Press the MENU/OK button.

- The text density setting does not appear on the screen.



Shifting the AF Target (Macro)

You can press the ADJ. button during macro shooting and then use the ▲▼◀▶ buttons to shift the AF target without moving the camera. You can then lock the focus (👉 P.35) at the position of the AF target and shoot the picture. This function is useful for shooting on a tripod.



When the AF target is shifted to the left with the ◀ button



1 With the camera ready to shoot, press the 🌸 (Macro) button.

- The macro symbol appears on the screen.

2 Press the ADJ. button.

3 Press the ◀▶ buttons until the AF target shift function screen (cross-mark in the middle of the screen) appears.

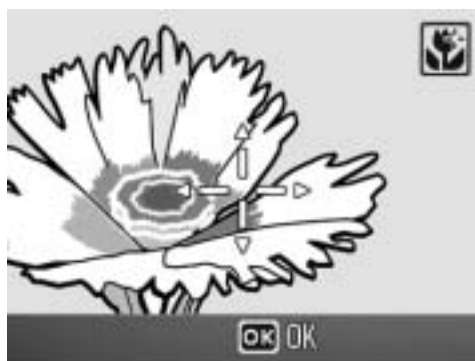

4 Shift the cross-mark to the subject you want the camera to focus on with the ▲▼◀▶ buttons.

5 Press the MENU/OK button.

6 Half-press the shutter release button.

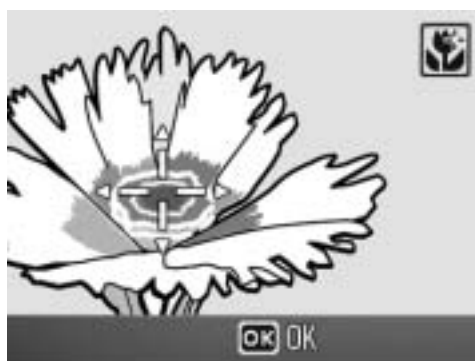

- The camera focuses on the area at the position of the cross-mark.







7 Gently press the shutter release button all the way.

- The AF target shift function automatically focuses the camera on the set position until macro mode is canceled.

Shooting Setting Menu







Press the MENU/OK button in shooting mode to display the Shooting Setting menu. The Shooting Setting menu can be used to set the following shooting settings.

When Mode Dial is Set to /CAL

Setting	Options [Default Settings]	Refer to
PIC QUALITY/SIZE	F3264(8M), N3264(8M), N2592(5M), N2048(3M), F1280(1M), [N1280(1M)], N640(VGA)	P.61
ANTIBLUR	[OFF], ON	P.63
FOCUS	[MULTI AF], SPOT AF, MF, SNAP, ∞	P.64
PHOTOMETRY	[MULTI], CENTER, SPOT	P.67
SHARPNESS	SHARP, [NORMAL], SOFT	P.68
CONT. MODE	[OFF], S-CONT, M-CONT	P.69
COLOR DEPTH	VIVID, [NORMAL], NEUTRAL, B&W	P.72
TIME EXPOSURE	[OFF], 1 SEC., 2 SEC., 4 SEC., 8 SEC.	P.73
INTERVAL	[0 s], 30 seconds to 3 hours	P.74
IMAGE WITH SOUND	[OFF], ON	P.76
DATE IMPRINT	[OFF], DATE, TIME	P.77
EXPOSURE COMP.	-2.0 to +2.0	P.78
WHITE BALANCE	[AUTO],  (OUTDOORS),  (CLOUDY),  (INCANDESCENT LAMP),  (INCANDESCENT LAMP2),  (FLUORESCENT LAMP),  (MANUAL SETTINGS)	P.79
ISO SETTING	[AUTO], ISO 64, ISO 100, ISO 200, ISO 400, ISO 800, ISO 1600	P.81
RESTORE DEFAULTS	_____	P.82



- The settings that can be selected during scene mode are restricted. ( P.240).

When Mode Dial is Set to

Setting	Options [Default Settings]	Refer to
MOVIE SIZE	[320], 160	P.61
FRAME RATE	[30FPS], 15FPS	P.84
FOCUS	[MULTI AF], SPOT AF, MF, SNAP, ∞	P.64
WHITE BALANCE	[AUTO],  (OUTDOORS),  (CLOUDY),  (INCANDESCENT LAMP),  (INCANDESCENT LAMP2),  (FLUORESCENT LAMP),  (MANUAL SETTINGS)	P.79



Note

The SETUP menu ( P.106) and EXP SET menu ( P.155) can be accessed from within the Shooting Setting menu.

Using the Menu

This explains how to make the settings.

Use the ▲▼▶ buttons and MENU/OK button to select and set an item.

1 Press the MENU/OK button in shooting mode.

- The Shooting Setting menu is displayed.

The menu items are provided on three screens.

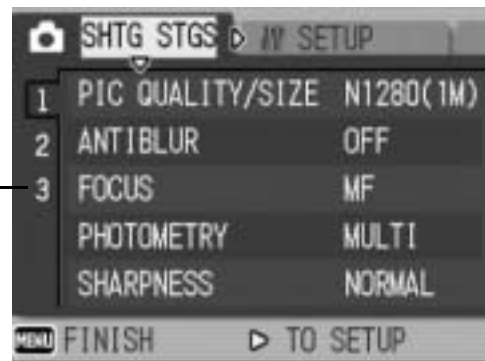

2 Press the ▲▼ buttons to select the desired menu item.

- Press the ▼ button at the bottom item to display the next screen.

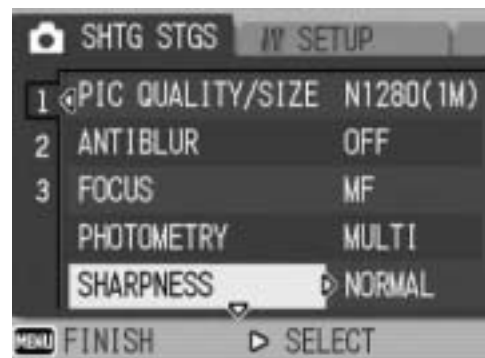

3 Press the ▶ button.

- The menu item settings are displayed.

4 Press the ▲▼ buttons to select the setting.

5 Press the MENU/OK button, or ◀ button and press the MENU/OK button.

- The setting is set.
- The Shooting Setting menu disappears and the camera is ready to shoot.



Changing the display -----

- You can select a screen by the screen number:
 - 1 Press the ◀ button to select a screen number on the left of the screen.
 - 2 Press the ▲▼ buttons to change screens.
 - 3 Press the ▶ button to return to menu item selection.

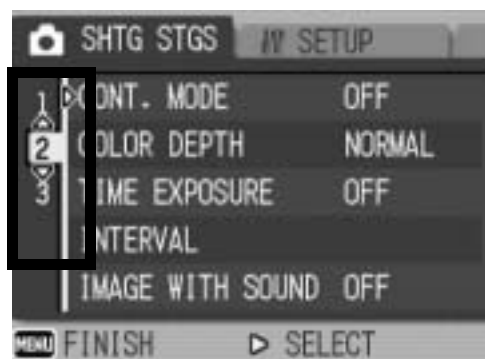

Choosing Picture Quality Mode/ Image Size (PIC QUALITY/SIZE)

The file size of a shot still image depends on the picture quality mode and image size settings. For movies, choose the movie size. Figures inside the bold frame indicate those shown on the screen.

Still Images

Image Size	Picture Quality Mode	PIC QUALITY/ SIZE	Remarks
3264 × 2448	F(Fine) N(Normal)	F3264(8M) N3264(8M)	<ul style="list-style-type: none"> • For downloading and editing images on your computer.
2592 × 1944	N(Normal)	N2592(5M)	<ul style="list-style-type: none"> • For creating large prints.
2048 × 1536	N(Normal)	N2048(3M)	<ul style="list-style-type: none"> • For creating large prints.
1280 × 960	F(Fine) N(Normal)	F1280(1M) N1280(1M)	<ul style="list-style-type: none"> • For taking pictures of public works for submission.
640 × 480	N(Normal)	N640(VGA)	<ul style="list-style-type: none"> • For shooting a large number of pictures. • For attaching to e-mail. • For posting on a website.

- In CALS mode, the image size is fixed to [N1280(1M)].
- When scene mode is set to [SKEW COR MODE], you can select 1280 × 960 or 640 × 480.
- When scene mode is set to [TEXT MODE], you can select 3264 × 2448 or 2048 × 1536.

Movies

Image Size	Movie Size
320 × 240	320
160 × 120	160

- You can also choose the number of frames for movies. (👉 P.84)



Note -----

- For picture quality mode, select normal mode (N) or fine mode (F), depending on the desired compression ratio.
Normal mode: The compression ratio is high, resulting in a small file. Normally, shooting is done in this mode.
Fine mode: The compression ratio is low, resulting in a large file, but the picture quality is better than in Normal.
- The number of images that can be stored in the internal memory or SD memory card depends on the [PIC QUALITY/SIZE] setting. (☞ P.235)

1 Turn the mode dial to /📹.

2 Press the MENU/OK button.

- The Shooting Setting menu is displayed.

3 Press the ▼ button to select [PIC QUALITY/SIZE] and press the ► button.

4 Press the ▲▼ buttons to select the desired setting.

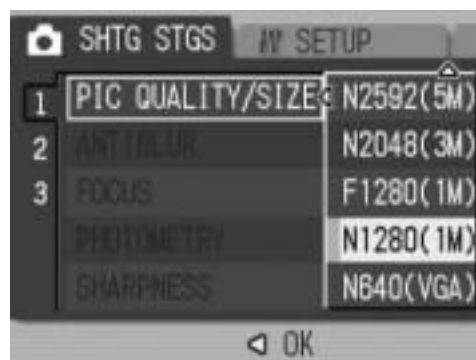

Still Images



Movies

5 Press the MENU/OK button, or ◀ button and press the MENU/OK button.

- The setting appears on the screen.

Shooting with the Antiblur Function (ANTIBLUR)

This function minimizes camera shake and blurring during shooting.

1 Turn the mode dial to /CAL.S.

2 Press the MENU/OK button.

- The Shooting Setting menu is displayed.

3 Press the ▼ button to select [ANTIBLUR] and press the ► button.

4 Press the ▲▼ buttons to select [ON].



5 Press the MENU/OK button, or ◀ button and press the MENU/OK button.

- The antiblur symbol appears on the screen.



Caution-----

- The antiblur function does not work when the ISO setting is set to a setting other than [AUTO] or the time exposure is set to a setting other than [OFF]. Set the ISO setting to [AUTO] (P.81) and set the time exposure to [OFF]. (P.73)
- The antiblur function may not prevent blurring when shooting in dark places or when the subject is moving.

Note-----



The mark appears when blurring is likely to occur. (P.33)



Changing the Focusing Mode (FOCUS)

If you shoot the subject in the default focusing mode, the camera focuses automatically with Auto Focus (AF).

Choose from the following five focusing modes.

Focusing Modes

Symbol	Mode	Description
None	MULTI AF	Automatically measures the distances to a maximum of five AF areas from among 17 AF areas and focuses to the nearest AF area. This prevents the center of the LCD monitor from becoming out of focus and enables you to shoot with a minimum number of out-of-focus pictures.
None	SPOT AF	Selects one AF area at the center of the picture to allow the camera to focus on this area automatically.
	MF (Manual Focus)	Enables you to adjust the focus manually.
	SNAP	Fixes the shooting distance to a short distance (about 2.5 m (8.2 ft.)).
	∞ (Infinity)	Fixes the shooting distance to infinity. Infinity is useful for shooting distant scenes.

- 1** Turn the mode dial to /CALIS/.
- 2** Press the MENU/OK button.
 - The Shooting Setting menu is displayed.
- 3** Press the ▼ button to select [FOCUS] and press the ► button.
- 4** Press the ▲▼ buttons to select the desired setting.
- 5** Press the MENU/OK button, or ◀ button and press the MENU/OK button.



Manual Focus Shooting (MF)

If the camera fails to focus automatically, you can focus manually (MF: Manual Focus).

Manual focus enables shooting at a fixed distance.



Note

- In scene mode, manual focus can be used only when [ZOOM MACRO] or [SKEW COR MODE] is selected.
- You can also use manual focus to focus on objects within the macro shooting range.

1

Turn the mode dial to /CAL_S/.

2

Press the MENU/OK button.

- The Shooting Setting menu is displayed.

3

Press the ▼ button to select [FOCUS] and press the ► button.

4

Press the ▲▼ buttons to select [MF].



5

Press the MENU/OK button.

- [MF] is displayed on the screen.



6

Press the ▼ button as required.

- Pressing the ▼ button enlarges the display for easy focusing.

7 Press the ◀ button to display the focus bar.

- Each time the ◀ button is pressed, the focus bar and zoom bar appear alternately.



8 Press the [▲] (Telephoto) button or the [↕] (Wide-angle) button to adjust the focus.

- Pressing the [▲] (Telephoto) button adjusts the focus to farther objects.
Pressing the [↕] (Wide-angle) button adjusts the focus to closer objects.

9 Press the shutter release button to shoot the picture.





Note -----
When the zoom bar is displayed, you can operate the zoom bar with the [▲] (Telephoto) button or the [↕] (Wide-angle) button.

Changing the Light Metering (PHOTOMETRY)

You can change the metering method (the range to use for metering) used to determine the exposure value.

There are three light metering modes.

Light Metering Modes

Symbol	Mode	Description
None	MULTI	The entire shooting range is divided into 256 partitions, and each is metered to determine the overall exposure value.
	CENTER	The entire image is metered, with emphasis on the center, to determine the exposure value. Use this when the brightness of the center and surroundings are different.
	SPOT	Only the center of the image is metered to determine the exposure value. Use this setting when you want to use the brightness at the center. This is useful if there is a marked difference in contrast or backlighting.

1 Turn the mode dial to /CALC.

2 Press the MENU/OK button.

- The Shooting Setting menu is displayed.

3 Press the ▼ button to select [PHOTOMETRY] and press the ► button.

4 Press the ▲▼ buttons to select the desired setting.



5 Press the MENU/OK button, or ◀ button and press the MENU/OK button.

- The symbol appears on the screen.



Changing the Edge Quality of Still Images (SHARPNESS)

You can change the edge quality of your still images to either sharp or soft.

1 Turn the mode dial to /CAL.S.

2 Press the MENU/OK button.

- The Shooting Setting menu is displayed.

3 Press the ▼ button to select [SHARPNESS] and press the ► button.

4 Press the ▲▼ buttons to select the desired setting.



5 Press the MENU/OK button, or ◀ button and press the MENU/OK button.

- The symbol appears on the screen.



Shooting with Multi-Shot (S-CONT/M-CONT)

With Multi-shot, you can shoot consecutive images. Multi-shot has the following two modes:

S (Stream)-CONT

With just one full-press of the shutter release button, you can take 16 consecutive shots at intervals of 1/7.5 seconds in about 2 seconds. The 16 still images are grouped together as a set and are recorded as one image file (3264 × 2448 pixels).

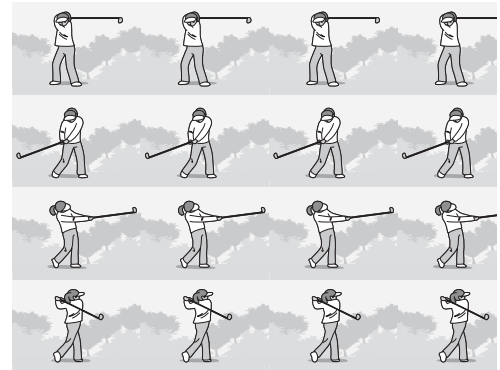

M (Memory-reversal)-CONT

The camera memorizes the scene while you hold down the shutter release button, and once you release it, the previous 2 seconds of shots are recorded. The 16 still images are grouped together as a set and are recorded as one image file (3264 × 2448 pixels).

(2) The camera records for about 2 seconds ahead

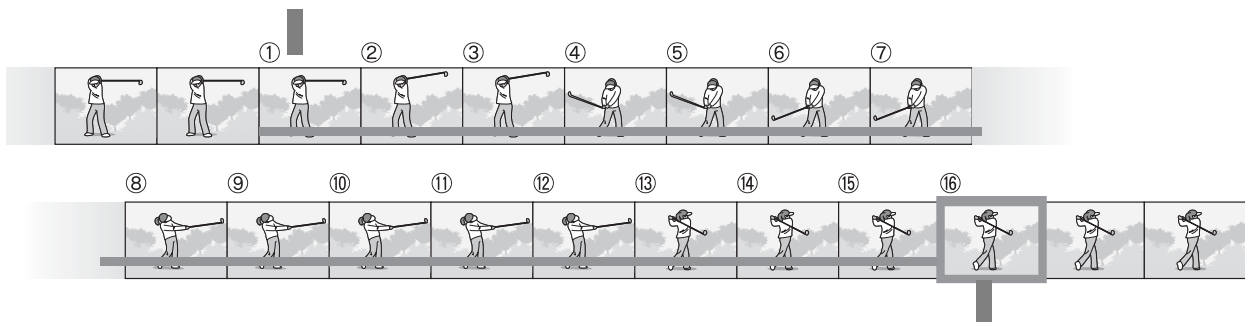

(1) If you release the shutter release button here...



Note

When shooting with S-CONT or M-CONT, the ISO setting is fixed at [AUTO] even if it is set to [ISO 64] or [ISO 100].

1 Turn the mode dial to /CAL.S.

2 Press the MENU/OK button.

- The Shooting Setting menu is displayed.

3 Press the ▼ button to select [CONT. MODE] and press the ► button.

4 Press the ▲▼ buttons to select [S-CONT], or [M-CONT].



5 Press the MENU/OK button, or ◀ button and press the MENU/OK button.

- The symbol appears on the screen.



S-CONT (S Multi-Shot)

6 Compose your picture and then press the shutter release button.

- 16 pictures are taken automatically.

M-CONT (M Multi-Shot)

6 Compose your picture and then press and hold the shutter release button.

- The camera memorizes the scene while you hold down the shutter release button.

7 Release your finger from the shutter release button.

- The camera stops shooting and the 16 still images (in the previous 2 seconds) are recorded as one still image.



Note -----

- To return to normal single-image shooting, follow Steps 1 to 3, select [OFF] in Step 4, and press the MENU/OK button.
- In M-CONT mode, if you release the shutter release button within 2 seconds from the time you first pressed it, the shots from the time you pressed the shutter until you released it will be recorded and the number of consecutive shots will be less than 16.
- The flash is turned off.
- During Multi-shot mode, the LCD monitor is turned off.

Viewing an S-CONT or M-CONT Still Image in Enlarged Display Mode

While a still image (16 frames in an image file) taken with S-CONT or M-CONT is displayed, you can enlarge any one of the 16 frames. You can also switch between frames while viewing the image in enlarged display mode.

To view a frame from an S-CONT or M-CONT still image in enlarged display mode, follow the steps below.



1 Press the (Playback) button.

- The last shot taken is displayed.

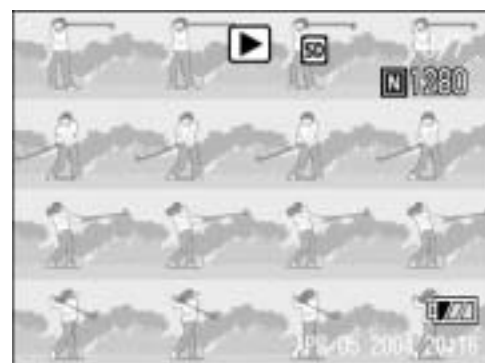
2 Press the buttons to display an S-CONT or M-CONT still image.



3 Press the (Enlarged View) button.

- The first frame of the consecutive images is displayed in enlarged display mode. The frame position bar appears at the bottom of the screen.
- Press the   buttons to switch frames. To return to the 16-frame display, press the MENU/OK button.

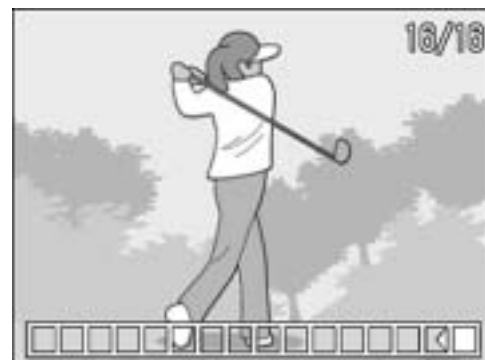

Note

Press the DISP. button to switch between displaying the bar at the bottom of the screen, displaying the grid guide, and hiding the display. (👉 P.54)

Setting the Color Depth (COLOR DEPTH)

You can set the color depth of still images to [VIVID], [NORMAL], [NEUTRAL], or [B&W].

1 Turn the mode dial to /CAL.S.

2 Press the MENU/OK button.

- The Shooting Setting menu is displayed.

3 Press the ▼ button to select [COLOR DEPTH] and press the ► button.

4 Press the ▲▼ buttons to select the desired setting.



5 Press the MENU/OK button, or ◀ button and press the MENU/OK button.

- If you selected a setting other than [NORMAL], the symbol appears on the screen.



Using Long Time Exposure (TIME EXPOSURE)

You can select [1 SEC.], [2 SEC.], [4 SEC.], or [8 SEC.] for time exposure.

By using long time exposure, you can capture the movement of moving subjects such as the trail of fireworks and car lights when shooting a night scene.

- 1** Turn the mode dial to /CAL.S.
- 2** Press the MENU/OK button.
 - The Shooting Setting menu is displayed.
- 3** Press the ▼ button to select [TIME EXPOSURE] and press the ► button.
- 4** Press the ▲▼ buttons to select the desired setting.

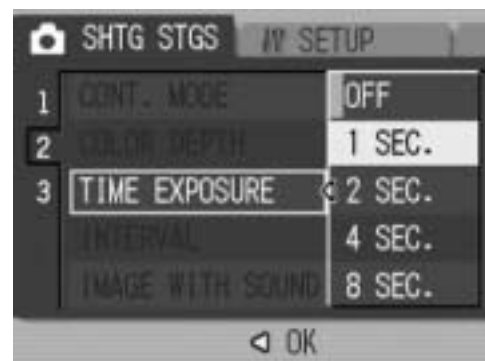

- 5** Press the MENU/OK button, or ◀ button and press the MENU/OK button.

- The setting appears on the screen.



Note

- When using long time exposure, the shutter speed may slow down and images may be blurred. Hold the camera steady by using a tripod when shooting.
- The antiblur function only works when long time exposure is set to [OFF].
- While shooting with long time exposure, the LCD monitor turns off.

Shooting Pictures Automatically at Set Intervals (INTERVAL)

You can set the camera to automatically take pictures at fixed intervals.

You can set the shooting interval from 30 seconds to 3 hours in increments of 30 seconds.

- 1 Turn the mode dial to /CAL.S.
- 2 Press the MENU/OK button.
 - The Shooting Setting menu is displayed.
- 3 Press the ▼ button to select [INTERVAL] and press the ► button.

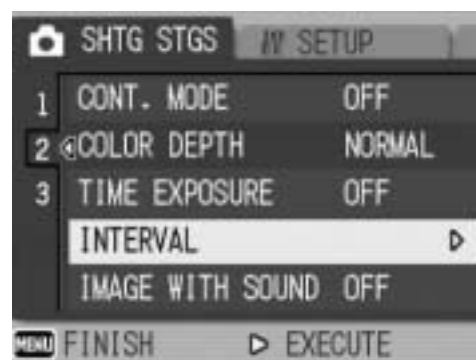

- 4 Press the ▲▼ buttons to set the hours.
- 5 Press the ► button to move to the minutes setting, then use the ▲▼ buttons to set the minutes.
 - You can press and hold either the ▲▼ buttons to quickly raise or lower the minute setting.

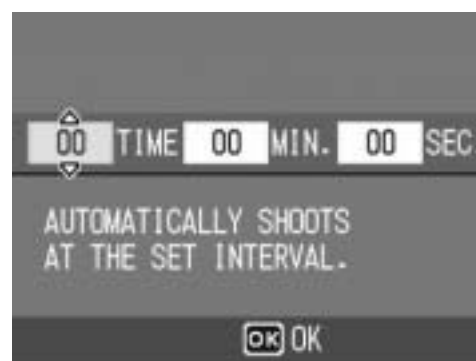

- 6 Press the ► button to move to the seconds setting, then use the ▲▼ buttons to set the seconds.

- 7 Press the MENU/OK button.
 - [INTERVAL] appears on the screen.

- 8 Press the shutter release button to shoot the picture.
 - A picture is taken every time the fixed interval elapses.



- 9 To stop shooting, press the MENU/OK button.



Caution-----

- The interval shooting setting is cleared when the camera is turned off.
- The time until the next picture can be taken according to the shooting menu setting may be longer than the time set for interval shooting. In this case, the shooting interval becomes longer than the set time.



Note-----

- Depending on the remaining battery level, the battery may become depleted during interval shooting. Use of the AC adapter (sold separately) is recommended.
- If you press the shutter release button during interval shooting, the camera will shoot as usual. However, the interval shooting setting is unaffected. After shooting, once the time specified in interval shooting elapses, the next shot is taken.
- When interval shooting is turned on, Multi-shot is automatically set to [OFF] even if it had been set to [M-CONT].

Shooting a Still Image with Sound (IMAGE WITH SOUND)

You can shoot a still image with a voice memo of up to eight seconds.

1 Turn the mode dial to /CAL.S.

2 Press the MENU/OK button.

- The Shooting Setting menu is displayed.

3 Press the ▼ button to select [IMAGE WITH SOUND] and press the ► button.

4 Press the ▲▼ buttons to select [ON].



5 Press the MENU/OK button, or ◀ button and press the MENU/OK button.

- The symbol appears on the screen.

6 Press the shutter release button to shoot the picture.

- The camera starts recording after shooting.



7 Press the shutter release button to finish recording.

- Even if the shutter release button is not pressed, recording automatically stops after 8 seconds.



Note

- To play back a still image with sound, display the still image in the same way as a still image without sound (👉 P.47) and press the ADJ. button to play back the sound.
- Press the ▲▼ buttons during sound playback to display the volume adjustment bar. You can adjust the volume with the ▲▼ buttons.

Inserting the Date into a Still Image (DATE IMPRINT)

You can insert the date (YY/MM/DD) or the date and time (YY/MM/DD hh:mm) at the lower right of a still image.

- 1** Turn the mode dial to /CAL.S.
- 2** Press the MENU/OK button.
 - The Shooting Setting menu is displayed.
- 3** Press the ▼ button to select [DATE IMPRINT] and press the ► button.
- 4** Press the ▲▼ buttons to select the desired setting.



- 5** Press the MENU/OK button, or ◀ button and press the MENU/OK button.
 - The symbol appears on the screen.



Note

- If the date and time have not been set, [DATE IMPRINT] cannot be used. First make the date and time settings (👉 P.119).
- [DATE IMPRINT] cannot be used with movies.

Changing the Exposure (EXPOSURE COMP.)

The exposure setting enables you to select the brightness level for your picture. Normally, if your subject is centered, backlight compensation is automatically activated, and you can shoot with the correct exposure.

In the following cases, or when you intentionally want to change the exposure, you can adjust the exposure setting. Exposure can be specified in the range from -2.0 to +2.0. Setting the level higher (+) makes the picture brighter and lower (-) makes the picture darker.

For backlighting

When the background is particularly bright, the subject will appear dark (underexposed). In this case, set the exposure level higher (+).





When your subject is whitish

The entire picture will turn out dark (underexposed). Set the exposure level higher (+).

When your subject is darkish

The entire picture will turn out bright (overexposed). Set the exposure level lower (-). The same happens when you take a photo of a subject in a spotlight.

To change the setting, use the Shooting Setting menu or the ADJ. button. This section explains easy ways to change the exposure setting with the ADJ. button. To use the Shooting Setting menu, see "Using the Menu" (P.60).

- 1 Turn the mode dial to /CAL.S.**
- 2 Press the ADJ. button and then press the   buttons until the exposure compensation bar appears.**
- 3 Press the   buttons to set the exposure setting.**
 - You can also press the shutter release button to shoot the picture.
- 4 Press the MENU/OK button.**
 - The setting appears on the screen.









Note

When shooting in particularly bright places, you may not be able to correct the exposure level. In that case, the [!AE] symbol will appear on the screen.



Using Natural and Artificial Lighting (WHITE BALANCE)

Adjust the white balance so that a white subject will appear white. At purchase, the white balance is set to [AUTO]. Normally you do not need to change the setting, but if the camera is having difficulty determining the white balance when shooting an object of a single color or when shooting under multiple light sources, you can change the setting.

White Balance Modes

Symbol	Mode	Description
AUTO	AUTO	Adjusts the white balance automatically.
	OUTDOORS	Select this when shooting outdoors (sunny) and white balance fails to adjust properly.
	CLOUDY	Select this when shooting in cloudy weather or shade and the white balance fails to adjust properly.
	INCANDESCENT LAMP	Select this when shooting under incandescent light and white balance fails to adjust properly.
	INCANDESCENT LAMP2	Select this when shooting under incandescent light (more reddish, compared with [INCANDESCENT LAMP]).
	FLUORESCENT LAMP	Select this when shooting under fluorescent light and white balance fails to adjust properly.
	MANUAL SETTINGS	Adjust the white balance manually.

To change the setting, use the Shooting Setting menu or the ADJ. button. This section explains easy ways to change the white balance setting with the ADJ. button. To use the Shooting Setting menu, see "Using the Menu" (P.60).

- 1** Turn the mode dial to /CALC/.
- 2** Press the ADJ. button and then press the ◀▶ buttons until the white balance menu appears.
- 3** Press the ▲▼ buttons to select a setting other than [M].
 - You can also press the shutter release button to shoot the picture.
- 4** Press the MENU/OK button.
 - The symbol appears on the screen.





- Note** -----
- The white balance may not be adjusted correctly for a subject that is mostly dark. In this case, add something white to the subject.
 - When shooting with the flash, the white balance may not be adjusted correctly if [AUTO] is not selected. In this case, switch to [AUTO] to shoot with flash.

Setting the White Balance Manually (MANUAL SETTINGS)

- 1 Turn the mode dial to /CALC/.
- 2 Press the ADJ. button.
- 3 Press the buttons until the white balance menu appears.
- 4 Press the buttons to select [M].
- 5 Point the camera at a piece of paper or something white under the lighting conditions for your picture.
- 6 Press the DISP. button.
 - The white balance is set.
- 7 Press the MENU/OK button.
 - The symbol appears on the screen.
 - The screen is displayed with the white balance set in Step 6. If the result is not as expected, repeat Steps 5 and 6 to change the settings as many times as required.



- Note** -----
- To cancel [MANUAL SETTINGS], select a setting other than [M] in Step 4.

Changing the Sensitivity (ISO SETTING)

ISO sensitivity indicates how sensitive film is to light. A greater value means higher sensitivity. High sensitivity is suitable for shooting an object in a dark place or a fast-moving object while minimizing blurring.

You can choose from the following ISO settings:

AUTO, ISO 64, ISO 100, ISO 200, ISO 400, ISO 800, and ISO 1600. When ISO setting is set to [AUTO], the camera automatically changes the sensitivity according to the distance, brightness, zoom, macro and picture quality/size settings. Usually, use the camera in the [AUTO] mode.

If you do not want to allow the camera to change the ISO sensitivity, select an ISO setting other than [AUTO].

1 Turn the mode dial to /CAL.S.

2 Press the MENU/OK button.

- The Shooting Setting menu is displayed.

3 Press the  button to select [ISO SETTING] and press the  button.

4 Press the   buttons to select the desired setting.

5 Press the MENU/OK button, or  button and press the MENU/OK button.

- The setting appears on the screen.

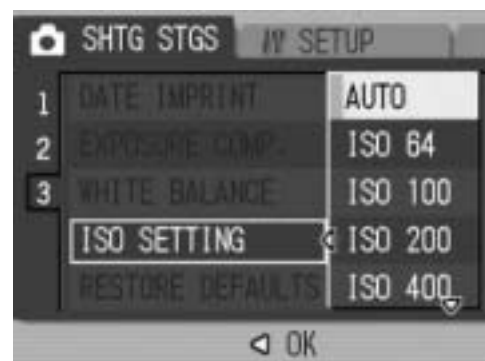

Note

- At the wide-angle zoom setting, when the ISO setting is set to [AUTO], the sensitivity is ISO 125 to 800 with flash or ISO 64 to 351 without flash.
- The antiblur function does not work when the ISO setting is set to a setting other than [AUTO].
- Images shot with a higher sensitivity may appear grainy.

Returning the Shooting Setting Menu Settings to their Defaults (RESTORE DEFAULTS)

To return the Shooting Setting menu settings to their defaults, follow the steps below.

1

1 Turn the mode dial to /CAL.S.

2 Press the MENU/OK button.

- The Shooting Setting menu is displayed.

3 Press the ▲▼ buttons to select [RESTORE DEFAULTS] and press the ► button.

- A confirmation message appears.

4 Make sure that [YES] is selected, and then press the MENU/OK button.

- The display indicates the camera is restoring the initial settings. Once it is finished, the display returns to the shooting mode screen.

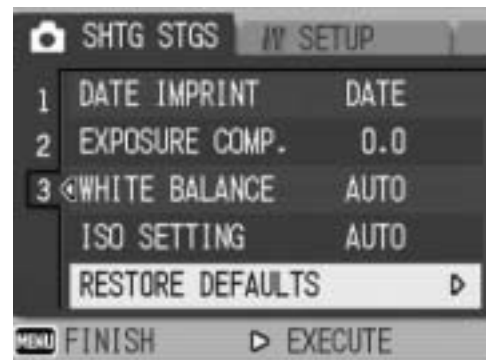

Note

For a list of functions whose settings are saved when the camera is turned off, see "Appendices". (📖 P.238)

2 Shooting/Playing Back Movies

Shooting Movies

You can shoot movies with sound.

You can set the image size to either 320 × 240 or 160 × 120 pixels. You can set the number of frames shot per second (frame rate) to either 30 or 15.

Each movie you shoot is recorded as an AVI file.

- 1 Turn the mode dial to  (movie mode).**

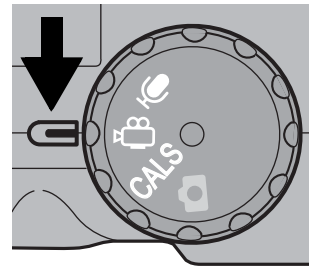

- 2 Press the shutter release button.**

- The camera starts recording. Recording continues until you press the shutter release button again.

- 3 Press the shutter release button to finish recording the movie.**



Caution-----

- While shooting movies, operation sounds may be recorded.
- The maximum recording time per shooting depends on the size of your SD memory card. (👉 P.85) Even if you are within the maximum recording time, recording may end depending on your card.
- The antiblur function does not work in movie mode.

**Note**

- The flash cannot be used.
- While shooting movies, only digital zoom can be used. (👉 P.37)
- When the shutter release button is pressed in Step 2, the camera focuses on the subject.
- The remaining recording time may not change uniformly because it is recalculated from the remaining memory capacity during movie recording.
- Use the Shooting Setting menu to set the image size (👉 P.61) and frame rate (👉 P.84) of movies.
- The Shooting Setting menu items for movie mode differ from those in still image mode. (👉 P.59)

Setting the Frame Rate (FRAME RATE)

You can select the number of shot frames per second (frame rate) in movie mode.

- 1 Turn the mode dial to**
- 2 Press the MENU/OK button.**
 - The Shooting Setting menu is displayed.
- 3 Press the ▼ button to select [FRAME RATE] and press the ► button.**
- 4 Press the ▲▼ buttons to select [30FPS] or [15FPS].**
- 5 Press the MENU/OK button, or ◀ button and press the MENU/OK button.**
 - The setting appears on the screen.

**Movie Frames**

Movies consist of many frames whose images appear to be moving when displayed at high speed.



Note

- Movie recording time may vary depending on the capacity of the recording destination (internal memory or SD memory card), shooting conditions, and the type and manufacturer of the SD memory card.
- The table below shows the approximate recording time.

	Internal Memory	32 MB	64 MB	128 MB	256 MB	512 MB	1 GB
320 × 240 (15 FPS)	1 min 17 s	1 min 27 s	2 min 59 s	6 min 3 s	12 min 4 s	24 min 19 s	46 min 47 s
320 × 240 (30 FPS)	39 s	44 s	1 min 31 s	3 min 4 s	6 min 7 s	12 min 19 s	23 min 42 s
160 × 120 (15 FPS)	4 min 38 s	5 min 16 s	10 min 47 s	21 min 49 s	43 min 29 s	87 min 37 s	168 min 30 s
160 × 120 (30 FPS)	2 min 26 s	2 min 46 s	5 min 40 s	11 min 27 s	22 min 50 s	46 min 1 s	88 min 31 s

Playing Back Movies

To playback movies, follow the steps below.

1 Press the (Playback) button.

- The last shot taken is displayed.
- The first frame of the movie is displayed as a still image.

2 Select the movie you want to view using the buttons.

- Press the button to display the next file.
- Press the button to display the previous file.

3 Press the ADJ. button.

- Playback begins.
The elapsed playback indicator or the elapsed time is displayed on the screen.



Fast Forward	Press the button during playback.
Rewind	Press the button during playback.
Pause/Playback	Press the ADJ. button.
Slow Playback	Press and hold down the button during pause.
Slow Rewind	Press and hold down the button during pause.
Next Frame	Press the button during pause.
Previous Frame	Press the button during pause.
Volume Adjustment	Press the buttons during playback.

3 Recording/Playing Back Sound

Recording Sound

You can record sound.

Recorded data is stored as a WAV file.

- 1 Turn the mode dial to  (voice memo mode).**

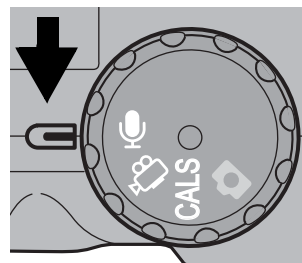

- 2 Press the shutter release button.**

- Sound recording starts.
Recording continues until you press the shutter release button again.

- 3 Press the shutter release button to stop recording.**

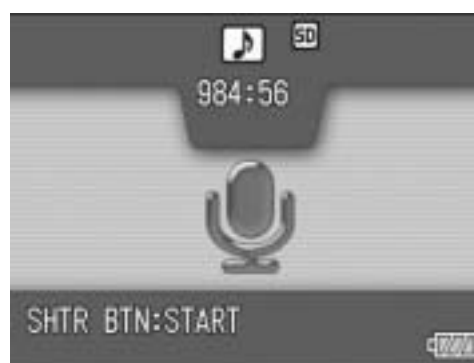

Note

- The voice recording time depends on the capacity of the SD memory card.
- The table below shows the available recording time.

Internal Memory	32 MB	64 MB	128 MB	256 MB	512 MB	1 GB
56 min 45 s	64 min 36 s	132 min 11 s	267 min 15 s	532 min 36 s	1073 min 00 s	2063 min 25 s



Caution

When recording sound for a long time, use of the AC adapter (sold separately) is recommended. ( P.27)



Playing Back Sound

To playback sounds, follow the steps below.

1 Press the (Playback) button.

- The last shot taken is displayed.





2 Press the buttons to select a sound file for playback (indicated with a speaker).

- Press the  button to display the next file.
- Press the  button to display the previous file.



3 Press the ADJ. button.

- Playback begins.
The elapsed playback indicator or the elapsed time is displayed on the screen.

Fast Forward	Press the  button during playback.
Rewind	Press the  button during playback.
Pause/Playback	Press the ADJ. button.
Volume Adjustment	Press the   buttons during playback.

4 Other Playback Functions

Playback Setting Menu

Press the MENU/OK button in playback mode to display the Playback Setting menu. The Playback Setting menu allows you to make the settings for the following functions.

Setting	Options	Refer to
SLIDE SHOW	_____	P.89
PROTECT	Select/Cancel 1 FILE, Select/Cancel ALL FILES, Select Multi-files	P.90
DPOF	Select/Cancel 1 FILE, Select/Cancel ALL FILES, Select Multi-files	P.93
RESIZE	1280, 640	P.96
COPY TO CARD	_____	P.97
PRINT	_____	P.157
FILE SEND	_____	P.166







Note

The SETUP menu (👉 P.106) and EXP SET (👉 P.155) menu can be accessed from within the Playback Setting menu.

Using the Menu

This explains how to make the settings.

- 1 Press the  (Playback) button to select the playback mode.**
- 2 Press the MENU/OK button.**
 - The Playback Setting menu appears.
- 3 Press the   buttons to select the desired item.**
- 4 Press the  button.**
 - The screen for the selected menu item appears.

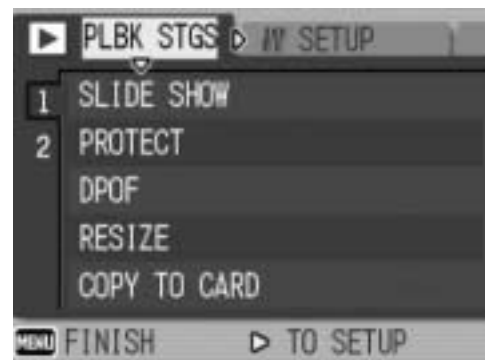

Displaying Photos in Order Automatically (SLIDE SHOW)

You can display the recorded still images, movies, and sound files sequentially on the screen. This is called a slide show. To view a slide show, follow the steps below.

1 Press the (Playback) button.

- The last shot taken is displayed.

2 Press the MENU/OK button.

- The Playback Setting menu appears.

3 Press the button to select [SLIDE SHOW] and press the button.

- The slide show starts and files are played back in order.
- If you want to stop the slide show in progress, press any button on the camera.
The slide show will repeat itself until stopped.

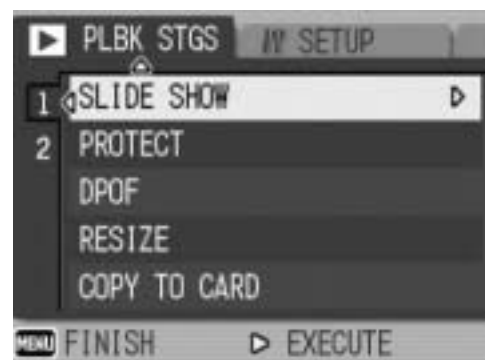

Note

- Each still image is displayed for three seconds.
- For movies, not just one frame, but the entire movie you shot is played back.
- Sound files are also played back.

Write-protecting Files (PROTECT)

You can protect files from being accidentally deleted.



Caution

Protected files cannot be deleted normally. However, they will be deleted if you format the memory where the files are stored.

Protecting a File

1 Press the (Playback) button.

- The last shot taken is displayed.

2 Press the buttons to display the file you want to protect.

3 Press the MENU/OK button.

- The Playback Setting menu appears.

4 Press the button to select [PROTECT] and press the button.

5 Make sure that [1 FILE] is selected, and then press the MENU/OK button.

- The selected file is protected and the  symbol appears on the screen.

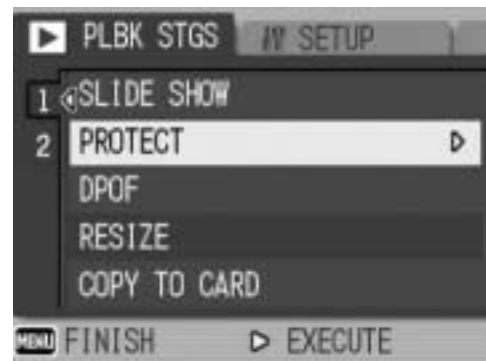

Note

To unprotect a file, display the file you want to unprotect and perform Steps 3 to 5.

Protecting All Files

To protect all your files, follow the steps below.

1 Press the  (Playback) button.

2 Press the MENU/OK button.

- The Playback Setting menu appears.

3 Press the  button to select [PROTECT] and press the  button.

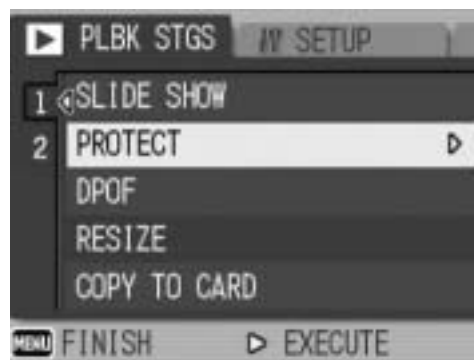

4 Press the   buttons to select [ALL FILES].

5 Make sure that [SELECT] is selected, and then press the MENU/OK button.

- All files are protected and the symbol appears on the screen.



Note

To cancel protection for all protected files, select [CANCEL] in Step 5.

Protecting Multiple Files at Once

To protect selected files all at once, follow the steps below.

1 Press the  (Playback) button.

2 Press the  (Thumbnail Display) button twice.

- The screen is divided into 12 frames and thumbnails are displayed.

3 Press the     buttons to select the first file you want to protect.



4 Press the MENU/OK button.

- The Playback Setting menu appears.

5 Press the  button to select [PROTECT] and press the  button.

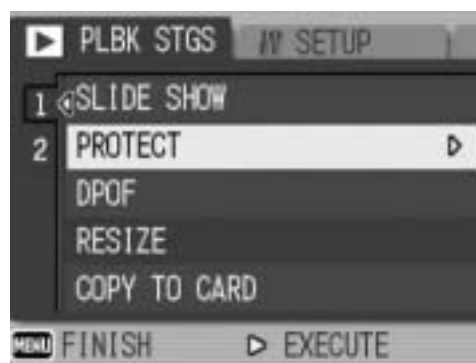
- The Protect symbol appears in the upper-right corner of the file.



6 Press the     buttons to select the next file you want to protect, and then press the MENU/OK button.

7 Repeat Step 6 to select all the files you want to protect.

- If you selected a file by mistake, you can deselect by selecting the file and pressing the MENU/OK button again.

8 Press the DISP. button.

- The display indicates that the selected images are being processed; once finished, the display returns to the thumbnail display screen.



Note





- To unprotect multiple files, follow the same steps described above to select the files to unprotect, and then press the DISP. button.
- You can also unprotect all files at once. (👉 P.91)
- For information on thumbnail display, see P.48.

Using a Printing Service (DPOF)

The still images recorded on an SD memory card can be printed out if you take them to a store that offers a digital camera print service. To use a print service, you must make print settings on your camera. These settings are called Digital Print Order Format (DPOF) settings.

The DPOF setting specifies one print per still image. When making DPOF settings in list view, you can also specify the number of copies to print. (👉 P.95)

Setting DPOF for the Displayed Still Image

- 1** Press the  (Playback) button.
- 2** Press the  buttons to display the still image for which you want to make the DPOF setting.
- 3** Press the MENU/OK button.
 - The Playback Setting menu appears.
- 4** Press the  button to select [DPOF] and press the  button.
- 5** Make sure that [1 FILE] is selected, and then press the MENU/OK button.
 - Once the DPOF setting is made, the DPOF symbol appears on the screen.

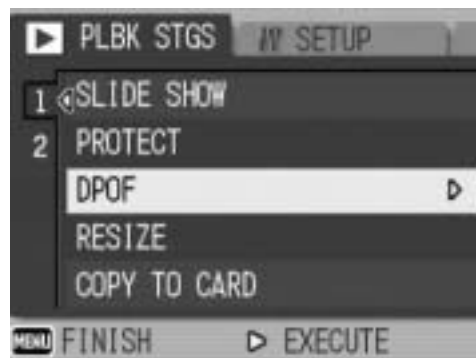

Note

To remove the DPOF setting, display the still image with the DPOF setting and perform Steps 3 to 5.

Setting DPOF for All Still Images

To apply DPOF settings to all your still images, follow the steps below.

1 Press the  (Playback) button.

2 Press the MENU/OK button.

- The Playback Setting menu appears.

3 Press the  button to select [DPOF] and press the  button.

4 Press the   buttons to select [ALL FILES].

5 Make sure that [SELECT] is selected, and then press the MENU/OK button.

- Once the DPOF setting is made, the DPOF symbol appears on the screen.

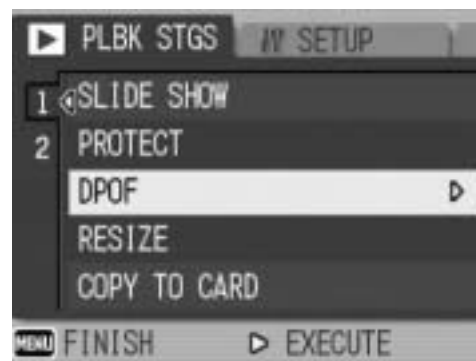













Note

To cancel the DPOF settings for all still images with DPOF settings, select [CANCEL] in Step 5.

Setting DPOF for Multiple Still Images

To make the DPOF settings for selected still images all at once, follow the steps below.

- 1** Press the  (Playback) button.
- 2** Press the  (Thumbnail Display) button twice.
 - The screen is divided into 12 frames and thumbnails are displayed.
- 3** Press the  buttons to select the first still image for which you want to make the DPOF setting.
- 4** Press the MENU/OK button.
 - The Playback Setting menu appears.
- 5** Press the  button to select [DPOF] and press the  button.
- 6** Press the  buttons to set the number of copies to print.
 - Press the  button to increase the number of copies, or press the  button to decrease the number of copies.
- 7** Press the  buttons to select the next still image for which you want to make the DPOF setting.
- 8** Press the  buttons to set the number of copies to print.
 - Press the  button to increase the number of copies, or press the  button to decrease the number of copies.
- 9** Repeat Steps 7 and 8 to select all the still images for which you want to make the DPOF setting.
- 10** Press the MENU/OK button.
 - The display indicates that the selected images are being processed; once finished, the display returns to the thumbnail display screen.

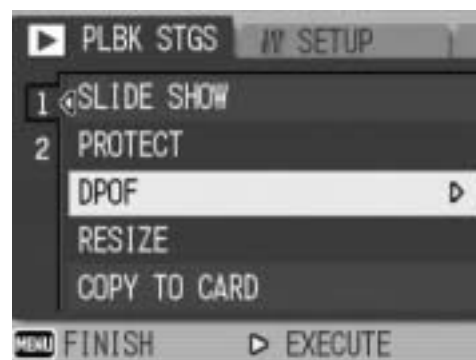

Note

- To remove the DPOF settings for multiple still images, follow the same steps described above to set the number of copies to print to [0] for each image, and then press the MENU/OK button.
- You can also cancel the DPOF settings for all still images at once. (👉 P.94)

Changing the Image Size (RESIZE)

You can reduce the image size of a shot still image to create a new file with a different image size.

Original	Resized	
F3264/N3264/N2592/N2048	N1280	N640
F1280/N1280	N640	



Caution

You can resize only still images and still images with voice memos. Movies cannot be resized.

To change the image size, follow the steps below.

1 Press the  (Playback) button.

2 Press the  buttons to display the file with the image size you want to change.

3 Press the MENU/OK button.

- The Playback Setting menu appears.

4 Press the  button to select [RESIZE] and press the  button.

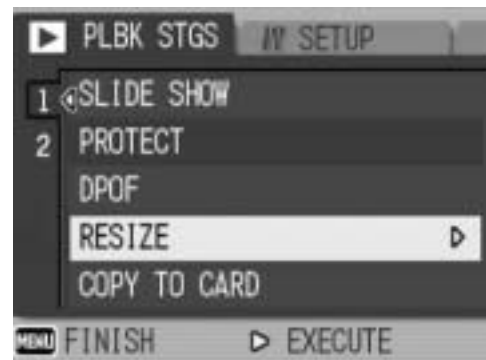

5 Press the  buttons to select [1280] or [640].

6 Press the MENU/OK button.

- The display indicates that the image is being processed, and then the still image with the changed image size is displayed. The image before the image size is changed is also recorded.





Note

You can also change the image size during shooting. (👉 P.61)

Copying the Contents of the Internal Memory to an SD Memory Card (COPY TO CARD)

You can copy all movies, still images, and sound data stored in the internal memory onto an SD memory card at once.

- 1** Turn the camera off.
- 2** Insert an SD memory card.
- 3** Turn the camera on.
- 4** Press the  (Playback) button.
- 5** Press the MENU/OK button.
 - The Playback Setting menu appears.
- 6** Press the  button to select [COPY TO CARD] and press the  button.
 - The display indicates copying is in progress; once finished, the display returns to the playback screen.

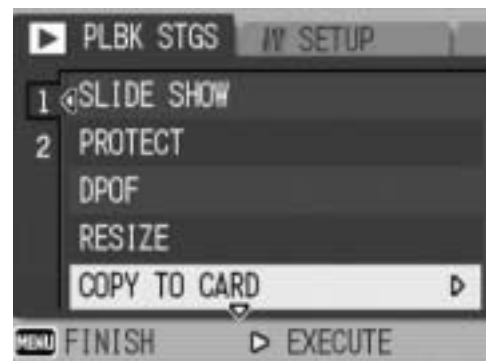

Note

- If the capacity of the SD memory card to which you are copying is insufficient, a message will be displayed indicating there is not enough capacity. To copy only the number of shots that will fit into the available capacity, select [YES] and then press the MENU/OK button. To cancel copying, select [NO] and then press the MENU/OK button.
- It is not possible to copy the contents of an SD memory card to the internal memory.

Direct Print Function

The Direct Print standard enables direct printing from a camera to a printer by connecting them via a USB cable. Photos can be printed quickly and easily from your digital camera without using a computer.



Caution-----

- You cannot print movies (AVI files) with this function. For still images with sounds (JPG files with WAV files), only the still images (JPG files) are printed.
- Some printers do not support images taken in text mode (TIFF files) (☞ P.40). Even when TIFF images are printed, their printed contents cannot be guaranteed.



Note-----

- This camera uses PictBridge, an industry standard for Direct Printing.
- Your printer must be compatible with PictBridge to use the Direct Print function. For support information, see the documentation that came with the printer.
- For some printers, Direct Print may not be available when [MASS STR] is selected for [USB CONNECTION] (☞ P.123) in the SETUP menu of the camera. In such cases, select [ORIGINAL] instead.

Connecting the Camera to a Printer

Connect your camera to a printer using the USB cable provided.

1 Make sure that the camera is off.

2 Turn the terminal cover knob of the camera in the direction of the arrow to open the cover.

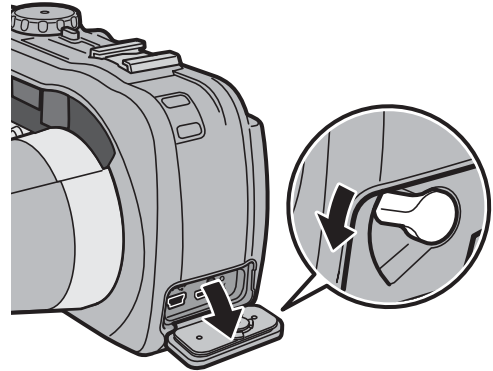

3 Connect your camera to a printer using the USB cable provided.

- Turn on the printer if it is not already on.

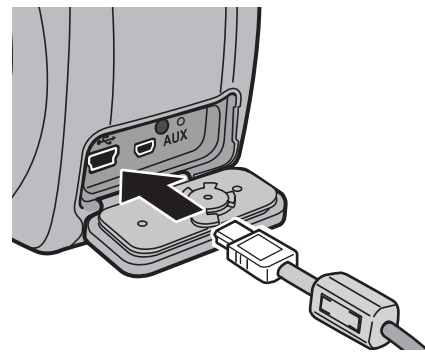

Caution-----

Before opening or closing the battery/card cover or terminal cover, be sure to remove any water, sand or mud adhering to the camera, and avoid opening and closing the cover in places where such contaminants may get inside the camera.



Note-----

To disconnect the camera from the printer, check that the power is off on both units before disconnecting the USB cable between them.

Printing Still Images

You can print still images from the camera with a PictBridge-compatible printer.

Still images are sent from the internal memory when no SD memory card is loaded or from an SD memory card when one is loaded.



Caution

Do not disconnect the USB cable during printing.



Note

If a [PRINTER ERROR] message appears during image transfer, check the printer status and take the appropriate action.

Printing One or All Still Images

1 Check that the printer is ready to print.

- The [CONNECTING...] screen appears.



2 Press the ADJ. button.

- The Direct Print playback mode screen appears.

3 Press the ◀▶ buttons to select an image for printing.

4 Press the ADJ. button.

5 Press the ▲▼ buttons to select [1 FILE] or [ALL FILES].

6 Press the MENU/OK button.

- The Direct Print menu appears.



7 Press the ▲▼ buttons to select an item, and then press the ► button to display the detailed options screen.

- When [CONNECTING...] is displayed, the connection to the printer is not yet established. When a connection is established, [CONNECTING...] disappears and [DIRECT PRINT] appears. Proceed with this step after the connection is established.
- The following items can be selected. Each item appears only when supported by the printer connected to the camera. The items marked with an asterisk (*) appear only when [REPORT PRINT] is supported by a Ricoh printer connected to the camera.

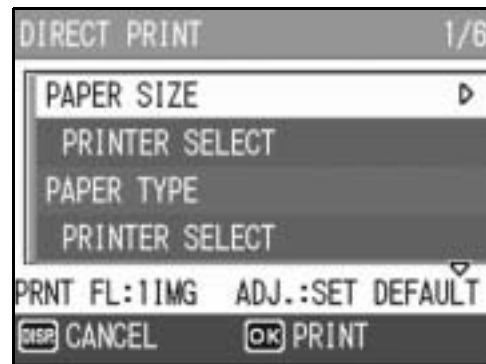

Item Name	Description
PAPER SIZE	Sets the paper size.
PAPER TYPE	Sets the paper type.
LAYOUT	Sets the number of images printed on a sheet of paper. The number of images that can be laid out on a sheet of paper varies depending on the connected printer.
DATE PRINT	Selects whether to print the date (shooting date). The date format can be set using the date/time option in the SETUP menu.
FILE NAME PRINT	Selects whether to print the file name.
OPTIMIZE IMAGE	Selects whether to optimize the image data (still image) prior to printing on the printer.
PRINT SIZE	Sets the print image size.
PRINT QUALITY	Sets the print quality.
REPORT PRINT*	Prints on forms. (☞ P.104)
MEMO PRINT*	When printing a report for an image with a camera memo, the contents of the camera memo can be printed in the report. (☞ P.105) Depending on the layout selected with [REPORT PRINT], the camera memo may not be printed. In this case, delete some of the information in the camera memo.

8 Press the ▲▼ buttons to select the setting, and then press the MENU/OK button.

- The display returns to the Direct Print menu.

9 Repeat Steps 7 and 8 to change other settings as required.



Note

- To specify the settings as the default settings next time the camera is connected to the printer, press the ADJ. button when the screen in Step 7 is displayed. When the screen at the right appears, press the ◀▶ buttons to select [SET] and press the MENU/OK button.
- To use the settings last set the next time the camera is connected to the printer, select [CANCEL].



10 Press the MENU/OK button.

- The selected still images are sent to the printer and the [SENDING...] screen appears.
- Pressing the DISP. button cancels the operation.
- When the images have been sent to the printer, the display returns to the Direct Print playback mode screen and printing starts.

Printing Several Still Images

1 Check that the printer is ready to print.

- The [CONNECTING...] screen appears.



2 Press the ADJ. button.

- The Direct Print playback mode screen appears.

3 Press the (Thumbnail Display) button.

- The screen is divided into 12 frames and thumbnails are displayed.

4 Press the ▲▼◀▶ buttons to select an image for printing.

5 Press the MENU/OK button.

6 Press the ▲▼ buttons to set the number of copies to print.

- Press the ▲ button to increase the number of copies, or press the ▼ button to decrease the number of copies.

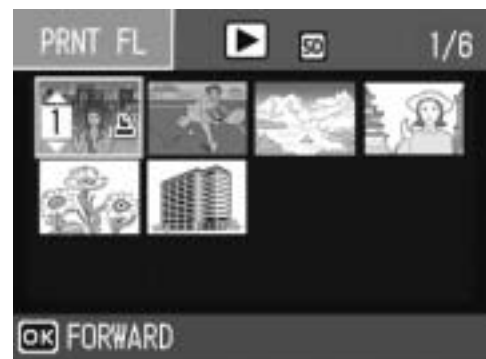

7 Press the ◀▶ buttons to select the next image for printing.

8 Press the ▲▼ buttons to set the number of copies to print.

9 Repeat Steps 7 and 8 to select all the still images to be printed and the number of copies for each.

10 Press the MENU/OK button.

- The Direct Print menu appears.

11 Press the ▲▼ buttons to select an item, and then press the ► button to display the detailed options screen.

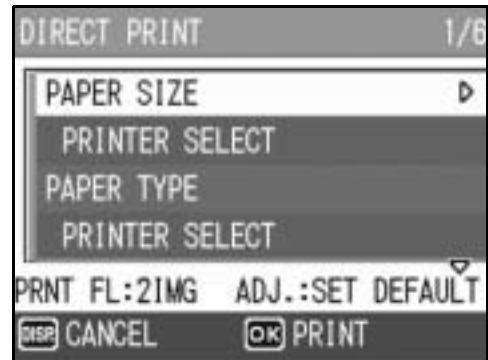

- When [CONNECTING...] is displayed, the connection to the printer is not yet established. When a connection is established, [CONNECTING...] disappears and [DIRECT PRINT] appears. Proceed with this step after the connection is established.
- For available settings, see P.101.

12 Press the ▲▼ buttons to select the setting, and then press the MENU/OK button.

- The display returns to the Direct Print menu.

13 Repeat Steps 11 and 12 to change other settings as required.

14 Press the MENU/OK button.

- The selected still images are sent to the printer and the [SENDING...] screen appears.
- Pressing the DISP. button cancels the operation.
- When all the selected still images have been sent from the camera to the printer, the camera display returns to the Direct Print playback mode screen.



Note -----

- Only images with a printer mark () are printed. If you cancel printing and then try to print again, make sure that the printer mark is on the images you want to print.
- The same still image can also be printed several times on a single sheet.
- The available items vary depending on the functions of the printer.
- To print images using the printer's default settings, select [PRINTER SELECT] on the detailed options screen.

Printing Reports

Select [REPORT PRINT] on the Direct Print menu. [REPORT PRINT] appears only when connected to a Ricoh printer that supports PictBridge. For the latest information about Ricoh printers, visit the Ricoh website at <http://www.ricoh.com/>.

The layout that can be selected depends on the connected printer. For more details, see the documentation that came with the printer.

Available Layouts

1FRAME W/RULE	2FRAMES W/RULE	3FRAMES W/RULE	4FRAMES W/RULE
1FRAME W/O RULE	2FRAMES W/O RULE	3FRAMES W/O RULE	4FRAMES W/O RULE
CONST. PHOTO 1	W/REMARK SECTION		

Examples of Printed Reports



1FRAME W/RULE



2FRAMES W/RULE



CONST. PHOTO 1

Printing a Camera Memo on a Report

To print a camera memo on a report, select [REPORT PRINT] on the Direct Print menu and set [MEMO PRINT] to [ON].

Example of Printed Report with Camera Memo

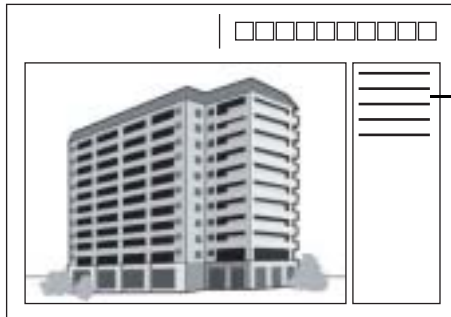

W/REMARK SECTION

The content of the camera memo is printed. The position of the printed camera memo depends on the layout set in [REPORT PRINT].



Note

For details about the camera memo, refer to the "Software User Guide".

6 Changing Camera Settings

SETUP Menu

You can change the camera settings by displaying the SETUP menu from the Shooting Setting menu (👉 P.59) or Playback Setting menu (👉 P.88).

The SETUP menu enables you to set the items listed in the table below.

Setting	Options [Default Settings]	Refer to
FORMAT [CARD]	_____	P.109
FORMAT [INT. MEM.]	_____	P.110
LCD BRIGHTNESS	_____	P.111
ADJ BTN. SET.1* ¹ ADJ BTN. SET.2* ²	[OFF]* ² , ISO, QUALITY, FOCUS, SHARP, METERING, CONT MDE, [ANTIBLUR]* ¹	P.112
AUTO POWER OFF	OFF, [1 MIN.], 5 MIN., 30MIN.	P.113
BEEP SOUND	[ALL], SHUTTER	P.114
VOL. SETTINGS	□ □ □ (OFF), ■ □ □ (Small), [■ ■ □] (Medium), ■ ■ ■ (Large)	P.115
LCD CONFIRM.	OFF, 0.5SEC., [1 SEC.], 2 SEC., 3 SEC.	P.116
SEQUENTIAL NO.	ON, [OFF]	P.117
DATE SETTINGS	_____	P.119
LANGUAGE/言語	日本語, [ENGLISH]	P.120
STEP ZOOM	ON, [OFF]	P.121
SHTG STGS WARNG.	[ON], OFF	P.122
USB CONNECTION	MASS STR, [ORIGINAL]	P.123
ENLGE PHOTO ICON	ON, [OFF]	P.125
REG. MY SETTINGS	[SETTING1], SETTING2	P.126
START SETTINGS	[OFF], SETTING1, SETTING2	P.127

Using the SETUP Menu

This explains how to make the settings.

Use the ▲▼▶ buttons and MENU/OK button to select and set an item.

1 Press the MENU/OK button.

- The Shooting Setting menu (or the Playback Setting menu) appears.

2 Press the ▶ button.

- The SETUP menu appears.

The menu items are provided on four screens.

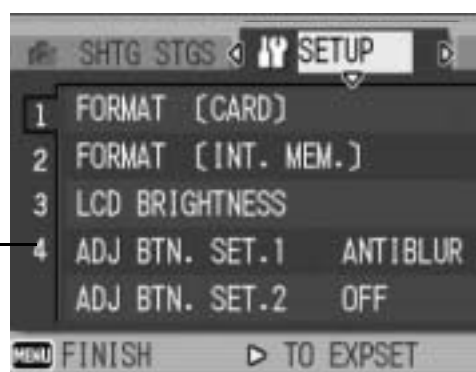

3 Press the ▲▼ buttons to select the desired item.

- Press the ▼ button at the bottom item to display the next screen.

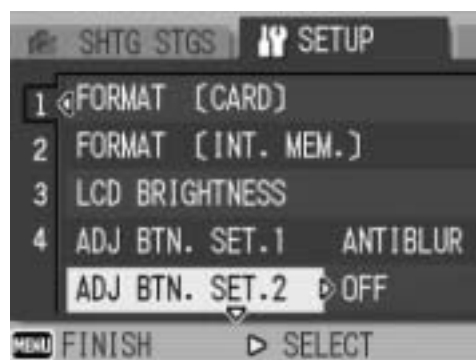

4 Press the ▶ button.

- The menu item settings are displayed.

5 Press the ▲▼ buttons to select the setting.

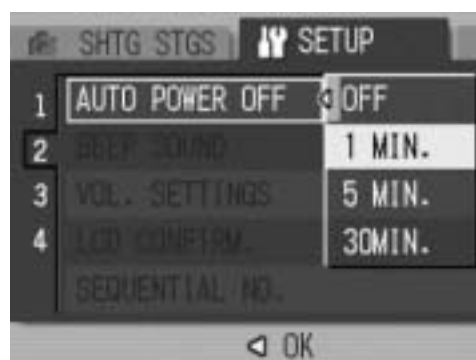

6 Press the MENU/OK button, or ◀ button and press the MENU/OK button.

- The SETUP menu disappears and the camera is ready for shooting or playback.
- The SETUP menu may appear depending on the setting. In this case, press the MENU/OK button again to return to the shooting or playback screen.



Note

For some functions, the setting selection method may differ from what is explained here. For detailed operation, see the explanation of each function.



Changing the display

- You can select a screen by the screen number:
 - 1 Press the ◀ button to select a screen number on the left of the screen.
 - 2 Press the ▲▼ buttons to change screens.
 - 3 Press the ▶ button to return to menu item selection.

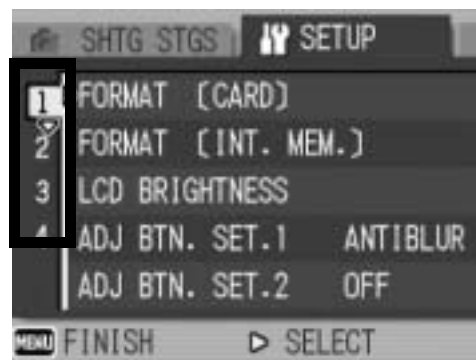

Preparing the SD Memory Card (FORMAT [CARD])

If the error message [CARD ERROR] is displayed when an SD memory card is loaded into the camera or the card has been used with a computer or other device, you must format the card prior to use with this camera.

Formatting is the process of preparing a card so image data can be written on it.



Caution-----

If you format a card that still has images stored on it, the images will be lost.

To format a card, follow the steps below.

1 Display the SETUP menu.

- For the operating procedure, see P.107.

2 Press the ▼ button to select [FORMAT [CARD]] and press the ► button.

- A screen appears to confirm formatting.

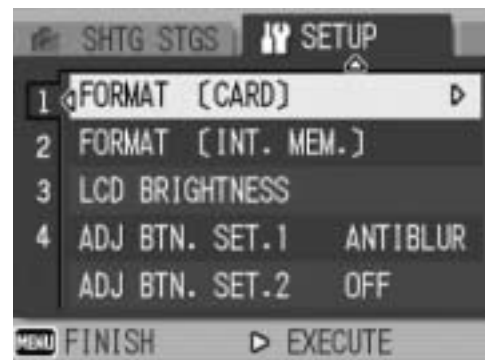

3 Press the ◀▶ buttons to select [YES] and then press the MENU/OK button.

- Formatting starts. When it is done, the display returns to the SETUP menu.
- If no SD memory card is loaded, a message will be displayed. After turning the power off, load an SD memory card and repeat the formatting process again.

4 Press the MENU/OK button.



Protecting your images from being deleted-----

- Move the write-protection switch on the SD memory card to "LOCK" to prevent your still images from being accidentally erased or the card from being formatted. (P.22)
- If you unlock the card (by returning the switch to its original position), it is once again possible to erase images and format the card.

Formatting the Internal Memory (FORMAT [INT. MEM.])

If the error message [FORMAT INTERNAL MEMORY] is displayed, you must format the internal memory prior to use.



Caution-----

Formatting the internal memory deletes all of the images recorded in the memory. If you have images in the internal memory that you do not want to delete, copy the images to the SD memory card before formatting the internal memory. (☞ P.97)

To format the internal memory, follow the steps below.

1 Display the SETUP menu.

- For the operating procedure, see P.107.

2 Press the ▼ button to select [FORMAT [INT. MEM.]] and press the ► button.

- A screen appears to confirm formatting.

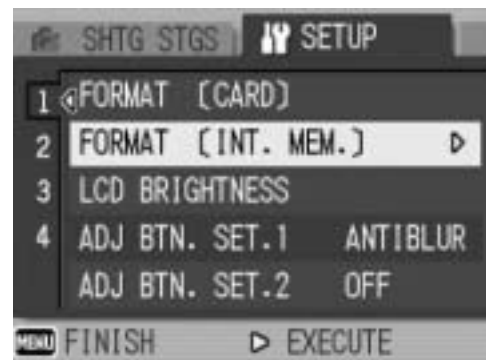

3 Press the ◀▶ buttons to select [YES] and then press the MENU/OK button.

- Formatting starts. When it is done, the display returns to the SETUP menu.

4 Press the MENU/OK button.

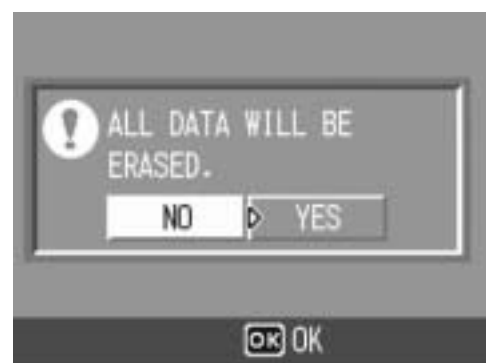

Adjusting the Brightness of the LCD Monitor (LCD BRIGHTNESS)

To adjust the brightness of the LCD monitor, follow the steps below.

1 Display the SETUP menu.

- For the operating procedure, see P.107.

2 Press the ▼ button to select [LCD BRIGHTNESS] and press the ► button.

- The screen for setting the brightness appears.

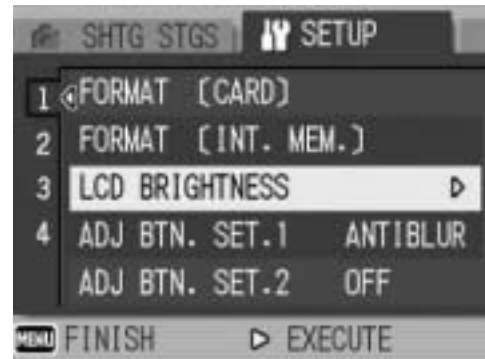

3 Press the ▲▼ buttons to adjust the brightness.

- Move the slider on the LCD brightness adjustment bar down to make the LCD monitor darker and up to make it brighter. The brightness of the LCD monitor changes as the slider is moved along the bar.



4 When you reach the desired brightness, press the MENU/OK button.

- The display returns to the SETUP menu.

5 Press the MENU/OK button.



Using the DISP. button to adjust the brightness -----

When shooting, press and hold down the DISP. button to maximize the LCD brightness. When the brightness is at the maximum setting, holding the DISP. button down returns the brightness to the level set in [LCD BRIGHTNESS].

Assigning a Function to the ADJ. Button (ADJ BTN. SET.)

You can use the ADJ. button to display the screens for setting the exposure compensation and white balance with fewer button operations and without displaying the Shooting Setting menu. You can also use [ADJ BTN. SET.1] and [ADJ BTN. SET.2] to add a camera function that can be activated by pressing the ADJ. button.

Available Settings	Refer to
OFF *Default setting for [ADJ BTN. SET.2]	-
ISO (ISO SETTING)	P.81
QUALITY (PIC QUALITY/SIZE)	P.61
FOCUS	P.64
SHARP (SHARPNESS)	P.68
METERING (PHOTOMETRY)	P.67
CONT MDE (CONT. MODE)	P.69
ANTIBLUR *Default setting for [ADJ BTN. SET.1]	P.63

To assign a function to either [ADJ BTN. SET.1] or [ADJ BTN. SET.2], follow the steps below.

- 1 Display the SETUP menu.**
 - For the operating procedure, see P.107.
- 2 Press the ▼ button to select [ADJ BTN. SET.1] or [ADJ BTN. SET.2], and then press the ► button.**
- 3 Press the ▲▼ buttons to select the desired setting.**
- 4 Press the MENU/OK button, or ◀ button and press the MENU/OK button.**



Note

For information on how to use the ADJ. button, see P.56.

Changing the Auto Power Off Setting (AUTO POWER OFF)

If you do not operate the camera for a set period of time, it will shut off automatically to conserve battery power (Auto Power Off). By default, auto power off is set to one minute, but you can change this setting.

Available Settings

OFF (Auto Power Off is turned off)

1 MIN. *Default setting

5 MIN.

30MIN.

To change the auto power off setting, follow the steps below.

1 Display the **SETUP** menu.

- For the operating procedure, see P.107.

2 Press the ▼ button to select [AUTO POWER OFF] and press the ► button.

3 Press the ▲▼ buttons to select the desired setting.

4 Press the MENU/OK button, or ◀ button and press the MENU/OK button.

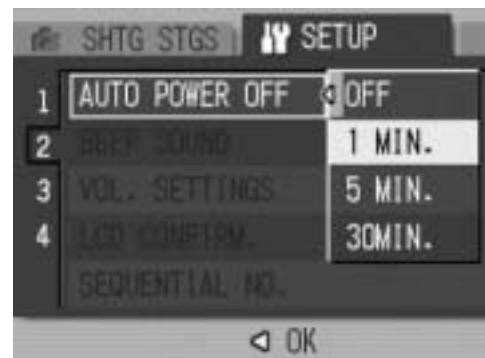

Note

- To continue using the camera after auto power off turned the camera off, press the power button to turn the camera on again. You can also press and hold the ► (Playback) button for more than one second to turn on the camera in playback mode.
- Auto power off does not work when the camera is connected to a computer or printer.
- When using interval shooting, the [AUTO POWER OFF] setting is not valid and auto power off does not work.

Changing the Beep Sound Setting (BEEP SOUND)

During operation, the camera generates four types of sounds: start sound, shutter release sound, focus sound, and beep sound.

- Start sound : Sound when the camera is turned on.
- Shutter release sound : Sound when the shutter release button is pressed.
- Focus sound : Sound when the shutter release button is half-pressed and the camera focuses on the subject.
- Beep sound : Error sound indicating an operation that cannot be performed.

Available Settings

ALL (All sounds on) *Default setting

SHUTTER (Shutter release sound and beep sound only)

To change the beep sound settings, follow the steps below.

- 1 Display the SETUP menu.**
 - For the operating procedure, see P.107.
- 2 Press the ▼ button to select [BEEP SOUND] and press the ► button.**
- 3 Press the ▲▼ buttons to select the desired setting.**
- 4 Press the MENU/OK button, or ◀ button and press the MENU/OK button.**



Changing the Beep Sound Volume (VOL. SETTINGS)

The beep sound volume can be changed.

Available Settings

- (Mute)
- (Small)
- (Medium) *Default setting
- (Large)

To change the beep sound volume, follow the steps below.

1 Display the **SETUP** menu.

- For the operating procedure, see P.107.

2 Press the ▼ button to select [VOL. SETTINGS] and press the ► button.

3 Press the ▲▼ buttons to select the desired setting.

4 Press the MENU/OK button, or ◀ button and press the MENU/OK button.



Changing Image Confirmation Time (LCD CONFIRM.)

Immediately after you press the shutter release button, the still image taken is displayed on the screen for a moment so you can check it. By default, the image confirmation time is set to 1 second, but this can be changed.

Available Settings

OFF (Image not displayed for confirmation)

0.5SEC.

1 SEC. *Default setting

2 SEC.

3 SEC.

To change the image confirmation time, follow the steps below.

1 Display the **SETUP** menu.

- For the operating procedure, see P.107.

2 Press the ▼ button to select [LCD CONFIRM.] and press the ► button.

3 Press the ▲▼ buttons to select the desired setting.

4 Press the MENU/OK button, or ◀ button and press the MENU/OK button.

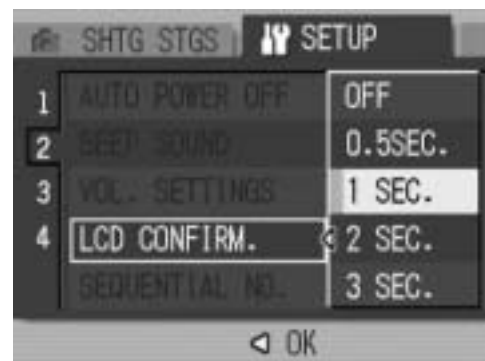

Caution

When [LCD CONFIRM.] is set to 0.5 seconds, symbols such as the zoom bar may remain on the monitor while the image is displayed.

Changing File Name Settings (SEQUENTIAL NO.)

When you shoot a still image, it is stored on an SD memory card or in the internal memory with a consecutively numbered file name that is automatically assigned.

When you switch SD memory cards, you can set your camera to continue consecutive numbering from the previously loaded card.

Available Settings	
ON (Continue numbering)	File names are automatically assigned to still images you take, in the format of "R" followed by seven digits, from R0010001.jpg to R9999999.jpg. With this setting, file numbering is continued from one card to the next.
OFF (Do not continue numbering) *Default setting	File numbering is assigned, from RIMG0001.jpg to RIMG9999.jpg, for each SD memory card. When file name RIMG9999 is reached, no more data can be recorded to that card.

To change the file name setting, follow the steps below.

1 Display the **SETUP** menu.

- For the operating procedure, see P.107.

2 Press the ▼ button to select **[SEQUENTIAL NO.]** and press the ► button.

3 Press the ▲▼ buttons to select the desired setting.

4 Press the MENU/OK button, or ◀ button and press the MENU/OK button.

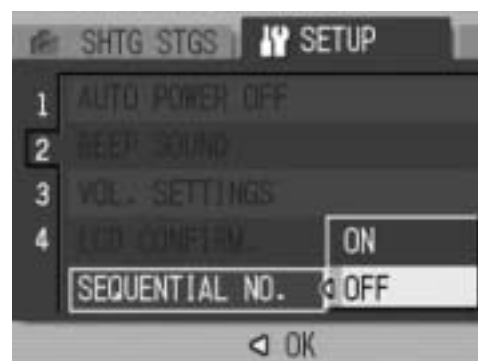



Note

- When recording data to the internal memory, files are assigned consecutively numbered file names, just as if [SEQUENTIAL NO.] is set to [OFF].
- When transferring images to a computer using RICOH Gate La (🖱️ P.150), the file being transferred is renamed and saved. The file is saved with the name “RIMG****.jpg” (where **** indicates a number) even if [SEQUENTIAL NO.] is set to [ON].
- When RIMG9999 is reached, no more files can be saved. In this case, move image data from the SD memory card to the memory of the computer or a storage medium, and then format the SD memory card.

Setting the Date and Time (DATE SETTINGS)

You can take still images with the time or date stamped onto the picture.

The date/time setting on the SETUP menu is explained here.

1 Display the SETUP menu.

- For the operating procedure, see P.107.

2 Press the ▼ button to select [DATE SETTINGS] and press the ► button.



3 Press the ▲▼◀▶ buttons to set the year, month, date and time.

- You can press and hold down the ▲▼ buttons to quickly raise or lower the setting.
- Press the ◀▶ buttons to move to the next item.

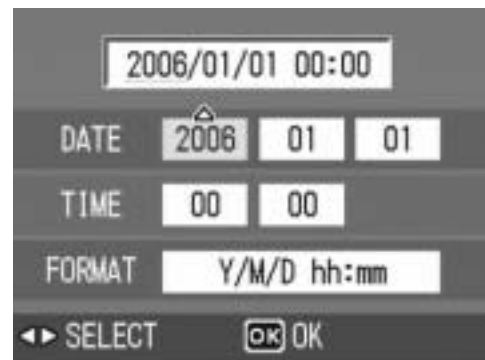

4 In [FORMAT], choose the date and time format.

5 Check the information on the screen and then press the MENU/OK button.

- Once you have set the date and time, the display returns to the SETUP menu.

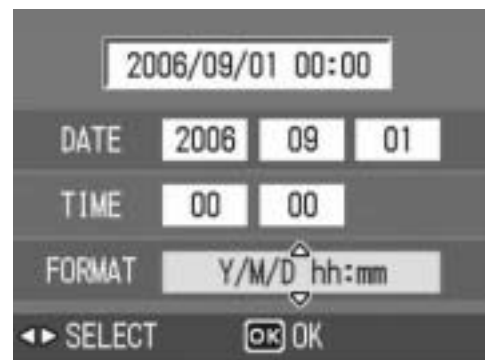

6 Press the MENU/OK button.



Note

- If the battery is removed for more than one week, the date and time settings will be lost. These settings must be made again.
- To retain the date and time settings, load a battery with adequate remaining power for more than two hours.

Changing the Display Language (LANGUAGE/言語)

You can change the language displayed on the screen.

Available Settings

日本語 (Japanese)

ENGLISH *Default setting

To change the display language, follow the steps below.

1 Display the SETUP menu.

- For the operating procedure, see P.107.

2 Press the ▼ button to select [LANGUAGE/言語] and press the ► button.

- The language selection screen appears.



3 Press the ▲▼ buttons to select the desired setting.

4 Press the MENU/OK button.

- Once you have set the language, the display returns to the SETUP menu.

5 Press the MENU/OK button.

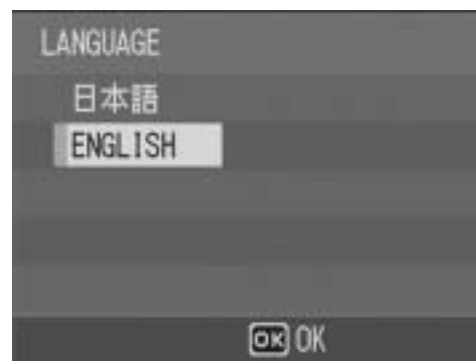

Changing the Step Zooming Setting (STEP ZOOM)

Step zooming is the setting of the focal length with optical zooming, which can be fixed to any of four levels (28, 35, 50, 85 mm, equivalent to that on a 35mm camera).

Available Settings

ON (Use step zooming)

OFF (Do not use step zooming) *Default setting

To set step zooming, follow the steps below.

1 Display the **SETUP** menu.

- For the operating procedure, see P.107.

2 Press the ▼ button to select **[STEP ZOOM]** and press the ► button.

3 Press the ▲▼ buttons to select the desired setting.

4 Press the **MENU/OK** button, or ◀ button and press the **MENU/OK** button.



Displaying a Settings Change Warning (SHTG STGS WARNG.)

If the initial settings are changed for the following functions, you can set the camera to have the icon of that function blink and to display a warning message about the function with the changed setting for a few seconds when the camera is turned on.

White balance, Focus, ISO setting, Exposure compensation,
Time exposure

If you operate a camera button while an icon is blinking, the icon stops blinking and lights steadily. If you operate a camera button while the warning message is displayed, the message disappears.

Available Settings

ON (Enable warnings) *Default setting

OFF (Disable warnings)

To set change warning, follow the steps below.

- 1 Display the SETUP menu.**
 - For the operating procedure, see P.107.
- 2 Press the ▼ button to select [SHTG STGS WARNG.] and press the ► button.**
- 3 Press the ▲▼ buttons to select the desired setting.**
- 4 Press the MENU/OK button, or ◀ button and press the MENU/OK button.**



Changing the USB Setting (USB CONNECTION)

By setting [USB CONNECTION] to [MASS STR] on the SETUP menu, you can view files in the camera and transfer files from the camera to your computer using the USB cable without installing the supplied software or USB driver.

Usually, set [USB CONNECTION] to [ORIGINAL]. You can transfer images to your computer using the supplied RICOH Gate La software.

USB CONNECTION Mode	MASS STR	ORIGINAL
Downloading data	The SD memory card or internal memory of the camera can be operated directly as an external drive for file processing.	RICOH Gate La allows automatic transfer of camera data to your computer. Use the Caplio Mounter to transfer camera data to your computer. (Mac OS)
Installation from Caplio Software CD-ROM	Not required	Required
Supported Operating Systems		
Windows 98/98SE	×	○
Windows 2000 Professional	○	○
Windows Me	○	○
Windows XP Home Edition	○	○
Windows XP Professional	○	○
Mac OS 8.6	×	○
Mac OS 9.0 to 9.2.2	○	○
Mac OS X 10.1.2 to 10.4.6	○	○
For those:	<ul style="list-style-type: none"> Familiar with OS file operations Not willing to install a USB driver or other programs 	<ul style="list-style-type: none"> Willing to automate downloading to a computer Using Windows 98/98SE Using Mac OS 8.6



Caution-----

- When [USB CONNECTION] is set to [MASS STR], you cannot use RICOH Gate La to transfer camera data.
- When [USB CONNECTION] is set to [MASS STR], files can only be read from the camera and cannot be written to or deleted from the camera.
- When [USB CONNECTION] is set to [MASS STR], Direct Print may not be available for some printers. In such cases, select [ORIGINAL] instead.

To change the USB setting, follow the steps below.

1

Display the SETUP menu.

- For the operating procedure, see P.107.

2

Press the ▼ button to select [USB CONNECTION] and press the ► button.

3

Press the ▲▼ buttons to select the desired setting.

4

Press the MENU/OK button, or ◀ button and press the MENU/OK button.



Note-----

For how to download images from the camera to a computer using the USB cable, see P.149-153.

Enlarging Icon Display (ENLGE PHOTO ICON)

You can enlarge the icons displayed on the screen during shooting. The following icons are enlarged:

Flash, Macro Shooting, Self-timer, White balance, Focus, Exposure compensation, ISO setting

When the icons are enlarged, the following items are not displayed:

Zoom bar/Focus bar, Date imprint, Sharpness, Color depth

To enlarge the icons on the screen, follow the steps below.

1 Display the **SETUP** menu.

- For the operating procedure, see P.107.

2 Press the ▼ button to select [ENLGE PHOTO ICON] and press the ► button.

3 Press the ▲▼ buttons to select the desired setting.

4 Press the MENU/OK button, or ◀ button and press the MENU/OK button.



Registering the Power-on Settings (REG. MY SETTINGS)

The My Setting function allows you to make your desired settings to be used at power-on. For example, when a digital camera is used in common by multiple persons, you can use the camera without regard to the settings made by the person who used the camera previously because the camera settings are restored to your settings each time the camera is turned on.

Two types of My Settings can be registered.

To register the current camera settings as My Settings, follow the steps below.

1 Change the camera settings to the settings to be registered as My Settings.

2 Display the SETUP menu.

- For the operating procedure, see P.107.

3 Press the ▼ button to select [REG. MY SETTINGS] and press the ► button.

- A confirmation message appears.



4 Select [SETTING1] or [SETTING2] and press the MENU/OK button.

- The current camera settings will be registered and the display returns to the SETUP menu.
- If you do not want to register them, press the DISP. button.

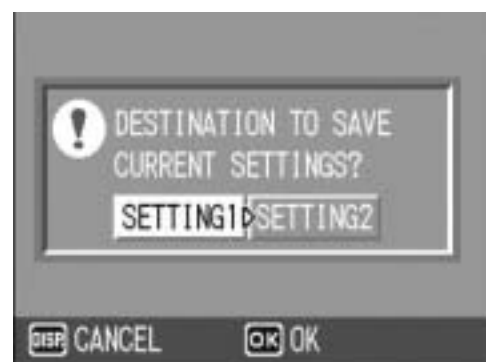

5 Press the MENU/OK button.

Changing the Startup Settings (START SETTINGS)

You can use the settings registered in [REG. MY SETTINGS] for the startup settings.

1 Display the SETUP menu.

- For the operating procedure, see P.107.

2 Press the ▼ button to select [START SETTINGS] and press the ► button.

3 Select [SETTING1] or [SETTING2] and press the MENU/OK button, or ◀ button and press the MENU/OK button.

- If you do not use the my setting function, select [OFF].



4 Turn your camera off.

- The settings to be used at the next power-on will be changed.



Note

- When [START SETTINGS] is set to [OFF], settings are retained as usual.
- When [START SETTINGS] is set to [SETTING1] or [SETTING2], the camera settings made with [REG. MY SETTINGS] are used at power-on even if [RESTORE DEFAULTS] is selected.

Settings Saved by My Setting Function

PIC QUALITY/SIZE	DATE IMPRINT
ANTIBLUR	WHITE BALANCE
FOCUS	ISO SETTING
Focal distance used in Manual	Zoom position
PHOTOMETRY	Macro
SHARPNESS	Flash
CONT. MODE	Scene Mode
COLOR DEPTH	DISP. Mode
EXPOSURE COMP.	DENSITY
TIME EXPOSURE	FRAME RATE
IMAGE WITH SOUND	ENLGE PHOTO ICON

7 Downloading Images to Your Computer

The screen images shown here may differ from the images displayed on your computer depending on your computer OS.

For Windows

Refer to P.142 for Macintosh.

You need to install software for transferring images to your computer before you can download images from the camera. Software installation is necessary for automatic image downloading from the camera to your computer.



Caution

Be sure to install the software before you connect the camera to your computer. (☞ P.134)

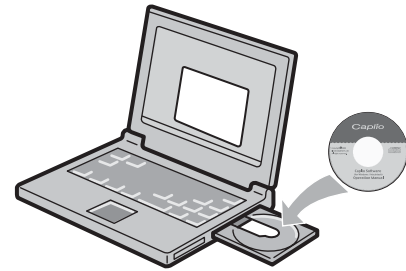

Note

- When [MASS STR] is selected for [USB CONNECTION] of the camera's SETUP menu, you can view the files in the camera without installing the supplied software or USB driver (☞ P.151). At the time of purchase, [ORIGINAL] is selected.
- For how to download images from the camera to your computer, see the "Software User Guide" available from the Caplio Software CD-ROM. For how to display the "Software User Guide", see P.131.

Using the Caplio Software CD-ROM

Once you insert the Caplio Software CD-ROM in the CD-ROM drive, the installer screen appears automatically.



Item Name	Description	Refer to
Installing the Software	Use this button to install software required for handling the camera and images.	P.134
Installing DeskTopBinder Lite	Use this button to install software required for handling the camera and images.	P.136
Browse User's Manual (Software Version)	Click this to display the "Software User Guide" (PDF).	P.131
Browse CD-ROM Content	Click this to display the list of files contained on the CD-ROM.	P.132

When [Installing the software] is clicked: (👉 P.134)

The following software will be installed:

Software	Windows		Description	
	XP	98		
Caplio Software	RICOH Gate La	<input type="radio"/>	<input type="radio"/>	Downloads images collectively.
	List Editor	<input type="radio"/>	<input type="radio"/>	Used to create a camera memo list.
	Caplio Setting*	<input type="radio"/>	<input type="radio"/>	Used to make wireless LAN-related settings.
	Caplio Server*	<input type="radio"/>	<input type="radio"/>	Used to set your computer as a Caplio-only FTP server.
ImageMixer	<input type="radio"/>	<input type="radio"/>	Shot images can be displayed or edited and video CDs can be created. DirectX (👉 P.139) is necessary for handling movies.	
USB Driver	<input type="radio"/>	<input type="radio"/>	Used to connect the camera to the computer.	
WIA Driver	<input type="radio"/>	-	Used to download images.	

XP: Windows XP

98: Windows 98/98SE/Me/2000

* Only for Caplio 500SE-W



Note

- The camera is provided with ImageMixer software that allows you to display and edit images from your computer. For how to use ImageMixer, click the [?] button on the ImageMixer window and see the displayed manual.
For the latest information about ImageMixer, access the Web page of Pixela Co., Ltd. (<http://www.imagemixer.com>).
- The WinASPI installer starts during installation of ImageMixer. WinASPI is required when creating a Video CD using ImageMixer.

When [Installing DeskTopBinder Lite] is clicked: (👉 P.136)

The following software will be installed:

Software	Windows		Description
	XP	98	
DeskTopBinder Lite	<input type="radio"/>	<input type="radio"/>	Software used to manage business documents. Images in the camera can be downloaded to DeskTopBinder Lite using the Auto Document Link that monitors document updating.
USB Driver	<input type="radio"/>	<input type="radio"/>	Used to connect the camera to the computer.
WIA Driver	<input type="radio"/>	-	Used to download images.

XP: Windows XP

98: Windows 98/98SE/Me/2000



Caution-----

DeskTopBinder Lite is compatible with Windows 98SE but not Windows 98.



Note-----

- For details about the DeskTopBinder Lite, refer to the Introduction Guide (PDF file), Setup Guide (PDF file), Auto Document Link Guide (PDF file), and Help supplied with the DeskTopBinder Lite.
- For details about the Auto Document Link, refer to the Auto Document Link Guide (PDF file).

When [Browse User's Manual (Software Version)] is clicked:

The "Software User Guide" (PDF file) on the Caplio Software CD-ROM is displayed on your computer screen.

If you have Acrobat Reader installed on your computer, simply click [Browse User's Manual (Software Version)]. Acrobat Reader must be installed to view the PDF file. (👉 P.138)

When [Browse CD-ROM Content] is clicked:

You can check folders and files on the CD-ROM. The CD-ROM contains not only the software installed by clicking [Installing the software] but also the following software. These software products run on Windows.

For the installation of each software product, see the reference page in the table below.

Software	Description	Refer to
Acrobat Reader	Required for viewing the "Software User Guide".	P.138
DirectX	Required for playing movies by the ImageMixer.	P.139



Note -----

- For details about Acrobat Reader, see Help for Acrobat Reader.
- To install ImageMixer alone, double-click "setup.exe" in the ImageMixer folder.

System Requirements for Using Caplio Software CD-ROM

The following environments are necessary for using Caplio Software. Please check your computer, or the computer's user manual.

Operating Systems Supported	Windows 98/98 Second Edition Windows 2000 Professional Windows Me Windows XP Home Edition/Professional
CPU	Pentium III: 500 MHz or faster
Memory	Windows 98/98SE: 128 MB or more Windows 2000: 128 MB or more Windows Me: 128 MB or more Windows XP: 256 MB or more
Hard drive space required for installation	Windows 98/98SE: 500 MB or more Windows 2000: 500 MB or more Windows Me: 500 MB or more Windows XP: 500 MB or more
Display Resolution	800 × 600 pixels or greater
Display Colors	65,000 colors or greater
CD-ROM Drive	A CD-ROM drive compatible with the above-mentioned computer
USB Port	A USB port compatible with the above-mentioned computer



Caution-----

- If your computer has an upgraded OS, the USB function may not work normally, so it cannot be supported.
- The provided software may not operate properly if changes are made to the operating system, such as with patches and service package releases.
- The camera does not support connection to a USB port added by using an extension function (PCI bus or other).
- If used in conjunction with a hub or other USB devices, the software may not work properly.
- When dealing with movies and other large files, a larger memory environment is recommended.

Installing the Software Required for Handling the Camera and Images on Your Computer

Install the required software on your computer from the CD-ROM before connecting the camera.



Caution-----

- Do not install the software when the camera is connected to your computer with a USB cable.
- If you happened to connect your camera to the computer (resulting in the [Add New Hardware Wizard] screen appearing on your computer screen), simply click [Cancel], and after disconnecting your camera, install the software on your computer.
- If software is already installed from a Caplio Software CD-ROM from a previous model, a message stating that the old software must be uninstalled before installing the new one is displayed. Follow the message instructions and uninstall the old software before installing the new software. Functions of the old model can still be used as before. If DU-10 is installed, it will be replaced by Caplio Viewer (an upgraded version of DU-10). If the old software is uninstalled before the message is displayed, Caplio Viewer is not installed even if the new software is installed. (For how to uninstall the software,  P.140.)
- For Windows XP or Windows 2000, administrator privileges are required to install the software.

Here is an example of the Windows XP screen.

1 Start your computer and insert the Caplio Software CD-ROM in the CD-ROM drive.

- The installer screen appears automatically.

2 Click [Installing the software].

- After a while, the [Choose Setup Language] screen appears.

3 Confirm the language, and then click [OK].

- The [Welcome to the InstallShield Wizard for Caplio Software] screen appears.



4 Click [Next].

- The [Choose Destination Location] screen appears.

5 Confirm where you want to install and then click [Next].

- The [Select Program Folder] screen appears.

6 Confirm the [Select Program Folder] and then click [Next].

- The ImageMixer installer starts. Install ImageMixer following the messages displayed on the screen.

- When installation of ImageMixer is completed, a dialog box appears, indicating that all software applications have been installed.

7 Click [Finish].

8 Restart your computer.



Note

You can remove (uninstall) the software. (👉 P.140)

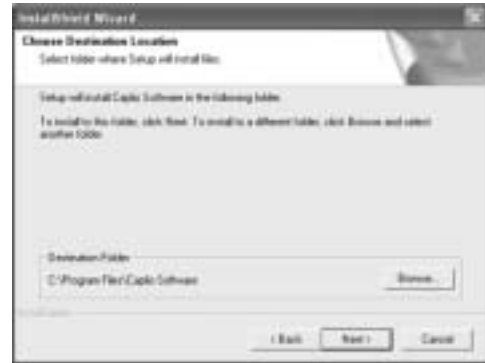
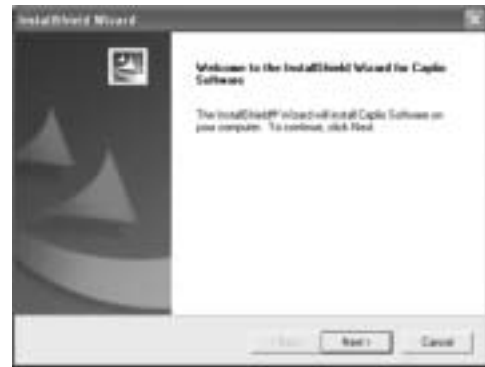

Installing the DeskTopBinder Lite

DeskTopBinder Lite is used for managing business documents. As well as still images captured with a digital camera, you can manage a variety of documents, including documents input by scanner, documents created with various applications and image files. You can also store files with different formats in a single document. Images downloaded from the camera can be saved to DeskTopBinder Lite using the Auto Document Link for monitoring document updating.

Note -----
 For how to use DeskTopBinder Lite, refer to the Introduction Guide, the Setup Guide, and the DeskTopBinder Lite - Auto Document Link Guide (all PDF files) that are installed with DeskTopBinder Lite.

- Caution**-----
- If you happened to connect your camera to the computer (resulting in the [Add New Hardware Wizard] screen appearing on your computer screen), simply click [Cancel], and after disconnecting your camera, install the software on your computer.
 - For Windows XP or Windows 2000, administrator privileges are required to install the software.
 - To download images from the camera using the Auto Document Link of DeskTopBinder Lite, install the Caplio Software before installing DeskTopBinder Lite. (P.134) The driver included in the Caplio Software is required to use the Auto Document Link.
 - If [Caplio Digital Camera] is set as the monitoring destination of the Auto Document Link, select [ORIGINAL] for [USB CONNECTION] on the camera menu. (P.123)

Here is an example of the Windows XP screen.

1 Start your computer and insert the Caplio Software CD-ROM in the CD-ROM drive.

- The installer screen appears automatically.



2 Click [Installing DeskTopBinder Lite].

- After a few moments, the [Welcome to the InstallShield Wizard for Caplio Software S] screen appears.

3 Click [Next].

- After a few moments, the [Choose Destination Location] screen appears.

4 Confirm where you want to install and then click [Next].

- The [Select Program Folder] screen appears.



5 Confirm the [Select Program Folder] and then click [Next].

6 Click [OK].

7 Click [DeskTopBinder Lite].

- The DeskTopBinder Lite installer starts.
- Install DeskTopBinder Lite following the messages displayed on the screen.
- When the screen where you verify digital ID is displayed, click [OK].

Caution-----

- DeskTopBinder Lite cannot coexist with a different version of DeskTopBinder Lite, DeskTopBinder Professional, or Job Binding. Before installing DeskTopBinder Lite, uninstall these applications. The data used in the previous application can be saved and inherited by DeskTopBinder Lite. However, when the previous application is DeskTopBinder Professional, some functions will no longer be available.
- When capturing images from the camera using the Auto Document Link of the DeskTopBinder Lite, deselect the [Saves automatically when connected to USB] check box in the [Option settings] dialog box displayed by selecting [Option settings] on the [RICOH Gate La Settings] menu. (Refer to the “Software User Guide”.) Before capturing images from the camera, set the date and time using the [DATE SETTINGS] option of the camera. (👉 P.119)
- If you turned the camera off and then on again while connected to the computer with DeskTopBinder Lite open, reboot the computer with the camera connected.

Installing Other Software on Your Computer



Caution-----

- Do not install the software when the camera is connected to your computer with a USB cable.
- For Windows XP or Windows 2000, administrator privileges are required to install the software.

Acrobat Reader

Acrobat Reader is required to display the operation manual (PDF file).

If the computer is running under Windows, Acrobat Reader can be installed. Acrobat Reader need not be installed if already installed on your computer.

1 Start your computer, and insert the included Caplio Software CD-ROM into the CD-ROM drive.

- The installer screen appears automatically.

2 Click [Browse CD-ROM Content].

- The files on the CD-ROM are listed.

3 Double-click the [Acrobat] folder.

4 Double-click the [English] folder.

5 Double-click [ar500enu] (ar500enu.exe).

6 Install Acrobat Reader by following the messages displayed.



DirectX

DirectX is used to play movie files with ImageMixer. This camera requires DirectX 8.1 or later to play movie files in Windows. If you have an earlier version installed, please install the updated version available on the accompanying CD-ROM. For Windows XP, installation of DirectX is not needed because the updated version is already installed.

- 1** Start your computer, and insert the included Caplio Software CD-ROM into the CD-ROM drive.
- 2** Click [Browse CD-ROM Content].
- 3** Double-click the [DirectX] folder.
- 4** Double-click the [English] folder.
- 5** Double-click the following file:

Windows 98/98SE/Me	[DX81xxx.exe] in the [Win98Me] folder
Windows 2000	[DX81NTxxx.exe] in the [Win2000] folder

Uninstalling the Software



Caution-----

- For Windows 2000/XP, administrator privileges are required to uninstall the software.
- If any other program is active or unsaved data remains, save the data and terminate the program before uninstalling.
- If you install both ImageMixer and the DeskTopBinder Lite and then uninstall either one, camera connection to the computer may fail. In this case, uninstall both [Caplio Software] and [Caplio Software S] and then install only the required one.

Caplio Software

- 1** Click [Start] on the Windows task bar.
- 2** Select [Settings]-[Control Panel] ([Control Panel] for XP).
- 3** Double-click the [Add/Remove Programs] icon (or the [Add or Remove Programs] icon in Windows XP).
- 4** Select [Caplio Software] (select [Caplio Software S] if you have installed the DeskTopBinder Lite), and then click the [Change/Remove] button.
- 5** Confirm file deletion and click [OK].
 - The [Shared File Detected] dialog box appears.
- 6** Select the [Don't display this message again.] check box, and then click [Yes].
 - The uninstallation process begins. When it is finished, close the displayed window.

ImageMixer

- 1** Click [Start] on the Windows task bar.
- 2** Select [Settings]-[Control Panel] ([Control Panel] for XP).
- 3** Double-click the [Add/Remove Programs] icon (or the [Add or Remove Programs] icon in Windows XP).
- 4** Select [ImageMixer] and then click [Change/Remove].
- 5** Confirm file deletion and click [OK].
 - The uninstallation process begins. When it is finished, close the displayed window.
- 6** Restart your computer.

For Macintosh

Refer to P.128 for Windows.

You need to install software for transferring images to your computer before you can download images from the camera. Software installation is necessary for automatic image downloading from the camera to your computer.



Caution

Be sure to install the software before you connect the camera to your computer with the cable.

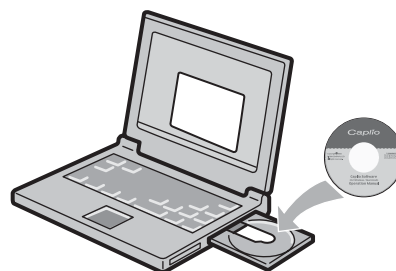

Note

For how to download images from the camera into your computer, see the "Software User Guide" available from the Caplio Software CD-ROM. For how to display the "Software User Guide", see P.143.

Using the Caplio Software CD-ROM

Software	Mac		Description
	9	X	
RICOH Gate La	<input type="radio"/>	-	Downloads images collectively.
USB Driver	<input type="radio"/>	<input type="radio"/>	Connects the camera to your computer.
Caplio Mounter	<input type="radio"/>	<input type="radio"/>	Connects the camera to your computer.

9: Mac OS 8.6 to 9.2.2

X: Mac OS X 10.1.2 to 10.4.6



Note

- For Mac OS 8.6 to 9.2.2, when the camera and computer are connected, RICOH Gate La automatically starts and the downloading of images begins. For details about the software, see the "Software User Guide".
- For how to download images using Caplio Mounter, see the "Software User Guide".

For Mac OS 8.6 to 9.2.2, double-clicking the [Installer] icon displays the [Digital camera software installer] window.



Note -----

The “Digital camera software installer” window is not displayed in Mac OS X 10.1.2 to 10.4.6. (👉 P.146)

Item Name	Description
Installing the Software	Use this button to install software required for handling the camera and images.
Browse User's Manual (Software Version)	Use this button to display the “Software User Guide” (PDF).

When [Installing the software] is clicked (👉 P.145, P.146):

The software will be installed.

When [Browse User's Manual (Software Version)] is clicked:

The “Software User Guide” (PDF file) on the Caplio Software CD-ROM can be displayed on your computer screen. Acrobat Reader must be installed to view the PDF file.

System Requirements for Using the Caplio Software CD-ROM

The following environments are necessary for using the Caplio Software.

Please check your computer, or the computer's user manual.

Operating System	Mac OS 8.6 to 9.2.2/Mac OS X 10.1.2 to 10.4.6	
Macintosh	A USB port standard-equipped Apple Macintosh Series	
Internal Memory	Mac OS 8.6 to 9.2.2	96 MB or more (128 MB or more recommended)
	Mac OS X 10.1.2 to 10.4.6	128 MB or more (256 MB or more recommended)
Application Allocated Memory (For Mac OS 8.6 to 9.2.2)	Without using the compression utility, 16 MB or more (24 MB or more is recommended) as Application Memory	
Hard Disc Drive Capacity	Mac OS 8.6 to 9.2.2	10 MB or more (at installation)
	Mac OS X 10.1.2 to 10.4.6	100 MB or more (at installation)
	100 MB or more (at operation)	
Display Resolution	800 × 600 pixels or greater	
Display Colors	32,000 colors or greater	
CD-ROM Drive	A CD-ROM drive compatible with the above-mentioned Macintosh machine	
USB Port	A USB port compatible with the above-mentioned computer body	



Caution-----

- The provided software may not operate properly if changes are made to the operating system.
- Connection to a USB port retrofitted using an extended function (PCI bus, etc.) cannot be supported.
- If used in conjunction with a hub or other USB devices, the software may not work properly.



Note-----

- When dealing with movies and other large files, a larger memory environment is recommended.
- For Mac OS 8.6 to 9.2.2, use a larger memory environment, as well as allocating extra application memory.

Installing the Software Required for Handling the Camera and Images on Your Computer (Mac OS 8.6 to 9.2.2)

Install the required software on your computer from the CD-ROM before connecting the camera.



Caution-----

Do not install the software when the camera is connected to your computer with a USB cable.

1 Turn on your Macintosh and insert the Caplio Software CD-ROM in the CD-ROM drive.

2 Double-click the [Caplio Software] icon.

3 Double-click the [MacOS9] folder.

- The [Installer] icon appears.

4 Double-click [Installer].

- The [Digital camera software installer] window opens.



5 Click [Installing the software].

6 Click [OK] to update.

7 Click [Install].

- When installation finishes, a message appears to inform you that it is necessary to restart your Macintosh.

8 Click [Continue].

- The software is installed and after a while the Installation Complete message appears.

9 Click [Restart].

- Your Macintosh restarts.



Installing the Software Required for Handling the Camera and Images on Your Computer (Mac OS X 10.1.2 to 10.4.6)

Install the required software on your computer from the CD-ROM before connecting the camera.



Caution-----

Do not install the software when the camera is connected to your computer with a USB cable.

1 Turn on your Macintosh and insert the Caplio Software CD-ROM in the CD-ROM drive.

2 Double-click the [Caplio Software] icon.

3 Open the [Mac OS X] folder.

- Folders named [Mac OS X 10.1 - 10.3] and [Mac OS X 10.4] appear.

4 Click the folder for your OS.

- Double click [Mac OS X 10.1 - 10.3] if you are using Mac OS X 10.3 or earlier. Double click [Mac OS X 10.4] if you are using Mac OS X 10.4 or later. The [Caplio Mounter] icon appears.

5 Double-click [Caplio Mounter].

- The [Install Caplio Mounter] screen appears.
- The [Caplio Mounter] in the [Mac OS X 10.4] folder cannot be installed in Mac OS X 10.1 to 10.3.



6 Click [Continue].

- The installation Readme file appears. Click [Continue].

7 Click [Continue].

- The screen to select the destination disk appears.

8 Click the destination disk you want, and then click [Continue].



9 Click [Install].

- Click [Upgrade] to update the software.
- A screen appears prompting you to enter the administrator's password.

10 Enter the administrator's name and password, and then click [OK].

- A message appears to inform you that it is necessary to restart your Macintosh when installation finishes.

11 Click [Continue Installation].

- The software is installed, and after a while an Installation Complete message appears.

12 Click [Restart].

- Your Macintosh restarts.

Uninstalling the Software



Caution-----

If any other program is active or unsaved data remains, save the data and terminate the program before uninstalling.

Mac OS 8.6 to 9.2.2

- 1 Delete the following files in the System Folder from your Macintosh.**

File Name	Folder Name
RICOH Gate La	Control Panels
RICOH Gate La Prefs	Preferences
Caplio Mounter	Extensions
Caplio Mounter Prefs	Preferences
Caplio USB Driver	Extensions
Caplio LIB	Extensions

Mac OS X 10.1.2 to 10.4.6

- 1 Start [Caplio Mounter] in [Applications] folder.**
- 2 Select [Uninstall] in [File] menu.**
 - The uninstallation process begins.

Connecting the Camera to Your Computer

After installing the software on your computer, connect your camera to the computer.

The following explanation is provided assuming that [ORIGINAL] (default) is selected at [USB CONNECTION] of the camera's SETUP menu. (☞ P.123) If [MASS STR] is selected, change it to [ORIGINAL]. You can also download images in mass storage mode (☞ P.151).

1 Make sure the camera power is off.

2 Connect the USB cable to the USB port of your computer.

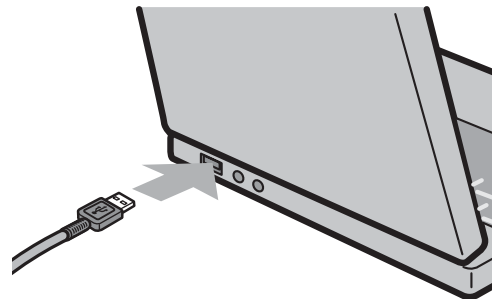

3 Connect the USB cable to the USB terminal of your camera.

- Your camera turns on.
- In Windows the first time you connect your camera to the computer using a USB cable, the [Found New Hardware Wizard] screen will appear. (☞ P.150)
- When using Macintosh or when connecting the camera to a Windows computer that you have connected the camera to already, RICOH Gate La starts and image transfer begins automatically.

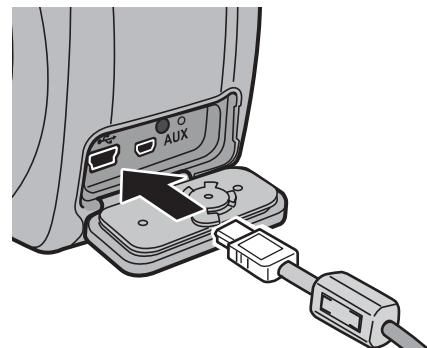

Caution-----

Before opening or closing the battery/card cover or terminal cover, be sure to remove any water, sand or mud adhering to the camera, and avoid opening and closing the cover in places where such contaminants may get inside the camera.

Using the Caplio Software to Download Images

In Windows the first time you connect your camera to the computer using a USB cable, the [Found New Hardware Wizard] screen will appear. (Does not appear on Macintosh.) Here is an example of the Windows XP screen.

1 Select [Install the software automatically (Recommended)].



2 Insert the Caplio Software CD-ROM into the CD-ROM drive on your computer.

- Installation of the WIA driver automatically starts. If the CD-ROM is already on your computer when the [Found New Hardware Wizard] screen is displayed, simply click [Next] to start installation.



Note -----

By default, the WIA driver is installed in the following location:
Specify the folder if the CD-ROM is not available.

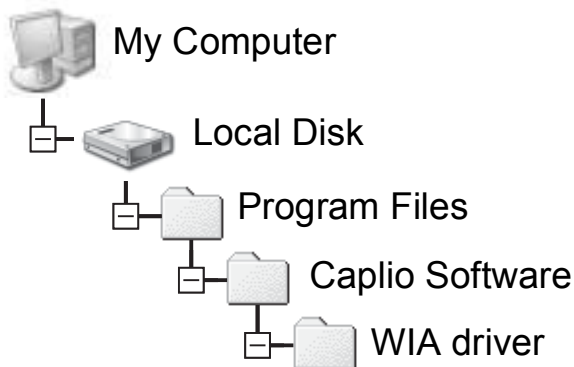

3 Select [RICOH Gate La], check [Always use this program for this action] check box, and then click [OK].

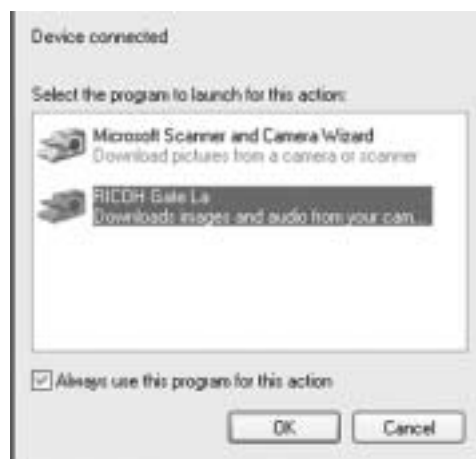

- To load images from the camera with assistance from the Windows XP “Scanner and Camera Wizard”, select [Microsoft Scanner and Camera Wizard].
- Leaving the [Always use this program for this action] check box unchecked will cause the [Caplio 500SE] screen to be displayed each time you transfer images from the camera, thereby allowing you to choose whether to use [RICOH Gate La] or the [Microsoft Scanner and Camera Wizard] for image transfers.
- If your PC is installed with Windows XP Service Pack 2 and a warning message is displayed, see P.230.



Note -----

- If the computer does not recognize the camera, uninstall the software (☞ P.140) and install it again.
- When downloading images from your camera, load a battery with adequate remaining power in the camera. Use of the AC adapter (sold separately) is recommended.
- When transferring images to a computer using RICOH Gate La, the file being transferred is renamed and saved.

Downloading Images in Mass Storage Mode

You can download images from the camera to a computer without having to use software.

- 1** Change [USB CONNECTION] to [MASS STR] on the **SETUP** menu.
 - For more details, see P.123. At the time of purchase, [ORIGINAL] is selected.
- 2** Make sure that the camera power is off.
- 3** Connect the accessory USB cable to a USB port of your computer.
- 4** Connect the USB cable to the **USB terminal of your camera.**

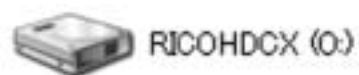

Example of the display in Windows XP

- Your camera turns on.
- Your computer automatically reads a file necessary for recognizing the camera as a drive.
- After this preparation, the camera is displayed as a drive at [My Computer] (Windows) or Desktop (Macintosh).

5 From the displayed drive, copy a file to the desired location.

- The figure at right shows the folder configuration in the drive.
- When the contents of the internal memory are displayed, the drive name is [RICOHDCI].

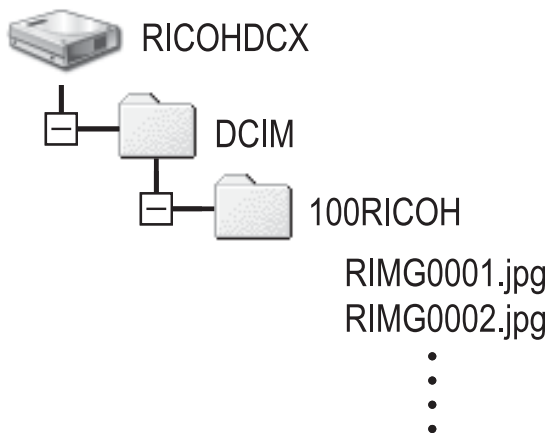

Example of the display in Windows XP



Caution-----

- Mass storage mode is not available on this camera if you are using Windows 98/98 SE or Mac OS 8.6.
- Do not turn off the camera or disconnect the USB cable during image transfer.
- If a file with the same name already exists at the destination, it is overwritten. If you do not want the file to be overwritten, rename the file or transfer data to another folder.



Note-----

When an SD memory card is loaded, its files are displayed. Otherwise, files in the internal memory are displayed.



Downloading images from an SD memory card-----

It is possible to download images from an SD memory card to the computer via a PC card slot or card reader. Depending on the type of PC card slot or card reader, a memory card adapter may be required when using an SD memory card. If the SD memory card can be used in the PC card slot, no memory card adapter is required.

- Images are stored in an SD memory card in the hierarchy shown below.

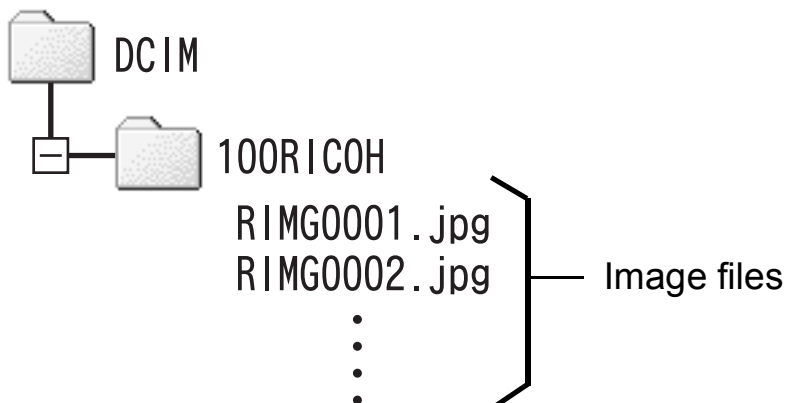

Example of the display in Windows XP

Card Reader

This is a device connected to a computer to read the contents of cards. In addition to the memory card adapter-type, there are card readers compatible with various types of cards, into which you can directly load an SD memory card.

Disconnecting the Camera from Your Computer

For Windows

If images are downloaded using RICOH Gate La or the [Scanner and Camera Wizard], turn the camera off after downloading images and disconnect the USB cable.

Perform the following operations if images are downloaded using mass storage mode. (The display is an example of Windows XP. The terms are different for other operating systems but the operations are the same.)

- 1** Double-click the [Safely Remove Hardware] icon at the right end of the task bar.
- 2** Select [USB Mass Storage Device] and click [Stop].
- 3** Check that [USB Mass Storage Device] is selected and click [OK].
- 4** Click [Close].
- 5** Disconnect the USB cable.



For Macintosh

- 1** Drag and drop the displayed drive or the volume icon to the "Trash".
 - If a screen appears prompting you to enter the administrator's password, enter the password.
- 2** Disconnect the USB cable.



Note

You can also click [Eject] on the [Special] menu in Mac OS 9 or the [File] menu in Mac OS X to cancel the connection.

8 Using the Bluetooth® Function

About the Bluetooth® Function

The Bluetooth® function enables the camera to wirelessly connect to a Bluetooth®-enabled computer, printer or other peripheral device. Bluetooth®-enabled devices can be wirelessly connected without cables. This technology is a popular method for sending and receiving data among various types of devices, such as computers, peripheral devices, and home appliances.

This camera has a Bluetooth® function that enables you to easily connect to a Bluetooth®-enabled printer, computer or other device to send images taken with the camera.

There are two ways to send image data using the Bluetooth® function.

- Send still images to a printer to have them printed (👉 P.157)
- Send and save still images to a computer (👉 P.166)



Caution

- Bluetooth®-enabled devices can connect at a maximum range of about 10 meters (33 feet). Keep the line-of-sight distance between the destination Bluetooth® device and the camera within about 10 meters (33 feet).
- The destination Bluetooth® device must support the following Bluetooth® Profiles. Please consult the manual that came with your Bluetooth® device.
 - BIP (Basic Imaging Profile)
 - OPP (Object Push Profile)
 - SPP (Serial Port Profile)
- You can only use the Bluetooth® function to send still images (.JPG). You cannot send movies (.AVI) or text (.TIF). If there are still images with sounds (.JPG and .WAV), only still images (.JPG) are sent.
- For Caplio 500SE-W, before sending an image, set [CHANGE COM] to [BT] on the Expanded Settings menu on the camera. (👉 P.193)



Note

Be careful not to obstruct the Bluetooth® antenna with your fingers when communicating.

Bluetooth® antenna

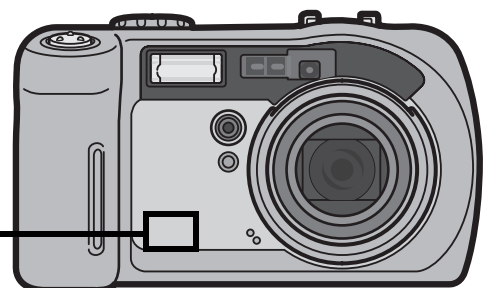

Expanded Settings Menu

You can set the Bluetooth® function, GPS information, or wireless LAN (only for Caplio 500SE-W) by displaying the Expanded Settings menu from the Shooting Setting menu (P.59) or Playback Setting menu (P.88).

The Expanded Settings menu enables you to set the items listed in the table below.

Setting	Options [Default Settings]	Refer to
GPS DATUM	TOKYO, [WGS-84]	P.188
GPS DISP MODE	[LAT/LON], UTM, MGRS, ALL	P.189
GPS LOCK	[OFF], ON	P.190
PASS KEY	-	P.175
SEARCH COUNT	1, 2, 3, 4, [5], 6, 7, 8, 9, 10	P.176
BT AUTO CONN	ON, [OFF]	P.183
BT SERIAL	-	P.181
MASTER/SLAVE	MASTER, [SLAVE]	P.177
IMAGE FILE SIZE	NO CHANGE, 1280, [640], 320, 160	P.178
AUTO DEL	ON, [OFF]	P.179
QUICK SEND MODE	[OFF], 1TOUCH, 2TOUCH	P.171
BARCODE MODE ^(*1)	[MODE1], MODE2	"Software User Guide"
SCAN TIME ^(*1)	[3 SEC.], 6 SEC., 9 SEC., 12 SEC., 15 SEC., 18 SEC., 21 SEC., 24 SEC., 27 SEC., 30 SEC.	"Software User Guide"
CHANGE COM ^(*2)	[W-LAN], BT	P.193
READ COM SETTING ^(*2)	-	P.205
SEND TO ^(*2)	-	P.207, 220
SEND CONDITION ^(*2)	[ON], OFF	P.219

(*1) You can import 1D barcode data and register it as a camera memo. Use this when using camera memos.

(P.59 "Software User Guide")

(*2) Only for Caplio 500SE-W

Using the Expanded Settings Menu

This explains how to make the settings.

Use the ▲▼▶ buttons and MENU/OK button to select and set an item.

1 Press the MENU/OK button.

- The Shooting Setting menu (or the Playback Setting menu) appears.

2 Press the ► button twice.

- The Expanded Settings menu is displayed.

The menu items are provided on four screens.



3 Press the ▲▼ buttons to select the desired menu item.

- Press the ▼ button at the bottom item to display the next screen.



4 Press the ► button.

- The menu item settings are displayed.

5 Press the ▲▼ buttons to select the setting.



6 Press the MENU/OK button, or ◀ button and press the MENU/OK button.

- The Expanded Settings menu disappears and the shooting or playback screen reappears.
- The Expanded Settings menu may appear depending on the setting. In this case, press the MENU/OK button again to return to the shooting or playback screen.



Note

For some functions, the setting selection method may differ from what is explained here. For detailed operation, see the explanation of each function.



Changing the display

- You can select a screen by the screen number:
 - Press the ◀ button to select a screen number on the left of the screen.
 - Press the ▲▼ buttons to change screens.
 - Press the ► button to return to menu item selection.



Sending Still Images to a Printer (PRINT)

You can send still images from the camera to a Bluetooth[®]-enabled printer to have them printed.

Images are sent from the internal memory when no SD memory card is loaded or from an SD memory card when installed.

There are three ways to send images to a printer.



- Send one image (👉 P.157)
- Send all images from the camera (👉 P.157)
- Select and send several images (👉 P.159)



Caution-----

- You can only use the Bluetooth[®] function to send still images (.JPG). You cannot send movies (.AVI) or text (.TIF). If there are still images with sounds (.JPG and .WAV), only still images (.JPG) are sent.
- If the printer supports both BIP and OPP profiles, the BIP profile is selected.
- When sending images using a BIP profile, the maximum image size that can be handled by the destination device is automatically obtained. If the size of the image to be sent is too large, then it is resized before being sent.

Printing One or All Still Images

- 1 Check that the destination device (printer) is ready for printing.**
- 2 Press the  (Playback) button.**
 - For Caplio 500SE-W, check that [CHANGE COM] is set to [BT] on the Expanded Settings menu. (👉 P.193)
 - To send all still images, go to Step 4.
- 3 Press the   buttons to select an image to send.**
- 4 Press the MENU/OK button.**
 - The Playback Setting menu appears.

5 Press the ▼ button to select [PRINT], and then press the ► button.

- When the Bluetooth® function is used for the first time, a screen appears confirming whether to search for a destination device.
- If you have already searched for a destination device, a list of destination devices appears. Go to Step 7.
- If the camera is connected using a serial connection, a screen appears confirming whether to disconnect the serial connection. Select [YES] and press the MENU/OK button, and go to Step 7.

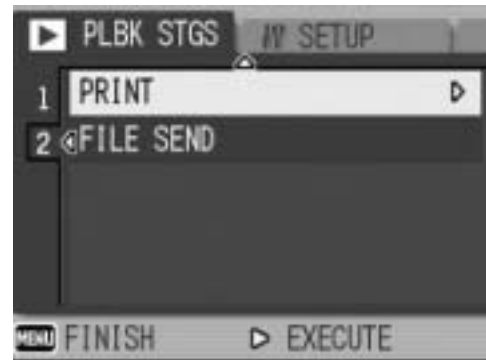

6 Press the ► button to select [YES] and then press the MENU/OK button.

- The camera begins searching for a destination device and a list of destination devices appears when the search is completed.
- By default, up to five devices can be discovered, but you can change this to search for any number of devices between one and ten. (☞ P.176)

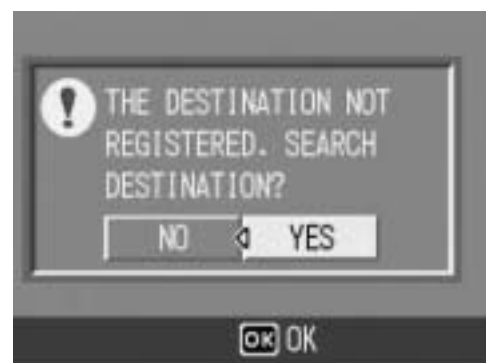

7 Press the ▲▼ buttons to select the desired destination device and then press the MENU/OK button.

- If the desired destination device is not listed, press the ADJ. button to search again for destination devices.
- Select a destination device and press the ► button to display information about the destination device.
- To delete a destination device from the list, select the device and press the ☒ (Delete) button.

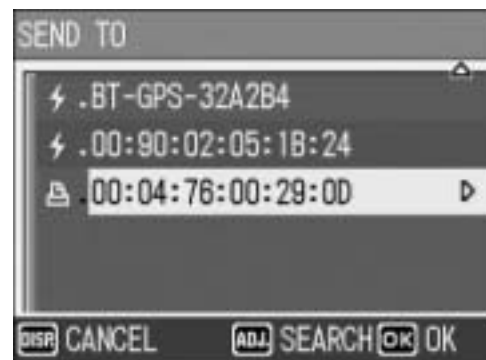

8 Press the ▲▼ button and [SEND ONE] to send one image or [SEND ALL] to send all images, and then press the MENU/OK button.



- Transfer of the images to the destination device begins and the progress is displayed. Pressing the DISP. button cancels the operation. Pressing the  (Playback) button or shutter release button also cancels the operation.
- If a passkey is required to connect to the destination device, a message appears prompting you to enter the passkey. (P.162)
- If an error message appears during transfer, follow the message instructions and send the images again. For details about the error messages, see P.222.
- Once the transfer is completed, the printer begins printing the images.

9 Press the MENU/OK button.

- The display returns to the playback screen.



Note -----
The most recently connected destination device appears at the top of the list of destination devices.

Printing Several Still Images

1 Check that the destination device (printer) is ready for printing.

2 Press the (Playback) button.

- For Caplio 500SE-W, check that [CHANGE COM] is set to [BT] on the Expanded Settings menu. (P.193)

3 Press the (Thumbnail Display) button twice.

- The screen is divided into 12 frames and thumbnails of the still images are displayed.

4 Press the MENU/OK button.

- The Playback Setting menu appears.

5 Press the ▼ button to select [PRINT], and then press the ► button.

- When the Bluetooth® function is used for the first time, a screen appears confirming whether to search for a destination device.
- If you have already searched for a destination device, a list of destination devices appears. Go to Step 7.
- If the camera is connected using a serial connection, a screen appears confirming whether to disconnect the serial connection. Select [YES] and press the MENU/OK button, and go to Step 7.

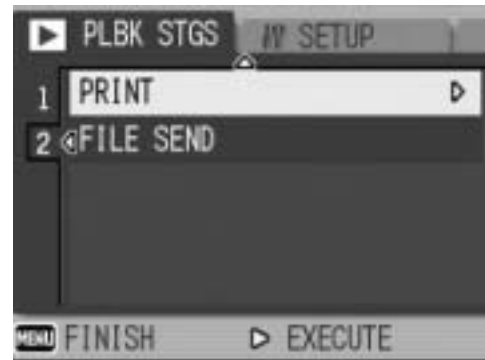

6 Press the ► button to select [YES] and then press the MENU/OK button.

- The camera begins searching for a destination device and a list of destination devices appears when the search is completed.
- By default, up to five devices can be discovered, but you can change this to search for any number of devices between one and ten. (☞ P.176)

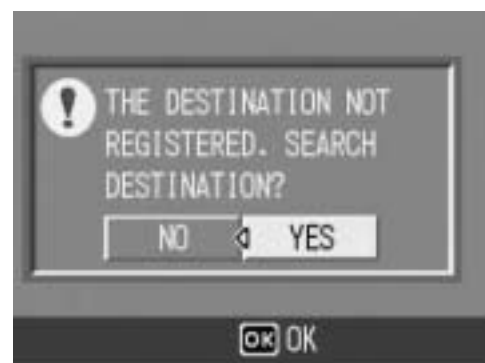

7 Press the ▲▼ buttons to select the desired destination device and then press the MENU/OK button.

- If the desired destination device is not listed, press the ADJ. button to search again for destination devices.
- Select a destination device and press the ► button to display information about the destination device.
- To delete a destination device from the list, select the device and press the ☒ (Delete) button.

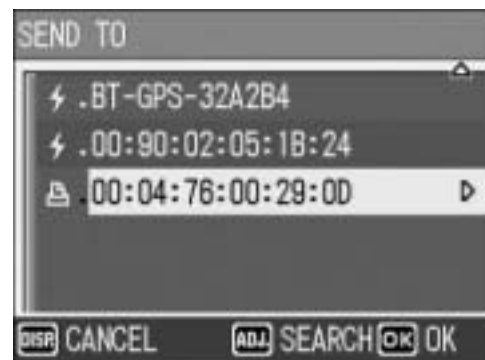

8 Press the ▲▼◀▶ buttons to select the still images to send and then press the MENU/OK button.

- The printer icon appears on the screen.

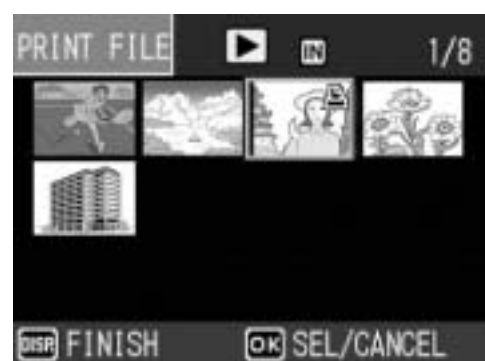

9 Repeat Step 8 to select all the files you want to send.

- If you selected a file by mistake, you can deselect it by selecting the file and pressing the MENU/OK button again.

10 Press the DISP. button.

- A screen appears indicating the printing format and number of files.

11 Press the MENU/OK button.

- Transfer of the images to the destination device begins and the progress is displayed. Pressing the DISP. button cancels the operation. Pressing the  (Playback) button or shutter release button also cancels the operation.
- If a passkey is required to connect to the destination device, a message appears prompting you to enter the passkey. (P.162)
- If an error message appears during transfer, follow the message instructions and send the images again. For details about the error messages, see P.222.
- Once the transfer is completed, the printer begins printing the images.

12 Press the MENU/OK button.

- The display returns to the playback screen.



Note -----

The most recently connected destination device appears at the top of the list of destination devices.

Entering an Authentication Passkey for a Destination Device

The authentication passkey is a code used to authenticate two devices connecting using the Bluetooth® function.

If the passkey is set on the destination device, a message appears when connecting to that device. Follow the procedure below to enter the passkey.

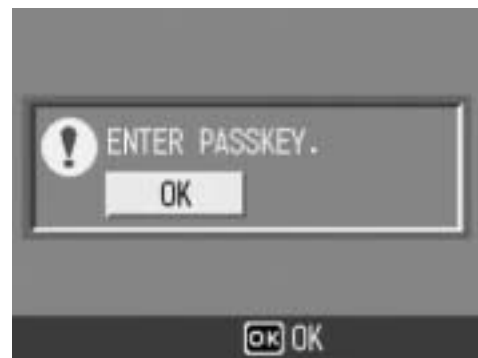

1 Press the MENU/OK button.

- The keyboard screen appears.

2 Use the keyboard to enter the passkey set on the destination device.

- For information on how to use the keyboard, see P.163.
- To set the passkey on the destination device, see the documentation that came with the destination device.
- You have 30 seconds to enter the passkey. If you do not enter the passkey within the allotted time, an error message appears. Press the MENU/OK button and start again from steps before entering the passkey.
- If you enter the incorrect passkey, an error message appears. Press the MENU/OK button and start again from steps before entering the passkey.



3 Press the MENU/OK button.

- The destination device is connected and the transfer of images begins.



Note

- You do not need to enter a passkey to connect to authenticated devices for which you have entered a passkey in the past.
- The maximum size of the passkey that can be entered with this camera is 16 alphanumeric characters.
- You can set the authentication passkey for a destination device on the camera beforehand so the camera can automatically authenticate the device without the need to enter the passkey. (☞ P.175)
- If the passkey input screen appears on the destination device before appearing on the camera, enter the passkey on the destination device, and then enter the same passkey on the camera.

How to Use the Keyboard

To use the keyboard, follow the steps below.

Switching among letters, numbers and symbols

When there is a cursor at the leftmost or rightmost character on the keyboard, press the ◀▶ buttons to switch the character type among numbers, symbols, lowercase letters and uppercase letters.

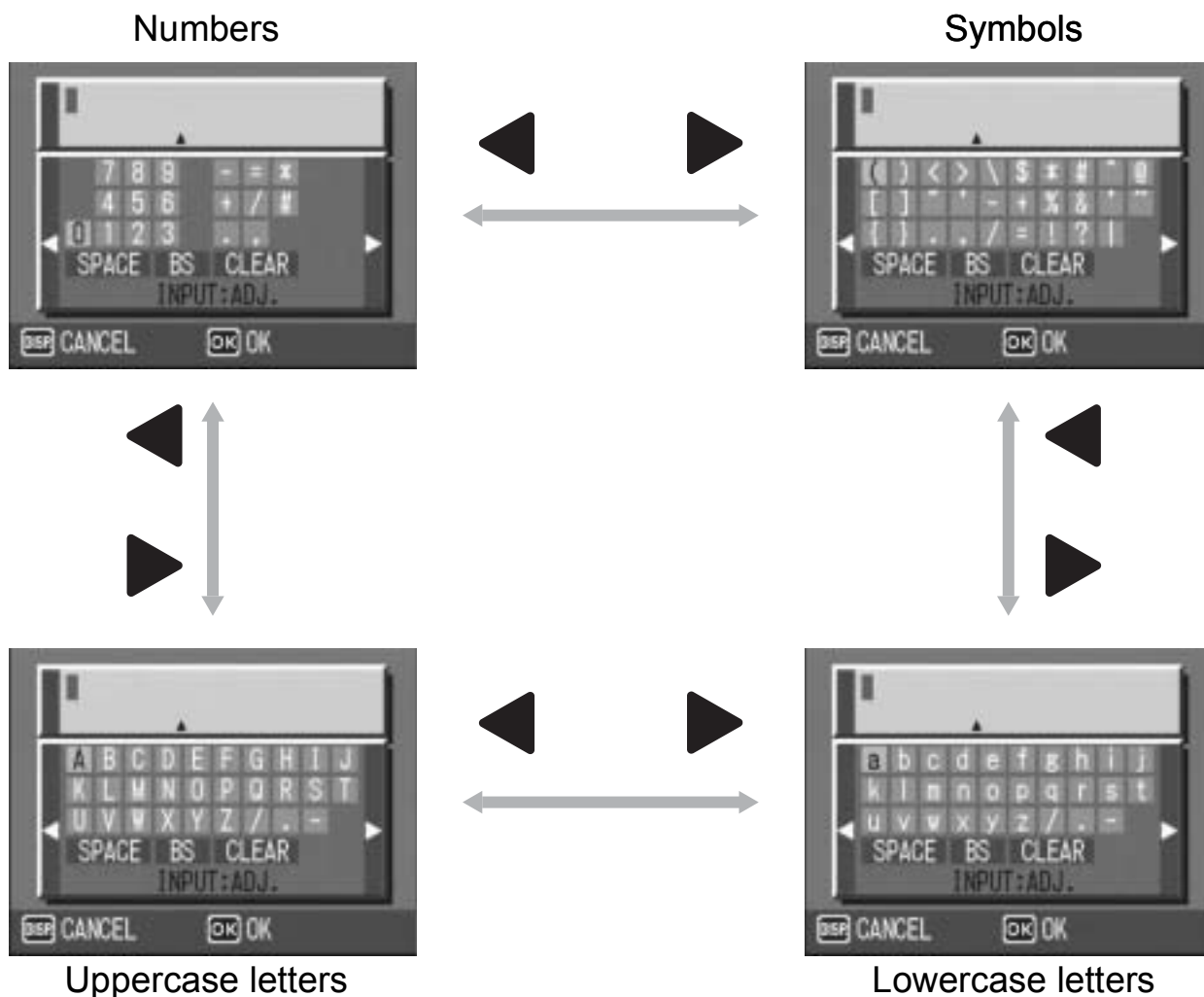

Entering characters

- 1 Press the ▲▼◀▶ buttons to select a character to input.
- 2 Press the ADJ./MEMO button.
 - The input edit area permits input up to the ▲ mark at the bottom of the area.



Entering a space

- 1 Press the ▲▼◀▶ buttons to select [SPACE].
- 2 Press the ADJ./MEMO button.



Inserting a character

- 1 Press the ▲▼◀▶ buttons to select one of the characters at the top of the keyboard.
- 2 Press the ▲ button.
 - The cursor moves to the right of the input characters.
- 3 Press the ◀▶ buttons to position the cursor to the right of the point where you want to insert a character.
- 4 Press the ▼ button to return the cursor to the keyboard.
- 5 Press the ▲▼◀▶ buttons to select an input character.
- 6 Press the ADJ./MEMO button.



Deleting a character

- 1** Press the ▲▼◀▶ buttons to select one of the characters at the top of the keyboard.
- 2** Press the ▲ button.
 - The cursor moves to the right of the input characters.
- 3** Press the ◀▶ buttons to position the cursor to the right of the character you want to delete.
- 4** Press the ▼ button to return the cursor to the keyboard.
- 5** Press the ▲▼◀▶ buttons to select [BS], and then press the ADJ./MEMO button.



Deleting all input characters

- 1** Press the ▲▼◀▶ buttons to select [CLEAR].
- 2** Press the ADJ./MEMO button.



Sending Still Images to Your Computer (FILE SEND)

You can send still images from the camera to a Bluetooth[®]-enabled computer. The sent images are processed according to the computer settings.

Images are sent from the internal memory when no SD memory card is loaded or from an SD memory card when installed.

There are three ways to send images to a printer.

- Send one image (👉 P.167)
- Send all images from the camera (👉 P.167)
- Select and send several images (👉 P.169)



Caution-----

- You can only use the Bluetooth[®] function to send still images (.JPG). You cannot send movies (.AVI) or text (.TIF). If there are still images with sounds (.JPG and .WAV), only still images (.JPG) are sent.
- If the computer supports both BIP and OPP profiles, the OPP profile is selected.
- When sending images using an OPP profile, you can set the size of the images to be sent beforehand. (👉 P.178)
- When sending images using a BIP profile, the maximum image size that can be handled by the destination device is automatically obtained. If the size of the image to be sent is too large, then it is resized before being sent.



Note-----

For information about setting your computer to receive images sent using the camera's Bluetooth[®] function, see the documentation that came with the computer.

Sending One or All Still Images

1 Check that the destination device (computer) is turned on.

2 Press the  (Playback) button.

- For Caplio 500SE-W, check that [CHANGE COM] is set to [BT] on the Expanded Settings menu. (👉 P.193)
- To send all still images, go to Step 4.

3 Press the  buttons to select an image to send.

4 Press the MENU/OK button.

- The Playback Setting menu appears.

5 Press the  button to select [FILE SEND] and press the  button.

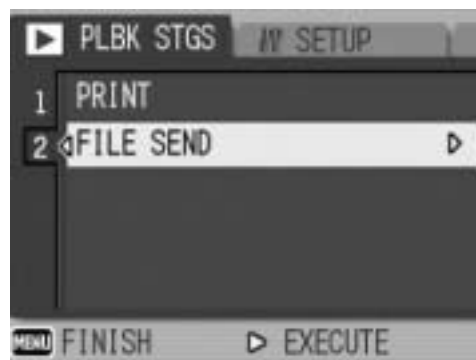

- When the Bluetooth® function is used for the first time, a screen appears confirming whether to search for a destination device.
- If you have already searched for a destination device, a list of destination devices appears. Go to Step 7.
- If the camera is connected using a serial connection, a screen appears confirming whether to disconnect the serial connection. Select [YES] and press the MENU/OK button, and go to Step 7.

6 Press the  button to select [YES] and then press the MENU/OK button.

- The camera begins searching for a destination device and a list of destination devices appears when the search is completed.
- By default, up to five devices can be discovered, but you can change this to search for any number of devices between one and ten. (👉 P.176)

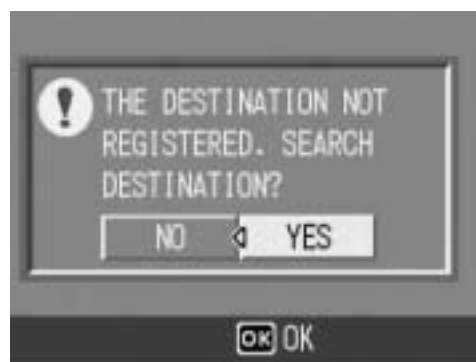

7 Press the ▲▼ buttons to select the desired destination device and then press the MENU/OK button.

- If the desired destination device is not listed, press the ADJ. button to search again for destination devices.
- Select a destination device and press the ► button to display information about the destination device.
- To delete a destination device from the list, select the device and press the  (Delete) button.

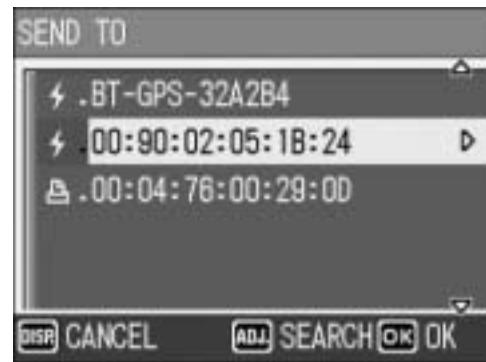

8 Press the ▼ button and [SEND ONE] to send one image or [SEND ALL] to send all images, and then press the MENU/OK button.

- Transfer of the images to the destination device begins and the progress is displayed. Pressing the DISP. button cancels the operation. Pressing the  (Playback) button or shutter release button also cancels the operation.
- If a passkey is required to connect to the destination device, a message appears prompting you to enter the passkey. (P.162)
- If an error message appears during transfer, follow the message instructions and send the images again. For details about the error messages, see P.222.
- Once the transfer is completed, a message indicating this appears.



9 Press the MENU/OK button.

- The display returns to the playback screen.



Note

The most recently connected destination device appears at the top of the list of destination devices.

Sending Several Still Images

1 Check that the destination device (computer) is turned on.

2 Press the  (Playback) button.

- For Caplio 500SE-W, check that [CHANGE COM] is set to [BT] on the Expanded Settings menu. (👉 P.193)

3 Press the  (Thumbnail Display) button twice.

- The screen is divided into 12 frames and thumbnails of the still images are displayed.

4 Press the MENU/OK button.

- The Playback Setting menu appears.

5 Press the  button to select [FILE SEND] and then press the  button.

- When the Bluetooth® function is used for the first time, a screen appears confirming whether to search for a destination device.
- If you have already searched for a destination device, a list of destination devices appears. Go to Step 7.
- If the camera is connected using a serial connection, a screen appears confirming whether to disconnect the serial connection. Select [YES] and press the MENU/OK button, and go to Step 7.

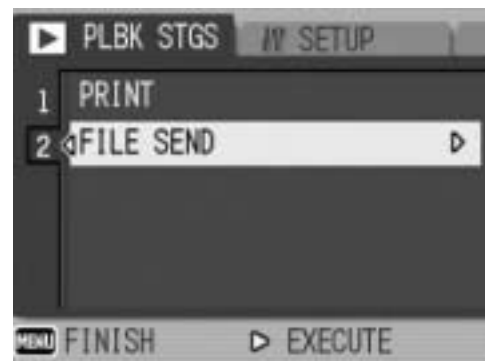

6 Press the  button to select [YES] and then press the MENU/OK button.

- The camera begins searching for a destination device and a list of destination devices appears when the search is completed.
- By default, up to five devices can be discovered, but you can change this to search for any number of devices between one and ten. (👉 P.176)

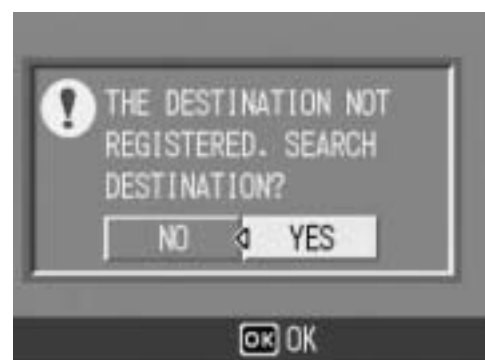

7 Press the ▲▼ buttons to select the desired destination device and then press the MENU/OK button.

- If the desired destination device is not listed, press the ADJ. button to search again for destination devices.
- Select a destination device and press the ► button to display information about the destination device.
- To delete a destination device from the list, select the device and press the  (Delete) button.



8 Press the ▲▼◀▶ buttons to select the still images to send and then press the MENU/OK button.

- The envelope icon appears on the screen.

9 Repeat Step 8 to select all the files you want to send.

- If you selected a file by mistake, you can deselect it by selecting the file and pressing the MENU/OK button again.



10 Press the DISP. button.

- A screen appears confirming whether to send the selected images to the computer.

11 Press the ► button to select [YES] and then press the MENU/OK button.

- Transfer of the images to the destination device begins and the progress is displayed. Pressing the DISP. button cancels the operation. Pressing the  (Playback) button or shutter release button also cancels the operation.
- If a passkey is required to connect to the destination device, a message appears prompting you to enter the passkey. (☞ P.162)
- If an error message appears during transfer, follow the message instructions and send the images again. For details about the error messages, see P.222.
- Once the transfer is completed, a message indicating this appears.

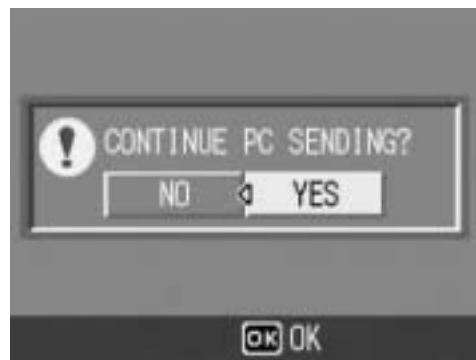

12 Press the MENU/OK button.

- The display returns to the playback screen.



Note

The most recently connected destination device appears at the top of the list of destination devices.

Sending Images in Shooting Mode (QUICK SEND MODE)

Immediately after you shoot a still image, you can send that image to another device. This is convenient if you want to send images to a predetermined device.

You need to set [QUICK SEND MODE] on the Expanded Settings menu beforehand.



Caution-----

You can only use the Bluetooth[®] function to send still images (.JPG). You cannot send movies (.AVI) or text (.TIF). If there are still images with sounds (.JPG and .WAV), only still images (.JPG) are sent.

Setting Up Quick Review Send (QUICK SEND MODE)

Available Settings	
OFF *Default setting	Images are not sent in shooting mode.
1TOUCH	If images have previously been sent, you can automatically send an image to the same destination device by pressing the MENU/OK button after shooting while the image is displayed (☞ P.116). You cannot use Quick Review Send when connecting to a Bluetooth [®] -enabled device for the first time, using a serial connection, or using a wireless LAN connection (only for Caplio 500SE-W).
2TOUCH	If images have previously been sent, you can automatically send an image to the same destination device by pressing the MENU/OK button after shooting during quick review display (☞ P.46). When connecting to a Bluetooth [®] device for the first time, the image is sent after discovering the destination device.

1 Display the Expanded Settings menu.

- For the operating procedure, see P.155.
- For Caplio 500SE-W, check that [CHANGE COM] is set to [BT] on the Expanded Settings menu. (☞ P.193)

2 Press the ▼ button to select [QUICK SEND MODE] and press the ► button.

3 Press the ▲▼ buttons to select [1TOUCH] or [2TOUCH].

4 Press the MENU/OK button, or ◀ button and press the MENU/OK button.

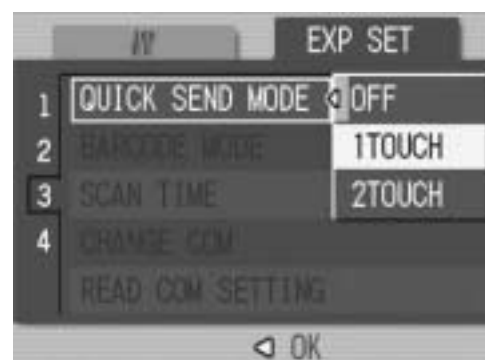

Using Quick Review Send

When [QUICK SEND MODE] is set to [1TOUCH]

- 1 Check that the destination device is turned on.
- 2 Turn the mode dial to /CAL and shoot the picture.

- While the image is displayed after shooting, a screen appears confirming whether to send the image. (👉 P.116)

- 3 Press the MENU/OK button.

- Transfer of the image to the previous destination device begins.

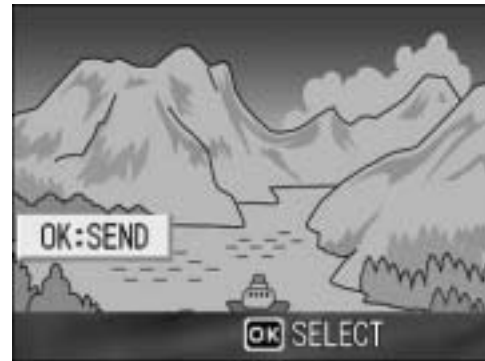

- Once the transfer is completed, the camera returns to shooting mode and remains connected to the destination device. You can change to playback mode or voice memo mode or remain connected to the destination device until the camera is turned off. The Bluetooth® antenna icon appears on the LCD monitor while the camera is connected.



Note

- You cannot use Quick Review Send to send still images when connecting to a Bluetooth®-enabled device for the first time even when [QUICK SEND MODE] is set to [1TOUCH]. Before you can use Quick Review Send to send still images, you must first use [PRINT] (👉 P.157) or [FILE SEND] (👉 P.166) in playback mode to send a still image to a Bluetooth®-enabled device.
- If the camera is connected using a serial connection or wireless LAN connection (only for Caplio 500SE-W), you cannot use Quick Review Send to send still images even when [1TOUCH] is set. Before you can use Quick Review Send to send still images, you must first disconnect the serial connection or wireless LAN connection. (👉 P.182, P.184, P.218)
- In the following cases, you cannot use Quick Review Send to send still images to a device even when [QUICK SEND MODE] is set to [1TOUCH].
 - When [LCD CONFIRM.] is set to [OFF] (👉 P.116)
 - During scene mode (👉 P.40)
 - During S-CONT or M-CONT (👉 P.69)
- When image with sound is set to [ON] (👉 P.76), after pressing the MENU/OK button in Step 3, the send button remains displayed until sending is started.
- The image size set with [IMAGE FILE SIZE] (👉 P.178) does not apply.

When [QUICK SEND MODE] is set to [2TOUCH]

- 1 Check that the destination device is turned on.
- 2 Turn the mode dial to /CALC and shoot the picture.
- 3 Press the (Quick Review) button.
 - A screen appears confirming whether to send the image.

4 Press the MENU/OK button.

- When the Bluetooth[®] function is used for the first time, a screen appears confirming whether to search for a destination device.
- If you have already searched for a destination device, a list of destination devices appears. Go to Step 6.
- If the camera is connected using a serial connection, a screen appears confirming whether to disconnect the serial connection. Select [YES] and press the MENU/OK button and go to Step 6.
- If the camera is connected using a wireless LAN connection, a screen appears confirming whether to disconnect the wireless LAN connection. Select [YES] and press the MENU/OK button, and go to Step 5 or Step 6. (Only for Caplio 500SE-W)

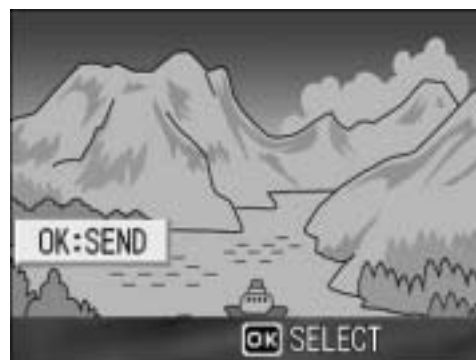

5 Press the ► button to select [YES] and then press the MENU/OK button.

- The camera begins searching for a destination device and a list of destination devices appears when the search is completed.
- By default, up to five devices can be discovered, but you can change this to search for any number of devices between one and ten. (P.176)

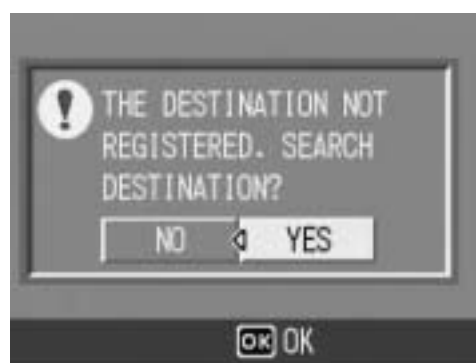

6 Press the ▲▼ buttons to select the desired destination device.

- If the desired destination device is not listed, press the ADJ. button to search again for destination devices.
- Select a destination device and press the ► button to display information about the destination device.
- To delete a destination device from the list, select the device and press the (Delete) button.



7 Press the MENU/OK button.

- Transfer of the images to the destination device begins and the progress is displayed. Pressing the DISP. button cancels the operation. Pressing the  (Playback) button or shutter release button or turning the mode dial also cancels the operation.
- If a passkey is required to connect to the destination device, a message appears prompting you to enter the passkey. (☞ P.162)
- If an error message appears during transfer, follow the message instructions and send the images again. For details about the error messages, see P.222.
- Once the transfer is completed, the camera returns to shooting mode and remains connected to the destination device. You can change to playback mode or voice memo mode or remain connected to the destination device until the camera is turned off. The Bluetooth® antenna icon appears on the LCD monitor while the camera is connected.



Note

- If an image is sent to a Bluetooth®-enabled device using [PRINT] (☞ P.157) or [FILE SEND] (☞ P.166) in playback mode before Quick Review Send, destination devices are not searched for again even if the camera is turned off and then on again. Transfer of images to the previous destination device begins. When the transfer is completed, the camera returns to shooting mode and remains connected to the destination device.
- Once Quick Review Send is performed to a Bluetooth®-enabled device in shooting mode and, thereafter, the camera is connected to a destination device, the camera does not search for destination devices again. Transfer of images to the previous destination device begins. When the transfer is completed, the camera returns to shooting mode and remains connected to the destination device.
- During manual focus (☞ P.65), you cannot use Quick Review Send to send still images to a device even when [QUICK SEND MODE] is set to [2TOUCH].
- The size of the images to be sent can be set beforehand. (☞ P.178)



To disconnect after Quick Review Send

Once Quick Review Send is completed, the camera returns to shooting mode and remains connected to the destination device. To disconnect, switch to playback mode or voice memo mode, or turn the camera off.

Making Advanced Bluetooth® Settings

Registering an Authentication Passkey for a Device (PASS KEY)

The authentication passkey is a code used to authenticate two devices connecting using the Bluetooth® function. If a passkey is required to connect to a destination device, the authentication passkey can be registered in the camera beforehand so that the passkey can be authenticated automatically when connecting to the device.

1 Display the Expanded Settings menu.

- For the operating procedure, see P.155.

2 Press the ▼ button to select [PASS KEY] and press the ► button.

- The keyboard screen appears.



3 Use the keyboard to enter the passkey set on the destination device.

- For information on how to use the keyboard, see P.163.
- To set the passkey on the destination device, see the documentation that came with the destination device.



4 Press the MENU/OK button.



Note

- The maximum size of the passkey that can be entered with this camera is 16 alphanumeric characters.
- If no authentication passkey is registered, the passkey must be entered when connecting the camera to the destination device. (☞ P.162)
- Only one authentication passkey (for one destination device) can be registered. To connect to several devices at the same time (☞ P.177), the authentication passkey must be the same on all connecting devices.
- To change a registered authentication passkey, enter a new passkey in Step 3 and press the MENU/OK button.

Changing the Number of Discoverable Devices (SEARCH COUNT)

You can set the maximum number of Bluetooth® devices that can be discovered each time a search is performed. Select between one and ten devices. The default setting is [5].

1 Display the Expanded Settings menu.

- For the operating procedure, see P.155.

2 Press the ▼ button to select [SEARCH COUNT] and press the ► button.

3 Press the ▲▼ buttons to select the desired setting.

4 Press the MENU/OK button, or ◀ button and press the MENU/OK button.

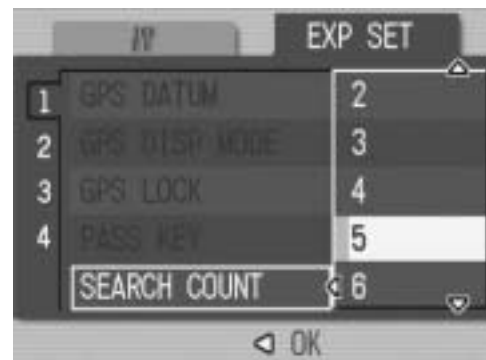

Connecting to Several Devices at the Same Time (MASTER/SLAVE)

You can connect the camera to one Bluetooth[®] device or multiple devices at the same time.

Available Settings

MASTER (Connect to several devices at the same time)

SLAVE (Connect to one device) *Default setting

- 1 Display the Expanded Settings menu.**
 - For the operating procedure, see P.155.
- 2 Press the ▼ button to select [MASTER/SLAVE] and press the ► button.**
- 3 Press the ▲▼ buttons to select the desired setting.**
- 4 Press the MENU/OK button, or ◀ button and press the MENU/OK button.**



Note

When the camera is connected to multiple devices at the same time, images can only be sent using the SPP profile.

Selecting the Size of Images to Be Sent (IMAGE FILE SIZE)

You can select the size of still images to be sent.

Available Settings

NO ALTER (Do not change the image size)

1280

640 *Default setting

320

160

- 1 Display the Expanded Settings menu.**
 - For the operating procedure, see P.155.
- 2 Press the ▼ button to select [IMAGE FILE SIZE] and press the ► button.**
- 3 Press the ▲▼ buttons to select the desired setting.**
- 4 Press the MENU/OK button, or ◀ button and press the MENU/OK button.**



Caution

- When sending images with Bluetooth[®], the image size set with [IMAGE FILE SIZE] is only applied when sending images with an OPP profile.
- When [QUICK SEND MODE] is set to [1TOUCH], the image size set with [IMAGE FILE SIZE] does not apply.
- When sending images using a BIP profile, the maximum image size that can be handled by the destination device is automatically obtained. If the size of the image to be sent is too large, then it is resized before being sent.

Automatically Deleting Sent Images (AUTO DEL)

You can set the camera to automatically delete a file from the camera after it has been sent to a computer or a printer.

Available Settings

ON (Automatically delete a still image after it has been sent)

OFF (Do not delete a still image after it has been sent) *Default setting

- 1 Display the Expanded Settings menu.**
 - For the operating procedure, see P.155.
- 2 Press the ▼ button to select [AUTO DEL] and press the ► button.**
- 3 Press the ▲▼ buttons to select the desired setting.**
- 4 Press the MENU/OK button, or ◀ button and press the MENU/OK button.**



About the GPS Function

This camera can obtain and use GPS (Global Positioning System) information (longitude and latitude) in two ways.

The first is by connecting the camera directly to a GPS module. The second is by using a Bluetooth[®] SPP (Serial Port Profile) to connect to a Bluetooth[®] GPS unit.

You can record GPS information on shot still images. GPS information recorded with a still image can be displayed on the Playback mode screen.



Caution-----

- For information about using the GPS module or Bluetooth[®] GPS unit, see the documentation that came with the device.
- GPS information can be recorded to still images shot with this camera.
- GPS information cannot be recorded with a text mode still image or movie.
- Under some geographical conditions, GPS information cannot be obtained.
- In some cases, positioning may take time.

Obtaining GPS Information

This section explains how to connect the camera to the Bluetooth[®] GPS unit to receive GPS information using a SPP.

There are two ways to connect the devices.

- Manually connect to a device (☞ P.181)
- Automatically connect to a previously connected device (☞ P.183)

Manually Connecting to a Device (BT SERIAL)

1 Display the Expanded Settings menu.

- For the operating procedure, see P.155.

2 Press the ▼ button to select [BT SERIAL] and press the ► button.

- When the Bluetooth[®] function is used for the first time, a screen appears confirming whether to search for a destination device.
- If you have already searched for a destination device, a list of destination devices appears. Go to Step 4.
- If the camera is connected using a wireless LAN connection, a screen appears confirming whether to disconnect the wireless LAN connection. Select [YES] and press the MENU/OK button, and go to Step 3 or Step 4. (Only for Caplio 500SE-W)



3 Press the ◀▶ buttons to select [YES] and then press the MENU/OK button.

- The camera begins searching for a Bluetooth[®] GPS unit and a list of destination devices appears when the search is completed.
- By default, up to five devices can be discovered, but you can change this to search for any number of devices between one and ten. (☞ P.176)

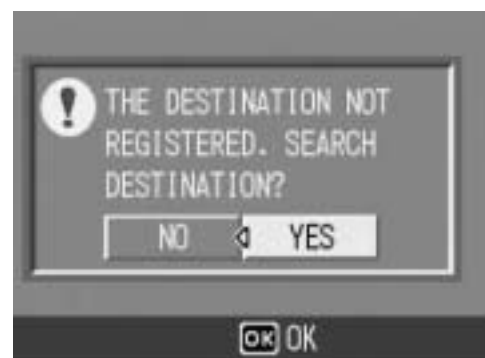

4 Press the ▲▼ buttons to select the desired destination device.

- If the desired destination device is not listed, press the ADJ. button to search for a Bluetooth® GPS unit in your vicinity.
- Select a destination device and press the ► button to display information about the destination device.
- To delete a destination device from the list, select the device and press the  (Delete) button.

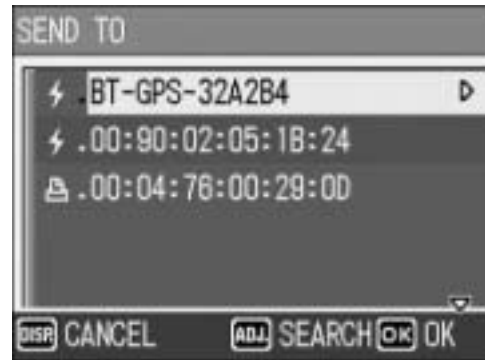

5 Press the MENU/OK button.

- The connection status appears. Pressing the DISP. button cancels the operation.
- If a passkey is required to connect to the destination device, a message appears prompting you to enter the passkey. (P.162)
- If the connection fails, an error message appears and then the shooting screen appears. For details about the error messages, see P.222.
- When a connection is established to a Bluetooth® GPS unit, the Bluetooth® antenna icon, GPS information and GPS antenna icon appear on the shooting screen.



Note

The most recently connected destination device appears at the top of the list of destination devices.



Disconnecting serial connection after manually connecting to a device

Turn the camera off to disconnect serial connection.

Automatically Connecting to a Previously Connected Device (BT AUTO CONN)

When [BT AUTO CONN] on the Expanded Settings menu is set to [ON], the next time the camera is turned on, the camera automatically searches for and connects to the previously connected Bluetooth® GPS unit. This is convenient if you want to use the same Bluetooth® GPS unit to which your camera previously connected.

Set [BT AUTO CONN] to [ON].

1 Display the Expanded Settings menu.

- For the operating procedure, see P.155.
- For Caplio 500SE-W, check that [CHANGE COM] is set to [BT] on the Expanded Settings menu. (☞ P.193)

2 Press the ▼ button to select [BT AUTO CONN] and press the ► button.

3 Press the ▲▼ buttons to select [ON].

4 Press the MENU/OK button, or ◀ button and press the MENU/OK button.



Note

- To automatically connect to a previously connected device after setting this function, turn off the camera and then turn it on again. The camera automatically connects to the previously connected Bluetooth® GPS unit.
- If the previously connected device is not detected (☞ P.154) or [CHANGE COM] is set to [W-LAN] (only for Caplio 500SE-W) (☞ P.193), no connection is established even if [BT AUTO CONN] is set to [ON].
- Use this function for a Bluetooth® GPS unit only.

Automatically Establishing a Connection

1 Check that the Bluetooth® GPS unit is turned on.

2 Turn the camera power on.

- The camera attempts to automatically connect to the device and the connection status appears. Pressing the DISP. button cancels the operation.
- If a passkey is required to connect to the destination device, a message appears prompting you to enter the passkey. (☞ P.162)
- If the connection fails, an error message appears and then the shooting screen appears. For details about the error messages, see P.222.
- When a connection is established to a Bluetooth® GPS unit, the Bluetooth® antenna icon, GPS information and GPS antenna icon appear on the shooting screen.

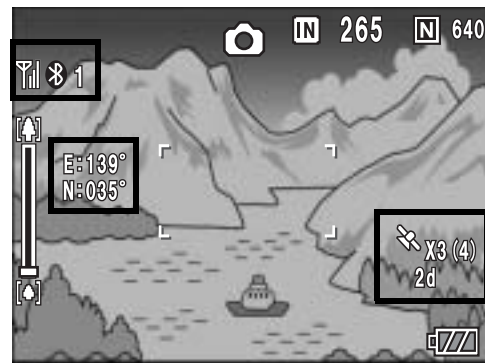

Disconnecting serial connection after automatically connecting to a device

In the Expanded Settings menu, set [BT AUTO CONN] to [OFF] (☞ P.183) and turn off to disconnect serial connection. Automatic connection will not be performed when the camera is turned on again.



Note

To send files while connected to a Bluetooth® GPS unit, you must disconnect the serial connection.

Select [PRINT] (☞ P.157) or [FILE SEND] (☞ P.166, P.209) on the Playback Setting menu to display the screen confirming whether to disconnect the serial connection. Select [YES] and press the MENU/OK button to disconnect the serial connection.

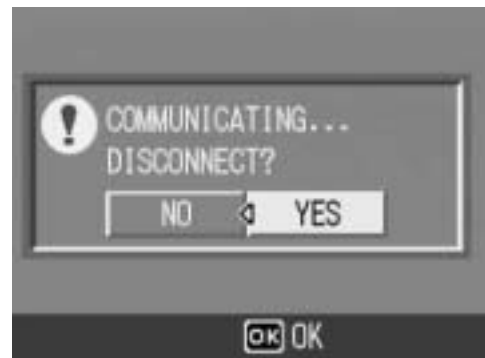

Displaying GPS Information

When the camera is connected to a Bluetooth® GPS unit in shooting mode, the Bluetooth® antenna icon, GPS information and GPS icon appear on the LCD monitor.

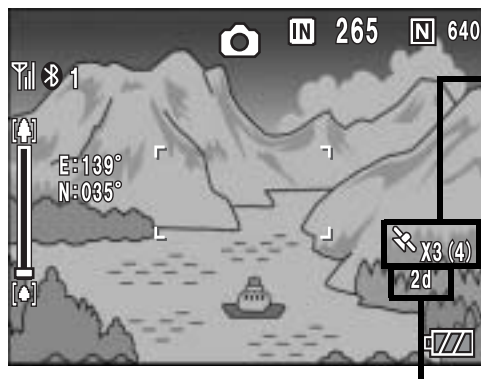

x3(4)

Number of visible satellites captured at the current position

Number of satellites used

GPS positioning quality

Display	Contents
no fix	The GPS unit cannot receive data.
2d	The NMEA-0183 format GSA positioning mode is 2d.
3d	The NMEA-0183 format GSA positioning mode is 3d.
Diff	The NMEA-0183 format GGA quality is DGPS.

If the number of receivable satellites is less than three, the GPS information cannot be acquired. If the GPS information cannot be acquired, the display of the GPS icon changes. In some cases, positioning may take time.



Retaining GPS information-----

- The latest GPS information is retained in the camera for ten minutes. This enables you to acquire GPS information outdoors and then shoot images indoors using the GPS information.
- If the GPS datum setup is changed (☞ P.188), GPS information is erased within ten minutes.

LCD Monitor Display

When the shooting screen switches to GPS display, the current GPS detailed information is displayed. At shooting, the latitude and longitude displayed on the LCD monitor are recorded as part of the image information.

You can change the display when playing back still images with GPS information. When using the GPS display, the latitude and longitude recorded with the still images appear.

The LCD monitor display can be switched using the DISP. button.

Shooting Mode

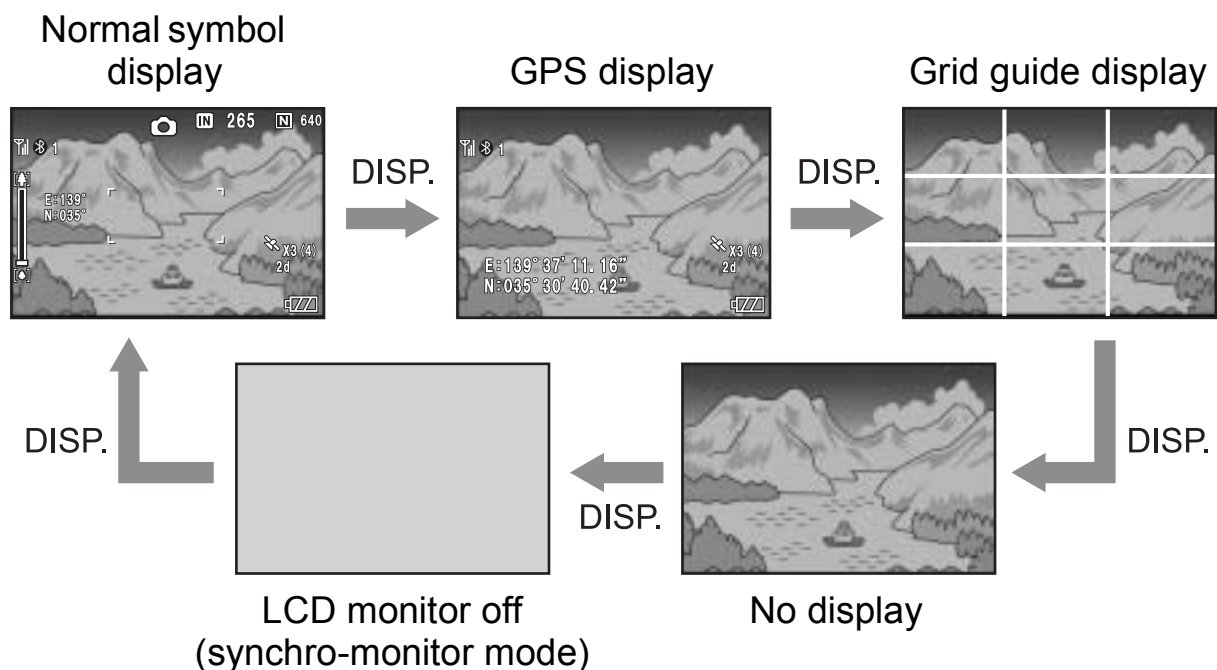

Playback Mode

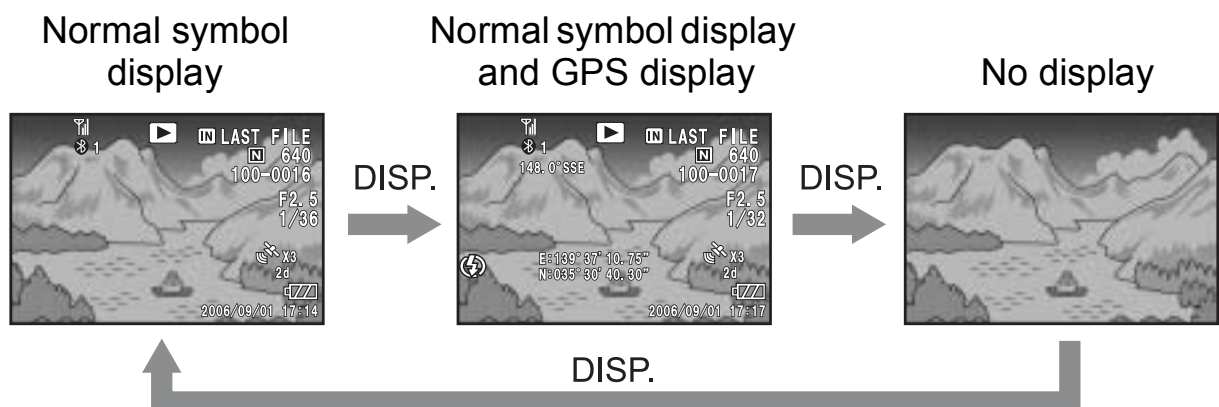

Shooting with GPS Information

You can shoot still images with GPS information. You can also shoot images with GPS information while using scene mode (except for TEXT MODE) or Multi-shot.

- 1** With the GPS function enabled, turn the Mode Dial to /CAL.S.
- 2** Check that the GPS information or GPS icon appears on the LCD monitor. (👉 P.186)
 - To check the current GPS detailed information, press the DISP. button to switch to the GPS display.
- 3** Press the shutter release button to shoot the picture.

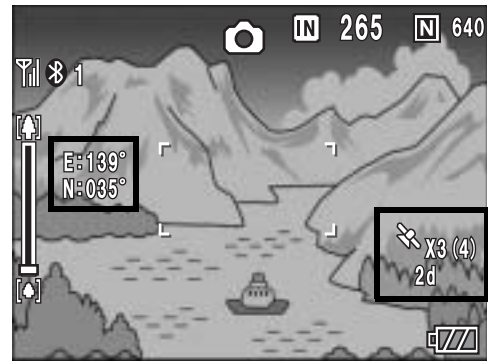

Playing Back a Still Image with GPS Information

When a still image with GPS information is played back (👉 P.186), its GPS information is also displayed.

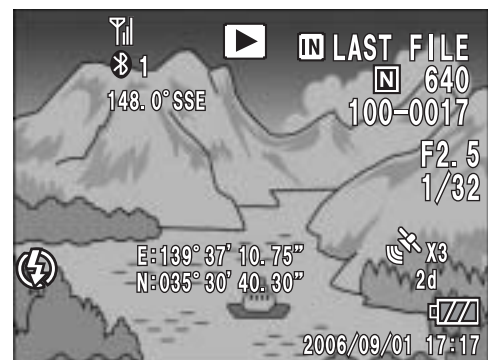

Note

- If the GPS information attached to the image is not what was acquired at shooting but is from the camera memory (👉 P.185), the latitude and longitude are displayed in orange.
- You can send a still image with GPS Information. (👉 P.184)

Advanced GPS Information Settings

Setting the Datum (GPS DATUM)

You can set the GPS information datum.

Available Settings

TOKYO (Standard datum used in Japan)

WGS-84 (World geodetic system) *Default setting

- 1 Display the Expanded Settings menu.**
 - For the operating procedure, see P.155.
- 2 Press the ▼ button to select [GPS DATUM] and press the ► button.**
- 3 Press the ▲▼ buttons to select the desired setting.**
- 4 Press the MENU/OK button, or ◀ button and press the MENU/OK button.**



Setting the Display Standard (GPS DISP MODE)

You can set the standard of the GPS information displayed on the monitor.

Available Settings

LAT/LON (Displays latitude and longitude) *Default setting

UTM (Displays Universal Transverse Mercator Projection (UTM) coordinates.)

MGRS (Displays Military Grid Reference System (MGRS) coordinates.)

ALL (Displays all information above)

- 1 Display the Expanded Settings menu.**
 - For the operating procedure, see P.155.
- 2 Press the ▼ button to select [GPS DISP MODE] and press the ► button.**
- 3 Press the ▲▼ buttons to select the desired setting.**
- 4 Press the MENU/OK button, or ◀ button and press the MENU/OK button.**



Locking the GPS Information (GPS LOCK)

You can set up the  (Quick Review) button to use when locking GPS information.

When GPS information is locked, new GPS information cannot be acquired.

Available Settings

OFF ( button cannot be used to lock GPS information.) *Default setting

ON ( button can be used to lock GPS information.)

1 Display the Expanded Settings menu.

- For the operating procedure, see P.155.



2 Press the ▼ button to select [GPS LOCK] and press the ► button.

3 Press the ▲▼ buttons to select [ON].

4 Press the MENU/OK button, or ◀ button and press the MENU/OK button.



Note

- When this function is set to [ON], you cannot use the  (Quick Review) button for the quick review function.
- Once this function is set to [ON], press the  (Quick Review) button on the shooting screen to lock the GPS information. A symbol appears on the screen.



10 Using the Wireless LAN Function (Only for Caplio 500SE-W)

About the Wireless LAN Function

Caplio 500SE-W is equipped with Bluetooth® and wireless LAN functions to enable connection to other devices. To connect to a wireless device, you must set the Expanded Settings menu to the wireless LAN or Bluetooth® function setting beforehand.

(☞ P.193)

You can use the wireless LAN function to send still pictures (including text mode still images), movies, and sound files. There are two ways to send files using the wireless LAN function.

- Send files via e-mail

You can attach a file to an e-mail and send it to an e-mail address registered in the communication list. You cannot enter a mail message.

- Send files via FTP

You can use File Transfer Protocol (FTP) to send a file to an FTP server registered in the communication list. If there is no FTP server, you can set your computer as a Caplio server (Caplio-only FTP server). (☞ P.199)



Caution

- Wireless LAN-enabled devices can connect at a maximum range of about 30 meters (100 feet). Keep the line-of-sight distance between the destination wireless LAN device and the camera within about 30 meters (100 feet).
- The provided Caplio Setting software must be installed to use the wireless LAN function. Caplio Setting can only be installed on Windows.



Note

- You cannot use the wireless LAN function to send files to a printer. To send files to a printer, use the Bluetooth® function. (☞ P.157)
- Be careful not to obstruct the wireless LAN antenna with your fingers when connected.

Wireless LAN antenna

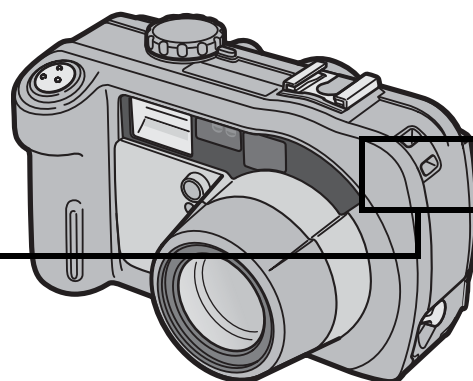

Overview of Transfer Process via a Wireless LAN

① Make advanced file transfer settings. (👉 P.194)

Use the provided Caplio Setting software to make advanced settings for sending files via wireless LAN.
If no FTP server is available, set up your computer to be the Caplio server before making the advanced settings. (Only for sending via FTP) (👉 P.199)



② Create a communication list. (👉 P.202)

Create a communication list combining the desired settings made in Step ①.



Computer settings using the provided Caplio Setting software

③ Transfer the communication list from the camera to the computer. (👉 P.202)

Connect the computer to the camera using the provided USB cable and transfer the communication list to the internal memory of the camera. You can also use the SD memory card to import the communication list to the camera. (👉 P.205)
You can also correct the destination setting on the camera. (👉 P.207)



④ Send files.

Use the Expanded Settings menu on the camera to set the communication method to wireless LAN (👉 P.193), and send the files from the camera. There are two ways to send files.

- FILE SEND (👉 P.209)
Select and send files in playback mode.
- QUICK SEND MODE (👉 P.214)
Immediately after you shoot a still image, you can send that file to another device.

When sending files, you can use the [SEND TO] screen displayed at the time of sending the files to specify the destination, or you can use the Expanded Settings menu to specify the destination beforehand. (👉 P.219)

Selecting the Communication Method (CHANGE COM)

Before sending files from the camera, set whether to connect the camera to the destination by wireless LAN or Bluetooth®.

Available Settings

W-LAN (connect via wireless LAN) *Default setting

BT (connect via Bluetooth®)

- 1 Display the Expanded Settings menu.**
 - For the operating procedure, see P.155.
- 2 Press the ▼ button to select [CHANGE COM] and press the ► button.**
- 3 Press the ▲▼ buttons to select the desired setting.**
- 4 Press the MENU/OK button, or press the ◀ button and then the MENU/OK button.**



Making Advanced Wireless LAN Settings for Sending Files

To send files by wireless LAN, you must use the computer to create a communication list registering the advanced settings for sending files, and then transfer the communication list to the camera. Use the provided Caplio Setting software to make the settings.

1 Install Caplio Setting from the provided Caplio Software CD-ROM.

- For the operating procedure, see P.134.

2 On the [Start] menu, point to [All Programs] or [Programs], point to [Caplio Software], and then click [Caplio Setting].

- Caplio Setting is activated and the [Caplio Setting] screen appears.

3 Click the [All Detailed Setups] button.

- The [Detailed Setups for selections] screen appears.

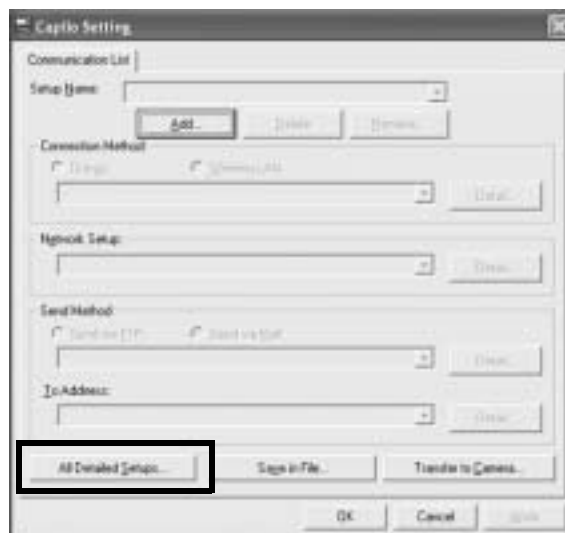

4 Click the tab with the settings you want to make.



- The settings for the Detailed Setups tabs are as shown below.

Detailed Setups tab	Settings
Network	IP address and other settings (Send via Mail, Send via FTP)
Wireless LAN	Wireless LAN settings (Send via Mail, Send via FTP)
Dial-up	This camera is not configured for a dial-up connection, so this setting is not required.
FTP Send	Destination FTP server name and other settings (Send via FTP)
Mail Config.	Destination SMTP server name and other settings (Send via Mail)
Address Book	Destination mail address settings (Send via Mail)



Note

- If there is no FTP server, you can set your computer as a Caplio server and specify the destination for sending via FTP. (P.199)
- You can also make the advanced settings for each individual setting by clicking the [Detail] button to the right of the setting on the [Caplio Setting] screen.

5 Click the [Add] button under the [Setup Name] list.

- The [New Name for the Setup] dialog box appears.

6 Enter a setting name, and then click [OK].

7 Make the advanced settings.

- For the available advanced settings, see P.196.
- To delete a setting, select the setting you want to delete, and click the [Delete] button.
- To rename a setting, select the setting you want to rename, click the [Rename] button, and enter the new setting name in the [New Name for the Setup] dialog box.



8 To make other advanced settings, click the tab with the setting you want to make, and repeat Steps 5 to 7 above.

9 Click [OK].

- The display returns to the [Caplio Setting] screen.



Caution

For details about the settings, consult your system administrator.



Note

When [Apply] is clicked, the current setting is registered.

Detailed Setups Tab Settings

[Network] tab

Item Name	Description
Host Setup Host Name Camera Password	These settings are not required when using this camera.
Automatically retrieves its IP address	Select this to retrieve an IP address automatically for the camera.
Use the following IP address IP address Subnet Mask Default Gateway	Select this to use a fixed IP address, and then enter the information below. [IP address] Fixed IP address for the camera [Subnet Mask] Usually enter 255.255.255.0. [Default Gateway] IP address of an Internet-connected computer
Automatically retrieves the address from the DNS server	Select this to retrieve the address automatically from the DNS server.
Use the following DNS server addresses Primary DNS Server Secondary DNS Server	Select this to use a fixed DNS server address, and then enter the information below. [Primary DNS Server] Primary DNS server address of your Internet service provider [Secondary DNS Server] Secondary DNS server address of your Internet service provider

[Wireless LAN] tab

Item Name	Description
Connection Method	Select from the following connection methods. [Infrastructure] Connection method for communication through routers and access points [AdHoc] Connection method for communication between slave devices
ESS-ID	A wireless LAN enables communication between a master device and a slave device having the same ESS-ID. Enter the same ESS-ID as the master device.

Item Name	Description
Communication Channel	<p>When several access points are in use, a channel is set to each access point. Select the channel of the access point.</p> <p>[Auto] Select this if [Connection Method] is set to [Infrastructure] and there is only one access point.</p> <p>[1-13] If [Connection Method] is set to [Infrastructure] and there are several access points or if [Connection Method] is set to [AdHoc], select the channel you want to use.</p>
Cryptography	<p>Select from the following encryption methods.</p> <p>[None] No encryption is used.</p> <p>[WEP] This can be selected when [Connection Method] is set to either [Infrastructure] or [AdHoc].</p> <p>[AES] This can be selected only when [Connection Method] is set to [Infrastructure].</p> <p>[TKIP] This can be selected only when [Connection Method] is set to [Infrastructure].</p>
Network Key	<p>Enter the security key. Select a key type from [String] and [Hex] and enter an encryption key in the box.</p> <p>[String] When [Cryptography] is set to [WEP]: Enter an encryption key of 5 or 13 characters. Entering a 5-character string uses 40-bit encryption, and entering a 13-character string uses 128-bit encryption. When [Cryptography] is set to [AES] or [TKIP]: Enter an encryption key from 8 to 63 characters.</p> <p>[Hex] This can be selected only when [Cryptography] is set to [WEP]. Enter an encryption key with 10 or 26 digits. Entering a 10-digit string uses 40-bit encryption, and entering a 26-digit string uses 128-bit encryption.</p>
Authentication	<p>[Open System] This can be selected only when [Cryptography] is set to [None] or [WEP]. This authentication does not use WEP keys.</p> <p>[Shared Key] This can be selected only when [Cryptography] is set to [None] or [WEP]. This authentication compares the WEP keys of different devices.</p> <p>[WPA-PSK] This can be selected only when [Cryptography] is set to [AES] or [TKIP].</p> <p>[WPA2-PSK] This can be selected only when [Cryptography] is set to [AES] or [TKIP].</p>

[FTP Send] tab

Item Name	Description
Server Name	Set the name and IP address of the destination FTP server to which to send files. If your computer is set as a Caplio server (P.199), set the IP address of your computer.
User Name and Password	Set the user name (user ID) and password necessary for connecting to an FTP server. If your computer is set as a Caplio server (P.199), this setting is not required.
Specify Folder	Set the destination folder name (inbox folder in the FTP server).
Does not send a file whose name already exists.	Check this box to not send files with the same name to the destination folder. Do not check this box to send files with the same name to the destination folder. This setting is disabled when using a Caplio server (P.199). In this case, files with the same name are renamed and saved to the destination folder. (P.201)

[Mail Config.] tab

Item Name	Description
Server Name	Set the name of the SMTP server (outgoing mail server) of your Internet service provider.
User Name and Password	Set the user name (user ID) and password necessary for connecting to your Internet service provider.
From Address	Enter the mail-from (your) address.

[Address Book] tab

Item Name	Description
E-mail Address	Enter the destination address.

**Note** -----

This camera is not configured for dial-up connection, so settings in the [Dial-up] tab are not required.

Setting Up a Caplio-only FTP Server

If you do not have access to an FTP server, you can use the provided Caplio Server software to set up your computer as a Caplio server (Caplio-only FTP server).

This setup is not necessary to send files to an FTP server already configured on your computer.



Caution-----

- The FTP server set by using Caplio Server permits FTP connection from this camera only. Other FTP clients cannot access this server.
- Files cannot be sent from the FTP server to the camera.

1 Install Caplio Setting from the provided Caplio Software CD-ROM.

- For the operating procedure, see P.134.

2 On the [Start] menu, point to [All Programs] or [Programs], point to [Caplio Software], and then click [Caplio Server].

- Caplio Server is activated and the [Caplio Server] screen appears.

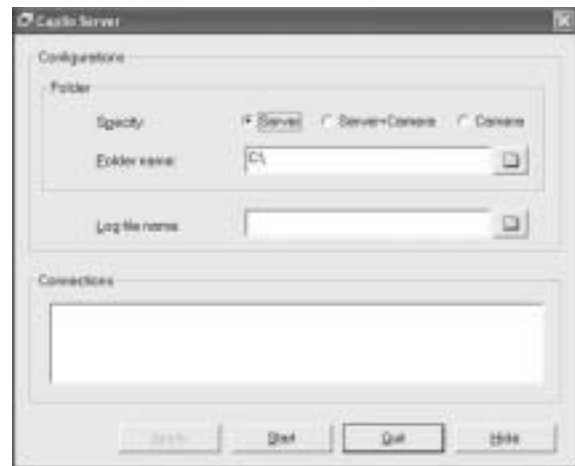

3 Select an inbox folder specification method in the [Specify] field.

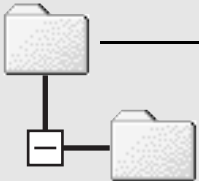
Item Name	Description
Server	Specify the inbox folder in [Folder name] box.
Server+Camera	The following are inbox folders.  Folder specified by [Folder name] Folder specified with the camera ^(*)
Camera	Specify the inbox folder on the camera. ^(*)

- (*) The folder set in [Specify Folder] on the [FTP Send] tab (P.198) is the inbox folder.



Note

The inbox folder is not created automatically. Create a folder with the same name as the specified folder.

4 When [Server] or [Server+Camera] is selected in Step 3, specify the inbox folder in the [Folder name] box.

- Click the folder icon to display a dialog box. You can select and specify a folder here.

5 When necessary, specify a log file name in the [Log file name] box.

- If a log file name is specified, a connection status log file is created. If not, no log file is created.
- Specify a full path for the log file name.
- Click the folder icon to display a dialog box. You can select and specify the folder name here.

6 Click [Apply].

- This completes the setup.

7 Click [Quit].

- Caplio Server closes.

Using the Caplio Server

To send files from the camera to an FTP server, you must register the set FTP server to the communication list, and then transfer the communication list to the camera (☞ P.202).

When using a Caplio server, after sending the communication list to the camera, follow the procedure below to use the FTP server.

1 On the [Start] menu, point to [All Programs] or [Programs], point to [Caplio Software], and then click [Caplio Server].

- Caplio Server is activated and the [Caplio Server] screen appears.

2 Click [Start].

- The FTP server is activated and becomes ready to receive images from the camera.
- To hide the [Caplio Server] screen, click the [Hide] button. The screen is hidden and its icon is displayed on the taskbar. To display the screen again, click the icon on the taskbar.



3 Send files from the camera.

- For the procedure for sending files, see P.209 or P.214.
- The [Caplio Server] screen displays the communication status in the [Connections] box.
- The files are saved in the specified inbox folder (☞ P.199).



Note

If the inbox folder already has a file of the same file name, the file being sent is renamed by appending a serial number from 001 to 999 and saved to the inbox folder. If the same file number with a serial number from 001 to 999 already exists in the inbox folder, the file is overwritten.

Creating a Communication List and Transferring it to the Camera

After completing the advanced settings on the [Detailed Setups for selections] screen, create a communication list combining the desired settings and transfer it to the camera via the supplied USB cable.



Caution

[USB CONNECTION] must be set to [ORIGINAL] on the camera's SETUP menu. (☞ P.123)



Note

You can also save the communication list on the computer, copy it to an SD memory card, and import it into the camera. (☞ P.205)

1

If Caplio Setting is not active, on the [Start] menu, point to [All Programs] or [Programs], point to [Caplio Software], and then click [Caplio Setting].

- Caplio Setting is activated and the [Caplio Setting] screen appears.

2

Click the [Add] button under the [Setup Name] list.

- The [New Name for the Setup] dialog box appears.

3

Enter a setting name, and then click [OK].

4

Select [Wireless LAN] in the [Connection Method] field, and then select the desired wireless LAN setting from the pull-down menu.

- The settings registered on the Detailed Setups [Wireless LAN] tab are displayed.

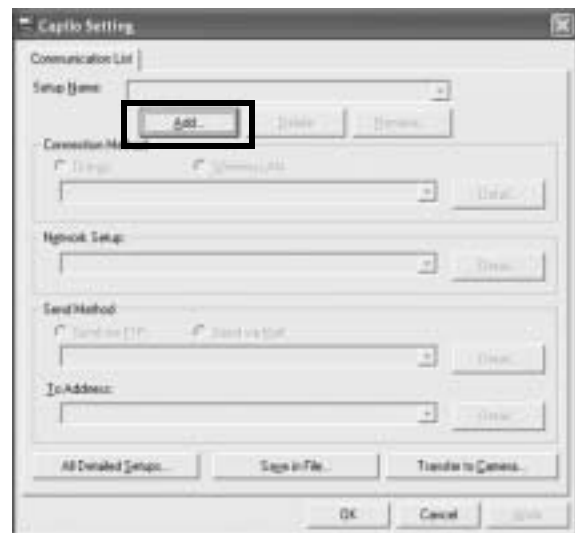

5

Select the desired network setting from the [Network Setup] pull-down menu.

- The settings registered on the Detailed Setups [Network] tab are displayed.

- 6** Select either [Send via FTP] or [Send via Mail] in the [Send Method] field.
- 7** Select the desired Send via FTP setting or Mail Config. setting from the pull-down menu.
 - The settings registered on the Detailed Setups [FTP Send] or [Mail Config.] tab are displayed.
- 8** If [Send via Mail] is selected in Step 6, select the desired address book setting from the [To Address] pull-down menu.
 - The settings registered on the Detailed Setups [Address Book] tab are displayed.
- 9** To create another communication setting, repeat Steps 2 to 8.
 - To delete a communication setting, select the setting you want to delete, and click the [Delete] button.
 - To rename a communication setting, select the setting you want to rename, click the [Rename] button, and enter the new setting name in the [New Name for the Setup] dialog box.
 - To edit a communication setting, select the setting you want to edit and edit the setting.
- 10** Click [Apply].
- 11** Make sure that the camera is off.
- 12** Connect the provided USB cable to a USB port on your computer.
- 13** Connect the USB cable to the USB terminal on your camera.
 - Your camera turns on.

14 Click [Transfer to Camera].

- A screen appears confirming whether to update the information set in the camera. Click [Yes] to update the information. Click [No] to cancel the update.
- After Step 10, if [Transfer to Camera] is clicked without clicking [Apply], a message appears confirming whether to save the edited setting. Click [OK] to save the edited setting. Click [No] to cancel the transfer of the communication list.
- Transfer of the communication list begins, and once the transfer is completed, a message indicating this appears.

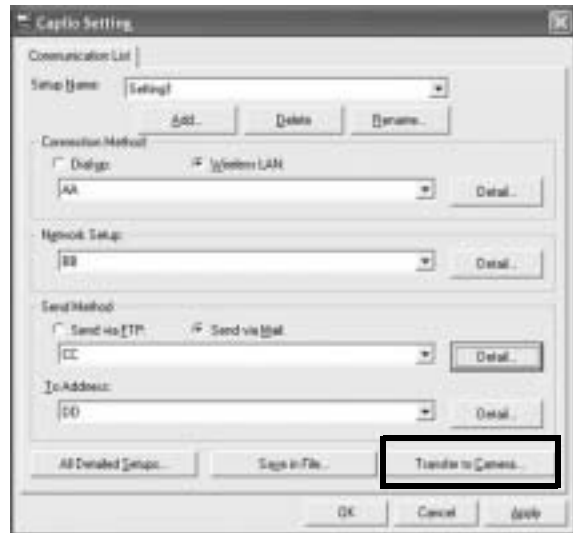
**15 Click [OK] on the message box.****16 Click [OK] on the [Caplio Setting] screen.**

- Caplio Setting closes.

**Note**

The settings made on the [Caplio Setting] screen (Detailed Setups and Communication List settings) are saved regardless of whether or not they are transferred to the camera or saved on the computer. When Caplio Setting is restarted, the last settings used are displayed.

17 Turn off the camera and disconnect the USB cable from the camera and computer.

- For disconnecting the USB cable, see P.153.

Importing a Communication List from an SD Memory Card (READ COM SETTING)

You can save the communication list on the computer, copy it to an SD memory card, and import it into the camera.



Caution-----

Use an SD memory card formatted with this camera.

1 Create a communication list (☞ P.202 Steps 1 to 9), and click [Save in File].

- The [Browse for Folder] dialog box appears.

2 Select the folder to which to save the communication list, and click [OK].

- Once the communication list is saved, a message indicating this appears.
- The communication list is saved with the file name "SYSTEM.PRM".

3 Click [OK] on the message box.

4 Click [OK] on the [Caplio Setting] screen.

- Caplio Setting closes.

5 Use a PC card slot or card reader to copy the communication list ("SYSTEM.PRM") to the SYSTEM folder on the SD memory card.



6 Load the SD memory card with the copied communication list into the camera.

7 Turn on the camera to display the Expanded Settings menu.

- For the operating procedure, see P.155.



8 Press the ▼ button to select [READ COM SETTING], and then press the ► button.

- A screen appears confirming whether to import the communication list.

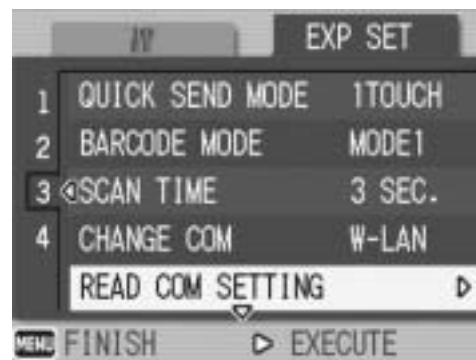

9 Press the ► button to select [YES] and then press the MENU/OK button.

- If a communication list has already been imported, a screen appears confirming whether to overwrite the communication list. To overwrite the communication list, select [Yes]. Selecting [No] cancels importing and returns to the Expanded Settings menu.
- The communication list is imported from the SD memory card into the camera and the display returns to the Expanded Settings menu.



10 Press the MENU/OK button.

Caution-----
Only one communication list can be imported from the SD memory card into the camera.

Note-----
A communication list can also be transferred from the computer to the camera by using the USB cable. (P.202)

Confirming and Editing the Destination Setting on the Camera

You can use the camera to confirm and edit the settings of the communication list transferred to the camera.

1 Turn on the camera to display the Expanded Settings menu.

- For the operating procedure, see P.155.

2 Press the ▼ button to select [SEND TO] and press the ► button.

- A screen appears with a list of destinations set on the communication list.

3 Press the ▲▼ buttons to select the destination with the setting you want to edit, and press the ► button.

- The setup category of the selected destination is displayed.

4 Press the ▲▼ buttons to select the setup category with the setting you want to edit, and press the ► button.

- The setting of the selected destination is displayed.

5 Press the ▲▼ buttons to select the setting you want to edit, and press the ► button.

- The selection screen or keyboard screen appears.

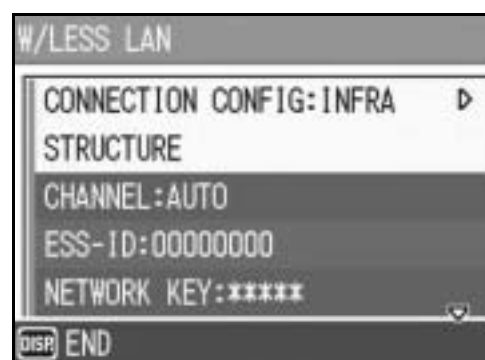
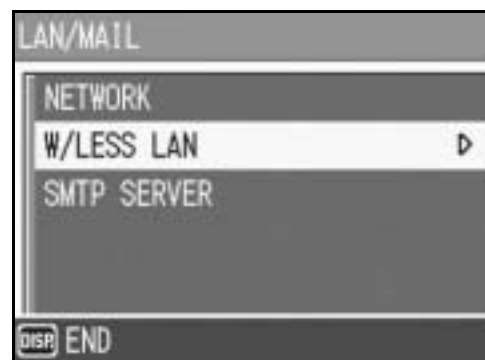
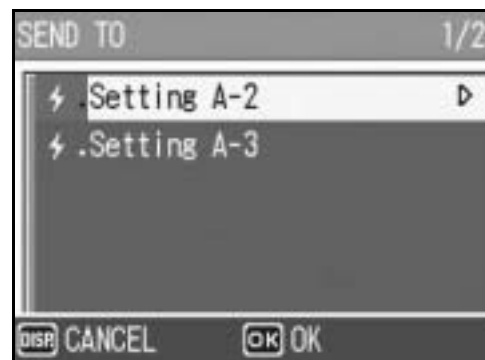

6 Change the setting.

- Only alphanumeric characters can be entered with the keyboard screen. For information on how to use the keyboard, see P.163.

7 After completing changes, press the MENU/OK button.

- The display returns to the settings display screen.
- To edit other settings, repeat Steps 5 to 7.

8 Press the DISP. button.

- The display returns to the setup category display screen.
- To edit other setup categories, repeat Steps 4 to 8.

9 Press the DISP. button.

- The display returns to the [SEND TO] screen.
- To edit other destinations, repeat Steps 3 to 9.

10 After completing changes, press the MENU/OK button.

- The display returns to the Expanded Settings menu.

11 Press the MENU/OK button.**Caution**-----

- In Caplio Setting, if the [Cryptography]/[Authentication] on the [Wireless LAN] tab are set as follows (☞ P.196), [Cryptography/Authentication] is automatically set to [OFF/OPEN] when [Connection Method] in [W/LESS LAN] is set to [AD-HOC].
[AES]/[WPA-PSK], [AES]/[WPA2-PSK], [TKIP]/[WPA-PSK], [TKIP]/[WPA2-PSK]
- When [Cryptography/Authentication] in [W/LESS LAN] is changed on the camera, check the network key. (☞ P.197)
- If [Cryptography/Authentication] is set to [WEP/OPEN] or [WEP/SHARED], enter the [Network Key] as below.
[String]: Five characters or 13 characters
[Hex]: Ten characters or 26 characters
- If [Cryptography/Authentication] is set to [AES/WPA-PSK], [AES/WPA2-PSK], [TKIP/WPA-PSK], or [TKIP/WPA2-PSK], enter an 8 to 63 character network key.

Sending Still Images, Movies, and Sound Files (FILE SEND)

You can send still pictures (including text mode still images), movies, and sound files from the camera. The sent files are processed according to the computer settings.

Files are sent from the internal memory when no SD memory card is loaded or from an SD memory card when installed.

There are three ways to send files.

- Send one file (👉 P.210)
- Send all files from the camera (👉 P.210)
- Select and send several files (👉 P.212)



Caution-----

Before sending files, create a communication list on the computer and transfer it to the camera. (👉 P.202)



Note-----

- You can set the file size of the image beforehand. (👉 P.178)
- When sending files, you can use the [SEND TO] screen displayed at the time of sending the files to specify the destination, or you can also use the Expanded Settings menu to specify the destination beforehand. (👉 P.219)
- For information about setting your computer to receive images, see the documentation that came with the computer.

Sending One or All Files

1 Check that the destination device (computer) is turned on.

2 Press the  (Playback) button.



- Check that [CHANGE COM] is set to [W-LAN] on the Expanded Settings menu. (P.193)
- To send all files, go to Step 4.

3 Press the   buttons to select a file to send.

4 Press the MENU/OK button.

- The Playback Setting menu appears.

5 Press the  button to select [FILE SEND] and press the  button.

- If [SEND CONDITION] is set to [ON], the [SEND TO] screen appears.
- If [SEND CONDITION] is set to [OFF] ( P.219), go to Step 7.
- If the communication list has not been transferred, or if [SEND CONDITION] is set to [OFF] ( P.219) and the destination setting is incorrect, an error message appears and the display returns to the Playback Setting menu.
- If the camera is connected using a serial connection, a screen appears confirming whether to disconnect the serial connection. Select [YES] and press the MENU/OK button.

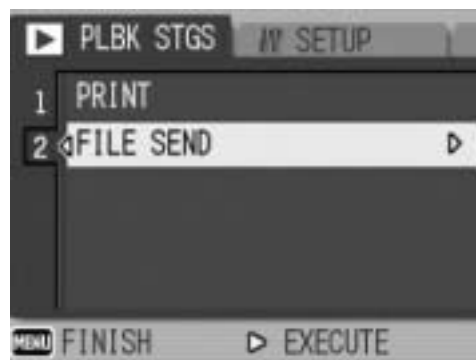

6 Press the   buttons to select the desired destination device and then press the MENU/OK button.

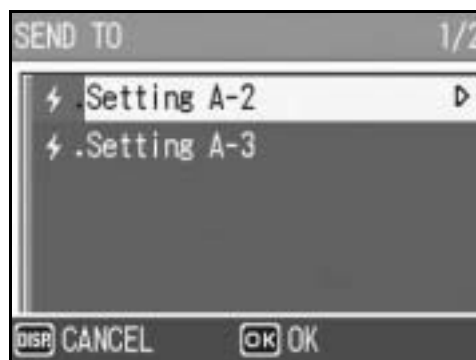

7 Press the ▲▼ button and [SEND ONE] to send one file or [SEND ALL] to send all files, and then press the MENU/OK button.



- Transfer of the files to the destination device begins and the progress is displayed. Pressing the DISP. button cancels the operation. Pressing the  (Playback) button or shutter release button also cancels the operation.
- If an error message appears during file transfer, follow the message instructions and resend the files. For details about the error messages, see P.223.
- Once the file transfer is completed, a message indicating this appears.

8 Press the MENU/OK button.

- The display returns to the playback screen.

Sending Several Files

1 Check that the destination device (computer) is turned on.

2 Press the  (Playback) button.



- Check that [CHANGE COM] is set to [W-LAN] on the Expanded Settings menu. (☞ P.193)

3 Press the  (Thumbnail Display) button twice.

- The screen is divided into 12 frames and thumbnails are displayed.

4 Press the MENU/OK button.

- The Playback Setting menu appears.

5 Press the  button to select [FILE SEND], and then press the  button.

- If [SEND CONDITION] is set to [ON], the [SEND TO] screen appears.
- If [SEND CONDITION] is set to [OFF] (☞ P.219), go to Step 7.
- If the communication list has not been transferred, or if [SEND CONDITION] is set to [OFF] (☞ P.219) and the destination setting is incorrect, an error message appears and the display returns to the Playback Setting menu.
- If the camera is connected using a serial connection, a screen appears confirming whether to disconnect the serial connection. Select [YES] and press the MENU/OK button.

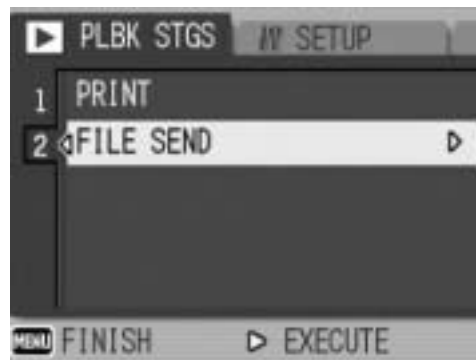

6 Press the   buttons to select the desired destination device and then press the MENU/OK button.

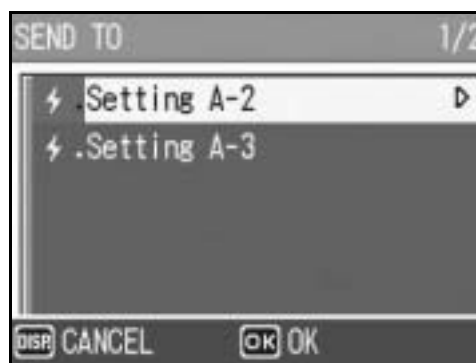

7 Press the ▲▼◀▶ button to select the file to send, and then press the MENU/OK button.

- The envelope icon appears on the screen.



8 Repeat Step 7 to select all the files you want to send.

- If you selected a file by mistake, you can deselect it by selecting the file and pressing the MENU/OK button again.

9 Press the DISP. button.

- A screen appears confirming whether to send the selected files.

10 Press the ► button to select [YES], and then press the MENU/OK button.

- Transfer of the files to the destination device begins and the progress is displayed. Pressing the DISP. button cancels the operation. Pressing the ► (Playback) button or shutter release button also cancels the operation.
- If an error message appears during file transfer, follow the message instructions and resend the files. For details about the error messages, see P.223.
- Once the file transfer is completed, a message indicating this appears.

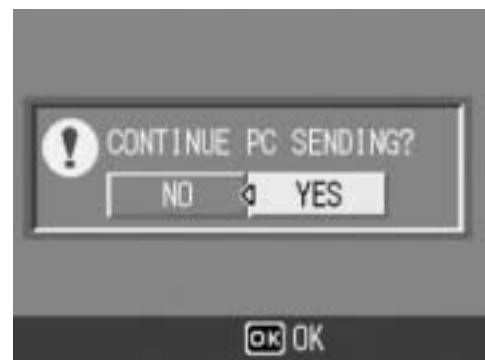

11 Press the MENU/OK button.

- The display returns to the playback screen.



Note -----

- When the [Does not send a file whose name already exists.] box is checked on the [FTP Send] tab in the advanced settings of the communication list (☞ P.198), a file whose name already exists is not sent to the Send via FTP inbox folder. After the files whose names do not exist already are sent, a screen appears confirming whether to rename and send or overwrite the files whose names already exist in the inbox. Select [YES] or [NO], and press the MENU/OK button. If a communication error message appears while overwriting the file, press the MENU/OK button. A message appears again, confirming whether to overwrite the file. Press the ► button to select [YES] or [NO], and then press the MENU/OK button.
- When the [Does not send a file whose name already exists.] box is not checked on the [FTP Send] tab in the advanced settings of the communication list (☞ P.198), the file whose name already exists in the Send via FTP inbox folder is overwritten.
- You can set the camera to automatically delete a file from the camera after it has been sent. (☞ P.179)

Sending Files in Shooting Mode (Quick Review Send)

Immediately after you shoot an image, you can send the image file to another device. This is convenient if you want to send images to a predetermined device.

You need to set [QUICK SEND MODE] on the Expanded Settings menu beforehand.



Caution

Before sending files, create a communication list on the computer and transfer it to the camera. (👉 P.202)



Note

For information about setting your computer to receive images, see the documentation that came with the computer.

Setting Up Quick Review Send (QUICK SEND MODE)

Available Settings	
OFF *Default setting	Files are not sent in shooting mode.
1TOUCH	Files are sent by pressing the MENU/OK button after shooting while the file is displayed (👉 P.116). You can use this function to send only still images (.JPG). If there are still images with sounds (.JPG and .WAV), only still images (.JPG) are sent. You must use the Expanded Settings menu to specify the destination beforehand. (👉 P.220)
2TOUCH	Files are sent by pressing the MENU/OK button after shooting during quick review display (👉 P.46). You can use this function to send still images (.JPG), text (.TIF), and still images with sound (.JPG and .WAV). When sending files, you can use the [SEND TO] screen displayed at the time of sending the files to specify the destination, or you can also use the Expanded Settings menu to specify the destination beforehand. (👉 P.219)

1 Display the Expanded Settings menu.

- For the operating procedure, see P.155.
- Check that [CHANGE COM] is set to [W-LAN]. (P.193)

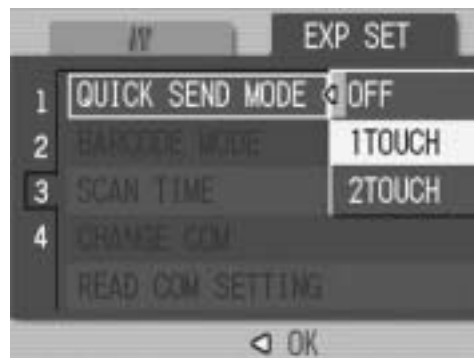
2 Press the ▼ button to select [QUICK SEND MODE] and press the ► button.**3 Press the ▲▼ buttons to select [1TOUCH] or [2TOUCH].****4 Press the MENU/OK button, or press the ◀ button and then the MENU/OK button.****Using Quick Review Send****When [QUICK SEND MODE] is set to [1TOUCH]****1 Check that the destination device (computer) is turned on.****2 Turn the mode dial to /CAL S and shoot the picture.**

- While the image is displayed after shooting, a screen appears confirming whether to send the file. (☞ P.116)

3 Press the MENU/OK button.

- Transfer of the image to the destination (☞ P.220) specified in [SEND TO] on the Expanded Settings menu begins.

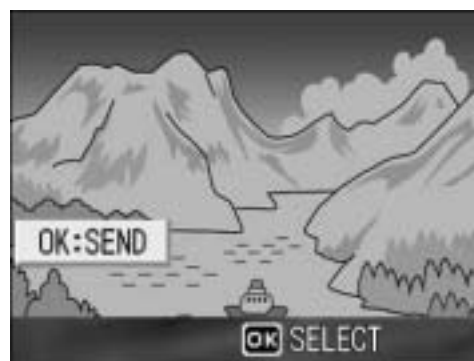

- Once the transfer is completed, the camera returns to shooting mode and remains connected to the destination device. You can change to playback mode or voice memo mode or remain connected to the destination device until the camera is turned off. The wireless LAN antenna icon appears on the LCD monitor while the camera is connected.



**Note**-----

- In the following cases, you cannot use Quick Review Send to send files to a device even when [QUICK SEND MODE] is set to [1TOUCH].
 - When a communication list has not been transferred to the camera (👉 P.202)
 - When the destination setting is incorrect
 - When [Server Name] is not set on the Detailed Setups [FTP Send] tab (👉 P.198)
 - When [E-mail Address] is not set on the Detailed Setups [Address Book] tab (👉 P.198)
 - When [LCD CONFIRM.] is set to [OFF] (👉 P.116)
 - During scene mode (👉 P.40)
 - During S-CONT or M-CONT (👉 P.69)
- During Bluetooth® connection, you cannot use Quick Review Send to send still images even when [QUICK SEND MODE] is set to [1TOUCH]. Before you can use Quick Review Send to send still images, you must first disconnect the Bluetooth® connection. (👉 P.174, P.182, P.184)
- When image with sound is set to [ON] (👉 P.76), after pressing the MENU/OK button in Step 3, the send button remains displayed until sending is started.
- The image size set with [IMAGE FILE SIZE] (👉 P.178) does not apply.
- The [SEND TO] screen does not appear even when [SEND CONDITION] is set to [ON].
- You can set the camera to automatically delete a file from the camera after it has been sent. (👉 P.179)

When [QUICK SEND MODE] is set to [2TOUCH]

1 Check that the destination device (computer) is turned on.

2 Turn the mode dial to /CALC and shoot the picture.

3 Press the (Quick Review) button.

- A screen appears confirming whether to send the file.

4 Press the MENU/OK button.

- If [SEND CONDITION] is set to [ON], the [SEND TO] screen appears.
- If [SEND CONDITION] is set to [OFF] (P.219), sending to the destination selected in [SEND TO] (P.220) begins, and the progress is displayed.
- If the communication list has not been transferred, or if [SEND CONDITION] is set to [OFF] (P.219) and the destination setting is incorrect, an error message appears and the display returns to the Playback Setting menu.
- If the camera is connected with a Bluetooth[®]-enabled device, a screen appears confirming whether to disconnect the connection. Select [YES] and press the MENU/OK button. (P.174, P.182, P.184)

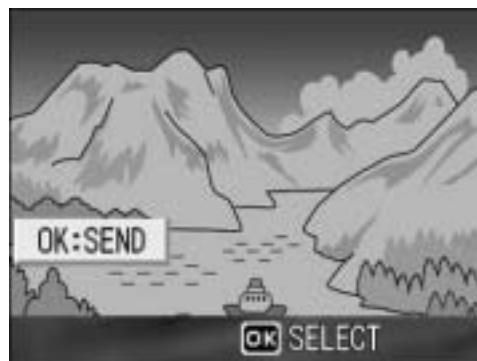





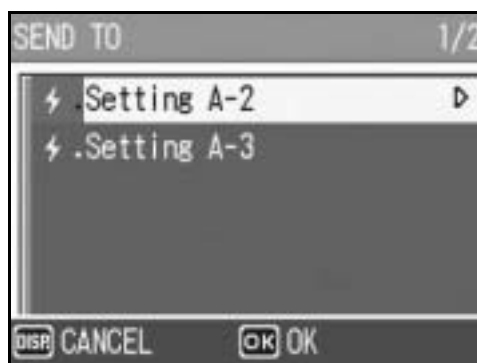

5 Press the buttons to select the desired destination device and then press the MENU/OK button.

- Transfer of the files to the destination device begins and the progress is displayed. Pressing the DISP. button cancels the operation. Pressing the (Playback) button or shutter release button or turning the mode dial also cancels the operation.
- If an error message appears during transfer, follow the message instructions and resend the files. For details about the error messages, see P.223.
- Once the connection is established, the camera returns to shooting mode and remains connected to the destination device. You can change to playback mode or voice memo mode or remain connected to the destination device until the camera is turned off. The wireless LAN antenna icon appears on the LCD monitor while the camera is connected.



**Note** -----

- During manual focus ( P.65), you cannot use Quick Review Send to send files to a device even when [QUICK SEND MODE] is set to [2TOUCH].
- When the [Does not send a file whose name already exists.] box is checked on the [FTP Send] tab in the advanced settings of the communication list ( P.198), a file whose name already exists is not sent to the Send via FTP inbox folder. After the files whose names do not exist already are sent, a screen appears confirming whether to rename and send or overwrite the files whose names already exist in the inbox. Select [YES] or [NO], and press the MENU/OK button. If an error message appears while overwriting the file, press the MENU/OK button. A message appears again, confirming whether to overwrite the file. Press the  button to select [YES] or [NO], and then press the MENU/OK button.
- When the [Does not send a file whose name already exists.] box is not checked on the [FTP Send] tab in the advanced settings of the communication list ( P.198), the file whose name already exists in the Send via FTP inbox folder is overwritten.
- The size of the image files to be sent can be set beforehand. ( P.178)
- You can set the camera to automatically delete a file from the camera after it has been sent. ( P.179)

**To disconnect after Quick Review Send** -----

Once Quick Review Send is completed, the camera returns to shooting mode and remains connected to the destination device. Switch to playback mode or voice memo mode, or turn the camera off to disconnect.

Specifying a Destination on the Camera Beforehand

When sending files, you can use the [SEND TO] screen displayed at the time of sending the files to specify the destination, or, you can choose not to display the [SEND TO] screen and specify the destination beforehand. This is useful when sending files to the same destination each time.

Hiding the [SEND TO] Screen (SEND CONDITION)

Available Settings

OFF (Hides the [SEND TO] screen)

ON (Displays the [SEND TO] screen) *Default setting

- 1 Display the Expanded Settings menu.**
 - For the operating procedure, see P.155.
- 2 Press the ▼ button to select [SEND CONDITION] and press the ► button.**
- 3 Press the ▼ button to select [OFF].**
- 4 Press the MENU/OK button, or press the ◀ button and then the MENU/OK button.**



Note

When [SEND CONDITION] is set to [ON], each time you send a file, the [SEND TO] screen appears, and you can specify the destination.

Specifying a Destination (SEND TO)

1 Display the Expanded Settings menu.

- For the operating procedure, see P.155.

2 Press the ▼ button to select [SEND TO] and press the ► button.

- A screen appears with a list of destinations set on the communication list.



3 Press the ▲▼ buttons to select a destination to which to connect.

- You can also confirm and edit the destination setting on the camera. (☞ P.207)

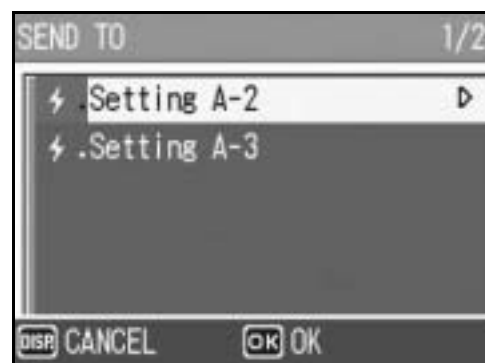

4 Press the MENU/OK button.

- The destination is set and the display returns to the Expanded Settings menu.

5 Press the MENU/OK button.



Note

 If a destination is not specified with [SEND TO], the destination at the top of the [SEND TO] list is selected. When [SEND CONDITION] is set to [OFF], or when [QUICK SEND MODE] is set to [1 TOUCH] to use Quick Review Send, the file is sent to the destination at the top of the list.

Troubleshooting

Error Messages

If an error message is displayed on the screen, take the corresponding action.

Non-Bluetooth[®] or Wireless LAN related error messages

Error Message	Cause and Action	Refer to
INSERT CARD	No card is loaded. Insert a card.	P.25
SET DATE.	The date is not set. Set the date.	P.119
FILE NUMBER OVER LIMIT	The file number limit has been exceeded. Use another card.	P.117
UNMATCHED FILE	The camera cannot display this file. Check the file contents on your computer, and then delete the file.	-
INSUFFICIENT MEMORY. CONTINUE?	Because there is not sufficient capacity on the card, all the files cannot be copied. Use another card.	P.22
PROTECTED	You are trying to delete a protected file.	P.90
CARD IS WRITE-PROTECTED.	The card is "Locked (write-protected)". Unlock the card.	P.22
PRINT SETTINGS CANNOT BE SET FOR THIS FILE.	This file (movie or other file) cannot be selected for printing.	-
INSUFFICIENT MEMORY	Files cannot be stored. Make sure there is enough free space or delete unwanted files.	P.51 P.109 P.110
	The image print number limit has been exceeded. Select an image and set the number to 0.	-
FORMAT INTERNAL MEMORY	You must format the internal memory.	P.110
FORMAT CARD	The card is not formatted. Format the card with this camera.	P.109
CARD ERROR	Reformat the card. If, after doing so, the error message still appears, the card may be faulty. Do not use the card.	P.109
WRITING TO CARD	Writing file to memory. Wait until writing finishes.	-
NO FILE	There are no files that can be played back.	-
CANNOT RECORD	The number of remaining shots is 0. Switch to another card or the internal memory.	P.22

Bluetooth® related error messages

Error Message	Cause and Action	Refer to
REQUESTED FILE CANNOT PRINT.	You attempted to send an image other than still ones (.JPG). Only still images (.JPG) can be sent.	P.154
REQUESTED FILE CANNOT BE SENT.	You attempted to send an image other than still ones (.JPG). Only still images (.JPG) can be sent.	P.154
VERIFYING FAILED.	The input passkey did not match the destination device. Enter the correct passkey.	-
	The passkey was not entered within the time limit. Enter the passkey again within the time limit.	P.162
CANNOT CONNECT.	At the start of transfer, the destination device could not be connected due to one of the following causes. Check the device status and start again from the beginning. <ul style="list-style-type: none"> • Signal no longer reach the destination device. • The destination device does not exist nearby (about 10 m). • The destination device is not active because the power is off or due to other causes. • The destination device does not support the Bluetooth® Profiles required for communication with this camera. • Inappropriate device was selected for the destination. 	P.154
PRINTING FAILED.	Printing failed during transfer due to one of the causes below. Check the device status and start again from the beginning. <ul style="list-style-type: none"> • Signal no longer reach the destination device. • The destination device is not ready to print. • There is insufficient space on the destination device. 	-
CANNOT SEND.	Transfer was interrupted by one of the following causes. Check the device status and start again from the beginning. <ul style="list-style-type: none"> • Signal no longer reach the destination device. • The destination device can no longer receive a signal. • There is insufficient space on the destination device. 	-

Wireless LAN related error messages (Only for Caplio 500SE-W)

Communication and send setting errors

Error Message	Cause and Action	Refer to
CONNECTION ERROR	The camera is unable to establish a connection for some reason. Check the communication settings.	P.194 P.202
SEND METHOD MUST BE SELECTED	The [Send Method] setting is not selected in the communication settings. Select [Send via FTP] or [Send via Mail].	P.202
NO SEND TO ADDRESS	The [To Address] setting is not selected in the communication settings. Select the [To Address] setting.	P.202
CANNOT CONNECT TO ACCESS POINT	The destination access point is off or otherwise not operating. Check the access point.	-
	Incorrect communication settings. Check the send settings.	P.202
THE IP ADDRESS IS ALREADY IN USE	The same IP address as the camera exists in the destination network. Check the [IP address] in the Detailed Setups [Networks] tab.	P.196
CONFLICTING LAN SETTING	The first destination sent to after turning the camera on and the setting in the Detailed Settings [Network] tab or [Wireless LAN] tab is different. To send to a destination different from the setting in the [Network] or [Wireless LAN] tab, change the destination in advance and restart the camera.	P.196 P.219
DESTINATION NOT REGISTERED	The communication list has not been imported by the camera. Import the communication list into the camera and try again.	P.202
INVALID KEY SIZE.	When [Cryptography/Authentication] in [W/LESS LAN] is changed on the camera, check the network key. <ul style="list-style-type: none"> • If [Cryptography/Authentication] is set to [WEP/OPEN] or [WEP/SHARED], enter the [Network Key] as below. <ul style="list-style-type: none"> [String]: Five characters or 13 characters [Hex]: Ten characters or 26 characters • If [Cryptography/Authentication] is set to [AES/WPA-PSK], [AES/WPA2-PSK], [TKIP/WPA-PSK], or [TKIP/WPA2-PSK], enter an 8 to 63 character network key. For details, refer to [Network Key] on P.197	P.197 P.207

FTP send setting errors

Error Message	Cause and Action	Refer to
NO UPLOAD SERVER NAME SETTING	[Server Name] for the destination is not set in the Detailed Setups [FTP Send] tab. Set the [Server Name] setting.	P.198
CANNOT DETECT IP ADDRESS	Unable to acquire the IP address of the destination server. Set the correct [Server Name] setting in the Detailed Setups [FTP Send] tab.	P.198
NO RESPONSE FROM SERVER	The destination server does not respond. Check the advanced settings on the [FTP Send] tab.	P.198
CANNOT CONNECT TO SERVER	Unable to connect to the destination server. Check the advanced settings on the [FTP Send] tab.	P.198
SETTING ERROR EITHER IN USER NAME OR PASSWORD	Incorrect [User Name] or [Password] setting. Set the correct [User Name] and [Password] settings in the Detailed Setups [FTP Send] tab.	P.198
THE FOLDER DOES NOT EXIST.	The specified inbox folder does not exist on the destination. Set the correct [Folder Name] setting in the Detailed Setups [FTP Send] tab.	P.198
CANNOT SEND	Unable to send files for some reason. Check the advanced settings on the [FTP Send] tab.	P.198
SERVER ERROR	An error is received from the server after connecting to the server. Try resending the file.	-

Mail send setting errors

Error Message	Cause and Action	Refer to
NO UPLOAD SERVER NAME SETTING	The [Server Name] is not set in the Detailed Setups [Mail Config.] tab. Set the [Server Name] setting.	P.198
CANNOT DETECT IP ADDRESS	Unable to acquire the IP address of the SMTP server. Set the correct [Server Name] setting in the Detailed Setups [Mail Config.] tab.	P.198
NO RESPONSE FROM SERVER	The SMTP server does not respond. Check the advanced settings on the [Mail Config.] tab.	P.198
CANNOT CONNECT TO SERVER	An error is received from the server after connecting to the server. Try resending the file.	-
SETTING ERROR EITHER IN USER NAME OR PASSWORD	Incorrect [User Name] or [Password] setting. Set the correct [User Name] and [Password] settings in the Detailed Setups [Mail Config.] tab.	P.198
FILE SIZE IS TOO LARGE TO SEND	The image was not sent because the image file size is too large. Reduce the file size and try resending the image.	P.178
CANNOT SEND	Unable to send files for some reason. Wait a moment, and then try reconnecting.	-
SERVER ERROR	An error is received from the server after connecting to the server. Wait a moment, and then try reconnecting.	-

Other errors

Error Message	Cause and Action	Refer to
CANNOT PRINT VIA WIRELESS LAN.	You cannot use the wireless LAN function to send files to a printer. To send files to a printer, use the Bluetooth [®] function.	P.157
NO FILE SELECTED FOR DIRECT UPLOAD	The files to be sent are not selected in the thumbnail display. Select the files and click the MENU/OK button.	P.212



Note



If you cannot solve the problem using the solutions above, contact a Ricoh office or your local authorized Ricoh dealer.



Camera Troubleshooting

Power Supply

Problem	Cause	Solution	Refer to
The camera does not turn on.	Battery is not loaded or is exhausted.	Load the rechargeable battery correctly or charge the battery as required. Use the AC adapter as required. Replace the alkaline batteries with new batteries.	P.24 P.25 P.27
	A (manganese dry cell or other) unacceptable battery is used.	Use the dedicated rechargeable battery or alkaline batteries. Never use any other batteries.	P.20
	The AC adapter is not connected correctly.	Reconnect it properly.	P.27
	The camera is automatically turned off by auto power off.	Turn the camera back on.	P.29
	The battery is loaded in wrong direction.	Load correctly.	P.25
The camera turns off during use.	The camera was left unattended and unused, so auto power off turned it off.	Turn the camera back on.	P.29
	Battery is running low.	Charge the rechargeable battery or use the AC adapter. Replace the alkaline batteries with new batteries.	P.24 P.27 P.25
	A (manganese dry cell or other) unacceptable battery is used.	Use the dedicated rechargeable battery or alkaline batteries. Never use any other batteries.	P.20
The camera does not turn off.	Camera malfunction.	Remove the battery and load it again. Reconnect the AC adapter cable properly, if using.	P.25 P.27
The battery has been fully charged, but: <ul style="list-style-type: none"> The battery mark is displayed, indicating a low battery level. The camera turns off. 	A (manganese dry cell or other) unacceptable battery is used.	Use the dedicated rechargeable battery or alkaline batteries. Never use any other batteries.	P.20
Cannot charge the battery.	Battery has reached the end of its useful life.	Replace with a new battery.	P.25
Battery runs out quickly.	It is being used at extreme high or low temperatures.	-	-
	Many shots are being taken in dark places or other location requiring extensive use of flash.	-	-

Shooting

Problem	Cause	Solution	Refer to
The camera does not shoot even if you press the shutter release button.	Battery is exhausted.	Charge the rechargeable battery or use the AC adapter. Replace the alkaline batteries with new batteries.	P.24 P.27 P.25
	The camera is not on or it is not in the shooting mode.	Turn on the camera, and turn the mode dial to the shooting mode. Press the  (Playback) button to select the shooting mode.	P.16 P.29
	The camera is in playback mode.	Press the  (Playback) button to select the shooting mode.	P.47
	The shutter release button is not pressed all the way.	Press the shutter release button all the way.	P.34 P.35
	The SD memory card is not formatted.	Format the card.	P.109
	The SD memory card is full.	Load a new card, or delete unwanted files.	P.25 P.51
	The SD memory card has reached the end of its useful life.	Load a new SD memory card.	P.25
	The flash is charging.	Wait until the auto focus/flash lamp stops blinking.	P.39
	The SD memory card is locked.	Unlock the card.	P.22
	The contact surface of the SD memory card is dirty.	Wipe with a soft, dry cloth.	-
Unable to view the shot image.	The image confirmation time is too short.	Lengthen the image confirmation time.	P.116
Images do not appear on the LCD monitor.	The camera is not on or the LCD monitor is dark.	Turn the camera on or adjust the brightness of the LCD monitor.	P.29 P.111
	The screen display is in synchro-monitor mode.	Press the DISP. button to change the display.	P.54
Although the camera is set to auto focus, it is unable to focus.	The lens or AF window is dirty.	Wipe clean with a soft, dry cloth.	P.14
	The subject is not in the center of the shooting range.	Shoot with focus lock.	P.35
	It is a hard-to-focus subject.	Shoot with focus lock or manual focus.	P.35 P.65
The picture is blurred.	You moved the camera when pressing the shutter release button.	Hold the camera with your elbows pressed against your body. Use a tripod. Use the antiblur function.	P.32 P.63
	When shooting in a dark place (such as indoors), the shutter speed slows down and pictures become easily blurred.	Use the flash. Raise the ISO setting. Use the antiblur function.	P.39 P.81 P.63

Problem	Cause	Solution	Refer to
The flash does not fire or the flash cannot charge.	The flash cannot be used in the following cases: <ul style="list-style-type: none"> In multi-shot mode In movie mode In scene modes, the flash is disabled by default.	To shoot with the flash, change the settings or mode.	P.39 P.69 P.83 P.240
	The flash is set to flash off.	Use the  (Flash) button to cancel flash off.	P.39
	Battery is running low.	Charge the rechargeable battery or use the AC adapter. Replace the alkaline batteries with new batteries.	P.24 P.27 P.25
Even though the flash fired, the picture is dark.	The distance to the subject is greater than 6.5 meters in telephoto or greater than 10 meters in wide-angle.	Get closer to your subject and shoot.	P.39
	The subject is dark.	Correct the exposure. (Exposure compensation also changes the light intensity of the flash.)	P.78
The image is too bright.	The light intensity of the flash is not appropriate.	Move a little away from the subject or illuminate the subject with another light source instead of using the flash.	P.39
	Subject is overexposed.	Correct the exposure. Cancel exposure time.	P.78 P.73
	The brightness of the LCD monitor is not appropriate.	Adjust the brightness of the LCD monitor.	P.111
The image is too dark.	The shot was taken in a dark place while set to flash off.	Use the  (Flash) button to cancel flash off.	P.39
	The subject is underexposed.	Correct the exposure. Set to long exposure time.	P.78 P.73
	The brightness of the LCD monitor is not appropriate.	Adjust the brightness of the LCD monitor.	P.111
The image lacks natural color.	The picture was shot in conditions that made it difficult for auto white balance to adjust the white balance.	Add a white object to the composition or use a white balance setting other than auto.	P.79
The date or recording information does not appear on the screen.	The screen display function is set to no display.	Press the DISP. button to change the display.	P.54
The brightness of the LCD monitor changes during AF.	You are using AF in a dark place or when the auto focus range and surrounding brightness are different.	This is normal.	-
There is a vertical smear on the image.	This is a phenomenon that occurs when a bright subject is shot. It is called the smear phenomenon.	This is normal.	-

Playback/Deleting

Problem	Cause	Solution	Refer to
Cannot play back, or the playback screen does not appear.	The camera is not in playback mode.	Press the  (Playback) button.	P.47
The contents of the SD memory card cannot be played back, or the playback screen does not appear.	No SD memory card is loaded, or an SD memory card with no stored images is loaded.	Load a card with stored images.	P.25
	You played back an SD memory card that was not formatted with this device.	Load a card that was formatted and recorded with this device.	P.25 P.109
	You played back an SD memory card that was not recorded normally.	Load a normally recorded card.	-
	The contact surface of the SD memory card is dirty.	Wipe with a soft, dry cloth.	-
	There is something wrong with the SD memory card.	Play back images from another card and if there is nothing wrong with the card, the camera is okay. There may be something wrong with the card, so do not use it.	-
The LCD monitor turned off.	Battery is running low.	Charge the rechargeable battery or use the AC adapter. Replace the alkaline batteries with new batteries.	P.24 P.27 P.25
	The camera was left unattended and unused, so auto power off turned it off.	Turn the camera back on.	P.29
A file cannot be deleted.	The file is protected.	Unprotect the file.	P.90
	The SD memory card is locked.	Unlock the card.	P.22
Cannot format the SD memory card.	The SD memory card is locked.	Unlock the card.	P.22

Other Problems

Problem	Cause	Solution	Refer to
Cannot load the SD memory card.	The card is facing the wrong way.	Load correctly.	P.25
The camera does not operate even when the buttons are pressed.	Battery is running low.	Charge the rechargeable battery or use the AC adapter. Replace the alkaline batteries with new batteries.	P.24 P.27 P.25
	Camera malfunction.	Press the power button to turn the camera off, and then press the power button to turn the camera on again.	P.29
		Remove the battery and load it again. Reconnect the AC adapter cable properly, if using.	P.25 P.27
The date is incorrect.	The correct date/time are not set.	Set the correct date/time.	P.119
The set date disappeared.	The battery was removed.	If the battery is removed for about one week, the date setting will be lost. Make the settings again.	P.119
Auto power off does not work.	Auto power off is set to [OFF].	Set the time for auto power off.	P.113
The beep sound cannot be heard.	The beep sound volume is turned off.	Use [VOL. SETTINGS] to set the volume to a setting other than mute.	P.115

Software and Computer Troubleshooting

For details about the software, refer to the “Software User Guide” (PDF file).

Warning Messages Under Windows XP Service Pack 2

When software for your Ricoh digital camera is used on a computer with Windows XP Service Pack 2 installed, the following warning message may appear at software activation or USB connection. With this in mind, refer to the following:

When this warning message is displayed:

- 1 Check the information provided on the message screen to make sure that it comes from a reputable source, and then click the [Unblock] button.

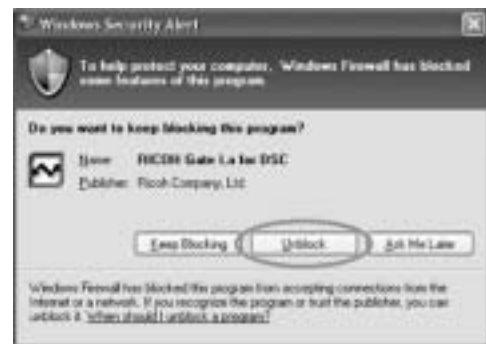

Caution

If you do not recognize the program, you should block it because it may be a virus. Click the [Keep Blocking] button to prevent the program from connecting to the Internet.

If you clicked the [Keep Blocking] button:

Follow the steps below to check the Windows Firewall settings.

- 1 Click [Start] and then [Control Panel].
- 2 Double-click [Windows Firewall].

- If [Windows Firewall] is not displayed, click [Switch to Classic View] at the top left of the window.



Windows
Firewall

- 3** Click the [Exceptions] tab.
- 4** Check that the software is in [Programs and Services].
- 5** Click the [Add Program] button to add software that uses the network.



If you clicked the [Ask Me Later] button:

Each time the program is activated, the [Windows Security Alert] dialog box appears. Then you can select [Unblock].

Specifications

General

Power Source Voltage	Rechargeable Battery DB-43 (3.7 V) × 1
	External (AC adapter): 3.8 V
	AA Dry Alkaline Battery, Nickel-Hydrogen Battery × 2
External Dimensions	133.0 mm (W) × 74.0 mm (H) × 78.5 mm (D) (excluding projecting parts)
Weight	Camera: Approximately 430 g (excluding battery, strap) Accessories: Approximately 50 g (battery, strap)
Tripod Hole Shape	1/4-20UNC
Operating Temperature Range	-10 ℃ to 40 ℃
Operating Humidity Range	85% or less
Storage Temperature Range	-20 ℃ to 60 ℃
Water Resistance	JIS protection grade 7, IEC IP67
Dust Resistance	JIS protection grade 6, IEC IP67

Camera Parts

Image Pickup Element	Total 8.30 million pixels (effective pixels 8.13 million), 1/1.8" primary-color CCD
Lens	
Lens	3.0 × Optical Zoom Aperture: F2.5 (Wide-angle) to 4.3 (Telephoto)
Focal Length	5.8 to 17.4 mm (equivalent to 28 to 85 mm on a 35mm camera)
Shooting Distance	Approximately 0.3 m to ∞ (Wide-angle) or 1.0 m to ∞ (Telephoto)
Macro Shooting Distance (from the very front of the camera)	Approximately 0.005 m to ∞ (Wide-angle), 0.1 m to ∞ (Telephoto) or 0.005 m to ∞ (Zoom macro mode)
Digital Zoom	4.0 times
Monitor Display Parts	
Screen Size	2.5"
Type	Transparent Amorphous Silicon TFT LCD
Pixel Count	Approx. 150,000
White Balance	AUTO/Fixed (OUTDOORS, CLOUDY, INCAND., INCAND.2, FLUORES., MANUAL)
Exposure Adjustment	
Light Metering Sensitivity Distribution	Multi Light Metering (256 segments), Center-weighted Light Metering, Spot Metering
Exposure Compensation	Manual exposure compensation +/-2.0EV (1/3EV Steps)
Metering Method	TTL-CCD Metering Method
Flash AE	Yes (In Daylight Synchro: On)
Shutter	Still image: 8, 4, 2, 1 to 1/2000 seconds; Movie: 1/30 to 1/2000 seconds
ISO Sensitivity	AUTO, ISO 64, ISO 100, ISO 200, ISO 400, ISO 800, ISO 1600

Distance Control	
AF Method	Normal Shooting: External Passive/CCD method Macro: CCD method
AF Measurement Range	Normal: approx. 0.3 m to ∞ , Macro: approx. 0.005 m to ∞
Internal Flash	
Method	External modulated light sensor and pre-flash method
Shooting Distance	Approx. 0.2 to 10 m (Wide-angle), Approx. 0.2 to 6.5 m (Telephoto) (ISO: AUTO)
Operating Modes	Flash Off/Auto/Red-eye reduction/Forced flash/Flash synchro
Date Maintain Time	Approx. 1 week

Image Data Record/Playback Part

Pixels	
Still Image	3264 × 2448, 2592 × 1944, 2048 × 1536, 1280 × 960, 640 × 480
Text	3264 × 2448, 2048 × 1536
Movie	320 × 240, 160 × 120
File Formats	
Still Image	JPEG (Exif Ver.2.21)
Text	TIFF (MMR Method ITU-T.6)
Movie	AVI (Open DML Motion JPEG Format Compliant)
Sound	WAV (Exif Ver.2.21 σ law)
Camera File System Standard	DCF ("Design rule for Camera File system", a JEITA standard)
Compression Format	JPEG Baseline Format Compliant (Still image, movie)
Image Size	
3264 × 2448	N: approx. 1665 KB/Screen, F: approx. 2894 KB/Screen
2592 × 1944	N: approx. 1060 KB/Screen
2048 × 1536	N: approx. 672 KB/Screen
1280 × 960	N: approx. 356 KB/Screen, F: approx. 686 KB/Screen
640 × 480	N: approx. 83 KB/Screen

I/O Terminals

DC In	3.8 V (AC adapter)
USB Terminal	USB2.0 High-Speed (mini-USB)
AUX Terminal	Proprietary specifications

Memory Cards for Recording and Playback

Memory Type	SD memory card, multi media card
-------------	----------------------------------

Bluetooth® Communication Port

Communication Method	Bluetooth® standard Ver. 2.0 + EDR
Output	Bluetooth® standard Power Class 2
Communication Range* ¹	Approx. 10 m (line of sight)
Supported Bluetooth® Profiles* ²	BIP, OPP, SPP
Frequency Band	2.4 GHz (2.4 GHz – 2.4835 GHz)

*1 The communication range may vary depending on obstructions between the two devices, signal strength, software or operating system in use, and other factors.

*2 These are specifications according to the intended use of the Bluetooth®-enabled devices and are predetermined by Bluetooth® standards.

Wireless LAN Communication Port (Only for Caplio 500SE-W)

Compliance Standard	IEEE802.11b/g
Transmission Method	IEEE802.11g: OFDM IEEE802.11b: DSSS, DQPSK, DBPSK
Data Transfer Speed* ¹	IEEE802.11g: 54M/48M/36M/24M/18M/12M/9M/6M (bps) IEEE802.11b: 11M/5.5M/2M/1M (bps)
Communication Range* ²	Approx. 30 m This varies depending on the location of the devices, usage environment, and usage conditions.
Security Protocol	WEP (64/128bit), WPA-PSK (TKIP/AES), WPA2-PSK (TKIP/AES)
Frequency Band	2.4 GHz (2.412 - 2.462 GHz)

*1 The data transfer speeds are the maximum theoretical values based on the wireless LAN standard and may differ from the actual data transfer speed.

*2 The communication range may vary depending on obstructions between the two devices, signal strength, location of the devices, usage environment, software or operating system in use, and other factors.

Number of Images That Can be Stored in Internal Memory/SD Memory Card

The following table shows the approximate number of images that can be recorded in the internal memory and onto an SD memory card at various image size and picture quality settings.

Mode	Picture Quality	Image Size	Internal Memory	32 MB	64 MB	128 MB	256 MB	512 MB	1 GB
Still Image	F	3264 × 2448	8	9	19	39	78	158	305
	N	3264 × 2448	14	16	33	68	136	275	530
	N	2592 × 1944	22	25	53	107	213	430	828
	N	2048 × 1536	36	41	84	170	339	683	1314
	F	1280 × 960	33	38	79	159	318	641	1233
	N	1280 × 960	63	72	148	301	600	1209	2324
	N	640 × 480	277	315	645	1304	2599	5237	10072
TEXT MODE		3264 × 2448	51	59	121	244	487	982	1889
		2048 × 1536	87	99	203	412	821	1654	3181
Movie	320 × 240 15FPS		1 min 17 s	1 min 27 s	2 min 59 s	6 min 3 s	12 min 4 s	24 min 19 s	46 min 47 s
	320 × 240 30FPS		39 s	44 s	1 min 31 s	3 min 4 s	6 min 7 s	12 min 19 s	23 min 42 s
	160 × 120 15FPS		4 min 38 s	5 min 16 s	10 min 47 s	21 min 49 s	43 min 29 s	87 min 37 s	168 min 30 s
	160 × 120 30FPS		2 min 26 s	2 min 46 s	5 min 40 s	11 min 27 s	22 min 50 s	46 min 1 s	88 min 31 s
Sound			56 min 45 s	64 min 36 s	132 min 11 s	267 min 15 s	532 min 36 s	1073 min 0 s	2063 min 25 s



Note

- The number of remaining shots displayed on the LCD monitor may differ from the actual number of shots, depending on the subject.
- Movie and sound recording time and the maximum number of still pictures may vary depending on the capacity of the recording destination (internal memory or SD memory card), shooting conditions, and the type and manufacturer of the SD memory card.

Optional Accessories

The Caplio 500SE can be used with the items (sold separately) listed below.

Item	Model	Remarks
Wide Conversion Lens	DW-5	Used for wider angle shooting. Conforms to the specifications for JIS Class 7 waterproof construction.
AC Adapter	AC-4d	Used for power supply from a household outlet to the camera.
Rechargeable Battery	DB-43	Rechargeable battery for use with this camera.
Battery Charger	BJ-2e	Used to charge the rechargeable battery (DB-43).
Rechargeable Battery Set	BS-3e	Includes the rechargeable battery (DB-43) and battery charger (BJ-2e).
Soft Case	SC-500	Used to store your camera.

Using a Wide Conversion Lens

A wide conversion lens (DW-5) enables shooting at a lens magnification of 0.8 times (equivalent to a 35mm camera's 22 mm zoom in wide-angle).

1 Attach the wide conversion lens to the lens of this camera.

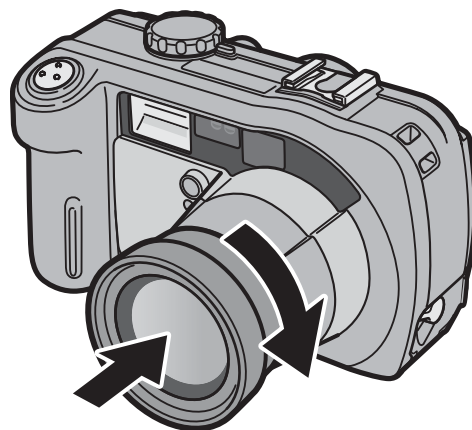

Caution

- When shooting with the lens attached, be sure to view the image on the LCD monitor of the camera. (The viewfinder does not show the actual shooting range.)
- When the wide conversion lens is attached, set the zoom position to the wide-angle end. If the shutter release button is pressed when the zoom position set to the telephoto side, the camera may not be focused.
- When the wide conversion lens is attached to the camera, even if you use the internal or external flash, the light from the flash may not sufficiently illuminate the area around the subject or the wide conversion lens may interfere with the flash, so part of the picture may appear darker.

Note

For cleaning and storage, see the documentation that came with your wide conversion lens.

Using the External Flash

You can attach an external flash and other accessories (available in stores) to the accessory shoe.

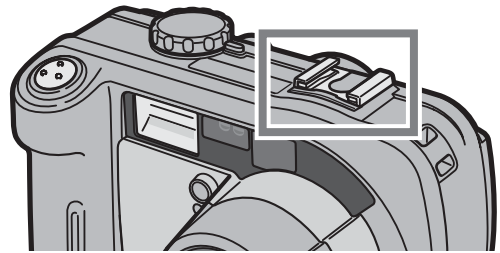

Caution

- The accessory shoe conforms to JIS B7101.
- You cannot use an external flash with no spring or lock mechanism.
- You cannot use an external flash with no mechanism for canceling the pre-flash.



Note

The accessory shoe does not support a synchronizer contact.

Functions Whose Defaults are Restored When Camera is Turned Off

Turning the camera off may reset some function settings to their defaults. The table below indicates whether or not the function is reset to its default when the camera is turned off.

O : setting is saved × : setting is restored

Menu	Function		Default Settings
SHTG STGS	PIC QUALITY/SIZE	O	N1280(1M)
	ANTIBLUR	O	OFF
	FOCUS	O	MULTI AF
	PHOTOMETRY	O	MULTI
	SHARPNESS	O	NORMAL
	CONT. MODE	×	OFF
	COLOR DEPTH	O	NORMAL
	TIME EXPOSURE	O	OFF
	INTERVAL	×	0s
	IMAGE WITH SOUND	×	OFF
	DATE IMPRINT	O	OFF
	EXPOSURE COMP.	O	0.0
	WHITE BALANCE	O	AUTO
	ISO SETTING	O	AUTO
	Macro shooting	×	Off
	Flash	O	FLASH OFF
	Self-timer	×	Off
	Maximum brightness	O	-
	DENSITY (TEXT MODE)	O	NORMAL
	SIZE (TEXT MODE)	O	2048(3M)
MOVIE SIZE (Movie Mode)	O	320	
FRAME RATE	O	30FPS	
PLBK STGS	VOL. SETTINGS	O	-
SETUP	LCD BRIGHTNESS	O	-
	ADJ BTN. SET.1	O	ANTIBLUR
	ADJ BTN. SET.2	O	OFF
	AUTO POWER OFF	O	1 MIN.
	BEEP SOUND	O	ALL
	VOL. SETTINGS	O	■ ■ □(Medium)

O : setting is saved × : setting is restored

Menu	Function		Default Settings
SETUP	LCD CONFIRM.	O	1 SEC.
	SEQUENTIAL NO.	O	OFF
	DATE SETTINGS	O	-
	LANGUAGE/言語	O	ENGLISH
	STEP ZOOM	O	OFF
	SHTG STGS WARNG.	O	ON
	USB CONNECTION	O	ORIGINAL
	ENLGE PHOTO ICON	O	OFF
	REG. MY SETTINGS	O	-
	START SETTINGS	O	OFF
	EXP SET	GPS DATUM	O
GPS DISP MODE		O	LAT/LON
GPS LOCK		O	OFF
PASS KEY		O	-
SEARCH COUNT		O	5
BT AUTO CONN		O	OFF
MASTER/SLAVE		O	SLAVE
IMAGE FILE SIZE		O	640
AUTO DEL		O	OFF
QUICK SEND MODE		O	OFF

About Scene Mode

Depending on the scene mode, the operation of functions may differ from when in normal shooting mode. Refer to the table below.

Scene Mode	Flash	Macro Shooting
HIGH SENS	Initial setting: FLASH OFF	Enabled
FIREFIGHTING	Initial setting: FLASH OFF	Enabled
SKEW COR MODE	Initial setting: FLASH OFF	Enabled
TEXT MODE	Initial setting: FLASH OFF	Enabled
ZOOM MACRO	Initial setting: FLASH OFF	Macro shooting only

Shooting Setting Menu Items by Scene Mode

Setting	HIGH SENSITIVITY	FIREFIGHTING	SKEW COR MODE	TEXT MODE	ZOOM MACRO	Refer to
PIC QUALITY/SIZE	O	O	O	-	O	P.61
ANTIBLUR	-	-	O	-	O	P.63
DENSITY	-	-	-	O	-	P.57
SIZE	-	-	-	O	O	P.61
FOCUS	O	O	O	-	O	P.64
PHOTOMETRY	-	-	O	-	O	P.67
SHARPNESS	-	-	O	-	O	P.68
CONT. MODE	-	-	-	-	O	P.69
COLOR DEPTH	-	-	O	-	O	P.72
TIME EXPOSURE	-	-	-	-	O	P.73
IMAGE WITH SOUND	O	O	O	O	O	P.76
DATE IMPRINT	O	O	O	O	O	P.77
EXPOSURE COMP.	O	O	O	-	O	P.78
WHITE BALANCE	O	O	O	-	O	P.79
ISO SETTING	-	-	O	-	O	P.81

O Available, - Not available

For details about options, see P.59.

Using Your Camera Abroad

AC Adapter (Model AC-4d), Battery Charger (Model BJ-2e)

This AC adapter can be used in regions with a current of 100-240V, 50Hz/60Hz. If you are going to travel to a country that uses a different shaped wall outlet/plug, please consult your travel agent on a plug adapter suitable for wall outlets in your country of destination.

Warranty

This product was manufactured for use in the country in which it was purchased. The warranty is only valid in the country in which the camera was purchased.

Should the product fail or malfunction while you are abroad, the manufacturer assumes no responsibility for servicing the product locally or bearing the expenditure incurred therefore.

Cautions on Use

Waterproofing

- This camera conforms to the specifications for JIS protection grade 7, IEC IP67.
- After shooting in the rain or cleaning in water, water may seep through the eyepiece of the lens segment and the tripod screw holes on the underside. This is not a problem because these sections are of double structure.
- The internal mechanisms of the camera are neither waterproof nor dustproof.
- Should water enter the inside of the camera, remove the batteries immediately and contact the Ricoh Repair Center.

Cautions on Use

- When opening and closing the camera, take care to prevent water droplets or contaminants adhering to the camera from getting inside. If possible, avoid opening or closing the camera at the beach, near the sea, or in sandy soil to prevent seawater or sand from getting inside.
- When opening and closing the battery/card cover or terminal cover, operate them with bare hands, without wearing work gloves. If the camera has contaminants (such as water, sand, or mud) adhering to it, make sure they are completely removed, and then open and close the camera in a place where it will not be exposed to dirt.
- Water droplets may get inside when the cover is opened. Wipe dry before using.
- Because of its airtight structure, variations in atmospheric pressure may make the battery/card cover or terminal cover hard to open.
- Because of its waterproof structure, the mode dial may be hard to turn when it has not been operated for a long time. If this occurs, operate the dial several times to restore it to the initial state.
- On a sandy beach or in a dusty place such as a construction site, pay sufficient attention to prevent sand or dust from adhering to the camera.
- Do not leave the camera in places where there are extremes of temperature or humidity, such as in a closed car, at the seashore, or in a bathroom.
- Before connecting the AC adaptor (optional), make sure the camera is off.
- Do not force the battery/card cover or terminal cover.
- Do not lift the camera by the battery/card cover or terminal cover.
- If water droplets get inside the camera, immediately stop using it. Turn the power off, remove the batteries, and leave all the covers and lids open. Do not use the camera with water droplets inside. Consult the dealer or the Ricoh Repair Center.

- In cold climates, if the camera has water droplets adhering to its surface, they may freeze. Using the camera with ice on it may cause it to fail. Do not leave the camera with water adhering to it.
- This product was manufactured for use in the country in which it was purchased. The warranty is only valid in the country in which the camera was purchased.
- Should the product fail or malfunction while you are abroad, the manufacturer assumes no responsibility for servicing the product locally or bearing the expenditure incurred therefore.
- Be sure not to drop or apply any sudden force to the camera.
- Firing the flash consecutively may heat the firing unit. Do not fire it consecutively more than necessary.
- Do not fire the flash near eyes. It could cause visual impairment (particularly for infants).
- Do not fire the flash near the driver of a vehicle to avoid causing accidents.
- The batteries may become hot after extended use. Touching the batteries immediately after use could result in burns to your fingers.
- If the LCD monitor or panel is exposed to sunlight, they may become washed out and images may become hard to view.
- The LCD monitor and panel may contain some pixels that do not remain lit up continually in part or at all. Also, the brightness may become uneven because of the characteristics of LCDs. These are not failures.
- While you are carrying the camera, be careful not to hit it against other objects.
- In an environment where the temperature changes suddenly, condensation may occur in the camera, resulting in troubles such as fogging of the glass surface or malfunctions of the camera. If this occurs, place the camera in a bag to slow the temperature change as much as possible. Take it out of the bag after the temperature difference from the atmosphere has decreased to a fairly small amount.
- To avoid damaging the connectors, do not put any objects into the camera's microphone or speaker holes.



Conditions in which condensation may easily occur:-----

- When the camera is moved to an environment where the temperature differs greatly.
- In humid places.
- In a room immediately after being heated, or when the camera is exposed directly to cooled air from an air-conditioner or another similar appliance.

Care and Storage

Care

- Please note that if fingerprints, dirt, etc. get onto the lens, picture quality will suffer.
- When dust or dirt does get on the lens, do not touch it directly with your fingers, and either use a blower (available in stores) to blow it off, or a soft cloth to gently dust it off.
- If the camera has gotten dirty or after use at the beach or around chemicals, take the following steps: Make sure the battery/card cover and terminal cover are securely closed. Then, clean the camera in tap water in a vessel such as a bucket. Remove sand and salt from the camera. Finally, wipe water off its surface using a soft cloth.
- If the rubber packing has gotten dirty, wipe dirt off its surface using a soft cloth. If the dirt cannot be removed, request the dealer or the Ricoh Repair Center to replace the packing.
- In the unlikely event that your camera fails to work properly, please consult your Ricoh Repair Center.
- There are high voltage circuits in this camera. As this is dangerous, do not dismantle this camera under any circumstances.
- Do not get volatile substances, such as thinner, benzene, or pesticides on your camera. This may cause a change in quality, paint to peel, etc.
- As the surface of the LCD monitor is easily scratched, do not rub hard objects against it.
- Clean the surface of the LCD monitor by wiping gently with a soft cloth containing a small amount of display cleaner sold in stores.

Use and Storage

- Please avoid using or storing your camera in the following kinds of places, as this may damage the camera.

Places with severe vibration.

Places where it is in direct contact with vinyl or rubber products or chemicals, including mothballs or other insect repellent, for long periods of time.

Places with strong magnetic fields (near a monitor, transformer, magnet, etc.).

Avoid using or storing your camera with the battery/card cover or terminal cover open in the following places.

In high heat and humidity, or where there is severe change in temperature or humidity.

Places with a lot of dust, dirt or sand.

Places where it is exposed to water.

- Remove the batteries if you are not going to use the camera for a long period of time.

Replacing the rubber packing

- To maintain the waterproof ability, replace the rubber packing every two years, regardless of whether it has gotten dirty.
If you use the camera frequently in a wet, sandy, or dusty environment, we recommend replacing the packing every year.
The replacement will be performed by the Ricoh Repair Center on a chargeable basis.

Precautions regarding care of your camera

1. Be sure to turn the power off.
2. Remove the batteries or AC adapter before caring for your camera.

Warranty and Servicing

1. This product is backed by a limited warranty. During the warranty period mentioned in the Warranty supplied with your camera, any defective parts will be repaired free of charge. In the event of a camera malfunction, contact the dealer from which you purchased the camera or your nearest Ricoh Repair Center. Please note that you will not be reimbursed for the cost of bringing the camera to the Ricoh Repair Center.
2. This warranty does not cover any damage resulting from:
 - ① failure to follow the instructions in the instruction manual;
 - ② repair, modification or overhaul not conducted by an authorized service center listed in the instruction manual;
 - ③ fire, natural disaster, act of God, lightning, abnormal voltage, etc;
 - ④ improper storage (noted in the "Camera User Guide"), leaking of battery and other fluids, mold, strong shock, dropping, pressure, or otherwise insufficient care of the camera;
 - ⑤ Dropping the camera or exposing it to water, mud, sand, pressure, etc. with the battery/card cover or terminal cover open.
3. After the warranty period has passed, you will be liable for all repair fees, including those incurred at an authorized service center.
4. You will be liable for all repair fees, even within the warranty period, if the warranty card is not attached or if the distributor's name or the purchase date have been changed or are not indicated on the card.
5. Expenses for overhaul and thorough inspection by special request of the customer will be charged to the customer, whether or not they are incurred during the warranty period.
6. This warranty only applies to the camera and not to the accessories, such as the case and strap, nor does it apply to the battery and other consumables provided.
7. Any consequential damages arising from failure of the camera, such as expenses incurred in taking pictures or loss of expected profit, will not be reimbursed whether they occur during the warranty period or not.
8. The warranty is only valid in the country in which the camera was purchased.
 - * The above provisions refer to repairs offered free of charge, and do not limit your legal rights.
 - * The intention of the above provisions is also described in the warranty card provided with this camera.
9. Parts essential to the servicing of the camera (that is, components required to maintain the functions and quality of the camera) will be available for a period of five years after the camera is discontinued.
10. Please note that if the camera is seriously damaged by flooding, submergence, infiltration of sand or mud, violent shocks or dropping, it may not be repairable, and restoration to its original condition may be impossible.



Note

- Before sending the camera in for repair, check the battery and read the instruction manual again to ensure proper operation.
- Some repairs require a significant amount of time to be completed.
- When sending the camera to a service center, please include a note which describes the defective part and the problem as precisely as possible.
- Remove all accessories not related to the problem before sending the camera to the service center.
- Before taking any important pictures (such as at weddings, on trips abroad, etc.), test the camera to check operation and ensure proper functioning. We recommend that you keep this manual and spare battery on hand.
- This warranty does not apply to data stored on an SD memory card or in internal memory.

Notes to users

This Transmitter must not be co-located or operated in conjunction with any other antenna or transmitter.

(Caplio 500SE-B)

This equipment complies with FCC/IC radiation exposure limits set forth for uncontrolled equipment and meets the FCC radio frequency (RF) Exposure Guidelines in Supplement C to OET65 and RSS-102 of the IC radio frequency (RF) Exposure rules. This equipment has very low levels of RF energy that it is deemed to comply without testing of specific absorption ratio (SAR).

(Caplio 500SE-W)

The available scientific evidence does not show that any health problems are associated with using low power wireless devices. There is no proof, however, that these low power wireless devices are absolutely safe. Low power Wireless devices emit low levels of radio frequency energy (RF) in the microwave range while being used. Whereas high levels of RF can produce health effects (by heating tissue), exposure to low-level RF that does not produce heating effects causes no known adverse health effects. Many studies of low-level RF exposures have not found any biological effects. Some studies have suggested that some biological effects might occur, but such findings have not been confirmed by additional research. Caplio 500SE-W has been tested and found to comply with FCC/IC radiation exposure limits set forth for an uncontrolled equipment and meets the FCC radio frequency (RF) Exposure Guidelines in Supplement C to OET65 and RSS-102 of the IC radio frequency (RF) Exposure rules. Please refer to the SAR test report that was uploaded at FCC website.

Note to users in the United States of America

NOTICE

This equipment has been tested and found to comply with the limits for a Class B digital device, pursuant to part 15 of the FCC Rules. These limits are designed to provide reasonable protection against harmful interference in a residential installation.

This equipment generates, uses and can radiate radio frequency energy and, if not installed and used in accordance with the instructions, may cause harmful interference to radio communications. However, there is no guarantee that interference will not occur in a particular installation. If this equipment does cause harmful interference to radio or television reception, which can be determined by turning the equipment off and on, the user is encouraged to try to correct the interference by one or more of the following measures:

- Reorient or relocate the receiving antenna
- Increase the separation between the equipment and receiver.
- Connect the equipment into an outlet on a circuit different from that to which the receiver is connected.
- Consult the dealer or an experienced radio/TV technician for help.

FCC WARNING

Changes or modifications not expressly approved by the party responsible for compliance could void the user's authority to operate the equipment.

Properly shielded and grounded cables and connectors must be used for connection to host computer and/or peripherals in order to meet FCC emission limits.

An AC adaptor with ferrite core must be used for RF interference suppression.

Product Name: DIGITAL CAMERA

Model Number: Caplio 500SE-B/Caplio 500SE-W

This device complies with Part 15 of FCC Rules. Operation is subject to the following two conditions:

- (1) this device may not cause interference, and
- (2) this device must accept any interference, including interference that may cause undesired operation of this device.

RICOH CORPORATION

5 Dedrick Place, West Caldwell NJ, 07006 Tel.: 1-800-225-1899

Note to users in Canada

This class B digital apparatus complies with Canadian ICES-003.

This device complies with RSS-Gen of IC Rules. Operation is subject to the following two conditions:

- (1) this device may not cause interference, and
- (2) this device must accept any interference, including interference that may cause undesired operation of this device.

Remarque concernant les utilisateurs au Canada

Cet appareil numérique de la Classe B est conforme à la norme NMB-003 du Canada.

Ce dispositif est conforme à la norme CNR-210 d'Industrie Canada.

L'utilisation de ce dispositif est autorisée seulement aux conditions suivantes:

- (1) il ne doit pas produire de brouillage et
- (2) l'utilisateur du dispositif doit être prêt à accepter tout brouillage radioélectrique reçu, même si ce brouillage est susceptible de compromettre le fonctionnement du dispositif.

Notice to Users in EEA Countries

Caplio 500SE-B



Declaration of Conformity
"The Product complies with the requirements of the EMC
Directive 89/336/EEC."

This product complies with the essential requirements and provisions of Directive 1999/5/EC of the European Parliament and of the Council of 9 March 1999 on radio equipment and telecommunications terminal equipment and the mutual recognition of their conformity.

The CE Declaration of Conformity is available on the Internet at URL:
http://www.ricoh.com/r_dc/support/ce_docs/

Caplio 500SE-W



Declaration of Conformity
"The Product complies with the requirements of the EMC
Directive 89/336/EEC."

This product complies with the essential requirements and provisions of Directive 1999/5/EC of the European Parliament and of the Council of 9 March 1999 on radio equipment and telecommunications terminal equipment and the mutual recognition of their conformity.

The CE Declaration of Conformity is available on the Internet at URL:
http://www.ricoh.com/r_dc/support/ce_docs/

This equipment may be operated in GB,DE.

Hinweis für Benutzer in Ländern des europäischen Wirtschaftsraumes

Dieses Produkt befindet sich in Übereinstimmung mit den grundlegenden Anforderungen und den übrigen einschlägigen Bestimmungen der Richtlinie 1999/5/EG des Europäischen Parlaments und des Rates vom 9. März 1999 über Funkanlagen und Telekommunikationsendeinrichtungen und die gegenseitige Anerkennung ihrer Konformität.

Unter der folgenden URL finden Sie die offizielle Konformitätserklärung:
http://www.ricoh.com/r_dc/support/ce_docs

(Caplio 500SE-W)

Diese Gerät darf in GB und DE verwendet werden.

Index

A

AA Alkaline Batteries 20, 25
AC Adapter 13, 27
Accessory Shoe 14, 237
Acrobat Reader 132, 138
ADJ BTN. SET.1/2 112
ADJ./MEMO Button ... 15, 56, 85, 87
AF Auxiliary Light 14, 45
AF target shift 58
AF Window 14
ANTIBLUR..... 63
Authentication passkey 162, 175
AUTO DEL 179
Auto Focus (AF) 64
Auto Focus/Flash Lamp .. 15, 35, 39
AUTO POWER OFF 29, 113
AUX Terminal 14
AVI file 83

B

Backlighting 78
BARCODE MODE 155
Battery 20
Battery Charger 13, 24
Battery Level Indication 19
Battery/Card Cover..... 15, 25, 27
BEEP SOUND 114
BIP (Basic Imaging Profile) 154
Bluetooth® 154
BT AUTO CONN 183
BT SERIAL 181

C

CALS Mode 16, 44
Camera Memo..... 105
Camera shake 33
Caplio Mounter 142
Caplio Server..... 199
Caplio Setting 194
Caplio Software CD-ROM
..... 13, 129, 142

Card Reader 153
CHANGE COM 193
Charging 24
COLOR DEPTH 72
Communication List 202
COPY TO CARD..... 97

D

DATE IMPRINT 77
DATE SETTINGS 31, 119
Delete..... 51
Delete/Self-timer Button... 15, 45, 51
DENSITY 57
DeskTopBinder Lite 131, 136
Digital Zoom 37
Direct Print 98
DirectX 132, 139
DISP. Button 15, 54
DPOF 93

E

Enlarged View..... 50
ENLGE PHOTO ICON 125
Error Messages..... 221
Expanded Settings Menu..... 155
EXPOSURE COMP. 78
External Flash 237

F

FILE SEND 166, 209
FIREFIGHTING..... 40
Flash 14, 39
Flash Button..... 15, 39
Flash Compensation 14
FOCUS 64
Focus Lock..... 35
FORMAT [CARD]..... 109
FORMAT [INT. MEM.]..... 110
FRAME RATE..... 84
Full-press 34

G

GPS 180
GPS DATUM..... 188
GPS DISP MODE 189
GPS LOCK..... 190

Grid Guide 54

H

Half-press 35

HIGH SENS..... 40

I

IMAGE FILE SIZE 178

IMAGE WITH SOUND..... 76

ImageMixer..... 130, 132, 141

Internal Memory 22, 47

INTERVAL..... 74

ISO SETTING..... 81

L

LANGUAGE/言語 30, 120

LCD BRIGHTNESS 111

LCD CONFIRM. 116

LCD Monitor 15, 17

Lens..... 14

List Editor 130

M

M (Memory-reversal)-CONT 69

Macro Button 15, 38

Manual Focus (MF) 65

Mass Storage Mode (MASS STR)
..... 123, 151

MASTER/SLAVE 177

MENU/OK Button
..... 15, 60, 88, 107, 155

Microphone..... 15

Mode Dial 14, 16

Movie Mode..... 16, 83

MOVIE SIZE..... 61

N

Neck Strap..... 12

Nickel-Hydrogen Battery 20

Number of images that can be
stored 235

Number of shots you can take..... 21

O

OPP (Object Push Profile)..... 154

P

PASS KEY 175

PHOTOMETRY..... 67

PIC QUALITY/SIZE..... 61

PictBridge..... 98

Playback Button..... 15, 47

Playback Mode 29, 47

Playback Setting menu 88

Power Button 15

PRINT 157

Printing..... 98

PROTECT..... 90

Q

Quick Review Button..... 15, 46

Quick Review Send..... 171, 214

QUICK SEND MODE..... 171, 214

R

READ COM SETTING 155, 205

Rechargeable Battery
..... 13, 20, 24, 25

REG. MY SETTINGS..... 126

REPORT PRINT 104

RESIZE 96

RESTORE DEFAULTS..... 82

RICOH Gate La..... 130, 142, 150

S

S (Stream)-CONT 69

SCAN TIME 155

SCENE Button 15, 41

Scene Mode..... 40

SD Memory Card 22, 25, 47

SEARCH COUNT 176

Self-Timer 45

SEND CONDITION..... 155, 219

SEND TO..... 155, 220

SEQUENTIAL NO..... 117

SETUP menu 106

SHARPNESS..... 68

Shooting Setting Menu..... 59

SHTG STGS WARNG. 122

Shutter Release Button..... 14, 32

SKEW COR MODE..... 40, 42

SLIDE SHOW	89
Speaker	15
SPP (Serial Port Profile).....	154
START SETTINGS.....	127
STEP ZOOM	121
Still Image Mode.....	16, 34
Synchro-Monitor Mode	54

T

Telephoto/Enlarged View Button	15, 37, 49
Terminal Cover.....	14, 99, 149
TEXT MODE	40
Three-frame View	48
Thumbnail Display.....	48
TIME EXPOSURE.....	73
Tripod Screw Hole.....	15

U

USB Cable.....	12, 98
USB CONNECTION.....	123
USB Driver	130, 131, 142
USB Terminal	14, 99, 149

V

Viewfinder.....	14, 15
Voice Memo Mode	16, 86
VOL. SETTINGS	115

W

WAV file.....	86
WHITE BALANCE	79
WIA Driver.....	130, 131
Wide Conversion Lens	13, 236
Wide-angle/Thumbnail Display Button.....	15, 37, 48
Wireless LAN.....	191

Z

Zoom	37
ZOOM MACRO	40, 43

From environmental friendliness to environmental conservation and to environmental management

Ricoh is aggressively promoting environment-friendly activities and also environment conservation activities to solve the great subject of management as one of the citizens on our precious earth.



To reduce the environmental loads of digital cameras, Ricoh is also trying to solve the great subjects of "Saving energy by reducing power consumption" and "Reducing environment-affecting chemical substances contained in products".

If a problem arises

First of all, see "Troubleshooting" (👉 P.221) in this manual. If the issues still persist, please contact a Ricoh office.

Ricoh Offices	
Ricoh Company, Ltd.	3-2-3, Shin-Yokohama Kouhoku-ku, Yokohama City, Kanagawa 222-8530, Japan http://www.ricoh.co.jp/r_dc
Ricoh Corporation	5 Dedrick Place, West Caldwell, New Jersey 07006, U.S.A. 1-800-22RICOH http://www.ricoh-usa.com
RICOH EUROPE B.V. (EPMCC)	(innerhalb Deutschlands) 06331 268 438 (außerhalb Deutschlands) +49 6331 268 438 http://www.ricohpmcc.com
RICOH UK LTD. (PMMC UK)	(from within the UK) 02073 656 580 (from outside of the UK) +44 2073 656 580
RICOH FRANCE S.A.S. (PMMC FRANCE)	(à partir de la France) 0800 91 4897 (en dehors de la France) +49 6331 268 409
RICOH ESPANA, S.A. (PMMC SPAIN)	(desde España) 91 406 9148 (desde fuera de España) +34 91 406 9148
Ricoh Italia S.p.A. (PMMC ITALY)	(dall'Italia) 02 696 33 451 (dall'estero) +39 02 696 33 451
RICOH HONG KONG LIMITED Personal Multimedia Products Center	21/F., Tai Yau Building, 181 Johnston Road, Wan Chai, Hong Kong
Ricoh Australia Pty. Ltd.	8 Rodborough Road, Frenchs Forest, NSW 2086, Australia http://www.ricoh.com.au
About ImageMixer	
	North America (Los Angeles): TEL: +1-213-341-0163 Europe (U.K.): TEL: +44-1489-564-764 Asia (Philippines): TEL: +63-2-438-0090 China: TEL: +86-21-5450-0391 Business hours: 9:00 AM to 5:00 PM

Ricoh Company, Ltd.
Ricoh Building, 8-13-1, Ginza, Chuo-ku, Tokyo
104-8222, Japan
2006 December

En EN **USA** GB **GB** AE **AE**

Printed in China



* L 7 3 6 2 9 7 2 A *

Free Manuals Download Website

<http://myh66.com>

<http://usermanuals.us>

<http://www.somanuals.com>

<http://www.4manuals.cc>

<http://www.manual-lib.com>

<http://www.404manual.com>

<http://www.luxmanual.com>

<http://aubethermostatmanual.com>

Golf course search by state

<http://golfingnear.com>

Email search by domain

<http://emailbydomain.com>

Auto manuals search

<http://auto.somanuals.com>

TV manuals search

<http://tv.somanuals.com>