

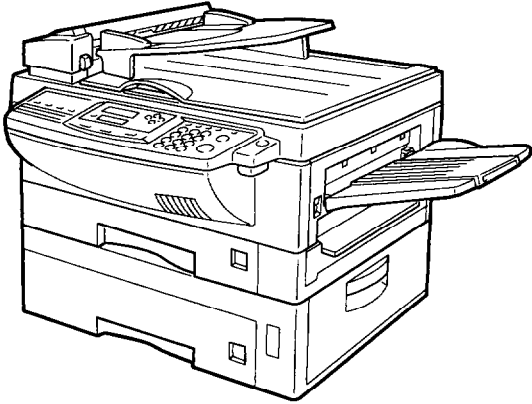

---

## MV310E Multi-Function Fax



<i>Faxing</i>	<i>page 1</i>
<i>Copying</i>	<i>page 63</i>
<i>Installation</i>	<i>page 135</i>
<i>Adding paper</i>	<i>page 80</i>
<i>Adding toner</i>	<i>page 86</i>
<i>Finding parts and keys</i>	<i>page 118</i>
<i>Troubleshooting</i>	<i>page 99</i>

*Read the safety instructions on page i to iv*

---

## Operator's Manual

## **Optional equipment**

### **FAX EXPANSION CARD TYPE 10**

A 1-Mbyte memory card can be added.

### **FAX EXPANSION CARD TYPE 20**

A 2-Mbyte memory card can be added.

### **FAX EXPANSION CARD TYPE 40**

A 4-Mbyte memory card can be added.

### **PC Printer Interface Kit (PRINTER INTERFACE TYPE 200)**

This allows you to use the machine as a laser printer for an IBM<sup>1</sup> or compatible personal computer.

### **Telephone Handset (HANDSET TYPE 100)**

This permits voice communication (over the PSTN).

### **PAPER CASSETTE TYPE 100**

This gives this machine additional 100 sheet paper capacity with single sheet bypass.

### **EXTRA PAPER FEED UNITS**

Paper feed units can be added to the base machine:

PAPER FEED UNIT TYPE 140S II

### **COUNTER TYPE 100**

### **PC-FAX EXPANDER TYPE 100**

This allows use of this machine as a scanner, PC Fax.

### <sup>1</sup>Copyright Notice

IBM is a registered trademark of International Business Machines Corporation.

**WARNING**

This equipment has been tested and found to comply with the limits for a Class A digital device, pursuant to Part 15 of the FCC Rules. These limits are designed to provide reasonable protection against harmful interference when the equipment is operated in a commercial environment. This equipment generates, uses, and can radiate radio frequency energy and, if not installed and used in accordance with the instruction manual, may cause harmful interference to radio communications. Operation of this equipment in a residential area is likely to cause harmful interference in which case the user will be required to correct the interference at his own expense.

**Caution**

Use of control or adjustments or performance of procedures other than those specified herein may result in hazardous radiation exposure

Shielded interconnect cables must be employed with this equipment to ensure compliance with the pertinent RF emission limits governing this device.

**Operator Safety**

This equipment is considered a CDRH Class 1 laser device, safe for office/EDP use. The machine contains a 5-milliwatt, 760 to 800 nanometer wavelength, GaAlAs laser diode. Direct (or indirect reflected) eye contact with the laser beam may cause serious eye damage. Safety precautions and interlock mechanisms have been designed to prevent any possible laser beam exposure to the operator.

**Laser Safety**

The Center for Devices and Radiological Health (CDRH) prohibits the repair of laser-based optical units in the field. The optical housing unit can only be repaired in a factory or at a location with the requisite equipment. The laser subsystem is replaceable in the field by a qualified Customer Engineer. The laser chassis is not repairable in the field. Customer engineers are therefore directed to return all chassis and laser subsystems to the factory or service depot when replacement of the optical subsystem is required.

In accordance with ISO 7001, this machine uses the following symbols for the main switch:

- ⏻ means POWER ON
- ⏻ means POWER OFF

**WARNING**

This symbol is attached to some components to alert the user not to touch them because they may be very hot.



This symbol is intended to alert the user to the presence of important operating and maintenance (servicing) instructions in the literature accompanying the machine.

**Notice about the Telephone Consumer Protection Act (Valid in USA only).**

The Telephone Consumer Protection Act of 1991 among other things makes it unlawful for any person to send any message via a telephone fax machine unless such message clearly contains in a margin at the top or bottom of each transmitted page or on the first page of the transmission, the date and time it is sent and an identification of the business or other entity, or other individual sending the message and the telephone number of the sending machine or such business, other entity or individual. This information is transmitted with your document by the TTI (Transmit Terminal Identification) feature.

In order for you to meet the requirement, your machine must be programmed by following the instructions in the accompanying Operation Manual. In particular, please refer to Appendix A: Installation. Also refer to the TTI (Transmit Terminal Identification) programming procedure to enter the business identification and telephone number of the terminal or business. Do not forget to set the date and time.

Thank you.

**ENERGY SAVING INFORMATION**

As an Energy Star Partner, we have determined that this fax model meets Energy Star guidelines for energy efficiency.

This product was designed to reduce the environmental impact associated with fax equipment. This is accomplished by means of energy saving features such as Low Power (saving energy) mode and Night Timer. Please see applicable sections of operating manual for details.



## Important Safety Instructions

All safety messages in the main text of this manual are labeled **WARNING** or **CAUTION**. These mean the following:

**WARNING:** Important information to alert you to a situation that might cause serious injury and damage to your property if instructions are not followed properly.

**CAUTION:** Important information that tells how to prevent damage to your equipment or how to avoid a situation that might cause minor injury.

In addition to the warnings and cautions included in the text of this manual, please read and observe the following safety instructions.

- 1 Read all of these instructions.
- 2 Save these instructions for later use.
- 3 Follow all warnings and cautions marked on the product.
- 4 Unplug this product from the wall outlet before cleaning. Do not use liquid cleaners or aerosol cleaners. Use a damp cloth for cleaning.
- 5 Do not use this product near water.
- 6 Do not place this product on an unstable cart, stand, or table. The product may fall, causing serious damage to the product or injuring the user.
- 7 Slots and openings in the cabinet and the back or bottom are provided for ventilation; to ensure reliable operation of the product and to protect it from overheating, these openings must not be blocked or covered. The openings should never be blocked by placing the product on a bed, sofa, rug, or other similar surface. This product should not be placed in a built-in installation unless proper ventilation is provided.
- 8 This product should be operated from the type of power source indicated on the marking label. If you are not sure of the type of power available, consult an authorized sales person or your local power company.
- 9 This product is equipped with a 3-wire grounding type plug, a plug having a third (grounding) pin. This plug will only fit into a grounding-type power outlet. This is a safety feature. If you are unable to insert the plug into the outlet, contact your electrician to replace your obsolete outlet. Do not defeat the purpose of the grounding type plug. (This does not apply in countries in which the 2-wire, non-grounded type of plug is used.)

10. Do not allow anything to rest on the power cord. Do not locate this product where persons will walk on the cord.
11. If an extension cord is used with this product, make sure that the total of the ampere ratings on the products plugged into the extension cord does not exceed the extension cord ampere rating. Also, make sure that the total of all products plugged into the wall outlet does not exceed 15 amperes.
12. Never push objects of any kind into this product through cabinet slots as they may touch dangerous voltage points or short out parts that could result in a risk of fire or electric shock. Never spill liquid of any kind on the product.
13. Do not attempt to service this product yourself, as opening or removing covers may expose you to dangerous voltage points or other risks. Refer all servicing to qualified service personnel.

## **When to Call Your Service Representative**

**WARNING:** Do not attempt any maintenance or troubleshooting other than that mentioned in this manual. This machine contains a laser beam generator and direct exposure to laser beams can cause permanent eye damage.

Unplug this product from the wall outlet and refer servicing to qualified service personnel under the following conditions:

- A. When the power cord or plug is damaged or frayed.
- B. If liquid has been spilled into the product.
- C. If the product has been exposed to rain or water.
- D. If the product does not operate normally when the operating instructions are followed. Adjust only those controls that are covered by the operating instructions since improper adjustment of other controls may result in damage and will often require extensive work by a qualified technician to restore the product to normal operation.
- E. If the product has been dropped or the cabinet has been damaged.
- F. If the product exhibits a distinct change in performance, indicating a need for service.

## Power and Grounding

### Power Supply

1. Power requirements: 115 V, 60 Hz
2. Insert the power plug securely into the wall socket.
3. Make sure that the wall outlet is near the machine and readily accessible.
4. Do not connect other equipment to the same socket.
5. Do not step on or set anything on the power cord.
6. Do not connect other equipment to the same extension cord.
7. Be sure that the power cord is not in a position where it would trip someone.
8. The wall outlet must be easily accessible.

### Grounding

Ground the machine and the lightning protection circuit in accordance with regulations. Do not ground to gas or water pipes, or to a telephone ground plug. Proper grounding is to the ground terminal of the power outlet. Be sure that the ground terminal of the power outlet is properly grounded.

The lightning protection circuit for the machine requires the machine to be properly grounded. If proper grounding is provided, about 90% of lightning damage can be prevented. For safety, be sure to connect the machine to a three-prong grounded outlet.

### Cold Weather Power-up

Avoid raising the room temperature abruptly when it is below 57°F, or condensation may form inside the machine.

1. Raise the room temperature to 68°F at less than 18°F per hour.
2. Wait for 30 to 60 minutes.
3. Turn the power on.
4. Do not use the machine near a humidifier.

## Thunderstorms

With proper grounding, about 90% of lightning damage can be prevented. However, if possible, during severe electric storms turn the power switch off and disconnect the power cord and telephone line cord.

**Caution:** All fax messages stored in the memory may be erased if power is switched off for more than an hour.

## GENERAL

1. Since some parts of the machine are supplied with high voltage, make sure that you do not attempt any repairs or attempt to access any part of the machine except those described in this manual.
2. Do not make modifications or replacements other than those mentioned in this manual.
3. When not using the machine for a long period, disconnect the power cord.

### Ozone

The machine generates ozone during operation. Normally, the ozone level is safe for operators. However, during a long copy run or while printing a long message, ozone odor may appear; in such a case, ventilate the room.

## Symbols & Conventions Used In This Manual

**Documents:** A document is anything you put on the feed table of your machine (or on the exposure glass) whether you are faxing it or copying it.

**Prints:** A print is anything that comes out of the machine: a fax message you received, a copy you made, or a printout from your computer.

**Procedures:** Procedures are described step by step. Perform them in order. When you see an LCD display, it always shows what comes after performing the step it accompanies. Other illustrations accompanying steps help you find the right key or handle, or show you how to perform the step.

**1** This is a step in a procedure.

THIS CORRESPONDS TO  
THE LCD DISPLAY.



## TABLE OF CONTENTS

<b>SAFETY</b> .....	<b>i</b>
Important Safety Instructions .....	i
When to Call Your Service Representative.....	ii
Power and Grounding .....	iii
Cold Weather Power-up.....	iii
Thunderstorms .....	iv
Symbols & Conventions Used In This Manual .....	iv
What Does a Fax Machine Do? .....	viii
Telephone Line Problems Affect Fax Communication .....	viii
<b>FAXING</b> .....	<b>1</b>
Recommended Types of Document .....	2
How to Set the Document .....	4
Memory Transmission and Immediate Transmission .....	5
Receiving Calls & Fax Messages(Faxes/Phone Calls) .....	14
Printing a Message Received & Stored (Substitute Reception) .....	16
Faxing a Page With Very Fine Detail .....	17
Optional Feature for Transmission.....	20
Sending the Same Message to Many Destinations .....	23
Using the Stamp .....	25
Redialing .....	26
Storing & Editing Fax Numbers (Functions 31 & 32).....	28
Storing & Editing a Group of Fax Numbers (Function 33).....	37
Erasing Groups .....	40
Erasing a Stored Message Before It Is Sent (Functions 21 & 22).....	42
Printing a Stored Message (Function 51) .....	43
Polling Reception (Function 11) .....	44
Talking Before Sending a Fax(On Hook Dial).....	46
Sending a Fax using the Handset .....	46
<b>OTHER FEATURES</b> .....	<b>47</b>
Verifying Communications, Errors, Counters, etc.....	47
Rejecting Messages From Certain Senders.....	52
Saving Energy .....	57
Printing the Sender's Identification .....	61
Tonal Signals.....	61
Things a Service Technician Can Change.....	62
<b>COPYING</b> .....	<b>63</b>
Basic Copying Procedure .....	63
Functions That Can Be Used Together .....	65
Selecting the Paper Size.....	66

Copying/Printing Using the Bypass .....	67
Enlarging & Reducing .....	70
Copying Darker or Lighter Originals .....	71
Copying Photographs .....	73
Clearing the Previously Used Settings .....	73
Options .....	74
<b>MAINTAINING YOUR MACHINE .....</b>	<b>80</b>
Setting / Adding the Paper (  ) .....	80
Replace Toner Cassette & Cleaning Pad .....	86
Replacing the Photoconductor Drum .....	89
Replacing the Stamp .....	93
Daily Maintenance .....	94
<b>Troubleshooting .....</b>	<b>100</b>
If an Indicator Lights Up on the Operation Panel .....	100
Other Possible Problems .....	100
Clearing a Document Jam .....	101
Copy, Fax, or Print Jams .....	102
Communication problems .....	108
RDS (Remote Diagnostic System) .....	109
Operational Difficulties .....	110
Displayed Error Messages .....	114
Error Codes .....	115
<b>TECHNICAL REFERENCE .....</b>	<b>118</b>
Operation panel .....	118
Machine Exterior .....	120
Access Code for Functions 61 to 94 .....	121
User Parameters (function 63) .....	121
Copier Settings (Function 72) .....	127
Adjusting the Volume of Various Features .....	128
Selecting the Display's Language .....	129
Counters (Function 94, see page 52. ) .....	129
Entering Characters .....	130
Document & Paper Specifications .....	131
Capabilities .....	132
Specifications .....	133
<b>APPENDIX A: INSTALLATION .....</b>	<b>135</b>
Machine Environment .....	135
Removing the Clip on the Upper Unit .....	137
Installing the Photoconductor, Toner Cassette and Cleaning Pad .....	138
Attaching the Print Tray .....	141
Attaching the Auto Document Table .....	141

Attaching the Stop.....	141
Setting the Paper .....	141
Installing the Optional Memory Card .....	142
Connecting the Machine .....	143
Connecting to the Phone Lines.....	143
Connecting the Power .....	145
Initial Settings & Adjustments.....	146
<b>APPENDIX B: OPTIONAL SIDE CASSETTE .....</b>	<b>152</b>
Installing the Side Cassette .....	152
Installing the Extension .....	155
<b>INDEX &amp; GLOSSARY .....</b>	<b>156</b>
.....	156
Mini-Glossary .....	159
<b>Certification Label .....</b>	<b>160</b>

Thank you for purchasing this product. This multi-function office machine offers a wide range of fax, copier, printer, and convenience features.

## **What Does a Fax Machine Do?**

When you write a letter, you normally seal it in an envelope, attach a stamp, and post it in the nearest mail box. Then, in a few days, depending on the postal service, the letter will arrive at its destination. However, you may not be aware of its arrival until you get a return letter.

A fax machine speeds up this process. After you have written your letter, place it in your fax machine's document feeder or on the exposure glass, dial the destination's fax number, then press the Start key.

The fax machine scans your letter, and converts it into a series of black and white dots (the number of dots that there are across and down the page depends on the resolution that you selected; refer to the specifications section of this manual for details). This series of dots is transformed into an electrical signal and sent out over the telephone line to the destination fax machine.

The receiving fax machine reconstructs your letter from the incoming signal, and prints it.

If you are worried about whether the message arrived at the destination, you can check a report called the TCR (Transaction Confirmation Report). When you print this report, you will see the results of the most recent fax communications made by your machine.

You can use your fax machine to send and receive many types of documents, even photographs.

## **Telephone Line Problems Affect Fax Communication**

Quick and accurate transmission of fax messages depends on the condition of the telephone line. If the line condition is very good, this machine will transmit a letter-size page in about 6 seconds. However, if the line is noisy, the speed may be reduced significantly, and the data may be damaged.

The symptoms of data loss caused by a noisy telephone line are seen on the printouts of received messages. An example is shown opposite. Note that lines are missing from the page at the indicated locations. ECM (Error Correction Mode) is an effective countermeasure against this type of error; you have the choice of having the ECM feature switched on or off. It is switched on before the machine leaves the factory. (Refer to page 62 for more information about ECM).

The line condition is affected by the weather; thunderstorms can cause electrical noise on telephone lines. In addition, the quality and condition of switching equipment used by your phone company can affect fax communication.

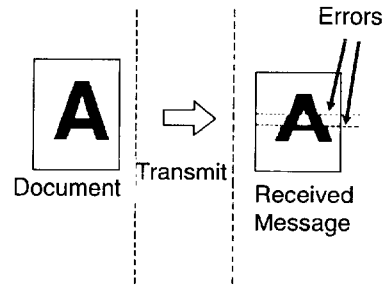



If you have not yet installed your fax machine, do so now. See Appendix A, Installation, on page 135.

This section covers what you'll most often need to do:

Recommended Types of Document .....	2
How to Set the Document .....	4
Memory Transmission and Immediate Transmission .....	5
Receiving Calls & Fax Messages(Faxes/Phone Calls) .....	14
Printing a Message Received & Stored (Substitute Reception) .....	16
Faxing a Page With Very Fine Detail .....	17
Optional Feature for Transmission.....	20
Sending the Same Message to Many Destinations .....	23
Using the Stamp .....	25
Radiating .....	26
Storing & Editing Fax Numbers (Functions 31 & 32).....	28
Storing & Editing a Group of Fax Numbers (Function 33).....	37
Erasing a Stored Message Before It Is Sent (Functions 21 & 22).....	42
Printing a Stored Message (Function 51) .....	43
Polling Reception (Function 11) .....	44
Talking Before Sending a Fax(On Hook Dial).....	46
Sending a Fax using the Handset .....	46

## A Few Hints...

Press **Clear** to erase the last letter or digit that you entered.

Press **No** to erase the entire name or number and start again.

To enter characters and labels, turn to page 130.

## Recommended Types of Document

Before you send your document, make sure that it meets the following requirements.

**CAUTION:** Documents that do not meet these requirements can cause your machine to jam or may cause some components of the machine to become damaged or dirty.

Minimum size from the auto document feeder

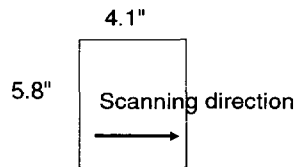

Maximum size from the exposure glass

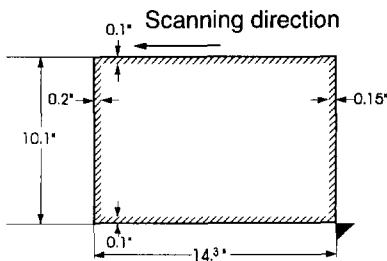

Correct Size for the Auto Document Feeder

Thickness: 2 to 8 mils (20 lb paper)

Length and Width: See the above diagram.

If the page is too short, put it inside a document carrier or enlarge it with the copier function.

If the page is too long, divide it into two or more sheets.

Maximum size from the auto document feeder

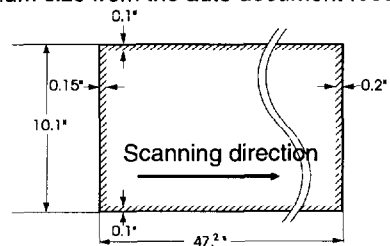

Note: The part shaded  will not be scanned, because it is outside the maximum scanning range.

**Note:** If you place the page on the exposure glass, you can transmit pages smaller than the minimum size shown above.

Clearly Written

Small faint characters may not be transmitted clearly.

Uniform Page Size

When using the document feeder, do not use different sizes of document in the same transmission.



Page Condition

Do not place damaged pages in the automatic document feeder.

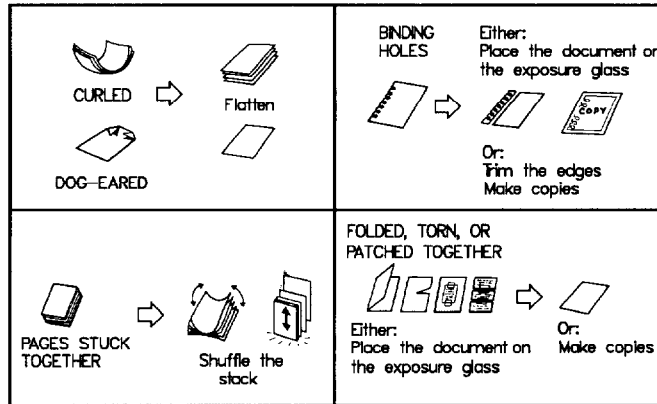

Originals that contain the following materials should not be placed in the document feeder. Place them directly on the exposure glass.

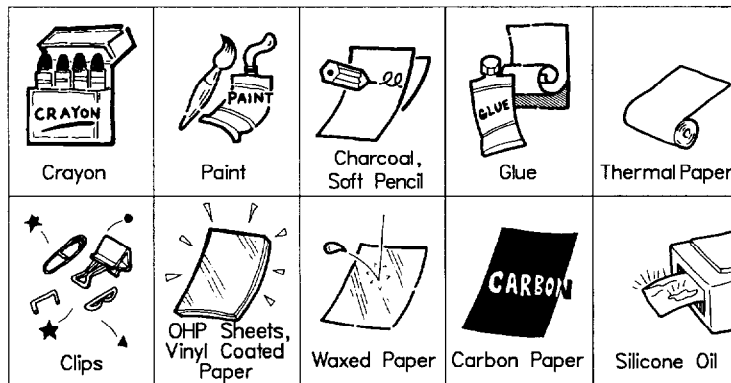

**Note:** Copies made with a copier that uses silicone oil may cause a misfeed. To avoid this, do not scan such copies until five or ten minutes after copying.

## How to Set the Document

### Setting the document in the Auto Document Feeder (ADF)

- 1 Carefully place the document face up into the auto document feeder. Then adjust the guides to fit the width of the document.

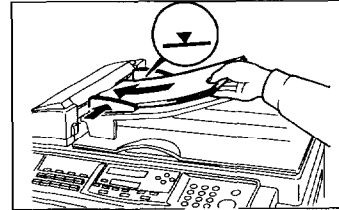

Make sure that the display changes as shown.

ADF TRANSMIT OPTION▶  
DIAL FAX NUMBER

**Note:** Do not feed in more than 30 pages.

Do not stack documents in the feeder so that they exceed the load limit marker.

### Setting the document to the exposure glass

- 1 Lift up the top cover (make sure you raise it by at least 35°, or halfway) and place the first page of your document face down on the exposure glass. Then lower the top cover.

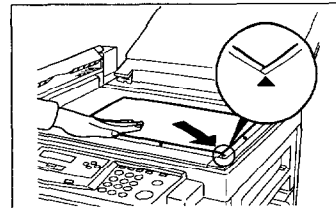

The display will change as shown.

TRANSMIT OPTION▶  
DIAL FAX NUMBER

## Memory Transmission and Immediate Transmission

There are two ways to send a fax message.

- Immediate Transmission
- Memory Transmission

### Immediate Transmission

Immediate Transmission is convenient when:

- You wish to send a message immediately
- You wish to quickly check whether you have successfully connected with the other party
- Your machine's memory is getting full

The machine dials immediately after you press Start (or at the specified later time, if you used a time-delay feature like Send Later). The message is scanned and transmitted page by page without being stored in memory.

### Memory Transmission

Memory Transmission is convenient because:

- Fax messages can be scanned much more quickly (you can take your document away from the fax machine without waiting too long).
- While your fax message is being sent, another user can operate the machine (people will not have to wait by the fax machine too long).
- You can send the same message to more than one place with the same operation.

After you press **Start**, the machine doesn't dial until all the pages of your fax message have been stored in the memory.

The default mode of this machine is Memory Transmission, so the procedures described in this manual will be based on the assumption that you are using Memory Transmission. Immediate Transmission is described in a separate section.

## Memory Transmission

### *Sending a Message with the Auto Document Feeder*

If at any time you want to completely start over, just remove the document, then open and close the top cover.

**Caution:** If your document gets stuck while it is being processed, press the Stop key, and turn to page 101 for instructions on how to safely remove the original.

**1** Remove any document left in the tray or on the exposure glass.

**2** The FAX indicator must be lit. Press the **Fax/ Copy** key if it is not lit.

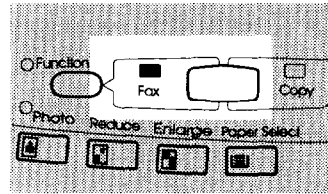

Make sure that the machine is in standby mode for faxing. The display should look like this:

```
READY 100% 10:00AM  
SET DOC. OR DIAL NO.
```

If the display isn't as above, press the Clear Modes key to clear any previously programmed destinations.

**3** Fan your document stack (at most 30 pages) to make sure all pages are loose, then square it.

All pages in your document must be one-sided and be of the same size.

- 4** Insert the document face up in the feeder and adjust the guides to fit the width of the document.

**Note:** Set the pages with the first page at the top of the stack.

Do not stack documents in the feeder so that they exceed the load limit marker.

**Note:** You can dial before you set the document. Place the document after you dial the number and go to step 8.

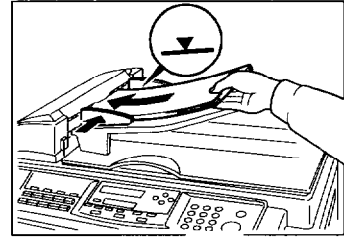

- 5** Make sure that the display changes as shown.

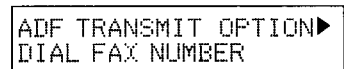

- 6** If the memory indicator is not lit, press the **Memory** key.

Dial the number in one of the following ways.

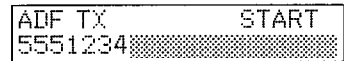

a) Ten Key Pad	b) Quick Dial	c) Speed Dial	d) Handset ☆
	<p>Example: QuickDial 12</p>	<p>Example: SpeedDial 10</p>	

☆: Only if the telephone handset is installed.

If you want to erase a digit of the phone number, press the **Clear** key.  
 If you want to erase the entire number, press the **No** key.

- 7** Press the **Start** key and wait. The machine will dial the destination's number.

```
5551234
DIAL FAX NUMBER
```

If you like to cancel the transmission, press the **Stop** key during communication.

```
5551234
STOP & CLR FILE? Y/N
```

Then press **Yes** to cancel the transmission.

If the other party's line is busy, your machine will dial again.

```
READY 100% 10:04
SET DOC. OR DIAL NO.
```

If the other party's fax machine answers, both machines will connect and yours will send the message.

```
(a number or label)
SET DOC. OR DIAL NO.
```

- Tip:** If your line goes through a local switchboard ( a PBX) remember to dial the exit code. Press the Pause key immediately after the code. If the number includes a country code, press the Pause key after the country code, then dial the rest of the number.

*Sending a Message with the Exposure Glass*

- 1** Remove any document left in the auto document feeder or on the exposure glass.
- 2** The FAX indicator must be lit. Press the **Fax/ Copy** key if it is not lit.

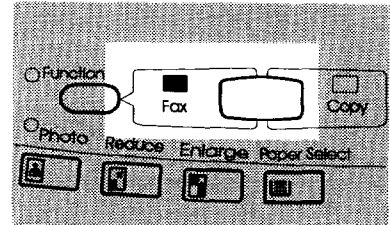

Make sure that the machine is in standby mode. The display should look like this:

```
READY 100% 10:00
SET DOC. OR DIAL NO.
```

- 3** Lift up the top cover and place the first page of your document face down on the exposure glass, as shown in the diagram. Then lower the top cover.

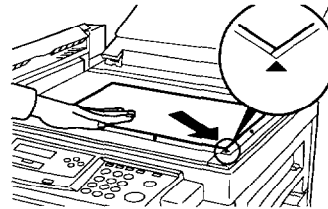

**Note:** You can dial before you set the document. Place the document after you dial the number and go to step 6. The display will change as shown.

```
TRANSMIT OPTION▶
DIAL FAX NUMBER
```

- 4** If the memory indicator is not lit, press the **Memory** key.

**5** Dial the number in one of the following ways.



a) Ten Key Pad	b) Quick Dial	c) Speed Dial	d) Handset ☆
	<p>Example: Quick Dial 12</p>	<p>Example: Speed Dial 10</p>	

☆: Only if the telephone handset is installed.

If you want to erase a digit of the phone number, press the **Clear** key.  
 If you want to erase the entire number, press the **No** key.

**6** Press **Start** key

If the document size cannot be detected, the right display appears. Select the scanning area by ◀ and ▶ key. Then press **Start**.

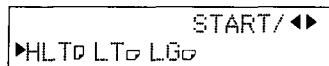

The machine scans and stores your page. After the page has been stored, the display appears as shown on the right

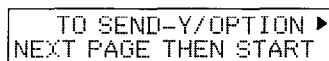

The machine is asking you to place the next page on the exposure glass.

Indicators shows how much time you have left to place the next page on the exposure glass and press **Start** key.

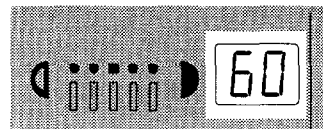

You have 60 seconds.

If you do not place a page on the exposure glass and press Start key within the remaining time, the machine will start to dial.



**7** Either;

Place the next page on the exposure glass if any and press **Start**. And repeat the step 6 for replacing the page.

If you have no more pages, press **Yes**.

**8** The machine dials, and the line to the other party is connected. On the display, the identification of the other party will appear.

**9** After sending the message, the machine hangs up automatically.

## Immediate Transmission

- 1** Remove any document left in the auto document feeder or on the exposure glass.
- 2** The FAX indicator must be lit. Press the **Fax/ Copy** key if it is not lit.

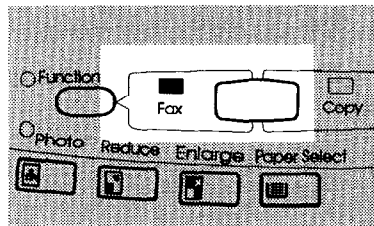

Make sure that the machine is in standby mode. The display should look like this:

```
READY 100% 10:00
SET DOC. OR DIAL NO.
```

- 3** Press **Memory** key. The Memory indicator should go out.

- 4** Either:
  - Place the first page of the document on the exposure glass.
  - or
  - Place the entire document face up into the feeder. (No more than 30 pages. Make sure that the display changes as shown.)

```
TRANSMIT OPTION▶
DIAL FAX NUMBER
```

```
ADF TRANSMIT OPTION▶
DIAL FAX NUMBER
```

How to set document see page 4.

**Note:** You can dial before you set the document. Place the document after you dial the number and go to step 6.

- 5** Dial. (See page 7 for how to dial.)

```
TRANSMIT Y/START
5551234
```

**6** Press **Start** key

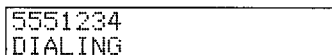

5551234  
DIALING

**7** The machine dials and the line to the other party is connected. The number that you dialed and the other party's RTI or CSI is displayed. (RTI, CSI: see page 146.)

Placing the document on the exposure glass

After a page has been sent, the machine asks you to place the next page on the exposure glass. The indicator shows how much time you have left to place the next page on the feeder and press **Start** key.

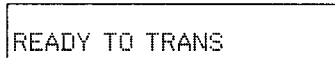
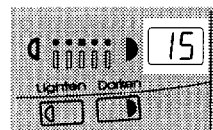

READY TO TRANS

For Immediate Transmission, you have 15 seconds. If you do not place a page on the exposure glass and press **Start** within the remaining time, the machine will disconnect the line.

Either:

Wait until the following message appears. Then, place the next page on the exposure glass and press **Start**.

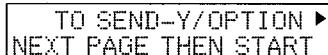

TO SEND-Y/OPTION ►  
NEXT PAGE THEN START

or

The page will be scanned and sent out. When you have get the last page, press **Yes**.

The machine will disconnect the line and return to standby mode.

## Receiving Calls & Fax Messages(Faxes/Phone Calls)

Your fax machine can treat all incoming calls as fax messages or as voice calls.

To use your phone line only for fax messages, set your machine to Auto Receive. It will accept fax messages automatically. To give priority to phone calls, set your machine to Manual Receive (handset option or a telephone needed) .

If you set your machine to Manual Receive you have to be by the machine when a fax message comes in (see below). To use an answering machine on the same line, set your fax machine to Manual Receive.

Press the **Receive** key to choose how your machine accepts messages.

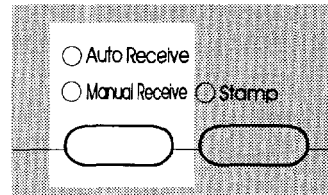

### Accepting Fax Messages Automatically

This mode is selected when the Auto Receive indicator is lit.

- 1** The machine automatically starts to receive the message.

**Accepting Fax Messages Manually(Handset or Phone Needed)**

- 1** To enable this feature, the Manual Receive indicator should be lit. If it isn't, press the **Receive** key.

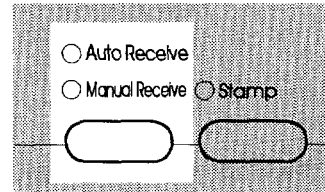

- 2** Answer the call with the handset. If you hear a voice from the other end, speak in reply. If you hear a tone every few seconds, a fax message is coming in.

Note: Remove any documents left in the feeder before you press **Start**.

- 3** If the person at the other end wishes to send you a fax message, press the **Start** key and hang up the handset. Your fax machine will accept the message. The Communicating indicator lights.

## **Printing a Message Received & Stored (Substitute Reception)**

**Caution:** If the machine is turned off for more than an hour, messages stored in memory will be lost. If this happens, the machine will print out a report (once it can) telling you which messages were lost. Contact the senders to have them send you the message again.

If the Receive File indicator is lit, a message was stored in memory using substitute reception. It was not printed, maybe because the machine is jammed or out of supplies, or the night timer has turned the heater off.

**Night Timer:** Press the Energy Saver key to print messages received while the night timer (page 57) has turned the heater off. Otherwise, check if any of the following indicators are lit. and follow instructions.

 Your fax machine is out of paper. Add paper: see page 80.

 Your fax machine is out of toner. Change the toner cassette: page 86.

Or The Check Display indicator is lit.  
There might be a paper jam (see page 102) or an open cover.

*-Message appears here-*  
SET DOC. OR DIAL NO.

As soon as the machine is back in working condition, messages stored in memory will be printed. The Receive File indicator will turn off and the messages will be erased from memory.

If a message comes in while you are copying, the fax machine will store the message in memory and the Receive File indicator will light. The message will be printed as soon as copying is done.

To turn substitute reception off or back on, set bit 0 of user parameter switch 05. See page 124.

## Faxing a Page With Very Fine Detail

If you wish to fax a message which must arrive as clearly as possible, adjust the resolution (for documents with fine detail) and the contrast (for documents printed on a dark background or in faint ink). You can also set the imaging process for sending photographs.

You can select different settings for each page of your message. Simply change the settings for page 2 while page 1 is being scanned.

### Resolution & Shading

If your document contains fine print, detailed diagrams, or photographs, use a higher resolution setting. There are three settings for general documents.

- Standard:** Use for most printed or typewritten documents.
- Detail:** Use for documents with small print or fine details.
- Fine:** Use this for high quality reproduction.

There is also an independent photo setting suitable for photographs or diagrams with complex shading patterns or grays.

**Important:** Faxing at a higher resolution requires more time. Frequent use of high resolution could cause an increase in your phone bill, especially for long distance transmissions.

## Contrast (density)

### *Manual Image Density*

The text and diagrams in your document must stand out clearly from the paper they are written on. If your document has a background darker than pure white (for example, a newspaper clipping) or if the writing is faint, adjust the contrast. There are five grades.

**Normal:** Suitable for most documents

**Darken 1 & 2**

**(Slightly Darken & Darken):** Use for documents with faint writing

**Lighten 1 & 2**

**(Slightly Lighten & Lighten):** Use for documents that have a dark or patchy background

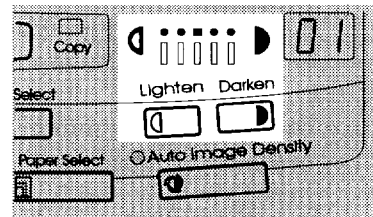

### *Auto Image Density*

If you select the Auto Image Density mode, the appropriate contrast is set automatically. Lit the **Auto Image Density** indicator.

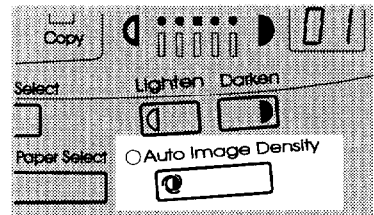



## Increasing Photo Quality

Your machine can transmit photographs and other images by using a halftone process which simulates colors and grays by using a pattern of black and white dots.

To use the above features, follow these steps:

- 1 If needed, press the **Photo** key. (When you select the Photo mode, the resolution will change to Detail automatically.)

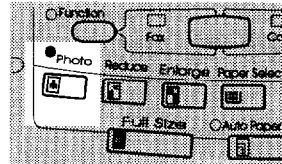

- 2 Press the **Resolution** key to select standard, fine, or detailed.

This doesn't change the photo setting you set in step 1.

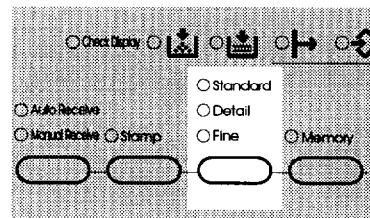

- 3 Press the **Lighten** or **Darken** key to change the contrast, if desired.

Note: You cannot select the Auto Image Density when you use the Photo mode.

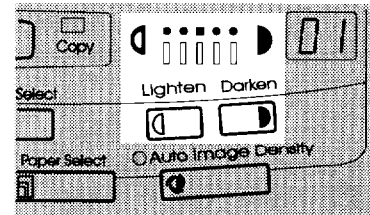

- 4 Proceed as for a usual fax transmission.

## Optional Feature for Transmission

### Sending Later

Using this feature, you can instruct the machine to delay transmission of your fax message until a specified time. This allows you to take advantage of off-peak telephone line charges without having to be by the machine at the time.

**CAUTION:** If your machine's memory is full, you will have to send the message from the document feeder. This means that anybody removing your document would automatically cancel the operation.

**1** Proceed as for a usual fax message but don't press Start.

**2** Press **▶** once and press **Yes**.  
(**▶** is also the **Option** key).

```
SET OPTION      Y/▶
SEND LATER?
```

**3** Enter a sending time that falls within the following 24 hours.  
For example: To send at 11:30 pm, press **1**, **1**, **3**, and **0** from the key pad. If you enter wrongly, press **No** and enter again. You'll get:

```
SET OPTION      KPAD/Y
TIME 11: 30AM 10: 00AM
```

**4** Press **\*** or **#** to change the AM/PM.

```
SET OPTION      */#/Y
TIME 11: 30PM 10: 00AM
```

**5** Press **Yes**.

Use function 21 to erase a stored fax message before it is sent, (see page 42).

### Page Count (Immediate Transmission only)

When your fax message is printed at the other end, page numbers will be printed on the top of each page. Using the Page Count feature, you can select the format in which the page numbers are printed.

If you use Page Count:

Page numbers will be printed in batch-numbering format (for example, p1/3, p2/3, and p3/3 for a three-page message). This makes it easy for the other party to see how many pages you sent, and if any are missing. However, you have to input the number of pages at the keypad before sending.

If you do not use Page Count:

Page numbers will be printed only as a sequence (for example, p1, p2, p3). This makes it difficult for the other party to tell at a glance whether any pages are missing (for example, due to a double feed in your machine's document feeder).

**Note:** If you do not select Immediate Transmission, Page Count is automatically switched on, and the pages are counted automatically.

**1** Press **▶** until the right display appears.

```
SET OPTION      Y/▶
SET PAGES?
```

**2** Yes.

```
SET OPTION      KPAD
PAGES:
```

**3** Example: 10 pages  
1 0

```
SET OPTION      Y/N
PAGES: 10
```

**4** Yes.

## TTI

Normally, the TTI programmed in your machine is printed at the top of each of the pages you transmit when they are received at the other end. The top of the image will be overprinted if there is no margin at the top of the transmitted page.

In some cases, you may wish the other party to receive an unmarked copy of your original. In this case, you can switch TTI off.

- 1** Press **▶** until the right display appears.

```
SET OPTION      Y/▶
TTI PRINT?
```

- 2** Yes.

```
SET OPTION      Y/◀▶
▶ON      OFF
```

- 3** If you wish to change the TTI setting, press **◀** or **▶** until the displayed setting is correct.

```
SET OPTION      Y/◀▶
ON      ▶OFF
```

- 4** Yes when you have finished.

## Document size

If you are going to send a page that is not of a normal size, your machine may have trouble scanning the entire page. For example, if your page is larger than a certain size but smaller than the next size up, you should use the document size selection feature to select the larger size. Otherwise, your machine will not scan the outer margins of your page. This feature is only available if you send a document placed directly on the exposure glass, not with the auto document feeder.

- 1** Press **▶** until the right display appears.

```
SET OPTION      Y/▶
SET DOCUMENT SIZE?
```

- 2** Yes.

```
SET OPTION      Y/◀▶
▶HLT◻LT◻LG◻
```

- 3** Select the scanning area using **◀** and **▶** key.

```
SET OPTION      Y/◀▶
▶HLT◻LT◻LG◻
```

Yes when you have finished.

## Sending the Same Message to Many Destinations

This is also called broadcasting.

### Caution:

There is a limit of 100 stored numbers overall.

Do not store more than 100 numbers (including those in groups). If you do, your machine will not send the message to all numbers in the group. See page 132 for more details.

**1** Remove any document left in the tray or on the exposure glass.

**2** Make sure that the machine is in standby mode for faxing .

```
READY 100% 10:00
SET DOC. OR DIAL NO.
```

**3** The FAX indicator must be lit. Press the **Fax/ Copy** key if it is not lit.

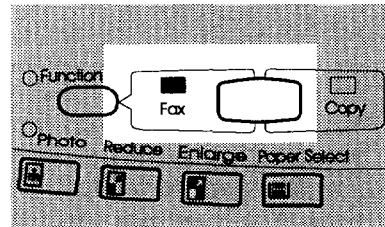

**4** Make sure the **Memory** indicator is turned on.  
 If it is not lit, press the **Memory** key

**5** Either:  
 Place the first page of the document on the exposure glass.

```
TRANSMIT OPTION▶
DIAL FAX NUMBER
```

or  
 Place the entire document face up into the feeder. Make sure that the display changes as shown.

```
ADF TRANSMIT OPTION▶
DIAL FAX NUMBER
```

How to set the document: see page 4.

**6** Dial a fax number in one of the following ways.

```
TRANSMIT      Y/START
@0144215842261
```

a) Ten Key Pad	b) Quick Dial	c) Speed Dial	d) Group Dial
	<p>Example: Quick Dial 12</p>	<p>Example: Speed Dial 10</p>	<p>Example: Method 1 * 08 of the Quick Dial key. Method 2 ** 20 of the Quick Dial key and 1 of the ten key pad.</p>

\*: This is the example of the case where Group Dial is programmed in 08 of the Quick Dial key.

\*\* : This is the example of the case where Quick Dial key 20 is programmed as the Group key, and Group dial number 1 is programmed.

Programming the Quick Dial: see page 28.

Programming the Speed Dial: see page 32.

Programming the Group Dial: see page 37.

Programming the Group key: see page 41.

Note: The maximum destinations you can dial using the ten key pad is 49. However, this limitation is up to the machine condition.

If you enter the wrong number, press **No** or **Clear** and enter again.

**Clear** to delete one digit.

**No** to delete the whole number.

**7** Press **Yes** (not the Start key).  
You'll get:

```
TRANSMIT  DIAL/START
DIAL NEXT FAX NUMBER
```

(When you set the document to the feeder)

```
ADF TX    DIAL/START
DIAL NEXT FAX NUMBER
```

**8** Repeat steps 2 and 3 until all destinations are entered.

**9** Press the **Start** key.

The machine stores your message and dials the first number (or, if you selected Send Later, it will return to standby mode and the fax message will be sent at the time that you selected). Send later: see page 20 .

For users who place the document on the contact glass

After a page has been stored, the machine asks you to place the next page on the exposure glass. The indicator shows how much time you have left to place the next page on the feeder and press **Start** key.

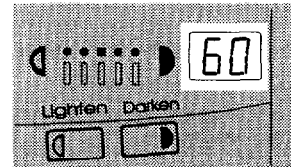

You have 60 seconds. If you do not place a page on the exposure glass and press **Start** within the remaining time, the machine will start to dial.

Either:

Place the next page on the exposure glass and press **Start**. The page will be scanned and stored.

or

If you have no more pages, press **Yes**. The machine will dial the first destination (or , if you selected Send Later, it will return to standby mode and the fax message will be sent at the time that you selected.)

## Using the Stamp

Press the Stamp key to achieve the transmission verification stamp. When the Stamp indicator is lit, the machine stamps a small mark on the bottom of each page. During memory transmission, the stamp indicates that the page was successfully stored. For immediate transmission, it shows that the page was sent successfully. You must switch the stamp on before you press **Start** , or the machine will not stamp the first page.

If you wish to change the Stamp default setting, set by user parameter switch 00, bit 0.

0: Verification stamp off

1: Verification stamp on

## Redialing

If a message was not transmitted successfully, that does not mean that you have to enter the telephone number again. In many cases, the machine will redial the destination automatically. Or, with the Redial key, you can redial with just a few keystrokes.

### Automatic Redialing

The machine will automatically redial the other party if any of the following conditions occurred.

- The other party was busy
- There was no reply from the other party

The message was rejected by the machine at the other end because of excessive errors (in this case, redialing will only take place if Memory Transmission was used)

Redialing is done 4 times at 5 minute intervals (for a memory transmission) or 2 times at 5 minute intervals (for an immediate transmission).

The number of redials and the redial interval may be adjusted by a service technician.

During redialing, the number being dialed is displayed as shown on the right.

21255551234 DIALING
------------------------



## Using the Redial Key

The machine remembers the last telephone number that you input. If you have to redial this number, just press the Redial key, then press the Start key.

This feature has the following uses.

If the machine is waiting to redial the other party, you do not have to wait for the redialing interval to expire.

If you wish to send another message to the same address that you just sent last time, you don't have to dial the full number again.

Place the message in the feeder, then press the Redial key, then press the Start key.

To send a fax using Redial, do the following:

- 1** Remove any document left in the auto document feeder or on the exposure glass.
- 2** The FAX indicator must be lit. Press the **Fax/ Copy** key if it is not lit.

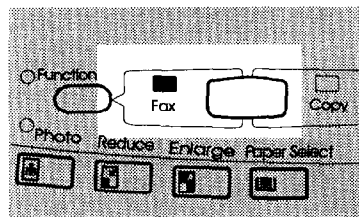

Make sure that the machine is in standby mode for faxing. The display should look like this:

```
READY 100% 10:00AM
SET DOC. OR DIAL NO.
```

- 3** Set your document. How to set the document, see page 4.
- 4** Press **Redial**.
- 5** Press **Start**.

```
REDIAL Y
2125551234
```

## Storing & Editing Fax Numbers (Functions 31 & 32)

Numbers that you often use can be stored in memory. A stored number will remain in memory even if the power is cut.

There are two ways to store individual phone numbers. Firstly, you can store a number in its own assigned key. This is called Quick Dial. Secondly, you can store a number as a two-digit code. This is called Speed Dial.

### Storing, Editing, & Erasing Quick Dial Numbers ( ■ Function 31)

#### *Storing a Number*

You can store up to 20 telephone number as Quick Dial keys. In this example you'll be storing a number in Quick Dial key 01.

**1** Press the **Function** key then press **3** and **1**. You'll get this:

```
PROGRAMMING  Y/NEXT▶
31 PROGR. QUICK DIAL
```

**2** Press **Yes** and you'll get this:  
(At this time, you can print a list of the numbers and groups stored in Quick Dial keys. Press ◀ and **Start**.)

```
■ ■ QUICK/◀▶
PRINT LIST◀/SEARCH▶
```

**3** Press **Quick Dial 01** You'll see this:

```
■ 01 PROGRAM?  Y/◀▶
```

Flip the plate, if needed. Make sure you push the flap down until it lies flat.

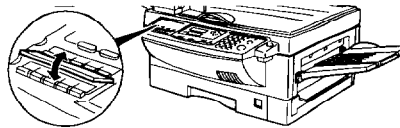

**4** Press **Yes**. You'll see this:

```
■ 01 KPAD/N
```

(If you're editing a number already stored, the lower line will display a number.)

**5** Enter the telephone number.

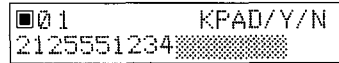

**6** Press **Yes**. You'll get this:

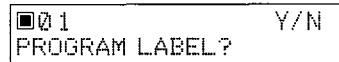

**7** If you *do* wish to enter a label, press **Yes**.

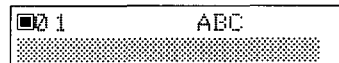

Press **No**. And go to step 10

**8** Enter the label using the Quick Dial keys (see page 130).

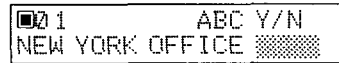

**9** Press **Yes**.

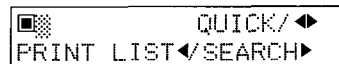

**10** Go to step 2 to store another number, or press the **Function** key if you're done.

*Editing a Number*

**1** Press the **Function** key then press **3** and **1**. You'll get this:

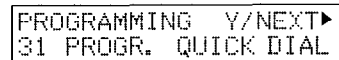

**2** Press **Yes** and you'll get this:

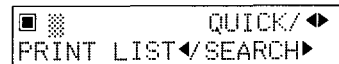

**3** Press the Quick Dial Key that you want to edit. Example: **Quick Dial 01**.

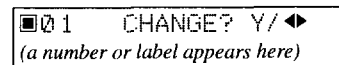

If the wrong number is displayed, use the ◀ and ▶ keys to scroll through the Quick Dial Keys on the screen.

**4** Press **Yes**. You'll get this:

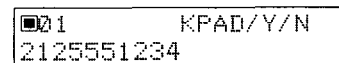

- 5** Edit the number.  
Use ◀ and ▶ to move the cursor. Use Clear or No to delete the number.

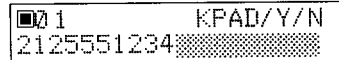

**No** to delete the whole number  
**Clear** to delete the digit on cursor

- 6** Press **Yes**.

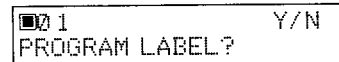

- 7** Either:

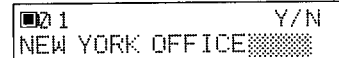

- Change the label: Press **Yes**. And go to step 8.
- Keep the label as it is: Press **Yes** twice. Go to step 10.

- 8** Edit the label.  
Use ◀ and ▶ to move the cursor. Use Clear or No to delete the number.

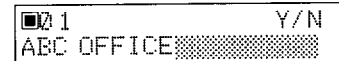

**Clear** to delete one character  
**No** to delete the whole characters at the cursor  
How to enter characters :see page 130.  
Example: ABC OFFICE

- 9** Yes



- 10** Either:
- Edit another: Go to step 3.
  - Finish: Press **Function**.

*Erasing a Quick Dial*

For this example, we'll erase the number stored in Quick Dial 01.

- 1** Press the **Function** key then press **3** and **1**. You'll see this:

PROGRAMMING Y/NEXT▶  
31 PROGR. QUICK DIAL

- 2** Press **Yes** and you'll see this:

☐ QUICK/◀▶  
PRINT LIST◀/SEARCH▶

(At this time, you can print a list of the numbers and groups stored in Quick Dial keys. Press ◀ and **Start**.)

- 3** Press **Quick Dial 01** (flip the plate, if needed). You'll see this:

☐ 01 CHANGE? Y/◀▶  
NEW YORK OFFICE

- 4** Press **Yes**. You'll see this:

☐ 01 KPAD/Y/N  
12125551234

- 5** Press **No**. You'll see this:

☐ 01 KPAD/N

- 6** Press **Yes**. The word **CLEARED** will appear briefly, and then this:

☐ QUICK/◀▶  
PRINT LIST◀/SEARCH▶

- 7** Go to step 2 to erase another number, or press the **Function** key if you're done.

### Storing, Editing, and Erasing Speed Dial Numbers (☒ Function 32)

You can store up to 50 telephone numbers as two-digit Speed Dial codes. You can program the Speed Dial code from 00 through 49.

#### *Storing a Speed Dial Number*

For this example, we'll assume you will store a number in Speed Dial code 00.

**1** Press the **Function** key then press **3** and **2**. You'll see this:

```
PROGRAMMING Y/NEXT▶
32 Progr. SPEED DIAL
```

**2** Press **Yes** and you'll see this:

```
☒☒☒ KPAD/◀▶
PRINT LIST◀/SEARCH▶
```

(At this time, you can print a list of the numbers stored as Speed Dial codes. Press ◀ and **Start**.)

**3** Press **0** and **1**. You'll see this:

```
☒ 01 PROGRAM? Y/◀▶
```

**4** Press **Yes**. You'll see this:

```
☒01 KPAD/N
████████████████████
```

**5** Enter the telephone number.

```
☒ 01 KPAD/N
2125551234██████████
```

**6** Press **Yes**. You'll see this:

```
☒01 Y/N
PROGRAM LABEL?
```

**7** You have two options:

- If you want to program the label for this Speed Dial, press **Yes**.
- If you don't want to program the label for this number, Press **No** and go to step 10.

```
☒ 01 ABC
████████████████████
```

**8** Enter a label. How to enter characters :see page 130.

```
☒ 01 ABC/Y/N
XYZ CO. LONDON██████
```

**9** Press **Yes**.

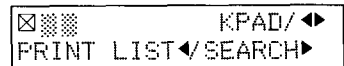

- 10** Either:
- Program another: Go to step 3
  - Finish: Press Function.

*Editing a Speed Dial Number*

**1** Press the **Function** key then press **3** and **2**. You'll get this:

```
PROGRAMMING  Y/NEXT▶
32 PROG.  SPEED DIAL
```

**2** Press **Yes** and you'll get this:

```
☒ KPAD/◀▶
PRINT LIST◀/SEARCH▶
```

(At this time, you can print a list of the numbers stored as Speed Dial codes. Press ◀ and **Start**.)

**3** Input the Speed Dial code that that you wish to edit.

```
☒ 01 CHANGE?  Y/◀▶
NEW YORK OFFICE
```

Example: If you edit the Speed Dial code 01, press 0 and 1 from the ten key pad. Or press ▶ then search the Speed Dial code using ◀ and ▶.

**4** Press **Yes**.

```
☒ 01          KPAD/Y/N
2125551234
```

Edit the number.  
Use ◀ and ▶ to move the cursor.  
Use Clear or No to delete the number.

```
☒ 01          KPAD/Y/N
2125551235
```

**No** to delete the whole number  
**Clear** to delete the digit on cursor

**5** Press **Yes**.

```
☒ 01          Y/N
PROGRAM LABEL?
```

**6** Either

```
☒ 01          Y/N
NEW YORK OFFICE
```

- Change the label: Press **Yes**. And go to step 8.
- Keep the label as it is: Press **Yes** twice. Go to step 10



- 7** Edit the label.  
Use ◀ and ▶ to move the cursor. Use Clear or No to delete the number.

**Clear** to delete one character  
**No** to delete the whole characters at the cursor  
How to enter characters :see page 130.  
Example: LONDON OFFICE

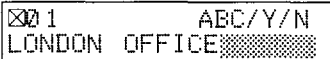

01 ABC/Y/N  
LONDON OFFICE

- 8** Press **Yes**.

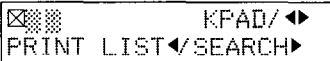

KPAD/◀▶  
PRINT LIST◀/SEARCH▶

- 9** Either
- Edit another: Go to step 3.
  - Finish: Press **Function**.

*Erasing a Speed Dial Number*

For this example, we'll erase the number stored in Speed Dial 01.

- 1** Press the **Function** key then press **3** and **2**. You'll set this:

```
PROGRAMMING Y/NEXT▶
32 PROG. SPEED DIAL
```

- 2** Press **Yes** and you'll set this:

```
☒ [dots] QUICK/◀▶
PRINT LIST◀/SEARCH▶
```

(At this time, you can print a list of the numbers stored as Speed Dial codes. Press **◀** and **Start**.)

- 3** Input the Speed Dial Code that you wish to erase.  
Example: If you want to erase Speed Dial code 01, press **0** and **1**. Or press **▶** then search for the Speed Dial code using **◀** and **▶**.  
You'll get this:

```
☒ 01 CHANGE? Y/◀▶
XYZ CO. LONDON [dots]
```

- 4** Press **Yes**. You'll set this:

```
☒ 01 KPAD/Y/N
2125551234 [dots]
```

- 5** Press **No**. You'll set this:

```
☒ 01 KPAD/N
[dots]
```

- 6** Press **Yes**. The word **CLEARED** will appear briefly, and then this:

```
PROGRAMMING Y/NEXT▶
32 PROG. SPEED DIAL
```

- 7** Go to step 3 to erase another number, or press the **Function** key if you're done.

## Storing & Editing a Group of Fax Numbers (Function 33)

You can combine many numbers into one group, for easy sequential transmission to all the numbers in that group. These numbers can be selected from those already stored in Quick Dial keys or Speed Dial codes, or you can enter other numbers from the keypad.

There are three groups available, ranging from group 1 to group 3.

You can program the 100 numbers in a Group.

### Storing Numbers In a Group

In this example, we will program numbers into group 1. We will store group 1 in Quick Dial key 08.

**1** Press **Function, 3 and 3**.

```
PROGRAMMING Y/NEXT▶
33 PROGR. GROUP
```

**2** Press **Yes**.

```
GROUP 1 1-3/◀▶
PRINT LIST◀/SEARCH▶
```

**3** Input the number of the group that you wish to program.  
Example: press **1**. You'll get this:

```
GROUP 1 Y/◀▶
-label appears here, if any-
```

**4** Press **Yes**.

```
GROUP 1 Y/N
PROGRAM QUICK?
```

**5** There are two options:

```
GROUP 1 QUICK/N
■
```

- If you want to program this group into a Quick Dial Key, press **Yes**. And go to step 6.
- If you don't want to program this group into a Quick Dial key, press **No** and go to step 8.

- 6** Press the Quick Dial key in which you wish to store this new group.  
Example: Quick Dial 08. Press **Quick Dial 08**. You'll get:

```
GROUP 1          Y/N
█08
```

- 7** Press **Yes**. You'll get:

```
GROUP 1          Y/N
PROGRAM LABEL?
```

- 8** If you *do* wish to enter a label, press **Yes** and use the Quick Dial keys to enter characters (see page 130). Then press **Yes** to accept the label.

```
GROUP 1          DIAL/N
████████████████
```

- Or* If you do not wish to program the label: press **No**.

- 9** Enter the fax number that you wish to store in the group. For example:

Press **Quick Dial 01**.

```
GROUP 1          Y/N
█01
```

- Or*: Press **Speed Dial, 0**, and **0**.

```
GROUP 1          Y/N
☒00
```

- Or*: Dial a full number from the key pad.

```
GROUP 1          Y/N
00144215842261 ██████████
```

**Caution:** The numbers you can program using the ten key pad is up to the machine's condition. You can program up to 48 numbers in the whole groups using the ten key pad.

- 10** Press **Yes**. (If the message ALREADY PROGRAMMED appears, either erase the number by pressing Yes, or keep the number by pressing No.)

- 11** Go back to step 9 to enter another number or press **No** if you are finished entering numbers for this group.
- 12** Go to step 3 to start working on another group, or press **Function** if you are done with all groups.

### Editing and Erasing from the Group

- 1** Press **Function 3** and **3**.

```
PROGRAMMING Y/NEXT▶
33 PROG. GROUP
```

- 2** Press **Yes**.

```
GROUP █ 1-3/◀▶
PRINT LIST◀/SEARCH▶
```

- 3** Input the number of the group that you wish to program.  
Example: If you want to delete or edit the contents of the Group1: press 1 on the ten key pad. Then press **Yes**.

```
GROUP 1 Y/N
PROGRAM QUICK?
```

- 4** Either; If you want to change the Quick Dial key where that Group is stored: Press **Yes**.  
And press **No** and press a new Quick Dial Key.  
Note: If that group is not programmed into a Quick Dial key, you don't have to do it.  
And press **Yes**. Then go to step 5.

```
GROUP 1 Y/N
█08
```

```
GROUP 1 Y/N
█16
```

- 5** There are two options:
- If you want to change the label, press **Yes**. Then Edit the label and press **Yes**.

```
GROUP 1 Y/N
PROGRAM LABEL?
```

```
GROUP 1 ABC Y/N
DISTRIBUTOR █
```

- If you keep this label, press **No**.

```
GROUP 1 DIAL/N
█
```

- 6** Input a number that you wish to store in or erase from the group.  
 Example:  
 Quick Dial 01: Quick Dial key 01.  
 Speed Dial 30: Speed Dial, 3 and 0 on the ten key pad.  
 Full number: Enter it on the 10 key pad.

```
GROUP 1      Y/N
SPEED 30
```

- 7** Press **Yes**.  
 If "ALREADY PROGRAMMED" appears, either:  
 To keep the number, press **No**.  
 To erase the number, press **Yes**.  
 Go back to step 6

```
GROUP 1      DIAL/N
XXXXXXXXXXXX
```

- 8** Either  
 To store or erase another number: Go to step 6.  
 To finish, press **Function**.

### Erasing Groups

These steps describe how to erase single numbers from a group.

- 1** Press the **Function** key and **3, 3** using the ten keypad, then press the **Yes** key.

```
GROUP 00    1-3/◀▶
PRINT LIST ◀/SEARCH▶
```

- 2** Enter the group number using the ten key pad, then press the **Yes** key.

```
GROUP 1      Y/N
PROGRAM QUICK?
```

- 3** Press the **No** key.

```
GROUP 1      QUICK/N
PROGRAM LABEL?
```

- 4** Press the **No** key.

```
GROUP 1      Y/N
CLEAR?
```

- 5** Press the **Yes** key.

```
GROUP 1      Y/N
CLEARED
```

- 6** Either:  
 Delete another number: Go to step 2  
 Finish: Press **Function**.

### Programming the Group key

You can program three groups. However, if there is no Quick Dial Key available, this Group key is helpful. You have to program Quick Dial 20 as the Group key.

**1** Press **Function 3 1** and **Yes**.

```
■ QUICK/◀▶  
PRINT LIST◀/SEARCH▶
```

**2** Press **20** of the Quick Dial key.

```
■ 20 PROGRAM? Y/◀▶
```

**3** Press **Yes**.  
Quick Dial 20 is programmed as a Group key.

```
■ 20 Y/N  
PROGRAM GROUP KEY?
```

**4** Press **Yes**. Quick Dial 20 is now programmed as the Group key.  
To finish, press **Function**.

```
■ QUICK/◀▶  
PRINT LIST◀/SEARCH▶
```

## Erasing a Stored Message Before It Is Sent (Functions 21 & 22)

Every time you store a fax message in your machine's memory, a new file is created. A file is also created for storing instructions to pick up a fax message left elsewhere (polling, page 44). Each file is given a number. This number appears on the memory storage report, TCR and Transmission Result Report. To see which files are currently in memory, print a file list.

- 1** To erase a fax message stored in memory:

Press **Function, 2, 1,** and **Yes**

```
FILE NO. [REDACTED] KPAD/◀▶  
PRINT LIST◀/SEARCH▶
```

- Or* To erase instructions to *pick up* a message (polling):

Press **Function, 2, 2,** and **Yes**

- 2** Press ▶ to scroll through the files. You'll get this.

```
FILE NO. 027 Y/◀▶
```

Or: Press ◀ to obtain a list of all the files and their number. If you already know the number of the file to erase, enter it directly from the keypad and skip to step 4.

- 3** Scroll through the files with ◀ or ▶.

```
FILE NO. 028 Y/◀▶  
- number or label-
```

- 4** Press **Yes.**

```
FILE NO. 028 Y/N  
CLEAR?
```

- 5** Press **Yes** again to erase the file.



## Printing a Stored Message (Function 51)

If you need to see the contents of any of the files, use this feature.

- 1** Press **Function, 5, 1,** and **Yes.**

```
FILE NO. [REDACTED] KPAD/◀▶
PRINT LIST◀/SEARCH▶
```

- 2** Press ▶ to scroll through the messages. You'll see this.

```
FILE NO. 115 Y/◀▶
```

Or: Press ◀ to obtain a list of all the files and their number. If you already know the number of the file to print, enter it directly from the keypad and skip to step 4.

- 3** Scroll through the message files with ◀ or ▶.

```
FILE NO. 116 Y/◀▶
-number or label-
```

- 4** Press **Yes.**

```
FILE NO. 116 START/N
-number or label-
```

- 5** Press **Start** to print the message.

## Polling Reception (Function 11)

Use this feature when you wish to pick up a message from another terminal.

You can poll documents from many terminals with one operation, similar to broadcasting.

The maximum number of terminals that you can poll is 100.

- 1** Press **Function, 1** and **1**

```
TRANS. MODE Y/NEXT▶
11 POLLING RECEIVE
```

- 2** Press **Yes**.

```
POLLING RECV OPTION▶
DIAL FAX NUMBER
```

- 3** Dial the number from where you will pick up the message.

```
POLLING RECV Y/START
-number or label-
```

You can use Quick Dial keys, Speed Dial codes, or groups

- 4** Press **Yes**. If you want to dial more numbers, go to step 3.

```
POLLING RECV D/START
DIAL NEXT FAX NUMBER
```

- 5** Press **Start**.

Note: Another terminal should have the polling feature. You cannot poll from a machine that has set secure polling with ID number. Ask the other end to make a polling file without polling ID.

### Polling Options

You can set the time when you poll the message. If you pick up the document, do as following.

- 1** Carry out the steps 1-4 for polling reception, but don't press Start.

```
POLLING RECV D/START
DIAL NEXT FAX NUMBER
```

**2** Press Option (▶) and then **Yes**.

```
SET OPTION      KPAD/Y
TIME 10:00AM 10:00AM
```

**3** Use the ten key pad to enter the time when you want polling to happen. For example enter **1 1 3** and **0**. If you enter wrongly, press **Clear** or **No** and enter again. You'll get:

```
SET OPTION      KPAD/Y
TIME 11:30AM 10:00AM
```

**No** to clear the whole number  
**Clear** to delete one digit

**4** Press \* or # to change the AM/PM.

```
SET OPTION      KPAD/Y
TIME 11:30PM 10:00AM
```

**5** Press **Yes**.

```
POLLING RECV D/START
DIAL NEXT FAX NUMBER
```

**6** Press **Start**.  
The other terminal(s) will be polled at the time you have just set.

**7** Press **Function** to return to the standby mode.

### Deleting a Preset Polling Reception (Function 22)

Use function 22. For details, see Erasing a Stored Message on page 42.

## Talking Before Sending a Fax(On Hook Dial)

- 1** Press the **On Hook Dial** key
- 2** Proceed as for a usual fax message but don't press **Start**. (Do not use the handset).
- 3** If you hear a voice from the machine's built-in speaker, pick up the handset and speak to the other party.  
  
If you hear a high-pitched tone instead of a voice, place your fax message in the auto document feeder or on the exposure glass, then press **Start**.
- 4** When you are ready to send your fax message, place your message in the feeder, then ask the other party to press **Start**.
- 5** When you hear a high-pitched tone, press **Start**.
- 6** Replace the handset.

## Sending a Fax using the Handset

You can send a fax message using the handset (Optional handset is required)

- 1** Set the document then pick up the handset.
- 2** Dial the other party.
- 3** If you hear a voice, speak to the other party.  
  
If you hear a high-pitched tone instead of a voice, press **Start**.
- 4** When you are ready to send your fax message, ask the other party to press **Start**.
- 5** When you hear a high-pitched tone, press **Start**.
- 6** Replace the handset.

---

## OTHER FEATURES

Other features are listed here that you might find useful but that you will not set very often.

Verifying Communications, Errors, Counters, etc.....	47
Rejecting Messages From Certain Senders.....	52
Saving Energy .....	57
Printing the Sender's Identification .....	61
Tonal Signals.....	61
Things a Service Technician Can Change.....	62

### Verifying Communications, Errors, Counters, etc.

You can obtain reports from your machine either by having your machine print them out automatically, or by printing them out yourself.

#### Automatically Printed Reports

Unless otherwise indicated, the automatic printing of these reports can be turned on or off by changing the bit of the switch of the user parameters (see page 121) indicated in the subtitle.

##### *Transaction Confirmation Report (TCR, Switch 03, bit 7)*

This report gives detail on each communication made by your terminal. It is automatically output after 35 number of communications.

##### *File Reserve Report (Memory Storage Report) (Switch 03, bit 2)*

If you switch this report on, it is printed immediately after you store a document in memory for Memory Transmission. It gives the file number, the time that it was stored, and the destinations (including any Group numbers that were selected).

##### *Power Failure Report (Stays on)*

This report is printed if the machine's power was off for long enough to erase files from the memory. The report gives details of the files that were lost. With this information, you may store messages for transmission again, and contact the senders of any received messages that were lost.

(Note: Phone numbers stored in Quick/Speed/Groups are not lost.)

Communication Result Report (Memory Transmission) (Switch 03, bit 0)

This report is printed out after memory transmission showing whether it was successful or not. If you have switched this report off, a Communication Failure Report will be printed when a communication fails.

Transmission Result Report (Switch 03, bit 5)

This report is printed out after immediate transmission showing whether it was successful or not.

File Reserve Report (polling reserve report) (Switch 03, bit 3)

If you switch this report on, it is printed automatically after you program the machine for polling reception (immediate or send later). It gives the file number, time of polling, and destinations (including any Group numbers that you selected).

Communication Result Report (polling result report) (Switch 03, bit 4)

This report is printed after your machine polls a message from another machine.

Communication Failure Report (ON if Transmission Result Report is OFF)

This report is printed if a memory transmission failure occurred, after a job is completed. It is only printed if the Transmission Result Report is switched off.

Error Report (Turned on/off by a Service Technician)

This report is printed after each unsuccessful communication. The communication failure report (above) is printed after a job has been completed. So while doing a broadcast, the machine may print a number of error reports, and at the end, it prints a communication failure or transmission result report. Check it, and retransmit any pages that were not sent. If a particular problem continues or gets worse, keep the error reports for the service technician.

Printing Part of the Image on the Report (Switch 04, bit 7)

For reference purposes, the machine prints the first few inches of the fax message on the following reports.

- Transmission Result Report
- Memory Storage Report
- Communication Failure Report

**Report Formats**

*Example 1. Error Report\**

* * * ERROR REPORT (AUG 01 1995 -06:00 AM) * * *					
			TTI	XYZ COMPANY	
FILE	ADDRESS	MODE	TIME	PAGE	RESULT
-----					
<i>Report details appear here</i>					

*Example 2. TCR\**

* * * TCR (AUG 01 1995 07:00AM) * * *							
				TTI	XYZ COMPANY		
<TX>							
DATE	TIME	ADDRESS	MODE	TIME	PAGE	RESULT	FILE
-----							
<i>Transmission details appear here</i>							
<RX>							
DATE	TIME	ADDRESS	MODE	TIME	PAGE	RESULT	FILE
-----							
<i>Reception details appear here</i>							

The Mode Column

See the bottom of the TCR for a full listing of symbols on the TCR. On other reports a code is given, informing the type of communication. These codes are explained below.

The Result Column

- OK: Successful Communication
- E: An error occurred
- STANDBY: Ready to transmit

The Footnote on the TCR

- TX counter: Total number of transmitted pages
- RX counter: Total number of received pages

Counters listed on the User Parameter List

- SCN: Total number of pages scanned
- PRN: Total number of pages printed

In the Result column, an "E" followed by a code might appear, and a message might also appear at the bottom of the report. This code and message indicate that a problem occurred. The codes are explained below.

Code	Message	Explanation
1	Hang up or line fail	The other party either hung up or had no message on polling standby. Or there could have been a problem with the line.
2	Busy	The machine at the other end was busy.
3	No answer	The machine at the other end did not answer.
4	No facsimile connection	The machine at the other end is not a facsimile.

### Reports You Can Printout Yourself

You can print these reports at any time by following the steps below.

#### *Transaction Confirmation Report (Function 41)*

In addition to the automatic output of this report, which we've described earlier, you can print the TCR at any time.

**1** Press **Function, 4, 1** and **Yes**.

```

START
PRINT TCR

```

**2** Press **Start** to print out the report.

#### *File List (Function 42)*

This is a list of memory transmission files still in memory. It gives information about each stored file, such as the fax numbers, start time, and status.

**1** Press **Function, 4, 2** and **Yes**.

```

START
PRINT LIST FILE

```

**2** Press **Start** to print out the report.



*Telephone Number List (Function 43)*

You can obtain a list of all the phone numbers stored in the machine. (You can also obtain a list of stored numbers as you edit them. See the section on storing numbers, beginning on page 28.)

**1** Press **Function**, **4**, and **3**.

```
REPORTS      Y/NEXT▶
43 PRINT TEL LIST
```

**2** Press **Yes**.

```
ALL LISTS?  START/N
QUICK/SPEED/GROUP
```

**3** To print all the numbers (Quick Dial, Speed Dial, and Group numbers) press **Start**. Then press **Function** and skip steps 4 and 5. Three lists will come out.

*Or* Press **No** and you'll see this:

```
SELECT LISTS Y/N
QUICK DIAL LIST?
```

**5** Either;  
If you want Quick Dial list, press **Yes**.  
If you don't press **No**.

```
SELECT LISTS Y/N
SPEED DIAL LIST?
```

**6** Either;  
If you want Speed Dial list, press **Yes**.  
If you don't press **No**.

```
SELECT LISTS Y/N
GROUP LIST?
```

**7** Either;  
If you want Group list, press **Yes**.  
If you don't press **No**.

```
START
```

**8** Press **Start**.

```
-Message appears here -
```

## Counters (Function 94)

These counters will help you if you wish to keep a regular check on how many pages your machine has sent, received, and copied. The machine has the following counters:

- TX Counter:** The number of pages that your machine has sent (transmitted)
- RX Counter:** The number of pages that your machine has received
- Scan Counter:** The number of pages that your machine has scanned (including copies)
- Print Counter:** The number of pages that your machine has printed (including copies, reports, lists and pages printed using the printer option.)

- 1** Press **Function 6**, and enter the access code **2222**, then press **9**, **4**, and **Yes**.

```
TX      : 003256
RX      : 002648
```

- 2** Press **Yes** to check the SCAN and PRINT counter.

```
SCAN   : 003287
PRINT  : 002703
```

- 3** Either:
- To finish, press **Yes** twice.
  - 1) If you have replaced the photoconductor before REPLACE OPC appears (see page 92) then press Yes to reset the counter.
  - 2) Press **Clear**.
  - 3) Press **Yes**.

```
OPC      Y/CLEAR
```

```
OPC      Y/CLEAR
```

- 4** When you have finished, press **Function**.

## Rejecting Messages From Certain Senders

### Rejecting Messages From Senders Who Don't Identify Themselves

Your fax machine can reject incoming messages lacking an identifier signal. Follow the user parameter procedure on page 121 to enter these settings.

Switch 05, bit 1

0: Accept such messages

1: Reject such messages

### Rejecting or Accepting Messages from Specified Senders

This feature is called Authorized Reception. It helps you reject junk fax mail. It lets you specify which terminals you wish to receive fax messages from; all others will be shut out.

- 1 - You must specify a list of senders (function 81). See page 54.
- 2 - You must turn Authorized Reception on (function 62). See page 56.
- 3 - You must set your machine to accept or reject messages from senders in that list (user parameters, switch 08, bit 2 and 3; see page 56).

If you *accept* them, the general public will not have access to your fax machine. You accept messages only from a group of people you know.

If you *reject* them, everyone will be able to send you messages *except* the people in the list. This is useful to reject the junk fax mail.

You can store up to 30 identifications with this feature. You can program part of an identification and accept (or reject) messages from all senders whose identification contains that part. See Wild Cards, page 159.

List of the Authorized Senders (Function 81)	Authorized Reception on/off (Function 62)	Accept messages from special terminals listed or not listed (Function 63)	Result
Empty	On	Either	No messages are accepted.
Empty/Not empty	Off	Either	All messages are accepted.
Not empty	On	Listed	Only messages from special terminals are accepted.
Not empty	On	non-listed	All messages are accepted <b>except</b> from special terminals.

## Creating & Editing the List of Authorized Senders (Function 81)

### *Creating the List of Authorized Senders*

- 1** Press **Function, 6** and enter the access code **2 2 2 2**. Then, press **8, 1**, and **Yes**.

```
SETTING?          Y/◀▶
PRINT LIST◀/SEARCH▶
```

(At this time, you can print an Authorized Reception List by pressing ◀ and **Start** if it has already been created.)

- 2** Press **Yes** again.

```
RTI/CSI          ABC  ◀▶
████████████████████
```

- 3** Enter the sender's RTI or CSI. For example, enter "XYZ COMPANY". How to enter characters, see page 130.

```
RTI/CSI ABC      Y/N
XYZ COMPANY
```

- 4** Press **Yes**.

```
RTI/CSI          Y/N
STORE AS WILD CARD?
```

- 5** To store this as a wild card, (see glossary) press **Yes**, otherwise press **No**. The word PRO--GRAMMED will appear briefly. And you'll see:

```
RTI/CSI          ABC  ◀▶
████████████████████
```

- 6** Go back to step 3 to enter another RTI or CSI or press **Function** if you are done.

*Editing the Authorized Senders*

- 1** Press **Function, 6** and enter the access code **2 2 2 2**. Then, press **8, 1**, and **Yes**.

```
SETTING?          Y/◀▶
PRINT LIST ◀/SEARCH ▶
```

- 2** Press ▶ to scroll the RTI/CSI. And the RTI/CSI you want to delete appears, press **Yes**.

```
RTI/CSI          ABC Y/N
XYZ COMPANY
```

- 3** Edit the RTI/CSI of the special terminal.  
◀ and ▶ to move the cursor.  
**Clear** to delete one character.  
**No** to delete the whole characters.  
How to enter characters, see page 130.

```
RTI/CSI          ABC Y/N
ABC COMPANY
```

- 4** Press **Yes**.

```
RTI/CSI          Y/N
STORE AS WILD CARD?
```

- 5** To store this as a wild card, (see glossary) press **Yes**, otherwise press **No**. The word `pro-`  
`grammed` will appear briefly. And you will see:

```
RTI/CSI          ABC ◀▶
████████████████████
```

- 6** Press **Function**.

*Erasing the Authorized Senders*

- 1** Press **Function, 6** and enter the access code **2 2 2 2**. Then, press **8, 1**, and **Yes**.

```
SETTING?          Y/◀▶
PRINT LIST ◀/SEARCH ▶
```

- 2** Press ▶ to scroll the RTI/CSI. And the RTI/CSI you want to delete appears, press **Yes**.

```
RTI/CSI          ABC Y/N
XYZ COMPANY
```

- 3** Press **No** and **Yes**.

- 4** Press **Function**.

### Switching Authorized Reception On or Off (Function 62)

Before you use Authorized Reception, you have to switch the feature on.

- 1** Press **Function, 6** and enter the access code **2 2 2 2**. Then, press **6, 2,** and **Yes**.

```

SELECT LINE          Y/NEXT▶
  
```

- 2** Press **▶** until the screen is as shown at right.

```

                Y/NEXT▶
AUTHORIZED ON/OFF
  
```

- 3** Press **Yes**.

```

AUTHORIZED          Y/◀▶
▶ON      OFF
  
```

- 4** Press **◀** or **▶** to change the on or off setting.

- 5** Press **Yes** and **Function**.

### Accepting or Rejecting Messages From Senders in the List

You can select accepting or rejecting messages from senders in the list. Follow the user parameter procedure on page 121 to enter the following settings.

Switch 08, bit 2

You have to set it "1"

Switch 08, bit 3

0: Accept calls from senders in the list of special terminals.

1: Reject calls from senders in the list of special terminals.

### Hints for Using Authorized Reception

You must specify the sender's identification code (their CSI or RTI, see page 146) which could be a little different from their phone number.

To get the other party's identification, call and ask for their CSI or RTI code. Explain that you need the number programmed into their fax machine for identification purposes. Or, attempt a communication with their fax machine and print out a transaction confirmation report (function 41, see page 49). Read the identification under the RTI or CSI heading of the report.

## Saving Energy

Laser printing requires the application of heat to bond toner to the printer paper. For incoming messages to be output quickly, a heating element inside the machine must be kept hot. Keeping the fusing unit at the correct high temperature uses electricity. To overcome this waste of energy your machine is equipped with an energy saving feature.

If your machine is left idle for 5 minutes (or if you hold down the **Energy Saver** key for 2 seconds) the heating element will cool. You have three choices: You can let the machine cool to room temperature, you can let it cool halfway or you can let it fully on.

The messages in the display will disappear.

Letting the heating roller cool to room temperature will reduce the amount of electricity the fax machine consumes. However, the fax machine will need to warm-up before it can print out anything. It takes about 30 seconds or less to warm up. Adjust the user parameters to match the settings below (see page 121)

Letting the heating roller cool halfway is not as economical as letting it cool to room temperature, but incoming fax messages and copies can be printed soon after the heating element becomes hot. It takes about 20 seconds or less to warm up. At the factory, this mode is set.

Letting the heating roller fully on is not as economical as other two modes, but incoming fax messages and copies can be printed can be printed right away. Adjust the user parameters to match the settings below (see page 121)

Switch 05 bits 6 & 7

Letting the heating roller cool to room temperature: Bit 6 at 0, Bit 7 at 0

Letting the heating roller cool halfway: Bit 6 at 1, Bit 7 at 0

Leaving the heating roller fully on: Bit 6 at 0, Bit 7 at 1

## Saving Energy with the Night Timer

The Night Timer feature lets you program timers to switch the heating element on and off. There are two differences between the energy saver described above and the night timer:

- If a fax message comes in while the night timer has switch off the heating element, the message is stored in the memory. It is printed only when the heating element is switched back on.

- The night timer switches the heater off completely, but the energy saver can also switch it to a midway temperature (see above).

If you wish to print a fax message while the heating element is off, you can temporarily override the timer and print the message. Just press the **Energy Saver** key. The timer will activate again automatically a few minutes after you have printed your message.

As a typical example, you could program the heating element inside the printer to stay off at night and over the weekend. (You can program different settings for every day of the week.)

To use the Night Timer, you must:

1. Program the timers for each day of the week.
2. Switch the Night Timer feature on.

#### *Setting the Timer (Function 71)*

**Caution:** While the heating element is disabled, all incoming calls are refused when the memory fills up.

**Example:** For Tuesday, set the Night Timer to switch the heater on at 9 am and off at 6 pm.

- 1** Press **Function, 6** and enter access code **2 2 2 2**. Then, press **7,1** and **Yes**.

```
SET NIGHT TIMER      Y/N
```

- 2** Press **Yes**.

```
SET TIMER           Y/N/◀▶
SUN
```

- 3** Use the **◀** and **▶** keys to scroll through the days of the week. Example: Press **▶** twice to go to Tuesday.

```
SET TIMER           Y/N/◀▶
TUE
```

- 4** Press **Yes**.

```
TIMER#1 TUE   */#/Y
ON FROM 12:00AM
```



**5** There are two timers for each day, each with an ON/OFF setting. "ON" means that the heater will switch on at the time indicated. "OFF" means that the heater will switch off at the time indicated. To change the ON to OFF, or the other way round, press \* or #. When the ON/OFF display is correct: Go to step 6.

**6** Press **▶** to move the cursor under the time.

```
TIMER#1 TUE  */#/#/Y
ON FROM 12: 00AM
```

**7** Input the time(9:00 AM): Press **0**, **9**, **0**, and **0** from the key pad.

```
TIMER#1 TUE  */#/#/Y
ON FROM 09: 00AM
```

**8** Set AM/PM using \* or #.

```
TIMER#1 TUE  */#/#/Y
ON FROM 12: 00PM
```

**9** Press **Yes**.

```
TIMER#2 TUE  */#/#/Y
ON FROM 12: 00AM
```

**10** Repeat step 5 for the second timer (6:00 PM)  
To change AM to PM or the other way around, press # .

**Tip:** If you want the heater on all day, set both timers to ON = 12:00AM. If you want the heater off all day, set both timers to OFF = 12:00AM.

**11** Either press **Yes** and **Function** to finish, or go back to step 3 to program the timer for another day.

*Switching the Night Timer On or Off (Function 62)*

The Night Timer feature must be switched on using Function 62.

- 1** Press **Function, 6** and enter access code **2 2 2 2**. Then, press **6, 2** and **Yes**.

```

SELECT LINE          Y/NEXT▶
  
```

- 2** Scroll through the list of features with ▶ until the screen is as shown opposite.

```

                Y/NEXT▶
NIGHT TIMER ON/OFF
  
```

- 3** Press **Yes**.

```

NIGHT TIMER      Y/◀▶
ON      ▶OFF
  
```

- 4** Change the on/off setting by pressing ◀ or ▶.

```

NIGHT TIMER      Y/◀▶
▶ON      OFF
  
```

- 5** Finish: **Yes** and **Function**.

## Printing the Sender's Identification

This feature *prints* at the top of the message, the sender's identification (the CSI or RTI, see page 159) that appears on the display. This is useful if you receive messages that don't include identification at the header. Follow the user parameter procedure on page 121 to enter the following setting.

Switch 02, bit 3

0: Don't print the identification code

1: Print the identification code

## Tonal Signals

If your machine is set for a pulse line, it will generate pulses rather than tones. This feature allows you to generate tones from the keypad when your machine is set for pulse dialing. Before you can use this feature, you must program **Quick Dial 19** as the tone key (see below). If your machine is already set for touch tone dialing, you do not need this feature at all.)

To use the feature, dial the other party, then after you are connected, press the tone key (Quick Dial 19) and dial numbers as needed. Once done, hang up.

### If You Have the Optional Handset or Your Own Touch Tone Phone

This will let you to keep Quick Dial 19 for storing a fax number. If you do this, don't forget to switch the handset back after you're done.

### Setting Quick Dial 19 as the Tone Key.

**1** Press **Function, 3, 1,** and **Yes.**

```

 QUICK<>
PRINT LIST</SEARCH>
    
```

**2** Press **Quick Dial 19.**

```

19 PROGRAM? Y/<
    
```

**3** Press **Yes.**

```

19 Y/N
PROGRAM TONE KEY?
    
```

**4** Press **Yes** again. Quick dial 19 can now be used as the Tone key.

## Things a Service Technician Can Change

### Sending Reliably vs. Sending More Cheaply

Your machine uses one of two methods for correcting errors in transmission due to bad lines: Error Correction Mode (ECM) or Page Retransmission. Page Retransmission does not work with Immediate Transmission but ECM does. ECM is turned on at the factory.

ECM is more efficient, because it only resends the damaged parts of the transmission, but the number of retransmission attempts is much higher. If you wish reliable communication and do not mind paying extra communication charges when you get a poor line, keep ECM switched on.

Pages can be sent up to 3 times before the machine gives up. If you wish to change the number of retries, contact a service technician.

### Protection Against Wrong Connections

This feature prevents accidentally connecting you to the wrong fax terminal. However, it does not help you if you dialed the wrong number yourself. Also, you will be unable to send messages to a phone number that forwards the connection elsewhere.

Your machine compares the number that you dialed with the identification received from the other end. This identification (called a CSI, see page 146 ) corresponds to the other party's fax number *as they've stored in in their machine*. Only the last 8 digits are checked, spaces and pauses in the telephone number are ignored. If the CSI is not the same as the telephone number, the transmission is stopped.

**Note:** If you cannot send a message to a certain location using this feature, contact the other end and make sure that they have stored the phone number identification (the CSI) correctly.

This feature has to be switched on by a service technician.

# COPYING

## Basic Copying Procedure

**CAUTION** If your document gets stuck while it is being processed, press the Stop key, and turn to page 102 for instructions on how to safely remove the original. If you make a mistake and want to start over, press the Clear Modes key.

- 1** Make sure your machine is set to copy. If it isn't press the **Fax/Copy** key. The Copy light will be lit.

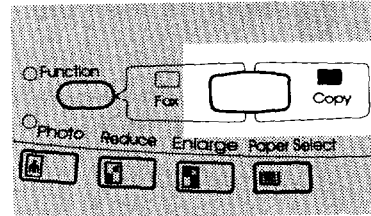

- 2** Lift up the top cover (make sure you raise it by at least 35°, or half way) and place the first page of your document face down on the exposure glass. Then lower the top cover.

COPY READY      ▶LT ⬇  
100%                      LG ⬇

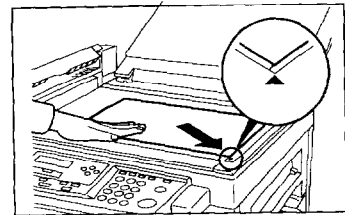

The display will change as shown.

COPY READY      ▶LT ⬆ ▲  
100%                      LG ⬆ ▼

**Or**

Insert the document face up in the feeder and adjust the guides to fit the width of the document. There should be no more than 30 pages in your document.

**Note:** Do not stack documents in the feeder so that they exceed the load limit marker.

When you set the document in the feeder, the display will change as shown.

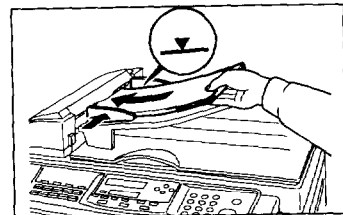

ADF COPY              ▶LT ⬆ ▲  
100%                      LG ⬆ ▼

## Selecting the Paper Size

### Manual Paper Select

The manual selection mode is useful when you wish to select the copy paper size yourself.

Press **Paper Select** or ▲ ▼ to select the size you require. The current selection is indicated by a ►.

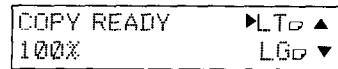
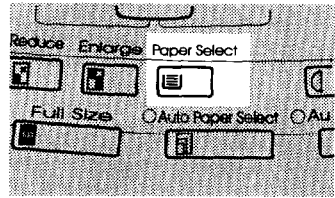

### Auto Paper Select

The machine automatically selects the appropriate copy paper size, based on the original's size and the reproduction ratio that you selected.

Light the **Auto Paper Select** indicator pressing the key.

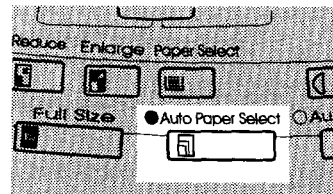

**Note:** You cannot choose this function when using the auto document feeder or the bypass.

## Copying/Printing Using the Bypass

Use the bypass feed table for the following types of copy paper.

- Paper of a different size from those currently in the paper trays
- Paper of non-standard size or weight, such as OHP transparencies, adhesive labels, or postcard.

Load one sheet at a time onto the bypass feed table.

**Caution:** Do not put paper on the bypass feed table while printing is in progress. Wait for the page to finish printing before placing the next sheet.

### Usage condition

Paper weight: 16 to 24lb

Width: 4.0" to 10.1"

Length: 5.8" to 14.3"

### How to Use the Bypass

- 1** Insert the sheet with the printing side down. The edge should touch the right side of the entrance. Then slide the guide of the left side.

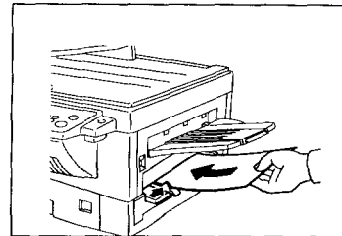

Make sure that the paper has advanced into the manual feeder.

**Note:** If a paper is left in the manual feeder for 3 minutes, it will be fed out automatically.

- 2** To enter the paper size, press **▶**.

**Note:** If you do not enter the paper size, the back side of next paper might be dirty.

- 3** Press **Yes**.

```
COPY READY      SIZE▶
100%             ▶BYPASS FEED
```

```
SET COPY OPTION  Y/▶
PAPER SIZE
```

```
PAPER SIZE      KPAD/Y
WIDTH■■■■■■■■  ■■■■INCH
```

- 4** Enter the paper width. You can enter from 4.0" through 10.1"

PAPER SIZE	KPAD/Y
WIDTHS. SINCH	

Example:

5.4 inch; Press **5** and **4** of the ten key pad.

10 inch; Press **1**, **0** and **0** of the ten key pad.

- 5** Press **Yes**.

COPY READY	SIZE▶
100%	▶BYPASS FEED

- 6** Set the document and press **Start**.



**If you install the optional paper cassette**

- 1** Slide the side cassette cover into the machine.

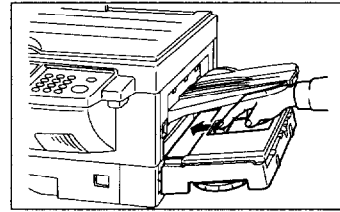

- 2** Insert the sheet with the printing side down. The edge should touch the far side of the entrance.

Make sure that the paper has advanced into the manual feeder.

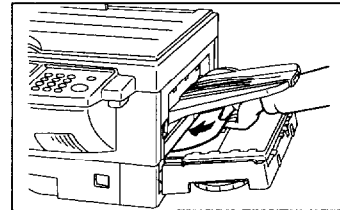

**Note:** If a paper is left in the manual feeder for 3 minutes, it will be fed out automatically.

- 3** Follow copying procedure in the above section titled "How to use the Bypass". After taking copy, slide the side cassette cover back (⇐).

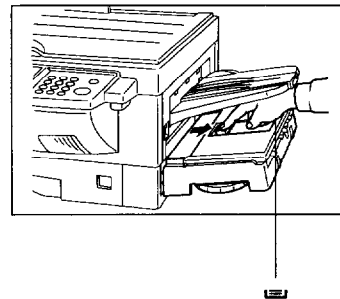

## Enlarging & Reducing

### Selecting a Magnification Ratio

- 1** Set the document. (See page 63.)
- 2** Press the **Reduce** or **Enlarge** key repeatedly to reach the desired ratio.

Enlargement ratios:  
121, 129, 155, and 200%.  
Reduction ratios:  
50, 65, 74, 77, and 93%

Press the **Full Size** key to return to 100%.

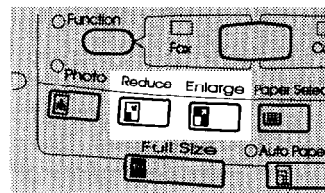

- 3** Follow the the standard copying. See page 63.

### Which Ratio Do I Choose?

The preset ratios will enlarge or reduce from one standard size to another, or they will allow you to create a border around the copy without losing any part of the original image. For example 129% enlarges a half-letter document to a letter size copy, while reducing a letter document 93% will ensure the entire document will be reproduced, including the border area.

#### Reduction ratios

50%  
65%: Letter to half letter  
74%: 10.1"x14.3" to letter  
77%: Legal to letter  
93%: Create a margin

#### Enlargement ratio

121%  
129%: Half letter to letter  
155%: Half letter to legal  
200%

## Copying Darker or Lighter Originals

### Manual Image Density Mode

**1** Set the document. See page 63.

**2** Press either **Lighten** or **Darken**.  
There are 5 density levels in all.

If the **Auto Image Density** indicators is on, turn it off by pressing the **Auto Image Density** key.

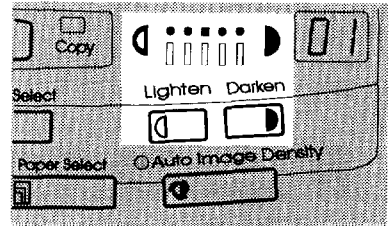

**3** Follow the the standard copying. See page 63.

### Auto Image Density Mode

Use this setting when you wish the machine to adjust the copy image density automatically to maintain a clear background.

**1** Set the document. See page 63.

**2** Make sure that the **Auto Image Density** indicator is lit.  
 If it is not, press the **Auto Image Density** key.

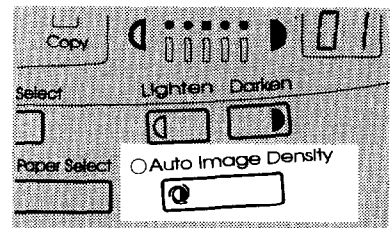

**3** Follow the the standard copying. See page 63.

### Combination Setting

Use this setting if you wish to make minor adjustment to the copy image density that was automatically selected by the machine.

- 1** Press the **Auto Image Density** key to turn on the Auto Image Density indicator.

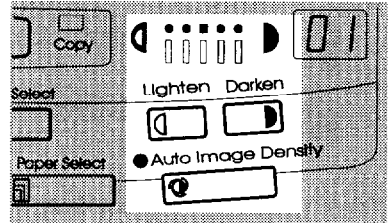

- 2** Press the **Manual Image Density** key to select the image density level.

## Copying Photographs

If your document contains a photograph, or diagrams with complex shading patterns or grays, switch Photo Mode on to achieve optimum image quality.

**1** Set the document. (See page 63)

**2** Press the **Photo** and the Photo indicator will illuminate.

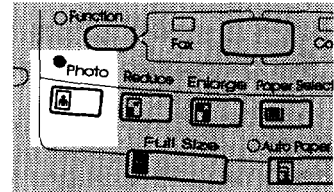

**3** Follow the the standard copying procedure. See page 63.

**4** Press **Start**.

Note: You cannot select the Auto Image Density with the Photo mode.

## Clearing the Previously Used Settings

All previously entered settings and modes will be automatically cleared three minutes after finishing copying. However, if you need to clear all modes immediately, press the **Clear Modes** key.

## Options

The option key lets you set several features.

### Sort Copy

Normally, the machine prints in the reverse order set in the feeder.

With sort copy function, the machine will collate the sequence by printing from the last page first collated.

This feature is available when the FAX EXPANSION CARD is installed.

This feature is available only when you make copies using the feeder. The maximum size document that you can sort depends on how much memory is installed.

1Mb FAX EXPANSION CARD: 48 pages (letter size)

2Mb FAX EXPANSION CARD: 78 pages (letter size)

4Mb FAX EXPANSION CARD: 138 pages (letter size)

- 1 Set the document to the feeder.

```
ADF COPY      ▶LT ⬇ ▲
100%          LG ⬇ ▼
```

- 2 Press the option (▶) key until the opposite display appears.

```
SET COPY OPTION  Y/▶
SORT COPY
```

- 3 Press **Yes** to set the option.

```
SORT COPY      Y/◀▶
ON             ▶OFF
```

**Note:** If you set the document on the exposure glass, the display indicates as shown.

Remove the document from the exposure glass and set it to the feeder.

```
USE ADF
```

- 4 Press ◀ to turn Sort Copy on.

```
SORT COPY      Y/◀▶
▶ON            OFF
```

- 5 Press **Yes** to accept the setting.

```
COPY READY     LT ⬇ ▲
100%          LG ⬇ ▼
```

- 6 Follow the standard copying procedure. See page 63.

## Erase center

When taking copies from a book, you can erase the shadow caused by a spine that won't lie flat on the glass. Adjust the width of the center column to be erased if necessary. This feature is available only when you set the document on the exposure glass.

**Note:** Erasing center is not successful with document sizes other than letter or legal.

Scanning direction

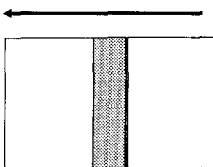

The shaded part will be erased.

- 1** Set the document.
- 2** Press the option (▶) key until the opposite display appears.
- 3** Press **Yes** to set the option.
 

**Note:** If you set the document on the feeder, the display indicates as shown.  
Remove the document from the feeder and set it to the exposure glass.
- 4** Press ◀ to turn Erase Center on.
- 5** Enter a number between 0.2 & 2.0.  
Example: 0.3 inch, press 3.  
1.5 inch, press 1 and 5.

```
SET COPY OPTION  Y/▶
ERASE CENTER
```

```
ERASE CENTER  Y/N/◀▶
ON           ▶OFF 0.4 INCH
```

```
USE EXPOSURE GLASS
```

```
ERASE CENTER  Y/N/◀▶
▶ON           OFF 0.4 INCH
```

```
ERASE CENTER  Y/N/◀▶
▶ON           OFF 0.3 INCH
```

- 6** Press **Yes** to accept the setting.

```
COPY READY      LT◀ ▲
100%            LG◀ ▼
```

- 7** Follow the standard copying procedure. See page 63

**Erase border**

Erasing border lets you create a white border around the copy. Adjust the width of the blank margin left around copies. This feature is available only when you set the document on the exposure glass.

**Note:** Erasing border is not successful with document sizes other than letter or legal.

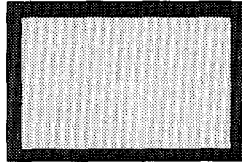

The shaded  area will be erased.

**1** Set the document to the exposure glass.

**2** Press the option (▶) key until the opposite display appears.

```
SET COPY OPTION  Y/▶
ERASE BORDER
```

**3** Press **Yes** to set the option.

```
ERASE BORDER  Y/N/◀▶
ON      ▶OFF  0.2 INCH
```

**Note:** If you set the document on the feeder, the display indicates as shown.

```
USE EXPOSURE GLASS
```

Remove the document from the feeder and set it to the exposure glass.

**4** Press ◀ to turn Erase Border on.

```
ERASE BORDER  Y/N/◀▶
▶ON      OFF  0.2 INCH
```

**5** Enter a number between 0.2 & 2.0.

```
ERASE BORDER  Y/N/◀▶
▶ON      OFF  .3 INCH
```

Example: 0.3 inch, press 3.  
1.5 inch, press 1 and 5.

**6** Press **Yes** to accept the setting.

```
COPY READY      LT◻ ▲
100%            LG◻ ▼
```

**7** Follow the standard copying procedure (See page 63).



## Number Copies

When making several copies of a document, this feature identifies each copy with a different number. This feature is not available when you use the bypass feeder.

The control number will be printed as following diagram.

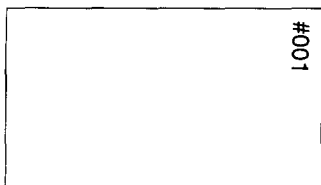

### Example

If you enter the starting number 20 and make 10 copies, each copy has its number as "#020, #021, #022.....#029".

- 1** Set the document.
- 2** Press the option (▶) key until the opposite display appears.

```
SET COPY OPTION  Y/▶
NUMBER COPIES?
```

Press **Yes** to set the option.

```
NUMBER COPIES Y/N/◀▶
ON      ▶OFF FROM 001
```

- 3** Press ◀ to turn Number Copies on.

```
NUMBER COPIES Y/N/◀▶
▶ON      OFF FROM 001
```

- 4** Enter the starting number using the ten key pad.

**Example:**

If you want start the number from "#012", press 1 and 2.

- If you enter the wrong number press **No** or **Clear** and enter the correct number.

```
NUMBER COPIES Y/N/◀▶
▶ON OFF FROM 012
```

**Clear** to delete the one digit.

**No** to delete the whole number.

- 5** Press **Yes** to accept the setting.

```
COPY READY LT◀ ▲
100% LG◀ ▼
```

- 6** Follow the standard copying procedure (See page 63).

### Center marks

Prints small triangular center marks at the top and left sides. These allow you to accurately center your copies when punching holes in them.

This features is not available when you use the bypass feeder.

**1** Set the document.

**2** Press the option (▶) key until the opposite display appears.

```
SET COPY OPTION  Y/▶  
CENTER MARKS
```

**3** Press **Yes** to set the option.

```
CENTER MARKS  Y/◀▶  
ON  ▶OFF
```

**4** Press ◀ to turn Erase Center on.

```
CENTER MARKS  Y/◀▶  
▶ON  OFF
```

**5** Press **Yes** to accept the setting.

```
COPY READY  LT◻  
100%
```

**6** Follow the standard copying procedure.(See page 63.)

---

# MAINTAINING YOUR MACHINE

## Setting / Adding the Paper (📄)

Before you use the machine, set the paper in the cassette.

And when the Add Paper indicator (📄) on the operation panel is lit, the drawer or optional side cassette is empty. To add paper to the side cassette option, see appendix B, on page 152.

**Caution:** To avoid dropping the drawer, hold it by the front and side while pulling it out.

**Caution:** Keep unused indicator plates. The plate actuates the proper inner switch for the indicated paper size.

**Caution:** Make sure the paper conforms to the specifications on page 131.

**1** Slide the drawer all the way out, and place it on a large flat surface. Remove the paper if you change paper size.

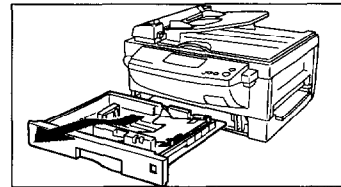

**2**\* Squeeze in the green button on the side fence and move the fence to the appropriate paper\* size.

If you aren't changing the paper size, skip this step and all others marked with an asterisk.

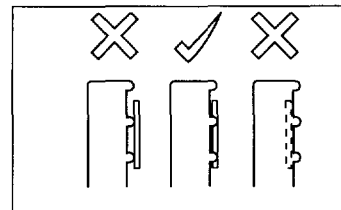
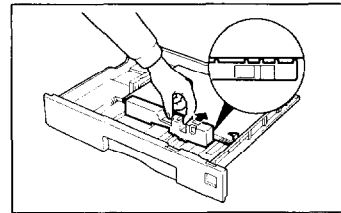

- 3** \* Pinch in the green lever on the rear fence and slide it until it matches the paper size printed on the base of the tray. Release the lever making sure it fits in the groove.

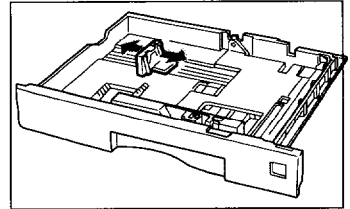
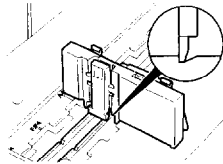

- 4** Flex the new stack of paper a few times.

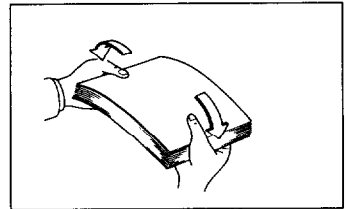

- 5** Press the plate (or paper when you add paper) until the bottom plate locks itself.

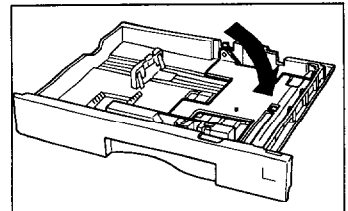

- 6** Put the stack in the drawer. Do not fill the drawer past the load limit marker and make sure the stack of paper fits under the corners. Push the side and rear fence toward the paper.
- Note:** If there is space between the paper and fences, carefully move in each fence until it is flush with the paper.

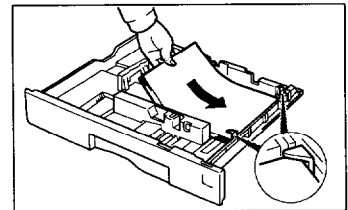

- 7** \* Pinch the paper size indicator plate, push it up, and slide it out.

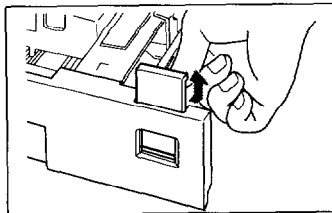

- 8** \* Slide in the plate for the new paper size.

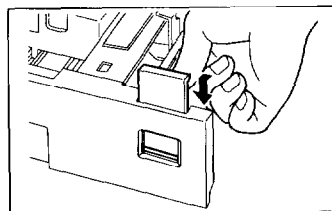

- 9** Replace the drawer in the machine.

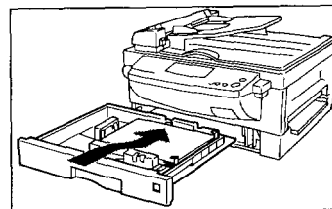

## Setting/Adding Paper in the Optional Side Paper Feed Unit

- 1** Slide out the paper feed unit until it stops. With both hands, remove it by holding it up and lifting it out at the same time.

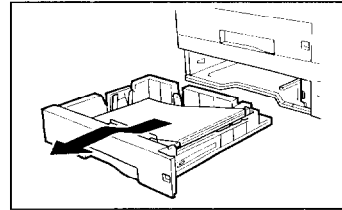

- 2** Press down the metal base plate/paper until it clicks into place.

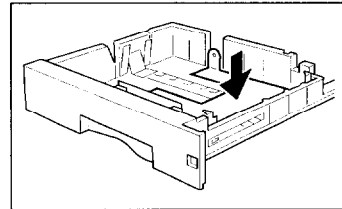

- 3** \* Pull out the paper.  
If you aren't changing the paper size, skip this step and all others marked with an asterisk.

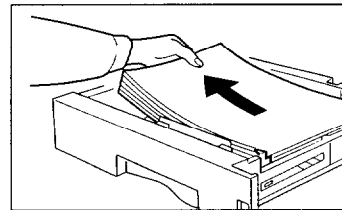

- 4** \* Adjust the paper fences to the paper size. To move a fence, pinch the top lever in and slide the fence in or out as shown.

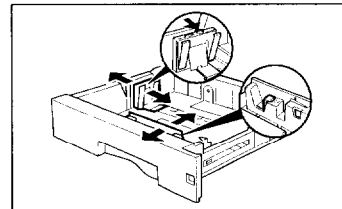

Make sure the positions of the two side fences match the paper size by checking them against the scale printed on the bottom of the feed unit. The fences should be aligned so that the inside edge of each fence is just touching the line of the scale.

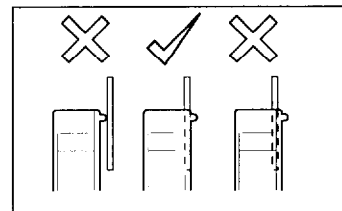

Make sure the fence is set in the groove on the paper cassette.

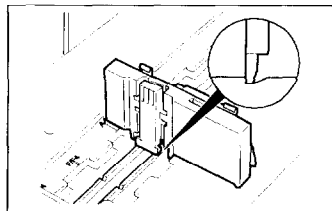

- 5** \* Change the paper size plate (located at the front of the feed unit). To remove an existing plate, push in the tab at the base while lifting the plate out from above (see diagram). Insert a plate with the appropriate paper size engraved on the front.

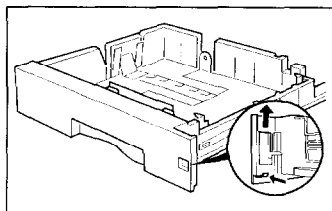

- 6** Fan the paper. Make sure the edges are uniformly aligned and place the paper into the unit with the side on you wish to print face up. Check the paper fits under the metal corners.

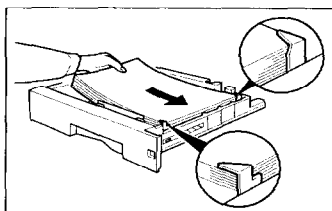

- 7** If there is space between the paper and fences, the paper will not be fed properly. To avoid this, carefully move in each fence until it is flush with the paper. Do not fill up the cassette past the load limit marker.

- 8** Replace the feed unit to its original position.



**Storage Condition of the Copy Paper**

- 16 to 24 lb. copy paper is recommended: letter or legal sizes are the most commonly used
- Do not use damp paper, or copies will be defective.
- Do not touch copy paper if your fingers are wet or oily; fingerprints may appear on the copy.
- Keep paper in a vinyl bag if it will not be used for a long time.
- Store in a cool dry place.
- Store flat. Do not stand upright.
- The following materials cannot be used in the paper cassettes : Post cards, Tracing paper, OHP sheets, Adhesive labels
- Do not overload the paper trays.
- If multi-sheet feeding occurs or dog-eared copies are made when using recycled paper in the paper cassette, fan the recycled paper and load it in the paper cassette again.

## Replace Toner Cassette & Cleaning Pad

When the Add Toner indicator (🔴) starts to blink, the toner cassette is almost empty. You will be able to make 100 more copies before you have to change it. When the indicator remains lit, it is time to install a new toner cassette. And replace the cleaning pad at the same time. The cleaning pad cleans the fusing roller. When the indicator starts to blink, prepare a new toner cassette.

**WARNING:** Do not incinerate waste toner or depleted cassettes. Toner dust might ignite suddenly if exposed to flames.

**Caution:** Lift the toner cartridge by the holes on top.

**Caution:** Do not touch any parts other than those specified in the procedure.

**1** Open the top unit and lift it until it lock in place.

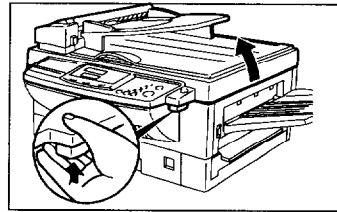

**2** Put your thumbs in the holes and carefully slide out the old toner cassette without shaking it.

**Caution :** Never touch the photoconductor under the toner cassette (green drum).

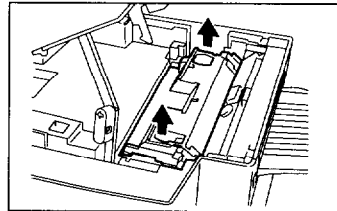

- 3** Shake the new toner cassette before installing it.

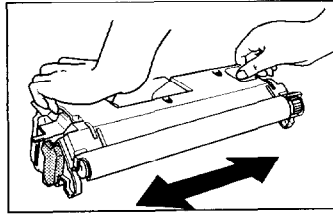

Unpack the new toner cartridge. Pull out the sheet of the new toner cassette.

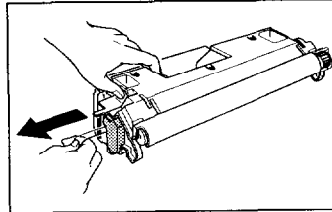

And remove the black sheet.

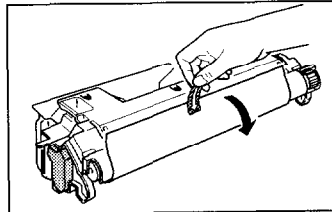

- 4** Slide the toner cassette into the machine as far as it will go. Gently push down the cassette to secure it in place.

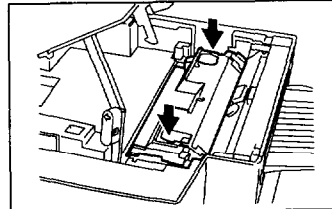

- 5** Remove the old cleaning pad.

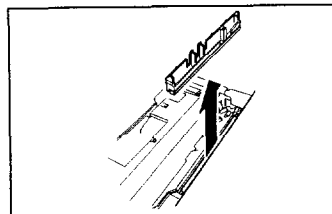

## MAINTAINING YOUR MACHINE Replace Toner Cassette & Cleaning Pad

- 6** Install the new cleaning pad.  
Match the position of the arrow on the cleaning pad with the arrow on the inside the machine.  
**Note:** Push the cleaning pad until you hear it clicking.

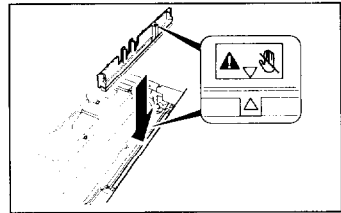

- 7** Push the lever arm inwards lifting up the top unit, let the top unit sink slowly in place, and press down to lock it.

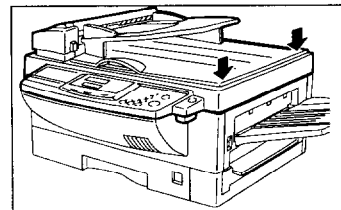
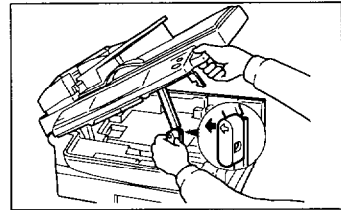

### Storage Condition of the Toner Cassettes

- Store in a cool, dark place.
- Never store where they may be exposed to heat.
- Keep out of the reach of children.
- Do not eat toner.
- Do not lay heavy objects on toner cassettes.
- Do not incinerate toner or toner containers. Toner dust may cause flash-back when exposed to an open flame.

## Replacing the Photoconductor Drum

The photoconductor receives the print image before it is transferred to paper. To ensure optimal quality, replace them every 30,000 copies.

If the following display appears, replace the photoconductor.

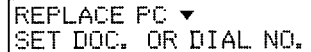

REPLACE PC ▼  
SET DOC. OR DIAL NO.

To check how many sheets you've printed, please refer the section titled "Counters" (See page 52.)

**Caution:** Do not expose the photoconductor drum to light for an extended period.

**Caution:** Do not touch or scratch the drum: it cannot be repaired. Any scratch on the drum would be reproduced on prints.

**Caution:** Do not touch any parts other than those specified in the procedure.

**Caution:** Though organic photoconductor drums are safe for the environment, dispose of used drums according to local regulations.

**1** Remove the print tray.

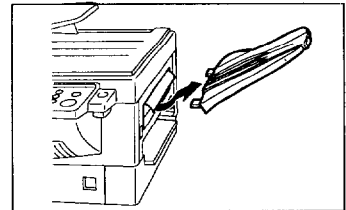

**2** Open the top cover unit and lift it until it locks in place.

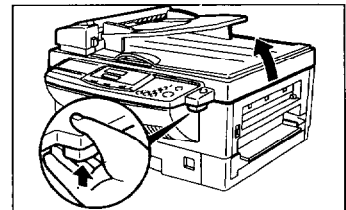

- 3** Open the side cover.

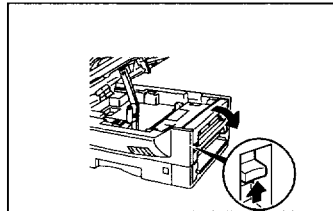

- 4** Put your thumbs in the holes and carefully slide out the old toner cassette without shaking it.

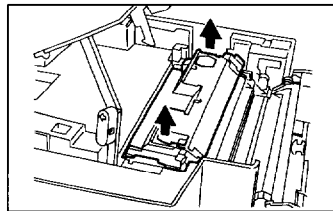

- 5** Remove the old photoconductor. Roll up the green plates on the old drum. Hold the used drum by the plates and carefully pull it out.

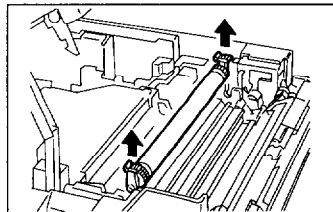
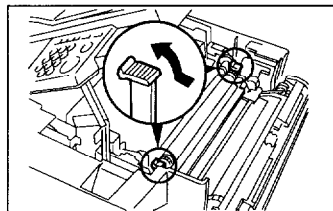

**Caution:** Do not expose the new drum to light for an extended period of time. Do not touch the surface of the drum.

- 6** Put the drum as shown in the illustration with the plate marked "R" at the rear of the machine. And remove the sheet of the photoconductor.  
**Caution:** Never touch surface on the photoconductor. (Green drum)

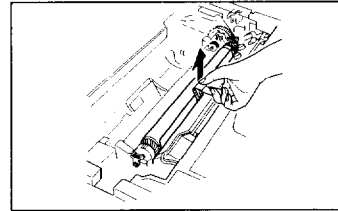
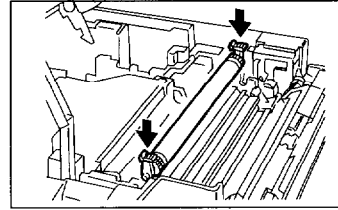

- 7** Turn the lever by gently pushing it.

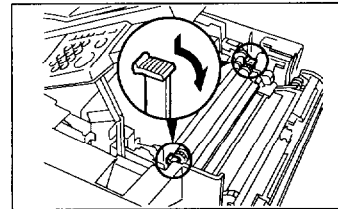

- 8** Reinstall the toner cartridge (see page 86).

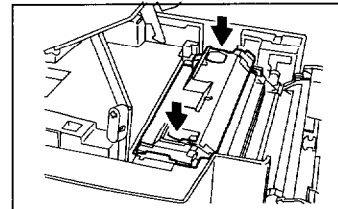

- 9** Close the side cover. Push the both end of the side cover until it clicks.

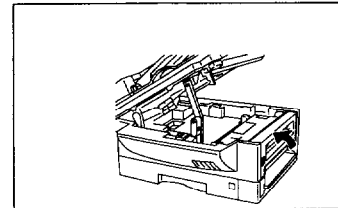

- 10** Push the lever arm inwards lifting up the top unit, let the top unit sink slowly in place, and press down to lock it.

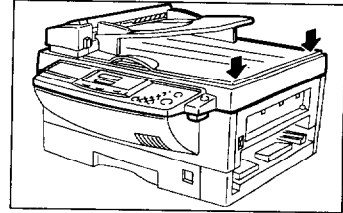
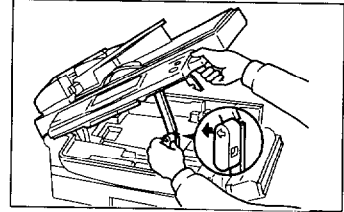

- 11** Reinstall the print tray.

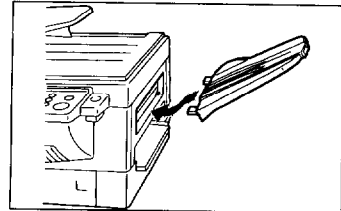

After you replace the photoconductor, reset the counter for photoconductor inside the machine.

If you have replaced the photoconductor before REPLACE OPC appears, see page 52 for how to reset the OPC counter (Function 94).

- 1** The display is shown as opposite.

```
REPLACE OPC ▼  
SET DOC. OR DIAL NO.
```

- 2** Press ▼.

```
REPLACE OPC?      Y/N
```

- 3** Press **Yes**.  
The counter resets.

```
READY 100% 10:00AM  
SET DOC. OR DIAL NO.
```



## Replacing the Stamp

When the marks made by the stamp becomes pale, replace the stamp as described below.

- 1** Push the ADF (auto document feeder) release button and pull up the ADF.

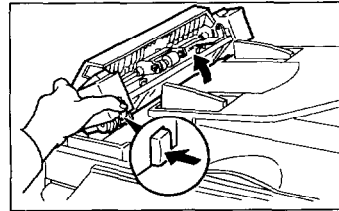

- 2** Take out the old stamp by tweezers. If tweezers are not available, you may press the point of a pencil down vertically into the stamp and remove it by lifting straight up. Replace the stamp as shown.

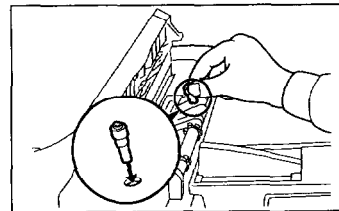

- 3** Close the ADF.

## Daily Maintenance

**Caution:** When wiping or cleaning components, do not use any sort of cleaning agent or abrasive powder. Use a damp soft cloth to clean and a dry soft cloth to wipe dry.

### Cleaning the exposure glass and the platen cover

- 1** Lift up the upper cover and clean the exposure glass with a clean dry cloth.

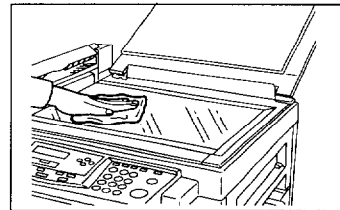

- 2** Clean the platen cover with a damp cloth and wipe it with a dry cloth. Use a weak cleaning solution if stains do not come off.

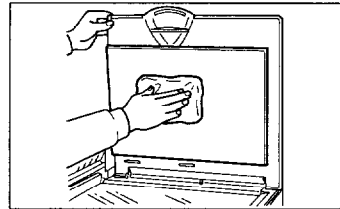

### Cleaning the ADF roller

**1** Open the ADF cover.

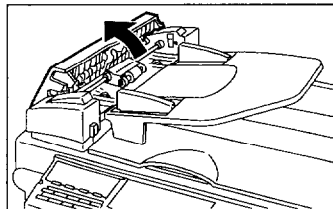

**2** Remove the feed unit.  
Push to the side, then pull it toward you.

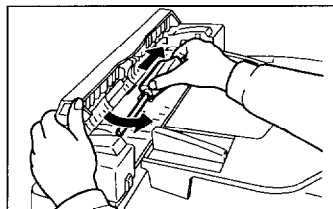

**3** Clean the feed roller and the separation rollers with a damp cloth.

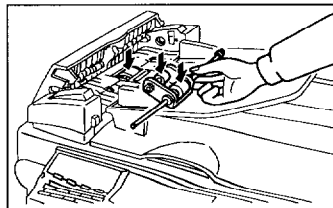

**4** Reinstall the feed unit.  
Push to the side then set the feed unit.

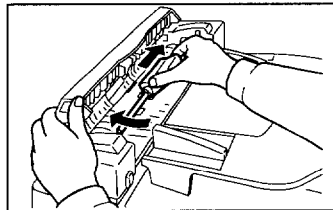

- 5** Close the ADF cover.

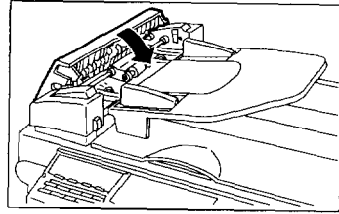

- 6** Lift up the top cover. And push the scanner release button and pull up the scanner.

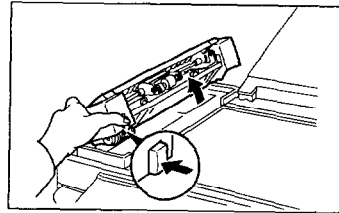

- 7** Clean the roller and white strip with a damp cloth then clean the exposure glass with a dry cloth.

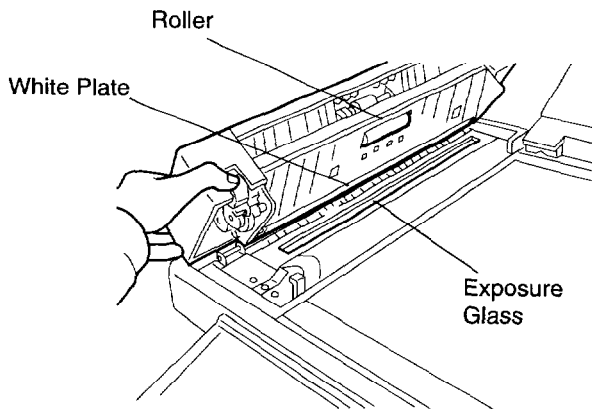

- 8** Close the scanner and lower the upper cover.

Cleaning the Paper Feed Unit Roller

**1** Open the side cover.

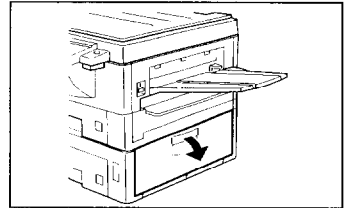

**2** Wipe 2 rollers.

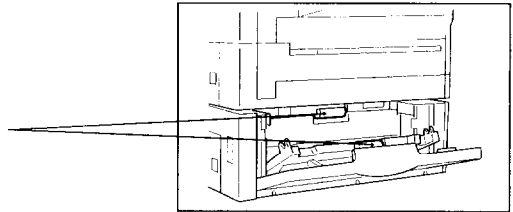

**3** Close the side cover.

**Cleaning the Corona Wire**

Please clean the corona wire on the toner cassette if the vertical black line appears on the printing image.

- 1** Open the top cover unit and lift it until it locks in place.

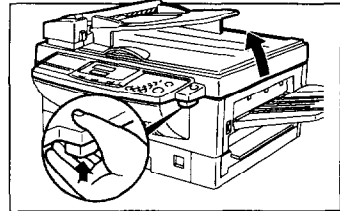

- 2** Put your thumbs in the holes and carefully slide out the old toner cassette without shaking it. And place it on a sheet of paper on a flat surface.

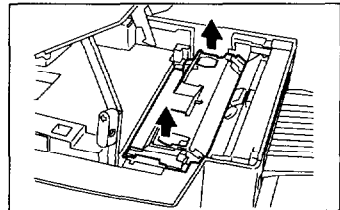

- 3** Gently drag the lever from end to end twice. Make sure that the lever returns to the original position after cleaning.

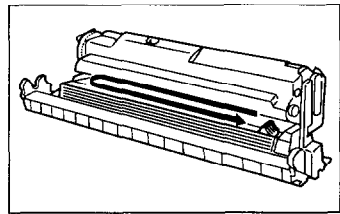

- 4** Reinstall the toner cassette.

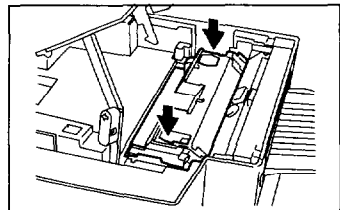

- 5** Push the lever arm inwards lifting up the top unit, let the top unit sink slowly in place, and press down to lock it.

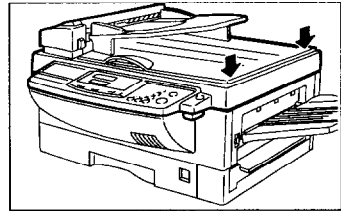
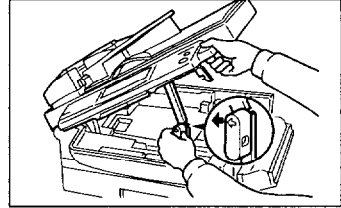

---

## Troubleshooting

**Caution:** Do not attempt to make any repairs other than those described in this manual. Removing covers may expose you to dangerous voltages and other risks. Refer all servicing to qualified personnel.

Check the indicators and the display panel. The indicators light if there are any problems. Check the description in the display.

### If an Indicator Lights Up on the Operation Panel

**If ERROR PRESS STOP KEY appears in the display:**

If the Communicating indicator is not lit, press **Stop**.

If the Communicating indicator lit, wait until it goes out, then press **Stop**.

**The Receive File indicator is lit:** You've received a fax message which is now stored in the machine. See page 16 for instructions on how to print it out.

**The Check Display indicator is lit:** Read the message on the LCD display and check the descriptions listed on page 114.

 **is blinking or lit:** You are either out of toner or about to be out of toner. See page 86 to change the toner cassette and the cleaning pad.

 **is lit:** You're out of paper. See page 80 for adding paper to the front cassette and see page 152 for adding paper to the side cassette.

One of the Printer indicators is lit: please refer to the Printer Interface Operator Manual for instructions.

### Other Possible Problems

**You want to take out the document**

Open the document feeder, and take out the document.

**Caution:** Do not pull out the document without opening the auto document feeder, or you will damage the scanning mechanism.



## Clearing a Document Jam

If CLEAR ORIGINAL appears in the display:

**Problem:** There is a document jammed in the feeder. Remove the jammed document and repeat the transmission procedure.

**Cause:** The document may be longer than the maximum limit (see the document specifications on page 131).

**1** Pull up and open the ADF cover.

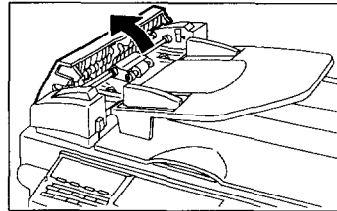

**2** Carefully take out the jammed original. Do not leave any pieces inside. Then close the scanner.

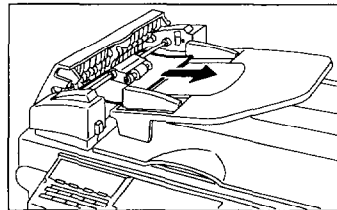

**3** If you can not remove the document, lift up the top cover. Then open the ADF unit pressing the ADF release button.

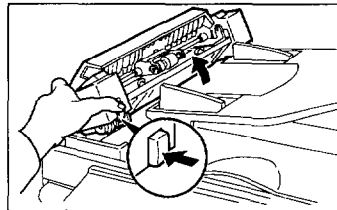

**4** Carefully take out the jammed original. Do not leave any pieces inside.

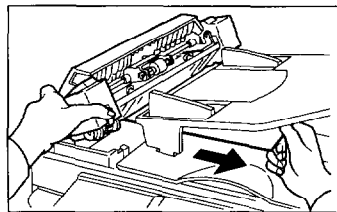

**5** Close the ADF unit and the ADF cover until it clicks.

## Copy, Fax, or Print Jams

If CLEAR COPY appears in the display, there is a copy jam. There are two possible locations: the drawer or the inside of the machine (including the copy feed-out area).

- 1** Remove the paper tray.

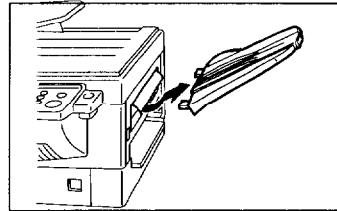

Remove the exit cover or optional paper cassette if the paper is jammed at the manual feeder or the cassette entrance.

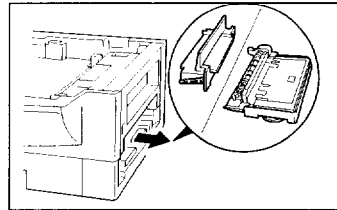

- 2** Open the top unit and lift it until it lock in place.

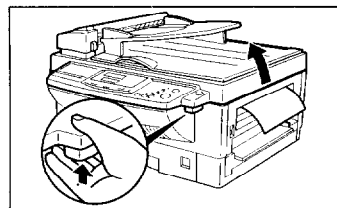

- 3** Open the side cover.

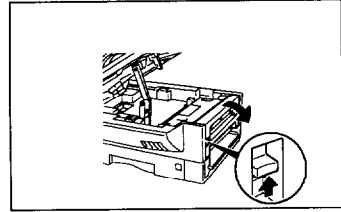

- 4** Pull out the jammed paper carefully.  
Toner may not be fixed to the paper. Be careful not to get any on your hands or clothes.

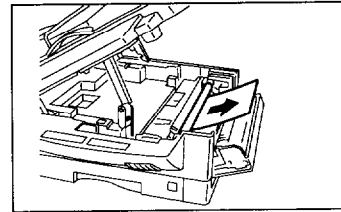

- 5** If you cannot remove the jammed paper, pull out the paper drawer completely and remove the jammed paper.

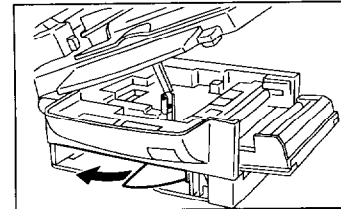

- 6** Push the stack of paper until it clicks. Make sure that the paper is under the corner.  
If there is space between the paper and fences, carefully move in each fence until it is flush with the paper.

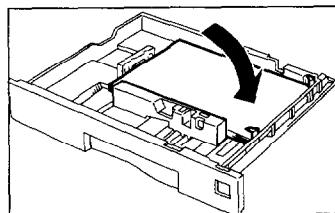

If there is space between the paper and fences, carefully move in each fence until it is flush with the paper.

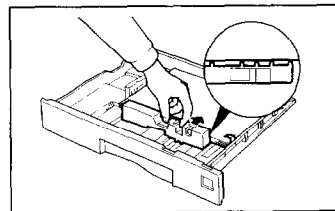

- 7** Set the paper cassette.

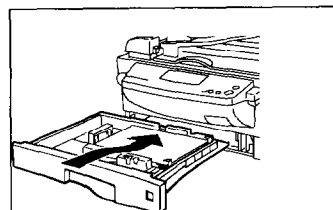

- 8** Close the side cover. Push the both end of the side cover until it clicks.

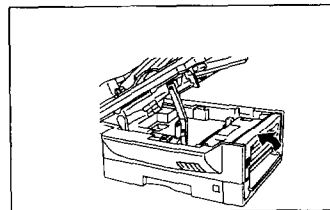

- 9** Push the lever arm inwards lifting up the top unit, let the top unit sink slowly in place, and press down to lock it.

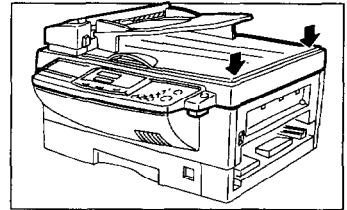
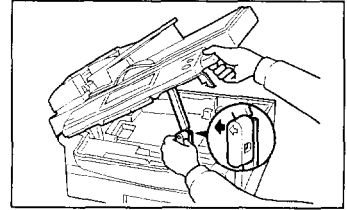

- 10** Reinstall the optional side cassette or the exit cover.

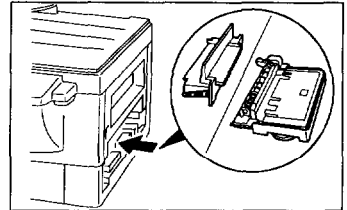

- 11** Replace the paper tray.

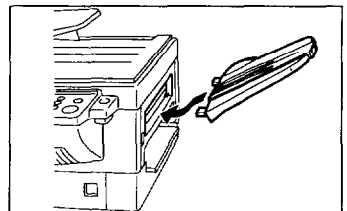

### Paper Jams in the Optional Front Paper Feed Unit

If the Paper Feed Unit is installed and you cannot remove the jammed paper as in the previous section, follow these procedure.

- 1** When  is lit, open the feed unit side cover.

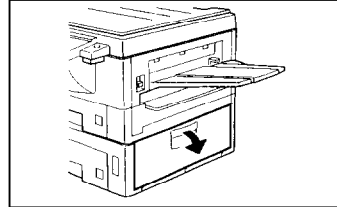

- 2** If there is any jammed paper, remove it.

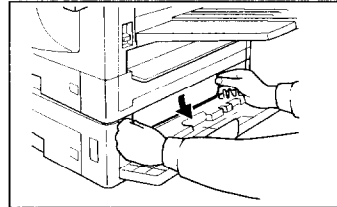

- 3** Close the side cover.

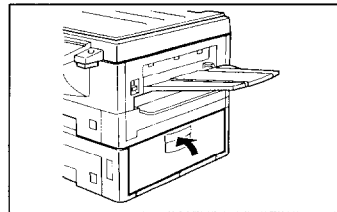

- 4** If you haven't managed to remove the jammed paper yet, pull out the paper feed unit. If there is any jammed paper, remove it.

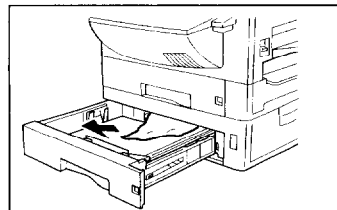

- 5** Press down the paper that is set in the unit until the bottom plate clicks. Make sure the paper fits correctly under the two metal corners.

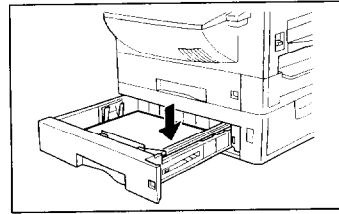

- 6** Replace the feed unit to its original position.

## If Messages You Receive Don't Fit on Your Paper

### Breaking Down Large Format Messages

If the incoming document is longer than the paper in your fax machine, the machine will split it into many sheets. The tail end of the message will be reproduced at the head of the next page. The images overlap each other by 0.4 inch. (You can ask a service technician to turn off the overlap.)

### Length Reduction

If the incoming document is too long but still within the limits below, the machine can reduce it so that it will fit on one page.

Paper size in the cassette	Maximum reducible length
Letter (11")	14.4"
Legal (14")	18.3"
Half letter (5 1/2")	7.5"

## Communication problems

If **PRESS STOP** appears in the display: Press **Stop**.

- Causes:**
- A poor line caused the communication to fail.
  - The line is busy or noisy. Try to retransmit.
  - The other machine is out of order. Ask the other party to check their machine.



## RDS (Remote Diagnostic System)

### Overview

If your machine has a problem, a service technician can perform various diagnostic tasks over the telephone line from the service station to try to find out what is wrong with your machine. The service technician can also use RDS to change some of your machine's settings if you request it.

For RDS to work, you must switch it on before the service technician starts the RDS operation on your machine.

For some RDS operations, it may be necessary for you to stay near the machine.

### Switching RDS On/Off

Before your machine can accept incoming calls from an RDS, you have to switch RDS on using Function 62. If it is switched off, the machine will not accept treatment from an RDS.

- 1** Press **Function, 6**, and enter the access number on page 121. Then press **6, 2**. And press **Yes**.

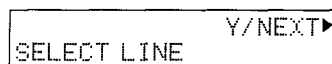

SELECT LINE Y/NEXT▶

- 2** Scroll through the list of features with ◀ and ▶ until the screen is as shown opposite.

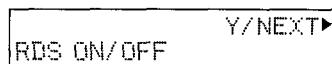

RDS ON/OFF Y/NEXT▶

- 3** Press **Yes**.

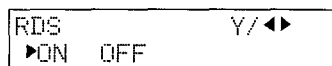

RDS ON OFF Y/◀▶

- 4** Change the on/off setting by pressing ◀ or ▶.

- 5** Finish: **Yes** and **Function**

**Note:** RDS is automatically switched off 24 hours after you switch it on.

**Operational Difficulties**

Problem	Required Action
<b>STANDBY MODE</b>	
Nothing happens when the switch is turned on.	Check the power cord. Is it properly plugged into the outlet? ➤ Plug it in firmly
SET DOC. OR DIAL NO. is not displayed.	Switch the power on. ➤ If the Power indicator does not light, check that the power cord is plugged in.  The machine might be the Energy Saver mode. ➤ Hold the Energy Saver key for two seconds.
The display does not show the Ready condition, or the machine stops during operation.	Does CLEAR ORIGINAL or CLEAR COPY appear in the display ? ➤ Clear the misfeed. See page 102.
	Does ADD PAPER appear in the display? ➤ Load paper into the paper tray. See page 80.
	Does CLOSE COVER appear in the display? ➤ Close all covers.
	Is the Add Toner indicator on? ➤ Load a new toner cartridge. See page 86.
<b>TRANSMISSION</b>	
The original is not pulled into the auto document feeder.	You did not feed the document far enough into the feeder. ➤ Insert the document into the feeder until it stops. Retransmit.
	Clean the ADF rollers (see page 95). ➤ If the same problem still exists after user maintenance, contact your service representative.
The machine cannot dial out.	The telephone line is disconnected. ➤ Check that the line is connected properly.
	The telephone line type setting is incorrect. ➤ Check the telephone line type setting See page 143.

Problem	Required Action
The machine cannot dial out from behind a private switchboard (a PBX).	<p>The dialed number <b>does not contain an access code or a pause, or not enough pauses.</b></p> <ul style="list-style-type: none"> <li>➤ Include the access number and a pause before the telephone number, or add pauses between the access code and the number, if necessary.</li> </ul>
Frequent original misfeeds	<b>Multifeeds or non feeds</b>
	<p>Incorrect positioning of originals</p> <ul style="list-style-type: none"> <li>➤ Put the document in the feeder correctly.</li> </ul>
	<p>Incorrect alignment of originals</p> <ul style="list-style-type: none"> <li>➤ Align the edges of the document.</li> </ul>
	<p>Curled pages</p> <ul style="list-style-type: none"> <li>➤ Flatten the document.</li> </ul>
	<p>Incorrect document type</p> <ul style="list-style-type: none"> <li>➤ Use a proper document type. See page 131.</li> </ul>
	<p>Mixed document types</p> <ul style="list-style-type: none"> <li>➤ The pages must all be of the same type.</li> </ul>
	<p>Static electricity on the originals</p> <ul style="list-style-type: none"> <li>➤ Shuffle the document.</li> </ul>
	<p>Clean the ADF rollers (see page 94).</p> <ul style="list-style-type: none"> <li>➤ If the same problem still exists after user maintenance, contact your service representative.</li> </ul>
	<p>Copier silicone oil on the originals</p> <ul style="list-style-type: none"> <li>➤ Wait a few minutes, then try again.</li> </ul>
	<p>More than 30 pages in the feeder</p> <ul style="list-style-type: none"> <li>➤ Do not place more than 30 pages in the automatic document feeder at once.</li> </ul>
<p>The document may be longer than the maximum limit (see page 131).</p> <ul style="list-style-type: none"> <li>➤ Make sure that none of your originals exceed this limit.</li> </ul>	

Problem	Required Action
<p>Transmission cannot take place</p> <p>Note: Before taking action, wait until the Communicating indicator goes out, then press the <b>Stop</b> key.</p>	<p>The other machine is out of order.</p> <ul style="list-style-type: none"> <li>➤ Check the error report.</li> <li>➤ Ask the other party to check their machine and correct the fault.</li> </ul> <p>The line is busy or noisy.</p> <ul style="list-style-type: none"> <li>➤ Check that the dial tone is sent out. Try to retransmit.</li> </ul>
<p>Consistent difficulty in communicating with a particular terminal</p> <p>Consistent poor image quality when communicating with a particular terminal</p>	<p>There are some bad lines between you and that other terminal.</p> <ul style="list-style-type: none"> <li>➤ Store that terminal's number as a Quick Dial Key or Speed Dial Code. Then call a service technician. Inform the nature of the problem and give the Quick Dial Key or Speed Dial Code that you stored the number in.</li> </ul>
<b>RECEPTION</b>	
<p>The telephone keeps ringing and no fax is printed.</p>	<p>You are in Manual Receive mode.</p> <ul style="list-style-type: none"> <li>➤ Change to Auto Receive mode (see page 14).</li> </ul> <p>Power is switched off.</p> <ul style="list-style-type: none"> <li>➤ Switch the power on.</li> </ul>
<b>RECEPTION/COPYING</b>	
<p>No printout; the Add Paper indicator is lit.</p>	<p>The cassettes are empty.</p> <ul style="list-style-type: none"> <li>➤ Add paper (see page 80).</li> </ul>
<p>No printout; the Clear Copy indicator blinks.</p>	<p>The printer has jammed.</p> <ul style="list-style-type: none"> <li>➤ Clear the jam (see page 102).</li> </ul>
<p>Copies appear dirty.</p>	<p>Does the original have a gray or colored background?</p> <ul style="list-style-type: none"> <li>➤ Select the Lighten contrast setting.</li> </ul>
<p>Copies are too light.</p>	<p>Does the original have a low contrast image?</p> <ul style="list-style-type: none"> <li>➤ Select the Darken contrast setting.</li> </ul>
<p>Copies are blank.</p>	<p>The original must be placed <u>face up</u> in the document feeder</p> <ul style="list-style-type: none"> <li>➤ Position the original correctly. See page 63.</li> </ul>

Problem	Required Action
Copy paper misfeeds occur frequently.	Is the proper paper in the paper tray? ➤ Use appropriate paper. See page 131.
	Is folded, wrinkled, damp, or curled paper in the paper tray? ➤ Always use dry, undamaged paper.
	Is the paper set properly in the paper tray? ➤ Always load paper correctly. See page 80. Do not load too much paper in the trays.
	Are there any pieces of misfed paper or other foreign objects in the machine? ➤ Make sure that the paper path is completely clear of paper and other material after a misfeed.
	Are you copying onto recycled paper? ➤ Fan the stack of recycled paper and load it in the paper tray.
Stripes on copies.	The exposure glass for the auto document feeder is dirty. ➤ Clean the exposure glass (see page 94).
<b>TELEPHONING</b>	
You can't receive phone calls; the unit only rings once then goes into receive mode.	You are in Auto Receive mode. ➤ Change to Manual Receive mode (see page 14).
You can't receive phone calls; the unit does not ring.	The telephone line is not connected. ➤ Connect the line (see page 143).
<b>POLLING</b>	
Dialing took place, but polling could not.	Polling with ID is set in the other terminal. ➤ Contact the person at the other end and make sure that <u>free polling</u> is available.

### Displayed Error Messages

CHECK AUTO-DIALING	You cannot use the auto-dialer at the moment. Use the ten-key pad or the handset.
NO FILE EXISTS	No polling reception operations have been programmed.
	There are no messages in memory waiting for transmission.
	Incorrect file number. Check the file number and try again.
TOO MANY DEST.	The memory cannot hold any more telephone numbers. Either: Delete some numbers then try again. Or: Wait until some of the Send Later or other delayed transmissions waiting in memory have been carried out, then try again.
USED AS GROUP	This Quick Dial Key has a Group stored in it.
USED AS DIAL	This Quick Dial Key has a telephone number stored in it.
USED AS TONE KEY	This Quick Dial Key is programmed as Tone Key.
USED AS GROUP KEY	This Quick Dial Key is programmed as Group Key
NOT PROGRAMMED	This Quick Dial Key or Speed Dial Code does not contain a number.
ALREADY PROGRAMMED	Either: This number is already included in this Group. This RT/CSI has already been stored for use with this feature.
PLEASE SET PAUSE	You must add a pause after your area code when you input your fax terminal's own telephone number.
ADD TONER	The toner cartridge is empty. Install a new cartridge.
ADD PAPER	The cassette is now empty.
CLEAR ORIGINAL	Either: - A document is jammed in the feeder. - The ADF exposure glass or the white plate might be dirty. Clean it as described on page 96. If this message still appears, please contact your service representative.
CLEAR COPY	Paper is jammed in the printer.
CLOSE COVER	A cover is not closed properly. Check that all covers are closed.
UNABLE USE PRINTER	Machine cannot print a list/file, because the heater is not warm enough or plotter is not ready.

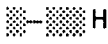
SERVICE CALL 	Machine is out of order. Contact your service representative.
--	---

## Error Codes

When an error occurs, an error report is printed. This report includes an error code. The following table lists common error codes and a few of the possible causes. If any of these or any other error codes are persistent and the machine does not work properly, contact a service technician.

**Note:**When an error occurs, it does not mean that you are doing anything wrong or that your machine needs service. Only if the problem persists should you call your service representative.

Code	Possible Cause
0-01	Printer empty or jammed at the other end
0-04	Faulty machine at the other end Poor line condition
0-05	Poor line condition
0-06	Incompatible or faulty terminal at the other end Poor line condition
0-07	The other party's machine disconnected during the call. Resend the page. If the problem persists, contact the other party.
0-08	The machine at the other end received the page that you sent but it had errors on the page. You may want to resend the page in question. The other party's memory could also be full. Contact the other party and ask them to make room in their memory for your message.
0-14	Same as for code 0-06
0-15	The other party's memory may be full.
0-16	Same as for code 0-04
0-20	Poor line condition
0-21	Same as for code 0-04
0-22	Poor line condition. Ask the other party to resend.
0-23	Same as for code 0-22

Code	Possible Cause
0-24	Memory may be full or there may be a problem with your printer, ( jam need to add paper or toner). Clear memory or solve the problem with your printer. If the memory was not full, substitute reception may have been disabled. See page 16
0-70	There is a problem with the machine at the other end.
1-00	Document jam, improperly inserted document
1-01	Document length exceeded the maximum limit, or as for code 1-00
2-xx	Possible fault in your machine
4-00	The page took too long to send. Send again at a lower resolution, or without halftone. The phone line may be bad.
4-01	There is a bad line. Your phone line may be disconnected.
4-02	The received page was too long.
4-10	Other party may be using ID codes. Ask the other party to avoid ID codes.
5-20, 5-21	Insufficient memory to receive the message. When the pages in memory have been printed, ask the other party to resend.
5-25	Your machine has a problem.
6-01, 6-02	Poor line condition or a problem with your machine
6-05, 6-06	Poor line condition, or a problem with the fax machines
6-08	A problem with the machine at the other end
6-09, 6-10	A problem with the machine at the other end or with yours machine
9-07	Copy jam at the cassette entrance
9-08	Copy jam inside the machine
9-09	Copy jam at the feed-out area



This page is intentionally blank.

# TECHNICAL REFERENCE

## Operation panel

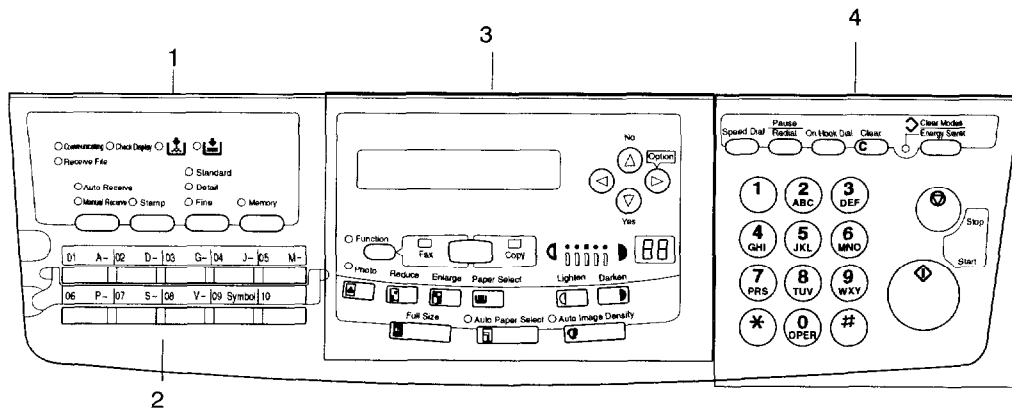

### Area 1

- 1- The **Communicating** indicator lights when a fax message is being transmitted or received.
- 2- The **Receive Files** indicator lights when a fax message was stored in memory (see page 16).
- 3- The **Check Display** indicator lights to tell you to read the display.
- 4- The **Add Toner** indicator blinks when toner is about to run out and lights continuously when toner has run out (see page 86).
- 5- The **Add Paper** indicator lights when you need to add paper.
- 6- The **Receive** button lets you switch between automatic and manual reception of fax messages (see page 14) while the indicators automatic and manual reception indicators tell you how the machine is set.
- 7- The **Stamp** button turns the stamp on and off and the indicator lights if it is on. (See page 25).
- 8- The resolution is indicated by these three indicators and can be changed by the Resolution button.
- 9- When the **Memory** indicator is on, then memory transmission is in effect, if it is off, immediate transmission is in effect. Switch between the two with the Memory button.

### Area 2

- 10- There are ten **Quick Dial** keys and a plate you can flip to get another ten keys. Use them to store individual numbers (see page 28) or groups (see page 37). Use the keys to enter characters (see page 130). Use Quick Dial 19 as a tone key if you are connected to a pulse dial line (see page 61). Use Quick Dial 20 as a Group key (see page 41).

### Area 3

- 11- The Liquid Crystal Display guides you through tasks and informs you of the state of the machine. Messages appear here. The LCD consists of two 20-character lines.
- 12- Use the arrow buttons to navigate through functions, to accept or reject settings, or to set function options.
- 13- Press the **Function** key and enter a two digit code to access functions 11 to 51. (For functions 61 to 94, enter 6, the access code on page 121 and the function number.)
- 14- The **Fax/Copy** key lets you switch between faxing and copying. The fax indicator lights for faxing and the Copy indicator lights for copying.
- 15- Press the **Photo** key to copy or fax photographs or other multi-tone images. When Photo processing is on, the Photo indicator lights.

- 16- Press the **Enlarge** key to enlarge your image. The available ratios are: 121% 129% 155% 200%.
- 17- Press the **Reduce** key to reduce your image. The available ratios are: 50% 65% 74% 77% 93%. Press the Full Size key to reset the magnification to 100%.
- 18- Press the **Paper Select** key to choose between having paper come from the optional side cassette or the main cassette. If you don't have the side cassette, pressing the key has no effect. The paper size selected appears in the LCD.
- 19- Press the **Lighten and Darken** keys to change the density. The Density indicator shows the selected density.
- 20- Press the **Auto Image Density** key to have the machine select the proper density. If the feature is on, the indicator lights.
- 21- Press the **Auto Paper Select** key to have the machine choose the right size of paper from the available kinds. If you don't have the needed size loaded, the machine will request it from the LCD.
- 22- If you have the optional side cassette and if the size of the paper it contains is different from what is loaded in the main tray, press the **Paper Select** to choose between the two. If you don't have the side tray, or if there is paper in only one of the trays,
- Area 4**
- 23- Press the **Speed Dial** key and enter a two digit code (between 00 & 49) to dial or store individual numbers (see page 32).
- 24- The **Pause/Redial** key inserts a pause when you are dialing or storing a fax number. Or, press the key to redial the last number dialed. (The redial feature doesn't work once you've started dialing a new number.)
- 25- Press the **On Hook Dial** key to dial a phone call from the keypad without having to lift the phone or handset off the hook (phone or handset option needed).
- 26- Press the **Clear** key to erase the last character or digit entered, or use the left and right arrow keys to move the cursor and then press Clear to erase whatever is at the cursor.
- 27- Press the **Clear Modes/Energy Saver** key to clear all the operation settings. Stored fax numbers are not cleared, nor are stored messages and polling jobs. Press and hold the key for three seconds to engage the Energy Saver function (see page 57).
- 28- Press the **Stop** key to stop a transmission or a document scanning or to stop a long copy run. The machine will finish printing out the sheet being printed and then stop.
- 29- Press the **Start** key to start all tasks.
- 30- Use the numeral keypad (sometimes called the 10 keys) to dial fax numbers, to enter the numbers of copies, etc.
- 31- Before pressing the start key, the Copy Counter indicates the number of copies to make. After pressing the Start key, the Copy Counter shows the number of copies made.

Machine Exterior

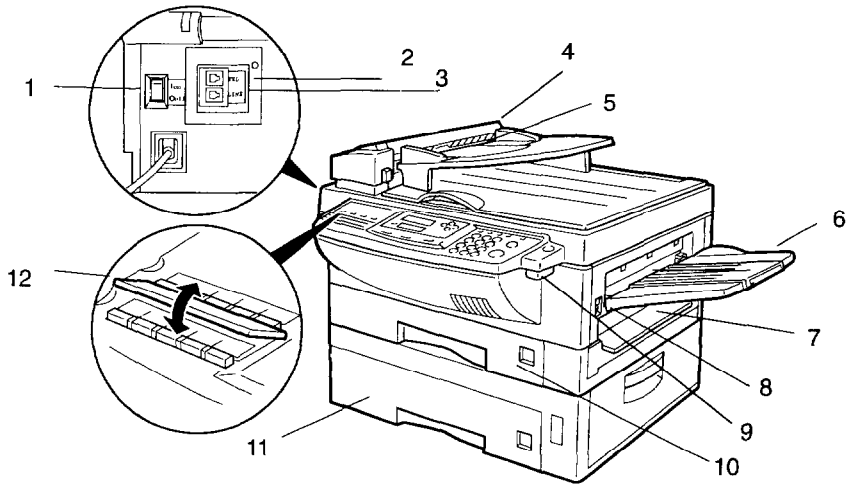

- 1- The **main switch** turns your machine on and off.
- 2- The **phone connection (TEL)** is where you plug in the line that goes to your telephone or handset (see page 143).
- 3- The **line connection (LINE)** is where you plug in the line to the telephone system's outlet.
- 4- The **automatic document feeder (ADF)** allows you to set up to 30 sheets at once so that they are fed in one at a time.
- 5 Set the document on the **ADF table**.
- 6- The **paper tray** receives all prints.
- 7- The **by-pass** tray allows you to copy to paper without having to load that paper in a tray.
- 8- The **side cover** can be opened (after opening the top unit) to let you change the toner cassette, the photoconductor, and to clear jams.
- 9- The top unit release lever
- 10- The **paper drawer** can hold 250 sheets (20 lb. paper) of half letter, letter or legal size.
- 11 Paper feed unit can be added to the base machine.
- 12- 20 Quick Dial keys are available by flipping the plate.

- 13- You can load another size of paper in the **optional paper cassette**.
- 14 Slide the lever and close the optional paper cassette cover when you set a sheet of paper using manual feed

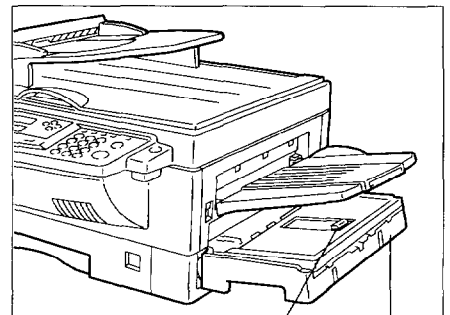

14 13

## Access Code for Functions 61 to 94

Accessing functions 61 to 94 requires an access code.

The sole purpose of this feature is to keep others from accidentally misadjusting the machine. This code cannot be changed, so do not rely on it as a security feature.

The code is 2222

### User Parameters (function 63)

Adjusting your machine sometimes requires that you change special settings called user parameters. For each user parameter, you must change a bit in a switch.

**Example:** Switch    \_\_\_\_\_  SW 01: 0000 1001———bit values  
   7 6 5 4 3 2 1 0———bit

A switch has eight bits. Each bit has a *value* of 1 or 0, and each bit is *numbered* 0 to 7 from the right. In the following example we'll change bit 3 of switch 05 in the user parameters.

- 1** Press **Function** and **6**, enter the access code **2 2 2 2** then press **6**, **3**, and **Yes**. You'll get:

```
SETTING?           Y//◀
PRINT LIST ◀
```

(You can press ◀ to see a list.  
Otherwise, press Yes.)

- 2** Press **Yes** again and use the ◀ & ▶ keys to change switches. For example go to switch 05 by pressing ▶ a few times.

```
KPAD/Y//▶
SWITCH 05 : 1000 0001
```

- 3** To change bit 3, press **3** on the key pad. Bit 3 will change from 1 to 0 or from 0 to 1.

```

KPAD/Y/◀▶
SWITCH 05 : 1000 1001
    
```

(To change bit 0, press 0, to change bit 1, press 1, and so on.)

- 4** Press **Yes** and **Function**.

Here is a list of all relevant user parameters. Many bit settings have no effect and are not listed. (Never change these.) The settings made at the factory are underlined.

SW	Bits & Definition	Settings																								
	0: Default Stamp setting STAMP	<u>Off</u> : 0 On: 1																								
	1, 2, and 3: Default manual density SCANNING CONTRAST	<table border="0"> <tr> <td>Bit</td> <td>1</td> <td>2</td> <td>3</td> </tr> <tr> <td><u>Normal</u></td> <td>0</td> <td>0</td> <td>0</td> </tr> <tr> <td>Slightly Darken</td> <td>0</td> <td>1</td> <td>1</td> </tr> <tr> <td>Darken</td> <td>0</td> <td>1</td> <td>0</td> </tr> <tr> <td>Slightly Lighten</td> <td>1</td> <td>0</td> <td>1</td> </tr> <tr> <td>Lighten</td> <td>1</td> <td>0</td> <td>0</td> </tr> </table>	Bit	1	2	3	<u>Normal</u>	0	0	0	Slightly Darken	0	1	1	Darken	0	1	0	Slightly Lighten	1	0	1	Lighten	1	0	0
Bit	1	2	3																							
<u>Normal</u>	0	0	0																							
Slightly Darken	0	1	1																							
Darken	0	1	0																							
Slightly Lighten	1	0	1																							
Lighten	1	0	0																							
	4, 5: Default resolution when you send a message RESOLUTION	<table border="0"> <tr> <td>Bit</td> <td>4</td> <td>5</td> </tr> <tr> <td><u>Standard</u></td> <td>0</td> <td>0</td> </tr> <tr> <td>Detail</td> <td>1</td> <td>0</td> </tr> <tr> <td>Fine</td> <td>0</td> <td>1</td> </tr> </table>	Bit	4	5	<u>Standard</u>	0	0	Detail	1	0	Fine	0	1												
Bit	4	5																								
<u>Standard</u>	0	0																								
Detail	1	0																								
Fine	0	1																								
	6: Default setting for transmission TRANSMISSION MODE	<u>Memory</u> : 0 Immediate: 1																								
	7: Default Photo setting. HALFTONE	<u>Off</u> : 0 On: 1																								
01	0: Default Auto Contrast Setting AUTO CONTRAST	<u>Off</u> : 0 <u>On</u> : 1																								
	1: Default Auto Select setting AUTOMATIC PAPER SELECTION	<u>Off</u> : 0 On: 1																								
	2: Copy/ Fax default COPY FAX	<u>Fax</u> : 0 Copy: 1																								

SW	Bits & Definition	Settings
01	7: Clear Modes after sending a fax. RETURN TO HOME POSITION	Off: 0 On: 1
02	1: Print a center mark on faxes. CENTER MARK	Off: 0 On: 1
	3: Print sender's ID on incoming messages. TSI PRINT	Off: 0 On: 1
03	0: Automatically print memory transmission reports. COMMUNICATION RESULT REPORT (MEMORY TX)	Off: 0 On: 1
	2: Automatically print storage reports for memory transmission. FILE RESERVE REPORT (MEMORY TX)	Off: 0 On: 1
	3: Automatically print storage reports for polling.	Off: 0 On: 1
	4: Automatically print polling reception reports. COMMUNICATION RESULT REPORT (POLLING RX)	Off: 0 On: 1
	5: Automatically print immediate transmission reports. TRANSMISSION RESULT REPORT	Off: 0 On: 1
	7: Automatically print communication reports. TCR	Off: 0 Yes: 1
04	7: Include the first half of the first page with reports? INCLUSION OF PART OF IMAGE	Off: 0 On: 1

SW	Bits & Definition	Settings
05	0: Store incoming faxes when machine is out of supplies. SUBSTITUTE RECEPTION	Off: 0 On: 1
	1: Allow automatic reception from senders that do not identify themselves. CONDITIONS OF MEMORY RECEPTION	Accept (Free): 0 Reject (RTI/CSI): 1
	6,7 : Level for the Energy Saving feature ENERGY SAVING	Bits: 6 7 Heater off (2W mode): 0 0 Heater half cool: 1 0 Heater full on: (copier priority mode) 0 1
06	0: Send a header with each page. TTI	Off: 0 On: 1
07	3: Reduce your message when sending. AUTO REDUCTION	Off: 0 On: 1
08	2, 3: AUTHORIZED RECEPTION (Can also use function 62)	Bits 2 3 : 0 X: Off 1 0: Receive messages only from senders whose RTI/CSIs are programmed. 1 1: Receive messages only from senders whose RTI/CSIs are programmed.
10	0: Reverse order printing (FAX EXPANSION CARD is required.)	Off: 0 On: 1
	7: Use dithering halftone (SPD) or standard halftone (STD)? HALFTONE METHOD	STD: 0 SPD: 1



SW	Bits & Definition	Settings	
12	2: Faxing & Report Toner Saving ECONOMY PRINTING MODE  Note: If on, contrast will be set to "Normal" automatically, preserving image quality. This is available when receiving fax messages and printing reports, but not for copying or printing from a PC. Further, messages sent to you in halftone mode will automatically turn off toner saving to insure a clear image. To make sure that the fax quality is acceptable with toner saving on, print a few reports. (Note: If the sender is using a machine made by another manufacturer, toner saving will stay on and this could lower image quality.)	Off: 0 On: 1	
	3, 4: Fax reception & PC printer density PRINT DENSITY	Bit Normal: Darken: Lighten:	3 4 0 0 0 1 1 0

## User Parameter Hints

### Changing your machine's default settings

These are the settings your machine assumes immediately after it is turned on, after clearing the machine, or after you or the night timer reactivates it. Many of the user parameters determine your machine's default settings.

### Clear modes after sending or loading a fax message (Switch 01, bit 7)

Your machine can either reset itself or keep its settings (for a few minutes) after it sends a fax message.

### Printing the sender's identification on the message (TSI, Switch 02, bit 3)

If you receive messages that do not include an identifying header on the printout, you can your machine to print the identification displayed on the LCD during the communication (the CSI or RTI, see page 159).

### Automatic reports

Many types of automatic reports can be switch on or off. See page 47 for details.

### Accepting messages when out of supplies (Switch 05, bit 0)

This is also called substitute reception. You can accept messages even when out of toner or paper by storing them in memory. See page 16

### Saving toner (Switch 12, bit 2)

You can reduce the amount of toner used for fax messages and for reports. Messages sent to you in halftone (e.g. photographs) will switch this feature off to ensure the best image quality available, but the feature will stay on if the sender is using a machine made by another manufacturer. To make sure the fax quality is acceptable, print a few reports (see page 47). If you find that your fax messages and reports are too light, turn this feature off.

### Adjusting the density for faxes and PC printouts (Switch 12, bits 3 & 4)

If your printouts or *received* fax messages are too light or too dark, adjust the printing density over three levels: Normal, Darken, and Lighten.

## Copier Settings (Function 72)

Use function 72 to set the limit number of copies.

- 1** Press **Function, 6**, and enter the access number **2222**. Then press **7, 2**.

```
PROGRAMMING  Y/NEXT▶
72 COPY SET
```

- 2** Press **Yes**

```
Y/NEXT▶
# OF COPIES LIMIT
```

- 3** Press **Yes** again and get this:

```
# OF COPIES  Y/N
99 SHEETS
```

- 4** Press **No**, then enter a number between 01 & 99.(for the number of copies). Example: If you set to 3 sheets, enter **0** and **3**.

```
# OF COPIES  Y/N
03 SHEETS
```

- 5** Press **Yes**. PROGRAMMED will flash across the screen and you'll get this:

```
FUNCTION  Y/NEXT▶
Z PROGRAMMING MODE
```

- 6** Press **Function** to return to the ready state.

## Adjusting the Volume of Various Features (Function 92)

You can change the beeper (monitor) volume of the desired feature.

TRANS MONITOR	Beeps to signal transmissions.
RECV MONITOR	Beeps to signal receptions.
ON HOOK MONITOR	Beeps to signal on hook dialing.
DIAL MONITOR	Beeps when a number is dialed.
BUZZER	Beeps (doesn't buzz) to signal something going amiss.
KEY	Beeps when a key is pressed.

- 1** Press **Function, 6**, and enter the access number **2222**. Then press **9, 2**.

```

                                Y/NEXT▶
92 ADJUST VOLUME
    
```

- 2** Press **Yes**.

```

TRANS MONITOR  Y/◀▶
MIN▶▶▶      MAX
    
```

- 3** Adjust the transmission monitor volume with ◀ & ▶ and press **Yes** when you're done.

```

RECV MONITOR  Y/◀▶
MIN▶▶▶      MAX
    
```

- 4** Adjust the reception monitor volume with ◀ & ▶ and press **Yes** when you're done.

```

ONHOOK MONITOR Y/◀▶
MIN▶▶▶      MAX
    
```

- 5** Adjust the dial monitor volume with ◀ & ▶ and press **Yes** when you're done.

```

DIAL MONITOR  Y/◀▶
MIN▶▶▶      MAX
    
```

- 6** Adjust the buzzer volume with ◀ & ▶ and press **Yes** when you're done.

```

BUZZER        Y/◀▶
MIN▶▶▶      MAX
    
```

- 7** Adjust the key press monitor volume with ◀ & ▶ and press **Yes** when you're done.

```

KEY           Y/◀▶
MIN▶▶▶      MAX
    
```

- 8** Press **Function** to return to the ready state.

## Selecting the Display's Language (Function 93)

If you would rather use another language for messages and displays, follow the procedure below. The three languages available are: English, French, and Spanish.

- 1** Press **Function, 6**, and enter the access number **2222**. Then press **9, 3**, and **Yes**.

```
SELECT LANGUAGE Y/◀▶  
ENGLISH
```

- 2** Use ◀ and ▶ to scroll through the available languages.

```
SELECT LANGUAGE Y/◀▶  
FRENCH
```

- 3** Press **Yes** to accept the language displayed, then press **Function** to return to the ready state.

**Counters (Function 94, see page 52. )**

## Entering Characters

Use the key pad for entering numbers. Use Quick Dial keys 1 to 8 for entering letters, the ◀ & ▶ keys to change to another letter, the **Yes** key to accept a character, and Quick Dial key 09 for spaces and other characters.

If at any time you make a mistake when entering a character or digit, press the **Clear** key to erase it. To correct a character or number already entered, use the ◀ and ▶ keys to reach the mistake, enter the new character, and press clear to erase the mistaken character. If you press **No** key, whole characters are erased.

Quick Dial Key	Letter
01 & 11	A
02 & 12	D
03 & 13	G
04 & 14	J
05 & 15	M

Quick Dial Key	Letter
06 & 16	P
07 & 17	S
08 & 18	V
09 & 19	Space & Symbols
10 & 20	Nothing

## Entering Symbols

**1** Press **09** or **19** of the Quick Dial key.

**2** Press ◀ or ▶ to scroll symbols.

You can enter the following symbols.

"Space" & \$ ! " # \$ % & ' ( ) \* + , / : ; < > ? @ [ ¥ ] ^

**3** Press **Yes**.

## Entering Numbers

**1** Enter numbers using the ten key pad.

## Document & Paper Specifications

### Documents (Using the Auto Document Feeder)

Length (automatic feed):	4.1~14.3 in (105~364 mm)
Length (manually assisted feed in fax):	Up to 47.2 in (1200 mm)
Width:	5.8~10.1 in (148~257 mm)
Thickness :	16~24 lb(0.05~0.2 mm)

### Document Feeder Requirements

- Do not insert torn, heavily curled, wavy, creased, dog-eared, damp, or otherwise damaged documents. Copy or fax from the exposure glass.
- Do not insert folded, stapled, clipped, glued, or taped documents, or documents with a metallic coating. Copy or fax from the exposure glass.
- Do not insert documents on which there is undried ink or correction fluid. Wait for the document to dry.
- If the document has an uneven or slanted edge, do not insert that edge in first.

### Documents (On Exposure Glass)

Size:	Up to 10.1 x 14.3 in (257 x 364 mm)
Maximum Thickness	Closed cover, 1.18 in (30mm)
Maximum weight of the document:	11 lb (5 kg)

### Paper Requirements

- Acceptable sizes are half letter, letter and legal. Load other sizes from the bypass.
- Do not print to torn, heavily curled, wavy, creased, dog-eared, damp, or otherwise damaged paper.
- Do not print to folded, stapled, clipped, glued, or taped paper.
- Do not print to paper with any kind of coating or printing. Do not print to metallic paper. Do not print to the reverse side of a print.

## Capabilities

### Functions That Can Be Used Together (Dual Access)

Job currently in progress (First selection)	Job you wish to carry out at the same time (Second selection)								
	1.	2.	3.	4.	5.	6.	7.	8.	9.
1. Storing to Memory	■	✓	✗	✓	✗	✓	✓	✓	✓
2. Printing from Memory	✓	■	●	✗	✗	✗	✗	✗	✗
3. Copying	✗	✗	■	✗	✗	✓	✗	✓	✓
4. Printing an Automatic Report	✓	✗	✗	■	✗	✗	✗	✗	✗
5. Immediate Transmission	✗	✗	✗	✗	■	✗	✗	✗	✗
6. Memory Transmission	✓	✗	✓	✗	✗	■	✗	✗	✗
7. Receiving and Printing aFax	✓	✗	✗	✗	✗	✗	■	✗	✗
8. Receiving a Fax to Memory	✓	✗	✓	✗	✗	✗	✗	■	✗
9. Printing a Fax or Report Manually	✓	✗	✓	✗	✗	✗	✗	✗	■

✓: Possible, ✗: Not possible ▲: The second selection is not possible.

●: The second selection is possible, but it cancels the correctly selected mode.

### Stored Numbers (Long term)

- 20 Quick Dial keys, each of which can hold an individual number. Any three of the Quick Dial keys can hold a group of numbers and Quick Dial 19 can be used as a tone key.
- 50 individual numbers stored as two-digit Speed Dial codes (see page 32).
- Three groups, each of which can hold up to 100 destinations.
- 30 CSI or RTI codes (possibly used as wild cards) for authorized reception.

### Stored Destinations

- You can send to (or pick up from) as many as 100 locations for one job.
- Up to 200 destinations can be set at any one time. (Ex: message A to 75 destinations, message B to 25, message C to 75, then a polling job from 49 numbers, and finally one immediate transmission job you're programming in now. Total: 200)



## File Storage

- ❑ You can have as many as 100 files stored in the machine: this includes memory transmission files and polling reception files. This is a theoretical maximum. The actual number of files you can have in your machine depends on the types of the documents.

## Specifications

### Electrical Specifications (Base machine)

Power supply: 115 Vac, 60 Hz

#### Power consumption

Energy saver mode: Average 2 W

Standby mode: Average 25 W

Copier standby mode: Average 70 W

Transmission: Average 35 W

Reception: Average 200 W

Copying: Average 300 W

Maximum power consumption: 800 W

#### Fax Specifications

Protocol: G3

Memory Capacity: Base machine: 52 pages/letter size  
 With 1 Mbyte memory: 135 pages  
 With 2 Mbyte memory: 218 pages  
 With 4 Mbyte memory: 384 pages

Data rate: 14400/12000/9600/7200/4800/2400  
 bps, automatic fallback.

Transmission time: 6 seconds at 14400 bps, G3 ECM,  
 using memory for a ITU-T #1 test  
 document (Slerexe letter) at stand-  
 ard resolution

**General Specifications**

Fax mode resolution:	(main scan x subscan) Standard: 8 x 3.85 lines/mm Detail: 8 x 7.7 lines/mm Fine: 8 x 15.4 lines/mm
Copy mode resolution:	16 x 15.4 lines/mm
Printer mode resolution:	300 dpi Pseudeo 600 dpi with resolution improvement technology
Copying/printing speed:	10 ppm (letter paper)
Paper cassette capacity:	250 sheets
By-pass feeder capacity:	1 sheet
Auto document feeder capacity:	30 sheets, face up
Paper Size:	Letter, Legal, Half Letter
Reduction ratios:	50%, 65%, 74%, 77%, 93%
Enlargement ratios:	121%, 129%, 155%, 200%
Dimensions (W x D x H):	21.9 x 21.9 x 13.4 inches

*exclusive of trays, handsets, and options*

Weight:	66.1 lb <i>exclusive of trays, handsets, and options</i>
---------	---

**Optional Side Paper Cassette**

Capacity:	100 sheets
Usage:	Paper Cassette & by-Pass tray
Paper Size:	Letter, Legal

**Optional Paper Feed Unit**

Capacity:	500 sheets
Paper Size:	Letter, Legal

---

## APPENDIX A: INSTALLATION

Before installing your machine, read the safety instructions at the beginning of this manual. To install the machine, follow these procedures:

- 1-Find a suitable location for the machine.
- 2-Remove all the pieces of tape attached to the machine and remove the red clip on the upper unit (See page 137.)
- 3-Install the photoconductor, cleaning pad and toner. (See page 138.)
- 4-Attach the accessories and load the paper in the drawer. (See page 141.)
- 5-Connect the phone line. (See page 143.)
- 6-Connect the power. (See page 145.)
- 7-Enter all necessary information and settings in your machine's memory. (See page 146.)

### Machine Environment

**WARNING:** When choosing a location for your machine, please follow the safety instruction given on pages i to iv of this manual.

#### Location

For the best possible performance, install your machine in a place which satisfies the following conditions.

- Not exposed to direct sunlight
- Well ventilated (air turnover at least three times per hour); to avoid the build-up of ozone, make sure to locate the machine in a large well-ventilated room which has an air turnover of more than 30 yd<sup>3</sup>/hr per person.
- Level
- Not subject to vibration
- Away from other electronic equipment, to avoid interference
- Away from areas containing corrosive gas
- Dust-free
- Condensation-free
- Temperature 63 to 82°F
- Humidity 40 to 70% RH (do not install near a humidifier)
- Away from heaters and air conditioners, to avoid sudden changes of temperature
- Within 5 yards of a three-pin grounded power outlet (115 Volts, 60 Hz)

- ❑ Ensure there is clearance around the machine, as indicated in the diagram below.

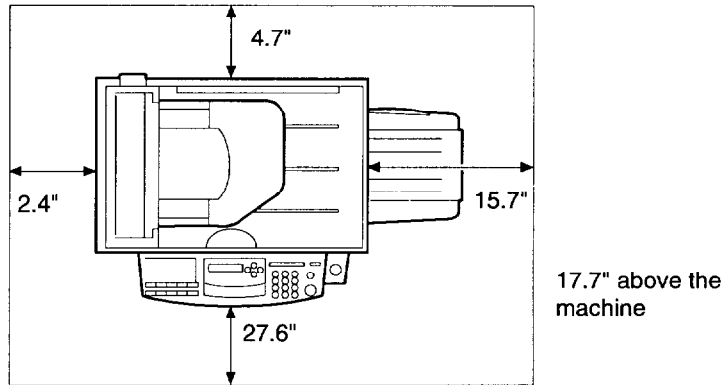

**NOTE:** This machine generates a certain amount of ozone. Although the amount generated is within safety requirements, it is recommended that, to avoid ozone buildup, you install the machine in a room which is properly ventilated.

### Operating Precautions

- ❑ While the machine is in operation, do not turn off the main switch or unplug the power cord.
- ❑ Keep corrosive liquids, such as acid, off the machine.
- ❑ Do not allow paper clips, staples, or other small metallic objects to fall inside the machine.
- ❑ The fusing unit may be very hot. Be careful when handling it.

- First of all, remove all the pieces of tape attached with the machine.

## Removing the Clip on the Upper Unit

You have to remove the clip on the rear side of the upper unit before you use the machine.

- 1** Open the upper unit and lift it until it lock in place.

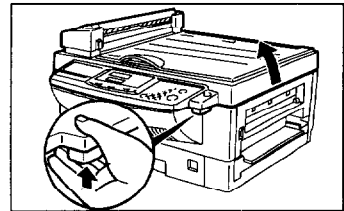

- 2** Pull out and remove the red clip with the label.

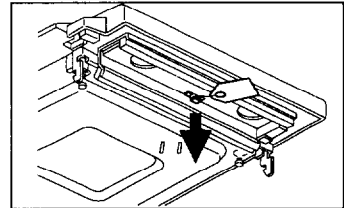

- 3** Bend the mylar tag along the line. Stick it over the hole made when you remove the red clip.

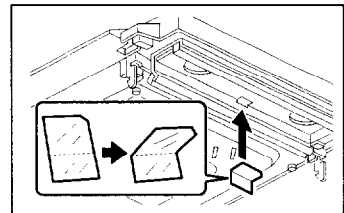

## Installing the Photoconductor, Toner Cassette and Cleaning Pad

Before using the machine, install the photoconductor, toner cassette and the cleaning pad as in the following procedure:

- 1** Open the upper unit and lift it until it locks in place.

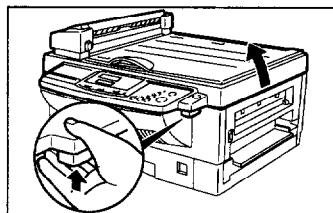

- 2** Open the side cover.

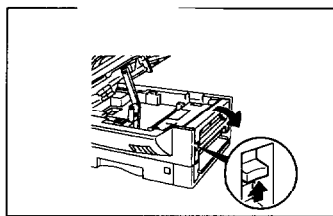

- 3** Put the photoconductor as shown in the illustration. Pay attention to the green knob are in both edge. One of them is marked "R" for rear (back) side. Then remove the black sheets.

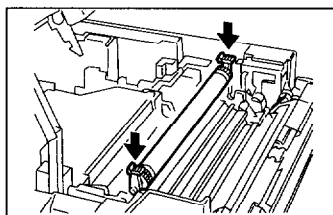

**Caution:** Never touch the photoconductor (green drum).

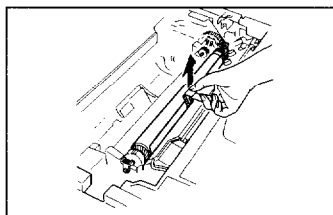

- 4** Turn the lever by gently pushing it.

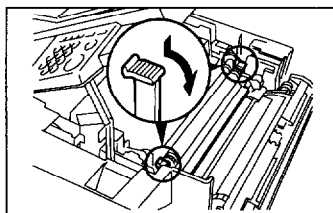

- 5** Shake the toner cassette from side to side.

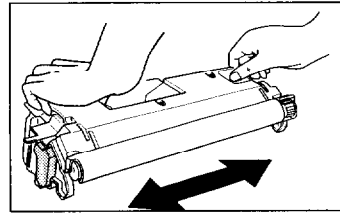

Pull out the film and remove the black sheet of the toner cassette.

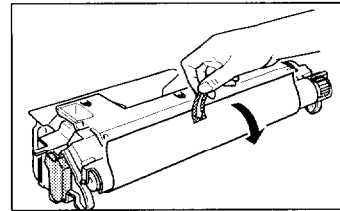
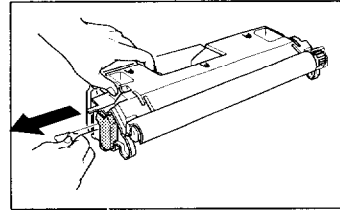

- 6** Slide the toner cassette into the machine as far as it will go. Gently push down the cassette to secure it in place.

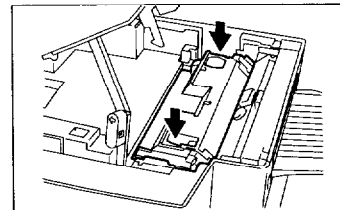

- 7** Install the cleaning pad as shown in the illustration. Match the position of the arrow on the cleaning pad with the arrow on the inside the machine.
- Note:** Push the cleaning pad until you hear it clicking.

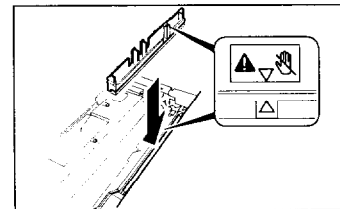

- 8** Close the side cover.  
Push the both end of the side cover until it clicks.

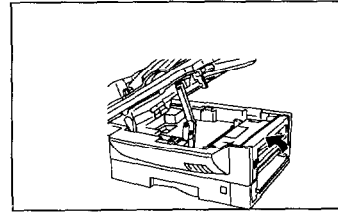

- 9** Push the lever arm inwards, let the top unit sink slowly in place, and press down to lock it.

**Note:** If the top unit does not close, the toner cassette, photoconductor or cleaning pad is not fitted correctly.

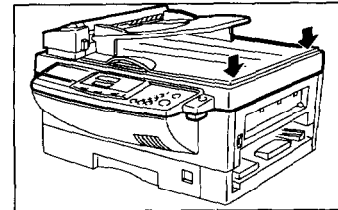
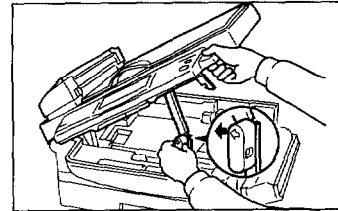



## Attaching the Print Tray

- 1** Attach the print tray.

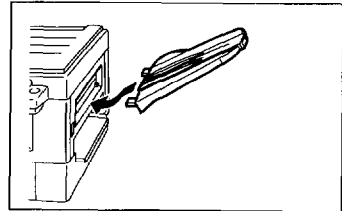

## Attaching the Auto Document Table

- 1** Insert the document table into the holes on the top cover.

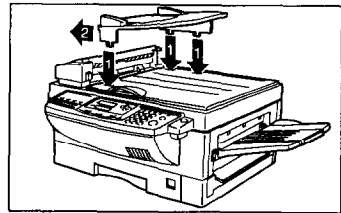

- 2** Slide the document table until you hear it clicks.

## Attaching the Stop

- 1** Insert the stop by pushing it in direction 1 as shown in the diagram.

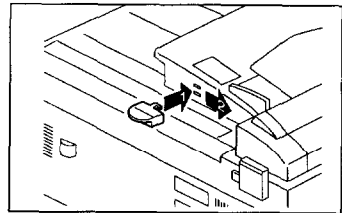

- 2** When fully in, slide it towards direction 2 to fix it in place.

## Setting the Paper

See the section titled "Setting / Adding the paper". See page 80 .

## Installing the Optional Memory Card

Switch off the power before you install the optional memory card.

**1** Slide the drawer all the way out.

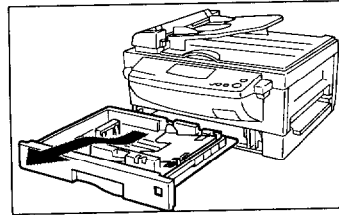

**2** Remove the cover on the machine.

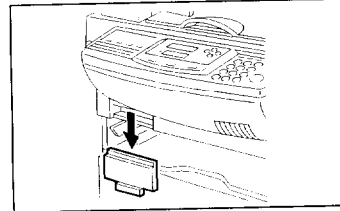

**3** Insert the card. The side with the card type (e.g. TYPE20) must be facing upwards. Make sure the card is pushed right so the contacts touch.

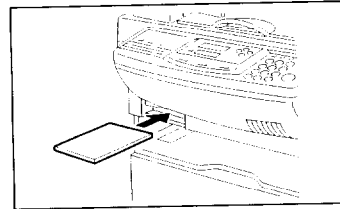

**4** Replace the cover.

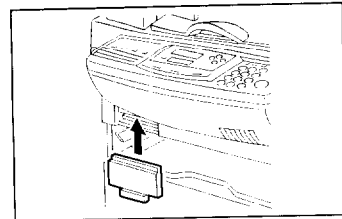

**5** Replace the drawer in the machine. Turn the power on.

## Connecting the Machine

Before using the machine, connect the machine to the telephone line properly. And plug the power cable and switch on.

Make sure that it is properly connected to the telephone line and the power outlet, as shown below.

**CAUTION**

Do not switch on until everything is connected properly.

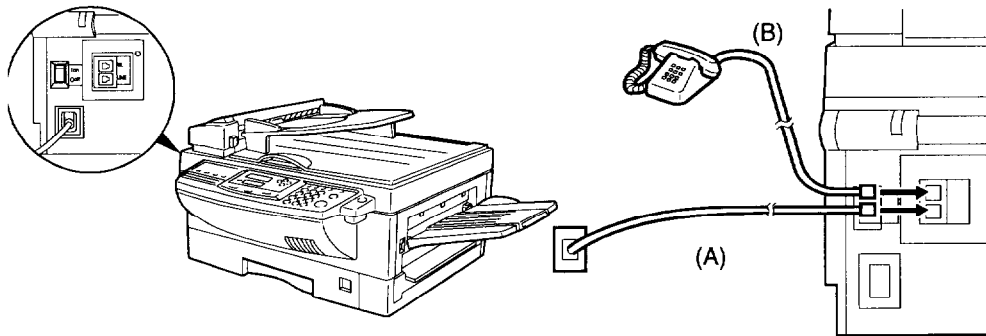

Program the Telephone Line Type setting (use Function 62; see page 41). If your telephone normally sends out tones (touch tone) when dialing, use the TT setting; if it normally sends out pulses (rotary dial), use the DP setting. Also, make sure that the switch on the handset is set up correctly.

## Connecting to the Phone Lines

**Important:** By law in the United States, you must program your phone number identification (your CSI) into your machine before you can connect it to the public phone system. See page 146.

- 1** Connect the phone line cord to the fax jack marked Line.(A)
- 2** Connect the other end of the line into the phone line jack (on the wall or on a cable).
- 3** Connect the handset (option) or your own telephone to the jack marked Tel (B).
- 4** Connect the other end of the line to the handset or telephone.

## Connecting the Power

### IMPORTANT POINTS ABOUT POWER CONNECTION

If you have to use an extension cord, make sure that it is capable of carrying 125V/15A, and that your facsimile terminal is the only piece of equipment connected to that cord. The supply from the wall outlet must not fluctuate more than 20 V either side of 115 Vac.

The power cord should not be laid in a place where it might trip somebody.

Do not lay anything on the power cord.

**WARNING:** The power source must conform to the specifications on page 133.

**WARNING:** Make sure the power source is properly grounded.

**WARNING:** Follow the safety instructions given of pages i to iv.

**1** Insert the plug into the wall outlet.

**2** Turn on the power.

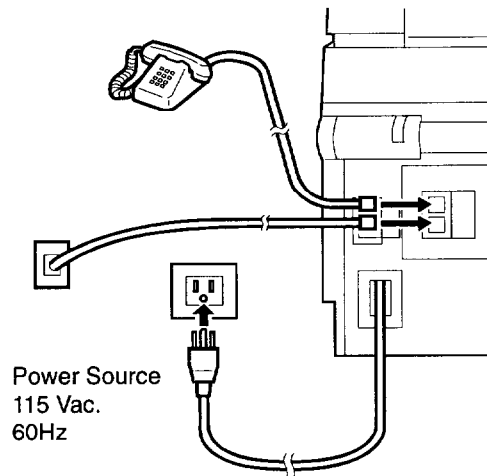

## Initial Settings & Adjustments

**Important:** The CSI code (see below) is required by international law. You cannot legally connect a fax machine to the telephone system if the CSI code is not programmed. Further, the TTI code and the date and time of transmission must be included in the header of all pages faxed to, from, or within the United States.

Before you connect your machine to the telephone system, you must enter a few settings and make a few adjustments.

**Own number:** The phone number used by your fax line.

**CSI** (Called Station Identification, required by international law): This is your fax machine's phone number, *which must include country and area codes*. During any communication, your CSI appears on their display. (Conversely their CSI appears on your display.)

**RTI** (Receive Terminal Identification): This should be your name or company name, in 20 characters or less. During a communication, if the other party's fax machine supports RTI, then this replaces the CSI above. The other party's name will appear on your display, and yours on theirs.

**TTI** (Transmitter Terminal Identification): This should be the same as your RTI or CSI code. It will be printed on the header of every page you send. Required in the USA.

**Line:** You must match the fax machine to the type of line you use: a tone line or a pulse line. Then, you should connect the line to the machine.

**Date & Time:** Necessary for many functions and required in the USA.

### Initial Settings (Function 61)

During the course of this procedure you'll have to enter letters and other characters.

Use the key pad for entering numbers. Use Quick Dial keys 1 to 8 for entering letters, the ◀ & ▶ keys to change to another letter, the Clear Key to erase a letter, Yes key to accept a character, and Quick Dial key 09 for spaces and other characters. See page 130 for details.

If these settings have been made before, the messages on the display will not always match those shown here. The setting already entered will appear along with the word [CHANGE?]. In this case, press **Yes** to change the setting.

- 1** Press **Function** and **6**, enter the access code **2222**, then enter **61**.  
You'll get this:

```
INITIAL MODE Y/NEXT▶
61 INITIAL SET
```

- 2** Press **Yes**.

```
Y/NEXT▶
SET OWN NUMBER
```

- 3** Press **Yes** again.

```
OWN NO.          KPAD
████████████████
```

- 4** Enter your phone number.

```
OWN NO.          KPAD/Y/N
0111212-5551234 ██████████
```

- The format of the number is normally be as follows:**  
International Dial Prefix, Your Country Code, Your Area Code, **then you must add a Pause**, followed by your telephone number.  
Check the International Dialing Prefix and the Country Code with your local telecommunications operator. The example shown is for the USA; the codes to add are 011 and 1.

- 5** Press **Yes**. PROGRAMMED will flash on the display and you'll get:

```
Y/NEXT▶
SET RTI
```

- 6** Press **Yes**.

```
RTI              ABC
████████████████
```

- 7** Enter your office, company, or personal name, or any other appropriate identification. (Use the quick Dial keys. See page 130 for details.)

```
RTI              ABC Y/N
XYZ COMPANY.
```

- 8** Press **Yes**. PROGRAMMED will flash on the display and you'll get:

```
Y/NEXT▶
SET TTI
```

- 9** Press **Yes**. The RTI programmed in step 7 appears. You should keep it.

```
TTI CHANGE? ABC Y/N
XYZ COMPANY.
```

If you wish to change it, press **Yes** and edit the TTI.

- 10** Press **No** to keep the TTI as is. You'll get:

```
SET CSI Y/NEXT▶
```

- 11** Press **Yes**.

```
CSI KPAD
████████████████████
```

- 12** Enter your phone number and include the country and area code, (but no pauses). Should be the same as in step 4.

```
CSI KPAD/Y/N
15145551234:██████████
```

- 13** Press **Yes**. PROGRAMMED will flash on the display and you'll get:

```
READY 100% 00:00AM
SET DOC. OR DIAL NO.
```



## Setting the Phone Line (Function 62)

**1** Press **Function** and **6**, enter the access code **2 2 2 2**, then enter **62**. You'll get this:

```
INITIAL MODE Y/NEXT▶
62 SELECT FUNCTION
```

**2** Press **Yes**.

```
SELECT LINE Y/NEXT▶
```

**3** Press **Yes** again.

```
SELECT LINE Y/◀▶
▶TT PD
```

**4** Press **◀ & ▶** to set your machine for a tone dial line (TT) or a pulse dial line (PD).

```
SELECT LINE Y/◀▶
TT ▶PD
```

**5** Press **Yes**. PROGRAMMED will flash on the display and you'll get this.

```
Y/NEXT▶
AUTHORIZED ON/OFF
```

At this point, you could turn on the Authorized Sender function (page 53). We will skip this

**6** Press **Function**.

```
READY 100% 10:00AM
SET DOC OR DIAL NO.
```

## Setting the Date &amp; Time (Function 91)

- 1** Press **Function, 6**, and enter the access code **2222**. Then enter **9 1**.

```
ADJUSTMENT  Y/NEXT▶
91 ADJUST CLOCK
```

- 2** Press **Yes**. A date and time will appear.

```
SUN           :*/#/#/Y
APR 21 1996  01:35PM
```

- 2** Change the month using **\*** or **#** (**\*** to scroll forward, or **#** to scroll backward) on the ten key pad and press **▶** to move the cursor.

```
TUE           */#/#/Y
MAY 21 1996  01:35PM
```

- 3** Change the date with the ten key-pad as **09**.

```
THU           */#/#/Y
MAY 09 1996  01:35PM
```

- 4** Type in the year and time at the keypad as **9 6 1 0 2 5**.

```
THU           */#/#/Y
MAY 09 1996  10:25PM
```

- 5** Change AM/PM using **\*** or **#** on the ten key pad.

```
THU           */#/#/Y
MAY 09 1996  10:25AM
```

- 6** When the display is correct, press **Yes** and **Function**

## Daylight Saving Time

Whenever local custom requires advancing the clock or setting the clock back, use this feature. You can easily move the clock forwards when daylight saving time begins, and back when it ends.

When you install the machine for the first time, take care that the setting is correct before you set the date and time.

- 1** Press **Function, 6**, and enter the access code **2222**. Then enter **6 2** and **Yes**.

```

SELECT LINE          Y/NEXT▶
  
```

- 2** Press ▶ until the screen is as shown opposite, and then press **Yes**.

```

DAYLIGHT TIME ON/OFF  Y/NEXT▶
  
```

- 3** Use the ◀ and ▶ arrows on the scroll key to switch the feature on or off. This mode is off if the display is shown as opposite.

```

DAYLIGHT              Y/◀▶
ON ▶OFF
  
```

- 4** To store your setting: **Yes**

---

## APPENDIX B: OPTIONAL SIDE CASSETTE

### Installing the Side Cassette

Followings are the installation procedure of the optional paper cassette and paper in it.

- 1** Remove the cover just under the copy exit.

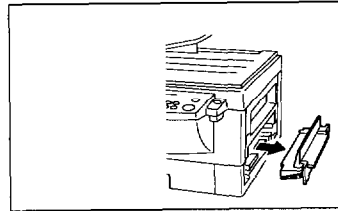

- 2** Remove the cover from the cassette.

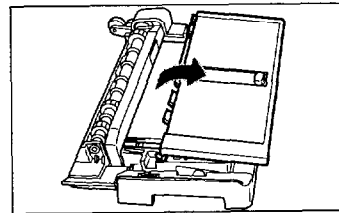

- 3** Press on the bottom plate(or paper stack) until it locks in place.

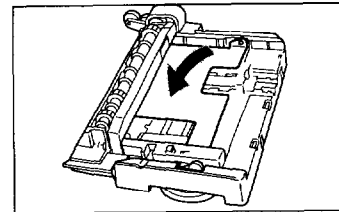

- 4\*** If necessary, remove the paper stack.

\*You do need to follow steps marked with an asterisk unless you are changing the paper size setting.

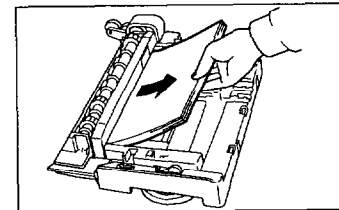

**5**\* If the new paper size is legal, install the extender (see next page). Otherwise you do not need it, and you can remove it if it is installed.

**6**\* Pinch and hold the side fence lock, and slide the fence to the proper size setting.

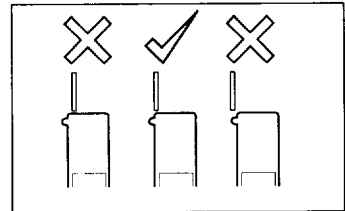
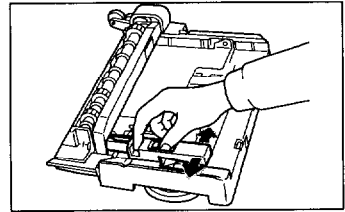

**7**\* Slide the back fence to the proper size setting.

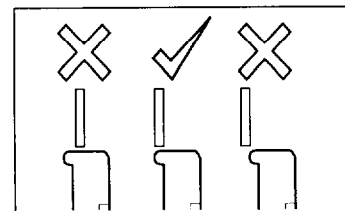
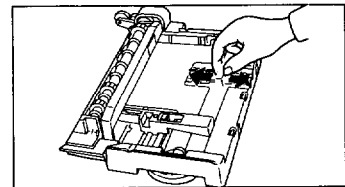

**8**\* Set the dial for the proper size.

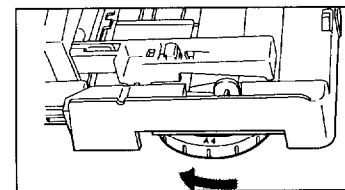

- 9** Bend your stack of paper (not exceeding the limit mark) and insert in the tray. Make sure the paper fits under the corners and push the side and back fence toward the paper.

**Note:** If there is space between the paper and fences, carefully move in each fence until it is flush with the paper.

- 10** Replace the cover on the cassette.

**Note:** The bypass feed plate should be in the standard paper feed (⇨:out) position. If it is in, paper might not be fed properly. Only move it to the bypass feed position (⇩) when feeding paper manually.

- 11** Install the side cassette as illustrated. Use both hands.

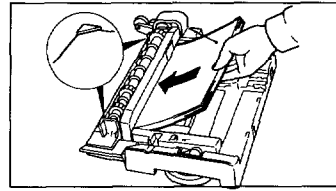

Standard paper feed position (⇨)

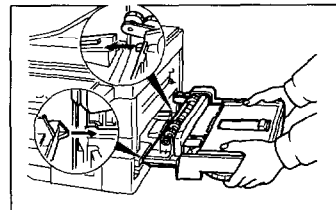
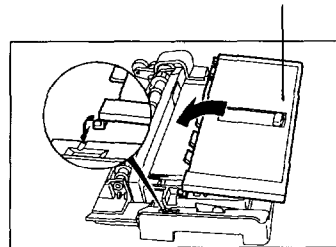

**Note:** Keep the cover of the side cassette in the outer position when you do not use the manual feeder.

## Installing the Extension

When you set the legal size in the optional side cassette, install the extension.

- 1** Remove the extension from underneath the cassette as indicated by the arrows.

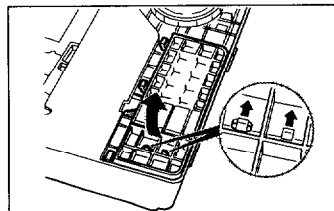

- 2** Install the extension.

When not using the extension, keep it stored under the bottom of the cassette.

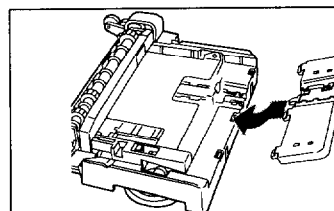

# INDEX & GLOSSARY

## A

access code 121  
Add Paper Indicator 80  
adding  
    paper 80  
    toner 86  
authorized reception 53  
authorized senders 53  
automatic  
    reception 14  
    reports 47

## B

broadcasting 23

## C

calls (receiving) 14  
characters  
    entering 130  
cleaning pad  
    replacing 87  
communication  
    capabilities 132  
    problems 108  
connection  
    phone line 143  
    power 145  
contrast 18  
    faxing 17  
copier  
    settings 127  
copying 63 - 79  
    density 71  
    document feeder 63  
    magnification 70  
    photos 73  
Correcting Mistakes  
    Dialing 100  
counters 52  
CSI 146

## D

date & time 150  
Daylight Saving Time 151  
default settings 126

density  
    copying 71  
    fax & PC printouts 126  
    faxing 17  
detail  
    faxing 17  
document  
    specifications 131  
Document Feeder  
    Acceptable originals 2 - 3  
    copying 63  
    faxing 6  
Document size, allowable 2  
Document types, allowable 3  
dual access 132

## E

energy  
    saving 57  
enlarging 70  
environment (machine) 135  
erasing  
    a quick dial 31  
    a speed dial 36  
    stored message 42  
error codes 115

## F

faxing 1 - 46  
    document feeder 6  
    photos 19  
    send later 20  
    to many destinations 23  
    to one destination 6  
file  
    report 50  
function  
    21 erasing a stored message 42  
    22 erasing a polling job 42  
    31 setting a quick dial 28  
    32 setting a speed dial 32  
    33 setting a group 37  
    41 TCR report 50  
    42 file report 50  
    43 stored number report 51

    51 printing a stored message 43  
62 initial settings 56, 60, 149  
63 user parameters 121  
71 night timer 58  
72 copier settings 127  
81 authorized senders 54  
91 date & time 150  
92 sound volume 128  
93 language 129  
94 counters 52  
function  
    61 initial settings 146

## G

Grounding iii  
groups  
    storing 37

## H

handset  
    on hook dial 46

## I

Indicators 118  
    Add Paper 80  
initial settings  
    copier 127  
    general 146  
installation 135, 137 - 151  
    side cassette 152

## J

jams  
    copy/print 102  
    document 101

## K

keys 118

## L

labels  
    entering characters for 130  
language 129  
LCD 118



length reduction 108  
Lightning protection iii - iv

**M**

machine exterior 120  
magnification 70  
maintenance  
  cleaning pad 87  
  daily 94  
  paper 80  
  photoconductor 90  
  stamp 93  
  toner 86  
manual  
  reception 14  
  reports 50  
Marker (Stamp) 25  
Memory Transmission 5  
  erasing 42  
  printing 43

**N**

night timer 16, 57  
numbers  
  erasing a quick dial 31  
  erasing a speed dial 36  
  storing 28

**O**

on hook dial 46  
On/Off Switches  
  RDS 109  
  Reject Messages from  
  Unidentified Senders 52  
operation panel 118  
option  
  fax: send later 20

**P**

Page Count 21  
paper  
  adding 80  
  specifications 131  
  when out of 16  
phone  
  see handset  
photoconductor  
  replacing 90  
photos  
  copying 73

faxing 19  
polling  
  cancel 42  
  power 133, 145  
  Power supply iii  
printing  
  sender's CSI/RTI 61, 126  
  stored message 16, 43  
Printing a file from memory 43  
problems 100  
  communication 108  
  document jams 101  
  error codes 115  
  indicator 100  
  operation 110  
  print/copy jams 102  
Programming  
  Daylight Saving Time 151  
pulse line 149

**Q**

quick dial  
  erasing a 31  
  storing 28  
  tone key 61

**R**

RDS (Remote Diagnostic System) 109  
reception 14  
  authorized 53  
  substitute 16  
reducing 70  
reduction  
  length reduction 108  
report  
  communication failure 48  
  communication result 48  
  error 48  
  format 49  
  list of files 50  
  list of numbers 51  
  memory storage 47  
  power failure 47  
  TCR 47, 50  
  transmission result 48  
reports 47 - 51  
  automatic 47  
resolution  
  see detail  
RTI 146

**RTI/TTI**

  entering characters for 130

**S**

saving  
  toner 126  
saving energy 57  
send later 20  
  cancel 42  
  printing 43  
sending  
  see faxing  
side cassette  
  extension 155  
  installation 152  
solutions 100  
sound volume 128  
specifications  
  general 133  
  paper & documents 131  
speed dial  
  erasing 36  
  storing 32  
Stamp  
  replacing 93  
  Use during transmission 25  
stored message  
  printing 43  
stored numbers  
  printing 51  
storing numbers 28  
  in groups 37  
  quick dial 28  
  speed dial 32  
storing numbers  
  capacity 132  
substitute reception 126  
substitute reception 16

**T**

TCR 47, 50  
time & date 150  
timer  
  night 57  
tonal signals 61, 149  
tone line 149  
toner  
  adding 86  
  saving 126  
  when out of 16  
Transmission

## **INDEX & GLOSSARY**

---

Memory 5  
Using Redial 27  
troubleshooting 100  
TSI  
  printing 61, 126  
TTI 146  
TTI On/Off 22

### **U**

user parameters 121 - 126

### **V**

Verification Stamp 25  
volume 128

## Mini-Glossary

**CSI:** Called Station Identification. This is your fax number, programmed in your machine for identification purposes. During a communication, it appears on the other party's display, and vice versa. By international law, the CSI must be programmed in your machine before you connect it to the public phone network. The CSI consists of your fax number, and should include the country and area codes, but not hyphens.

**TTI:** Transmitting Terminal Identification. This is the identification printed at the header of every page you send. It should be identical to the RTI (see below). By American law, a TTI must appear on every page sent from, to, or within the USA.

**RTI:** Receiving Terminal Identification This is a 20 character identification, such as your name or company name. The RTI replaces the CSI during a communication if the other party's machine is compatible with this function. (This is legal).

**TCR:** Transmission Confirmation Report. A report generated by your fax machine to attest to the success or failure of all communications, including receptions.

**Wild cards:** A wild card is a partial RTI or CSI. A caller whose RTI or CSI contains the wild card will be treated differently (e.g. for authorized reception, see page 53).

## Certification Label

The certification is located behind the machine.

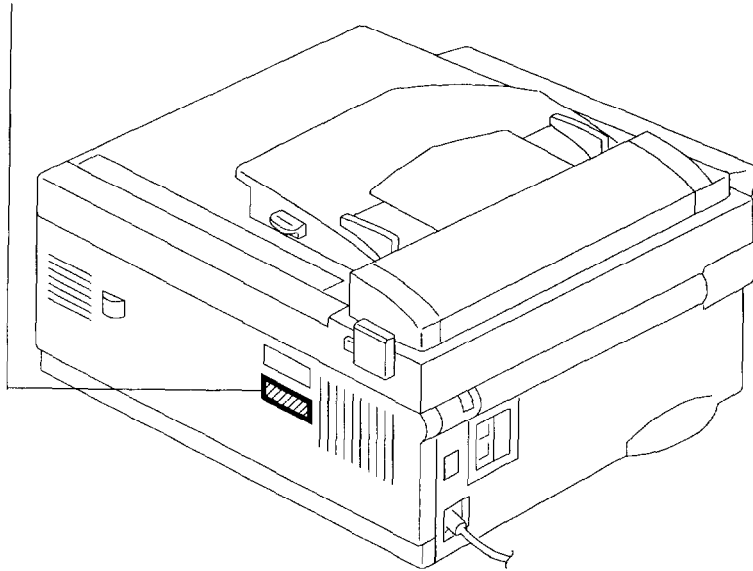

The label says:

<p>RICOH UNITECHNO CO., LTD. 713 TSURUGASONE YASHIO-SHI SAITAMA-KEN JAPAN.</p>	<p>Complies with FDA radiation performance standards, 21 CFR Subchapter J.</p>
<p>MANUFACTURED:</p>	 PPC2100S HS

# Faxing at a Glance

## Option key

SEND LATER	Sending or picking up a fax message later (page 20 & 22)
SET PAGES?	Setting the number of pages
TTI PRINT?	Printing an ID at the top of your message
DOCUMENT SIZE?	Selecting the scanning area

## Hints

- Problem? See page 100
- To change the toner cartridge, see page 86.
- To add paper, see page 80.
- To use the side cassette option, see page 152.
- Follow the safety instructions at the beginning of this manual.
- Use the **Function**, **◀**, and **▶** keys to navigate through functions and options.
- Use the **Yes & No** keys (**▼** & **▲**) to accept or reject settings.
- If your telephone line uses pulse dialing, see page 61 for how to generate tones.
- Use **Quick Dial keys 01 to 08** (or 11 to 18, on the left side) to enter letters and **Quick Dial key 09** (or 19) to enter spaces and symbols.

**Functions:** Press the function key followed by one of the numbers below.

11	Picking a document stored elsewhere (page 22)	61*	Initial Settings: Own telephone number RTI (a name ID sent to other machines) TTI (an ID printed on messages you send), CSI (phone ID sent to other machines). (page 146)
21	Erasing a message stored for transmission (page 42)	62*	Selecting the phone line, turning authorized reception, turning RDS and the timer on or off. (page 149)
22	Erasing instructions to pick up a document (page 42)	63*	Printing and setting user parameters (bit switch settings for a variety of functions, page 121).
31	Storing a number in one of the Quick Dial keys at left (page 28)	71*	Night timer (page 57).
32	Storing a number as a two-digit code (page 32)	72*	Copier settings (page 127).
33	Storing a group of numbers (page 37)	81*	Setting the list of specified senders (for authorized reception, page 53)
41	Checking the last 35 communications (prints out a report, page 49)	91*	Adjusting the clock (page 150).
42	Printing a list of all messages and pick-up files stored in the machine (page 50)	92*	Adjust the volume (page 128).
43	Printing a list of all the telephone numbers stored in the fax machine (page 51)	93*	Selecting a different language (page 129).
51	Printing a message stored in the machine (page 43)	94*	Counters (page 52).

Photocopy this cover and use as a quick reference.

\*These functions require the access code on page 121.





## SUPPLIES

**CAUTION:** Ricoh shall not be responsible for any damage or expense that may result from the use of parts other than recommended parts.

For good copy quality, Ricoh recommends that use genuine Ricoh toner.

### TONER CASSETTES

- RICOH TONER CASSETTE TYPE 300 is recommended for the best performance.

### STAMP

- MARKER TYPE 30 is recommended for the best performance.

### PHOTOCONDUCTOR

- RICOH PHOTOCONDUCTOR TYPE 300 is recommended for the best performance.

# RICOH

Headquarters: Ricoh Corporation, 5 Dedrick Place, West Caldwell, NJ 07006. 201-882-2000  
U.S. Government Marketing: Ricoh Corporation, 1700 N. Moore Street, Suite 1200, Arlington, VA 22209. 703-525-3234  
Ricoh Company Ltd., 15-5, Minami-Aoyama 1-Chome, Minato-ku, Tokyo 107, Japan



Part No. H5228600 Printed in Japan



## USA

### FCC Requirements

1. This equipment complies with Part 68 of the FCC rules. On the cover of this equipment is a label that contains, among other information, the FCC registration number and ringer equivalence number (REN) for this equipment. If requested, this information must be provided to the telephone company.
2. This equipment uses the following USOC jack: RJ11C
3. The REN is used to determine the quantity of devices which may be connected to the telephone line. Excessive REN's on the telephone line may result in the devices not ringing in response to an incoming call. In most, but not all areas, the sum of the REN's should not exceed five (5.0). Contact the telephone company to determine the maximum REN for the calling area.
4. If this equipment causes harm to the telephone network, the telephone company will notify you in advance that temporary discontinuance of service may be required. If advance notice is not practical, the telephone company will notify the customer as soon as possible. Also, you will be advised of your right to file a complaint with the FCC if you believe it is necessary.
5. The telephone company may make changes in its facilities, equipment, operations, or procedures that could affect the operation of the equipment. If this happens, the telephone company will provide advance notice in order for you to make necessary modifications in order to maintain uninterrupted service.
6. In the event of operation problems (document jam, copy jam, communication error indication), refer to the solving problems section in this manual.
7. If you cannot correct the problem, please contact the RICOH CORP. CUSTOMER SUPPORT DEPT. at 1-800-FASTFIX for repair and warranty information. If it is causing harm to the telephone network, the telephone company may request you to disconnect the equipment from the network until the problem is resolved.
8. This equipment cannot be used on telephone company-provided coin service. Connection to Party Line Service is subject to state tariffs.

### WHEN PROGRAMMING EMERGENCY NUMBERS AND/OR MAKING TEST CALLS TO EMERGENCY NUMBERS:

1. Remain on the line and briefly explain to the dispatcher the reason for the call before hanging up.
2. Perform such activities in the off-peak hours, such as early morning hours or late evenings.

## CANADA

The Industry Canada label identifies certified equipment. This certification means that the equipment meets certain telecommunications network protective, operational, and safety requirements. The department does not guarantee the equipment will operate to the user's satisfaction. Before installing this equipment, users should ensure that it is permissible to be connected to the facilities of the local telecommunications company. The equipment must also be installed using an acceptable method of connection. The customer should be aware that compliance with the above conditions may not prevent degradation of service in some situations.

Repairs to certified equipment should be made by an authorized Canadian maintenance facility designated by the supplier. Any repairs or alterations made by the user to this equipment, or equipment malfunctions, may give the telecommunications company cause to request the user to disconnect the equipment. Users should ensure for their own protection that the electrical ground connections of the power utility, telephone lines, and internal metallic water pipe system, if present, are connected together. This precaution may be particularly important in rural areas.

**Caution:** Users should not attempt to make such connections themselves, but should contact the appropriate electric inspection authority, or electrician, as appropriate.

The standard connecting arrangement code for this equipment is CA11A.

The Load Number (LN) assigned to each terminal device denotes the percentage of the total load to be connected to a telephone loop which is used by the device to prevent overloading. The termination of a loop may consist of any combination of devices subject only to the requirement that the sum of the load numbers of all the devices does not exceed 100.



## Free Manuals Download Website

<http://myh66.com>

<http://usermanuals.us>

<http://www.somanuals.com>

<http://www.4manuals.cc>

<http://www.manual-lib.com>

<http://www.404manual.com>

<http://www.luxmanual.com>

<http://aubethermostatmanual.com>

Golf course search by state

<http://golfingnear.com>

Email search by domain

<http://emailbydomain.com>

Auto manuals search

<http://auto.somanuals.com>

TV manuals search

<http://tv.somanuals.com>