

MP C3500/C4500
MP C3500/C4500
Aficio™ MP C3500/C4500
ISC 3535/ISC 4045

Operating Instructions Copy/Document Server Reference

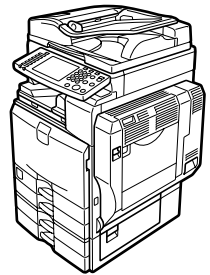

-
- 1** Placing Originals
 - 2** Copying
 - 3** Document Server
 - 4** Appendix

Read this manual carefully before you use this machine and keep it handy for future reference. For safe and correct use, be sure to read the Safety Information in "About This Machine" before using the machine.

Introduction

This manual contains detailed instructions and notes on the operation and use of this machine. For your safety and benefit, read this manual carefully before using the machine. Keep this manual in a handy place for quick reference.

Important

Contents of this manual are subject to change without prior notice. In no event will the company be liable for direct, indirect, special, incidental, or consequential damages as a result of handling or operating the machine.



Notes:

Some illustrations in this manual might be slightly different from the machine.

Certain options might not be available in some countries. For details, please contact your local dealer.



Caution:

Use of controls or adjustments or performance of procedures other than those specified in this manual might result in hazardous radiation exposure.

Notes:

The model names of the machines do not appear in the following pages. Check the type of your machine before reading this manual. (For details, see “Machine Types”, About This Machine.)

- Type 1: MP C3500/Aficio MP C3500/ISC 3535
- Type 2: MP C4500/Aficio MP C4500/ISC 4045

Certain types might not be available in some countries. For details, please contact your local dealer.

Depending on which country you are in, certain units may be optional. For details, please contact your local dealer.

Two kinds of size notation are employed in this manual. With this machine refer to the metric version.

For good copy quality, the supplier recommends that you use genuine toner from the supplier.

The supplier shall not be responsible for any damage or expense that might result from the use of parts other than genuine parts from the supplier with your office products.

Manuals for This Machine

Refer to the manuals that are relevant to what you want to do with the machine.

❖ **About This Machine**

Be sure to read the Safety Information in this manual before using the machine. This manual provides an introduction to the functions of the machine. It also explains the control panel, preparation procedures for using the machine, how to enter text, and how to install the CD-ROMs provided.

❖ **General Settings Guide**

Explains User Tools settings, and Address Book procedures such as registering fax numbers, e-mail addresses, and user codes. Also refer to this manual for explanations on how to connect the machine.

❖ **Troubleshooting**

Provides a guide to solving common problems, and explains how to replace paper, toner, staples, and other consumables.

❖ **Security Reference**

This manual is for administrators of the machine. It explains security functions that the administrators can use to protect data from being tampered, or prevent the machine from unauthorized use. Also refer to this manual for the procedures for registering administrators, as well as setting user and administrator authentication.

❖ **Copy/ Document Server Reference**

Explains Copier and Document Server functions and operations. Also refer to this manual for explanations on how to place originals.

❖ **Facsimile Reference**

Explains Facsimile functions and operations.

❖ **Printer Reference**

Explains Printer functions and operations.

❖ **Scanner Reference**

Explains Scanner functions and operations.

❖ **Network Guide**

Explains how to configure and operate the machine in a network environment, and use the software provided.

This manual covers all models, and includes descriptions of functions and settings that might not be available on this machine. Images, illustrations, and information about operating systems that are supported might also differ slightly from those of this machine.

❖ Other manuals

- Quick Reference Copy Guide
- Quick Reference Fax Guide
- Quick Reference Printer Guide
- Quick Reference Scanner Guide
- PostScript3 Supplement
- UNIX Supplement
- Manuals for DeskTopBinder Lite
 - DeskTopBinder Lite Setup Guide
 - DeskTopBinder Introduction Guide
 - Auto Document Link Guide

Note

- Manuals provided are specific to machine types.
- Adobe Acrobat Reader/Adobe Reader must be installed in order to view the manuals as PDF files.
- For “UNIX Supplement”, please visit our Web site or consult an authorized dealer.
- “PostScript3 Supplement” and “UNIX Supplement” include descriptions of functions and settings that might not be available on this machine.

What You Can Do with This Machine

<Colour Functions/Colour Adjustments>

Colour Copying

You can switch the colour copy mode depending on the type of originals used and the desired finish.

See p.40 "Selecting a Colour Mode".

❖ Full Colour Copy

Copies using four colours: yellow, magenta, cyan and black.



AMF033S

❖ Black/White Copy

Copies in black and white even if the original is coloured.

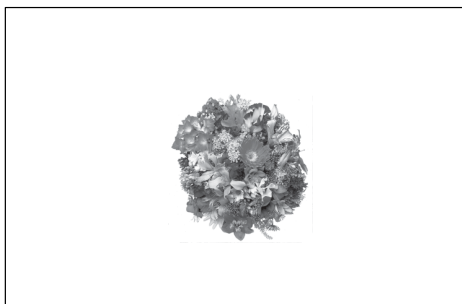

AMF034S

❖ Convert Colours

See p.41 "Convert Colours".

Copies by changing a specific colour in the original to another colour.

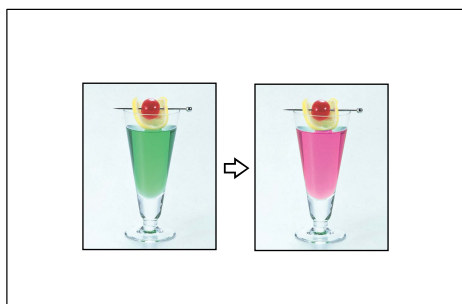

AMF038S

❖ **Erase Specified Colour**

See p.42 “Erase Colour”.

Copies by deleting a specific colour in the original.

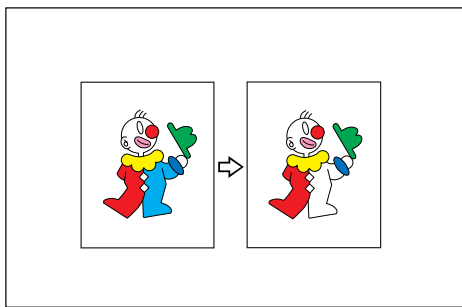

AMF039S

❖ **Colour Background**

See p.43 “Colour Background”.

Copies by adding a colour to the whole page.

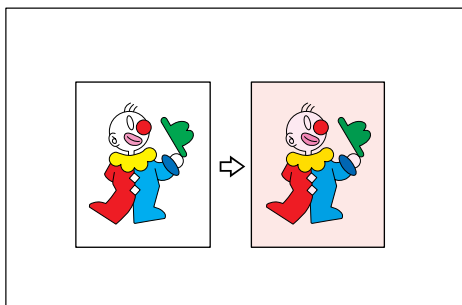

AMF040S

Stamping on Copies

Copies with the date, page numbers, etc. The stamp colour can be yellow, red, cyan, magenta, green, blue, and black.

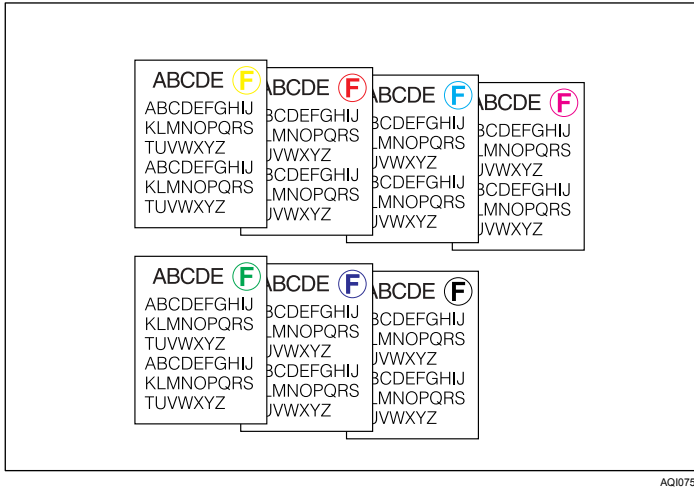

Printed inserts types:

- ❖ **Background Numbering**
See p.107 “Background Numbering”.
- ❖ **Preset Stamp**
See p.108 “Preset Stamp”.
- ❖ **User Stamp**
See p.111 “User Stamp”.
- ❖ **Date Stamp**
See p.116 “Date Stamp”.
- ❖ **Page Numbering**
See p.119 “Page Numbering”.

Adjusting Colours

See p.47 "Colour Adjustment".

❖ Primary Colours

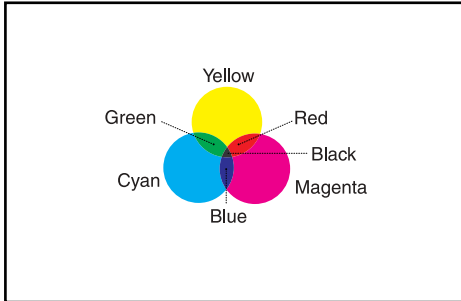

Colours can be created by combining the 3 primary colours: yellow, magenta and cyan. Black can be made by combining yellow, magenta and cyan, however, as there might be some slight differences, "black" will be expressed using a black toner.

❖ Adjust Colour

Adjusts the specific colours (yellow, red, magenta, blue, cyan and green) by mixing them with adjacent colours in the colour circle. See p.47 "Colour Adjustment".

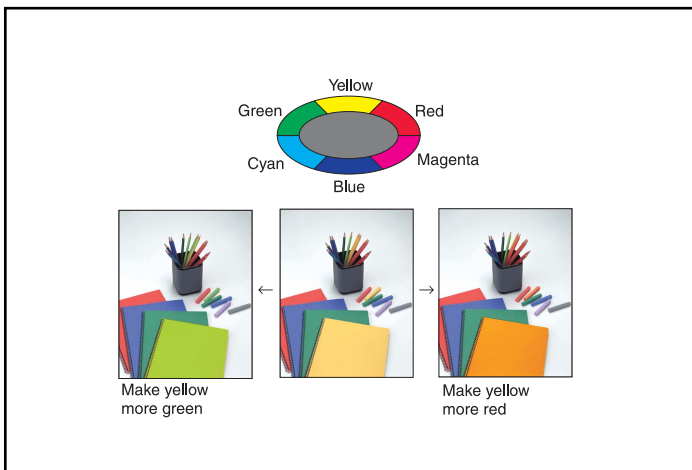

❖ Colour Balance

Adjusts the overall colour tone of copies.

See p.44 “Colour Balance”.

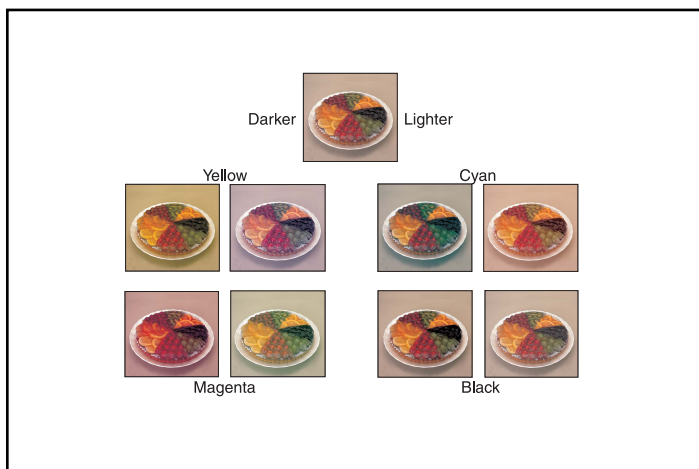

AMA015S

Adjusting Images

See p.48 “Image Adjustment”.

❖ Sharp/Soft

Adjusts the outline of the image.

See p.50 “Adjusting the sharpness/softness”.

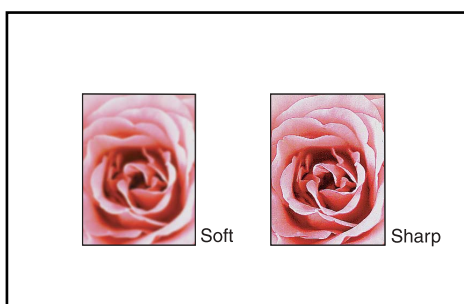

AMA016S

❖ Contrast

Adjusts the shades of the image.

See p.50 “Adjusting the contrast”.

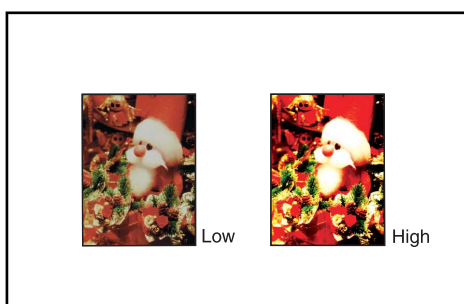

AMA017S

❖ Background Density

Adjusts the background density of the image.
See p.51 “Adjusting the background density”.

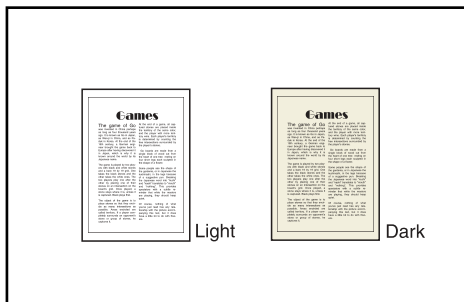

AMA018S

❖ Other Adjustments

- Adjust U.C.R.
See p.51 “Adjusting the U.C.R.”.
- Text/Photo Sensitivity
See p.52 “Adjusting the Text/Photo sensitivity”.

What You Can Do with This Machine

Functions differ depending on machine type and options.

Reference

See p.3 “Functions Requiring Optional Configurations”.

Types of Duplex Copies

❖ 1 Sided 2 Pages → 2 Sided 1 Page

See p.83 “Duplex”.

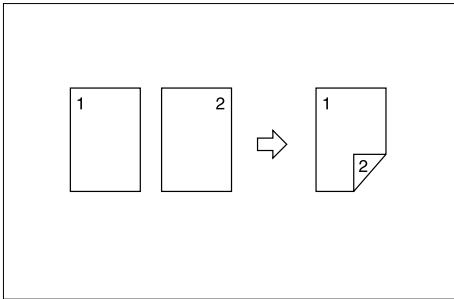

❖ 2 Sided 1 Page → 2 Sided 1 Page

See p.83 “Duplex”.

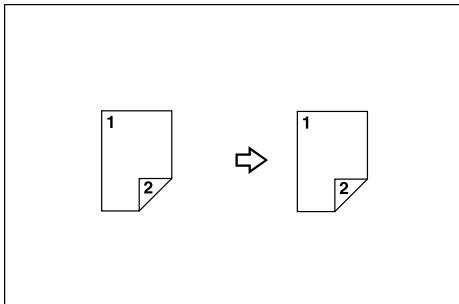

❖ 1 Sided 4 Pages → Combine 2 Sided 1 Page

See p.89 “Two-Sided Combine”.

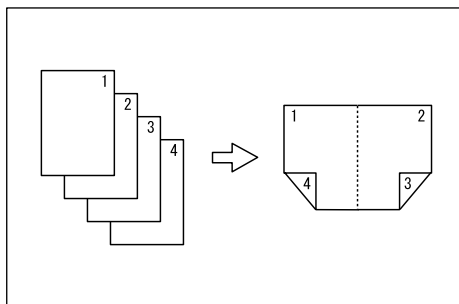

GCSHVY9J

❖ **1 Sided 8 Pages → Combine 2 Sided 1 Page**

See p.89 “Two-Sided Combine”.

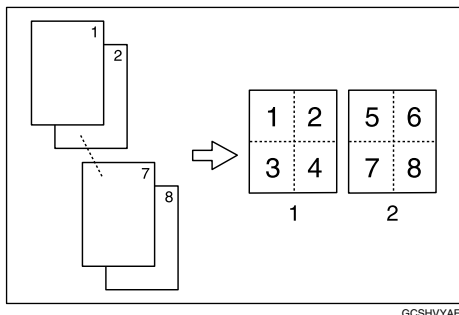

GCSHVYAE

1 Front
2 Back

❖ **2 Sided 16 Pages → Combine 2 Sided 1 Page**

See p.89 “Two-Sided Combine”.

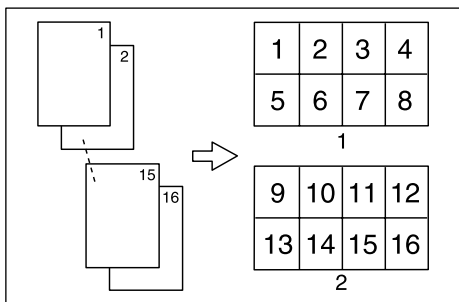

GCSHVYSE

1 Front
2 Back

❖ **2 Sided 2 Pages → Combine 2 Sided 1 Page**

See p.89 “Two-Sided Combine”.

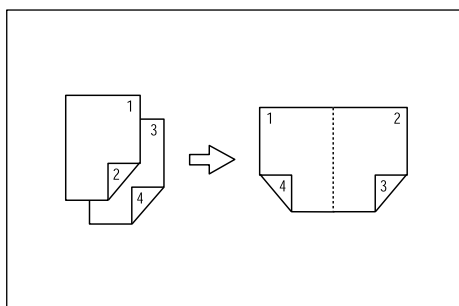

GCSHVY1E

❖ **2 Sided 4 Pages → Combine 2 Sided 1 Page**
 See p.89 “Two-Sided Combine”.

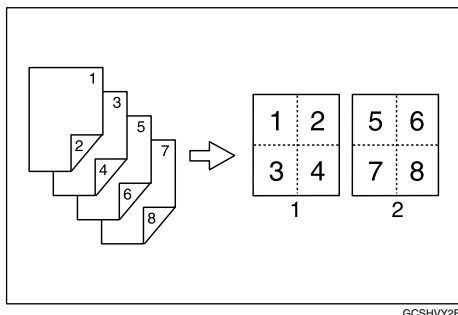

GCSHVY2E

1 Front
 2 Back

❖ **2 Sided 8 Pages → Combine 2 Sided 1 Page**
 See p.89 “Two-Sided Combine”.

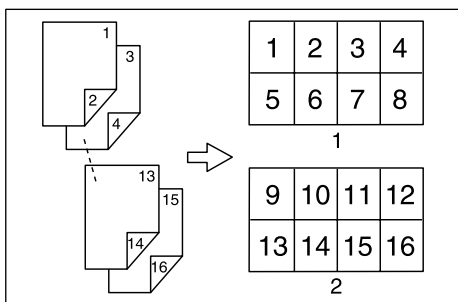

GCSHVY6E

1 Front
 2 Back

❖ **Bound Originals → 2 Sided 1 Page**
 See p.94 “Booklet/Magazine”.

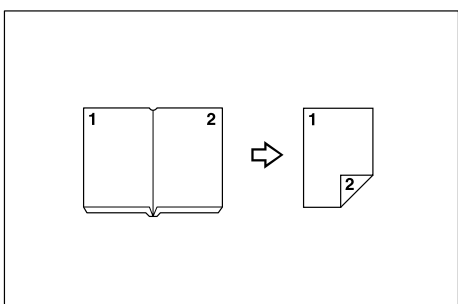

❖ **Front & Back Bound Originals → 2 Sided Pages**

See p.94 “Booklet/Magazine”.

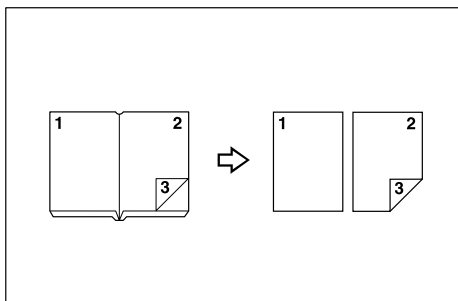

Copying Book Originals

❖ **1 Sided 4 Pages → Booklet**

See p.94 “Booklet/Magazine”.

- Open to left

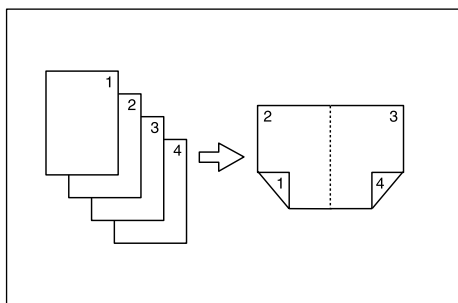

GCBOOKGE

- Open to right

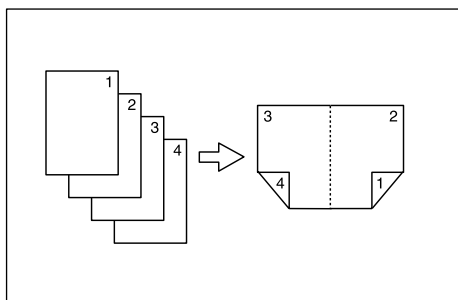

GCBOOK1E

❖ **2 Sided 2 Pages → Booklet**

See p.94 “Booklet/Magazine”.

- Open to left

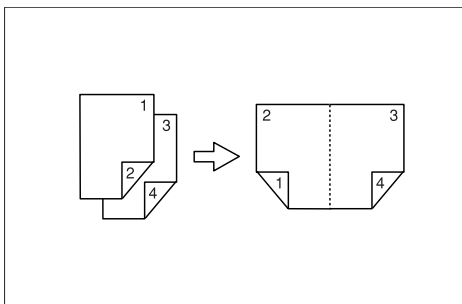

GCAH010E

- Open to right

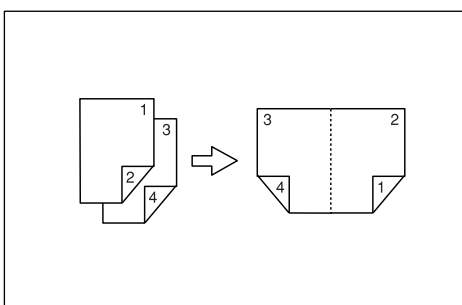

GCAH020E

❖ **1 Sided → Magazine**

See p.94 “Booklet/Magazine”.

- Open to left

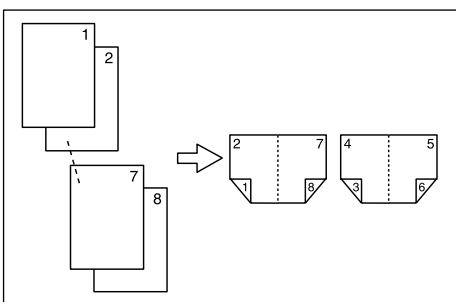

GCBOOK3E

- Open to right

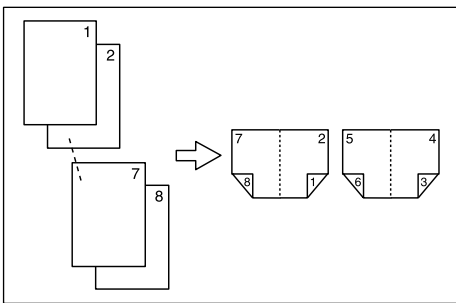

GCBOOK4E

❖ 2 Sided → Magazine

See p.94 “Booklet/Magazine”.

- Open to left

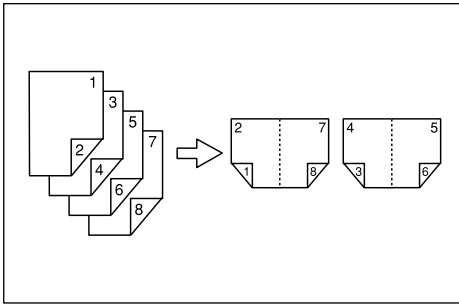

GCAH030E

- Open to right

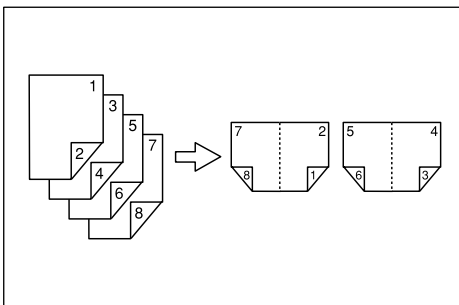

GCAH040E

Combining Multiple Pages onto a Single Page

See p.87 "One-Sided Combine".

❖ **1 Sided 2 Pages → Combine 1 Sided 1 Page**

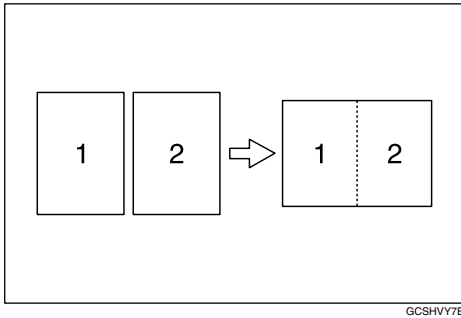

❖ **1 Sided 4 Pages → Combine 1 Sided 1 Page**

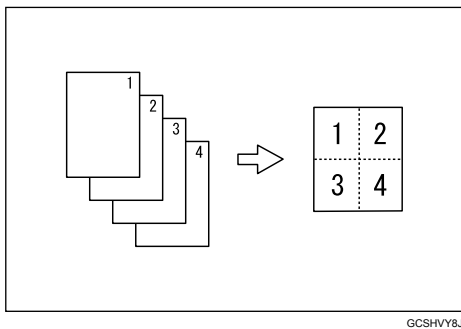

❖ **1 Sided 8 Pages → Combine 1 Sided 1 Page**

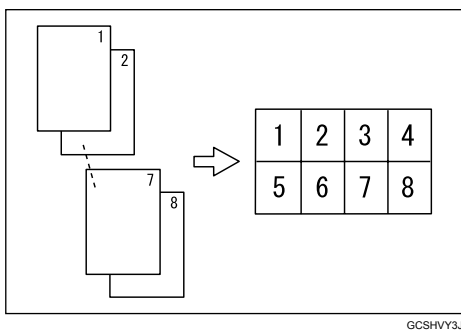

❖ **2 Sided 1 Page → Combine 1 Sided 1 Page**

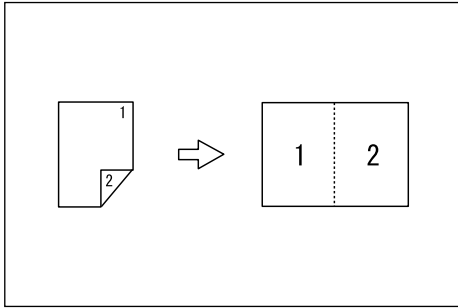

GCSHVYQJ

❖ **2 Sided 2 Pages → Combine 1 Sided 1 Page**

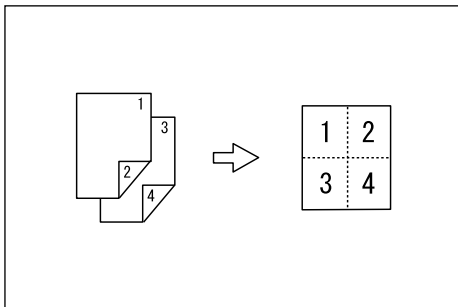

GCSHVYBJ

❖ **2 Sided 4 Pages → Combine 1 Sided 1 Page**

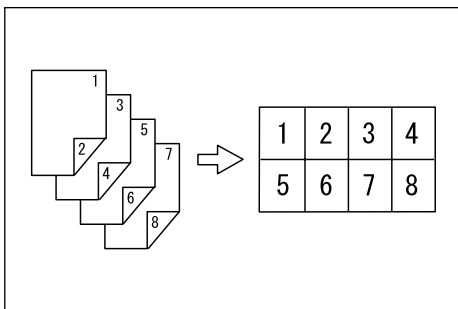

GCSHVY4J

Copying Originals Such as Books

❖ Bound Originals → 1 Sided 2 Pages

See p.92 "Series Copies".

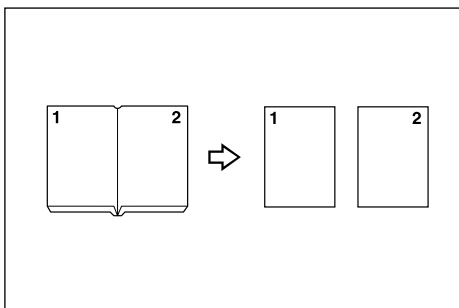

CP2B0100

❖ Bound Originals → 2 Sided 1 Page

See p.94 "Booklet/Magazine".

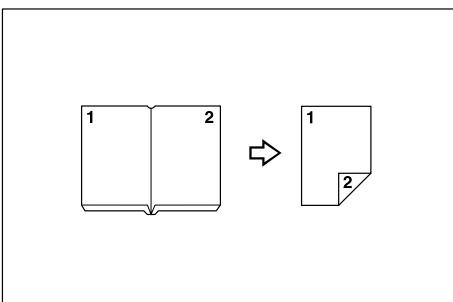

❖ Front & Back Bound Originals → 2 Sided Pages

See p.94 "Booklet/Magazine".

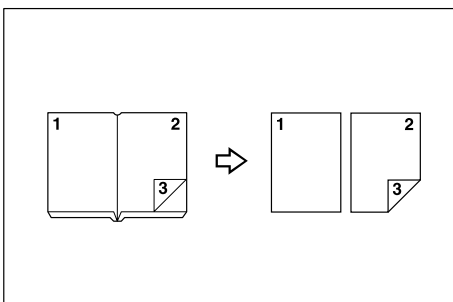

Copying 2-Sided Pages onto 1-Sided Pages

See p.92 "Series Copies".

❖ **2 Sided 1 Page → 1 Sided 2 Pages**

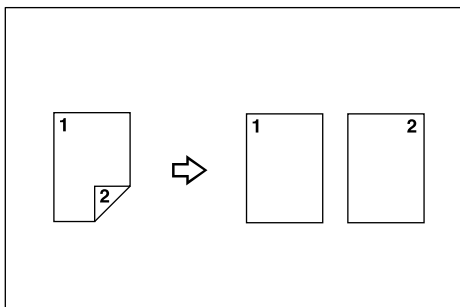

CP2B0200

Copying onto Thick Paper

❖ **Copying onto Thick Paper**

See p.38 "When Copying onto Thick Paper".

TABLE OF CONTENTS

Manuals for This Machine	i
What You Can Do with This Machine <Colour Functions/Colour Adjustments>	iii
Colour Copying	iii
Stamping on Copies.....	v
Adjusting Colours	vi
Adjusting Images.....	vii
What You Can Do with This Machine	ix
Types of Duplex Copies	ix
Copying Book Originals.....	xii
Combining Multiple Pages onto a Single Page	xv
Copying Originals Such as Books.....	xvii
Copying 2-Sided Pages onto 1-Sided Pages.....	xviii
Copying onto Thick Paper.....	xviii
Notice	1
How to Read This Manual	2
Symbols	2
Functions Requiring Optional Configurations	3
Display	4
Simplified Display	5
User Tools Menu (Copier / Document Server Features)	6

1. Placing Originals

Originals	11
Sizes and Weights of Recommended Originals.....	11
Sizes Detectable by the Auto Paper Select	13
Missing Image Area	14
Placing Originals	15
Original Orientation	16
Placing Originals on the Exposure Glass.....	17
Placing Originals in the Auto Document Feeder	18
Batch Mode	20
SADF Mode.....	21
Mixed Size Mode.....	22
Original Size.....	23

2. Copying

Basic Procedure	25
Interrupt Copy	26
Left Original Beeper	27
Job Preset.....	27
Job List	28
Job List Screen	29
Checking Jobs in the Print Queue.....	30
Changing the Order of Jobs	30
Holding Print Jobs	31
Deleting Jobs	31
Checking Job History	32

Copying from the Bypass Tray	33
When Copying onto Regular Size Paper	35
When Copying onto Custom Size Paper.....	36
When Copying onto OHP Transparencies or Thin Paper	37
When Copying onto Thick Paper	38
When Copying onto Envelopes.....	39
Colour Functions	40
Selecting a Colour Mode.....	40
Convert Colours	41
Erase Colour	42
Colour Background	43
Colour Balance.....	44
Colour Balance Program.....	45
Colour Adjustment.....	47
Image Adjustment	48
User Colour	53
Copier Functions	57
Adjusting Copy Image Density	57
Selecting the Original Type Setting.....	59
Selecting Copy Paper	60
Preset Reduce/Enlarge	63
Zoom	65
Auto Reduce/Enlarge	67
Size Magnification	68
Directional Magnification (%)	69
Directional Size Magnification (mm).....	71
Sort.....	72
Stack	76
Staple	78
Punch	81
Duplex	83
One-Sided Combine.....	87
Two-Sided Combine.....	89
Series Copies.....	92
Booklet/Magazine.....	94
Margin Adjustment	100
Erase.....	101
Background Numbering	107
Preset Stamp	108
User Stamp	111
Date Stamp	116
Page Numbering	119
Image Repeat.....	126
Double Copies.....	129
Centring.....	130
Positive/Negative	132
Mirror.....	133
Covers.....	134
Designate	136
Chapters.....	137
Slip Sheets	138
Storing Data in the Document Server	140

Programs	142
Storing a Program	143
Changing a Stored Program	144
Deleting a Program	145
Recalling a Program.....	145
Programming Defaults in Initial Display	146

3. Document Server

Relationship between Document Server and Other Functions	147
Document Server Display	148
Simplified Display	150
Preview Display.....	151
Using the Document Server.....	152
Storing Data	152
Changing User Name, File Name or Password of a Stored Document	157
Checking the Details of a Stored Document	158
Searching for a Stored Document.....	159
Printing a Stored Document	162
Deleting a Document.....	168
Displaying a Document in Document Server with Web Image Monitor.....	169
Downloading Stored Documents.....	170

4. Appendix

Function Compatibility	171
Supplementary Information	173
INDEX.....	184

Notice

Do not copy or print any item for which reproduction is prohibited by law.

Copying or printing the following items is generally prohibited by local law: bank notes, revenue stamps, bonds, stock certificates, bank drafts, checks, passports, driver's licenses.

The preceding list is meant as a guide only and is not inclusive. We assume no responsibility for its completeness or accuracy. If you have any questions concerning the legality of copying or printing certain items, consult with your legal advisor.

The colour samples in this manual may differ slightly from the colours of actual copies.

Colours on colour keys or the colour circle may differ slightly from the colours of actual copies.

This machine is equipped with a function that prevents making counterfeit bank bills. Due to this function the original images similar to bank bills may not be copied properly.

How to Read This Manual

Note

- ❑ For proper use of this product, be sure to read About This Machine first.
- ❑ Supplementary information about the copier mode is described in “Supplementary Information”.

Reference

p.173 “Supplementary Information”
About This Machine

Symbols

This manual uses the following symbols:

WARNING:

Indicates important safety notes.

Ignoring these notes could result in serious injury or death. Be sure to read these notes. They can be found in the “Safety Information” section of About This Machine.

CAUTION:

Indicates important safety notes.

Ignoring these notes could result in moderate or minor injury, or damage to the machine or to property. Be sure to read these notes. They can be found in the “Safety Information” section of About This Machine.

Important

Indicates points to pay attention to when using the machine, and explanations of likely causes of paper misfeeds, damage to originals, or loss of data. Be sure to read these explanations.

Note

Indicates supplementary explanations of the machine's functions, and instructions on resolving user errors.

Reference

This symbol is located at the end of sections. It indicates where you can find further relevant information.

[]

Indicates the names of keys that appear on the machine's display panel.

[]

Indicates the names of keys on the machine's control panel.

Functions Requiring Optional Configurations

Certain functions require special machine configuration and extra options as follows:

Stack: SR790, Booklet Finisher SR3020 or Finisher SR3030

Staple: SR790, Booklet Finisher SR3020 or Finisher SR3030

Staple (Centre): Booklet Finisher SR3020

Punch: Booklet Finisher SR3020 or Finisher SR3030, Punch kit

Note

The bridge unit and paper tray unit are required when you install the finisher.

Display

The function items displayed serve as selector keys. You can select or specify an item by lightly pressing them.

When you select or specify an item on the display panel, it is highlighted like **Auto Density**. Keys appearing as **Backspace** cannot be used.

❖ Initial copy display

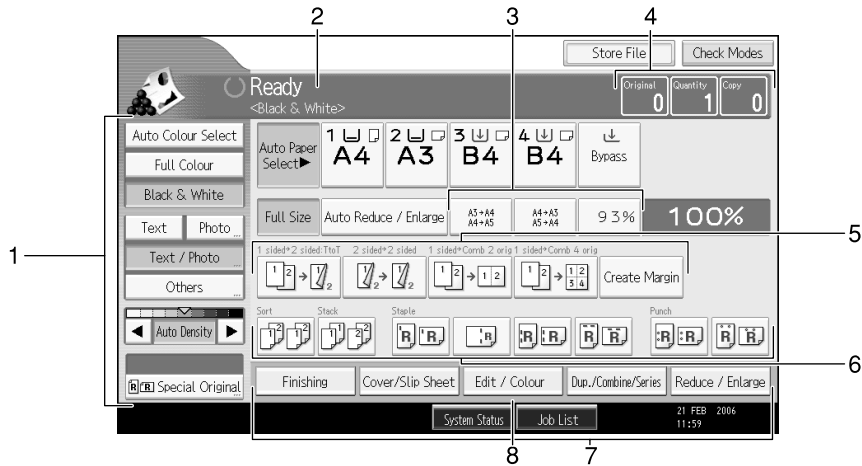

AQI062S

1. Original function, Image Density and Special Original function.

2. Operational status and messages.

3. You can register up to three frequently used reduce/enlarge ratios other than the fixed reduce/enlarge ratios. See "Reproduction Ratio", General Settings Guide.

4. Numbers of originals scanned into memory, copies set, and copies made.

5. Displays contents of the Shortcut keys. You can register frequently used functions in these keys. See "Copier / Document Server Features", General Settings Guide.

6. Sort, Stack, Staple, and Punch functions.

7. Displays available functions. Press a function name to display its menu. For example, press [Reduce / Enlarge] to switch to the Reduce/Enlarge menu.

8. A clip mark indicates the currently selected function.

Simplified Display

This section explains how to use the “Simplified Display” and introduces its keys.

You can view the simplified display from the Copier's initial screen by pressing the **[Simplified Display]** key.

The simplified display contains main functions only.

Enlarged characters and keys make for easier operation.

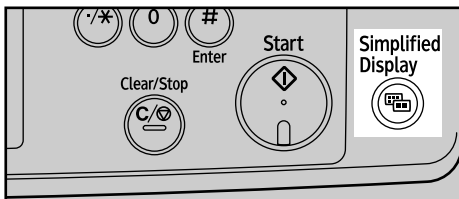

AQI032S

❖ Simplified Copier Screen

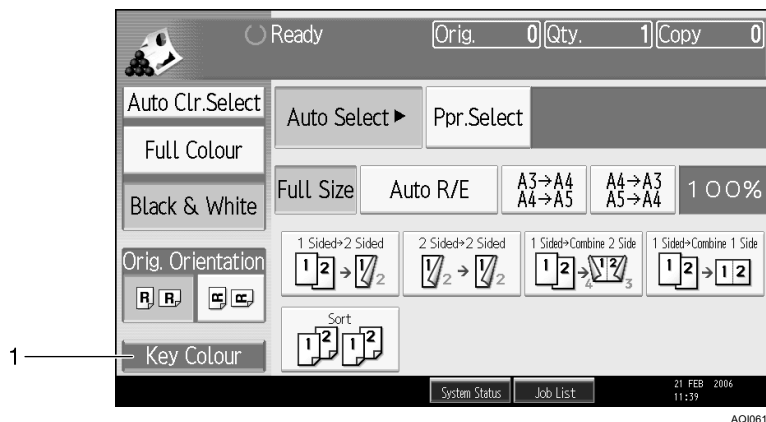

1. [Key Colour]

Use this to intensify the screen contrast by changing the colour of the keys.

Not available on the copier default screen.

Note

- Press the **[Simplified Display]** key again to return to the copier default screen.
- The simplified display screen does not contain every available key.

User Tools Menu (Copier / Document Server Features)

This section describes items that can be specified on the Copier / Document Server Features screen. The Copier / Document Server Features screen can be displayed by pressing the **[User Tools/Counter]** key. For details about how to set up these items, see General Settings Guide.

❖ General Features

Item	Description
Auto Image Density Priority	Select whether Auto Image Density is automatically applied after power on, when modes are cleared or reset, or a colour selection key is pressed.
Original Type Priority	Specify the original type that is automatically selected after power on, when modes are cleared or reset, or when a colour selection key is pressed.
Original Photo Type Priority	When you select "Text / Photo" or "Photo" in "Original Type Priority", you can change the settings of the selected original type.
Original Type Display	You can have the original types shown on the initial display.
Paper Display	You can choose to have the available paper trays and sizes shown on the initial display.
Original Orientation in Duplex Mode	You can set the original orientation when making two-sided copies.
Copy Orientation in Duplex Mode	You can set the copy orientation when making two-sided copies.
Max. Copy Quantity	You can set the maximum copy quantity.
Auto Tray Switching	If you load paper of the same size in two or more trays, the machine automatically shifts to the other when the first tray runs out of paper (when Auto Paper Select is selected.) This function is called "Auto Tray Switching". This setting specifies whether to use Auto Tray Switching or not.
Tone: Original Remains	The beeper (key tone) sounds if you forget to remove originals after copying.
Job End Call	You can choose to have the beeper sound when copying is complete.
Customize Function: Copier	Register up to six frequently used functions and display them on the initial screen. (Registered functions can be changed.)
Customize Function: Document Server Storage	Register up to six frequently used functions and display them on the initial screen. (Registered functions can be changed.)

❖ Reproduction Ratio

Item	Description
Shortcut R / E	You can register up to three frequently used Reduce/Enlarge ratios other than the fixed Reduce/Enlarge ratio and have them shown on the initial display. You can also change registered Reduce/ Enlarge ratios.
R / E Ratio	Specify the enlargement and reduction ratios that appear on the copier screen when you press [Reduce / Enlarge] .
R / E Ratio Priority	Specify the enlargement and reduction ratios that are prioritized when you press [Reduce / Enlarge] .
Ratio for Create Margin	You can set a Reduce/Enlarge ratio when registering Create Margin in a shortcut key.

❖ Edit

Item	Description
Front Margin: Left / Right	You can specify left and right margins on the front side of copies using the Margin Adjustment function.
Back Margin: Left / Right	You can specify left and right margins on the back side of copies using the Margin Adjustment function.
Front Margin: Top / Bottom	You can specify top and bottom margins on the front side of copies using the Margin Adjustment function.
Back Margin: Top / Bottom	You can specify top and bottom margins on the back side of copies using the Margin Adjustment function.
1 Sided → 2 Sided Auto Margin: TtoT	When using the 1 sided → 2 sided Duplex function, you can specify margins on the back side.
1 Sided → 2 Sided Auto Margin: TtoB	When using the 1 sided → 2 sided Duplex function, you can specify margins on the back side.
Erase Border Width	You can specify the width of erased border margins using this function.
Erase Original Shadow in Combine	In Combine Copy or Booklet/Magazine Copy mode, you can specify whether to erase a 3 mm, 0.1" bounding margin around all four edges of each original.
Erase Centre Width	You can specify the width of the erased centre margins using this function.
Front Cover Copy in Combine	You can make a combined copy on the front cover sheet when you select the Front Cover function.
Copy Order in Combine	You can set the copy order when using the Combine function to Left to Right or Top to Bottom.
Orientation: Booklet, Magazine	You can select the orientation of copies to open when using Booklet or Magazine function.
Copy on Designating Page in Combine	You can make a combined copy on the inserted slip sheets when using the Desig./Chapter Copy function.
Image Repeat Separation Line	You can select a separation line used in the Image Repeat function from: None, Solid, Broken A, Broken B, or Crop Marks.
Double Copies Separation Line	You can select a separation line used in the Double Copies function from: None, Solid, Broken A, Broken B, or Crop Marks.
Separation Line in Combine	You can select a separation line used in the Combine function from: None, Solid, Broken A, Broken B, or Crop Marks.

❖ Stamp

Item	Description
Background Numbering	
Size	You can set the size of the numbers.
Density	You can set the density of the numbers.
Stamp Colour	You can set the colour of the numbers.
Preset Stamp	
Stamp Language	You can select the language of the stamp.
Stamp Priority	You can select the stamp type given priority when [Preset Stamp] is pressed.
Stamp Format	You can adjust the stamp printing quality ("COPY", "URGENT", "PRIORITY", "For Your Info.", "PRELIMINARY", "For Internal Use Only", "CONFIDENTIAL", "DRAFT").
Stamp Colour	You can specify the stamp printing colour ("COPY", "URGENT", "PRIORITY", "For Your Info.", "PRELIMINARY", "For Internal Use Only", "CONFIDENTIAL", "DRAFT").
User Stamp	
Program / Delete Stamp	You can register, change, or delete these user stamp designs.
Stamp Format: 1 to 4	You can set the position where the stamp is printed.
Stamp Colour: 1 to 4	Select which colour to prioritize for printing User Stamps 1 to 4.
Date Stamp	
Format	You can select the date format for the Date Stamp function.
Font	You can select the Date Stamp font.
Size	You can set the Date Stamp size.
Superimpose	You can have the Date Stamp printed in white where it overlaps black parts of the image.
Stamp Colour	You can set the selected priority colour when printing the date.
Stamp Setting	You can have the date printed on the first page or all pages.
Page Numbering	
Stamp Format	You can select the page number format given priority when [Page Numbering] is pressed.
Font	You can select the page number font.
Size	You can set the size of the page number.
Duplex Back Page Stamping Position	You can set the position of the duplex back page number printed using the Duplex function.
Page Numbering in Combine	You can set page numbering when using the Combine and Page Numbering function together.
Stamp on Designating Slip Sheet	You can print the page number onto designating slip sheets when using the Designate function and the Page Numbering function together.
Stamp Position:P1,P2...	You can set the position where the stamp is printed.
Stamp Position:1/5,2/5...	You can set the position where the stamp is printed.

Item	Description
Stamp Position:-1,-2-...	You can set the position where the stamp is printed.
Stamp Position:P.1,P.2...	You can set the position where the stamp is printed.
Stamp Position:1,2...	You can set the position where the stamp is printed.
Stamp Position:1-1,1-2...	You can set the position where the stamp is printed.
Superimpose	You can have page numbers printed in white where they overlap black parts of the image.
Stamp Colour	You can set the selected priority colour when printing the date.
Page Numbering Initial Letter	You can select the page numbering initial letter between "P.1, P.2.../P.1, P.2..." and "S1, S2.../S.1, S.2...".

❖ Input / Output

Item	Description
Switch to Batch	You can select to have either [Batch] or [SADF] displayed when you press [Special Original] .
SADF Auto Reset	When you set one original at a time in the ADF, the Auto Feed indicator lights for a specified time after an original is fed, to show the ADF is ready for another original.
Rotate Sort: Auto Paper Continue	You can continue copying when paper of the required orientation has run out during rotate-sorting.
Memory Full Auto Scan Restart	If memory becomes full while scanning originals, the machine will copy the scanned originals first, and then automatically proceed scanning remaining originals. You can enable or disable this function.
Letterhead Setting	If you select [Yes] for this function, the machine rotates images correctly.
Staple Position	You can select a key to appear preferentially for staple on the initial screen.
Punch Type	You can select a key to appear preferentially for punch on the initial screen.
Simplified Screen: Finishing Types	You can select a key to appear preferentially for finishing on the simplified display screen.

❖ Adjust Colour Image

Item	Description
Background Density of ADS (Full Colour / Two-colour)	The background density is adjusted to skip the texture and copy. You can adjust the background density up to 5 levels when in Full Colour.
Colour Sensitivity	You can adjust the colour specified to convert in "Convert Colour" and the colour specified for "Erase Colour", in 5 levels.
A.C.S. Sensitivity	This 5-step setting determines the level of the standard used for discriminating between black & white originals and full colour originals when "Auto Colour Select" is selected.
A.C.S. Priority	This setting determines the copy priority between "Black & White" and "Full Colour" when "Auto Colour Select" is selected.

❖ Administrator Tools

Item	Description
Menu Protect	You can prevent unauthenticated users from changing the user tools settings.

1. Placing Originals

This chapter describes the types of originals you can set and how to place originals.

Originals

This section describes the types of originals that can be placed, paper sizes that are automatically detected, and missing image area.







Note

- ❑ As the colour of markers or highlighters is difficult to reproduce, the copy might not come out depending on the colour or a different colour might be copied.







Sizes and Weights of Recommended Originals

The following describes recommended paper sizes and non-recommended originals for the ADF:

❖ Metric version

Where original is placed	Original size	Original weight
Exposure glass	Up to A3	-
ADF	One-sided originals: A3  - B6 JIS (Japanese Industrial Standard)  	40-128 g/m ² (35-110 kg)
	Two-sided originals: A3  - A5  	52-128 g/m ² (45-110 kg)

❖ Inch version

Where original is placed	Original size	Original weight
Exposure glass	Up to 11" × 17"	-
ADF	One-sided originals: 11" × 17"  - 5 ¹ / ₂ " × 8 ¹ / ₂ "  	11-34 lb.
	Two-sided originals: 11" × 17"  - 5 ¹ / ₂ " × 8 ¹ / ₂ "  	14-34 lb.

Note

- ❑ About 100 originals can be placed in the ADF.
- ❑ The weight range for originals in the Mixed size mode is 52-81.4 g/m² (13.8-22.0 lb).

Non-compatible originals for the Auto Document Feeder

1

Placing the following types of originals in the ADF can cause paper misfeeds or light & black lines or result in damage to the originals. Place these originals on the exposure glass instead.

- Originals other than those specified on “Sizes and Weights of Recommended Originals”
- Stapled or clipped originals
- Perforated or torn originals
- Curled, folded, or creased originals
- Pasted originals
- Originals with any kind of coating, such as thermal fax paper, art paper, aluminum foil, carbon paper, or conductive paper
- Originals with perforated lines
- Originals with indexes, tags, or other projecting parts
- Sticky originals such as translucent paper
- Thin, highly flexible originals
- Thick originals such as postcards
- Bound originals such as books
- Transparent originals such as OHP transparencies or translucent paper
- Originals that are still wet with ink or white-out











 **Note**

- The original might become dirty if it is written with a pencil or a similar tool.

Sizes Detectable by the Auto Paper Select

Sizes detectable by the exposure glass and ADF are:

❖ Metric version

Size	A3 	B4 JIS 	A4 	B5 JIS 	A5 	B6 JIS 	11" × 17" 	8 ¹ / ₂ " × 11" 	8 ¹ / ₂ " × 13" 	8K 	16K 
Location of the original											
Exposure glass	○	○	○	○	○ *1	×	×	×	○ *2	○ *3	○ *3
ADF	○	○	○	○	○	○	○	○	○ *2	○ *4	○ *4

○ : Detectable size × : Undetectable size











*1 If you want to make A5 size detectable, consult your service representative.

*2 You can select from 8¹/₂" × 13", 8¹/₄" × 13", 8" × 13" with User Tools (System Settings).

*3 You can select from A3 or B4 JIS to 8K, from A4, A5 or B5 JIS to 16K with User Tools (System Settings).



*4 You can select from 11" × 17" to 8K, from 8¹/₂" × 11" to 16K with User Tools (System Settings).

❖ Inch version

Size	A3 	A4 	11" × 17" 	8 ¹ / ₂ " × 14" 	8 ¹ / ₂ " × 11" 	5 ¹ / ₂ " × 8 ¹ / ₂ " 	8 ¹ / ₂ " × 13" 	11" × 15" 	10" × 14" 	8" × 10" 	7 ¹ / ₄ " × 10 ¹ / ₂ " 
Location of the original											
Exposure glass	×	×	○	○	○	○ *1	×	×	×	×	×
ADF	○	○	○	○	○	○	○ *2	○ *2	○	○ *2	○ *2

○ : Detectable size × : Undetectable size

*1 If you want to make 5¹/₂" × 8¹/₂" size detectable, consult your service representative.

*2 You can select from 8¹/₂" × 14" to 8¹/₂" × 13", from 11" × 17" to 11" × 15", from 8¹/₂" × 11"  to 8" × 10", from 8¹/₂" × 11"  to 7¹/₄" × 10¹/₂"  with User Tools (System Settings).

❖ Exposure glass

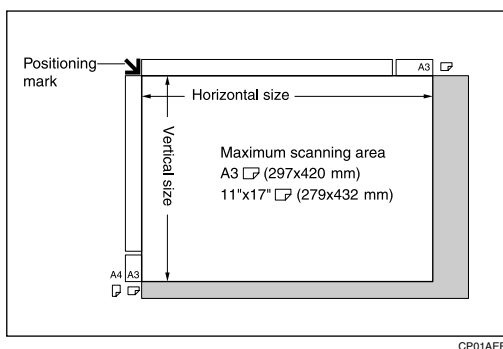

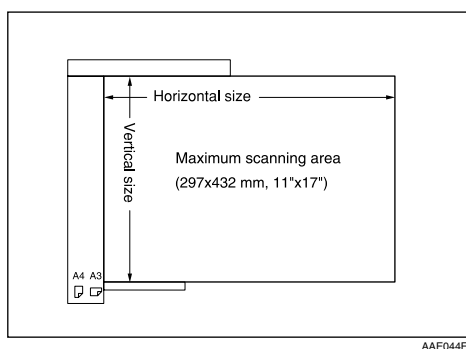
❖ ADF**📌 Note**

- ❑ When you copy custom size originals, make sure you specify the size of the originals. If not, the image may not be copied properly.

🔍 Reference

See p.24 "Custom sizes".

Sizes difficult to detect

It is difficult for the machine to detect the sizes of the following originals, so select the paper size manually:

- Originals with indexes, tags, or other projecting parts
- Transparent originals such as OHP transparencies or translucent paper
- Dark originals with a lot of text and drawings
- Originals which partially contain a solid image
- Originals which have solid images at their edges

Missing Image Area

Even if you place originals in the ADF or on the exposure glass correctly, 3 mm (0.1") margins on all four sides might not be copied.

Placing Originals

This section describes the procedure for placing originals on the exposure glass and in the ADF.

Take care to place originals after any correction fluid and ink has completely dried. Not taking this precaution could cause marks on the exposure glass that will be copied onto paper.

Note

For original sizes you can set, see “Originals”.

Reference



See p.11 “Originals”.

Original Orientation



You can set the original orientation in the following ways. When placing the original on the exposure glass, set it facing downwards.

- Standard orientation  Select this function when the original orientation is the same as the copy paper orientation.

- 90° turn 

Use this function when you want to copy A3 , B4 JIS  or 11" × 17"  size originals. The machine rotates the copy image by 90° and you can make copies as you want.

This is useful for copying large originals with the Staple, Duplex, Combine or Stamp functions.

For example, to copy A3  or 11" × 17"  originals with the Staple function selected:

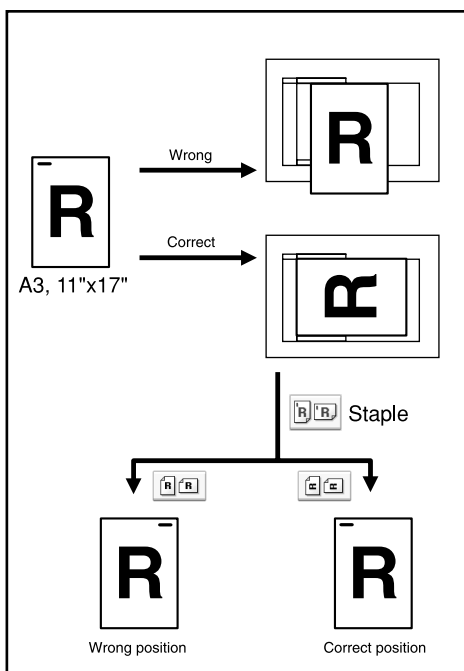

AQI079S

1 Press [Special Original].

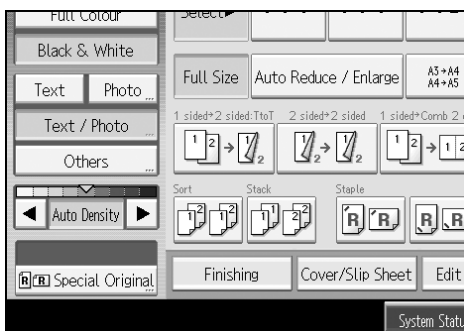

2 Select the original orientation (Ⓜ or Ⓝ), and then press [OK].

Note

- It is recommended to use this function together with the [Auto Paper Select] or [Auto Reduce / Enlarge] function.

Placing Originals on the Exposure Glass

Place originals on the exposure glass.

Important

- Do not lift the exposure glass cover or ADF forcefully. Otherwise, the cover of the ADF might open or be damaged.

1 Lift the exposure glass cover or ADF.

Be sure to lift the exposure glass cover or ADF by more than 30 degrees. Otherwise, the size of the original might not be detected correctly.

2 Place the original face down on the exposure glass. The original should be aligned to the rear left corner.

Start with the first page to be copied.

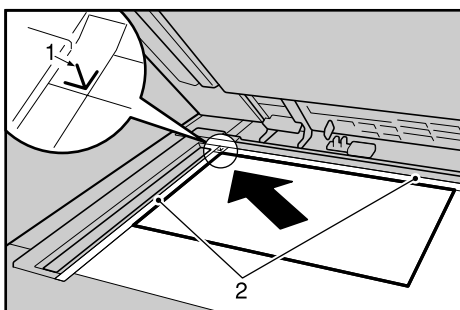

- ① Positioning mark
- ② Left scale

3 Lower the exposure glass cover or ADF.

Placing Originals in the Auto Document Feeder

Place originals in the ADF.

Settings should be made in the following situations:

- ❖ **When placing originals consisting of more than 100 pages:**
See p.20 “Batch Mode”.
- ❖ **When placing originals one by one:**
See p.21 “SADF Mode”.
- ❖ **When copying originals of various sizes:**
See p.22 “Mixed Size Mode”.
- ❖ **When placing custom size originals:**
See p.24 “Custom sizes”.

1 Adjust the guide to the original size.

2 Set the aligned originals face up into the ADF.

Do not stack originals beyond the limit mark.

The last page should be on the bottom.

Be sure not to block the sensor or load the original untidily. Doing so may cause the machine to detect the size of the scanned image incorrectly or display a paper misfeed message. Also, be sure not to place originals or other objects on the top cover. Doing so may cause a malfunction.

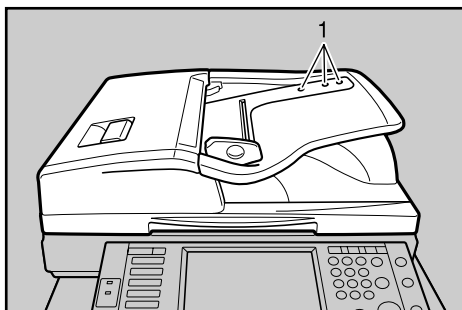

AQH011S

① Sensors

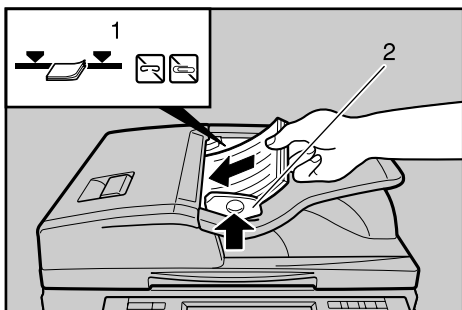

AQH012S

① Limit mark

② Document guide

Note

- Straighten curls in the originals before placing them on the ADF.
- To prevent multiple sheets from being fed at once, fan the original before placing it on the ADF.
- Set the original squarely.

Batch Mode

In Batch mode, the machine copies an original of more than 100 pages as one document, even if it is placed on the ADF in parts.

1 Press [Special Original].

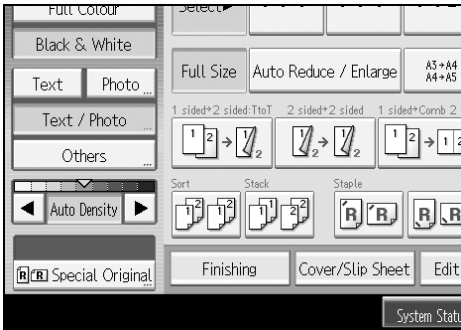

2 Select [Batch] and then press [OK].

3 Place the first part of the original, and then press the [Start] key.

4 After the first part of the original has been fed, place the next part, then press the [Start] key.

Note

- When [SADF] is displayed in step 2, set the Batch mode with [Switch to Batch]. See "Input/Output", General Settings Guide.
- To copy subsequent originals in this mode, repeat step 4.
- When the Sort, Combine or 1 Sided→2 Sided mode has been set, press the [#] key after all originals have been scanned.

SADF Mode

In SADF mode, even when an original is placed page by page in the ADF, each page is automatically fed when placed.

Important

- You should make a setting so that **[SADF]** will be displayed when you press **[Special Original]**. See “Input/Output”, General Settings Guide.

1 Press **[Special Original]**.

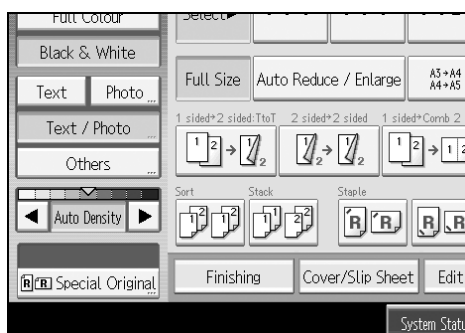

2 Press **[SADF]**, and then press **[OK]** .

3 Place one page of an original, and then press the **[Start]** key.

4 When the machine instructs you to place another original, place the next page.

The second and subsequent pages will be fed automatically without pressing the **[Start]** key.

Note

- When the Sort, Combine or 1 Sided→2 Sided mode has been set, press the **[#]** key after all originals have been scanned.











Reference

See “Input/Output”, General Settings Guide

Mixed Size Mode

When placing different size originals of the same width in the ADF at the same time, the machine automatically checks the size of the originals and makes copies.

Important

- ❑ When placing originals of different sizes in the ADF and making copies without using the Mixed size mode, paper might become jammed or parts of the original image might not be copied.
- ❑ The sizes of the originals that can be placed in this mode are follows:
 - Metric version
A3 , B4 JIS , A4  , B5 JIS  
 - Inch version
11" × 17" , 8¹/₂" × 14" , 8¹/₂" × 11"  

1 Press [Special Original].

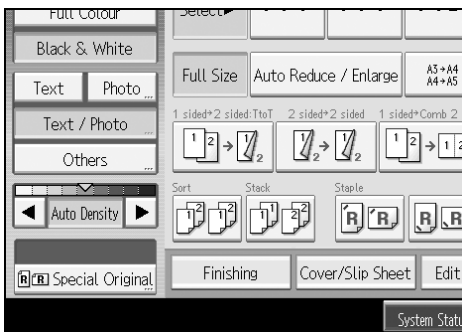

2 Select [Mixed Sizes], and then press [OK].

3 Align the rear and left edges of the originals as shown in the illustration.

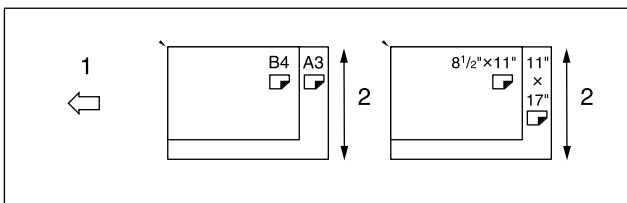

APG045S

- ① Place the originals into the ADF
- ② Vertical size

4 Adjust the guide to the widest original size.

5 Place originals in the ADF.

6 Press the [Start] key.

Original Size

Specify the size of the originals.

Regular sizes

Select the size of the originals from the regular sizes.

1 Press **[Special Original]**.

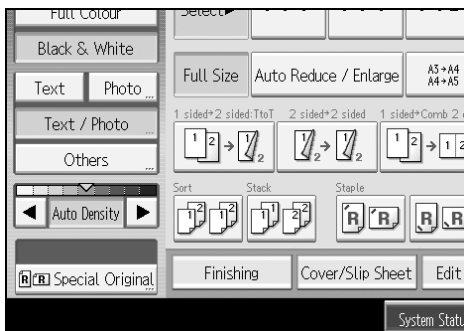

2 Press **[Original Size]**.

3 Press **[Regular Size]**.

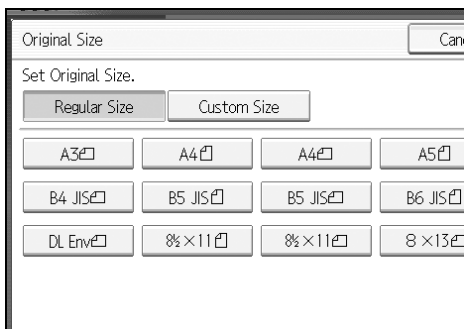

4 Select the size of original, and then press **[OK]**.

5 Place the original, and then press the **[Start]** key.

1

Custom sizes

When placing custom size originals in the ADF, specify the size of the originals.

1

Important

- Paper that has a vertical length of 128–297 mm (5.1"-11.6") and a horizontal length of 128–432 mm (5.1"-17") can be placed with this function.

1 Press [Special Original].

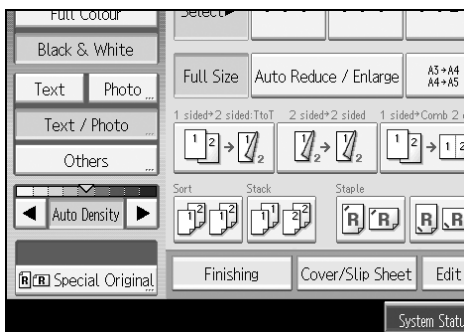

2 Press [Original Size].

3 Press [Custom Size].

4 Enter the horizontal size of the original with the number keys, and then press the [#] key.

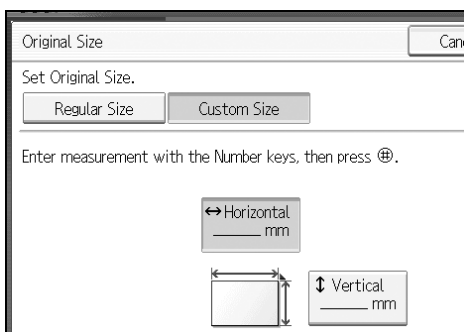

5 Enter the vertical size of the original with the number keys, and then press the [#] key.

6 Press [OK].

7 Place the originals, and then press the [Start] key.

Note

- If you make a mistake in step **4** or **5**, press [Clear] or the [Clear/Stop] key, and then enter the value again.

2. Copying

This chapter describes the procedure for making copies in various modes.

Basic Procedure

This section describes the basic procedure for making copies.

Important

- ❑ When User Code Authentication is set, enter your user code (up to eight digits) with the number keys so that the machine accepts copy jobs. See “Administrator Tools”, General Settings Guide.
- ❑ When Basic Authentication, Windows Authentication, LDAP Authentication, or Integration Server Authentication is set, enter your login user name and user password so that the machine accepts copy jobs. Ask the user administrator for the login user name and login password. For details, see “When the Authentication Screen is Displayed”, About This Machine.

1 Make sure "Ready" appears on the screen.

If any other function is displayed, press the **[Copy]** key on the left side of the control panel.

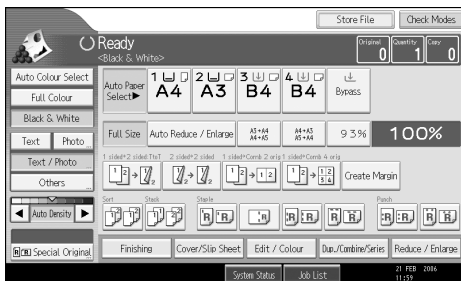

2 Make sure no previous settings remain.

When there are previous settings remaining, press the **[Clear Modes]** key.

3 Place your originals.

4 Make desired settings.

5 Enter the number of copies using the number keys.

The maximum copy quantity that can be set is 999.

6 Press the **[Start]** key.

The machine starts copying.

When placing originals on the exposure glass, press the **[#]** key after all originals are scanned.

Copies are delivered face down.

Note

- Always log off when you have finished using the machine to prevent unauthorized users from using the machine.
- To stop the machine during a multi-copy run, press the **[Clear/Stop]** key.
- To cancel all copy jobs and return the machine to the default condition, press the **[Clear Modes]** key.
- To clear entered values, press the **[Clear/Stop]** key or **[Cancel]** on the screen.
- To confirm settings, press the **[Check Modes]**.

Interrupt Copy

Use this function if you want to interrupt a long copy job to make urgently needed copies.

Important

- You cannot use the Interrupt Copy function when fax originals are being scanned or the scanner function is being used.

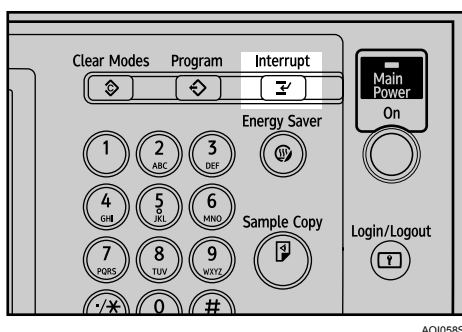
1 Press the **[Interrupt]** key.

AQI0585

2 The machine stops scanning. Remove the originals that were being copied.**3** Place the originals you want to copy.**4** Press the **[Start]** key.

The machine starts making copies.

5 When copying is complete, remove the originals and copies.**6** Press the **[Interrupt]** key again.

The interrupt key indicator goes off.

7 Replace the originals that you were copying, and then press the **[Start]** key.

Following message "Reset n original(s).", replace the originals that you were copying.

Note

- The previous copy job settings are restored. Simply press the **[Start]** key to continue copying from where it left off.

Left Original Beeper

The beeper sounds and an error message is displayed when you leave your originals on the exposure glass after copying.

Reference

For details, see “Copier / Document Server Features”, General Settings Guide.

2

Job Preset

You can set up the next copy content during copying. If a long copy job is in progress and you do not want to wait for it to finish, you can use this function to set up the next copy job in advance. When the current copy job is finished, the next job will start automatically.

1 Press [New Job] when “Copying...” appears.

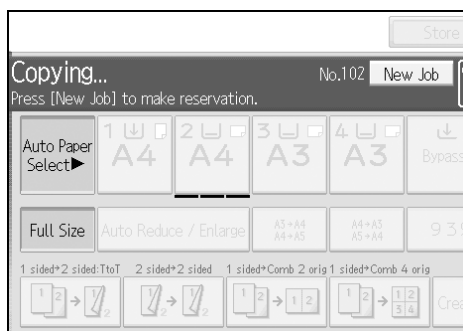

2 Be sure message “Ready” appears, and then set up the next copy job.

3 Place the originals, and then press the [Start] key.

All originals are scanned.

When the job preset is complete, a job preset confirmation dialog box appears.

4 Press [Exit].

You return to the copy screen.

After the current copy job, the next copy job starts automatically.

Note

- You can switch the display to the current copy job by pressing [To Copying Screen]. You can switch the display to the preset job by pressing [To Reserv. Screen].
- Preset copy jobs are registered under job numbers in the Reserv. Screen.

Job List

Jobs printed using Copy, Document Server, or Printer mode are temporarily stored in the machine, and then executed in order. The Job List function allows you to manage these jobs. For example, you can cancel incorrect job settings or print an urgent document.

2

Note

- You cannot use the Job List function when Interrupt Copy is active.
- Documents printed using the facsimile function and scanner function are not displayed in the job list.

Job List Screen

This section explains displays and icons that appear in the Job List screen.

The Job List screen varies depending on whether **[Job Order]** is selected with Print Priority for the System Settings. For details about the setting procedure, see “System Settings”, General Settings Guide.

❖ When **[Job Order]** is not selected:

The job list is displayed for each of the functions.

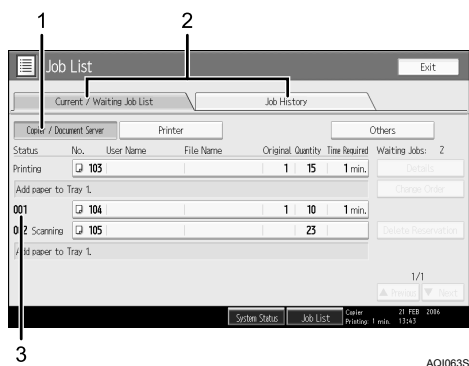

❖ When **[Job Order]** is selected:

The job list is displayed for all functions in the order of print jobs.

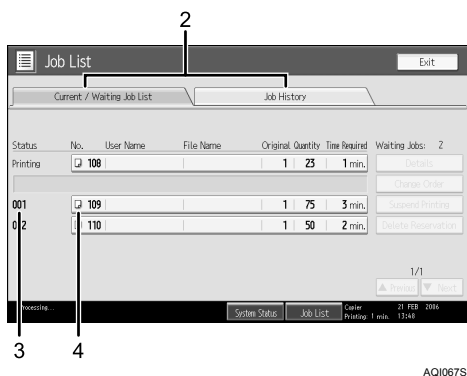

- ① Switches between job lists for each function.
- ② Switches between **[Current / Waiting Job List]** and **[Job History]**.
- ③ Displays reserved job numbers.
- ④ Displays the function used to print jobs.
 - ☐: Job printed using copy function
 - ☐: Job printed using printer function
 - ☐: Job printed using Document Server function
 - ☐: Job printed using DeskTopBinder
 - ☐: Job printed using Web Image Monitor

🔍 Reference

See “System Settings”, General Settings Guide.

Checking Jobs in the Print Queue

You can check the contents of jobs in the print queue.

- 1** Press [Job List].
- 2** Select the job whose contents you want to check.



- 3** Press [Details], and then check the contents.
- 4** Press [Exit].

Changing the Order of Jobs

You can change the order in which print jobs in the job list are served:

- 1** Press [Job List].
- 2** Select the job whose order you want to change.



- 3** Press [Change Order].
- 4** Change the order using [Top], [Previous], or [Next].

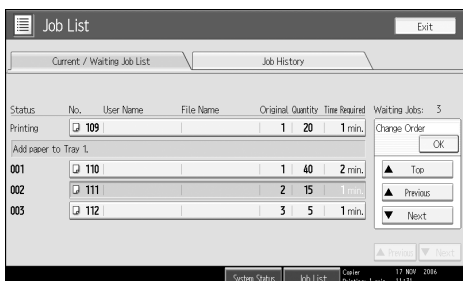

5 Press [OK].

Holding Print Jobs

The machine holds jobs that are queued and currently printing.

1 Press [Job List].

2 Select the job(s) to hold.

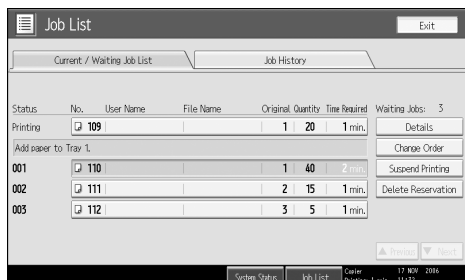

3 Press [Suspend Printing].

Deleting Jobs

You can delete a job that is queued or currently printing.

1 Press [Job List].

2 Select the job you want to delete.

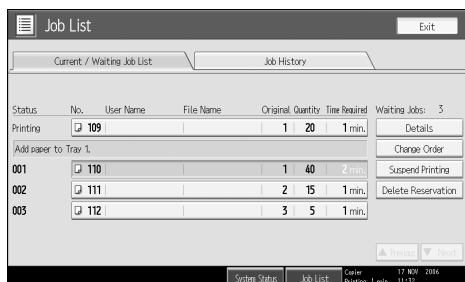

3 Press [Delete Reservation].

4 Press [OK].

Note

To delete multiple print jobs, select them in step **2**.

Checking Job History

You can view the history and contents of completed print jobs.

1 Press [Job List].

2 Press [Job History].

A list of completed print jobs appears.

3 Select the job whose contents you want to check.

4 Press [Details], and then check the contents.

5 Press [Exit].

Copying from the Bypass Tray

Use the bypass tray to copy onto OHP transparencies, adhesive labels, translucent paper, postcards and copy paper that cannot be loaded in the paper trays.

Important

- ❑ When the duplex unit is attached, the default is **[1 Sided → 2 Sided]**. When copying from the bypass tray, cancel **[1 Sided → 2 Sided]** in **[Dup./Combine/Series]**. You can change the initial settings. See “Programming Defaults in Initial Display”.
- ❑ Paper that has a vertical length of 90-305 mm (3.6-12 inch) and a horizontal length of 148-457.2 mm (5.9-18 inch) can be copied from the bypass tray. However, when paper larger than 433 mm (17.1 inch) in size is used, the paper may become wrinkled, may not be fed into the machine, or may cause paper jams.
- ❑ The machine can detect the following sizes as regular size copy paper: A3❑, A4❑, A5❑, A6❑. If you want to use the size of paper other than the above, be sure to specify the size.
- ❑ When copying on OHP transparencies or paper heavier than 81 g/m² (about 70 kg, 21 lb.), you need to specify the type and size of paper with “Special Original”.
- ❑ The maximum number of sheets you can load at the same time depends on paper type. The maximum number of sheets should not exceed the upper limit.
- ❑ When copying paper lighter than 59 g/m² or tracing paper, you need to specify the paper type.

❖ [Bypass Tray Usage]

Press **[Bypass Tray Usage]** to display a description on using the bypass tray.

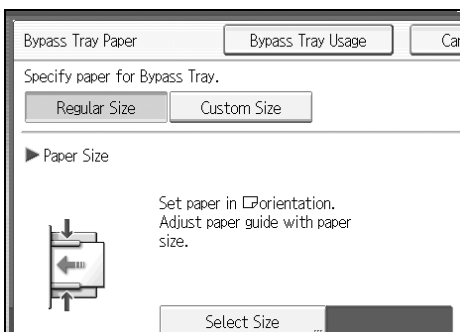

1 Open the bypass tray.

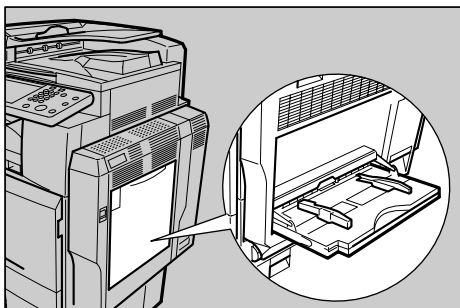

AQF070S

2 Insert the paper face-down until you hear the beep, and then align the paper guide to the paper size by pinching the clip.

If the guides are not flush against the copy paper, images might be skewed or paper misfeeds might occur.

Do not stack paper over the limit mark, otherwise images might be skewed or paper misfeeds might occur.

Swing out the extender to support paper sizes larger than A4 or 8¹/₂" × 11".

Fan paper to get air between the sheets and avoid a multi-sheet feed.

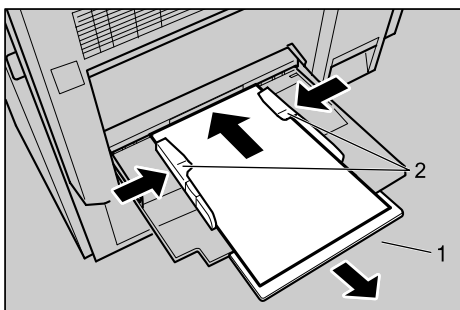

AQF071S

① Extender

② Paper guide

3 Press [Bypass], and then press the [#] key.

4 Select the size and type of the paper.

5 Press [OK].

6 Place the original, and then press the [Start] key.

7 When the copy job is finished, press the [Clear Modes] key to clear the settings.

Note

- When the Sort function is selected, press the [#] key after all originals have been scanned.
- When the beeper is turned off, it will not sound if you insert paper into the bypass tray.

Reference

See p.146 “Programming Defaults in Initial Display”.

See “System Settings”, General Settings Guide.

When Copying onto Regular Size Paper

Makes copies onto regular size paper from the bypass tray.

- 1** Open the bypass tray, and then insert the paper face-down until you hear the beep.
- 2** Align the paper guide to the paper size by pinching the clip.
- 3** Press [Bypass], and then press the [#] key.
- 4** Press [Select Size].

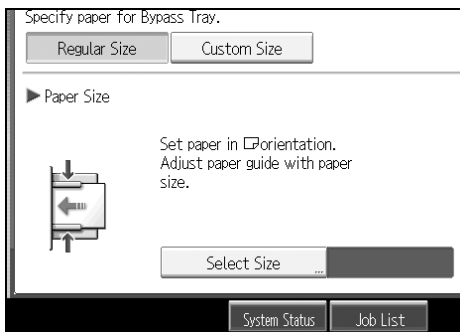

- 5** Select the paper size.
- 6** Press [OK] twice.
- 7** Place the original, and then press the [Start] key.
- 8** When the copy job is finished, press the [Clear Modes] key to clear the settings.

When Copying onto Custom Size Paper

Makes copies onto custom size paper from the bypass tray.

- 1** Open the bypass tray, and then insert the paper face-down until you hear the beep.
- 2** Align the paper guide to the paper size by pinching the clip.
- 3** Press [Bypass], and then press the [#] key.
- 4** Press [Custom Size].

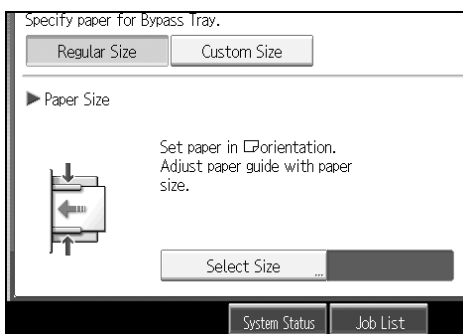

- 5** Enter the horizontal size of the original with the number keys, and then press [#].
- 6** Enter the vertical size of the original with the number keys, and then press [#].

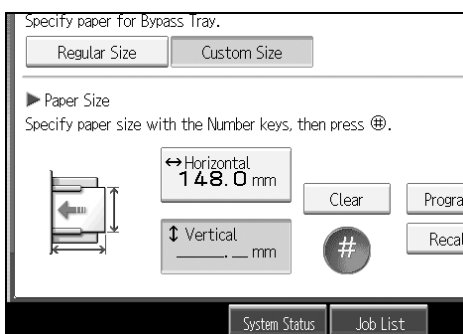

- 7** Press [OK].
- 8** Place the original, and then press the [Start] key.
- 9** When the copy job is finished, press the [Clear Modes] key to clear the settings.

Note

- If you make a mistake in step **5** or **6**, press [Clear] or the [Clear/Stop] key, and then enter the value again.
- To register the custom size entered in step **6**, press [Program] and then press [Exit] in the confirmation screen.

When Copying onto OHP Transparencies or Thin Paper

When copying onto OHP transparencies or thin paper, select the type and size of paper.

Important

- We recommend that you use specified OHP transparencies.
- OHP transparencies must be loaded face-down in the tray with the notched corner of the sheet in the appropriate corner of the tray.
- To prevent multiple sheets from being fed at once, fan paper before placing it on the tray.
- When copying onto OHP transparencies, remove copied sheets one by one.

1 Open the bypass tray, and then insert the paper face-down until you hear the beep.

2 Align the paper guide to the paper size by pinching the clip.

3 Press [Bypass], and then press the [#] key.

4 Select paper type ([OHP (Transparency)] or [Thin Paper]) in the special paper settings.

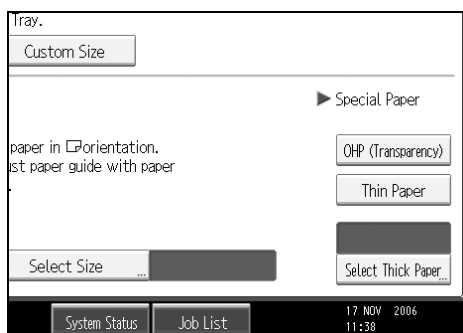

5 Set the paper size, and then press [OK] to return to the initial display.

6 Place the original, and then press the [Start] key.

7 When the copy job is finished, press the [Clear Modes] key to clear the settings.

Note

- For OHP transparencies or thin paper, print speed is slower when compared to printing on plain paper.

When Copying onto Thick Paper

When copying onto thick paper, select the type and size of paper.

To prevent multiple sheets from being fed at once, fan paper before placing it on the tray.

- 1** Open the bypass tray, and then insert the paper face-down until you hear the beep.
- 2** Align the paper guide to the paper size by pinching the clip.
- 3** Press [Bypass], and then press the [#] key.
- 4** Press [Select Thick Paper].
- 5** Select paper type (one of [Thick Paper 1], [Thick Paper 2], [Thick Paper 3], [Thick 1: Dup.Back], [Thick 2: Dup.Back], and [Thick 3: Dup.Back]), and then press [OK].
Select [Thick Paper 1] when copying paper whose weight is between 106 g/m² (28.5 lb.) and 169 g/m² (45.0 lb.).
Select [Thick Paper 2] when copying paper of 220 g/m² (58.5 lb.) or less.
Select [Thick Paper 3] when copying paper of 253 g/m² (67.3 lb.) or less.

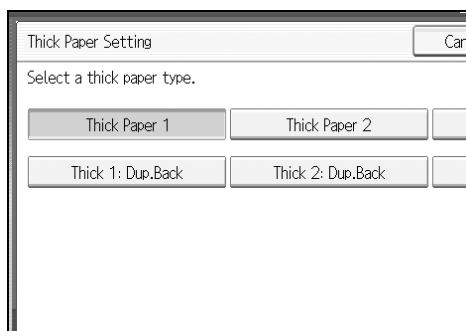

- 6** Set the paper size, and then press [OK] to return to the initial display.
- 7** Place the original, and then press the [Start] key.
- 8** When the copy job is finished, press the [Clear Modes] key to clear the settings.

Note

- If Internal Tray 1 is not selected for the output paper tray, copies are delivered to it.
- For thick paper, print speed is slower when compared to printing on plain paper.

When Copying onto Envelopes

When copying onto envelopes, select the paper type.

- 1** Open the bypass tray, and then insert the envelopes with the side you want to copy face-down until the beeper sounds.
- 2** Align the paper guide to the envelope side by pinching the clip.
- 3** Press [Bypass], and then press the [#] key.
- 4** Press [Select Thick Paper].
- 5** Select [Thick Paper 1], and then press [OK].
- 6** Select the paper size.
- 7** Press [OK] twice.
- 8** Place the original, and then press the [Start] key.
- 9** When the copy job is finished, press the [Clear Modes] key to clear the settings.

Note

- When placing an original on the exposure glass, place the original with the bottom line aligned to the left scale.
- When placing an original in the ADF, place the original with the bottom line inserted in the ADF.
- When inserting envelopes, be sure to unfold the flaps and position them opposite to the paper feed direction.

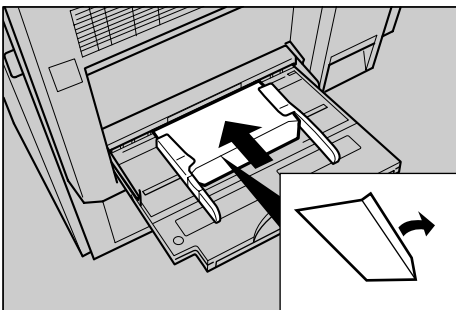

AQ10065

Reference

For details about supported size of envelope, see “Recommended Paper Sizes and Types”, About This Machine.

Colour Functions

This section describes functions that are used for colour copying.

Selecting a Colour Mode

2

Select a colour (or colours) that suits your originals and copying requirements. For colour images, see “What You Can Do with This Machine <Colour Functions/Colour Adjustments>”.

The following three colour modes are available:

❖ Auto Colour Selection

Judges the colour of the original automatically, and copies either in full colour or black/white.

❖ Full Colour Copy

Copies by overlaying yellow, magenta, cyan and black.

❖ Black/White Copy

Copies in black regardless of the colour of the original.

1 Select the type of colour.

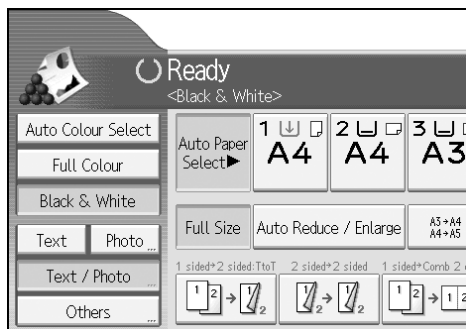

Note

- To use a user colour, you need to register it beforehand. For details, see “Registering Colours”.

Reference

See p.iii “What You Can Do with This Machine <Colour Functions/Colour Adjustments>”.

See p.53 “User Colour”.

Convert Colours

Copies by changing the colour in the original to a different colour.

Important

- It is possible to specify up to 4 colours.
- To use this function, **[Full Colour]** must be selected.
- If any other colour mode is selected, you cannot select **[Convert Colour]**.

1 Press **[Full Colour]**.

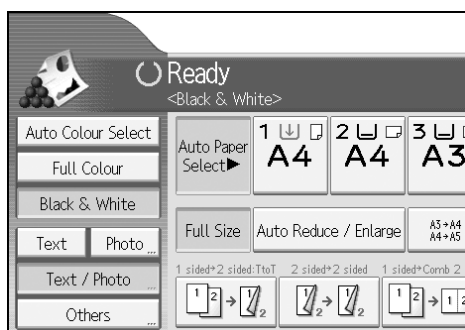

2 Press **[Edit / Colour]**.

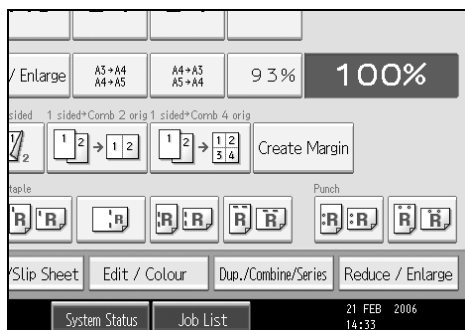

3 Make sure that **[Colour]** is selected before pressing **[Convert Colour]**.

4 Select any one item from **[Conversion 1]** to **[Conversion 4]**.

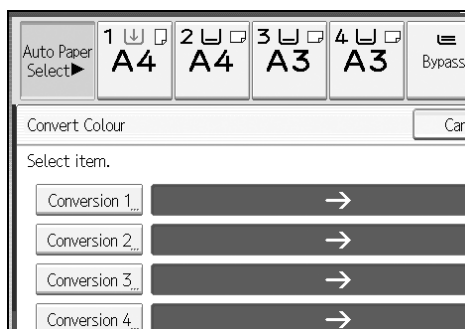

5 Selects the colour to be converted.

6 Selects the new colour.

You can adjust the density of each colour in four steps.

To select User Colour, press **[User Colour]**, and then select the colour.

7 After selecting all colours to be converted, press **[OK]** three times.

8 Place the originals, and then press the **[Start]** key.

Note

- The width of the colour to be converted can be adjusted in five levels. If the colour width is set to **[Wider]** and red has been specified, colours, which are close to magenta or orange, will also be converted. The colour width can be adjusted in User Tools. This adjustment will be valid in "Erase Colour". See "Adjust Colour Image", General Settings Guide.
- When you want to change the converted colour in step **6**, press from **[Conversion 1]** to **[Conversion 4]** and make the selection again.
- When changing more than two colours, repeat steps **4** to **6**.
- The full colour counter will advance by "1".

Erase Colour

Copies by erasing a certain colour in the image of the original.

1 Press **[Edit / Colour]**.

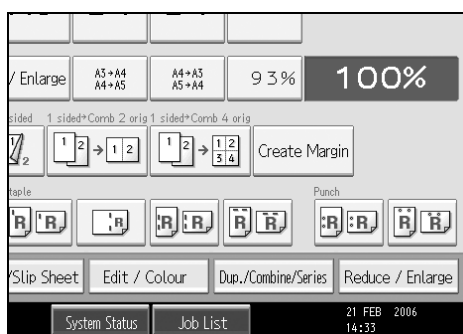

2 Make sure that **[Colour]** is selected before pressing **[Erase Colour]**.

3 Select the colour to be erased.

It is possible to select up to 4 colours.

4 After selecting all colours to be erased, press **[OK]** twice.

5 Place the originals, and then press the **[Start]** key.

Note

- The width of the colour to be deleted can be adjusted in five levels. If the colour width is set to **[Wider]** and red has been specified, colours, which are close to magenta or orange, will also be deleted. The colour width can be adjusted in User Tools. See “Adjust Colour Image”, General Settings Guide.
- You can cancel the selection by pressing the selected (highlighted) key in step **3**.
- When the Full Colour Copy is selected, the full colour counter will advance by “1”. When the Black/White is selected, the mono-colour counter will advance by “1”.

2

Colour Background

Copies by adding a colour in the whole page.

Important

- Since the Colour Background function overprints the entire original, the colour of the image may change.

1 Press **[Edit / Colour]**.

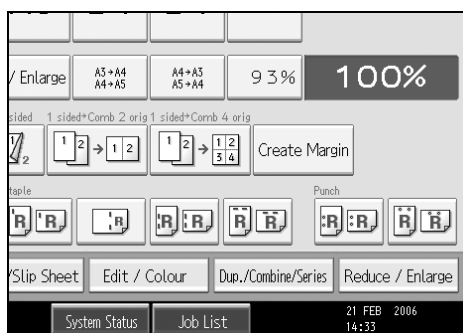

2 Make sure that **[Colour]** is selected before pressing **[Colour Background]**.

3 Select the background colour, and then press **[OK]** twice.

You can adjust the density of each colour in four steps.

To select User Colour, press **[User Colour]**, and then select the colour.

4 Place the originals, and then press the **[Start]** key.

Note

- You can cancel the selection by pressing the selected (highlighted) key in step **3**.
- When the Full Colour Copy is selected, the full colour counter will advance by “1”. When the Black/White is selected, the mono-colour counter will advance by “1”.

Colour Balance

Adjusts the overall colour tone when the overall copy is reddish or bluish.

1 Press [Edit / Colour].

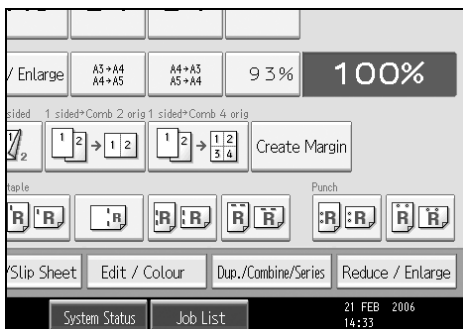

2 Make sure that [Colour] is selected before pressing [Adjust Colour].

3 Make sure that [Colour Balance] is selected.

4 Adjust the colour balance by pressing [Lighter] or [Darker].

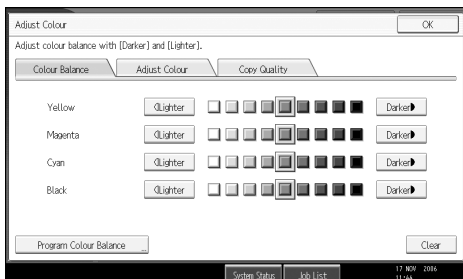

5 Press [OK] twice.

6 Place the originals, and then press the [Start] key.

Note

- The adjusted settings will be deleted and the initial values will be reset, when Auto Clear has been performed, when the **[Clear Modes]** key has been pressed or when the power has been turned off.
- For types and examples of the image adjustment functions, see "What You Can Do with This Machine <Colour Functions/Colour Adjustments>".

Reference

See p.iii "What You Can Do with This Machine <Colour Functions/Colour Adjustments>".

Colour Balance Program

You can also store the colour balance setting as a colour balance program and recall it when you want to use it.

You can store up to three programs.

Note

- If you want to change the registered settings, register them one more time. In this case, the previously registered contents will be changed.

2

Registering the adjusted colour balance

Register adjusted colour balance settings so that you can use them later.

1 Change the colour balance.

2 Press [Program Colour Balance].

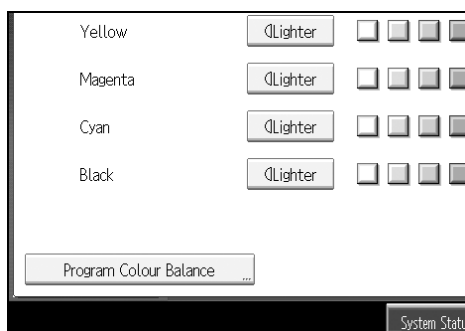

3 Press [\rightarrow Program].

4 Select a program number ([1]-[3]) for this setting.

The colour balance setting will be registered in the selected number.

5 Press [OK] twice.

Note

- If you select the program number key where the \rightarrow is displayed in step **4**, the previously registered settings will change (will be overwritten).
- For details about how to adjust the colour balance, see "Colour Balance".

Reference

See p.iii "What You Can Do with This Machine <Colour Functions/Colour Adjustments>".

See p.44 "Colour Balance".

Changing the registered contents

Changes contents stored in colour balance programs.

- 1** Press [Edit / Colour].
- 2** Make sure that [Colour] is selected before pressing [Adjust Colour].
- 3** Make sure that [Colour Balance] is selected before pressing [Program Colour Balance].

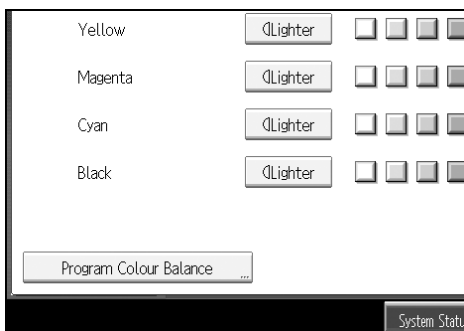

- 4** Make sure that [Recall] is selected, and then select the program number ([1]-[3]) to be changed.
The programmed colour balance appears.
- 5** Change the registered contents.
- 6** After the programmed contents are changed, press [Program Colour Balance].
- 7** Press [Program], and then press the program number to be overwritten.
- 8** Press [Yes].
The program is overwritten.
- 9** Press [OK] twice.

Copying with the registered contents

Applies settings registered in colour balance programs to the copy job.

- 1** Press [Edit / Colour].
- 2** Make sure that [Colour] is selected before pressing [Adjust Colour].
- 3** Make sure that [Colour Balance] is selected before pressing [Program Colour Balance].
- 4** Make sure that [Recall] is selected, and then select the program number registered by the colour balance to be used.
- 5** Press [OK] twice.

6 Place the originals, and then press the **[Start]** key.

 **Note**

- After copying has been completed, pressing the **[Clear Modes]** key deletes the recalled contents.

Deleting the registered contents

Deletes contents stored in colour balance programs.

1 Press **[Edit / Colour]**.

2 Make sure that **[Colour]** is selected before pressing **[Adjust Colour]**.

3 Make sure that **[Colour Balance]** is selected before pressing **[Program Colour Balance]**.

4 Press **[Delete]**, and then select the program number registered by the colour balance to be deleted.

5 Press **[Yes]**.

6 Press **[OK]** twice.

Colour Adjustment

Adjusts the specific colours (yellow, red, magenta, blue, cyan and green) by mixing them with adjacent colours in the colour circle.

You can adjust up to three colours from yellow, red, magenta, blue, cyan, or green.

 **Important**

- This function is not available if Black & White is selected.

1 Press **[Edit / Colour]**.

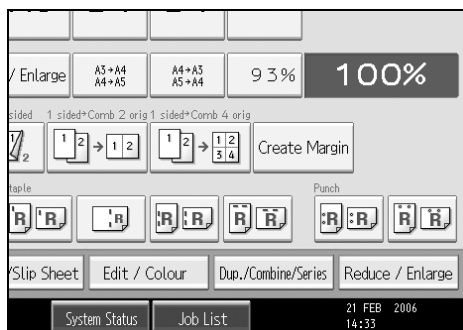

2 Make sure that **[Colour]** is selected before pressing **[Adjust Colour]**.

3 Press **[Adjust Colour]**.

4 Select the colours you want to adjust.

You can select up to 3 colours.

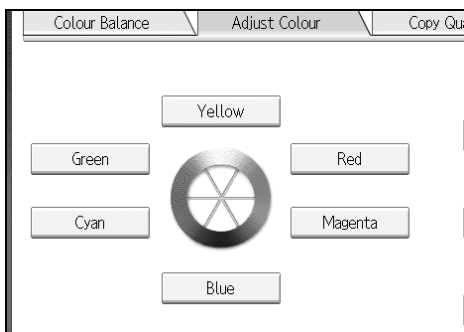
**5** Adjust the colour tastes using [←] or [→].

Refer to the colour circle on the control panel.

6 Press [OK] twice.**7** Place the originals, and then press the [Start] key.**Note**

- The adjusted settings will be deleted and the initial values will be reset, when Auto Clear has been performed, when the **[Clear Modes]** key has been pressed or when the power has been turned off.
- For types and examples of the image adjustment functions, see “What You Can Do with This Machine <Colour Functions/Colour Adjustments>”.

Reference

See p.iii “What You Can Do with This Machine <Colour Functions/Colour Adjustments>”.

Image Adjustment

The following five types of image adjustments are available:

❖ Sharp/Soft

Adjusts the outline of an image.

❖ Contrast

Adjusts the shades of an image.

❖ Background Density

Adjusts the background density of an image.

❖ Adjust U.C.R.

Adjusts the amount of black toner to express vividly the black areas in an image.

❖ Text/Photo Sensitivity

Adjusts the standard level in judging the image in the text and photo part when using “Text / Photo”.

1 Press [Edit / Colour].

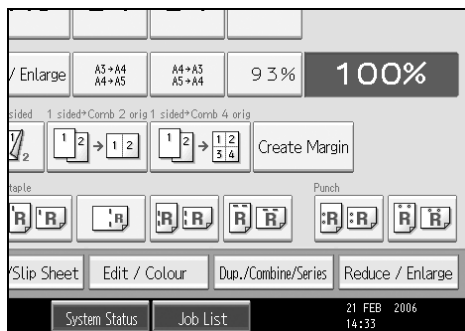

2 Make sure that [Colour] is selected before pressing [Adjust Colour].

3 Press [Copy Quality].

4 Adjust the settings.

5 Press [OK] twice.

6 Place the originals, and then press the [Start] key.

Note

- [Sharp / Soft], [Contrast], and [Background Density] can each be adjusted, however, their adjustments can affect the level of other adjustment functions.
- The adjusted settings will be deleted and the initial values will be reset, when Auto Clear has been performed, when the [Clear Modes] key has been pressed or when the power has been turned off.
- For types and examples of the image adjustment functions, see “What You Can Do with This Machine <Colour Functions/Colour Adjustments>”.

Reference

See p.iii “What You Can Do with This Machine <Colour Functions/Colour Adjustments>”.

Adjusting the sharpness/softness

Adjusts the outline of an image.

1 Adjust by pressing [Soft] or [Sharp].

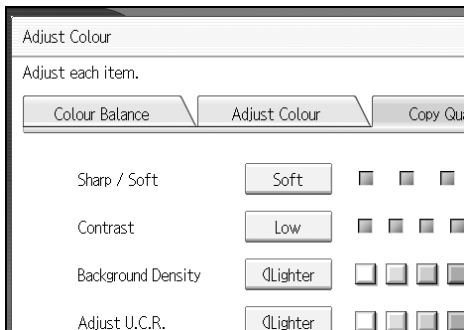

2 Press [OK].

Adjusting the contrast

Adjusts the shades of an image.

1 Adjust by pressing [Low] or [High].

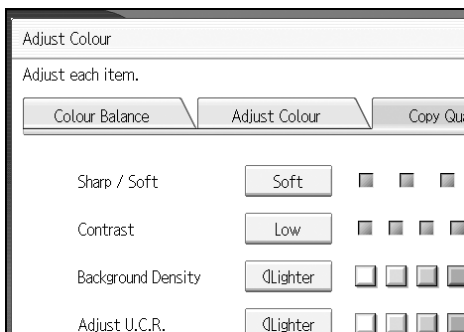

2 Press [OK].

Adjusting the background density

Adjusts the background density of an image.

1 Adjust by pressing [Lighter] or [Darker].

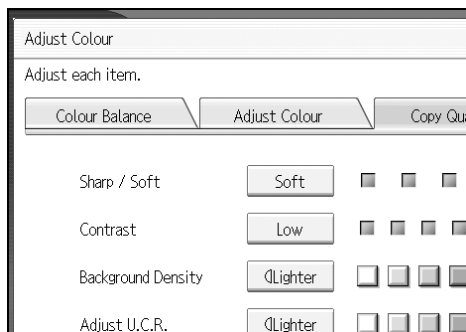

2 Press [OK].

Note

- Adjustments should be made lighter when copying dark textured originals, such as newspaper or recycled paper.
- Adjustments should be made darker when darkening the colour of markers or highlighters. However, as the colour of highlighters is difficult to reproduce, the copy might not come out depending on the colour or a different colour might be copied.

Adjusting the U.C.R.

Adjusts the amount of black toner to express vividly the black areas in an image.

1 Adjust by pressing [Lighter] or [Darker].

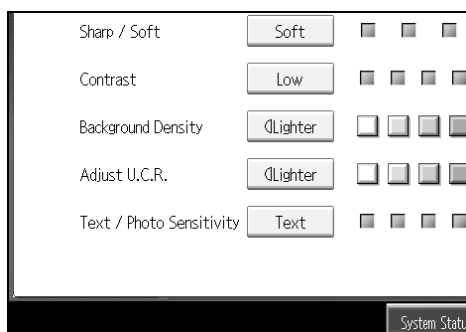

2 Press [OK].

Adjusting the Text/Photo sensitivity

Adjusts the standard level in judging the image in the text and photo part when using “Text / Photo”.

1 Adjust by pressing [Text] or [Photo].

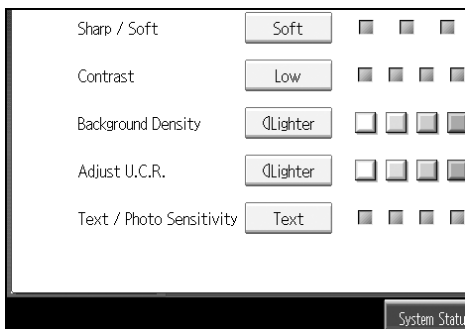

2 Press [OK].

Note

- Make sure to set to “Text” when parts of the texts are faded or are not clear. Set to “Photo” when the outline of photos becomes dark.





User Colour

You can register User Colours made by adjusting the density of yellow, magenta, cyan, and black. You can also give a name to the colours you register, and print out a list of user colours.

You can create colours by:

- Adjusting the density of each colour based on the density of a chosen basic colour.
- Directly specifying the density of each colour using the number keys.

Note

- Adjust the colours to be registered so that the total of yellow, magenta, cyan and black is under 400%.
- When copying using user colours, the fine shades might vary depending on the condition of the machine.
- In order to correctly reproduce originals, the values, which have been input, are corrected inside the machine, and copies are made using the best suitable values. Therefore, there might be slight colour differences when copying using "Text" and when using "Photo".
- Up to 15 colours can be registered.
- Sample prints of user colours can also be made on an A4 , 8¹/₂" × 11" , A3 , or 11" × 17"  size page.
- When printing a list of user colours, the full colour counter will advance by "1".
- For types and examples of the image adjustment functions, see "What You Can Do with This Machine <Colour Functions/Colour Adjustments>".

Reference

See p.iii "What You Can Do with This Machine <Colour Functions/Colour Adjustments>".

Adjusting colours based on selected colour

Creates colours by adjusting the density of each colour based on the density of a chosen basic colour.

1 Press **[Edit / Colour]**.

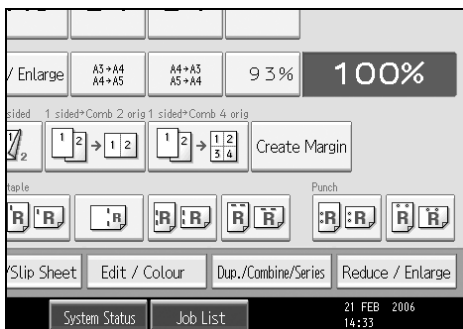

2 Press **[Colour]**, and then press **[User Colour]**.

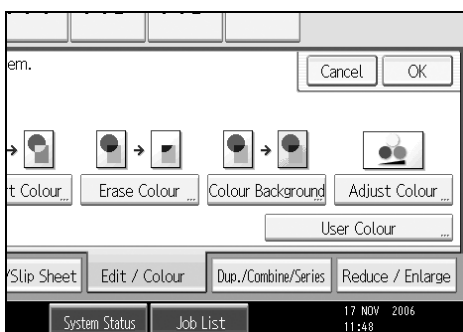

3 Make sure that **[Program]** is selected, and then select the number (**[01]**-**[15]**) for the colour you want to register.

4 Select the colour to be used as a base for registration from the basic and user colours.

The density of each colour for the selected colour is displayed.

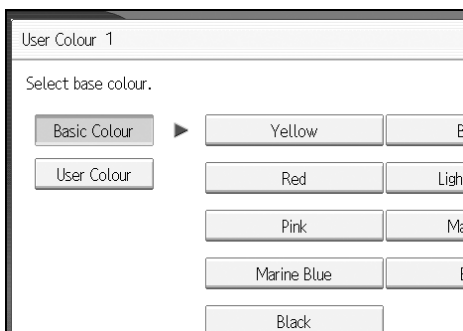

To select User Colour, press **[User Colour]**, and then select the colour.

- 5** Select the colour whose density is to be specified, and then specify the density in percentages using **[+]** or **[-]**.

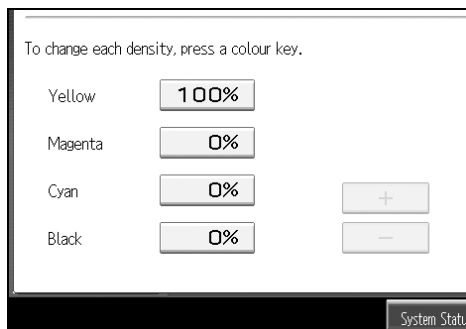

- 6** Check names and densities of each colour, and press **[OK]**.

- 7** Press **[OK]** twice.

Note

- It is also possible to specify density by pressing **[Adjust with Number Keys]** in step **5**.
- Selecting a user colour key that is indicated by a solid line will change (overwrite) the contents of that colour.

Creating colours by directly specifying the density of each colour with number keys

Creates colours by directly specifying the density of each colour using the number keys.

- 1** Press **[Edit / Colour]**.
- 2** Press **[Colour]**, and then press **[User Colour]**.
- 3** Make sure that **[Program]** is selected, and then select the number (**[01]**-**[15]**) for the colour you want to register.
- 4** Press **[Custom Setting]**.
- 5** Select the colour whose density is to be specified.
- 6** Enter the density (%) using the number keys, and then press the **[#]** key.
Repeat steps **5-6** if you want to specify the density of multiple colours.
- 7** Check names and densities of each colour, and press **[OK]**.
- 8** Press **[OK]** three times.

Note

- It is also possible to specify density by pressing **[Adjust with [+] [-]]** and then using **[+]** and **[-]** in step **6**.
- Selecting a user colour key that is indicated by a solid line will change (overwrite) the contents of that colour.

Renaming a user colour

Renames a user colour.

- 1** Press [Edit / Colour].
- 2** Press [Colour], and then press [User Colour].
- 3** Make sure that [Program] is selected, and then select the number ([01]-[15]) for the colour you want to rename.
- 4** Select the colour you want to rename.
- 5** Press [Change Name].
- 6** Enter the name of the colour (up to 16 characters), and then press [OK].
- 7** Press [OK] three times.

Deleting user colours

Deletes user colours.

Important

- You can not delete colours registered in the program or user colours that are currently being used.

- 1** Press [Edit / Colour].
- 2** Press [Colour], and then press [User Colour].
- 3** Press [Delete].
- 4** Select the number of the user colour (whose key is indicated by a solid line) you want to delete.
- 5** Press [Yes].
- 6** Press [OK] twice.





Printing a list of user colours

Prints a list of user colours.

- 1** Press [Edit / Colour].
- 2** Press [Colour], and then press [User Colour].
- 3** Check the copy paper, and then press [Print Sample of User Colour].

The list of user colours is output in the internal tray.

Note

- The list will be copied on a A4 , 8¹/₂" × 11" , A3  or 11" × 17"  sheet.

Copier Functions

This section describes the copy functions.

Adjusting Copy Image Density

There are three types of adjustment available.

❖ Auto image density

The machine automatically adjusts the image density by scanning the densities of originals. Dark texture originals (such as newspaper or recycled paper) will be copied so that background will not be reproduced.

❖ Manual image density

You can adjust the density of the overall original in nine steps.

❖ Combined auto and manual image density

Adjusts the density of an image only for dark texture originals.

Auto image density

The machine automatically adjusts the image density by scanning the densities of originals. Dark texture originals (such as newspaper or recycled paper) will be copied so that background will not be reproduced.

1 Make sure that [Auto Density] is selected.



Manual image density

You can adjust the density of the overall original in nine steps.

- 1** When [Auto Density] is selected, press [Auto Density] to cancel it.
- 2** Press [◀] or [▶] to adjust the image density. The density indicator “▽” moves.



Combined auto and manual image density

Adjusts the density of an image only for dark texture originals.

- 1** Make sure [Auto Density] is selected.
- 2** Press [◀] or [▶] to adjust the density. The density indicator “▽” moves.

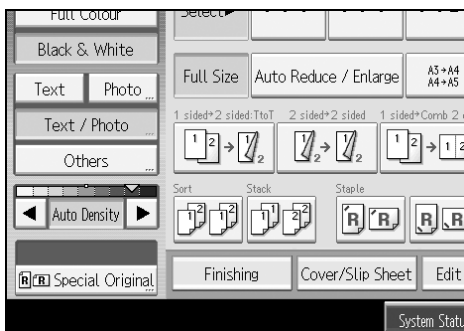

Selecting the Original Type Setting

Select one of the following 6 types to match your originals:

❖ Text

Select this mode when your originals contain only text (no pictures).

❖ Text/Photo

Select **[Text / Photo]** when your originals contain photographs or pictures with text.

❖ Photo

Delicate tones of photographs and pictures can be reproduced with this mode.

- When copying developed photographs:
- When copying photographs or pictures that are printed on paper (e.g. magazines):
- When copying copies or originals generated by colour copiers:

❖ Generation Copy

If your originals are copies (generation copies), the copy image can be reproduced sharply and clearly.

Select this type from **[Others]** when Original Type Display (Copier / Document Server Features) has been set to Off.

❖ Pale

The machine scans originals with settings suitable for originals that have lighter lines written in pencil, or for faint copied slips. The faint lines will be clearly copied.

Select this type from **[Others]** when Original Type Display (Copier / Document Server Features) has been set to Off.

❖ Map

The machine scans originals with settings suitable for map originals.

Select this type from **[Others]** when Original Type Display (Copier / Document Server Features) has been set to Off.

1 Select the original type, and then press **[OK]**.



🔍 Reference

See “Copier / Document Server Features” and “Adjust Colour Image”, General Settings Guide.

Selecting Copy Paper

There are two ways to select copy paper:

❖ Auto Paper Select

The machine selects a suitable size of copy paper automatically based on original size and reproduction ratio.

❖ Manual Paper Select

Choose the tray containing the paper you want to copy onto: a paper tray, bypass tray or LCT.

See the following table for copy paper sizes and orientations that can be used with Auto Paper Select (when copying at a ratio of 100%):

❖ Metric version

Where original is set	Paper size and orientation
Exposure glass	A3☐, B4 JIS☐, A4☐☐, B5 JIS☐☐, 8" × 13"☐
ADF	A3☐, B4 JIS☐, A4☐☐, B5 JIS☐☐, A5☐☐, 11" × 17"☐, 8 ¹ / ₂ " × 11"☐☐, 8" × 13"☐, 8K☐, 16K☐☐

❖ Inch version

Where original is set	Paper size and orientation
Exposure glass	11" × 17"☐, 8 ¹ / ₂ " × 14"☐, 8 ¹ / ₂ " × 11"☐☐
ADF	A3☐, A4☐☐, 11" × 17"☐, 8 ¹ / ₂ " × 14"☐, 8 ¹ / ₂ " × 11"☐☐, 5 ¹ / ₂ " × 8 ¹ / ₂ "☐☐, 10" × 14"☐, 7 ¹ / ₄ " × 10 ¹ / ₂ "☐

Note

- ☐ Only the paper trays set to **[No Display]** or **[Recycled Paper]** in Paper Type in Tray Paper Setting in System Settings and also set to **[Yes]** in Apply Auto Paper Select can be selected in Auto Paper Select mode.

Reference

See "Tray Paper Settings", General Settings Guide.

See "Copier / Document Server Features", General Settings Guide.

See p.14 "Sizes difficult to detect".

Auto Paper Select

The machine selects a suitable size of copy paper automatically based on the original size and the reproduction ratio.

1 Make sure that Auto Paper Select is selected.

Trays with a key mark (Ⓜ) will not be automatically selected.

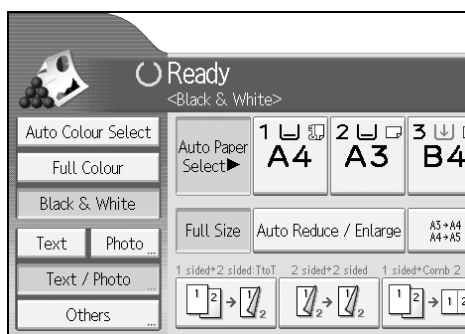

Reference

See "Tray Paper Settings", General Settings Guide.

Manual Paper Select

Choose the tray containing the paper you wish to copy onto: a paper tray, bypass tray or large capacity tray (LCT).

1 Select the paper tray, bypass tray or the LCT.

The indicator corresponding to the selected paper tray is highlighted.

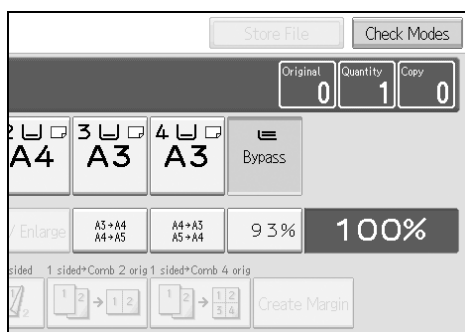

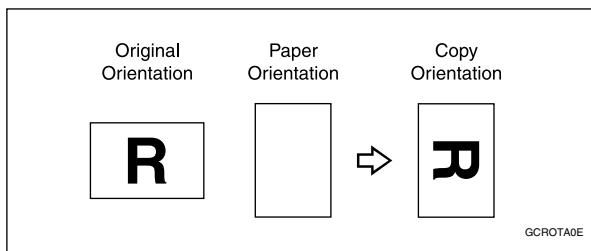

 **Note**

- ❑ If the orientation in which your original is placed (☐ or ☐) is different from that of the paper you are copying onto, this function rotates the original image by 90° to fit it on the copy paper.

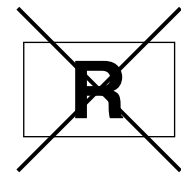

- ❑ This function works when **[Auto Paper Select]** or **[Auto Reduce / Enlarge]** is selected. See “Auto Paper Select” and “Auto Reduce/Enlarge”.
- ❑ The default setting for Auto Tray Switching is **[With Image Rotation]**. You cannot use the Rotated Copy function if this setting is changed to **[Without Image Rotation]** or **[Off]**. See “Copier / Document Server Features”, General Settings Guide.
- ❑ You cannot use the Rotated Copy function if 2 is selected for stapling when using SR790.
- ❑ You cannot use the Rotated Copy function if 2 or Centre is selected for stapling when using Booklet Finisher SR3020.
- ❑ You cannot use the Rotated Copy function when enlarging onto A3, B4 JIS or 11" × 17", 8¹/₂" × 14" size paper. In this case, place your original in the ☐ orientation.

	Original size and orientation		Copy paper size and orientation
You cannot rotate:	A4, B5 JIS, or A5 ☐	 GCROTA1E	When enlarging to → B4 JIS or A3  GCROTA2E
However, you can use:	A4, B5 JIS, or A5 ☐	 GCROTA3E	When enlarging to → B4 JIS or A3  GCROTA3E

 **Reference**

- See p.33 “Copying from the Bypass Tray”.
- See p.61 “Auto Paper Select”.
- See p.67 “Auto Reduce/Enlarge”.
- See p.78 “Staple”.
- See p.81 “Punch”.
- See “Copier / Document Server Features”, General Settings Guide.

Preset Reduce/Enlarge

You can select a preset ratio for copying.

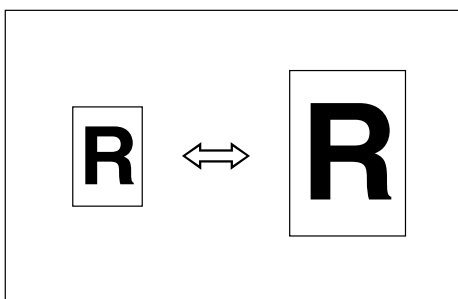

2

❖ Base Point

The base point of Reduce/Enlarge differs depending on how the original is scanned. When the original is placed on the exposure glass, the upper left corner will be the base point. When it is placed in the ADF, the bottom left corner will be the base point.

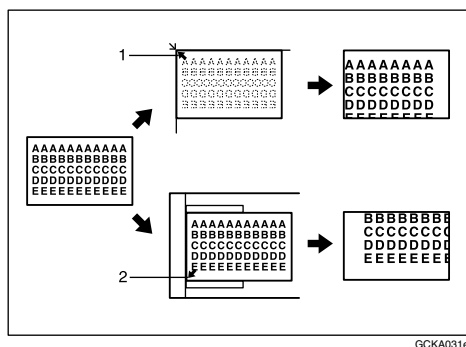

GCKA031e

- ① Base point when placed on the exposure glass.
- ② Base point when placed in the ADF.

1 Press [Reduce / Enlarge].

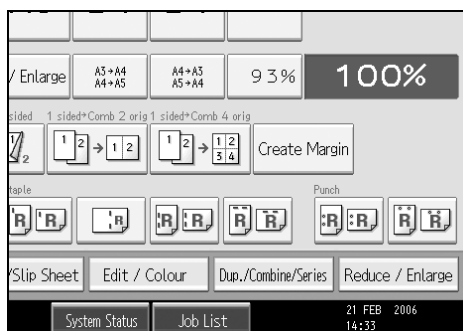

2 Select a ratio, and then press [OK].

3 Place your originals, and then press the [Start] key.

Note

- ☐ To select a preset ratio on the initial display in step 1, press the shortcut reduce/enlarge key and go to step 3.

Reference

See "Reproduction Ratio", General Settings Guide.

2**Create Margin function**

The Create Margin function reduces the image to 93% of its original size to place the reduced image at the centre. By combining it with the Reduce/Enlarge function, you can further increase a margin.

- 1 Press [Create Margin] displayed on the initial display.

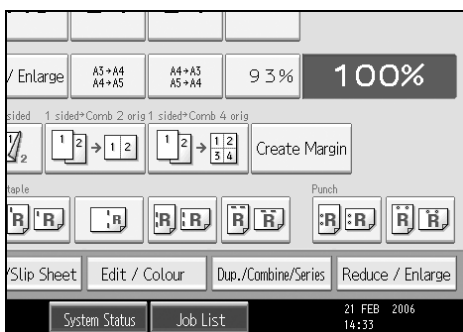

- 2 If you do not want to combine it with the Reduce/Enlarge function, place your originals, and then press the [Start] key.

Reference

See "Copier / Document Server Features", "Reproduction Ratio", General Settings Guide.

Zoom

You can change the reproduction ratio in increments of 1%.

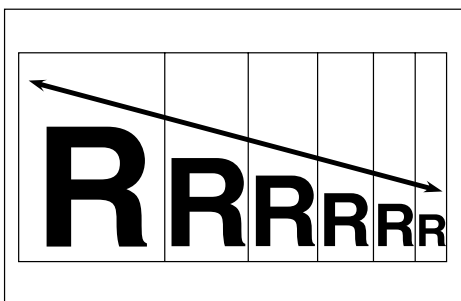

2

To select the ratio with [−] and [+]

Select a ratio using [−] or [+].

1 Press [Reduce / Enlarge].

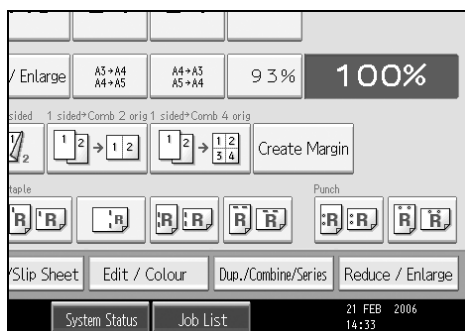

2 Select a preset ratio which is close to the desired ratio.

3 Adjust the ratio with [−] or [+].

To change the ratio in increments of 1%, press [−] or [+]. To change the ratio in increments of 10%, press and hold down [−] or [+].

4 Press [OK].

5 Place the originals, and then press the [Start] key.

Note

- If you have incorrectly entered the ratio in step **3**, readjust it with [−] or [+].

To enter the ratio with the number keys

Select a ratio using the number keys.

1 Press [Reduce / Enlarge].

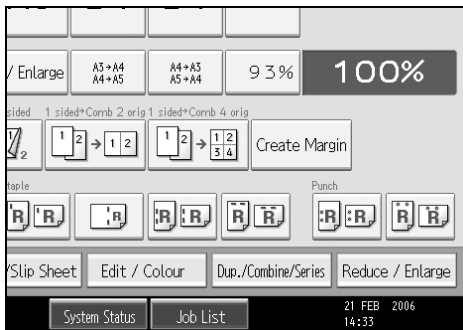

2 Press [Number keys].

3 Enter the desired ratio with the number keys, and then press the [#] key.

4 Press [OK] twice.

5 Place your originals, and then press the [Start] key.

Auto Reduce/Enlarge

The machine can choose an appropriate reproduction ratio based on the paper and original sizes you select.

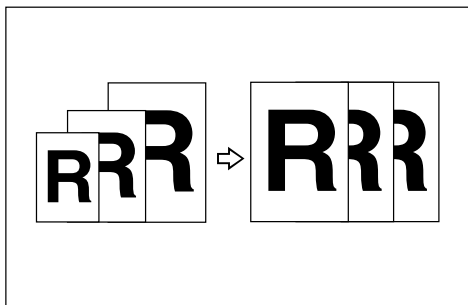

Important

- You cannot use the bypass tray with this function.
- When using Auto Reduce/Enlarge, see the following table for paper sizes and orientations you can use:

❖ Metric version

Where original is placed	Paper size and orientation
Exposure glass	A3 ☐, B4 JIS ☐, A4 ☐ ☐, B5 JIS ☐ ☐, 8" × 13" ☐
ADF	A3 ☐, B4 JIS ☐, A4 ☐ ☐, B5 JIS ☐ ☐, A5 ☐ ☐, 11 × 17" ☐, 8 ¹ / ₂ " × 11" ☐ ☐, 8" × 13" ☐, 8K ☐, 16K ☐ ☐

❖ Inch version

Where original is placed	Paper size and orientation
Exposure glass	11" × 17" ☐, 8 ¹ / ₂ " × 14" ☐, 8 ¹ / ₂ " × 11" ☐ ☐
ADF	A3 ☐, A4 ☐ ☐, 11" × 17" ☐, 8 ¹ / ₂ " × 14" ☐, 8 ¹ / ₂ " × 11" ☐ ☐, 5 ¹ / ₂ " × 8 ¹ / ₂ " ☐ ☐, 10" × 14" ☐, 7 ¹ / ₄ " × 10 ¹ / ₂ " ☐

1 Press [Auto Reduce / Enlarge].

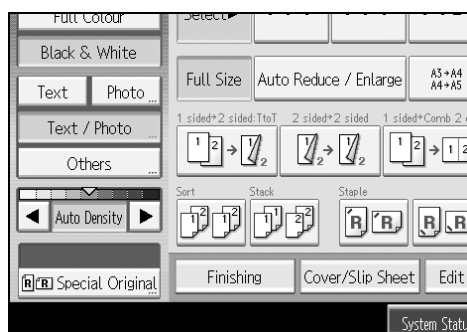

2 Select the paper size.

3 Place your originals, and then press the **[Start]** key.

Reference

See p.14 “Sizes difficult to detect”.

Size Magnification

2

This function calculates an enlargement or reduction ratio based on the lengths of the original and copy.

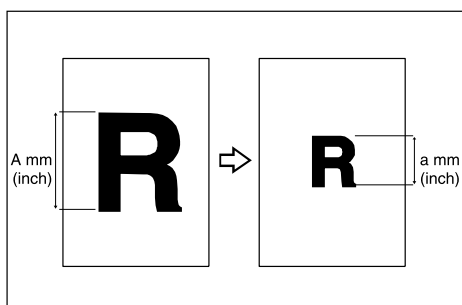

ANP059S

Measure and specify the lengths of the original and copy by comparing “A” with “a”.

1 Press **[Reduce / Enlarge]**.

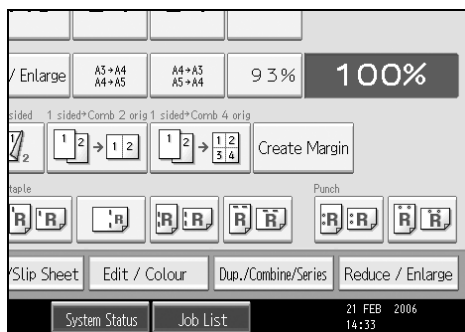

2 Press **[Size Magnification]**.

3 Enter the length of the original with the number keys, and then press the **[#]** key.
You can enter sizes between 1 to 999 mm in 1 mm steps.

4 Enter the length of the copy with the number keys, and then press the **[#]** key.

5 Press **[OK]** twice.

6 Place the originals, and then press the **[Start]** key.

Note

- To change the length after pressing the **[#]** key in step **4**, select **[Original]** or **[Copy]**, and then enter the desired length.

Directional Magnification (%)

Specify the horizontal and vertical lengths of the original and copy image at different reproduction ratio. Copies can be reduced or enlarged at different reproduction ratios horizontally and vertically.

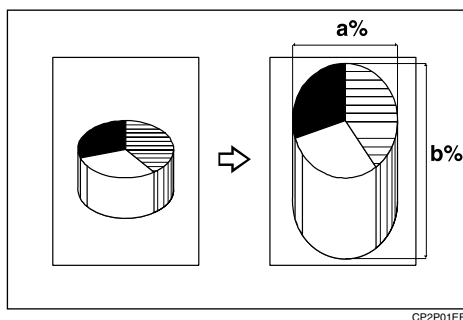

CP2P01EE

a: Horizontal ratio

b: Vertical ratio

To enter the ratio with the number keys

Select a ratio using the number keys.

1 Press [Reduce / Enlarge].

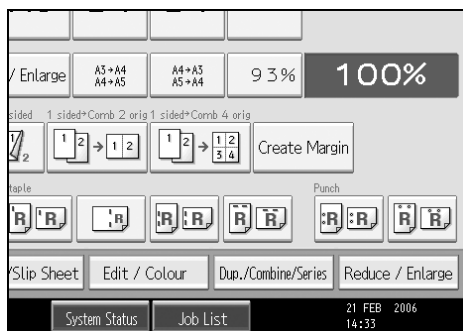

2 Press [Direct. Mag. %].

3 Press [Horizontal].

4 Enter the desired ratio with the number keys, and then press the [#] key.

5 Press [Vertical].

6 Enter the desired ratio with the number keys, and then press the [#] key.

7 Press [OK] twice.

8 Place the originals, and then press the [Start] key.

To specify the ratio with [−] and [+]

Select a ratio using [−] or [+].

1 Press [Reduce / Enlarge].

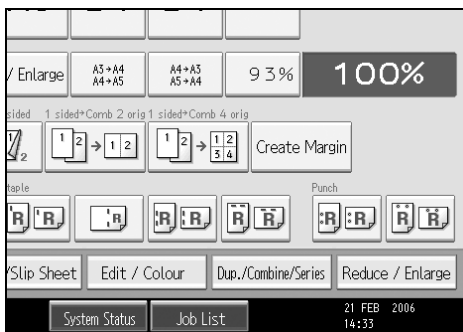

2 Press [Direct. Mag. %].

3 Press [[+] [−] keys].

4 Press [Horizontal].

5 Adjust the ratio using [+] or [−].

Pressing [+] or [−] changes the ratio in increments of 1%. Pressing and holding down [+] or [−] changes it in increments of 10%.

6 Press [Vertical].

7 Adjust the ratio with [+] or [−].

8 Press [OK] twice.

9 Place your originals, and then press the [Start] key.

Note

- If you have incorrectly entered the ratio in step **5** or **7**, readjust it with [+] or [−].

Directional Size Magnification (mm)

Specify the horizontal and vertical lengths of the original and copy image. Copies can be reduced or enlarged at different reproduction ratios horizontally and vertically.

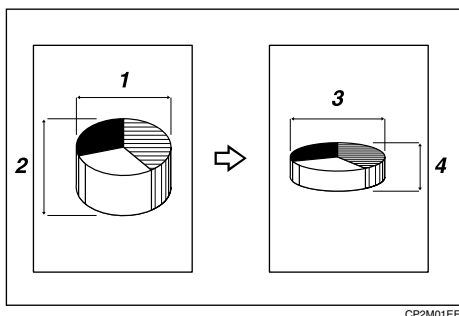

- ① Horizontal original size: A mm
- ② Vertical original size: B mm
- ③ Horizontal copy size: a mm
- ④ Vertical copy size: b mm

Measure and specify the lengths of the original and copy by comparing “A” with “a” and “B” with “b”.

1 Press [Reduce / Enlarge].

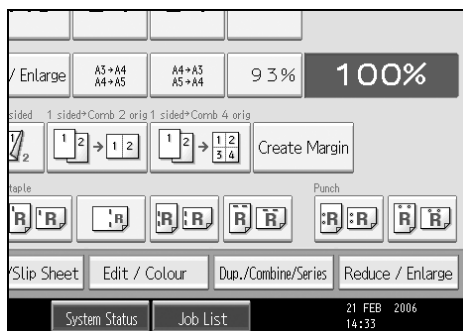

2 Press [Dir. Size Mag. mm].

3 Enter the horizontal size of the original with the number keys, and then press the [#] key.

You can enter sizes between 1 to 999 mm in 1 mm (0.1") steps.

4 Enter the horizontal size of the copy with the number keys, and then press the [#] key.

5 Enter the vertical size of the original with the number keys, and then press the [#] key.

6 Enter the vertical size of the copy with the number keys, and then press the [#] key.

7 Press [OK] twice.

8 Place the originals, and then press the [Start] key.

 **Note**



- To change a length in steps **3** to **6**, press the key you wish to change and enter the new value.

2

Sort

The machine assembles copies as sets in sequential order.

 **Important**



- To use the Rotate Sort function, two paper trays loaded with same size and type paper, but in different orientation ( ) are required. See “Tray Paper Settings”, General Settings Guide.
- You cannot use the bypass tray with Rotate Sort.

❖ **Sort**

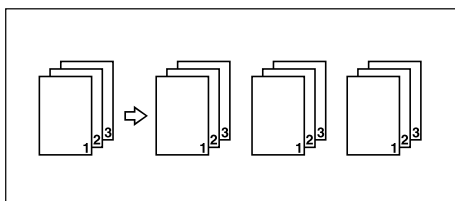
Copies are assembled as sets in sequential order.



❖ **Rotate Sort**

Every other copy set is rotated by 90 degrees ( ) and delivered to the copy tray.

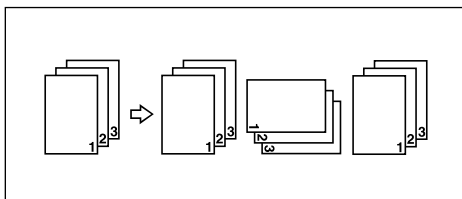

1 Press [Finishing].

2 Select [Sort] or [Rotate Sort].

When a finisher is not installed:

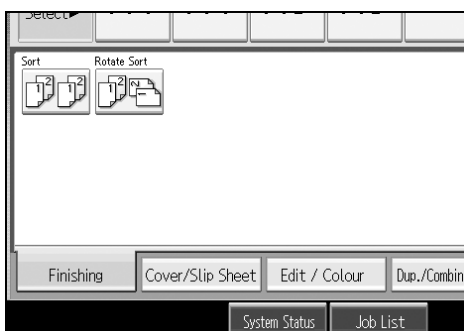

When SR790 is installed:

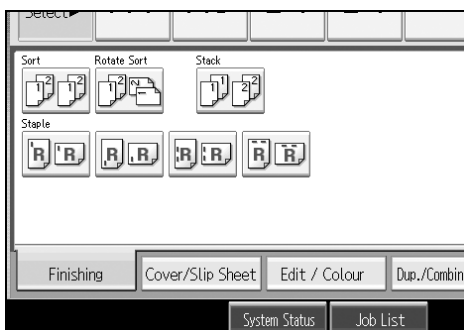

When Booklet Finisher SR3020 is installed:

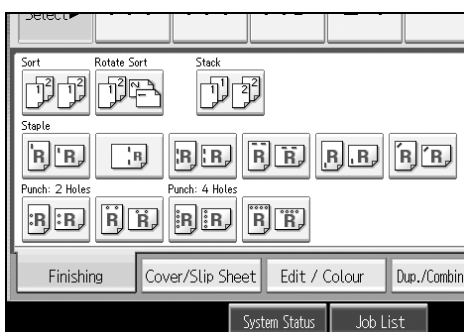

When Finisher SR3030 is installed:

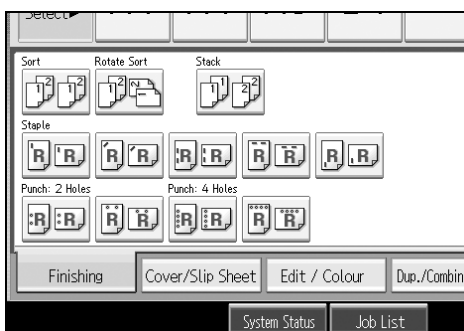

3 Press [OK].

4 Enter the number of copy sets using the number keys.

5 Place your originals.

When placing an original on the exposure glass, start with the first page to be copied. When placing an original in the ADF, set so the first page is on the top.

When placing an original on the exposure glass or in the ADF using Batch mode, press the [#] key after all the originals have been scanned.

6 Press the [Start] key.

 **Note**

To confirm the type of finishing, press the [Sample Copy] key in step 5.

 **Reference**

See "Input/Output", "Copier / Document Server Features", General Settings Guide.

Sample Copy

Use this function to check the copy settings before making a long copy run.

 **Important**

This function can be used only when the Sort function is turned on.

1 Select Sort and any other necessary functions, and then place the originals.

2 Press the [Sample Copy] key.

One copy set is delivered as a sample.

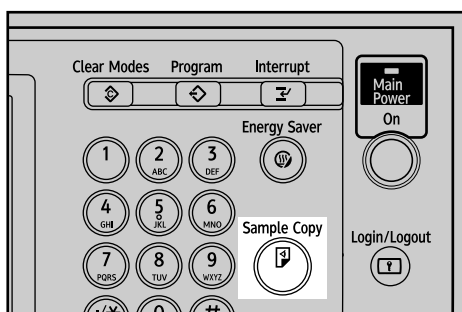

3 If the sample is acceptable, press [Continue].

The number of copies made is the number specified, minus one for the proof copy.

Note

- ❑ If you press **[Suspend]** after checking the results, return to step **1** to adjust the copy settings as necessary. You can change the settings for Staple, Punch, Duplex (1 sided → 2 sided, 2 sided → 2 sided), Copy Orientation, Margin Adjust., Cover/Slip Sheet, Stamp, and Designate. However, depending on the combination of functions, you may not be able to change some settings.

Reference

See p.171 “Function Compatibility”.

Changing the number of sets

You can change the number of copy sets during copying.

Important

- ❑ This function can only be used when the Sort function is turned on.

1 While “Copying...” is displayed, press the **[Clear/Stop]** key.

2 Press **[Change Quantity]**.

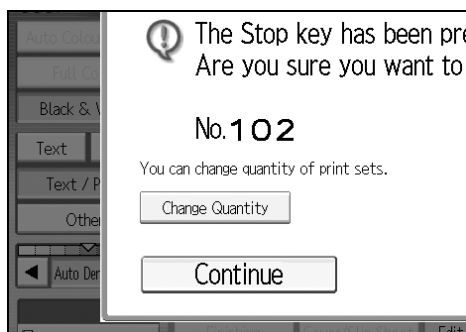

3 Enter the number of copy sets with the number keys, and then press the **[#]** key.

4 Press **[Continue]**.

Copying starts again.

Note

- ❑ The number of sets you can enter in step **3** differs depending on when the **[Clear/Stop]** key is pressed.

Stack

Copies can be assembled with each page placed.

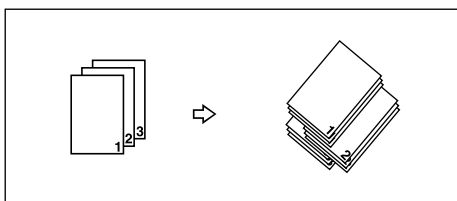

If a finisher is installed, each time the copies of one page are delivered, the next copy is shifted when delivered so you can separate each job by page.

Important

- A finisher is required.
- You cannot use the bypass tray with this function.

1 Press [Finishing].

2 Press [Stack].

SR790

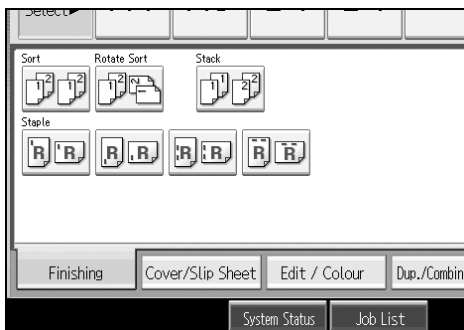

Booklet Finisher SR3020

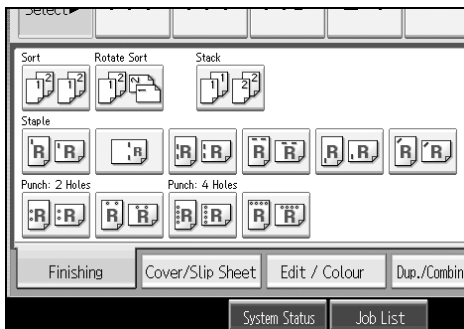

Finisher SR3030

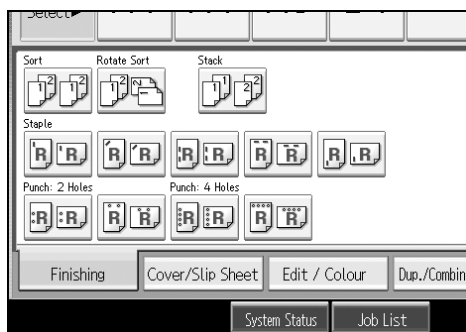

2

- 3** Press [OK].
- 4** Enter the number of copies with the number keys.
- 5** Place your originals, and then press the [Start] key.

Note

- When placing an original on the exposure glass, start with the first page to be copied. When placing an original in the ADF, set so the last page is on the bottom.

Staple

Each copy set can be stapled together.

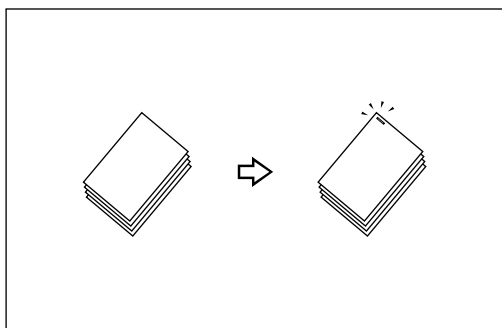

2

Important

- A finisher is required.
- You cannot use the bypass tray with this function.

❖ Stapling position and original setting

Place all the originals in the ADF in the orientation in which they can be read normally. When placing the original on the exposure glass, keep the same orientation, but set the original facing downwards. When there is copy paper that is identical in size and orientation to your original, the staple positions are as follows:

❖ SR790

		Original location		Stapling position
		Exposure glass	ADF	
	Top			
	Bottom			
	Left 2			
	Top 2			

AQ1076S

❖ Booklet Finisher SR3020

		Original location		Stapling position
		Exposure glass	ADF	
	Top 1			
	Centre			
	Left 2			
	Top 2			
	Bottom 1			
	Slant			

AQI077S

❖ Finisher SR3030

		Original location		Stapling position
		Exposure glass	ADF	
	Top 1			
	Slant			
	Left 2			
	Top 2			
	Bottom 1			

AQI051S

These tables show the stapling positions, not the orientation of delivery.
 Left 2 and Top 2 are not available for paper larger than A4 size.

- 1** Press [Finishing].
- 2** Select one of the stapling positions.

SR790

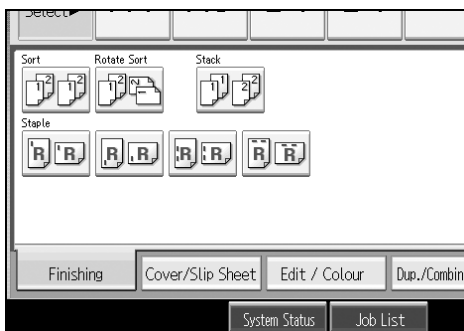

Booklet Finisher SR3020

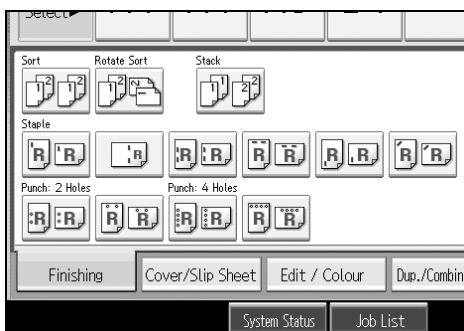

Finisher SR3030

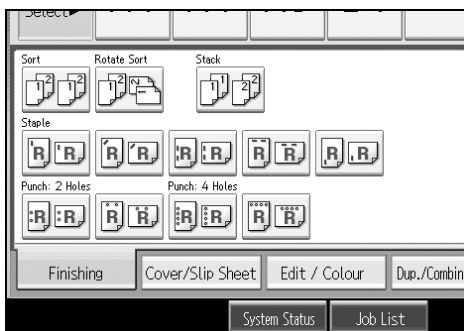

When you select a stapling position, Sort mode is automatically selected.

- 3** Press [OK].
- 4** Enter the number of copy sets using the number keys.
- 5** Place your originals, and then press the [Start] key.

 **Note**

- When placing an original on the exposure glass, start with the first page to be copied. When placing an original in the ADF, set so that the last page is on the bottom.
- When placing an original on the exposure glass or in the ADF using Batch mode, press the **【#】** key after all the originals have been scanned.

 **Reference**

See "Input/Output", General Settings Guide.

2

Punch

You can make punch holes in copies.

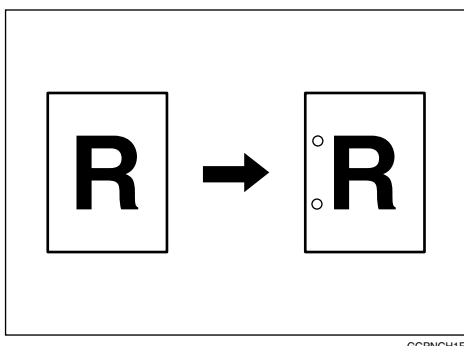
❖ 2 holes

GCPNCH1E

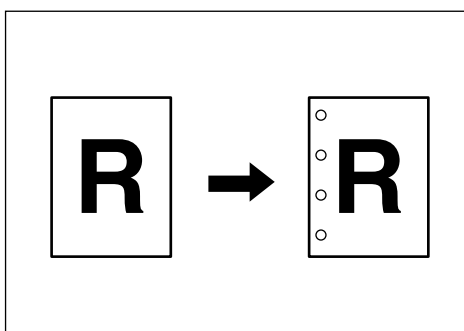
❖ 4 holes

GCPNCH0E

 **Important**

- Booklet Finisher SR3020 or Finisher SR3030 is required.
- You cannot use the bypass tray with this function.

❖ **Punch hole positions**

The relationship between the orientation in which you place the original and the punch hole positions is as follows:

		Original location		Punch hole position
		Exposure glass	ADF	
	2 hole left			
	2 hole top			
	4 hole left			
	4 hole top			

AQI078S

This table shows the punch hole positions, not the orientation of delivery.

2 hole left , 2 hole top , 4 hole left , and 4 hole top are not available for paper larger than A4 size.

- 1** Press [Finishing].
- 2** Select one of the punch hole positions.

Booklet Finisher SR3020

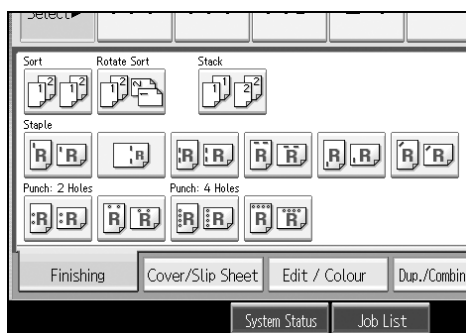

Finisher SR3030

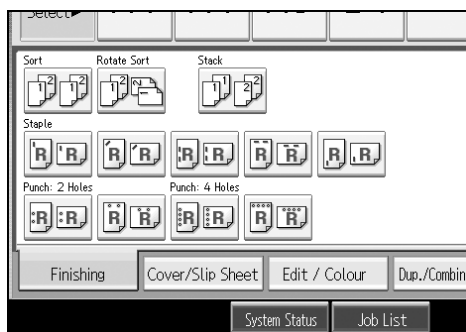

3 Press [OK].

4 Place your originals, and then press the [Start] key.

Duplex

There are two types of duplex.

❖ **1 Sided → 2 Sided**

Copies 2 one-sided pages on 1 two-sided page.

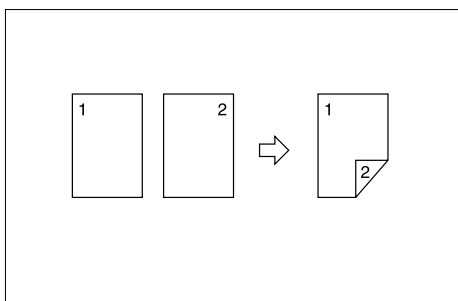

❖ **2 Sided → 2 Sided**



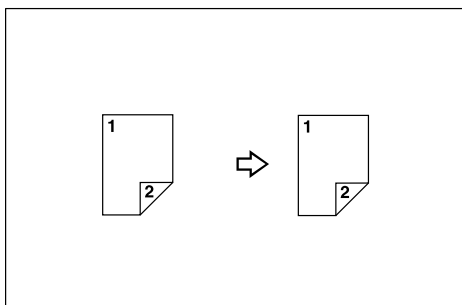





Copies 1 two-sided page on 1 two-sided page.

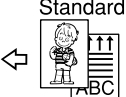

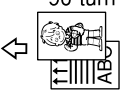
❖ **Original orientation and completed copies**

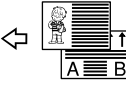
The resulting copy image will differ according to the orientation in which you place your originals (vertical or horizontal).

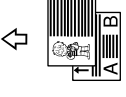
The table shows the orientation of images on the front and back of copies, not the orientation of delivery.

Original	How to place originals	Copy
Vertical 	Standard 	Top to Top 
	90° turn 	Top to Bottom 
Horizontal 	Standard 	Top to Top 
	90° turn 	Top to Bottom 

AMG050S

1 Press [Dup./Combine/Series].

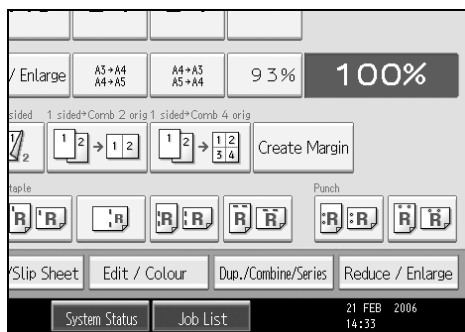

2 Press [Duplex].

3 Select [1 Sided → 2 Sided] or [2 Sided → 2 Sided].

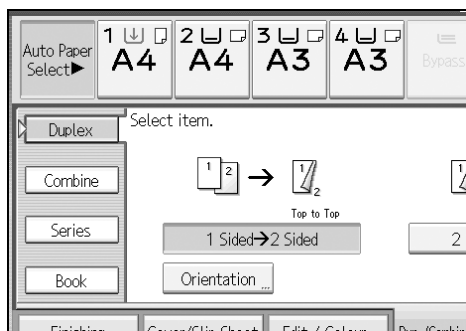

4 Press [OK].

5 Place the originals, and then press the [Start] key.

Note

- You cannot use the bypass tray with this function.
- The maximum paper weight that can be used with duplex copying is 64–105 g/m² (17-28 lb.).
- When placing an original on the exposure glass, start with the first page to be copied. When placing an original in the ADF, set so that the last page is on the bottom.
- To change originals and copy orientation in step **3**, press [Orientation].
- When placing an original on the exposure glass or in the ADF using Batch mode, press the [#] key after all the originals have been scanned.

Reference

See p.100 “Margin Adjustment”.

For related initial settings, see “Edit”, General Settings Guide.

Originals and copy orientation

You can select the orientation.

- Top to Top

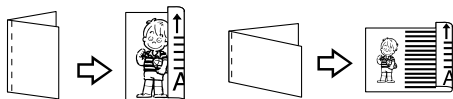

Duplex1

- Top to Bottom

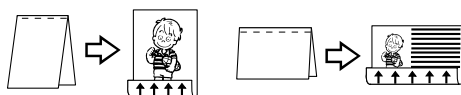

Duplex2

1 Press [Orientation].

2 Select orientation ([Top to Top]/[Top to Bottom]), and then press [OK].

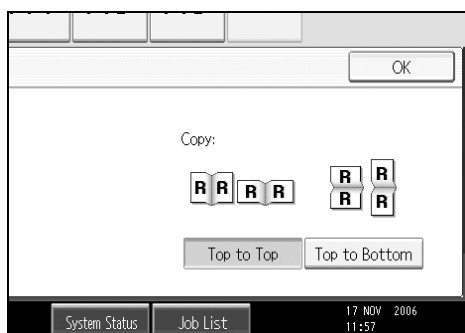

Note

- The default setting is **[Top to Top]**. You can change the default orientation with Copier/Document Server Features in User Tools.

Reference

See “Copier / Document Server Features”, General Settings Guide.

One-Sided Combine

Combine several pages onto one side of a sheet.

There are six types of One-Sided Combine.

❖ 1 Sided 2 Pages → Combine 1 Side

Copies 2 one-sided originals to one side of a sheet.

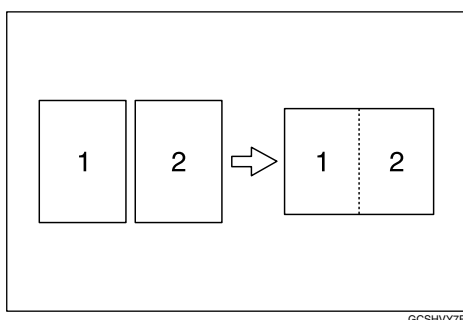

GCSHVY7E

❖ 1 Sided 4 Pages → Combine 1 Side

Copies 4 one-sided originals to one side of a sheet.

❖ 1 Sided 8 Pages → Combine 1 Side

Copies 8 one-sided originals to one side of a sheet.

❖ 2 Sided 1 Page → Combine 1 Side

Copies 1 two-sided original to one side of a sheet.

❖ 2 Sided 2 Pages → Combine 1 Side

Copies 2 two-sided originals to one side of a sheet.

❖ 2 Sided 4 Pages → Combine 1 Side

Copies 4 two-sided originals to one side of a sheet.

❖ Orientation of the original and image position of combine

Open to left (☐) originals

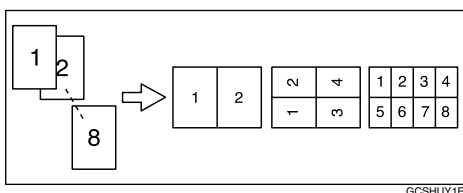

GCSHUY1E

Open to top (☐) originals

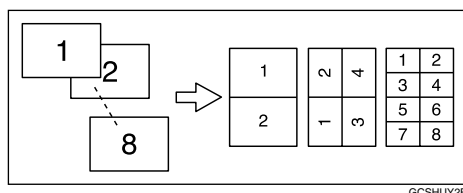

GCSHUY2E

Placing originals (originals placed in the ADF)

- Originals read from left to right

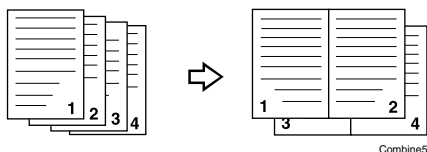

- Originals read from top to bottom

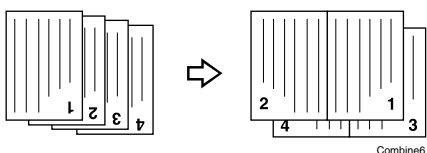

1 Press [Dup./Combine/Series].

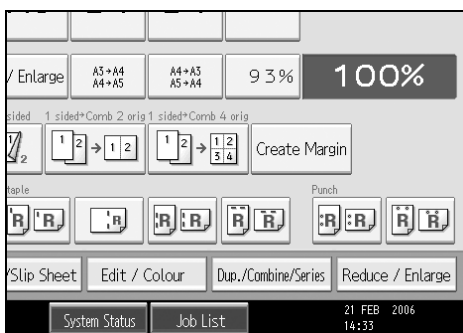

2 Press [Combine].

3 Select [1 Sided] or [2 Sided] for Original, and then press [Combine 1 Side] for Copy.

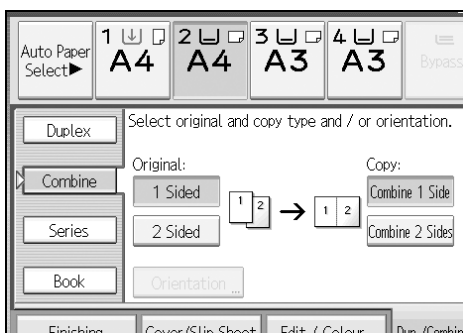

4 Select the number of originals to combine.

5 Select the paper size.

6 Press [OK].

7 Place your originals, and then press the [Start] key.

Note

- ❑ You cannot use the bypass tray with this function.

Reference

See "Edit", General Settings Guide.

See p.86 "Originals and copy orientation".

Two-Sided Combine

2

Combines various pages of originals into one sheet with two sides.

There are six types of Two-Sided Combine.

❖ 1 Sided 4 Pages → Combine 2 Sides

Copies 4 one-sided originals to one sheet with two pages per side.

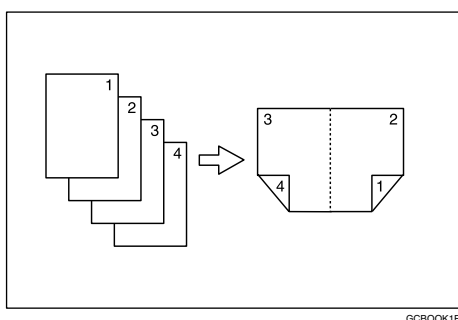

GCB00K1E

❖ 1 Sided 8 Pages → Combine 2 Sides

Copies 8 one-sided originals to one sheet with four pages per side.

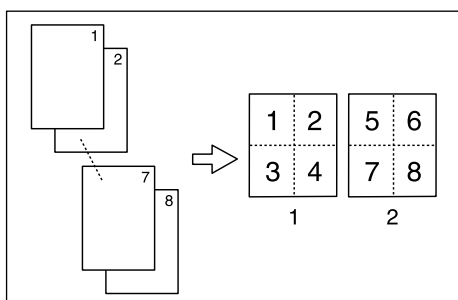

GCSHVYAE

① Front

② Back

❖ **1 Sided 16 Pages → Combine 2 Sides**

Copies 16 one-sided originals to one sheet with eight pages per side.

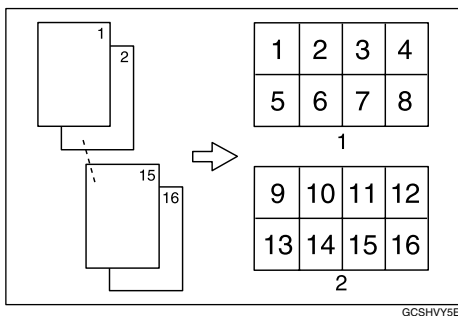

- ① Front
- ② Back

❖ **2 Sided 2 Pages → Combine 2 Sides**

Copies 2 two-sided originals to one sheet with two pages per side.

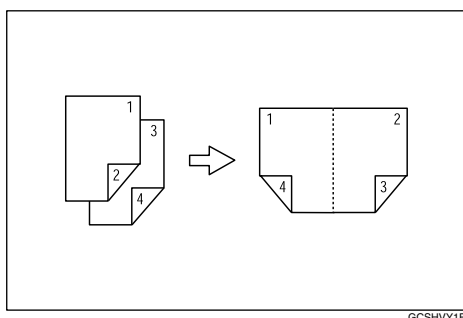

❖ **2 Sided 4 Pages → Combine 2 Sides**

Copies 4 two-sided originals to one sheet with four pages per side.

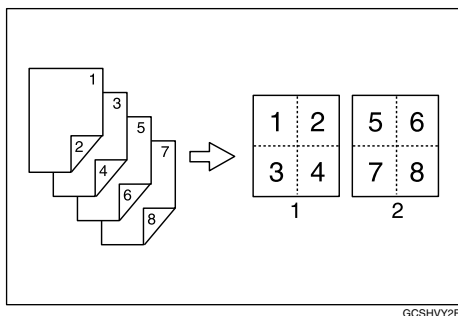

- ① Front
- ② Back

❖ 2 Sided 8 Pages → Combine 2 Sides

Copies 8 two-sided originals to one sheet with eight pages per side.

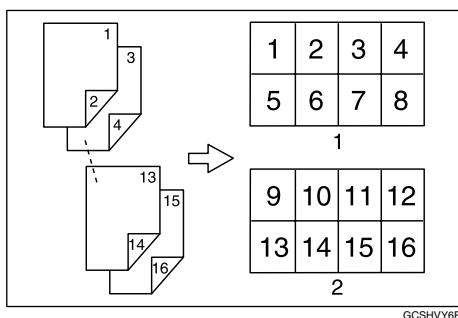

① Front

② Back

1 Press [Dup./Combine/Series].

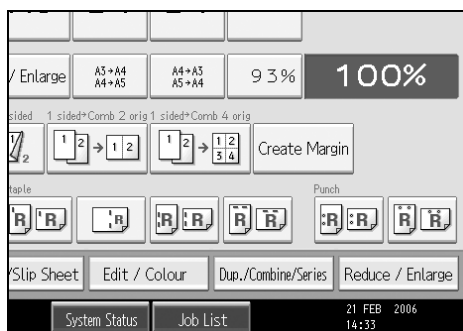

2 Press [Combine].

3 Select [1 Sided] or [2 Sided] for Original, and then press [Combine 2 Sides] for Copy.

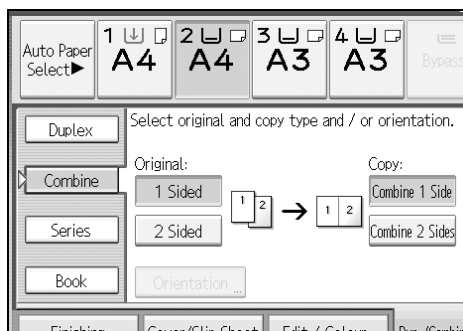

4 Press [Orientation].

5 Select orientation ([Top to Top]/[Top to Bottom]), and then press [OK].

6 Select the number of originals to combine.

7 Select the paper size.

8 Press [OK].

9 Place your originals, and then press the [Start] key.

 **Note**

- You cannot use the bypass tray with this function.

 **Reference**

See "Edit", General Settings Guide.

See p.86 "Originals and copy orientation".

Series Copies







Separately copies the front and back of a two-sided original or the two facing pages of a bound original onto two sheets.

There are two types of Series Copies.

 **Important**





- You cannot use the Book → 1 Sided function from the ADF.
- See the following table for original and copy paper sizes when using a 100% ratio:

❖ **Metric version**

Original	Paper for 1-sided copy
A3 	A4  × 2 sheets
B4 JIS 	B5 JIS  × 2 sheets
A4 	A5  × 2 sheets

AMA020S

❖ **Inch version**

Original	Paper for 1-sided copy
11" × 17" 	8 1/2" × 11"  × 2 sheets
8 1/2" × 11" 	5 1/2" × 8 1/2"  × 2 sheets

AMA027S

❖ **Book → 1 Sided**

You can make one-sided copies from two facing pages of a bound original (book).

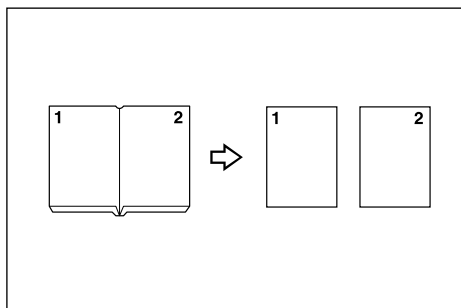

CP2B0100

❖ **2 Sided → 1 Sided**

You can make one-sided copies from two-sided originals.

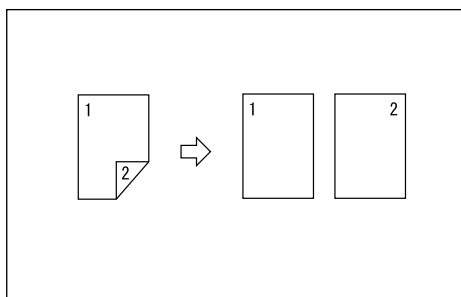
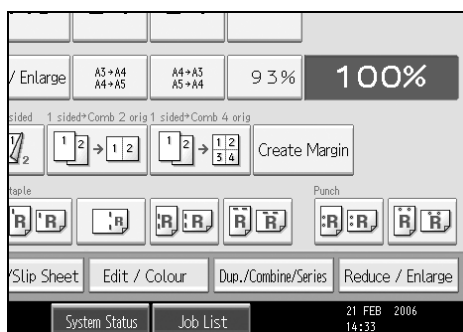
**1** Press [Dup./Combine/Series].**2** Press [Series].**3** Select [2 Sided → 1 Sided] or [Book → 1 Sided], and then press [OK].

If you selected [2 Sided → 1 Sided], you can change the orientation.

4 Place your original on the exposure glass, and then press the [Start] key.**Note**

- Press the [#] key after all originals have been scanned.

Booklet/Magazine







Copies two or more originals in page order.

There are six types of Booklet/Magazine.

❗ Important





- ❑ The following table shows the paper sizes of two-sided original and two-sided copy (when copying at a ratio of 100%):

❖ Metric version

Original	Paper for 1-sided copy
A3 	A4  × 2 sheets
B4 JIS 	B5 JIS  × 2 sheets
A4 	A5  × 2 sheets

AMA020S

❖ Inch version

Original	Paper for 1-sided copy
11" × 17" 	8 1/2" × 11"  × 2 sheets
8 1/2" × 11" 	5 1/2" × 8 1/2"  × 2 sheets

AMA027S

❖ 1 Sided → Booklet

Make copies in page order for a folded booklet as shown.

- Open to left

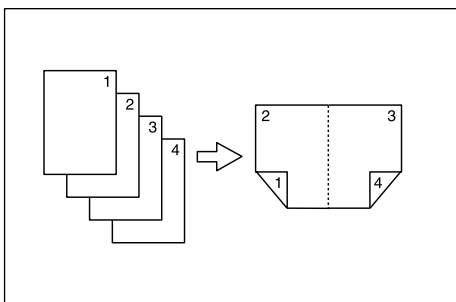

GCBOOK0E

- Open to right

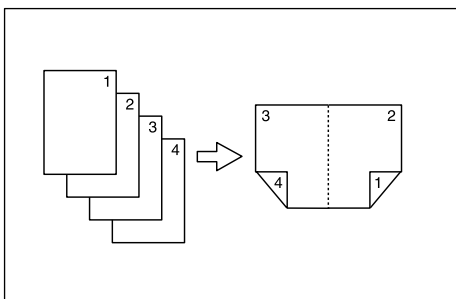

GCBOOK1E

❖ **2 Sided → Booklet**

Make two-sided originals to copies in page order for a folded booklet as shown.

- Open to left

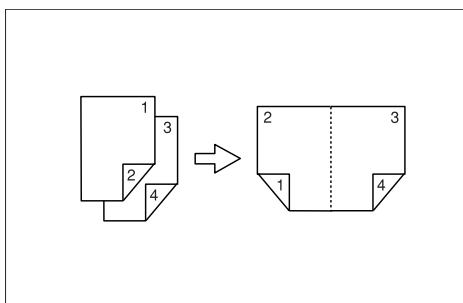

GCAH010E

- Open to right

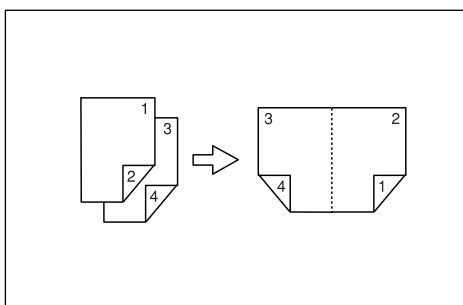

GCAH020E

❖ **1 Sided → Magazine**

Copies two or more originals to make copies in page order when they are folded and stacked.

- Open to left

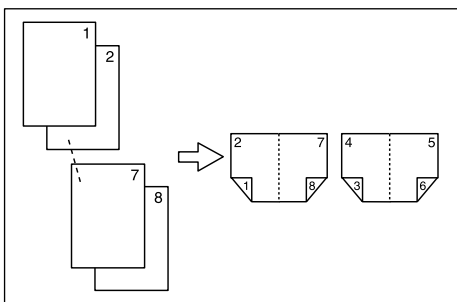

GCBOOK3E

- Open to right

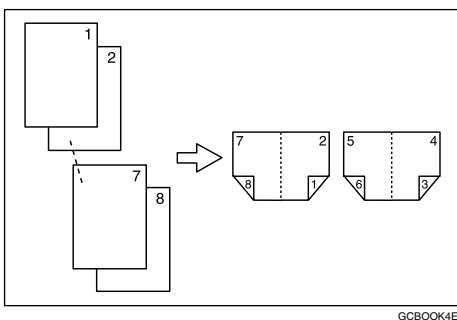

GCB00K4E

❖ **2 Sided** → Magazine

Copies two or more originals of two-sided to make copies in page order when they are folded and stacked.

- Open to left

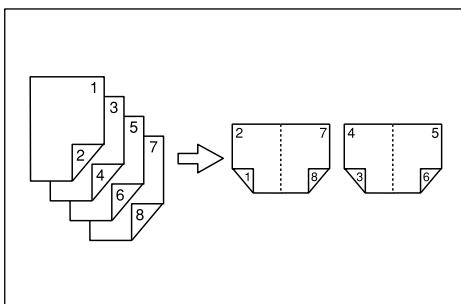

GCAH030E

- Open to right

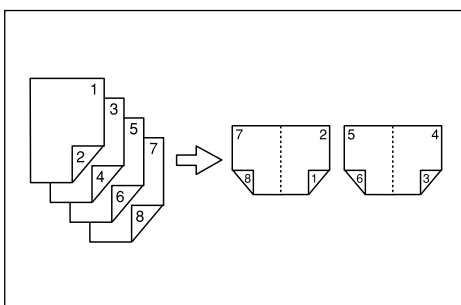

GCAH040E

❖ **Book → 2 Sided**

Copies a two-page spread original onto one sheet with one page per side.

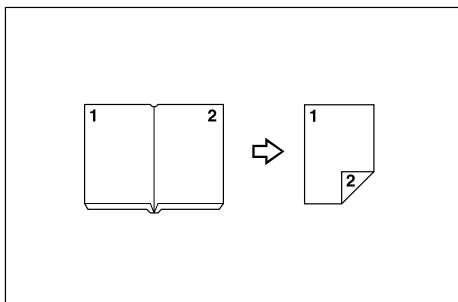

You cannot use the bypass tray with “Book → 2 Sided” or “Front&Back → 2 Sided”.

❖ **Front & Back → 2 Sided**

Copies each two-page spread original as it is onto both sides of a sheet.

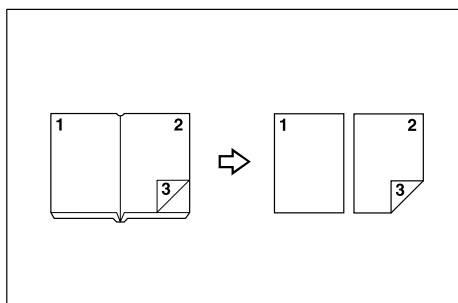
❖ **How to fold and unfold copies to make a booklet**

As shown below, fold a copy along the centreline, and open.

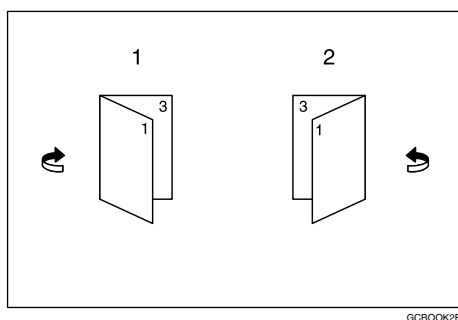

- ① Open to left
- ② Open to right

❖ **How to fold and unfold copies to make a magazine**

As shown below, fold and stack copies to make a magazine, and open.

- Open to left

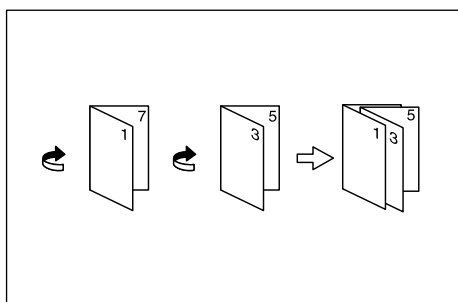

GCBOOK6E

- Open to right

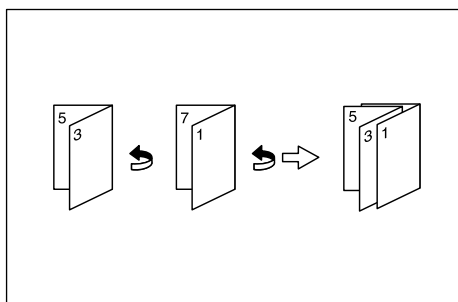

GCBOOK6E

1 Select [Open to Left] or [Open to Right] with User Tools.

2 Press [Dup./Combine/Series].

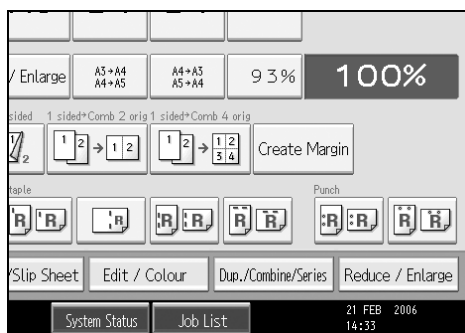

3 Press [Book].

4 Select a book type separately for the original ([1 Sided] or [2 Sided]) and copy ([Booklet] or [Magazine]), or select a book type from [Book → 2 Sided] and [Front&Back → 2 Sided].

5 Select the paper size.

6 Press [OK].

7 Place your originals, and then press the [Start] key.

 **Note**

- You cannot use the bypass tray with this function.
- When placing an original on the exposure glass or in the ADF using Batch mode, press the **[#]** key after all the originals have been scanned.
- The machine sets the reproduction ratio automatically to meet the paper size.

 **Reference**

See "Edit", General Settings Guide.

Margin Adjustment

Copies originals leaving a binding margin.

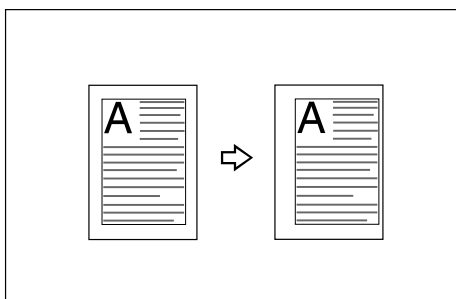

1 Press [Edit / Colour].

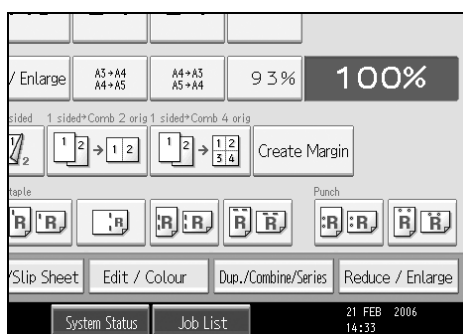

2 Press [Margin Adj.].

3 Set a binding margin for a front page. Press [←] and [→] when setting the left and right margins, and [↓] and [↑] when setting the top and bottom margins.

4 Set a binding margin for the back side pages. Press [←] and [→] when setting the left and right margins, and [↓] and [↑] when setting the top and bottom margins, and then press [OK].

Margin on the back side of the page is valid when [1 Sided → 2 Sided] or [Combine 2 Sides] is selected.

5 Place your originals, and then press the [Start] key.

Note

- If you make a mistake, press [←], [→], [↓], [↑], or press [Clear] to set a new value.
- If you do not need to specify the margins for the back side pages in step **4**, press [OK] and proceed to step **5**.

Reference

See "Edit", General Settings Guide.

Erase

This function erases the centre and/or all four sides of the original image.

This function has the following three types:

❖ Border

This mode erases the edge margin of the original image.

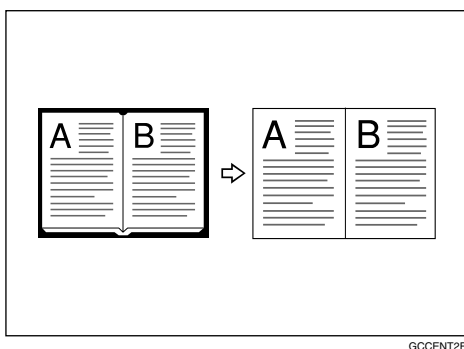

❖ Centre

This mode erases the centre margin of the original image.

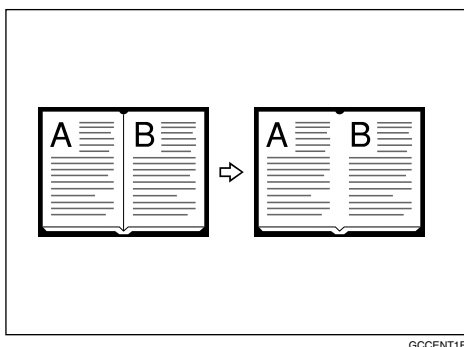

❖ Centre/Border

This mode erases both the centre and edge margins of the original image.

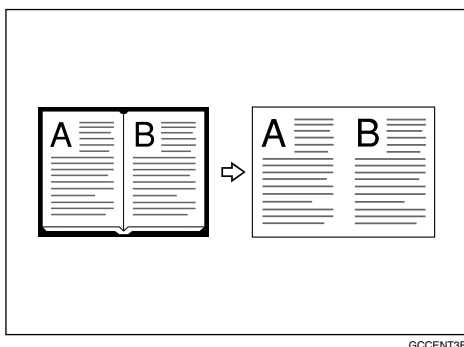

Note

- The erase width is set to 10 mm (0.4 inch) as a default. You can change this setting with User Tools. See "Edit", General Settings Guide.
- The relationship between the original orientation and the erased part is as follows:

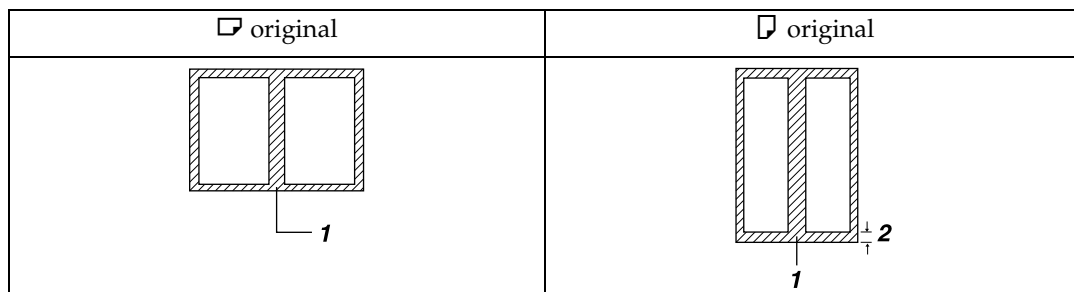

- ① Erased part
- ② 2-99 mm (0.1"-3.9")

Border Erase (same width)

This mode erases the edge margin of the original image.

1 Press [Edit / Colour].

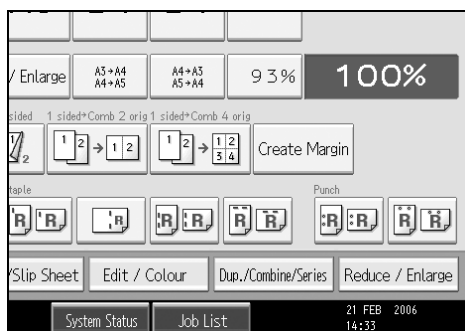

2 Press [Erase].

3 Press [Erase Centre / Border].

4 Press [Same Width].

5 Set an erase border width with **[+]** or **[-]**.

Pressing **[+]** or **[-]** changes the width in increments of 1 mm (0.1 inch). Pressing and holding down the relevant key changes the width in increments of 10 mm (1 inch).

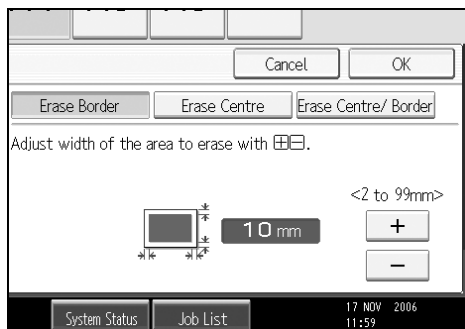
**6** Press **[OK]** twice.**7** Place your originals, and then press the **[Start]** key.**Note**

To change the value entered in step **5**, press **[+]** and **[-]** to set a new value.

Border Erase (different width)

This mode erases the edge margin of the original image.

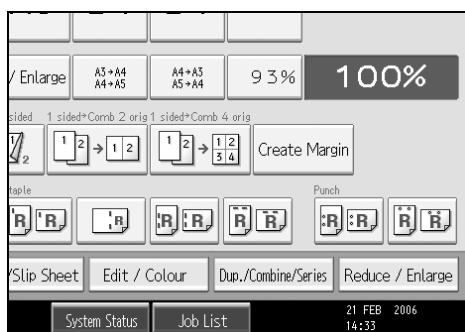
1 Press **[Edit / Colour]**.**2** Press **[Erase]**.**3** Press **[Erase Centre / Border]**.**4** Press **[Different Width]**.

- 5** Press the key for the border you want to change and set an erase width with **[+]** and **[-]**.

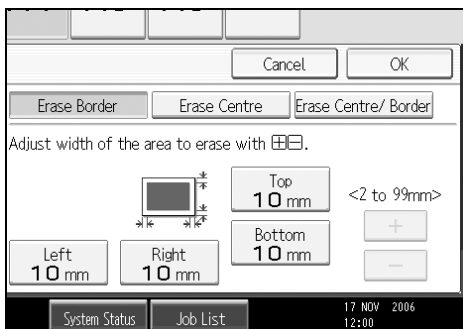

- 6** Press **[OK]** twice.

- 7** Place your originals, and then press the **[Start]** key.

Centre Erase

This mode erases the centre margin of the original image.

- 1** Press **[Edit / Colour]**.

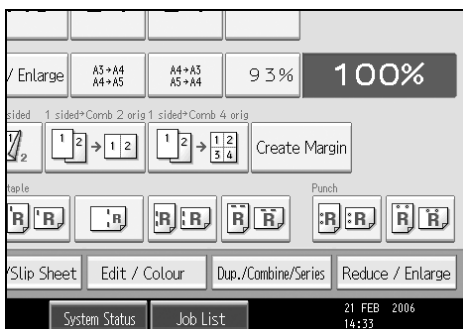

- 2** Press **[Erase]**.

- 3** Press **[Erase Centre / Border]**.

- 4** Press **[Erase Centre]**.

- 5** Set the erase centre width with **[+]** and **[-]**.

- 6** Press **[OK]** twice.

- 7** Place your originals, and then press the **[Start]** key.

Centre/Border Erase (same width)

This mode erases both the centre and edge margins of the original image.

1 Press [Edit / Colour].

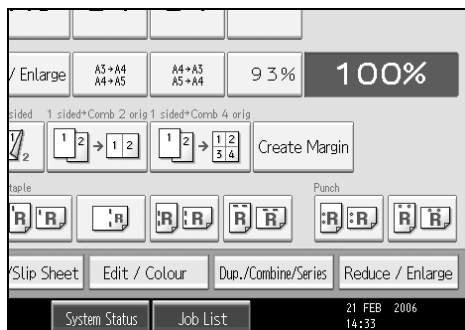

2 Press [Erase].

3 Press [Erase Centre / Border].

4 Press [Erase Centre / Border].

5 Press [Same Width].

6 Press [Centre], and then set the erase centre width with [+] and [-].

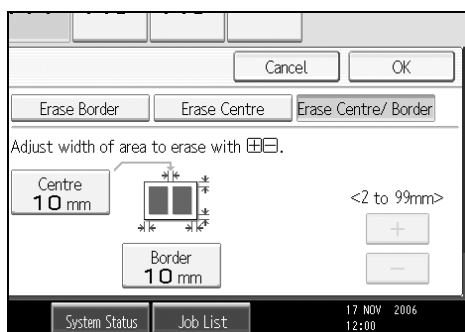

7 Press [Border], and then set the erase border width with [+] and [-].

8 Press [OK] twice.

9 Place your originals, and then press the [Start] key.

Centre/Border Erase (different width)

This mode erases both the centre and edge margins of the original image.

1 Press [Edit / Colour].

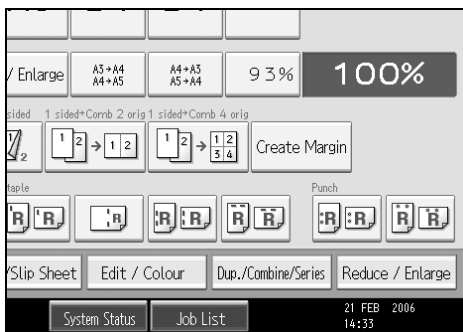

2 Press [Erase].

3 Press [Erase Centre / Border].

4 Press [Erase Centre / Border].

5 Press [Different Width].

6 Press the key for the border you want to change and set an erase width with [+] and [-].

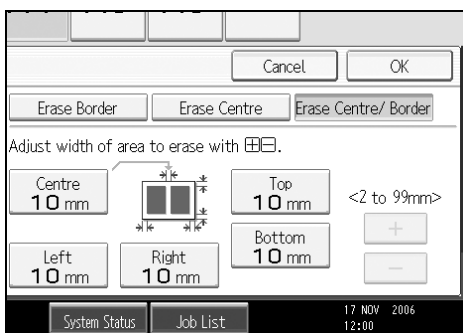

7 Press [OK] twice.

8 Place your originals, and then press the [Start] key.

Background Numbering

Use this function to have numbers printed on the background of copies. If this function is used in conjunction with Sort, the same numbers are printed on each set of copies, helping you keep track of confidential documents.

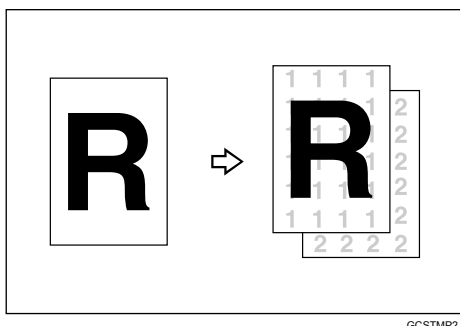

GCSTMP2J

⚠ Important

- You cannot use the bypass tray with this function.

1 Press [Edit / Colour].

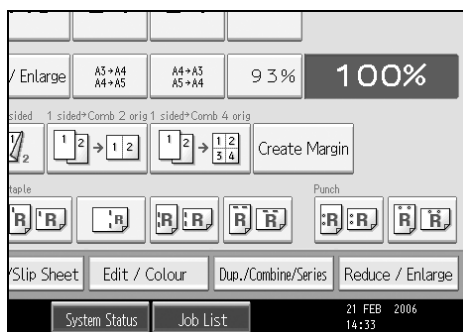

2 Press [Stamp].

3 Press [Background Numbering].

4 Enter the number to start counting from with the number keys, and then press the [#] key.

5 Press [OK] twice.

6 Place your originals, and then press [Start] key.

📌 Note

- To change the value entered in step 4, press [Clear] or the [Clear/Stop] key to set a new value.
- When the Full Colour Copy is selected, the full colour counter will advance by "1".
- The default colour is black.

Reference

See “Background Numbering”, General Settings Guide.

Preset Stamp

Messages are stamped on copies.

2

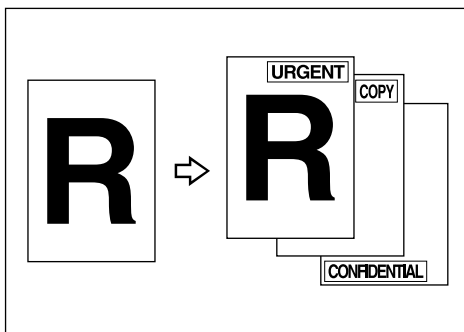

GCSTMP1E

Important

- You cannot use the bypass tray with this function.
- Only one message can be stamped at a time.
- The following eight messages are available for stamping: “COPY”, “URGENT”, “PRIORITY”, “For Your Info.”, “PRELIMINARY”, “For Internal Use Only”, “CONFIDENTIAL”, “DRAFT”

Stamp position and original orientation

The stamp positions differ according to the orientation in which you place your originals.

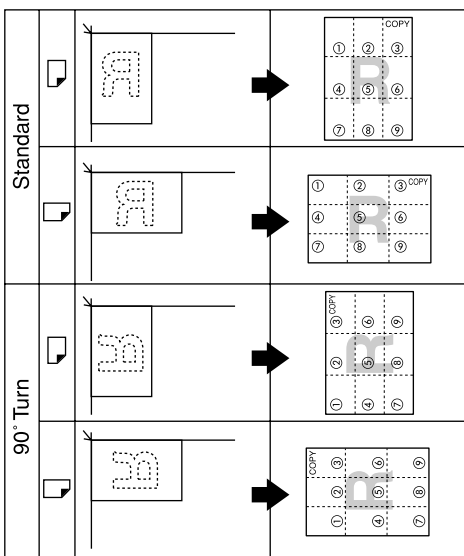

Key on the display	↖	↑	↗	←	✳	→	↙	↓	↘
Stamp position	①	②	③	④	⑤	⑥	⑦	⑧	⑨

GCSTMP5E

1 Press [Edit / colour].

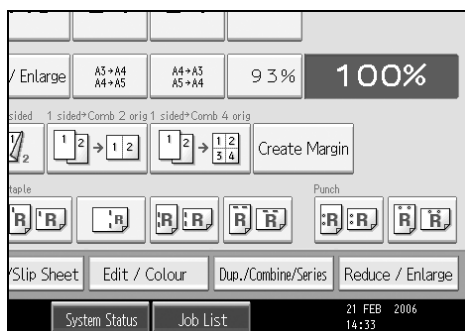

2 Press [Stamp].

3 Press [Preset Stamp].

4 Select the desired message.

You can change the stamp colour, position, size, and density of the stamp.

5 Press [All Pages] or [1st Page Only] to select the print page.

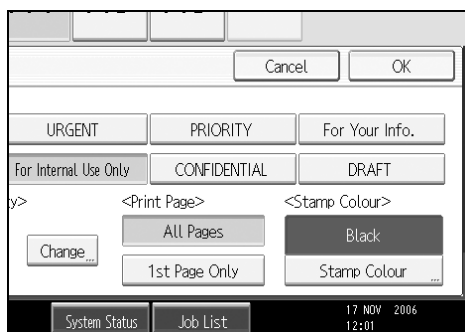

6 After you specify all desired settings, press [OK].

7 Press [OK].

8 Place your originals, and then press the [Start] key.

Note

- When the Full Colour Copy is selected, the full colour counter will advance by "1".
- The default user stamp colour is red.

Reference

See "Preset Stamp", General Settings Guide.

Changing the stamp colour

Changes the stamp colour.

- 1 Press [Stamp Colour] under Stamp Colour.
- 2 Select the stamp colour, and then press [OK].

Changing the stamp position, size and density

Changes the stamp position, size and density.

- 1 Press [Change] under [Position / Size / Density].
- 2 Select the position for print, size, and density, and then press [OK].

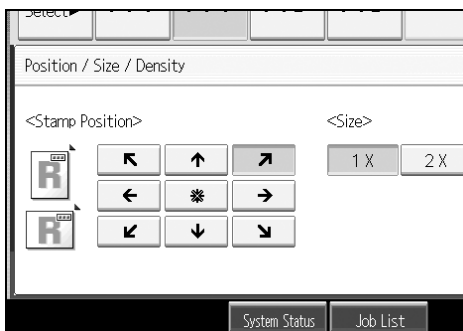

User Stamp

Copies a scanned image as a stamp. Letters or images you use frequently can be registered.

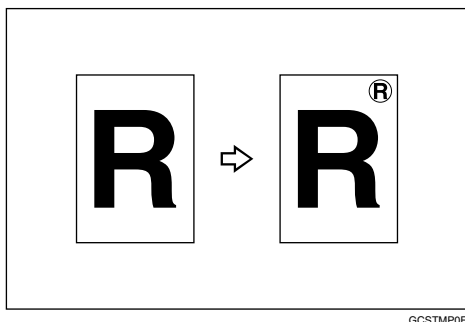

GCSTMP0E

Important

- You have to register a user stamp before using this function.
- You cannot use the bypass tray with this function.
- Only one message can be stamped each time.

❖ Stamp position and original orientation

The user stamp positions differ according to the orientation in which you place your originals.

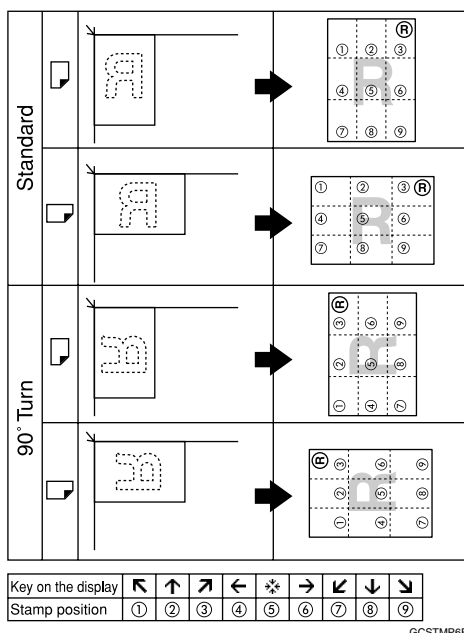

GCSTMP6E

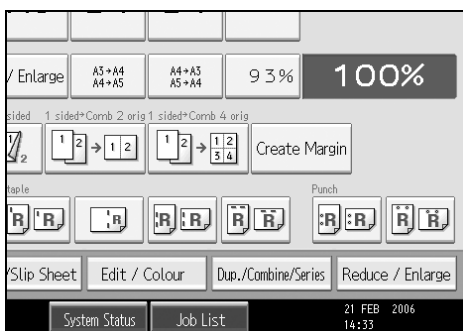
1 Press [Edit / Colour].**2** Press [Stamp].**3** Press [User Stamp].**4** Select the stamp you require.

You can change the stamp colour and position.

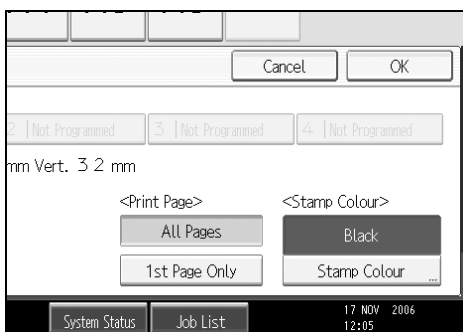
5 Press [All Pages] or [1st Page Only] to select the print page.**6** After making all settings, press [OK].**7** Press [OK].**8** Place your originals, and then press the [Start] key.**Note**

- When the Full Colour Copy is selected, the full colour counter will advance by "1".
- The default user stamp colour is red.

Reference

See p.113 "To program the user stamp".

See "User Stamp", General Settings Guide.

Changing the user stamp colour

Changes the stamp colour.

- 1** Press [Stamp Colour] under Stamp Colour.
- 2** Select the stamp colour, and then press [OK].

Changing the user stamp position

Changes the stamp position.

- 1** Press [Change] under Stamp Position.
- 2** Select the desired position, and then press [OK].

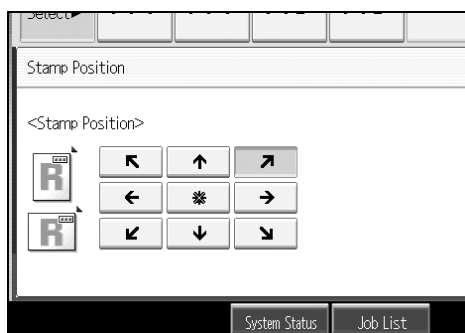

To program the user stamp

This function scans an image that is used as a user stamp.

The range of stamp images for readability is 10–297 mm (0.4"-11.7") high and 10–432 mm (0.4"-17.0") wide. However, if the value exceeds the maximum value of the area (5,000 mm², 7.75 inch²), it is corrected within the range of the area automatically.

- 1** Press the [User Tools/Counter] key.

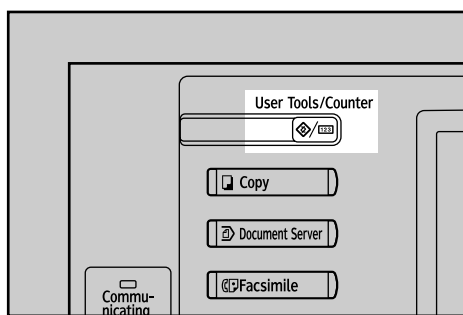

2 Press [Copier / Document Server Features].

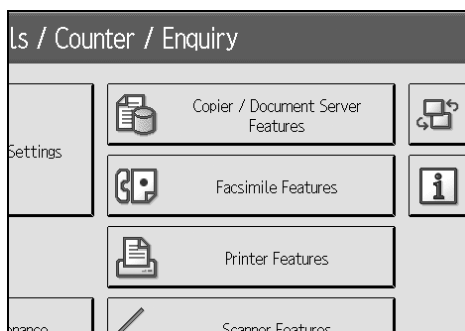

3 Press [Stamp].

4 Press [User Stamp].

5 Press [Program / Delete Stamp].

6 Press [↔Program], and then press the stamp number you want to program.

7 Enter the user stamp name (up to ten characters) with the letter keys, and then press [OK].

8 Enter the horizontal size of the stamp with the number keys, and then press the [#] key.

9 Enter the vertical size of the stamp with the number keys, and then press the [#] key.

10 Place the original for user stamp on the exposure glass, and then press [Start Scanning].

The original will be scanned, and the stamp will be registered.

11 Press [Exit].

12 Press [Exit].

The display returns to the User Tools/Counter/Enquiry screen.

13 Press [Exit].

Exits settings and gets ready to copy.

Note

- Stamp numbers with ↔ already have settings in them.
- If the stamp number is already being used, the machine will ask you if you want to overwrite it. Press [Yes] or [Stop].
- Originals cannot be scanned from the ADF when programming the user stamp.

To delete the user stamp

Deletes an image registered as a user stamp.

You cannot restore a deleted stamp.

- 1 Press the **[User Tools/Counter]** key.

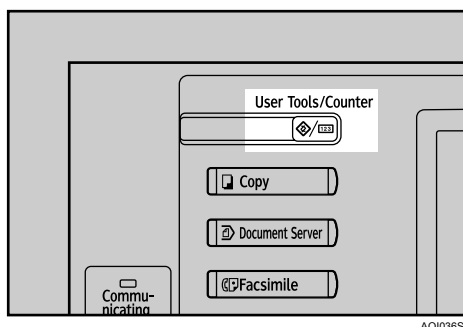

- 2 Press **[Copier / Document Server Features]**.

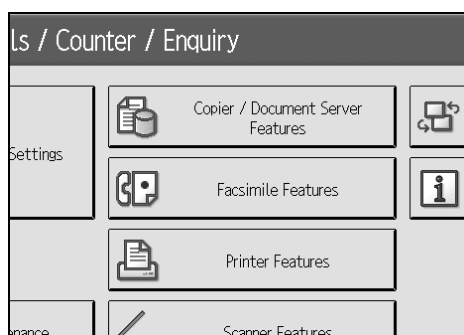

- 3 Press **[Stamp]**.
- 4 Press **[User Stamp]**.
- 5 Press **[Program / Delete Stamp]**.
- 6 Press **[Delete]**, and then press the stamp number you want to delete.
- 7 Select **[Yes]**, and then press **[Exit]**.
- 8 Press **[Exit]**.

The display returns to the User Tools/Counter/Enquiry screen.

- 9 Press **[Exit]**.

Exits settings and gets ready to copy.

Date Stamp

Use this function to print dates on your copies.

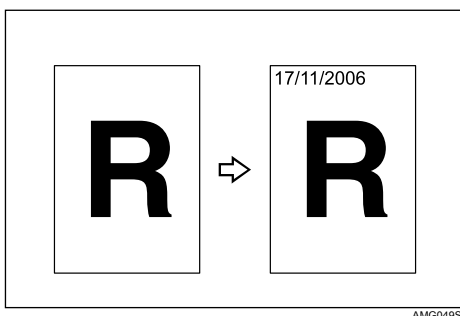

You can select from the following styles:

- MM/DD/YYYY
- MM.DD.YYYY
- DD/MM/YYYY
- DD.MM.YYYY

❖ Stamp position and original orientation

The date stamp positions differ according to the orientation in which you place your originals.

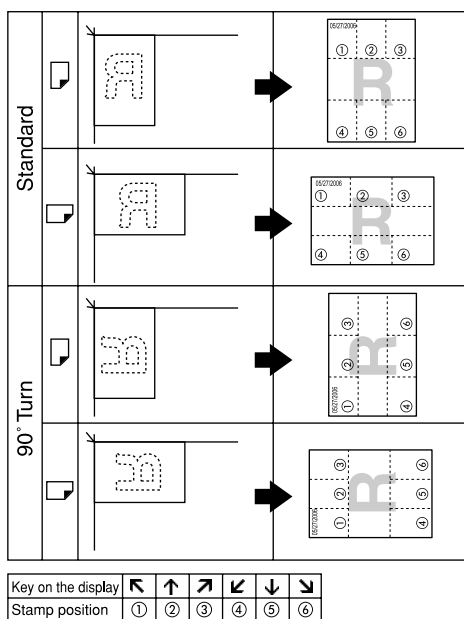

⚠ Important

- ❑ You cannot use the bypass tray with this function.

1 Press [Edit / Colour].

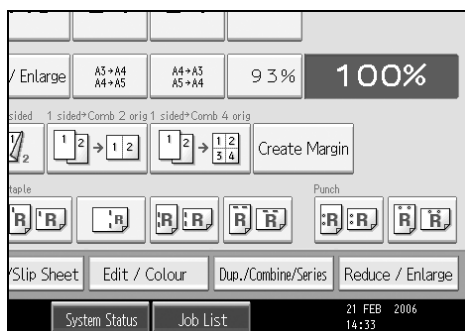

2 Press [Stamp].

3 Press [Date Stamp].

4 Select the stamp format.

You can change the stamp colour, style and position of the date to be stamped.

5 Press [All Pages] or [1st Page Only] to select the print page.

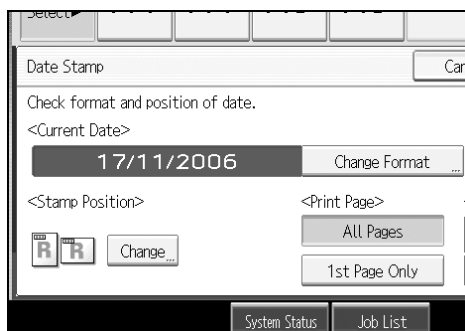

You can change the stamp colour, format and position of the date to be stamped.

6 After all settings are complete, press [OK].

7 Press [OK].

8 Place your originals, and then press the [Start] key.

Note

- The default colour is black.

Reference

See "Date Stamp", General Settings Guide.

To change the date stamp colour

Changes the stamp colour.

- 1 Press [Stamp Colour] under Stamp Colour.
- 2 Select the stamp colour, and then press [OK].

To change the format of date

Changes the style of date to be stamped.

- 1 Press [Change Format] under Current Date.

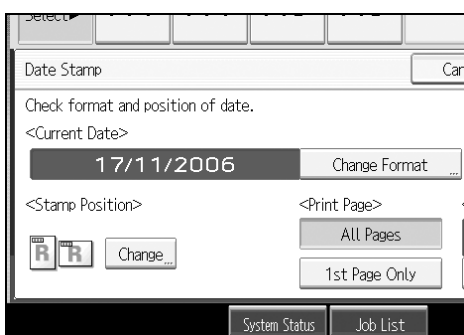

- 2 Select the date format, and then press [OK].

To change the date stamp position

Changes the stamp position.

- 1 Press [Change] under Stamp Position.



2 Select the desired date stamp position, and then press [OK].

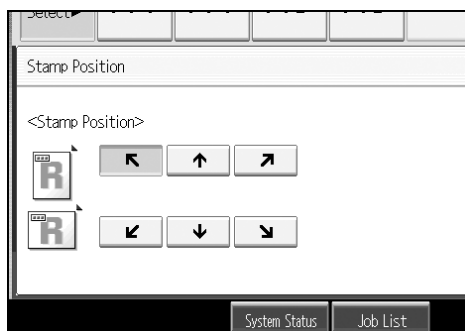

2

Page Numbering

Use this function to print page numbers on your copies.

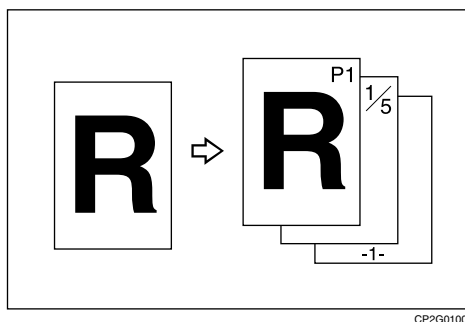

There are six types of page numbering.

- P1,P2,...
- 1/5,2/5,...
- -1,-2-,...
- P.1,P.2,...
- 1, 2, ...
- 1-1,1-2,...

❖ **Stamp position and original orientation**

The page stamp positions differ according to the orientation in which you place your originals.

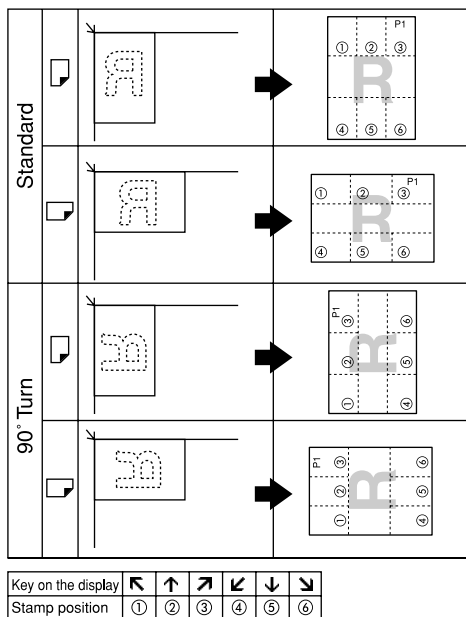

Important

You cannot use the bypass tray with this function.

1 Press [Edit / Colour].

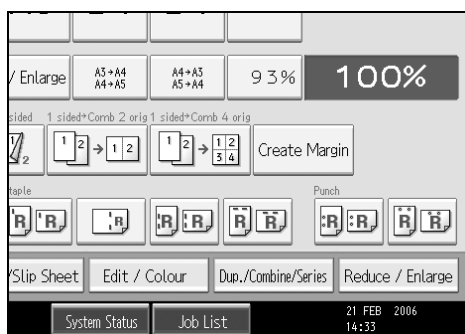

2 Press [Stamp].

3 Press [Page Numbering].

4 Select the format.

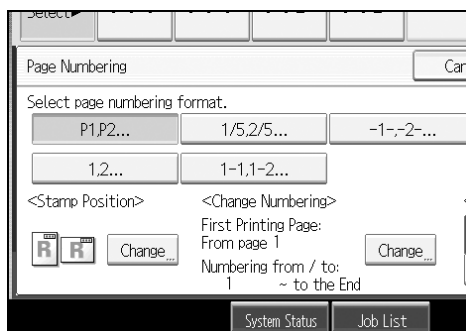

You can specify the stamp colour, position, pages to be stamped, and numbering.

5 After you specify all desired settings, press [OK].

6 Press [OK].

7 Place the originals, and then press the [Start] key.

Note

- The default colour is black.

Reference

See “Page Numbering”, General Settings Guide.

Changing the stamp colour

Changes the stamp colour.

1 Press [Stamp Colour] under Stamp Colour.

2 Select the stamp colour, and then press [OK].

Changing the stamp position

Changes the stamp position.

- 1** Press [Change] under Stamp Position.
- 2** Select the desired position, and then press [OK].

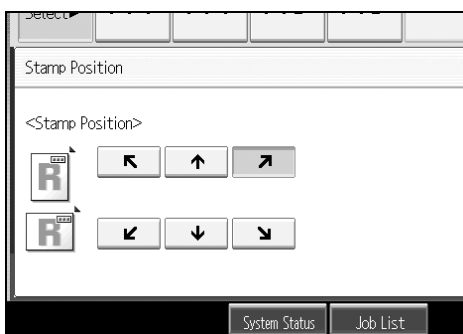

Specifying the first printing page and start number (“P1,P2...”, “-1,-2-...”, “P.1,P.2...”, “1,2...”)

Below explains the example when “P1, P2 ...” is selected. The steps are the same for other cases.

- 1** Press [Change] under Change Numbering.

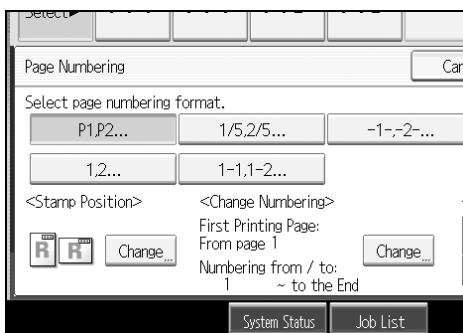

- 2** Press [First Printing Page], enter the original sheet number from which to start printing, and then press the [#] key.

- 3** Press [First Printing Number], enter the number of page from which to start numbering with the number keys, and then press the [#] key.

The example below shows when the first printing page is "2" and the start number is "3".

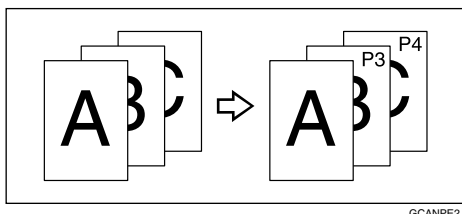

- 4** Press [Last Number], enter the number of the page at which to stop numbering with the number keys, and then press the [#] key.

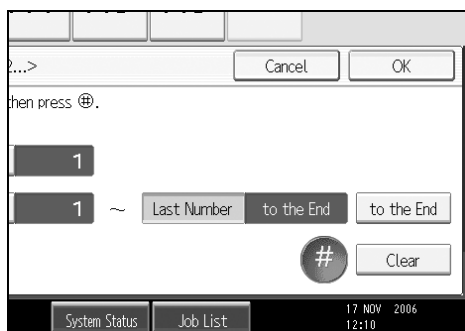

If you want to number all pages to the end, press [to the End].

- 5** When page designation is complete, press [OK].

- 6** Press [OK] twice.

 **Note**

- To change the number entered in steps **2-4**, press [Clear] or the [Clear/Stop] key, and then enter a new number.

Specifying the first printing page and start number (“1/5,2/5...”)

- 1** Press **[Change]** under Change Numbering.
- 2** Press **[First Printing Page]**, enter the original sheet number from which to start printing, and then press the **[#]** key.

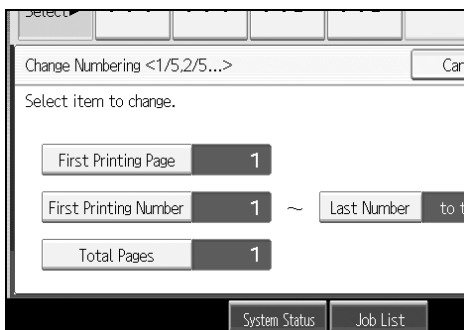

You can enter between 1 and 9999 for the original sheet number from which to start printing.

- 3** Press **[First Printing Number]**, enter the number of page from which to start numbering with the number keys, and then press the **[#]** key.
- 4** Press **[Last Number]**, enter the number of page at which to stop numbering with the number keys, and then press the **[#]** key.

Proceed to step **5** when not changing.

If you want to number all pages to the end, press **[to the End]**.

The last number is the last page number to print. For example, if Total Pages is ten, if you want to print up to seven pages and do not want to print from page 8 on, enter “7” for Last Number. Normally, you do not need to enter the number.

- 5** Press **[Total Pages]**, enter the total number of original pages with the number keys, and then press the **[#]** key.
- 6** When page designation is complete, press **[OK]**.
- 7** Press **[OK]** twice.

Note

- To change the number entered in steps **2-5**, press **[Clear]** or the **[Clear/Stop]** key, and then enter a new number.
- To change the settings (the first printing page, the number of page from which to start numbering, or total number of pages) after pressing **[OK]** in step **6**, press **[Change]** and then enter the numbers again.

Specifying the first printing page and start number (“1-1,1-2...”)

- 1** Press **[Change]** under Change Numbering.
- 2** Press **[First Printing Page]**, enter the original sheet number from which to start printing, and then press the **[#]** key.

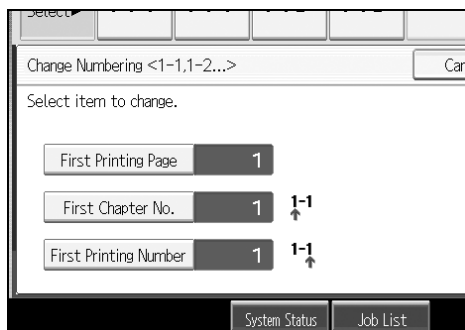

- 3** Press **[First Chapter No.]**, enter the chapter number from which to start numbering with the number keys, and then press the **[#]** key.
You can enter between 1 and 9999 for the chapter number from which to start numbering.
- 4** Press **[First Printing Number]**, enter the page number from which to start printing with the number keys, and then press the **[#]** key.
- 5** When page designation is complete, press **[OK]**.
- 6** Press **[OK]** twice.

Note

- To change the number entered in steps **2-4**, press **[Clear]** or the **[Clear/Stop]** key, and then enter a new number.

Image Repeat

The original image is copied repeatedly.

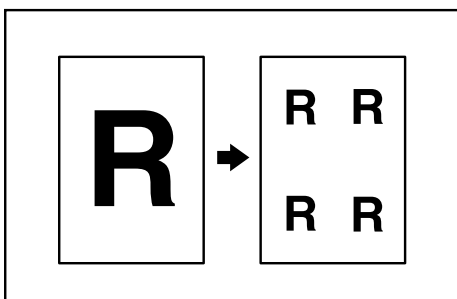

There are two ways to specify an image to be repeated.

❖ Whole Area Repeat

Repeatedly copies the entire image.

❖ Specified Area Repeat

Repeatedly copies a specified portion of the image.









🔍 Reference

See "Edit", General Settings Guide.

Whole Area Repeat

Repeatedly copies the entire image.

The number of repeated images depends on the original size, copy paper size, and reproduction ratio. For example, see the following table:

- ❖ Original: A5  / Copy paper: A4  or Original: A5  / Copy paper A4 , Original: 5 1/2" × 8 1/2"  / Copy paper: 8 1/2" × 11"  or Original: 5 1/2" × 8 1/2"  / Copy paper: 8 1/2" × 11" 

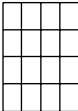
4 repeats (65%)	16 repeats (32%)
 Repeat1	 Repeat2

- ❖ Original: A5 □ / Copy paper: A4 □ or Original: A5 □ / Copy paper A4 □, Original: 5 1/2" × 8 1/2" □ / Copy paper: 8 1/2" × 11" □ or Original: 5 1/2" × 8 1/2" □ / Copy paper: 8 1/2" × 11" □

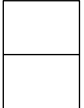
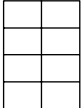
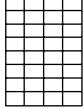
2 repeats (100%)	8 repeats (50%)	32 repeats (25%)
 Repeat3	 Repeat4	 Repeat5

- 1** Select the size of copy paper and the reproduction ratio.
- 2** Press [Edit / Colour].

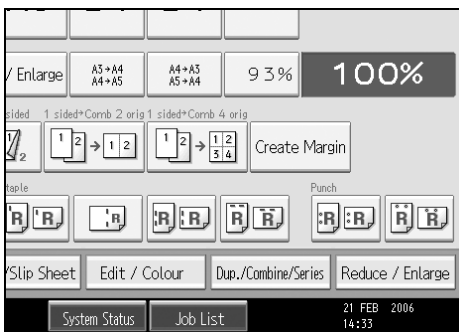

- 3** Press [Edit Image].
- 4** Press [Image Repeat].
- 5** Make sure that [Whole Area] is selected, and then press [OK].
- 6** Press [OK].
- 7** Place your original, and then press the [Start] key.

Specified Area Repeat

Repeatedly copies a specified portion of the image.

Determine the location of the area's base point and its length and width.

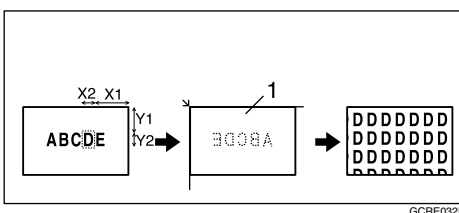

- ① Set on the exposure glass

Important

- ❑ You cannot use this function from the ADF.

- 1** Measure the location of the base point (X1, Y1) and its length and width (X2, Y2) for the area of the image repeatedly copied.

You can set any value in the range of X1: 0-412 mm (0"-16.2"), X2: 20-432 mm (0.8"-17.0"), Y1: 0-277 mm (0"-10.8"), and Y2: 20-297 mm (0.8"-11.6").

- 2** Select the size of copy paper and the reproduction ratio.

- 3** Press [Edit / Colour].

- 4** Press [Edit Image].

- 5** Press [Image Repeat].

- 6** Press [Specified Area].

- 7** Enter the length of [X1] with number keys, and then press the [#] key.

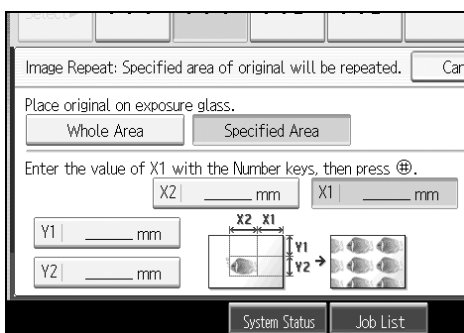

- 8** Enter the length of [Y1] with the number keys, and then press the [#] key.

- 9** Enter the length of [X2] with the number keys, and then press the [#] key.

- 10** Enter the length of [Y2] with the number keys, and then press the [#] key.

- 11** Press [OK] twice.

- 12** Place the original on the exposure glass, and then press the [Start] key.

Double Copies

One original image is copied twice on one copy as shown.

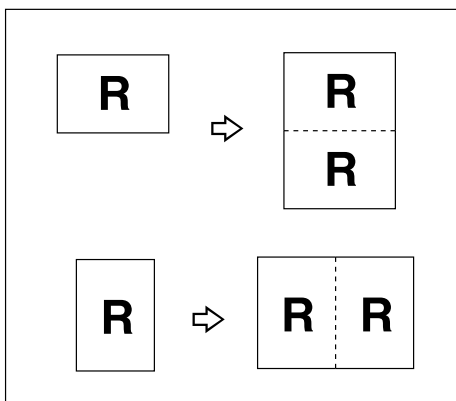

2

⚠ Important

- You cannot use the bypass tray with this function.
- See the following table for original and copy paper sizes when using a 100% ratio:

❖ Metric version

Original size and Orientation	Copy paper size and Orientation
A5	A4
A4	A3
A5	A4
B5 JIS	B4 JIS

AMG015S

❖ Inch version

Original size and Orientation	Copy paper size and Orientation
5 1/2" × 8 1/2"	8 1/2" × 11"
5 1/2" × 8 1/2"	8 1/2" × 11"
8 1/2" × 11"	11" × 17"

AMG016S

1 Press [Edit / Colour].

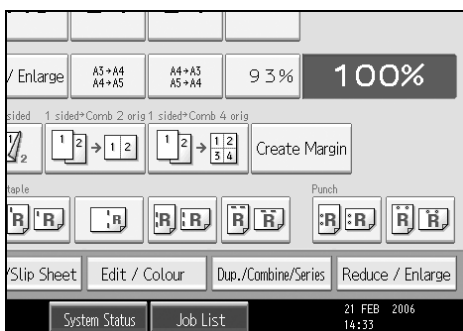

2 Press [Edit Image].

3 Press [Double Copies].

4 Press [OK].

5 Select the paper size.

6 Place your originals, and then press the [Start] key.

Reference

See "Edit", General Settings Guide.

Centring

You can make copies with the image moved to the centre of the copy paper.

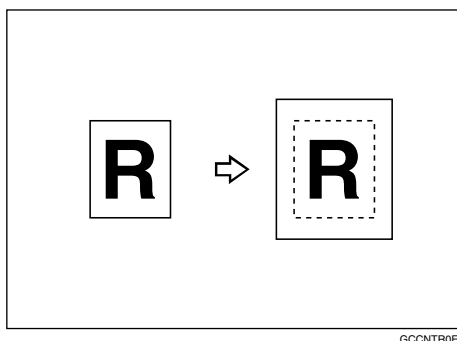

GCCNTR0E

Important

- You cannot use the bypass tray with this function.
- The paper sizes and directions for centring are listed below.

❖ Metric version

Original placed on:	Paper size and orientation
Exposure glass	A3☐, B4 JIS☐, A4☐☐, B5 JIS☐☐, 8" × 13"☐
ADF	A3☐, B4 JIS☐, A4☐☐, B5 JIS☐☐, A5☐☐, 11 × 17☐, 8 ¹ / ₂ " × 11"☐☐, 8" × 13"☐, 8K☐, 16K☐☐

❖ Inch version

Original placed on:	Paper size and orientation
Exposure glass	11" × 17"☐, 8 ¹ / ₂ " × 14"☐, 8 ¹ / ₂ " × 11"☐☐
ADF	A3☐, A4☐☐, 11" × 17"☐, 8 ¹ / ₂ " × 14"☐, 8 ¹ / ₂ " × 11"☐☐, 5 ¹ / ₂ " × 8 ¹ / ₂ "☐☐, 10" × 14"☐, 7 ¹ / ₄ " × 10 ¹ / ₂ "☐

1 Select the paper size.

2 Press [Edit / Colour].

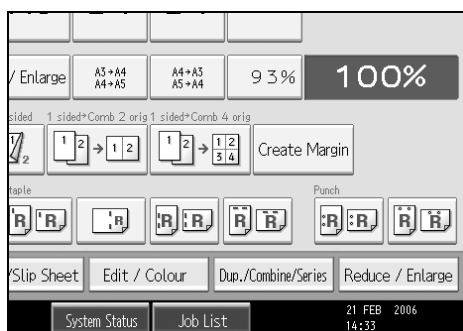

3 Press [Edit Image].

4 Press [Centring].

5 Press [OK].

6 Place your originals, and then press the [Start] key.

Positive/Negative

Copies an image inverted. If your original is black and white, copy images are inverted. If your original is colour, the density, darkness and brightness of each colour will be reversed and inverted to complimentary colours.

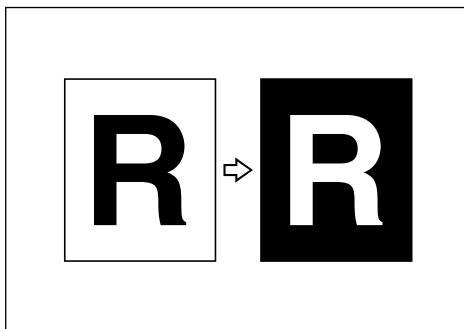

GCHATN1E

1 Press [Edit / Colour].

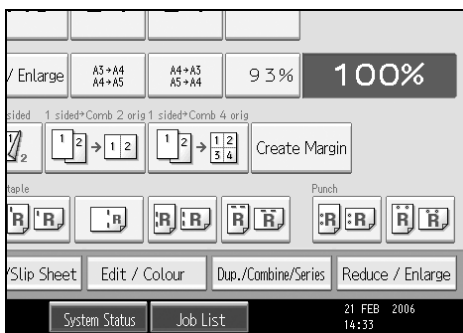

2 Press [Edit Image].

3 Press [Positive / Negative].

4 Press [OK].

5 Select the paper size.

6 Place your originals, and then press the [Start] key.

Mirror

Copies by reversing the image from left to right, as reflected in a mirror.

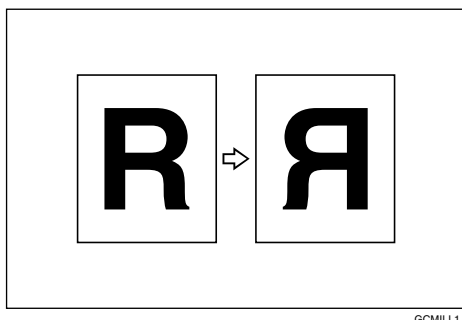

GCMILL1J

1 Press [Edit / Colour].

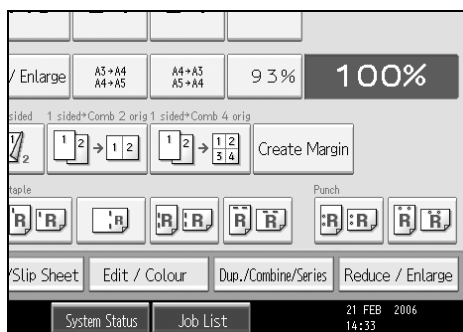

2 Press [Edit Image].

3 Press [Mirror Image].

4 Press [OK].

5 Place the originals, and then press the [Start] key.

Covers

You can use this function to create cover sheets by adding additional pages of different paper, or copying existing pages onto different paper.

❗ Important

- Before using this function, set the special paper tray for cover sheets.
- You cannot select the bypass tray for the copy paper.

The Covers function includes Front Cover and Front/Back Covers.

❖ Front Cover

The first page of your originals is copied on specific paper sheet for covers, or a cover sheet is inserted before the first copy.

- Copy

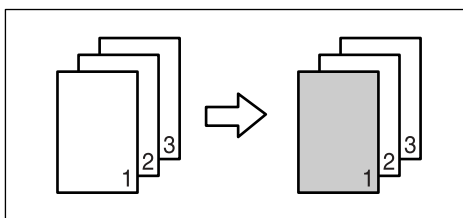

- Blank

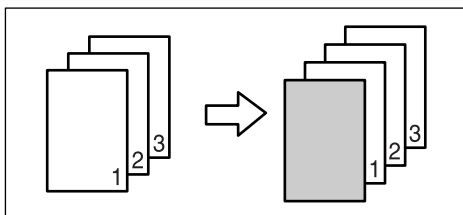

❖ Front/Back Covers

The first and last pages of your original are copied on specific paper for use as covers, or a cover sheet is inserted before the first copy and after the last copy.

- Copy

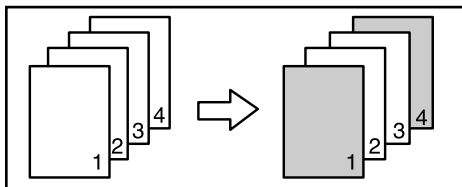

AMF085S

- Blank

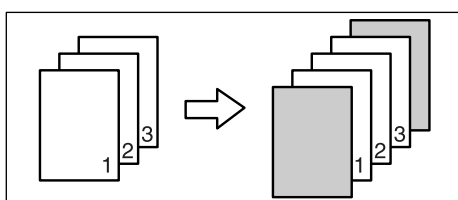

1 Set the tray for the front cover paper.

The cover sheet should be the same size and orientation as the copy paper.

2 Press [Cover/Slip Sheet].

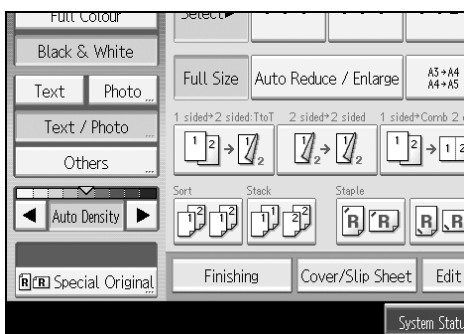

3 Select [Copy] or [Blank] for the cover sheet, and then press [OK].

4 Select the paper tray that contains the sheet paper to copy the originals.

5 Place your originals in the ADF, and then press the [Start] key.

🔍 Reference

See "Tray Paper Settings", General Settings Guide.

Designate

Use this function to have certain pages of your original copied onto slip sheets or to insert a slip sheet for each page specified.

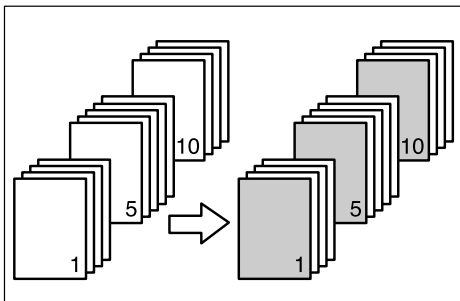

Important

- Before using this function, set the special paper tray for slip sheets.
- The slip sheets should be the same size and orientation as the copy paper.
- You cannot place the copy paper in the bypass tray.

1 Press [Cover/Slip Sheet].

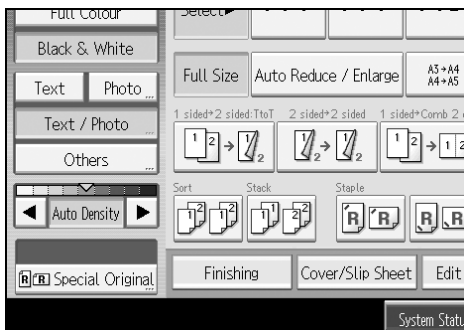

2 Press [Designate / Chapter].

3 Select [Designate: Copy] or [Designate: Blank].

4 Press the key to select the chapter number.

To select pages 11 to 20 (chapter), press [11-20].

5 Enter the page location of the first page of the chapter with the number keys, and then press the [#] key.

6 To specify another page location, repeat steps 4 to 5.

Up to 20 pages can be specified.

7 Select the paper tray that contains the sheet paper to copy the originals.

8 When you finish specifying pages, press [OK] twice.

- 9 Place your originals in the ADF, and then press the **[Start]** key.

🔍 Reference

See “Tray Paper Settings”, General Settings Guide.

Chapters

The page locations you specify with this function will appear on the front of copy sheets.

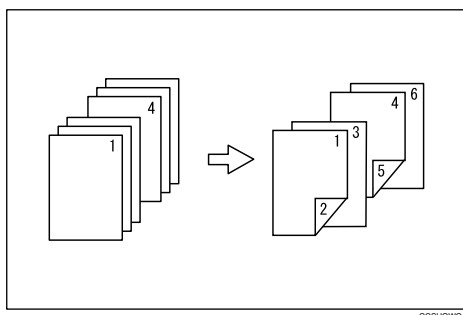

⚠ Important

- Before selecting this function, press **[Dup./Combine/Series]** and select “1 Sided → 2 Sided” or “Combine”.
- This function can be used only when you use the Duplex (1 Sided→2 Sided) or Combine function.

- 1 Press **[Cover/Slip Sheet]**.

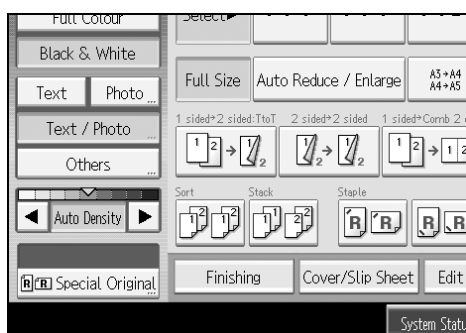

- 2 Press **[Designate / Chapter]**.

- 3 Press **[Chapter]**.

- 4 Press the key to select the chapter number.

To select chapters 11 to 20, press **[11-20]**.

- 5 Enter the page location of the first page of the chapter with the number keys, and then press the **[#]** key.

You can specify the pages up to 20.

6 To specify another page location, repeat steps **4** to **5**.

7 Select the paper.

8 When page designation is complete, [OK] twice.

9 Place the originals, and then press the [Start] key.

2

Slip Sheets

Every time an original page changes, a slip sheet is inserted. You can also print on the inserted slip sheet.

Since a slip sheet is inserted for every page, you can protect printed surfaces. This function is useful in copying OHP transparencies.

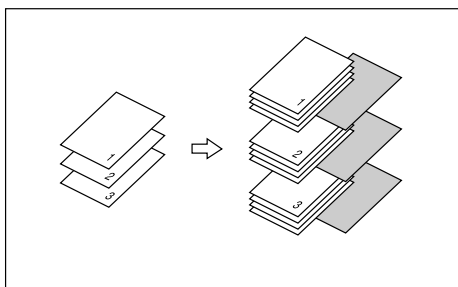

Important

- If [1 Sided → 2 Sided] is set, cancel the setting.
- Before using this function, set the special paper tray for slip sheets.
- Load the slip sheets in the same size and orientation as the copy paper or the OHP transparency.

❖ When using OHP transparencies placed in the bypass tray

- Copy

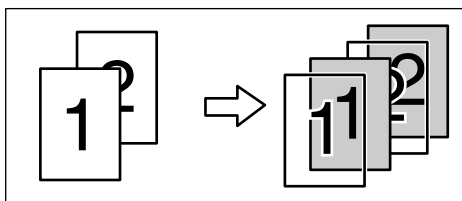

- Blank

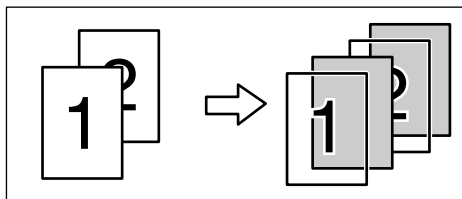

1 Press [Cover/Slip Sheet].

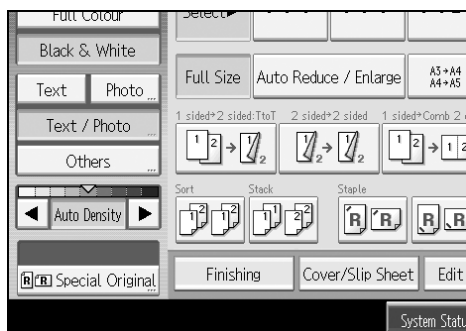

2 Select [Copy] or [Blank] for the slip sheets, and then press [OK].

3 Select the paper tray containing the sheet paper to copy the originals. When using OHP transparencies, open the bypass tray.

4 Place the originals, and then press the [Start] key.

Note

- When setting OHP transparencies on the bypass tray, press the [#] key and select [OHP (Transparency)] in Special Paper.
- When copying OHP transparencies set on the bypass tray, if Internal Tray 1 is not selected for the output paper tray, copies are delivered to it.

Reference

See "Tray Paper Settings", General Settings Guide.

See p.37 "When Copying onto OHP Transparencies or Thin Paper".

Storing Data in the Document Server

The Document Server enables you to store documents in the memory and print them as you want.

Important

- ❑ Data stored in the machine might be lost if some kind of failure occurs. The manufacturer shall not be responsible for any damage that might result from the loss of data.

1 Press [Store File].

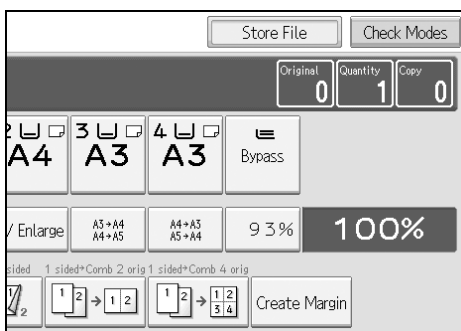

2 Enter a file name, user name, or password if necessary.



3 Press [OK].

4 Place the originals.

5 Make the scanning settings for the original.

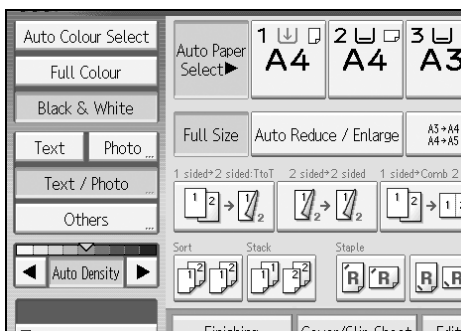

6 Press the **[Start]** key.

Stores scanned originals in memory and makes one set of copies.

Note

- To stop scanning, press the **[Clear/Stop]** key. To resume a paused scanning job, press **[Continue]** in the confirmation display. To delete scanned images and cancel the job, press **[Stop]**. The originals placed in the ADF are delivered.
- When placing an original on the exposure glass, press the **[#]** key after all the originals have been scanned.
- Data stored in the Document Server is set to be deleted after three days by the factory default. You can specify the period after which the stored data is deleted automatically. For details about changing settings, see “Administrator Tools”, General Settings Guide.
- To check if the document has been stored, press the **[Document Server]** key.
- If you want to store another document, do so after copying is complete.
- For details about the Document Server, see “Document Server”.
- For details about printing stored documents, see “Printing a Stored Document”.
- For details about setting user name, file name, and password, see “Storing Data”.
- Depending on the security setting, **[Access Privileges]** may appear instead of **[User Name]**. For details about specifying **[Access Privileges]**, consult the administrator.

Reference

See p.147 “Document Server”.

See p.152 “Using the Document Server”.

See p.162 “Printing a Stored Document”.

See p.152 “Storing Data”.

Programs

You can store the frequently used copy job settings in the machine memory and recall them for future use.

You can store up to 10 programs.

Note

- When a specified program is registered as the default, its values become the default settings, which are displayed without pressing the **[Program]** key, when modes are cleared or reset, and after the operation switch is turned on. See “Programming Defaults in Initial Display”.
- Paper settings are stored based on paper size. So if you place more than one paper tray of the same size, the paper tray prioritized with User Tools (System Settings) will be selected first. See “Tray Paper Settings”, General Settings Guide.
- Programs are not deleted by turning the power off or by pressing the **[Clear Modes]** key.

Reference

See p.146 “Programming Defaults in Initial Display”.

See “Tray Paper Settings”, General Settings Guide.

Storing a Program

Stores a program.

- 1** Edit the copy settings so all functions you want to store in this program are selected.
- 2** Press the [Program] key.

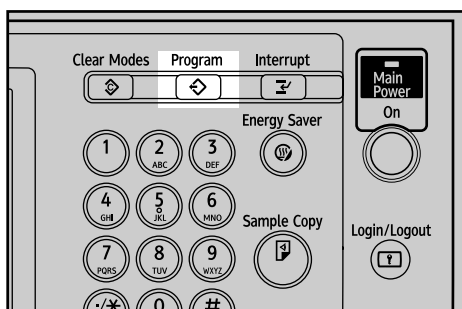

AQI060S

- 3** Press [Program].

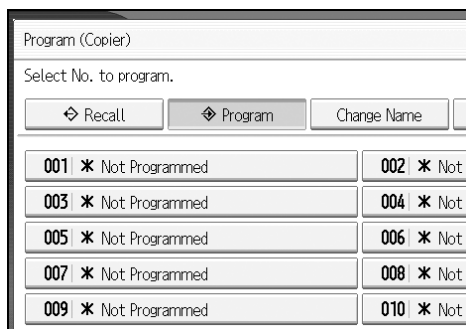

- 4** Press the program number you want to store.
- 5** Enter the program name with the letter keys on the display panel.
You can enter up to 34 characters.

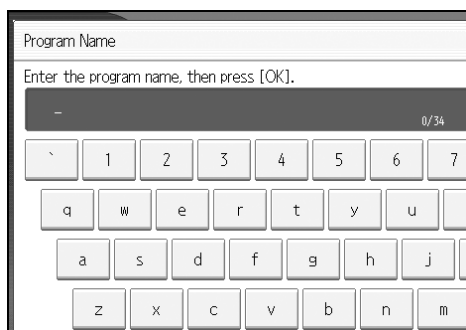

6 Press [OK].

The screen returns to the program screen, showing the program number followed by the program name. The screen returns to the initial copy display after a short time.

 **Note**

- Program numbers with ⇨ against them already have settings made for them.

Changing a Stored Program

Changes program settings.

1 Check the program settings.**2** Set the contents of a program.**3** Press the [Program] key.**4** Press [Program].**5** Press the program number you want to change.**6** Press [Yes].**7** Enter the program name.

You can enter up to 34 characters.

8 Press [OK].

The screen returns to the program screen, showing the program number followed by the program name. The screen returns to the initial copy display after a short time.

 **Note**

- When you want to check the contents of a program, recall the program.
- When it is overwritten, the previous program is deleted.

 **Reference**

See p.145 "Recalling a Program".

Deleting a Program

Erases the contents of program.

1 Press the [Program] key.

2 Press [Delete].

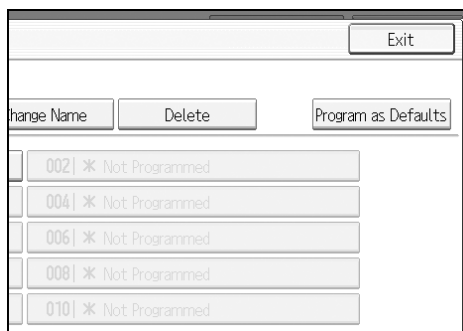

3 Press the program number you want to delete.

4 Press [Yes].

The program is deleted, and the display returns to the initial copy display.

Recalling a Program

Recalls a stored program to make copies using the stored settings.

1 Press the [Program] key.

2 Press [Recall].

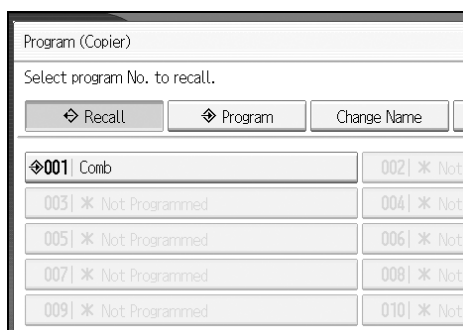

3 Press the program number you want to recall.

The stored settings are displayed.

4 Place the originals, and then press the [Start] key.

Note

- Only programs with ◆ against them contain a program in step **3**.

Programming Defaults in Initial Display

This section describes how to program defaults for the initial display when modes are cleared or reset, or immediately after the operation switch is turned on.

The default settings you can program are Colour Mode, Paper Tray, Original Type, Density, Special Original, Original Orientation, Cover/Slip Sheet, Edit / Colour, Dup./Combine/Series, Reduce / Enlarge, and Finishing.

- 1** Specify scan settings and any other settings you require in the initial display.
- 2** Press the **[Program]** key.
- 3** Press **[Program as Defaults]**.
- 4** Press **[Program]**.
- 5** When a confirmation dialog appears, press **[Yes]**.

The current settings are programmed as defaults. The screen returns to the initial display.

 **Note**

- To restore the factory default settings on the initial display, press **[Restore Factory Defaults]**.
- The default settings can be programmed separately for the normal screen and simplified display screens.

3. Document Server

Using the Document Server enables you to store documents being read with the copy feature on the hard disk of this machine. Thus you can print them later applying necessary conditions.

Relationship between Document Server and Other Functions

State of the Document Server varies depending on the function used.

❖ Copier Functions

- Storing method: Copy/Document Server
- List display: Available
- Printing: Available
- Transmission: Unavailable

❖ Printer Functions

- Storing method: Personal computer
- List display: Available
- Printing: Available
- Transmission: Unavailable

❖ Fax Functions

- Storing method: Fax
- List display: Available
- Printing: Available
- Transmission: Available
Transmission is done by use of the stored document transmission of the fax feature.

❖ Scanner Functions

- Storing method: Scanner
- List display: Unavailable
When documents are stored with the scanner feature, you can confirm them from the scanner feature screen.
- Printing: Unavailable
- Transmission: Available
Transmission is done by use of the stored document transmission of the scanner feature.

Reference

See "Sending Stored Documents", Facsimile Reference.

See "Displaying the List of Stored Files", Scanner Reference.

See "Sending a Stored File", Scanner Reference.

Document Server Display

Following explains the screens and icons displayed in the Document Server function.

❖ Document Server initial display

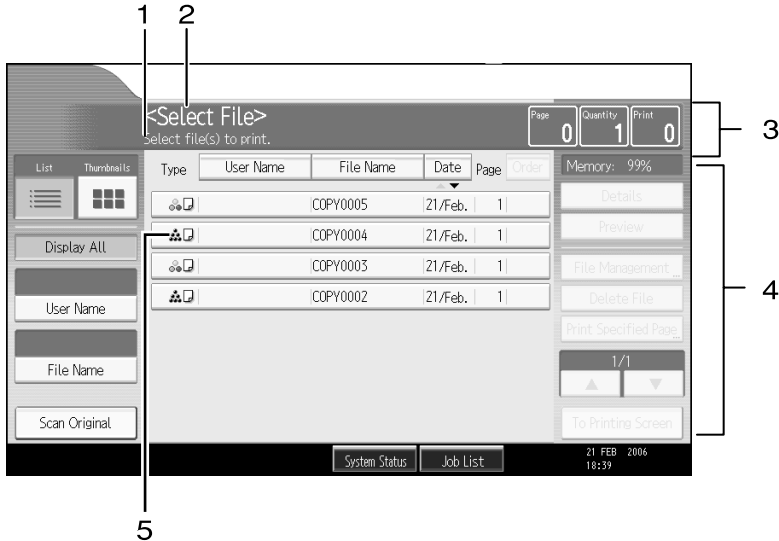

AQI064S

1. The operational status or message is displayed.





2. The currently selected screen's title is displayed.

3. The number of the originals being read with the memory as well as the number of paper set and copied are displayed.

4. Keys for the operation are displayed.

5. An icon that corresponds to the storing function and the colour mode selected is displayed.

The list display of the Document Server shows the following icons depending on the storing function and the colour mode selected:

Function	Copying	Facsimile	Printer
Icons			
Colour icons	Full colour	Black and white	
			

 **Note**

- All the stored documents may not be displayed depending on the security function specified.

Simplified Display

This section explains how to use the “Simplified Display” and introduces its keys.

You can view the simplified display from the Document Server's initial screen by pressing the **[Simplified Display]** key.

The simplified display contains main functions only.

Characters and keys are enlarged on this screen, making for easier operation.

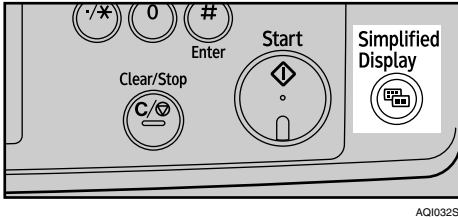

❖ Simplified Document Server Screen

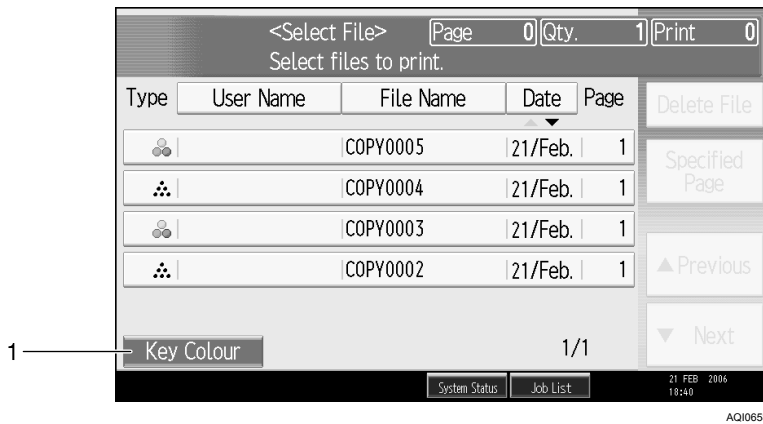

1. [Key Colour]

Use this to intensify the screen contrast by changing the colour of the keys.

Not available on the Document Server default display.

Note

- Press the **[Simplified Display]** key again to return to the Document Server default screen.
- The simplified display screen does not contain every available key.

Preview Display

Following explains the preview display displaying procedure and the items displayed on this screen.

The Preview Display appears after scanning completes. You can also display stored documents on the preview display. For details, see “Displaying the List of Stored Files”, Scanner Reference.

The preview display denotes the screen that allows confirming contents of the scanned documents.

❖ Preview Display

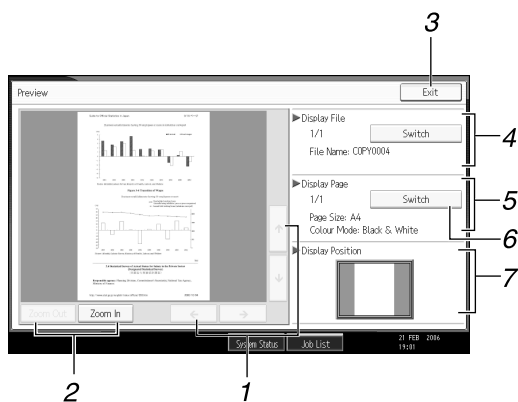

AQI066S

1. [←][→][↑][↓]

Used to move the portion to be displayed.

2. [Zoom Out], [Zoom In]

Used to scale up or down the document to be displayed.

3. [Exit]

Used to exit the preview display.

4. Display File

Used to display the document name.

[Switch] is displayed on the preview screen for the stored documents. It is used to switch the document to be displayed in the preview.

5. Display Page

Used to display the currently opened page number, total number of pages, page size and the colour mode selected.

6. [Switch]

Used to turn the page of the selected document.

7. Display Position

When the image is enlarged, the position on the document is displayed.

Note

- When the preview is already selected from another function, the preview screen function may become unusable.
- The preview display is also not available when the paper size is larger than A3.

Reference

See “Displaying the List of Stored Files”, Scanner Reference.

Using the Document Server

Following describes how to use the Document Server.

Storing Data

Following describes the procedure for storing documents on the Document Server.

Important

- Data stored in the machine might be lost if some kind of failure occurs. The manufacturer shall not be responsible for any damage resulting from loss of data.
- When entering your password or recording it to your notebook or like, be sure to protect it from being seen by others. Care must also be exercised for safe keeping of its recording paper.
- Enter the password in the range of four and eight digits.
- It is advisable not to use the same number such as "0000" or continuous numbers such as "1234" for your password. These numbers are imagine fully and they do not provide sufficient security.
- When you have selected a document using a correct password, it remains being selected after the operation is finished. As is, therefore, the document is left operable to those who don't know the password. After the operation, be sure to press the **[Clear Modes]** key to cancel the selected state of the document.
- User names registered to the stored documents of the Document Server are used for identifying the documents' authors and the nature of the documents. They don't function as a protective means of confidential documents.
- When turning on the fax transmission or scanning by the scanner, make sure that all other operations are ended.

❖ File Name

A document name such as "COPY0001" and "COPY0002" is automatically attached to the scanned document. You can change the document name.

❖ User Name

You can specify the user name so that the person or department that has stored the document can be identified. Two approaches are available in specifying the user name. One is specifying the name being registered from the Address Book Management and the other is entering another name.

❖ Password

You can specify a password for a document to be stored. When a password is set for a document, you are to enter that password for printing the document. Above arrangement prevents unauthorized printing of the document. A key mark will be attached to the document for which a password has been set.

- 1 Press the [Document Server] key.

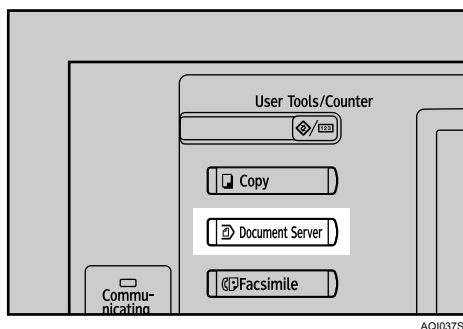

- 2 Press [Scan Original].

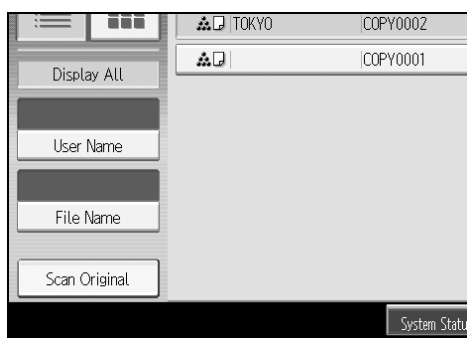

- 3 Above operation sets up the user name, document name and password.
When not changing a document name, the name will be automatically set.

- 4 Set the original.

- 5 Specify the original scanning conditions.

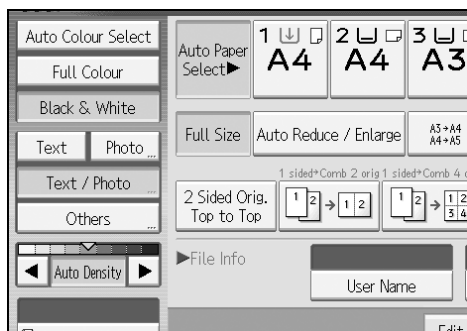

- 6 Press the [Start] key.

The original is scanned. The document is saved in the Document Server.

Note

- When interrupting the scan, press the **[Clear/Stop]** key. Pressing **[Continue]** from the confirmation screen resumes the scan. Pressing **[Stop]** deletes the scanned images and the original on the automatic document feeder (ADF) will be ejected.
- As a password is set, the key mark will be displayed on the left side of the document.
- As scan of the document is completed, a list will be displayed. If the list does not appear, press **[Scanning Complete]**.
- According to the factory default, the documents stored on the Document Server are deleted three days (72 hours) after the storing date. You can cancel the automatic document deletion or select other period than three days for the automatic deletion. See “Administrator Tools”, General Settings Guide.
- When storing a document, which is not to be automatically deleted, in the Document Server, specify **[Off]** for “Auto Delete File in Document Server” before storing the document. If you specify **[On]** for “Auto Delete File in Document Server” after that, Auto Delete File in Document Server will be enabled for the documents being stored after the setting.
- When storing a document in the Document Server after storing it from the copy feature, be sure that its copy is completed.

Reference

See “Administrator Tools”, General Settings Guide.

To register or change a user name (When using a user name registered to the Address Book)

Following describes the procedure for registering or changing a user name to be attached to a stored document.

1 Press **[Scan Original]**.

2 Press **[User Name]**.

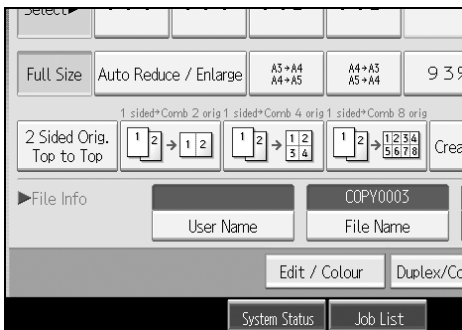

The user name input screen will appear.

3 Select the user name and then press **[OK]**.

To register or change a user name (When using a user name not registered to the Address Book)

Following describes the procedure for registering or changing a user name to be attached to a stored document.

- 1** Press [Scan Original].
- 2** Press [User Name].
- 3** Select the user name and then press [Manual Entry].

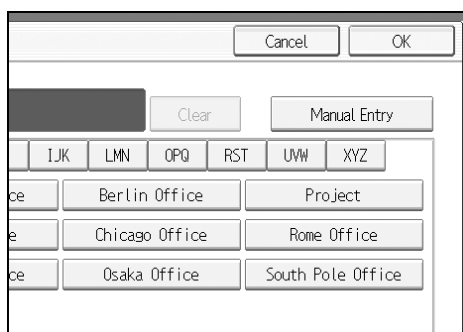

The user name change screen will appear.

- 4** Enter the user name and then press [OK] twice.

To register or change a user name (When no name is registered to the Address Book)

Following describes the procedure for registering or changing a user name to be attached to a stored document.

- 1** Press [Scan Original].
- 2** Press [User Name].

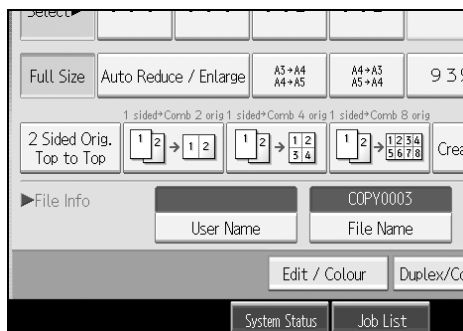

The user name input screen will appear.

- 3** Press [Manual Entry].
- 4** Enter the user name and then press [OK].

To change a file name

Following describes the procedure for changing a name to be attached to a stored document.

1 Press **[Scan Original]**.

2 Press **[File Name]**.

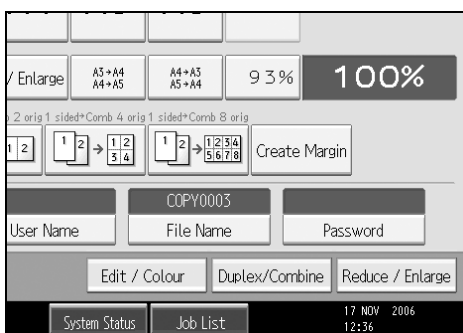

The document name change screen will appear.

3 Press **[Delete All]** to delete the document name to be automatically set.

4 Enter document name and then press **[OK]**.

Note

- In Step **3**, pressing **[Backspace]** allows you to delete up to any desired location.
- You can enter up to 20 characters for a document name. In the list, however, up to 16 characters are displayed as the document name. If above limits are exceeded, the list will display up to 15 characters for the document name.

To set or change a password

Following describes the procedure for setting or changing a password to be attached to a stored document.

1 Press [Scan Original].

2 Press [Password].

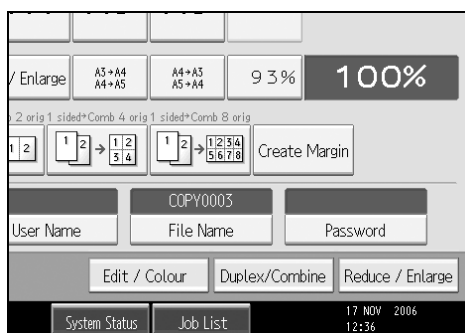

3 Enter the password from the number keys and then press [OK].

You can use four to eight digits for specifying the password.

4 For double-check, enter the password again and then press [OK].

Changing User Name, File Name or Password of a Stored Document

Following describes the procedure for changing a user name, document name or password.

1 Press the [Document Server] key.

2 Select the document whose user name, document name or password is to be changed.

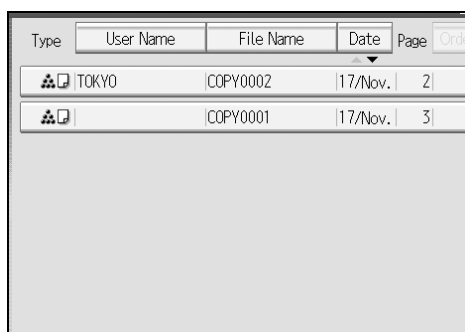

When a password is set, enter it and then press [OK].

3 Press [File Management].

4 Press **[Change User Name]**, **[Change File Name]** or **[Change Password]**.

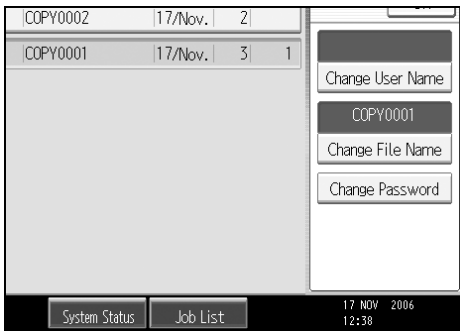

5 From the respective change screens, enter the new user name, document name or password and then press **[OK]**.

6 Press **[OK]**.

Note

- Depending on the security setting, **[Access Privileges]** may appear instead of **[User Name]**. For details about specifying **[Access Privileges]**, consult the administrator.

Checking the Details of a Stored Document

Following describes the procedure for displaying details of a stored document.

1 Press the **[Document Server]** key.

2 Select the document whose details are to be displayed.

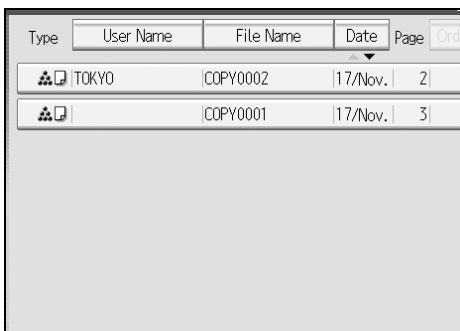

When a password is set, enter it and then press **[OK]**.

3 Press [Details].

Details of the document will be displayed.

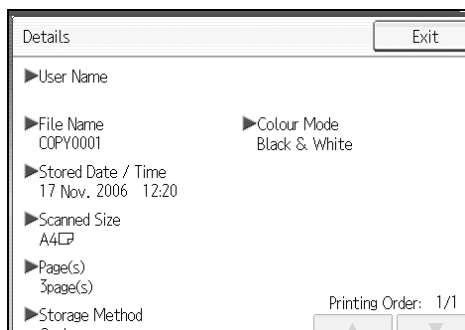

Note

- If you have selected multiple documents, press [▲] or [▼] to view their information.
- Pressing [Exit] restores the document selection screen.

Searching for a Stored Document

Following describes the procedure for searching a stored document from user name or document name.

You can rearrange the currently chronologically ordered documents in any desired order.

❖ To search by file name

Searches for stored documents by file name.

❖ To search by user name

Searches for stored documents by user name.

Note

- Installing DeskTopBinder Lite enables search and reordering of stored documents from PC.

Reference

For details about DeskTopBinder Lite, see Instruction Manual and Help of DeskTopBinder Lite.

To search by file name

Following describes the procedure for searching a stored document from the document name.

1 Press the [Document Server] key.

2 Press [File Name].



3 Enter the document name to be searched and then press [OK].

A document name that matches completely from the starting character will be searched and displayed on the document selection screen.

Note

- Pressing [Display All] displays ever stored document.

To search by user name

Following describes the procedure for searching a stored document from the user name.

1 Press the [Document Server] key.

2 Press [User Name].

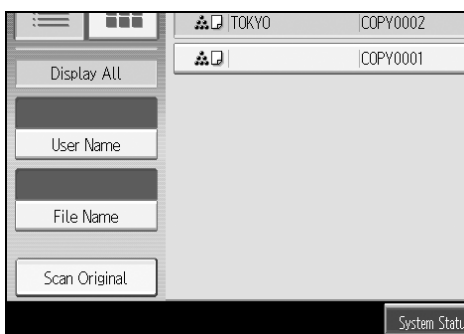

3 When specifying a registered user name, select the user name.

When using a not-registered user name, proceed to the next step.

- 4** When the user name is not registered, press **[Manual Entry]** and then enter the user name from the input screen to be displayed. Then press **[OK]**.

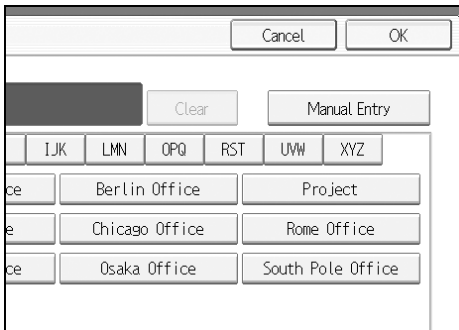

- 5** Press **[OK]**.

A document name that matches completely from the starting character will be searched and displayed on the document selection screen.

 **Note**

- Pressing **[Display All]** displays ever stored document.

Printing a Stored Document

Following describes the procedure for printing a stored document.

Using Web Image Monitor allows you to print a document stored in the Document Server from your PC.

1 Press the **[Document Server]** key.

2 Select the document to be printed.

When a password is set, enter it and then press **[OK]**.

3 When printing two or more documents at a time, repeat the operation in step **2**.

Up to 30 documents can be printed.

4 When specifying printing conditions, press **[To Printing Screen]**.

The printing condition screen will appear. User name of the document, document name and the order of printing of this document will be displayed.

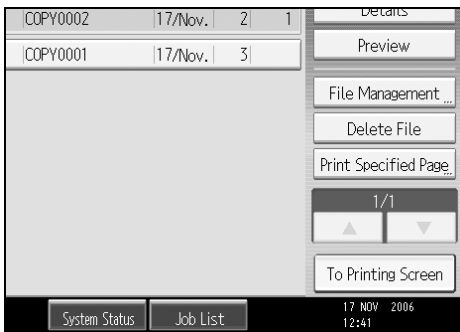

5 Enter the number of print copies from the number keys.

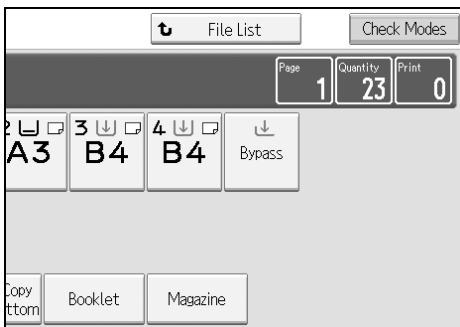

Up to 999 copies are specifiable.

6 Press the **[Start]** key.

Printing will be started.

Note

- You can search the target document using, in step **2**, **[User Name]** or **[File Name]** situated in the left side of the screen.
- Some of the selected documents may not be printed due to the difference in the size or resolution.
- When changing the printing order, cancel the highlight and then specify the order correctly.
- Pressing the **[Clear Modes]** key cancels every selection.
- Pressing **[Order]** displays the selected documents in the printing order.
- The copy and printer features hold the specified printing conditions after the operation is over and apply them at the next printing. The fax feature does not have the function of storing the printing conditions.
- When two or more documents are specified, the printing conditions are stored on the first document but not on the succeeding documents.
- Following settings are available for the printing conditions. For respective printing results, see "Copier Functions".
 - Book binding style (2 Sided Top to Top, 2 Sided Top to Bottom, Magazine, Booklet)
 - Treatment of front cover (Cover/Slip Sheet, Edit / Stamp)
 - Finish (Sort, Rotate Sort, Stack, Staple, Punch)
- When printing two or more copies while selecting the sort function, you can confirm the finish by printing only one copy.
- When printing two or more documents at a time, you can print them as a single continuous document by specifying the order of their printing.
- When printing two or more documents at a time, the printing conditions set for the first document are applied to all the remaining documents.
- When two or more documents are selected, pressing **[▲][▼]** allows you to confirm the user name, document name and printing order of the document selected in step **2**.
- Pressing **[Select File]** restores the document selection screen.
- The Stamp function is not specifiable to the documents being stored from the fax feature.

Reference

See p.57 "Copier Functions"

When interrupting printing

Following describes the procedure for interrupting printing work.

1 Press the **[Clear/Stop]** key.

2 Press **[Stop]**.

Changing number of print copies while printing is in progress

Following describes the procedure for changing the number of print copies after printing is started.

Important

- This feature is enabled when the sort function is selected in the printing conditions.

1 Press the [Clear/Stop] key.

2 Press [Change Quantity].

3 Enter the number of print copies anew from the number keys.

4 Press the [#] key.

5 Press [Continue].

Printing will be resumed.

Note

- The range of print copies enterable in step **3** depends on the timing of your pressing the [Clear/Stop] key.

Sample Print

When print copies are massive, you can print a single copy in advance to check appropriateness of the printing order of the selected documents and the printing conditions.

Important

- This feature is enabled when the sort function is selected in the printing conditions.

1 Select the document to be printed.

Type	User Name	File Name	Date	Page	Print
<input type="checkbox"/>	TOKYO	COPY0002	17/Nov.	2	
<input type="checkbox"/>		COPY0001	17/Nov.	3	

When a password is set, enter it and then press [OK].

2 Press the [Sample Copy] key.

Only one copy will be printed.

3 Press [Continue].

Printing will be resumed.

Note

- You can search the target document using, in step **1**, **[User Name]** or **[File Name]** situated in the left side of the screen.
- In the display order field of step **1**, you can sort the documents by **[User Name]**, **[File Name]**, or **[Date]**. Press the item to be used for the sorting.
- When canceling the selection in step **1**, press the highlighted document again.
- When canceling the printing, press **[Suspend]**. The print screen will appear, enabling to set another item.

Printing the first page

In order to confirm the print results, you can print the first page alone of the document selected from the document selection screen.

When two or more documents are selected, the first page of the respective documents is printed.

1 Select the document to be printed (confirmed).

When a password is set, enter it and then press **[OK]**.

2 Press [Print Specified Page].**3 Press [1st Page].****4 Press the [Start] key.****Note**

- You can search the target document using, in step **1**, **[User Name]** or **[File Name]** situated in the left side of the screen.
- In the display order field of step **1**, you can sort the documents by **[User Name]**, **[File Name]**, or **[Date]**. Press the item to be used for the sorting.
- When canceling the selection in step **1**, press the highlighted document again.

Printing a specified page

You can print the specified page alone of the document selected from the document selection screen.

When two or more documents are selected, the specified page of the respective documents is printed.

1 Select the document to be printed.

When a password is set, enter it and then press **[OK]**.

2 Press **[Print Specified Page]**.

3 Press **[Specified Page]**.

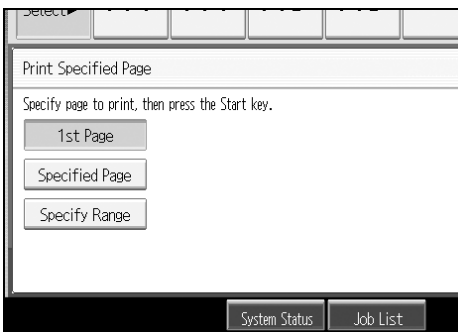

4 Specify the page to be printed from the number keys and then press the **[#]** key.

5 Press the **[Start]** key.

Note

- You can search the target document using, in step **1**, **[User Name]** or **[File Name]** situated in the left side of the screen.
- In the display order field of step **1**, you can sort the documents by **[User Name]**, **[File Name]**, or **[Date]**. Press the item to be used for the sorting.
- When canceling the selection in step **1**, press the highlighted document again.

Printing a specified range

You can print the pages in the specified range alone of the document selected from the document selection screen.

When two or more documents are selected, pages in the specified range of the respective documents are printed.

1 Select the document to be printed.

When a password is set, enter it and then press [OK].

2 Press [Print Specified Page].

3 Press [Specify Range].

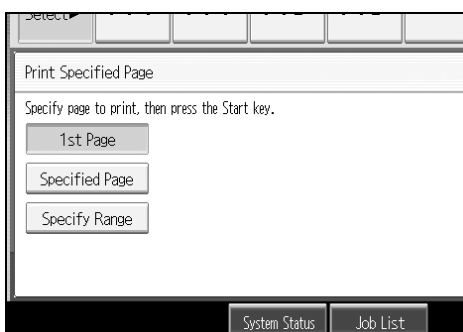

4 Specify the printing start page from the number keys and then press the [#] key.

5 Specify the printing end page from the number keys and then press the [#] key.

6 Press the [Start] key.

Note

- You can search the target document using, in step 1, [User Name] or [File Name] situated in the left side of the screen.
- In the display order field of step 1, you can sort the documents by [User Name], [File Name], or [Date]. Press the item to be used for the sorting.
- When canceling the selection in step 1, press the highlighted document again.

Deleting a Document

Following describes the procedure for deleting a stored document.

Important

- The Document Server can store up to 1000 documents. As the number of stored documents reaches 1000, storing of a new document becomes unavailable. Thus, you should delete unnecessary documents as much as practicable.

1 Press the **[Document Server]** key.

2 Select the document to be deleted.

When a password is set, enter it and then press **[OK]**.

3 Press **[Delete File]**.

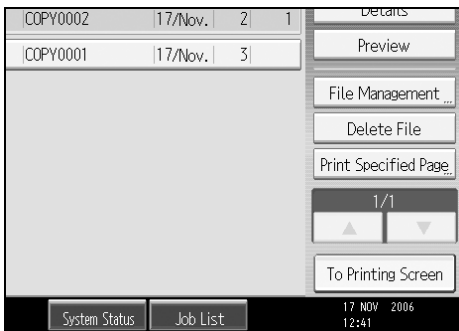

4 Press **[Yes]**.

Note

- You can delete the stored documents at a time. See “Administrator Tools”, General Settings Guide.
- Using Web Image Monitor allows you to print a document stored in the Document Server from your PC.
- It is also possible to select two or more documents and delete them.
- You can search the target document using, **[File Name]** or **[User Name]** situated in the left side of the screen.
- In the display order field, you can sort the documents by **[User Name]**, **[File Name]**, or **[Date]**. Press the item to be used for the sorting.
- When you could not identify the target document from the document name, print the first page alone of the document in order to confirm the print results.
- When canceling your selection, press the highlighted document again.

Reference

See “Administrator Tools”, General Settings Guide.

For the Web Image Monitor starting procedure, see p.169 “Displaying a Document in Document Server with Web Image Monitor”.

Displaying a Document in Document Server with Web Image Monitor

Following describes the procedure for confirming contents of a stored document on the PC screen by use of Web Image Monitor.

1 Start a Web browser.

2 Enter “http:// (IPv4 address of this machine) /” to the address.

Top page of Web Image Monitor will be displayed.

3 Click [Document Server].



The list of documents in the Document Server will be displayed.

4 Click  of the document you want to confirm.

Information of the document will be displayed.

5 Confirm contents of the document.

 **Note**

- You can change the document list display format in step **3**. Click the  (Thumbnails),  (Icons), or  (Details).
- When you want to enlarge the preview display in step **5**, click [Enlarge Image].

Downloading Stored Documents

Following describes the procedure for downloading a stored document to the PC by use of Web Image Monitor.

Important

- When downloading a document stored with the copy feature, you must prepare the extended data conversion board.

1 Start a Web browser.

2 Enter “http://(IPv4 address of this machine)/” to the address.

Top page of Web Image Monitor will be displayed.

3 Click [Document Server].

The list of documents in the Document Server will be displayed.



4 Click  of the document you want to download.

5 Select [PDF] or [Multi-page TIFF] for the file format.

The data will be downloaded.

6 Click [OK].

Note

- You can change the document list display format in step **3**. Click the  (Thumbnails),  (Icons), or  (Details).
- In step **5**, you cannot select [Multi-page TIFF] for a document being stored with the copy or printer.
- When downloading a document with [Multi-page TIFF] in step **5**, you must prepare a Printer/Scanner Unit and File Format Converter.

4. Appendix

Following describes the copy machine's specifications and the function compatibility.

Function Compatibility

The combination chart given below shows which modes can be used together.

Blank space: These modes can be used together.

×: These modes cannot be used together. The first mode selected will be the mode you are working in.

•: These modes cannot be used together. The second mode selected will be the mode you are working in.

The following shows the combinations of functions:

Functions	Functions selected later																											
	Mixed Sizes	Custom Size Originals	Original Orientation (Standard)	Original Orientation (90 degree Turn)	Image Density	Manual Image Density	Full Colour	Black & White	Auto Colour Select	Auto Paper Select	Manual Paper Select	Bypass Tray	Auto Reduce/Enlarge	Reduce/Enlarge	Create Margin	Original: 1 Sided	Original: 2 Sided	Original: Book	1 Sided	Duplex	Combine	2 Sided Combine	Front&Back → 2 Sided	Booklet	Magazine	Original: Top to Bottom	Top to Bottom	
Mixed Sizes		×																										
Custom Size Originals	×																											
Original Orientation (Standard)				•							×																	
Original Orientation (90 degree Turn)			•																×									
Image Density																												
Manual Image Density																												
Full Colour																												
Black & White																												
Auto Colour Select																												
Auto Paper Select		•																										
Manual Paper Select																												
Bypass Tray																												
Auto Reduce/Enlarge																												
Reduce/Enlarge																												
Create Margin																												
Original: 1 Sided																												
Original: 2 Sided																												
Original: Book																												
1 Sided				×																								
Duplex																												
Combine																												
2 Sided Combine																												
Front&Back → 2 Sided																												
Booklet																												
Magazine																												
Original: Top to Bottom																												
Top to Bottom																												
Double Copies																												
Image Repeat																												
Specified Area Repeat																												
Margin Adjustment																												
Positive/Negative																												
Centring																												
Centre Erase																												
Border Erase																												
Mirror																												
Erase Colour																												
Convert Colours																												
Colour Background																												
Background Numbering																												
Preset Stamp																												
User Stamp																												
Date Stamp																												
Page Numbering																												
Front cover																												
Front/Back Covers																												
Designate																												
Slip Sheets																												
Sort																												
Rotate Sort																												
Stack																												
Staple																												
Staple Top																												
Staple Left																												
Staple Centre																												
Punch																												
Storing Originals in the Document Server																												

AQ1015S

Functions	Functions selected later																													
	Double Copies	Image Repeat	Specified Area Repeat	Margin Adjustment	Positive/Negative	Centring	Centre Erase	Border Erase	Mirror	Erase Colour	Convert Colours	Colour Background	Background Numbering	Preset Stamp	User Stamp	Date Stamp	Page Numbering	Front cover	Front/Back Covers	Designate	Slip Sheets	Sort	Rotate Sort	Stack	Staple	Staple Top	Staple Left	Staple Centre	Punch	Storing Originals in the Document Server
Mixed Sizes																														
Custom Size Originals																														
Original Orientation (Standard)																														
Original Orientation (90 degree Turn)																														
Image Density																														
Manual Image Density																														
Full Colour																														
Black & White																														
Auto Colour Select		x	x																											
Auto Paper Select			●	●																		●	●	●	●					
Manual Paper Select																														
Bypass Tray		x					x								x	x	x	x	x	x				x		x	x	x	x	x
Auto Reduce/Enlarge			●	●																										
Reduce/Enlarge																														
Create Margin				x			x				x																			
Original: 1 Sided																														
Original: 2 Sided																														
Original: Book				x																										
1 Sided																														
Duplex																														
Combine		x	x	x																										
2 Sided Combine		x	x	x																										
Front&Back → 2 Sided																														
Booklet		x	x	x																										
Magazine		x	x	x																										
Original: Top to Bottom																														
Top to Bottom																														
Double Copies		●	●																											
Image Repeat		●	●																											
Specified Area Repeat		●	●																											
Margin Adjustment				x	x	x	x	x																						
Positive/Negative					x																									
Centring						x																								
Centre Erase							x																							
Border Erase								x																						
Mirror						x			x																					
Erase Colour																														
Convert Colours																														
Colour Background																														
Background Numbering																														
Preset Stamp																														
User Stamp																														
Date Stamp																														
Page Numbering																														
Front cover		x	x	x																										
Front/Back Covers		x	x	x																										
Designate																														
Slip Sheets		x	x	x																										
Sort																														
Rotate Sort																														
Stack																														
Staple																														
Staple Top																														
Staple Left																														
Staple Centre																														
Punch																														
Storing Originals in the Document Server		x	x	x																										

AQI016S

- *1 When "2 Sided → 1 Sided" is specified, the combination with the front cover or slip sheet (Designate) is ×.
- *2 Combination of "Staple: Top 1" and "Punch: Left" is ×.
 Combination of "Staple: Left 2" and "Punch: Top" is ×.
 Combination of "Staple: Centre" and "Punch: Left"/"Punch:Top" is ×.

Supplementary Information

Following describes the detailed specifications of the respective functions.

❖ Mixed Size mode

- Since small originals may not be correctly aligned with the original guide, the copy image may be slanted.
- You can place originals of two different sizes at a time.
- Copying speed and scanning speed will be reduced.

❖ Bypass Tray Copy

- The following paper sizes can be selected as the standard sizes:
A3, A4, A5, A6, B4 JIS, B5 JIS, B6 JIS, 12" × 18", 11" × 17", 8¹/₂" × 14", 8¹/₄" × 14", 8¹/₂" × 11", 5¹/₂" × 8¹/₂", 7¹/₄" × 10¹/₂", 8" × 13", 8¹/₂" × 13", 8¹/₄" × 13", 11" × 15", 10" × 14", 8" × 10", 8K, 16K, 9¹/₂" × 4¹/₂", 7¹/₂" × 3⁷/₈", C6 Env, C5 Env, DL Env
- When the beeper is turned off, it will not sound if you insert paper into the bypass tray. See "System Settings", General Settings Guide.

❖ Preset Reduce/Enlarge

- You can select one of 12 preset ratios (5 enlargement ratios, 7 reduction ratios).
- Following shows the relation between the original's size and copied-to-paper size at respective scaling factors.
 - Metric version
 - 400% (Area ratio 16 times):-
 - 200% (Area ratio 4 times): A5 → A3, B6 JIS → B4 JIS
 - 141% (Area ratio 2 times): A4 → A3, A5 → A4, B5 JIS → B4 JIS, B6 JIS → B5 JIS
 - 122%: A4 → B4 JIS, A5 → B5 JIS
 - 115%: B4 JIS → A3, B5 JIS → A4, B6 JIS → A5
 - 93%:-
 - 82%: B4 JIS → A4, B5 JIS → A5
 - 75%: B4 JIS → F4, B4 JIS → F
 - 71% (Area ratio 1¹/₂times): A3 → A4, A4 → A5, B4 JIS → B5 JIS, B5 JIS → B6 JIS
 - 65%: A3 → F
 - 50% (Area ratio 1¹/₄times): A3 → A5, B4 JIS → B6 JIS
 - 25%:-

- Inch version
 - 400% (Area ratio 16 times): -
 - 200% (Area ratio 4 times): $5\frac{1}{2}'' \times 8\frac{1}{2}'' \rightarrow 11'' \times 17''$
 - 155% (Area ratio 2 times): $5\frac{1}{2}'' \times 8\frac{1}{2}'' \rightarrow 8\frac{1}{2}'' \times 14''$
 - 129%: $8\frac{1}{2}'' \times 11'' \rightarrow 11'' \times 17''$
 - 121%: $8\frac{1}{2}'' \times 14'' \rightarrow 11'' \times 17''$
 - 93%: -
 - 85%: $F \rightarrow 8\frac{1}{2}'' \times 11''$
 - 78%: $8\frac{1}{2}'' \times 14'' \rightarrow 8\frac{1}{2}'' \times 11''$
 - 73%: $11'' \times 15'' \rightarrow 8\frac{1}{2}'' \times 11''$
 - 65%: $11'' \times 17'' \rightarrow 8\frac{1}{2}'' \times 11''$
 - 50% (Area ratio $\frac{1}{4}$ times): $11'' \times 17'' \rightarrow 5\frac{1}{2}'' \times 8\frac{1}{2}''$
 - 25%: -

- You can select a ratio regardless of the size of an original or copy paper. With some ratios, parts of the image might not be copied or margins will appear on copies.
- If a Copy Data Security Unit is installed, you can select the factor from 50 to 400%.

❖ Zoom

- The reproduction ratios you can specify are 25-400%. The factor can be from 50 to 400%, when the machine is equipped with a Copy Data Security Unit.
- You can select a ratio regardless of the size of an original or copy paper. With some ratios, parts of the image might not be copied or margins will appear on copies.

❖ Size Magnification





























































- If the calculated ratio is over the maximum or under the minimum ratio, it is automatically adjusted to within available range. However, with some ratios, parts of the image might not be copied or margins will appear on copies.
- The reproduction ratios you can specify are 25-400%. If the machine is equipped with a Copy Data Security Unit, the range is from 50 to 400%.

❖ Directional Size Magnification

- The reproduction ratio you can specify are 25-400%. If the machine is equipped with a Copy Data Security Unit, the range is from 50 to 400%.
- When entering a percentage ratio, you can specify any value in the permitted range, regardless of original or copy paper size. However, depending on settings and other conditions, part of the image may not be copied, or margins will appear on copies.
- When entering a size in mm, if the calculated ratio is over the maximum or under the minimum ratio, it is automatically adjusted to within available range. However, with some ratios, parts of the image might not be copied or margins will appear on copies.

❖ Sort, Rotate Sort, Stack

- Following shows the stackable paper sizes and the orientation.
 - SR790
 $12" \times 18"$, A3, B4 JIS, A4, B5 JIS, A5, $11" \times 17"$, $8\frac{1}{2}" \times 14"$, $8\frac{1}{2}" \times 11"$, $5\frac{1}{2}" \times 8\frac{1}{2}"$, $7\frac{1}{4}" \times 10\frac{1}{2}"$, $8" \times 13"$, $8\frac{1}{2}" \times 13"$, 8K, 16K
 - Booklet Finisher SR3020
 $12" \times 18"$, A3, B4 JIS, A4, B5 JIS, A5, B6 JIS, A6, $11" \times 17"$, $8\frac{1}{2}" \times 14"$, $8\frac{1}{2}" \times 11"$, $5\frac{1}{2}" \times 8\frac{1}{2}"$, $7\frac{1}{4}" \times 10\frac{1}{2}"$, $8" \times 13"$, $8\frac{1}{2}" \times 13"$, $8\frac{1}{2}" \times 13"$, 8K, 16K
 - Finisher SR3030
 $12" \times 18"$, A3, B4 JIS, A4, B5 JIS, A5, B6 JIS, A6, $11" \times 17"$, $8\frac{1}{2}" \times 14"$, $8\frac{1}{2}" \times 11"$, $5\frac{1}{2}" \times 8\frac{1}{2}"$, $7\frac{1}{4}" \times 10\frac{1}{2}"$, $8" \times 13"$, $8\frac{1}{2}" \times 13"$, $8\frac{1}{2}" \times 13"$, 8K, 16K
- Paper sizes and orientations that can be used in the Rotate Sort function are A4, B5 JIS and $8\frac{1}{2}" \times 11"$.
- The number of copies that can be placed on the tray is as follows. When the number of copies exceeds capacity, remove copies from the tray.
 - Internal tray
 $A4, 8\frac{1}{2}" \times 11"$ or smaller: 500 sheets
 $B4 JIS, 8\frac{1}{2}" \times 14"$ or larger: 250 sheets
 - Internal tray 2
 125 sheets
 - SR790 (Finisher upper tray)
 $A4, 8\frac{1}{2}" \times 11"$ or smaller: 250 sheets
 $B4 JIS, 8\frac{1}{2}" \times 14"$ or larger: 50 sheets
 - SR790 (On the Finisher shift tray, stack unstapled paper)
 $A4, 8\frac{1}{2}" \times 11"$ or smaller: 1000 sheets
 $B4 JIS, 8\frac{1}{2}" \times 14"$ or larger: 500 sheets
 - SR790 (On the Finisher shift tray, stack stapled paper)
 $A4, 8\frac{1}{2}" \times 11"$: 10 to 50-leaf binding...100 to 20 copies, 2 to 9-leaf binding...100 copies
 $A4, B5 JIS, 8\frac{1}{2}" \times 11"$: 10 to 50-leaf binding...50 to 10 copies, 2 to 9-leaf binding...100 copies
 $A3, B4 JIS, 11" \times 17", 8\frac{1}{2}" \times 14", 12" \times 18"$: 10 to 30-leaf binding...50 to 10 copies, 2 to 9-leaf binding...50 copies
 - Booklet Finisher SR3020 (Finisher tray)
 $A4, 8\frac{1}{2}" \times 11"$ or smaller: 250 sheets
 $B4 JIS, 8\frac{1}{2}" \times 14"$ or larger: 50 sheets

- Booklet Finisher SR3020 (On the Finisher tray 2, stack unstapled paper)
 - A4 , 8 1/2" x 11" : 2000 sheets
 - A3 , A4 , B4 JIS , B5 JIS  , 11" x 17" , 8 1/2" x 14" , 8 1/2" x 11" , 12" x 18" : 1000 sheets
 - A5 : 500 sheets
 - A5 , B6 JIS , 5 1/2" x 8 1/2" , A6 : 100 sheets
- Booklet Finisher SR3020 (On the Finisher tray 2, stack stapled paper)
 - A4 , 8 1/2" x 11" : 13 to 50-leaf binding...150 to 40 copies, 2 to 12-leaf binding...150 copies
 - A4 , B5 JIS , 8 1/2" x 11" : 10 to 50-leaf binding...100 to 20 copies, 2 to 9-leaf binding...100 copies
 - A3 , B4 JIS , 11" x 17" , 8 1/2" x 14" , 12" x 18" : 10 to 30-leaf binding...100 to 33 copies, 2 to 9-leaf binding...100 copies
 - When using the mixed size mode: 2 to 30-leaf binding...50 copies
- Booklet Finisher SR3020 (Booklet tray)
 - 12" x 18" , A3 , B4 JIS , A4 , B5 JIS , 11" x 17" , 8 1/2" x 14" , 8 1/2" x 11" : 2 to 5-leaf binding...30 copies, 6 to 10-leaf binding...15 copies, 11 to 15-leaf binding...10 copies
- Finisher SR3030 (Finisher tray)
 - A4, 8 1/2" x 11" or smaller: 250 sheets
 - B4 JIS, 8 1/2" x 14" or larger: 50 sheets
- Finisher SR3030 (On the Finisher tray 2, stack unstapled paper)
 - A4 , 8 1/2" x 11" : 3000 sheets
 - A3 , A4 , B4 JIS , B5 JIS  , 11" x 17" , 8 1/2" x 14" , 8 1/2" x 11" , 12" x 18" : 1500 sheets
 - A5 : 500 sheets
 - A5 , B6 JIS , 5 1/2" x 8 1/2" , A6 : 100 sheets
- Finisher SR3030 (On the Finisher tray 2, stack stapled paper)
 - A4 , 8 1/2" x 11" : 20 to 50-leaf binding...150 to 60 copies, 2 to 19-leaf binding...150 copies
 - A4 , B5 JIS , 8 1/2" x 11" : 15 to 50-leaf binding...100 to 30 copies, 2 to 14-leaf binding...100 copies
 - A3 , B4 JIS , 11" x 17" , 8 1/2" x 14" , 12" x 18" : 15 to 30-leaf binding...100 to 50 copies, 2 to 14-leaf binding...100 copies
 - When using the mixed size mode: 2 to 30-leaf binding...50 copies
- When using the Rotate Sort or Staple functions, the capacity may be reduced.
- Installing the finisher to the internal tray also reduces the number of paper it can house.

❖ Staple

- The following type of paper cannot be stapled:
 - Postcard
 - Translucent paper
 - OHP transparencies
 - Label paper (adhesive labels)
 - Curled paper
 - Paper of low stiffness
 - Paper of mixed sizes
- In the following cases, copies will be delivered to the shift tray without stapling:
 - When the number of sheets for one set is over stapler capacity.
 - When memory reaches 0% during copying.
- When using the Staple function with **[1 Sided → 1 Sided]**, **[1 Sided → 2 Sided]**, **[2 Sided → 1 Sided]**, **[2 Sided → 2 Sided]**, or **[Double Copies]**, select original for and original for copy.
- When using the Staple function with **[1 sided → Comb 2 orig]**, **[1 sided → 2 sided:TtoB]**, **[1 sided → 2 sided:TtoT]**, or **[Double Copies]**, select paper for original and for original.
- When using the Staple function **[Staple: Left 2]** or **[Staple: Top 2]** with the Combine function **[1 Sided → 1 Sided]**, **[1 Sided → 2 Sided]**, **[2 Sided → 1 Sided]**, **[2 Sided → 2 Sided]**, or **[Double Copies]**, select paper for original and paper for original.
- If a finisher is installed, the mixed size mode and the auto paper selection function become available. These functions make it possible to choose the paper appropriate for stapling from the mixed sizes. Prior to the operation, you should set on the feed tray the paper of the size to be used. Following sizes allow the stapling when mixed with other sizes.
 - A3 and A4
 - B4 JIS and B5 JIS
 - 11" × 17" and 8¹/₂" × 11"
- Paper sizes and orientation that can be used in the Staple function and the stapler capacity are as follows:
 - SR790
12" × 18", A3, B4 JIS, 11" × 17", 8¹/₂" × 14", 8¹/₄" × 14",
8" × 13", 8¹/₂" × 13", 8¹/₄" × 13", 11" × 15", 10" × 14", 8K: 30 sheets
 - A4 , B5 JIS , 8¹/₂" × 11" , 7¹/₄" × 10¹/₂" , 8" × 10",
16K : 50 sheets

- Booklet Finisher SR3020
 12" × 18"□, A3□, B4 JIS□, 11" × 17"□, 8¹/₂" × 14"□, 8¹/₄" × 14"□,
 8" × 13"□, 8¹/₂" × 13"□, 8¹/₄" × 13"□, 11" × 15"□, 10" × 14"□,
 8" × 10"□, 8K□: 30 sheets
 A4□□, B5 JIS□□, 8¹/₂" × 11"□□, 7¹/₄" × 10¹/₂"□□, 16K□□: 50
 sheets
 When using the mixed size mode: 30 sheets
 When stapling centre: 12" × 18"□, A3□, B4 JIS□, A4□, B5 JIS□,
 11" × 17"□, 8¹/₂" × 14"□, 8¹/₂" × 11"□: 15 sheets
- Finisher SR3030
 12" × 18"□, A3□, B4 JIS□, 11" × 17"□, 8¹/₂" × 14"□, 8¹/₄" × 14"□,
 8" × 13"□, 8¹/₂" × 13"□, 8¹/₄" × 13"□, 11" × 15"□, 10" × 14"□,
 8" × 10"□, 8K□: 30 sheets
 A4□□, B5 JIS□□, 8¹/₂" × 11"□□, 7¹/₄" × 10¹/₂"□□, 16K□□: 50
 sheets
 When using the mixed size mode: 30 sheets
- When stapling B4 JIS□, A3□, Legal 8¹/₂" × 14"□, 11" × 17"□, 12" × 18"□,
 be sure to extend the paper support plate of the finisher tray.
- When the number of copies exceeds tray capacity, copying stops. If this
 happens, remove the copies from the shift tray, and then resume copying.
 The tray capacity for the stapled sheets is as follows: (paper weight: 80 g/m², 20 lb.)
 - SR790 (Finisher shift tray)
 A4□, 8¹/₂" × 11"□: 10 to 50-leaf binding...100 to 20 copies, 2 to 9-leaf
 binding...100 copies
 A4□, B5 JIS□, 8¹/₂" × 11"□: 10 to 50-leaf binding...50 to 10 copies, 2 to
 9-leaf binding...100 copies
 A3□, B4□, 11" × 17"□, 8¹/₂" × 14"□, 12" × 18"□: 10 to 30-leaf bind-
 ing...50 to 10 copies, 2 to 9-leaf binding...50 copies
 - Booklet Finisher SR3020
 A4□, 8¹/₂" × 11"□: 13 to 50-leaf binding...150 to 40 copies, 2 to 12-leaf
 binding...150 copies
 A4□, B5 JIS□□, 8¹/₂" × 11"□: 10 to 50-leaf binding...100 to 20 copies,
 2 to 9-leaf binding...100 copies
 A3□, B4 JIS□, 11" × 17"□, 8¹/₂" × 14"□, 12" × 18"□: 10 to 30-leaf bind-
 ing...100 to 33 copies, 2 to 9-leaf binding...100 copies
 When using the mixed size mode: 2 to 30-leaf binding...50 copies
 When stapling centre: 12" × 18"□, A3□, B4 JIS□, A4□, B5 JIS□,
 11" × 17"□, 8¹/₂" × 14"□, 8¹/₂" × 11"□: 2 to 5-leaf binding...30 copies,
 6 to 10-leaf binding...15 copies, 11 to 15-leaf binding...10 copies
 - Finisher SR3030
 A4□, 8¹/₂" × 11"□: 20 to 50-leaf binding...150 to 60 copies, 2 to 19-leaf
 binding...150 copies
 A4□, B5 JIS□□, 8¹/₂" × 11"□: 15 to 50-leaf binding...100 to 30 copies,
 2 to 14-leaf binding...100 copies
 A3□, B4 JIS□, 11" × 17"□, 8¹/₂" × 14"□, 12" × 18"□: 15 to 30-leaf bind-
 ing...100 to 50 copies, 2 to 14-leaf binding...100 copies
 When using the mixed size mode: 2 to 30-leaf binding...50 copies

- You cannot change stapling positions during copying.
- When the original image is rotated, the staple orientation changes by 90°.
- The maximum original image size that can be rotated is as follows: Metric version: A4, Inch version: 8¹/₂" × 11"
- When using **[Staple: Slant]**, **[Staple: Bottom Slant]**, **[Staple: Left 2]**, or **[Staple: Top 2]** with Combine, Double copies or Auto Reduce / Enlarge function, "Blank part will appear. Check orientation." message may appear depending on the orientation of originals and paper you placed. In this case, change the paper orientation.
- When **[Staple: Left 2]**, or **[Staple: Top 2]** is selected, the following settings are useful to rotate images appropriately:
 - **[Auto Reduce / Enlarge]** or **[Auto Paper Select]**
 - Replace **[Auto Tray Switching]** with **[With Image Rotation]** in the User Tool's Copier / Document Server Features
- If you select **[Staple: Centre]** with the optional booklet finisher, the machine staples and folds the paper in the centre, then delivers the paper folded.
- If you select **[Staple: Centre]** from the Booklet or Magazine function, the machine staples the paper, and folds it like a book, then delivers the paper folded.

❖ Punch

- When using Punch and Combine, Double Copies, or Auto Reduce/Enlarge, the message "Blank part will appear. Check orientation." may appear because of the orientation of the original and the copy paper. If this occurs, change the orientation of the copy paper.
- Since punch holes are made in each copy, the punch hole positions vary slightly.
- Punchable paper sizes are as follows:
 - 2 and 4 holes type (2 holes)
A3☐, B4 JIS☐, A4☐☐, B5 JIS☐☐, A5☐☐, 11" × 17"☐, 8¹/₂" × 14"☐, 8¹/₄" × 14"☐, 8¹/₂" × 11"☐☐, 7¹/₄" × 10¹/₂"☐☐, 8¹/₂" × 13"☐, 8¹/₄" × 13"☐, 8" × 13"☐, 5¹/₂" × 8¹/₂"☐, 11" × 15"☐, 10" × 14"☐, 8" × 10"☐, 8K☐, 16K☐☐
 - 2 and 4 holes type (4 holes)
A3☐, B4 JIS☐, A4☐, B5 JIS☐, 11" × 17"☐, 8¹/₂" × 11"☐, 7¹/₄" × 10¹/₂"☐, 11" × 15"☐, 8K☐, 16K☐
 - 4 holes type
A3☐, B4 JIS☐, A4☐☐, B5 JIS☐☐, A5☐☐, 11" × 17"☐, 8¹/₂" × 14"☐, 8¹/₄" × 14"☐, 8¹/₂" × 11"☐☐, 7¹/₄" × 10¹/₂"☐☐, 8¹/₂" × 13"☐, 8¹/₄" × 13"☐, 8" × 13"☐, 5¹/₂" × 8¹/₂"☐, 11" × 15"☐, 10" × 14"☐, 8" × 10"☐, 8K☐, 16K☐☐

❖ Duplex

- You can use the following copy paper with this function:
A3, B4 JIS, A4, B5 JIS, A5, 11" × 17", 8¹/₂" × 14", 8¹/₄" × 14", 8¹/₂" × 11", 7¹/₄" × 10¹/₂", 8" × 13", 8¹/₂" × 13", 8¹/₄" × 13", 11" × 15", 10" × 14", 8" × 10", 8K, 16K
- You cannot use the following copy paper with this function:
 - Paper smaller than A5, 5¹/₂" × 8¹/₂"
 - Translucent paper
 - Label paper (adhesive labels)
 - OHP transparencies
 - Paper thicker than 105 g/m², 28 lb.
 - Paper thinner than 64 g/m², 17 lb.
 - Postcards
- When an odd number of originals are placed in the ADF, the back of the last page of copied paper is blank.
- During copying, the image is shifted to allow for the binding margin.

❖ Combine

- In this mode, the machine selects the reproduction ratio automatically. This reproduction ratio depends on copy paper sizes and the number of originals.
- The reproduction ratios you can specify are 25-400%. If the machine is equipped with a Copy Data Security Unit, the range is from 50 to 400%.
- If the calculated ratio is under the minimum ratio, it is automatically adjusted to within available range. However, with some ratios, parts of the image might not be copied.
- You cannot use custom size paper.
- If the orientation of originals is different from that of the copy paper, the machine will automatically rotate the image by 90° to make copies properly.
- If the number of originals placed is less than the number specified for combining, the last page segment is left blank as shown.

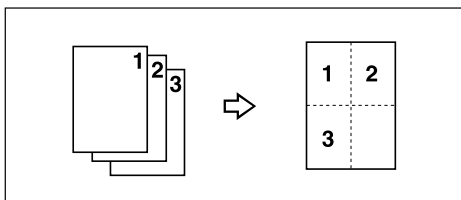

❖ Booklet/Magazine

- The machine sets the reproduction ratio automatically to meet the paper size and copies the originals together onto the paper.
- The reproduction ratios you can specify are 25-400%. If the machine is equipped with a Copy Data Security Unit, the range is from 50 to 400%.
- If the calculated ratio is under the minimum ratio, it is automatically adjusted to within available range. However, with some ratios, parts of the image might not be copied.
- If the orientation of originals is different from that of the copy paper, the machine will automatically rotate the image by 90° to make copies properly.
- You cannot copy with originals different in size and orientation.
- If the number of originals scanned is less than a multiple of 4, the last page is copied blank.
- In Magazine mode, the copying may take some time after scanning originals.
- When the optional Booklet Finisher SR3020 is installed, if you select **[Staple: Centre]** in Magazine mode, the machine staples and folds the paper in the centre, then delivers the paper folded.

❖ Image Repeat

- Depending on the paper size, ratio, and orientation, parts of repeated images may not be copied.

❖ Centring

- Though the original is set to a different orientation from the paper loaded, the machine will not rotate the image by 90° (Rotate copy).

❖ Erase

- The width of the erased margin varies depending on the reproduction ratio.
- If the size of the original is different from sizes listed in the following chart, the erased margin might be shifted:
 - Metric version
Exposure glass : A3, B4 JIS, A4, B5 JIS
ADF : A3, B4 JIS, A4, B5 JIS, A5
 - Inch version
Exposure glass: 11" × 17", 8 1/2" × 14", 8 1/2" × 11"
ADF: 11"×17", 8 1/2" × 14", 8 1/2" × 11", 5 1/2" × 8 1/2"

❖ Background Numbering

- The numbers appear to overlap the copied image in some cases.

❖ Margin Adjustment

- If you set a binding margin that is too wide, part of the image may not be copied.
- When making copies in Combine mode, the binding margin is added to the copies after the combination is finished.

❖ Preset Stamp

- You can change the size and density of the stamp with User Tools. Depending on the setting, density may change.
- Depending on paper size, if you change the stamp size, parts of the stamp might not be printed.

❖ Date Stamp

- When using Combine mode, the date stamp is printed as follows:
 - With the Combine function

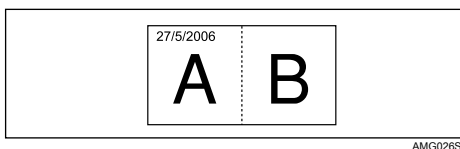

- With the Magazine or Booklet function

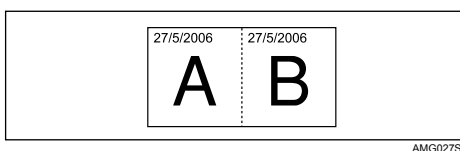

❖ Page Numbering

- When page numbering is used with Combine mode, page numbers are printed as follows:
- Page Numbering per original:
With 1 Sided/2 Sided using the Combine function

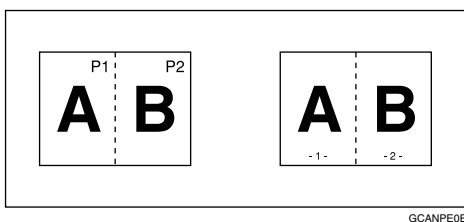

With the Magazine or Booklet function

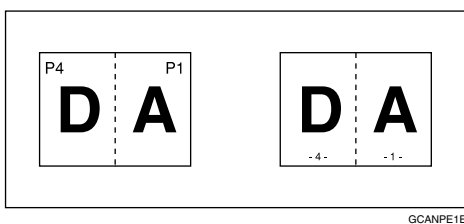

- Page Numbering per copy:
With 1 Sided/2 Sided using the Combine function

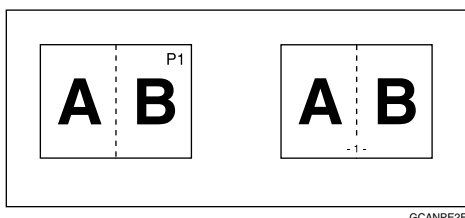

GCANPE2E

- If you combine this function with the Duplex (Top to Top) function and select [P1,P2...] or [1/5,2/5...], page numbers on the back are printed as follows:

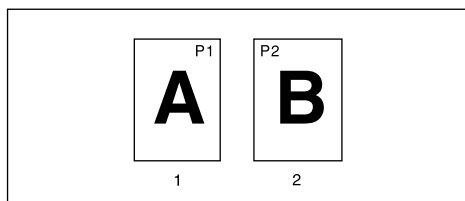

GCSTMPBE

- ① Front
- ② Back

❖ Front Cover, Front/Back Cover

- If Blank mode is selected, the cover will not be counted as a copy.
- Front and back covers are two-sided copied depending on the settings made in Display Time in Cover Sheet Tray of User Tools (System Settings).
 - At Mode Selected... Depends on the setting done from Cover Sheet Tray.
 - Full Time... Depends on the setting done from Paper Type. See "Tray Paper Settings", General Settings Guide.

❖ Slip Sheet

- If you do not copy onto slip sheets, they are excluded from the number of copies counted.

INDEX

-
- 1 Sided 16 Pages to Combine 2 Sides, 89
 - 1 Sided 2 Pages to Combine 1 Side, 87
 - 1 Sided 4 Pages to Combine 1 Side, 87
 - 1 Sided 4 Pages to Combine 2 Sides, 89
 - 1 Sided 8 Pages to Combine 1 Side, 87
 - 1 Sided 8 Pages to Combine 2 Sides, 89
 - 1 Sided to 2 Sides, 83
 - 1 Sided to Booklet, 94
 - 1 Sided to Magazine, 94
 - 2 Sided 16 Pages to Combine 2 Sides, 89
 - 2 Sided 1 Page to Combine 1 Side, 87
 - 2 Sided 2 Pages to Combine 1 Side, 87
 - 2 Sided 4 Pages to Combine 1 Side, 87
 - 2 Sided 4 Pages to Combine 2 Sides, 89
 - 2 Sided 8 Pages to Combine 2 Sides, 89
 - 2 Sided to 1 Sided, 92
 - 2 Sided to 2 Sided, 83
 - 2 Sided to Booklet, 94

A

- Adjust Colour, vi, 47
- Adjust Colour Image, 6
- Adjusting Colours Based on Selected Colour, 54
- Adjusting Copy Image Density, 57
- Adjusting the background density, 51
- Adjusting the contrast, 50
- Adjusting the sharpness/softness, 50
- Adjusting the Text/Photo sensitivity, 52
- Adjusting the U.C.R., 51
- Adjust U.C.R., vii, 48
- Administrator Tools, 6
- Auto Document Feeder, 12
- Auto image density, 57
- Auto Paper Select, 60, 61
- Auto Reduce/Enlarge, 67

B

- Background Density, vii, 48
- Background Numbering, v, 107, 173
- Basic Procedure, 25
- Batch mode, 20
- Binding margin, 100
- Black/White Copy, iii, 40
- Booklet, 94
- Booklet/Magazine, xii, xvii, 94, 173
- Book to 1 Sided, 92
- Book to 2 Sided, 94
- Border Erase, 101, 102, 103, 105, 106

- Bypass tray, 35, 36
- Bypass Tray Copy, 173

C

- Centre, 104, 105, 106
- Centre/Border Erase, 101, 105, 106
- Centre Erase, 101, 104
- Centring, 130, 173
- Changing a Stored Program, 144
- Changing the Number of Sets, 75
- Changing the order of jobs, 30
- Changing the registered contents, 46
- Changing User Name, File Name or Password of a Stored Document, 157
- Chapters, 137
- Checking Job History, 32
- Checking jobs in the print queue, 30
- Checking the Details of a Stored Document, 158
- Colour Background, iii, 43
- Colour Balance, vi, 44
- Colour Functions, 40
- Combine, 173
- Combined auto and manual image density, 57, 58
- Contrast, vii, 48
- Convert Colours, iii, 41
- Copier Functions, 57, 147
- Copying, 25
- Copying 2-Sided Pages, xviii
- Copying 2-Sided Pages onto 1-Sided Pages, xviii
- Copying from the Bypass Tray, 33
- Copying onto envelopes, 39
- Copying onto OHP Transparencies, 37
- Copying onto Thick Paper, xviii, 38
- Copying onto Thin Paper, 37
- Copying originals of various sizes, 22
- Copying Originals Such as Books, xvii
- Covers, 134
- Create Margin function, 64
- Creating Colours by
 - Directly Specifying the Density of Each Colour with Number Keys, 55
- Custom size paper, 36
- Custom sizes, 24

D

Date, 118
Date Stamp, v, 116, 173
Deleting a Document, 168
Deleting a Program, 145
Deleting jobs, 31
Deleting User colours, 56
Designate, 136
Directional Magnification, 69, 70
Directional Size Magnification (mm), 71
Display, 4
Displaying a Document in Document
 Server with Web Image Monitor, 169
Document Server, 147
Document Server Display, 148
Double Copies, 129
Downloading Stored Documents, 170
Duplex, ix, 83, 173

E

Edit, 6
Erase, 101, 173
Erase Colour, 42
Erase Specified Colour, iii

F

Fax Functions, 147
First Printing Number, 122, 124, 125
First Printing Page, 122, 124, 125
Front/Back Covers, 134
Front & Back to 2 Sided, 94
Front Cover, 134
Front Cover, Front/Back Cover, 173
Full Colour Copy, iii, 40
Function Compatibility, 171

G

General Features, 6
Generation Copy, 59

H

Holding print jobs, 31
How to fold and
 unfold copies to make a booklet, 94
How to fold and
 unfold copies to make a magazine, 94
How to Read This Manual, 2

I

Image density, 57
Image Repeat, 126, 173
Initial Display, 146
Input / Output, 6
Interrupt Copy, 26
Interrupting Printing, 163
Invert, 132

J

Job List, 28
Job List screen, 29
Job Preset, 27

L

Last Number, 122, 124
Left Original Beeper, 27

M

Magazine, 94
Manual image density, 58
Manual Paper Select, 61
Manuals for This Machine, i
Map, 59
Margin Adjustment, 100, 173
Mirror, 133
Missing image area, 14
Mixed size mode, 22, 173

O

One-Sided Combine, xv, 87
Option, 3
Orientation, 111
Original orientation, 16, 78, 108, 111,
 116, 119
Original orientation and completed copies, 83
Originals, 11, 14
Originals and copy orientation, 86
Original size, 23

P

Page Numbering, v, 119, 121, 122, 124, 125, 173
Pale, 59
Photo, 59
Placing Originals, 11, 15
Placing Originals in the
 Auto Document Feeder, 18
Placing originals of different sizes, 22
Placing Originals on the Exposure Glass, 17
Positive/Negative, 132
Preset Reduce/Enlarge, 63, 173
Preset Stamp, v, 108, 110, 173
Preview Display, 151
Primary Colours, vi
Printer Functions, 147
Printing a List of user colours, 56
Printing a Specified Page, 166
Printing a Stored Document, 162
Printing the First Page, 165
Program, 146
Program Colour Balance, 45
Programming Defaults, 146
Programs, 142
Punch, 81
Punch hole positions, 81

R

Recalling a Program, 145
Reflect, 133
Registering the adjusted colour balance, 45
Regular sizes, 23
Renaming a Colour, 56
Repeat, 126
Reproduction Ratio, 6
Reverse, 132
Rotate Sort, 72

S

SADF, 21
SADF mode, 21
Sample Copy, 74
Sample Print, 164
Scanner Functions, 147
Searching for a Stored Document, 159
Selecting a Colour Mode, 40
Selecting Copy Paper, 60
Series Copies, 92
Sharp/Soft, vii, 48
Simplified Display, 5, 150
Size Magnification, 68, 173

Sizes and Weights of
 Recommended Originals, 11
Sizes Detectable, 13
Sizes difficult to detect, 14
Slip Sheets, 138, 173
Sort, 72, 173
Specified Area Repeat, 126, 127
Stack, 76, 173
Stamp, 6
Stamp Colour, 110, 113, 118, 121
Stamp density, 110
Stamp position, 108, 110, 111, 113, 116, 118, 119, 122
Stamp size, 110
Staple, 78, 173
Stapling position, 78
Stapling position and original setting, 78
Storing a Program, 143
Storing Data, 152
Storing Data in the Document Server, 140
Symbols, 2

T

Text, 59
Text/Photo, 59
Text/Photo Sensitivity, vii, 48
To change a file name, 156
To change the format of date, 118
To delete the user stamp, 115
To enter the ratio with the number keys, 66, 69
To program the user stamp, 113
To register or change a user name, 154, 155
To search by file name, 160
To search by user name, 160
To set or change a Password, 157
Two-Sided Combine, 89

U

User Colour, 53
User Stamp, v, 111, 113, 115

W

What You Can Do with This Machine, iii, ix
Whole Area Repeat, 126

Z

Zoom, 65, 173

In accordance with IEC 60417, this machine uses the following symbols for the main power switch:

I means **POWER ON.**

○ means **POWER OFF.**

⏻ means **STAND BY.**

Acrobat® is a registered trademark of Adobe Systems Incorporated.

Other product names used herein are for identification purposes only and might be trademarks of their respective companies. We disclaim any and all rights to those marks.

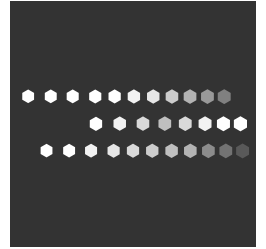

Type for MP C3500/Aficio MP C3500/ISC 3535
Type for MP C4500/Aficio MP C4500/ISC 4045
AE **AE** B222-7658

Free Manuals Download Website

<http://myh66.com>

<http://usermanuals.us>

<http://www.somanuals.com>

<http://www.4manuals.cc>

<http://www.manual-lib.com>

<http://www.404manual.com>

<http://www.luxmanual.com>

<http://aubethermostatmanual.com>

Golf course search by state

<http://golfingnear.com>

Email search by domain

<http://emailbydomain.com>

Auto manuals search

<http://auto.somanuals.com>

TV manuals search

<http://tv.somanuals.com>