

Operating Instructions

Laser Facsimile

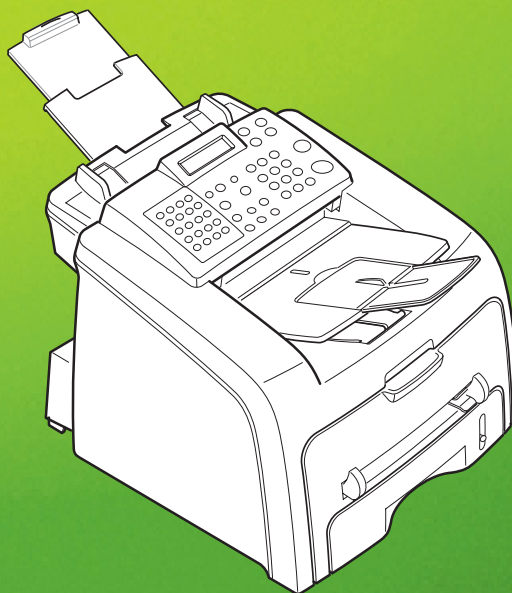

For safe and correct use of this machine, please be sure to read the Safety Information in this manual before you use it.

About the Operating Instructions

Your machine comes with the References:

This Operating Instructions provides information you need for setting up your machine and installing the supplied software. It also provides all of the detailed instructions for using your machine as a printer, a scanner and a copier and information for maintaining and troubleshooting the machine.

Contents of this manual are subject to change without prior notice. In no event will the company be liable for direct, indirect, incidental or consequential damages as a result of handling or operating the machine.

Copyright © 2004.

- Centronics is a trademark of Centronics Data Computer Corporation.
- IBM and IBM PC are a Trademark of International Business Machines Corporation.
- Microsoft, Windows, Windows 9x, Window Me, Windows 2000, Windows NT 4.0 and Windows XP are registered trademarks of Microsoft Corporation.
- TrueType is a trademarks of Apple Computer, Inc.
- All other brand or product names are trademarks of their respective companies or organizations.

Safety Information

When using this machine, the following safety precautions should always be followed.

Safety During Operation

In this manual, the following important symbols are used:

 **WARNING:**

Indicates a potentially hazardous situation which, if instructions are not followed, could result in death or serious injury.

 **CAUTION:**

Indicates a potentially hazardous situation which, if instructions are not followed, may result in minor or moderate injury or damage to property.

 **WARNING:**

- **Connect the power cord directly into a wall outlet and never use an extension cord.**
- **Disconnect the power plug (by pulling the plug, not the cable) if the power cable or plug becomes frayed or otherwise damaged.**
- **To avoid hazardous electric shock or laser radiation exposure, do not remove any covers or screws other than those specified in this manual.**
- **Turn off the power and disconnect the power plug (by pulling the plug, not the cable) if any of the following occurs:**
 - **You spill something into the machine.**
 - **You suspect that your machine needs service or repair.**
 - **The external housing of your machine has been damaged.**
- **Do not incinerate spilled toner or used toner. Toner dust might ignite when exposed to an open flame.**
- **Disposal can take place at our authorized dealer.**
- **Dispose of the used toner bottle in accordance with the local regulations.**
- **Keep the machine away from flammable liquids, gases, and aerosols. A fire or an electric shock might occur.**

⚠ CAUTION:

- *Protect the machine from dampness or wet weather, such as rain and snow.*
- *Unplug the power cord from the wall outlet before you move the machine. While moving the machine, you should take care that the power cord will not be damaged under the machine.*
- *When you disconnect the power plug from the wall outlet, always pull the plug (not the cable).*
- *Do not allow paper clips, staples, or other small metallic objects to fall inside the machine.*
- *Keep toner (used or unused) and toner bottle out of the reach of children.*
- *Be careful not to cut yourself on any sharp edges when you reach inside the product to remove misfed sheets of paper or masters.*
- *For environmental reasons, do not dispose of the machine or expended supply waste at household waste collection points. Disposal can take place at an authorized dealer.*
- *The inside of the machine could be very hot. Do not touch the parts with a label indicating the "hot surface". Otherwise, an injury might occur.*

Power Supply

The socket-outlet shall be installed near the product and shall be easily accessible.

Ozone Safety

This product generates ozone during operation.

Normally, the ozone level is safe for operators. If ozone odor may appear, ventilate the room.

For Fax or Telephone

Do not use this product near water, for example, near a bathtub, wash bowl, kitchen sink or laundry tub, in a wet basement or near a swimming pool. Avoid using a telephone during an electrical storm. There may be a remote risk of electric shock from lightning. Do not use a telephone in the vicinity of a gas leak to report the leak.

Laser Safety:

This equipment is considered a class 1 laser device. This equipment contains a 5 milliwatt, 760-800 nanometer wavelength, AlGaAs laser diode. The following marking is attached on the back of the equipment.



Caution:

Use of controls or adjustment or performance of procedures other than those specified in this Operating Instructions might result in hazardous radiation exposure.

For North America

Laser Safety:

This equipment complies with requirements of 21 CFR subchapter J for class 1 laser products. This equipment contains a 5 milliwatt, 760-800 nanometer wavelength, AlGaAs laser diode.

Caution:

Use of controls or adjustment or performance of procedures other than those specified in this Operating Instructions might result in hazardous radiation exposure.



Declaration of Conformity

Notice to Users in EEA Countries

This product complies with the essential requirements and provisions of Directive 1999/5/EC of the European Parliament and of the Council of 9 March 1999 on radio equipment and telecommunications terminal equipment and the mutual recognition of their conformity.

Notice to Users Accessing Analog PSTN in EEA Countries

This product is designed to be able to access analog PSTN in all EEA countries. Local PSTN compatibility is dependent on software switch settings. Please contact your service representative if relocating this product to another country. In the event of problems, please contact your service representative in the first instance.

FAX1130L/FAX1170L/F230/F250/LF120/LF125m : The CE declaration of Conformity is available on the Internet at URL :
http://www.ricoh.co.jp/fax/ce_doc

IF3030/IF3035 : The CE Declaration of Conformity is available by accessing the URL:

<http://jboard.danka.de/jboard/produkte/index.html> and selecting the product applicable.

Positions of Labels and Hallmarks for

⚠️ WARNING and ⚠️ CAUTION Labels

This machine has labels for ⚠️ WARNING and ⚠️ CAUTION at the positions shown below. For safety, please follow the instructions and handle the machine as indicated.

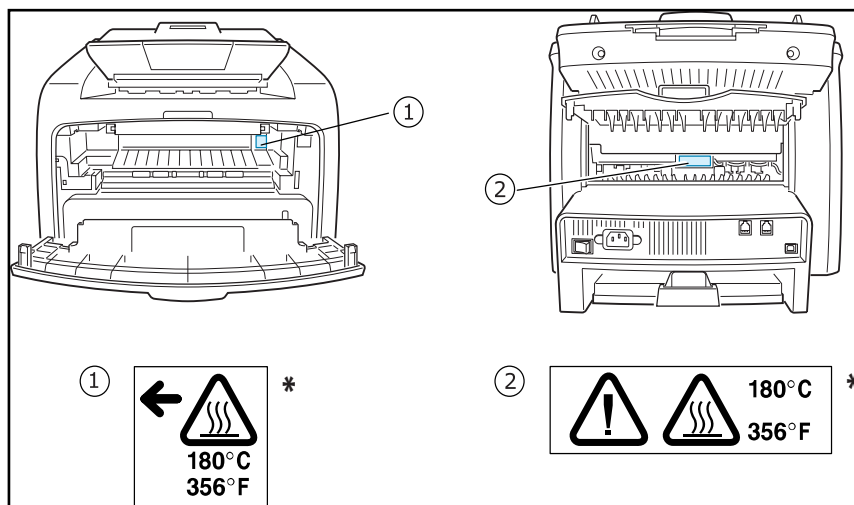

*This label is stuck to hot surfaces. Be careful not to touch these areas.

In accordance with IEC 60417, this machine uses the following symbols for the main power switch:

- | means POWER ON.
- means POWER OFF.

NOTICE

Note to users in the United States of America

Notice:

This equipment has been tested and found to comply with the limits for a Class B digital device, pursuant to Part 15 of the FCC Rules. These limits are designed to provide reasonable protection against harmful interference in a residential installation. This equipment generates, uses and can radiate radio frequency energy and, if not installed and used in accordance with the instructions, may cause harmful interference to radio communications. However, there is no guarantee that interference will not occur in a particular installation. If this equipment does cause harmful interference to radio or television reception, which can be determined by turning the equipment off and on, the user is encouraged to try to correct the interference by one more of the following measures:

- Reorient or relocate the receiving antenna.
 - Increase the separation between the equipment and receiver.
 - Connect the equipment into an outlet on a circuit different from that to which the receiver is connected.
 - Consult the dealer or an experienced radio /TV technician for help.
-

Caution

Changes or modifications not expressly approved by the party responsible for compliance could void the user's authority to operate the equipment.

Notice about the Telephone Consumer Protection Act (Valid in USA only).

The Telephone Consumer Protection Act of 1991 makes it unlawful for any person to use a computer or other electronic device, including FAX machines, to send any message unless such message clearly contains in a margin at the top or bottom of each transmitted page or on the first page of the transmission, the date and time it is sent and an identification of the business or other entity, or other individual sending the message and the telephone number of the sending machine or such business, other entity, or individual. (The telephone number provided may not be a 900 number or any other number for which charges exceed local or long-distance transmission charges.)

In order to program this information into your FAX machine, you should complete the following steps: Follow the FAX HEADER programming procedure in the Programming chapter of the operating instructions to enter the business identification and telephone number of the terminal or business. This information is transmitted with your document by the FAX HEADER feature. In addition to the information, be sure to program the date and time into your machine.

USA

◆ FCC Requirements

1. This equipment complies with Part 68 of the FCC rules and requirements adopted by the ACTA. On the cover of this equipment is a label that contains, among other information, a product identifier in the format US:AAAEQ##TXXXXX. If requested, this number must be provided to the telephone company.
2. This equipment uses the RJ11C USOC jack.
3. A plug and jack used to connect this equipment to the premises wiring and telephone network must comply with the applicable FCC Part 68 rules and requirements adopted by the ACTA. A compliant telephone cord and modular plug is provided with this product. It is designed to be connected to a compatible modular jack that is also compliant. See installation instructions for detail.
4. The REN is used to determine the number of devices that may be connected to a telephone line. Excessive RENs on a telephone line may result in the devices not ringing in response to an incoming call. In most but not all areas, the sum of RENs should not exceed five (5.0). To be certain of the number of devices that may be connected to a line, as determined by the total RENs, contact the local telephone company. The REN for this product is part of the product identifier that has the format US:AAAEQ##TXXXXX. The digits represented by ## are the REN without a decimal point (e.g., 03 is a REN of 0.3).
5. If this equipment causes harm to the telephone network, the telephone company will notify you in advance that temporary discontinuance of service may be required. But if advance notice is not practical, the telephone company will notify the customer as soon as possible. Also, you will be advised of your right to file a complaint with the FCC if you believe it is necessary.
6. The telephone company may make changes in its facilities, equipment, operations or procedures that could affect the operation of the equipment. If this happens the telephone company will provide advance notice in order for you to make necessary modifications to maintain uninterrupted service.
7. If trouble is experienced with this equipment, for repair or warranty information, please contact RICOH CORP. CUSTOMER SUPPORT DEPT. at 1-800-FASTFIX. If the equipment is causing harm to the telephone network, the telephone company may request that you disconnect the equipment until the problem is resolved.
8. In the event of operation problems (document jam, copy jam, communication error indication), refer to the solving problems section in this manual.
9. Connection to party line service is subject to state tariffs. Contact the state public utility commission, public service commission or corporation commission for information.

◆ WHEN PROGRAMMING EMERGENCY NUMBERS AND/OR MAKING TEST CALLS TO EMERGENCY NUMBERS:

1. Remain on the line and briefly explain to the dispatcher the reason for the call before hanging up.
2. Perform such activities in the off-peak hours, such as early morning hours or late evenings.

CANADA

The Ringer Equivalence Number is an indication of the maximum number of devices allowed to be connected to a telephone interface. The termination on an interface may consist of any combination of devices subject only to the requirement that the sum of the RENs of all the devices does not exceed five.

This product meets the applicable Industry Canada technical specifications.

Note:

This Class B digital apparatus complies with Canadian ICES-003.

Differences Between British and American English

British English	American English
(Re)dialling	(Re)dialing
Colour	Color
Emphasise	Emphasize
Recognise	Recognize
Organise	Organize
Authorise	Authorize
Cancelling	Canceling
Customise	Customize
Socket	Jack
Labelling	Labeling

WARNING

- Do not disassemble the machine as it may give you an electric shock.
- If you print large amount of copies, the surface of the output tray may become hot. Be careful not to touch the surface, especially for children.

CONTENTS

Chapter 1: **GETTING STARTED**

Setting Up Your Machine

Unpacking	1.2
Selecting a Location	1.5
Understanding the Component Location	1.6
Front View	1.6
Rear View	1.6
Control Panel Functions	1.7
Attaching Accessories	1.9
Document Output Support	1.9
Handset and Handset Cradle(for America only) .	1.10
Installing the Toner Cartridge	1.11
Loading Paper	1.13
Making Connections	1.16
Connecting to your computer (for MFP model only)	1.18
Turning the Machine On	1.19

Installing Software

About Software(for MFP model only)	1.20
Printer Driver Features	1.21
Installing Software in Windows (for MFP model only)	1.22
System Requirements	1.22
Installing Software in windows	1.23
Repairing Software(for MFP model only)	1.25
Removing Software(for MFP model only)	1.27

Setting Up the Machine System

Changing the Display Language	1.28
Setting the Machine ID	1.29
Entering Characters Using the Number Keypad ..	1.30
Setting the Date and Time	1.32
Changing the Clock Mode	1.33
Setting the Paper Type and Size	1.33
Setting Sounds	1.34

Speaker, Ringer, Key Sound and Alarm Sound ...	1.34
Speaker Volume	1.35
Using the Save Mode	1.36
Power Save Mode	1.36

Chapter 2: PAPER HANDLING

Selecting Print Materials	2.2
Type, Input Sources and Capacities	2.2
Guidelines for Paper and Special Materials	2.3
Selecting an Output Location	2.4
Printing to the Front Output Tray (Face down)	2.5
Printing to the Rear Output Slot (Face up)	2.5
Loading Paper in the Paper Tray	2.7
Using the Manual Feeder	2.8
Setting the Paper Type and Size for the Manual Feeder	2.10

Chapter 3: COPYING

Loading Paper for Copying	3.2
Preparing a Document	3.2
Making a Copy	3.3
Setting Copy Options	3.4
Darkness	3.4
Original Type	3.5
Number of Copies	3.5
Reduced/Enlarged Copying	3.6
Changing the Default Settings	3.7
Setting the Time Out Option	3.8
Collation Copying	3.8

Chapter 4: FAXING

Sending a Fax

Changing the Fax Setup options	4.2
Available Fax Setup Options	4.3
.....	4.5
Adjusting the Document Resolution	4.6
Sending a Fax Automatically	4.7
Sending a Fax Manually	4.8
Redialing the Last Number	4.8
Confirming Transmission	4.9
Automatic Redialing	4.9

Receiving a Fax

About Receiving Modes	4.10
Loading Paper for Receiving Faxes	4.11
Receiving Automatically in Fax Mode	4.11
Receiving Automatically in Ans/Fax Mode	4.12
Receiving Manually in Tel Mode	4.12
Receiving Manually Using Remote Receive Start Code	4.13
Receiving Faxes Using the DRPD Mode	4.13
Receiving Faxes in the Memory	4.14

Automatic Dialing

One-touch Dialing	4.15
Storing a Number for One-touch Dialing	4.15
Sending a Fax using a One-touch Number	4.16
Speed Dialing	4.16
Storing a Number for Speed Dialing	4.16
Sending a Fax using a Speed Number	4.17
Group Dialing	4.18
Setting a Group Dial Number	4.18
Editing Group Dial Numbers	4.19
Sending a Fax Using Group Dialing (Multi-address Transmission)	4.20
Searching for a Number in the Memory	4.20
Searching Sequentially through the Memory	4.21
Searching with a Particular First Letter	4.21
Printing a Phone Book List	4.21

Advanced Fax Functions

Sending Broadcasting Faxes	4.22
Sending a Delayed Fax	4.23
Sending a Priority Fax	4.25
Polling a Remote Machine	4.26
Adding Documents to a Scheduled Fax	4.27
Canceling a Scheduled Fax	4.28

Additional Features

Using Secure Receiving Mode	4.29
Printing Reports	4.31
Using Advanced Fax Settings	4.33
Changing Setting Options	4.33
Advanced Fax Setting Options	4.34
Using the Remote Control Panel (for MFP model only)	4.36

Chapter 5: PRINTING **(FOR MFP MODEL ONLY)**

Printing a Document in Windows	5.2
Canceling a Print Job	5.5
Using a Favorite Setting	5.6
Using Help	5.6
Setting Paper Properties	5.7
Setting Graphic Properties	5.9
Printing Multiple Pages on One Sheet of the Paper ...	5.11
Printing a Reduced or Enlarged Document	5.13
Fitting Your Document to a Selected Paper Size	5.14
Printing Posters	5.15
Using Watermarks	5.16
Using an Existing Watermark	5.16
Creating a Watermark	5.17
Editing a Watermark	5.18
Deleting a Watermark	5.18
Using Overlays	5.19
What is an Overlay?	5.19
Creating a New Page Overlay	5.19
Using a Page Overlay	5.21
Deleting a Page Overlay	5.23
Setting Up the Locally Shared Printer	5.24
In Windows 9x/Me	5.24
In Windows NT 4.0/2000/XP	5.25

Chapter 6: SCANNING **(FOR MFP MODEL ONLY)**

Scanning Basics	6.2
Scanning Process with TWAIN-enabled Software	6.2

Chapter 7: MAINTENANCE

Clearing the Memory	7.2
Adjusting Shading	7.3
Cleaning Your Machine	7.3
Cleaning the Outside	7.3
Cleaning the Inside	7.4
Cleaning the Scan Unit	7.5
Maintaining the Toner Cartridge	7.7
Redistributing Toner	7.8
Replacing the Toner Cartridge	7.9

Setting the Notify Toner Option	7.10
Cleaning the Drum	7.11
Ignoring the Toner Empty Message	7.11

Chapter 8: TROUBLESHOOTING

Clearing Document Jams	8.2
Input Misfeed	8.2
Exit Misfeed	8.2
Clearing Paper Jams	8.3
In the Paper Tray	8.4
In the Paper Exit Area	8.5
In the Fuser Area or Around the Toner Cartridge .	8.6
In the Manual Feeder	8.6
Tips for Avoiding Paper Jams	8.7
Clearing LCD Error Messages	8.8
Solving Problems	8.11
Paper Feeding Problems	8.11
Faxing Problems	8.12
Copying Problems	8.13
Printing Quality Problems	8.14
Printing Problems(for MFP model only)	8.19
Scanning Problems(for MFP model only)	8.22

Appendix A: SPECIFICATIONS

General Specifications	A.2
Facsimile Specifications	A.3
Scanner and Copier Specifications	A.4
Printer Specifications(for MFP model only)	A.4
Paper Specification	A.5
Overview	A.5
Supported Sizes of Paper	A.5
Guidelines for Using Paper	A.6
Paper Specifications	A.8
Paper Output Capacity	A.8
Paper Storage Environment	A.8
Envelopes	A.9
Labels(for MFP model only)	A.11
Transparencies(for MFP model only)	A.11

1

GETTING STARTED

Thank you for purchasing this multifunctional product. Your machine provides you with printing, copying, scanning, and faxing functions!

This chapter gives you step-by-step instructions for setting up your machine.

This chapter includes:

- **Setting Up Your Machine**
- **Installing Software**
- **Setting Up the Machine System**

Setting Up Your Machine

Unpacking

Remove the machine and all accessories from the packing carton. Make sure that the machine has been packed with the following items. If there is a missing item, contact the retailer where you bought the machine:



Starter Toner Cartridge

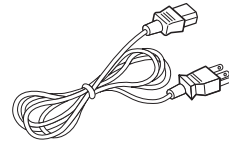

AC Power Cord*

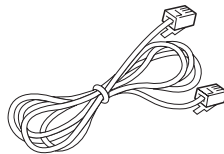

Telephone Line Cord*
(Not packed with Asia model)

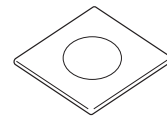

CD-ROM**
(Not packed with Asia model)

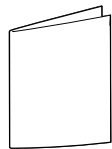

Quick Install Guide

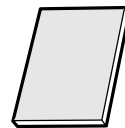

Quick Guide



Handset
(for America only)

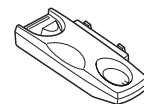

Cardle
(for America only)

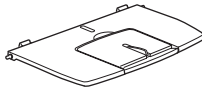

Document Output Support

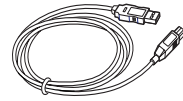

USB Cable
(for America only)



Brand plaque ***
(May already be affixed to the machine
in some regions)

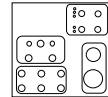

Key layout sheet
(for Europe only /May already be
affixed to the machine in some
regions)

* The appearance of the power cord and the telephone line cord may differ according to your country's specifications.

** The CD-ROM contains the Type 1200 Driver, the Operating Instructions and the Adobe Acrobat Reader program.

***Peel off the brand plaque's backing, and then stick down the plaque in the control panel's left corner.



NOTES:

- You should use the telephone line cord which is supplied with your machine. If you are replacing it with another vendor's, it should be AWG #26 or larger telephone line cord.
- The power cord must be plugged into a grounded power socket.
- Components may differ from one country to another.

Remove the packing tape from the front, back and sides of the machine.

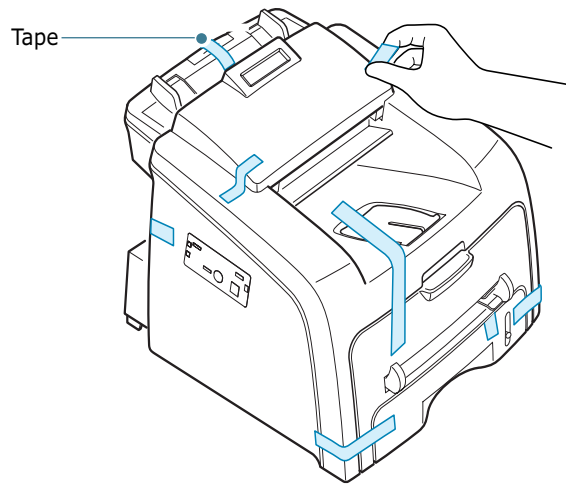

Selecting a Location

Select a level, stable place with adequate space for air circulation. Allow extra space for opening covers and trays.

The area should be well-ventilated and away from direct sunlight or sources of heat, cold and humidity. Do not set the machine close to the edge of your desk or table.

Clearance Space

- **Front:** 482.6 mm (enough space so that the paper tray can be removed)
- **Back:** 250 mm (enough space for ventilation)
- **Right:** 100 mm
- **Left:** 100 mm (enough space for ventilation)

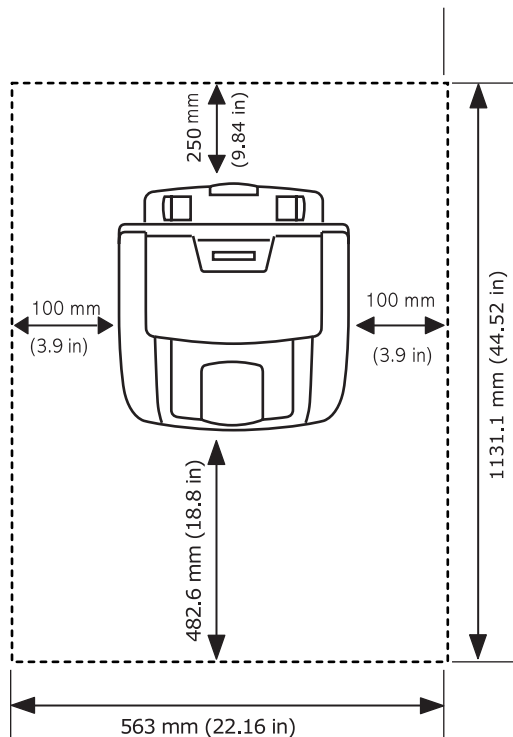

Understanding the Component Location

These are the main components of your machine:

Front View

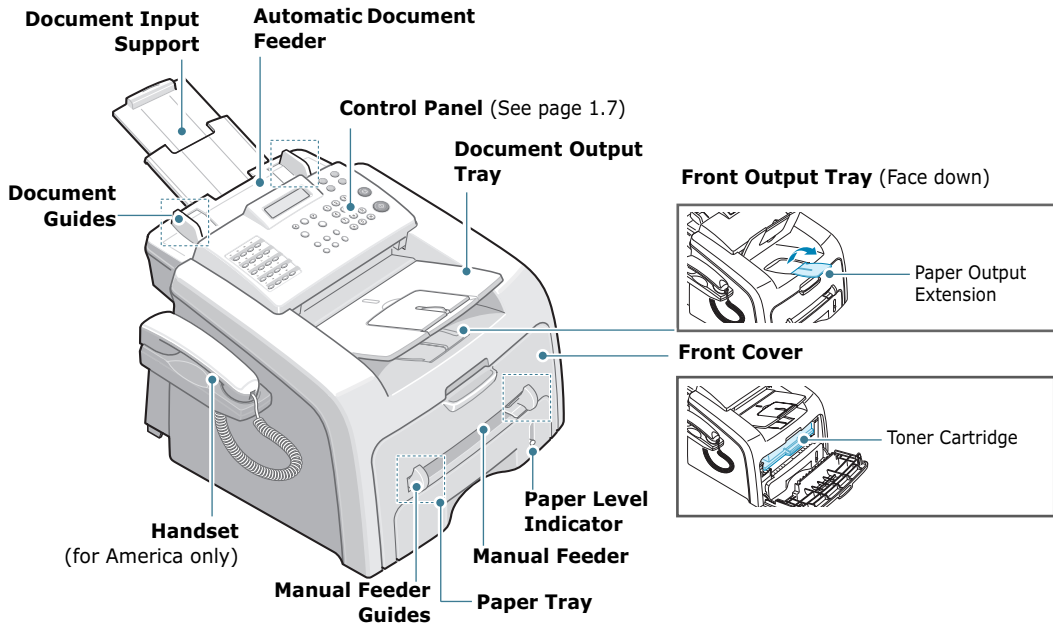



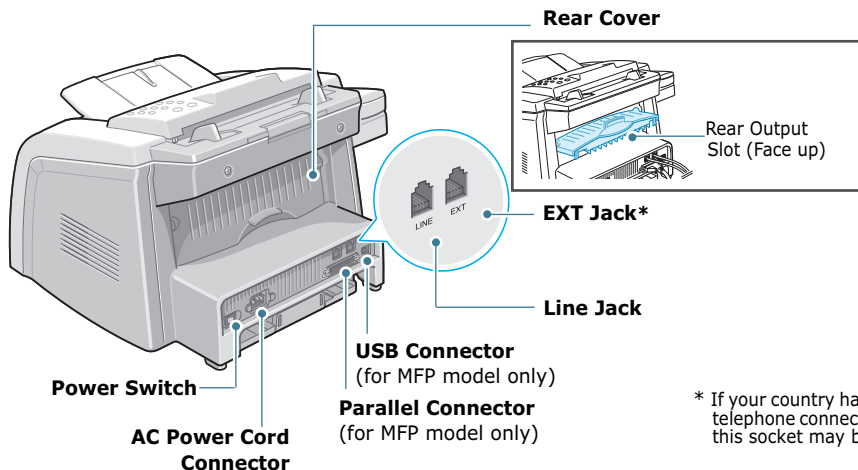



Rear View

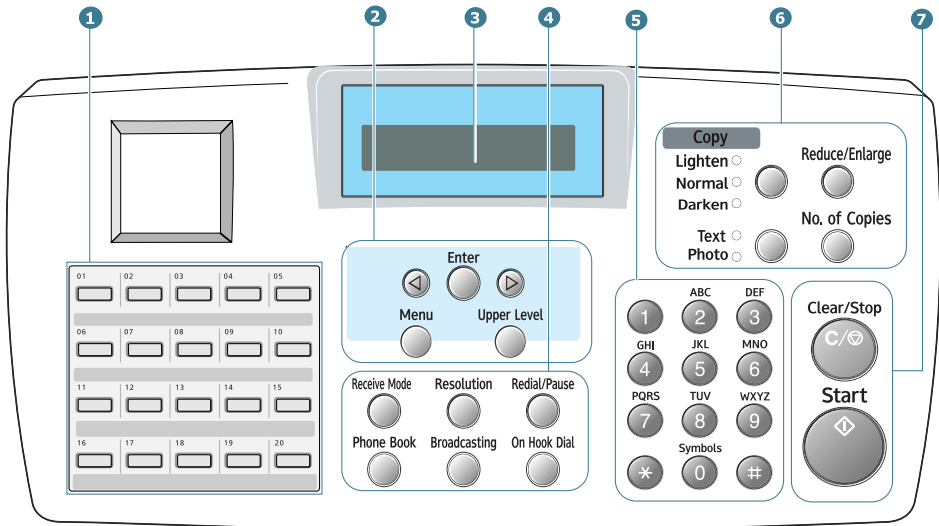













* If your country has a different telephone connection system, this socket may be blocked.

Control Panel Functions



1		Use to store frequently-dialed fax number and dial them with a touch of the buttons.
2		Scrolls through the options available for the selected menu item.
	<p>Enter</p> 	Confirms the selection on the display.
	<p>Menu</p> 	Enters Menu mode and scrolls through the menus available.
	<p>Upper Level</p> 	Returns you to the upper menu level.
3		Displays the current status and prompts during an operation.

4 F A X		Allows you to select the fax receiving mode.
		<ul style="list-style-type: none"> Allows you to store frequently-dialed fax numbers using a one or two-digit speed dial or group number for automatic dialing and edit the stored numbers. Allows you to print a Phone book list.
		Adjusts the resolution of the documents for the current fax job.
		Allows you to send a fax to multiple destinations.
		Engages the telephone line.
		Redials the last number in Standby mode or inserts a pause into a fax number in Edit mode.
5		Dials a number or enters alphanumeric characters.
6 C O P Y		Adjusts the brightness of the documents for the current copy job. *1 This button is called "Darkness" in this manual.
		Selects the document type for the current copy job. *2 This button is called "Original Type" in this manual.
		Makes a copy smaller or larger than the original document.
		Selects the number of copies.
7		Stops an operation at any time. In Standby mode, clears/stop the copy options, such as the darkness, the document type setting, the copy size and the number of copies.
		Starts a job.

Attaching Accessories

Document Output Support

Insert the two tabs on the supplied document output support into the slots on both sides of the paper output tray.

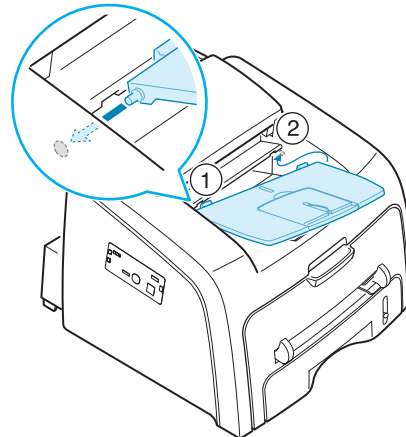

Fold out the extender, if necessary.

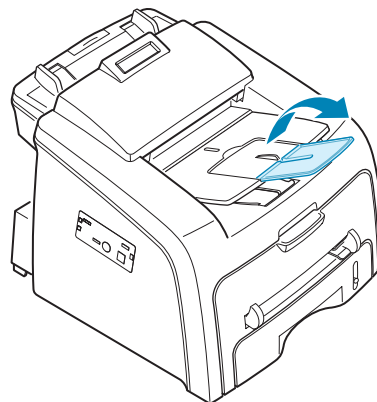

NOTE: When detaching the document output tray, detach it by pressing the front portion of document output tray as seen from the picture. As this time, even though the dull sound is heard the components are safe from damage.

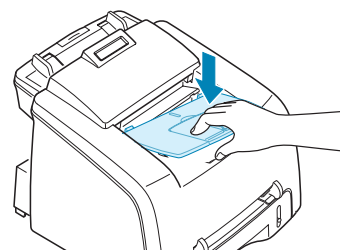

Handset and Handset Cradle(for America only)

- 1 Plug the end of the coiled cord of the handset into the jack on the left side of your machine.

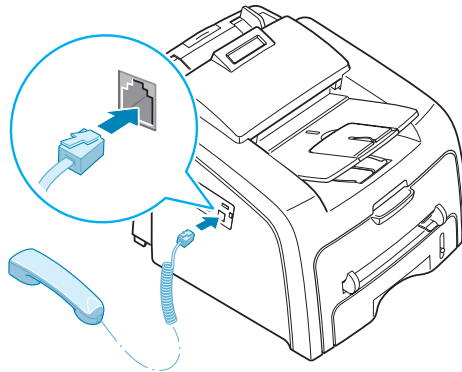

- 2 Holding the cradle as shown, attach the handset cradle to the machine.
 - ① Insert the two tabs of the cradle into the slots on the left side of the machine as shown.
 - ② Push the cradle toward the machine until it locks into place.



NOTES:

- The cradle and handset must be installed for correct operation of the set.
- To remove the cradle, push it down, pressing the latch on the bottom of the cradle.

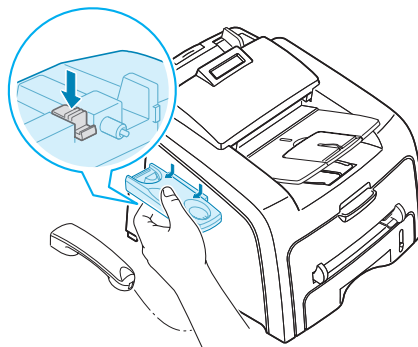

Installing the Toner Cartridge

- 1 Open the front cover.

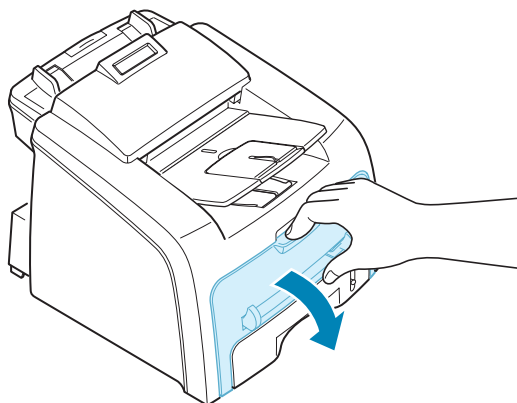

- 2 Remove the starter toner cartridge from its bag. Gently roll the cartridge 5 or 6 times to distribute the toner evenly inside the cartridge.

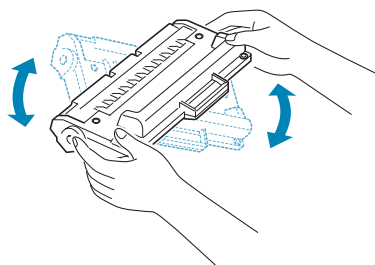

Thoroughly rolling the cartridge will assure the maximum copies per cartridge.



NOTES:

- To prevent damage, do not expose the toner cartridge to light for more than a few minutes. Cover it with a piece of paper, if left exposed for more than a few minutes.
- If toner gets on your clothing, wipe it off with a dry cloth and wash clothing in cold water. Hot water sets toner into fabric.

- 3** Slide the toner cartridge into the machine until it locks into place completely.

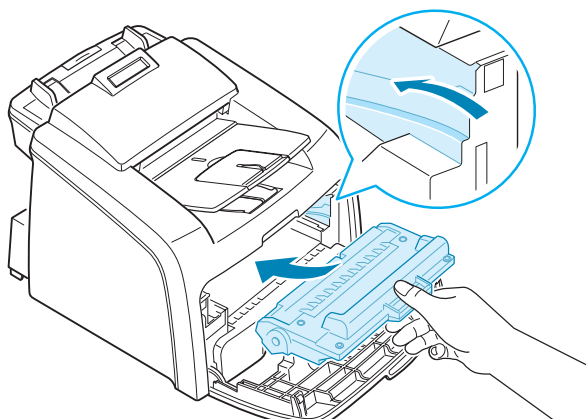

- 4** Close the front cover. Make sure that the cover is securely closed.

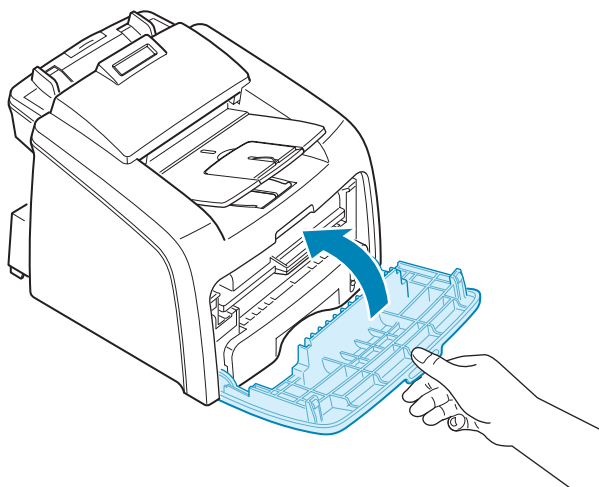

Loading Paper

You can load approximately 250 sheets.

To load a stack of Letter-sized paper:

- 1 Pull open the paper tray and remove it from the machine.

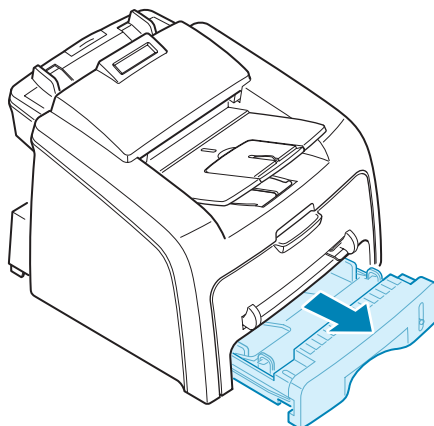

- 2 Push down on the pressure plate until it locks into place.

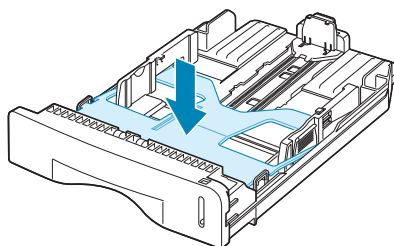

- 3 Fan the edges of the paper stack to separate the pages. Then tap the stack on a flat surface to even it up.

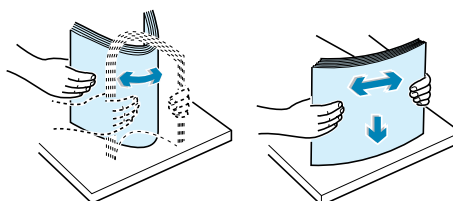

- 4 Insert the paper stack into the paper tray with the side you want to print facing up.

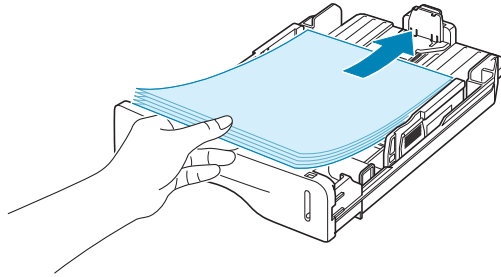

NOTE: If you want to load a different size of paper, you need to adjust the paper guides. For details, see page 1.15.

- 5 Pay attention to the paper limit mark on the left inside wall of the tray. Paper overloading may cause paper jams.

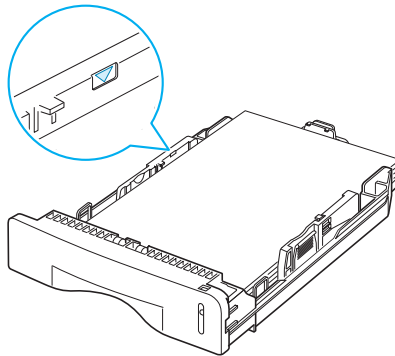

- 6 Insert and slide the paper tray back into the machine.

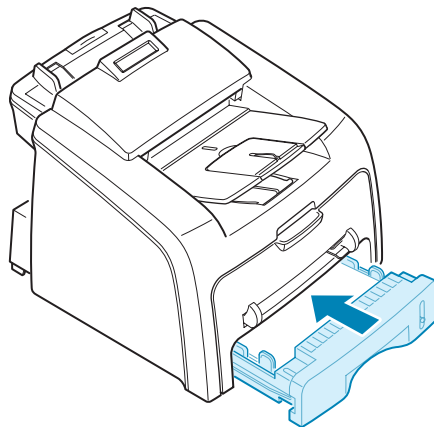

NOTE: After you load the paper, you need to set up your machine for the paper type and size you loaded. See page 1.33 for copying and faxing, or page 5.7 for PC-printing.

Changing the Paper Size in the Paper Tray

To load longer sizes of paper, such as Legal-sized paper, you need to adjust the paper guides to extend the paper tray.

- 1 After pressing and unlatching the guide lock, slide the paper length guide out completely to extend the paper tray to its full length.

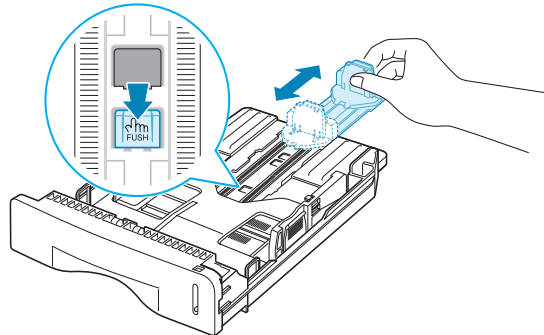

- 2 After inserting paper into the tray, slide in the guide until it lightly touches the end of the paper stack.

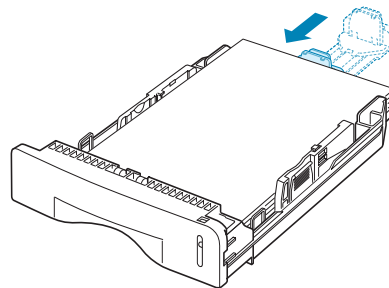

For the paper smaller than Letter, adjust the front paper length guide.

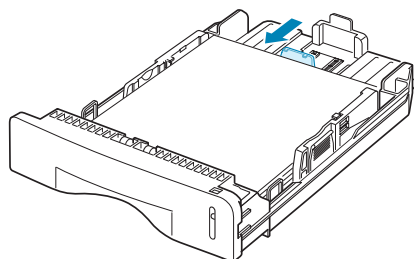

- 3 Pinching the paper width guide as shown, move it toward the stack of paper until it lightly touches the side of the stack.

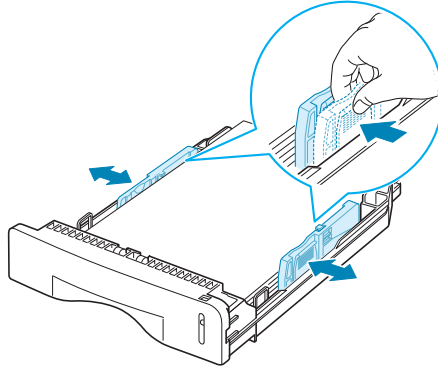

NOTES:

- Do not push the paper width guide far enough to cause the materials to warp.
- If you do not adjust the paper width guide, it may cause paper jams.

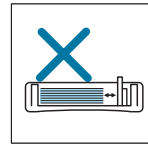
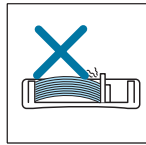
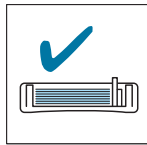

Making Connections

Plug the telephone line cord into the **LINE** jack and the other end into the wall jack.

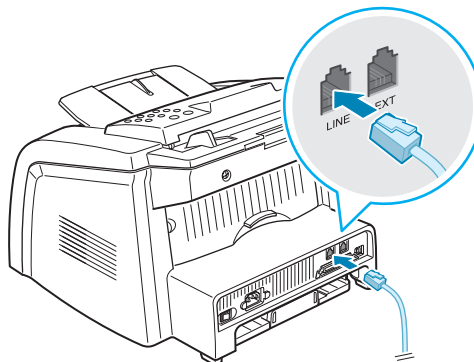

→ To the walljack

If you want to use your machine for receiving both faxes and voice calls, you will need to connect a telephone and/or answering machine to your machine.

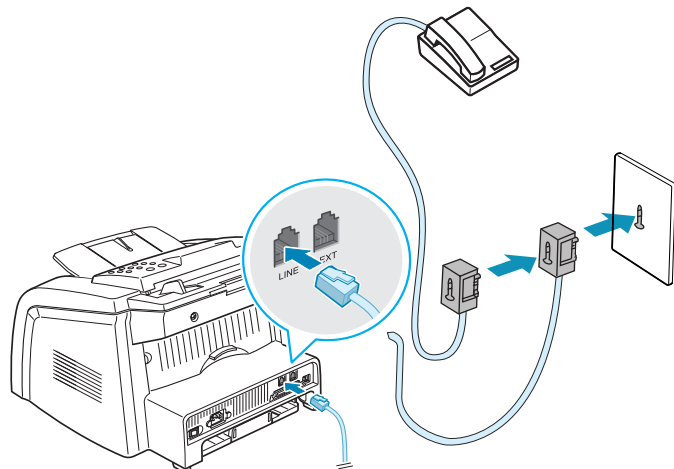
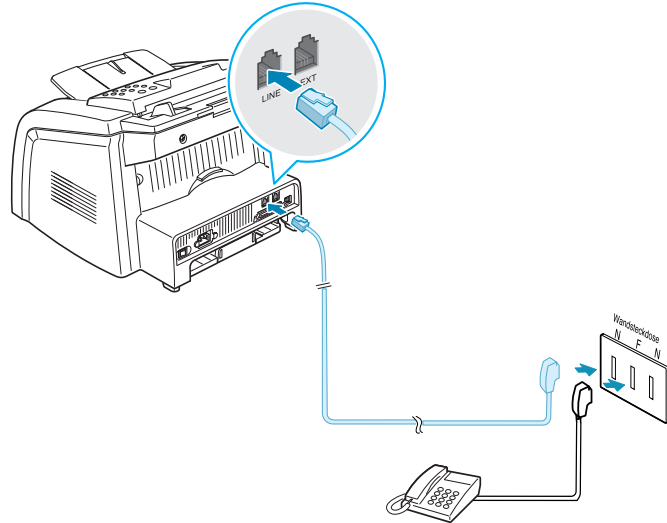
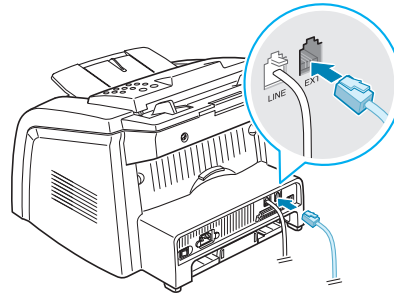

NOTE: In the United Kingdom, if a three-wire type (SHUNT-wire, older equipment) telephone or answering machine is connected to the EXT jack on the machine, the external equipment will fail to ring when receiving an incoming call as the machine is designed to operate with the latest technology. To prevent this incompatibility, use two-wire (newer equipment) telephone or answering machines.

Connecting to your computer (for MFP model only)

Plug the USB printer cable into the connector on the back of the printer.

You must use a USB 1.1 compliant cable that is no more than 3 m in length.

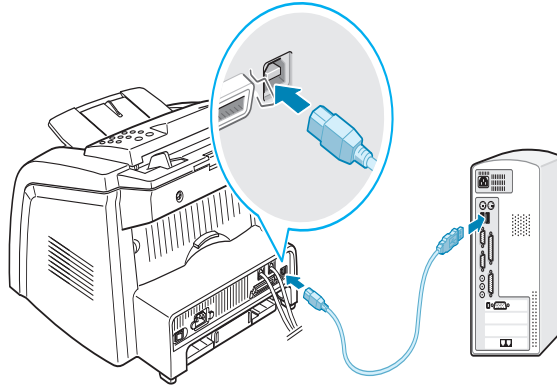

If you want to use a parallel printer cable, purchase only IEEE 1284 compliant parallel cable and connect it to the parallel connector on your machine.

Push the metal clips down to fit inside the notches on the cable plug.

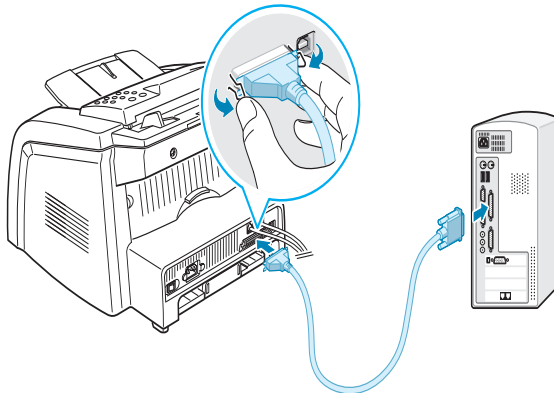

NOTES:

- You only need to connect one of the cables mentioned above. Do not use the parallel and the USB cables at the same time.
 - If you are using a USB cable, you must be running Windows 98/Me/2000/XP.
 - When using the USB connection, your machine provides two USB modes; Fast and Slow. Fast is the default mode. Some PC users may experience poor USB function in the default mode. If this occurs, select the Slow mode to achieve successful results. For details about changing the USB mode, see page 8.21.
-

Turning the Machine On

- 1 Plug one end of the supplied three-pronged electrical type cord into the AC socket on the machine and the other end into a properly grounded AC outlet.
- 2 Press the power switch to turn the machine on.

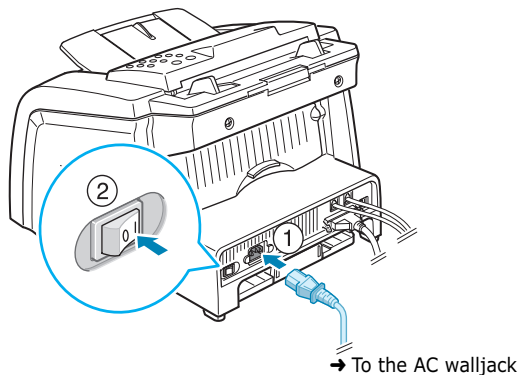

To view your display text in another language, see page 1.28.



WARNINGS:

- The fusing area inside the rear part of your machine becomes hot once the machine is turned on. Be careful when you access this area.
- Do not disassemble the machine when it is turned on as it may give you an electric shock.

Installing Software

About Software(for MFP model only)

You must install software using the supplied CD-ROM after you have set up your machine and connected it to your computer. The CD-ROM includes:

- Software
- Operating Instructions
- Adobe Acrobat Reader

The CD-ROM provides you with the following software:

Type 1200 Driver

To use your machine as a printer and scanner in Windows, you must install the Type 1200 Driver. For information about installing the Type 1200 Driver in Windows, see page 1.20.

Remote Control Panel

This Windows-based program is automatically installed when you install the Type 1200 Driver. For information about using the program, see page 4.36.

Printer Driver Features

Your printer drivers support the following standard features:

- Paper source selection
- Paper size, orientation and media type
- number of copies

The following table lists a general overview of features supported by your printer drivers.

Feature	Printer Driver		
	Win9x/Me	Win2000/XP	WinNT4.0
Toner save	Y	Y	Y
Print quality option	Y	Y	Y
Poster printing	Y	Y	Y
Multiple pages per sheet (N-up)	Y	Y	Y
Fit to page printing	Y	Y	Y
Scale printing	Y	Y	Y
Watermark	Y	Y	Y
Overlay	Y	Y	Y

Installing Software in Windows

(for MFP model only)

System Requirements

Before you begin, ensure that your system meets the minimum requirements.

Supported Operating System

- Windows 95 OSR2
- Windows 98/Windows 98 SE
- Windows Me
- Windows NT 4 Workstation or Server with Service Pack 3
- Windows 2000 Professional or Advanced Server
- Windows XP Home edition or Professional.

Minimal Requirements

- Disk space: 120 MB for installation
- Memory: 64 MB
- CPU: Pentium II 233 or higher
- Required software: Internet Explorer 4.01

Recommended

- Disk space: 300 MB for installation
- Memory: 128 MB
- CPU: Pentium II 400 or higher
- Required software: Internet Explorer 5.5



NOTES:

- For Windows NT 4.0/2000/XP, the system administrator should install software.
 - Windows 95 versions prior to OSR2 are not recommended due to incompatibility with OLE/COM libraries.
-

Installing Software in windows



NOTES:

- Cancel the "**New Hardware Found**" window when your computer boots up.
- Make sure that your machine is turned on and connected to your computer's parallel port or USB port **before installing software**. Windows 95 and Windows NT 4.0 do not support the USB connection.

- 1 Insert the supplied CD-ROM into your CD-ROM drive.

The CD-ROM should automatically run and an maintenance window appears.

If the maintenance window does not appear, click **Start** and then **Run**. Type **X:\Setup.exe**, replacing "**X**" with the letter of your drive and click **OK**.



NOTES: If your machine is not connected to the computer, the following window will appear.

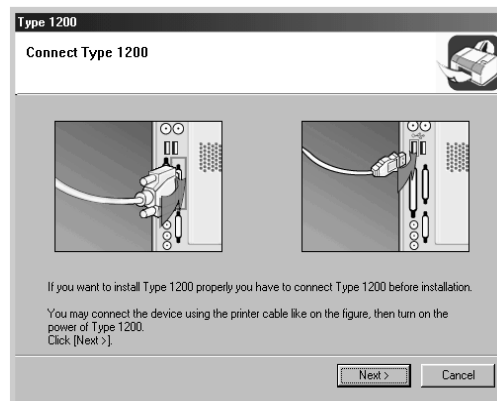

- After connecting the machine, click **Next**.
- If you want to skip the connection status, click Next, and No to the following screen. Then the installation will start and the test page will not be printed at the end of the installation.

2 Choose the installation type.

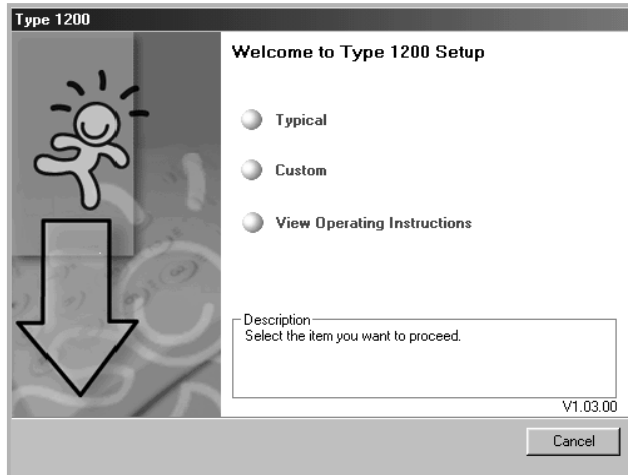

- **Typical:** Installs the common software for your printer, such as printer driver, Twain driver, Remote Control Panel. This is recommended for most users.
- **Custom:** Allows you to choose the language of software and the components you want to install. After selecting the language and the component(s), click **Next**.

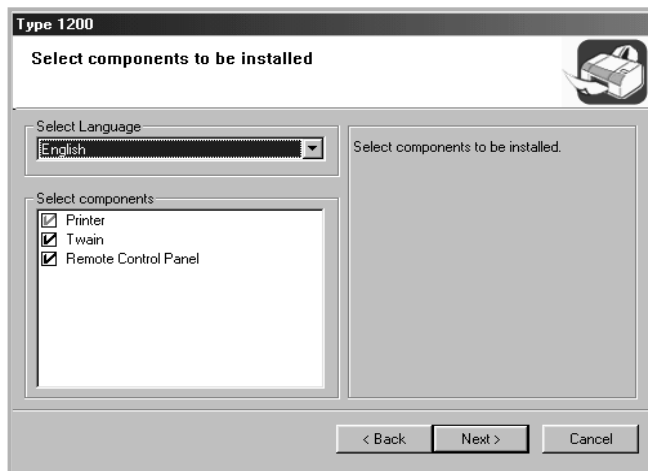

- **View Operating Instructions:** Allows you to view this Operating Instructions. If your computer doesn't have Adobe Acrobat, click on this option and it will automatically install Adobe Acrobat for you.

3 After the installation is finished, the window asking you to print a test page appears. If you choose to print a test page, select the check box and click **Next**.

4 When the test page prints out correctly, click **Yes**. If not, click **No** to reprint it.

5 Click **Finish**.

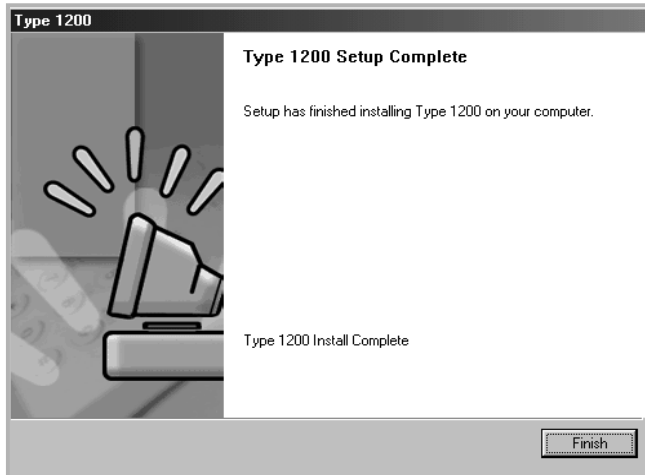

NOTES:

- When you want to use your machine with the parallel cable, remove the USB cable and connect the parallel cable. Then reinstall the printer driver; select **Start** → **Programs** → **Type 1200** → **Maintenance** → **Repair** → **Printer**. If you have replaced the parallel cable with the USB cable, do the same to reinstall the driver.
- If your printer doesn't work properly, reinstall the printer driver.

Repairing Software(for MFP model only)

Repairing is required if your installation fails or software does not work properly.

- 1 You can select **Start** → **Programs** → **Type 1200** → **Maintenance**.

Otherwise, insert the supplied CD-ROM into your CD-ROM drive.

The CD-ROM should automatically run and an maintenance window appears.

If the maintenance window does not appear, click **Start** and then **Run**. Type **X:\Setup.exe**, replacing "X" with the letter of your drive and click **OK**.

- 2 Click **Repair**.



NOTES: If your machine is not connected to the computer, the following window will appear.

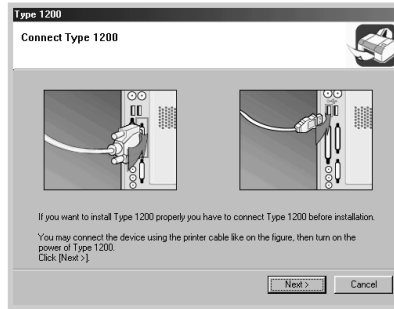

- After connecting the machine, click **Next**.
- If you want to skip the connection status, click Next, and No to the following screen. Then the installation will start and the test page will not be printed at the end of the installation.

3 Select the components you want to reinstall and click **Next**.

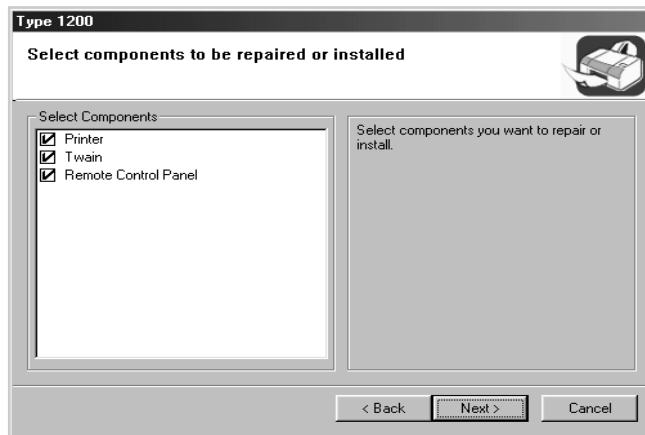

4 After the installation is finished, the window asking you to print a test page appears. If you choose to print a test page, select the check box and click **Next**.

5 When the test page prints out correctly, click **Yes**.
If not, click **No** to reprint it.

6 When the reinstallation is done, click **Finish**.

Removing Software (for MFP model only)

Uninstall is required if you are upgrading software or if your installation fails.

- 1 You can select **Start** → **Programs** → **Type 1200** → **Maintenance**.

Otherwise, insert the supplied CD-ROM into your CD-ROM drive.

The CD-ROM should automatically run and a maintenance window appears.

If the maintenance window does not appear, click **Start** and then **Run**. Type **X:\Setup.exe**, replacing "X" with the letter of your drive and click **OK**.

- 2 Click **Remove**.

Then you will see a component list so that you can remove any of them individually.

If you want to uninstall the printer driver, check **Printer**.

If you want to uninstall the Twain driver, check **Twain**.

If you want to uninstall the Remote Control Panel, check **Remote Control Panel**.

- 3 After selecting items you wish to remove, click **Next**.

- 4 When your computer asks you to confirm your selection, click **Yes**.

The selected driver and all of its components are removed from your computer.

- 5 When the uninstallation is done, click **Finish**.

Setting Up the Machine System

Changing the Display Language

To change the language that displays on the display of the control panel, follow these steps:

- 1** Press **Menu** until "Machine Setup" appears on the top line of the display.
- 2** Press the scroll button (◀ or ▶) until "Language" appears on the bottom line of the display.
- 3** Press **Enter**. The current setting appears on the bottom line of the display.
- 4** Press the scroll button (◀ or ▶) until the language you want appears on the display.
- 5** Press **Enter** to save the selection.
- 6** To return to Standby mode, press **Clear/Stop**.

Setting the Machine ID

In some countries, you are required by law to indicate your fax number on any fax you send. The Machine ID, containing your telephone number and name or company name, will be printed at the top of each page sent from your machine.

- 1 Press **Menu** until "Machine Setup" appears on the top line of the display. The first available menu item, "Machine ID" displays on the bottom line.
- 2 Press **Enter**. The display asks you to enter the fax number.
If there is a number already set, the number appears.
- 3 Enter your fax number using the number keypad.



NOTE: If you make a mistake while entering numbers, press the ◀ button to delete the last digit.

- 4 Press **Enter** when the number on the display is correct. The display asks you to enter the ID.
- 5 Enter your name or company name using the number keypad.

You can enter alphanumeric characters using the number keypad, and include special symbols by pressing the **0** button.

For details on how to use the number keypad to enter alphanumeric characters, see page 1.30.

If you want to enter the same letter or number in succession (e.g. SS, AA, 777), enter one digit, move the cursor by pressing the ▶ button and enter the next digit.



NOTE: When "Id" is printed at the top of each page you transmit, only the first 20 digits can be printed on the pages received at the other end.

If you want to insert a space in the name, you can also use the ▶ button to move the cursor to skip the position.

- 6 Press **Enter** when the name on the display is correct.
- 7 Press **Clear/Stop** to return to Standby mode.

Entering Characters Using the Number Keypad

As you perform various tasks, you need to enter names and numbers. For example, when you set up your machine, you enter your name or your company's name and telephone number. When you store one or two digit speed dial or group dial numbers, you may also enter the corresponding names.

To enter alphanumeric characters:

- 1 When you are prompted to enter a letter, locate the button labeled with the character you want. Press the button until the correct letter appears on the display.

For example, to enter the letter **O**, press **6**, labeled with "MNO."

Each time you press **6**, the display shows a different letter, **M**, **N**, **O** and finally **6**.

You can enter special characters, such as space, plus sign, and so on. For details, see "Keypad Letters and Numbers" on page 1.31.

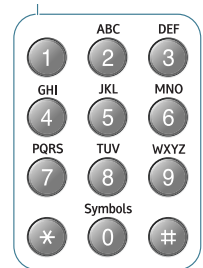

- 2 To enter additional letters, repeat step 1.

If the next letter is printed on the same button, move the cursor by pressing the **▷** button and then press the button labeled with the letter you want. The cursor moves to the right and the next letter appears on the display.

You can enter a space by pressing the **#** button.

- 3 When you finish entering letters, press **Enter**.

Keypad Letters and Numbers

Key	Assigned numbers, letters or characters
1	1 Space
2	A B C 2
3	D E F 3
4	G H I 4
5	J K L 5
6	M N O 6
7	P Q R S 7
8	T U V 8
9	W X Y Z 9
0	+ - , . ' / * # & 0

Changing Numbers or Names

If you make a mistake while entering a number or name, press the \triangleleft button to delete the last digit or character. Then enter the correct numbers or characters.

Inserting a Pause

With some telephone systems, you must dial an access code (9, for example) and listen for a second dial tone. In such cases, you must insert a pause in the telephone number. You can insert a pause while you are setting up one-touch or speed dial numbers.

To insert a pause, press **Redial/Pause** at the appropriate place while entering the telephone number. A "--" appears on the display at the corresponding location.

Setting the Date and Time

The current date and time are shown on the display when your machine is on and ready to work. All of your faxes will have the date and time printed on them.



NOTE: If power to the machine is cut off, you need to reset the correct time and date once the power is restored.

- 1 Press **Menu** until "Machine Setup" appears on the top line of the display.
- 2 Press the scroll button (◀ or ▶) to display "Date & Time" on the bottom line and press **Enter**.
- 3 Enter the correct time and date using the number keypad.
Month = 01 ~ 12
Day = 01 ~ 31
Year = requires all four digits
Hour = 01 ~ 12 (12-hour mode)
00 ~ 23 (24-hour mode)
Minute = 00 ~ 59



NOTE: The date format may differ from each country.

You can also use the scroll button (◀ or ▶) to move the cursor under the digit you want to correct and enter a new number.

- 4 To select "AM" or "PM" for 12-hour format, press the * or # button or any number button.

When the cursor is not under the AM or PM indicator, pressing the * or # button immediately moves the cursor to the indicator.

You can change the clock mode to 24-hour format (e.g. 01:00 PM as 13:00). For details, see page 1.33.

- 5 Press **Enter** when the time and date on the display is correct.

When you enter a wrong number, the machine beeps and does not proceed to the next step. If this happens, just reenter the correct number.

Changing the Clock Mode

You can set your machine to display the current time using either 12-hour or 24-hour format.

- 1 Press **Menu** until "Machine Setup" appears on the top line of the display.
- 2 Press the scroll button (◀ or ▶) until you see "Clock Mode" on the bottom line and press **Enter**.
The clock mode currently set for the machine displays.
- 3 Press the scroll button (◀ or ▶) to select the other mode and then press **Enter** to save the selection.
- 4 To return to Standby mode, press **Clear/Stop**.

Setting the Paper Type and Size

After loading paper in the paper tray, you need to set the paper type and size using the control panel buttons. These settings will apply to Fax and Copy modes. For PC-printing, you need to select the paper type and size in the application program you use.

- 1 Press **Menu**.
The display shows "Paper Setting" on the top line and the first menu item, "Paper Type," on the bottom line.
- 2 Press **Enter** to access the menu item.
- 3 Use the scroll button (◀ or ▶) to find the paper type you are using and press **Enter** to save it.
- 4 Press the ▶ button to scroll to "Paper Size" and press **Enter** to access the menu item.
- 5 Press **Enter** when "Tray Paper" displays on the bottom line.
- 6 Use the scroll button (◀ or ▶) to find the paper size you are using and press **Enter** to save it.
- 7 To return to Standby mode, press **Clear/Stop**.

Setting Sounds

You can control the following sounds:

- **Ringer:** You can adjust the ringer volume.
- **Key Sound:** With this option set to "On," a key tone sounds each time any key is pressed.
- **Alarm Sound:** You can turn the alarm sound on or off. With this option set to "On," an alarm tone sounds when an error occurs or fax communication ends.
- **Speaker:** You can turn on or off the sounds from the telephone line through the speaker, such as a dial tone or a fax tone. With this option set to "Comm.," the speaker is on until the remote machine answers.

You can adjust the speaker volume level using the **On Hook Dial** button or the handset(for America only).

Speaker, Ringer, Key Sound and Alarm Sound

- 1** Press **Menu** until "Sound/Volume" appears on the top line of the display.
- 2** Press the scroll button (◀ or ▶) to scroll through the options. Press **Enter** when you see the sound option you want.
- 3** Press the scroll button (◀ or ▶) to display the status or loudness you want for the option you have selected.

For the ringer volume, you can select from "Off", "Low", "Med" and "High". Setting "Off" means that the ringer turns off. The machine works normally even if the ringer is turned off.

- 4** Press **Enter** to save the selection.
- 5** If necessary, repeat steps 2 through 4.
- 6** To return to Standby mode, press **Clear/Stop**.

Speaker Volume

To adjust the volume using the **On Hook Dial** button:

- 1 Press **On Hook Dial**. A dial tone sounds from the speaker.
- 2 Press the scroll button (◀ or ▶) until you hear the loudness you want. The display shows the current volume level.
- 3 Press **Clear/Stop** to save the change and return to Standby mode.

To adjust the volume using the handset: **(for America only)**

- 1 Pick up the handset. A dial tone sounds from the earpiece.
- 2 Press the scroll button (◀ or ▶) until you find the loudness you want. You can select either "High" or "Low".
- 3 Press **Enter** to save selection and replace the handset.



NOTE: You can adjust the speaker volume only when the telephone line is connected.

Using the Save Mode

Power Save Mode

Power Save mode allows your machine to reduce power consumption when it is not in actual use. You can turn this mode on by selecting the length of time for which the machine waits after a job is printed before it switches to a reduced power state.

- 1** Press **Menu** until "Machine Setup" appears on top line of the display.
- 2** Press the scroll button (◀ or ▶) until "Power Save" appears on the bottom line. Press **Enter**.
- 3** Press the scroll button (◀ or ▶) to display "On" on the bottom line and press **Enter**.

Selecting "Off" means that Power Save mode turns off.

- 4** Press the scroll button (◀ or ▶) until the time settings you want appears.

The available options are 5, 10, 15, 30 and 45 (minutes).

- 5** Press **Enter** to save the selection.
- 6** To return to Standby mode, press **Clear/Stop**.



2

PAPER HANDLING

This chapter introduces you to the basics of selecting print materials and loading them into your machine.

This chapter includes:

- **Selecting Print Materials**
- **Selecting an Output Location**
- **Loading Paper in the Paper Tray**
- **Using the Manual Feeder**

Selecting Print Materials

You can print on a variety of print materials, such as plain paper, envelopes, labels, *transparencies* and so on. Always use print materials that meet the guidelines for use with this machine. See "Paper Specification" on page A.5. To get the best possible print quality, use only high-quality copier-grade paper.

* for MFP model only

When you choose print materials, consider the following:

- Desired outcome: The paper you choose should be appropriate for your project.
- Size: You can use any size paper that fits easily within the paper adjusters of the paper tray.
- Weight: Your machine supports paper weights as follows:
 - 16 ~ 24 lbs (60 ~ 90 g/m²) bond for the paper tray
 - 16 ~ 43 lbs (60 ~ 163 g/m²) bond for the manual feeder
- Brightness: Some papers are whiter than others and produce sharper, more vibrant images.
- Surface smoothness: The smoothness of the paper affects how crisp the printing looks on the paper.



NOTE: Using print materials that do not conform to the specifications listed on page A.5 may cause problems that may require service. This service is not covered by the warranty or service agreements.

Type, Input Sources and Capacities

Paper Type	Input Source/Capacity*	
	Paper Tray	Manual Feeder
Plain paper	250	1
Envelope**	-	1
Labels	-	1
Transparency films	-	1
Card stocks	-	1

* Maximum capacity may be reduced depending on the paper thickness.

** for MFP model only

Guidelines for Paper and Special Materials

When selecting or loading paper, envelopes, or other special material, keep these guidelines in mind:

- Always use paper and other materials that conform with the specifications listed under "Paper Specification" on page A.5.
- Attempting to print on damp, curled, wrinkled, or torn paper can cause paper jams and the poor print quality.
- Use only high quality copier grade paper for the best print quality.
- Avoid paper with embossed lettering, perforations, or a texture that is too smooth or too rough. Paper jams may occur.
- Store paper in its ream wrapper until you are ready to use. Place cartons on pallets or shelves, not on the floor. Do not place heavy objects on top of the paper, whether it is packaged or unpackaged. Keep it away from moisture, or other conditions that can cause it to wrinkle or curl.
- Store unused materials at temperatures between 15 °C and 30 °C (59 °F to 86 °F). The relative humidity should be between 10 % and 70 %.
- During storage, you should use moisture-proof wrap, such as any plastic container or bag, to prevent dust and moisture from contaminating your paper.
- Load special paper types one sheet at a time.
- Only use materials specifically recommended for use in laser printers.
- To prevent special materials, such as transparencies and label sheets from sticking together, remove them as they prints out.
- For envelopes:
 - Use only well-constructed envelopes with sharp, well creased folds.
 - Do not use envelopes with clasps and snaps.
 - Do not use envelopes with windows, coated lining, self-adhesive seals, or other synthetic materials.
 - Do not use damaged or poorly made envelopes.
- For transparencies(for MFP model only):
 - Place them on a flat surface after removing them from the machine.
 - Do not leave them in the paper tray for long periods of time. Dust and dirt may accumulate on them resulting in spotty printing.

- To avoid smudging caused by fingerprints, handle them and coated paper carefully.
- To avoid fading, do not expose the printed transparencies to prolonged sunlight.
- For labels(for MFP model only):
 - Verify that their adhesive material can tolerate fusing temperature of 200 °C (392° F) for 0.1 second.
 - Make sure that there is no exposed adhesive material between them. Exposed areas can cause labels to peel off during printing, which can cause paper jams. Exposed adhesive can also cause damage to machine components.
 - Do not load a sheet of them through the machine more than once. The adhesive backing is designed for one pass through the machine.
 - Do not use labels that are separating from the backing sheet or are wrinkled, bubbled, or otherwise damaged.
- Do not use **Carbonless** paper and **Tracing** paper. They could make smell of chemicals and damage your machine.

Selecting an Output Location

The machine has two output locations; the rear output slot (face up) and the front output tray (face down).

To use the front output tray, make sure that the rear cover is closed. To use the rear output slot, open the rear cover.



NOTES:

- If paper coming out of the front output tray has problems, such as excessive curl, try printing to the rear output slot.
 - To avoid paper jams, do not open or close the rear cover while the machine is printing.
-

Printing to the Front Output Tray *(Face down)*

The front output tray collects printed paper face-down in correct order. The tray should be used for most print jobs.

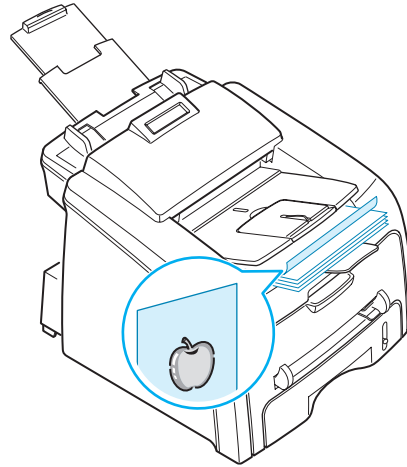

Printing to the Rear Output Slot *(Face up)*

Using the rear output slot, paper comes out of the machine face up.

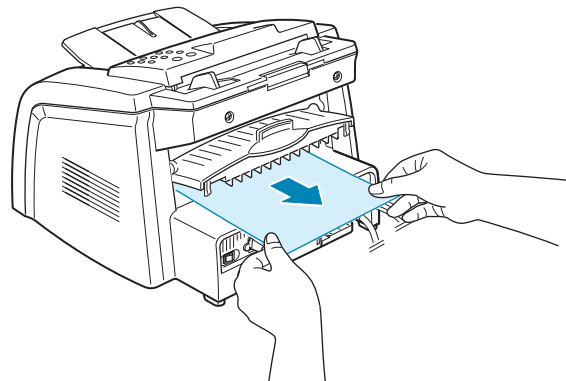

Printing from the manual feeder to the rear output slot provides the **straight paper path**. Using the rear output slot might improve the output quality with the following:

- envelopes
- labels(for MFP model only)
- small custom-sized paper
- postcards
- transparencies(for MFP model only)

To use the rear output slot:

- 1 Open the rear cover by pulling it upward.

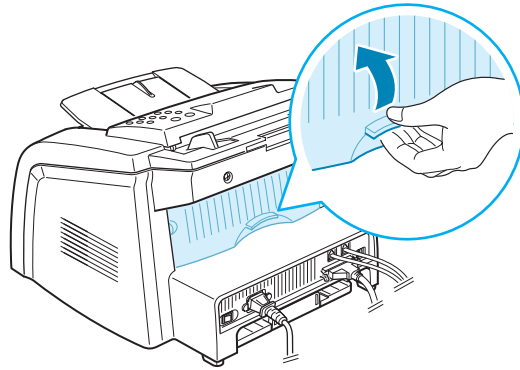

WARNING: The fusing area inside the rear part of your machine becomes hot once the machine is turned on. Be careful when you access this area.

- 2 If you do not want to use the rear output slot, close the rear cover. The pages stack on the front output tray.

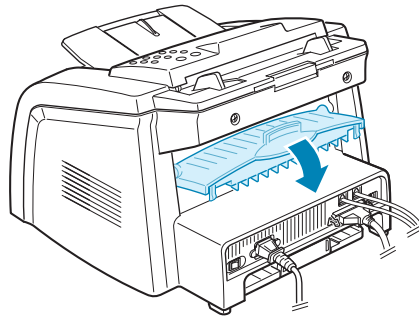

Loading Paper in the Paper Tray

The paper tray can hold a maximum of 250 sheets of 20 lb plain paper. For faxing and copying, you can use A4-, Letter- or Legal-sized paper only. For PC-printing, you can use many different sizes of paper; see page A.5.

The paper level indicator on the front of the paper tray shows the amount of paper currently left in the tray. When the tray is empty, the indicator of the bar is lowered.

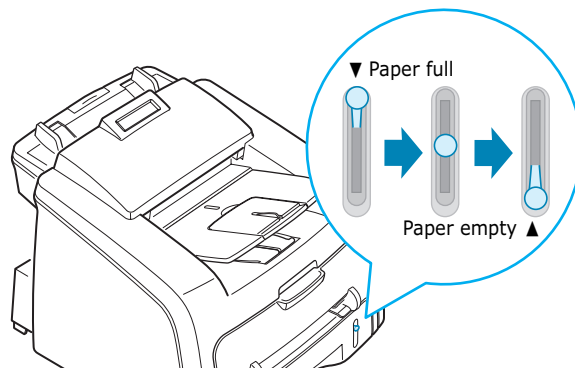

To load paper, pull open the paper tray and load paper with the print side face down.

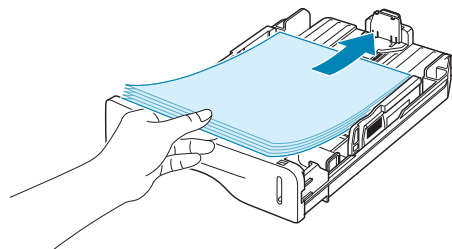

You can load letterhead paper with the design side face down. The top edge of the sheet with the logo should be placed at the front side of the tray.

For details about loading paper in the paper tray, see "Loading Paper" on page 1.13.



NOTES:

- If you experience problems with paper feed, place the paper in the manual feeder.
- You can load up to 150 sheets of previously printed paper. The printed side should be facing up with an uncurled edge at the top side. If you experience problems with paper feed, turn the paper around. Note that the print quality is not guaranteed.

Using the Manual Feeder

Use the manual feeder to print transparencies, labels, envelopes or postcards in addition to making quick runs of paper types or sizes that are not currently loaded in the paper tray.

Postcards, 3.5 by 5.83 in.(index) cards and other custom-sized materials can be printed with this printer. The minimum size is 76 by 127 mm (3.0 by 5.0 in.) and the maximum size is 216 by 356 mm (8.5 by 14 in.)

Acceptable print materials are plain paper with sizes ranging from 100 x 148 mm (3.9 x 5.8 in.) to Legal, 216 x 356 mm (8.5 x 14 in.), the largest size acceptable, and weighing between 16 lb and 32 lb.



NOTES:

- Always load only the print materials specified in the Specifications on page A.5 to avoid paper jams and print quality problems.
 - Flatten any curl on postcards, envelopes and labels before loading them into the manual feeder.
 - When you print on 76 mm X 127 mm (3 X 5 in.) sized media with loading into the tray, open the rear output tray.
-

- 1** Load a sheet of the print material with the print side face up into the center of the manual feeder.

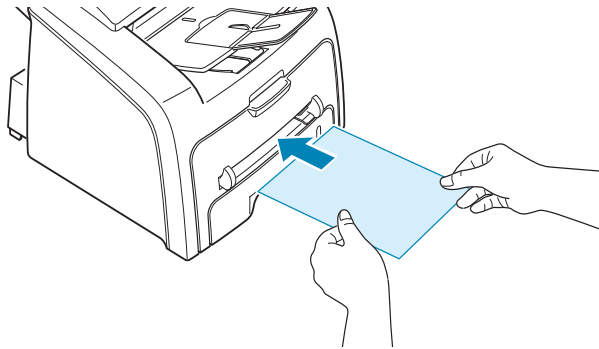

For envelopes, load a sheet with the flap side face down and with the stamp area on the top left side.

For transparencies, hold them by the edges and avoid touching the print side. Oils from your fingers can cause print quality problems.



NOTE: You must open the rear output slot when you print on transparencies. If not, they may tear while exiting the machine.

- 2 Adjust the paper guide to the width of the print material.

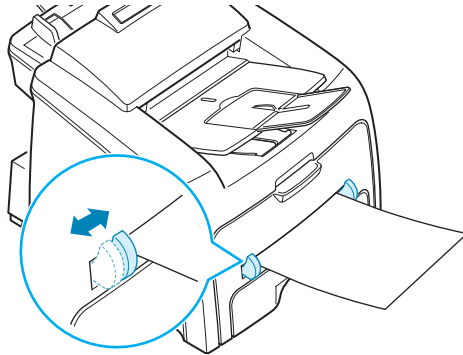

NOTE: When printing on previously printed paper from the manual feeder, the printed side should be facing down with an uncurled edge to the machine. If you experience problems with paper feed, turn the paper around.

- 3 Open the rear cover to use the rear output slot.

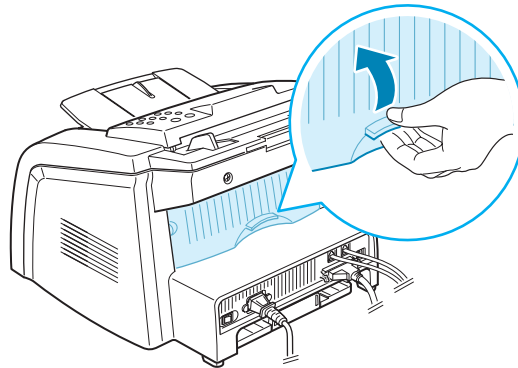

- 4 After printing, close the rear cover.

Setting the Paper Type and Size for the Manual Feeder

After loading paper in the manual feeder, you need to set the correct paper type and size using the control panel buttons. These settings will apply to Copy mode. For PC-printing, you need to select the paper size in the application program you use.

To set the paper size for the manual feeder:

1 Press **Menu**.

The display shows "Paper Setting" on the top line and the first item, "Paper Type," on the bottom line.

2 Press **Enter** to access the menu item.

3 Use the scroll button (◀ or ▶) to find the paper type you are using and press **Enter** to save it.

4 Press the ▶ button to scroll to "Paper Size" and press **Enter** to access the menu item.

5 Use the scroll button (◀ or ▶) to display "Manual Feed" on the bottom line. Press **Enter** to access the menu item.

6 Use the scroll button (◀ or ▶) to find the paper size you are using and press **Enter** to save it.

7 To return to Standby mode, press **Clear/Stop**.



3

COPYING

This chapter gives you step-by-step instructions for copying documents.

This chapter includes:

- **Loading Paper for Copying**
- **Preparing a Document**
- **Making a Copy**
- **Setting Copy Options**
- **Changing the Default Settings**
- **Setting the Time Out Option**
- **Collation Copying**

Loading Paper for Copying

The instructions for loading print materials are the same whether you are printing, faxing or copying. For copying, you can use Letter-, A4-, Legal-sized print materials. For further details, see page 1.13 for loading in the paper tray and page 2.8 for loading in the manual feeder.

Preparing a Document

Using the ADF (Automatic Document Feeder), you can load up to 20 documents (weight: 75 g/m², 20 lb) for one job.

When you use the ADF:

- Do not load documents smaller than 142 x 148 mm or larger than 216 x 356 mm.
- Do not attempt to feed the following types of documents:
 - carbon-paper or carbon-backed paper
 - coated paper
 - onion skin or thin paper
 - wrinkled or creased paper
 - curled or rolled paper
 - torn paper
- Remove all staples and paper clips before loading documents.
- Make sure any glue, ink or correction fluid on the paper is completely dry before loading documents.
- Do not load documents containing different sizes or weights of paper.
- Do not load booklet, pamphlet, transparencies or documents having other unusual characteristics.

Making a Copy

- 1 Pull the document support all the way out. Fold out the extender, if necessary.

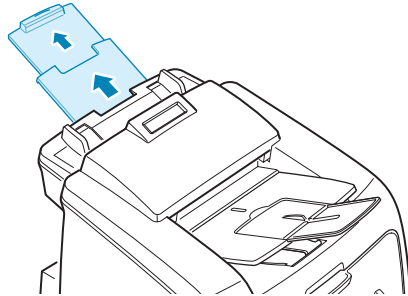

- 2 Load the documents up to 20 pages **face down** into the ADF.

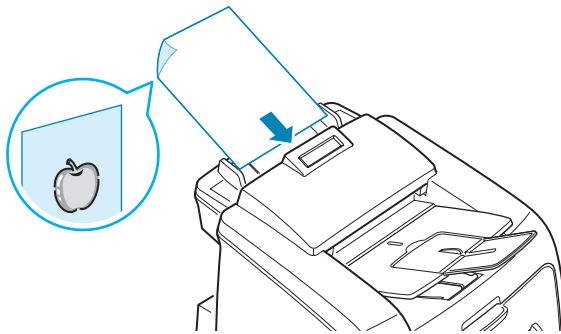

- 3 Adjust the document guides to the document size.

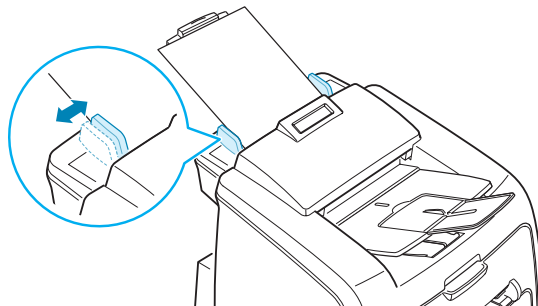

- 4 Customize the copy settings including number of copies, copy size, darkness and image by using the control panel buttons. See "Setting Copy Options" on page 3.4. Sorts the copy job. For example, if you make 2 copies of 3 page documents, one complete 3 page document will print followed by the second complete document. see page 3.8

To clear the settings, use the **Clear/Stop** button.

- 5 Press **Start**.

Setting Copy Options

The buttons on the control panel let you make all the basic copy options; darkness, document type, copy size and number of copies. Set the following options for the current copy job before pressing **Start** to make copies.



NOTE: If you press **Clear/Stop** while you set the copy options, all of the options you have set for the current copy job will be canceled and return to their default status. Or, they will automatically return to their default status after the machine completes the copy.

Darkness

If you have an original document containing faint markings and dark images, you can adjust the brightness to make a copy that is easier to read.

To adjust the contrast, press Darkness . Each time you press the button, the LED labeled with the selected mode turns on.

You can choose from the following darkness modes:

- **Lighten:** works well with dark print.
- **Normal:** works well with standard typed or printed documents.
- **Darken:** works well with light print or faint pencil markings.

Original Type

The image setting is used to improve the copy quality by selecting the document for the current copy job.

To select the document type, press Original Type . Each time you press the button, the LED labeled with the selected mode turns on.

You can choose from the following image modes:

- **Text:** Use for documents containing mostly text.
- **Photo:** Use when the originals are photographs.



NOTE: When you copy a document containing color on the background, such as a newspaper or a catalog, you can get the background on your copy. If you want to reduce the background, change the **Darken** setting to **Lighten** and/or the original Type  setting to **Text**.

3

Number of Copies

Using the **No. of Copies** button, you can select the number of copies from 1 to 99.

- 1 Press **No. of Copies**.
- 2 Press the scroll button (◀ or ▶) until the number you want appears on the display.

Pressing and holding the buttons allows you to quickly increase and decreases in increments of 5.

You can enter the value using the number keypad.

- 3 Press **Enter** to save the selection.

Reduced/Enlarged Copying

Using the **Reduce/Enlarge** button, you can reduce or enlarge the size of a copied image from 50% to 150%.

To select from the predefined copy sizes:

1 Press **Reduce/Enlarge**.

The default setting appears on the bottom line of the display.

2 Use **Reduce/Enlarge** or the scroll button (◀ or ▶) to find the size setting you want.

3 Press **Enter** to save the selection.

To fine-tune the size of copies:

1 Press **Reduce/Enlarge**.

2 Press **Reduce/Enlarge** or the scroll button (◀ or ▶) until "Custom:50-150%" displays on the bottom line. Press **Enter**.

3 Press the scroll button (◀ or ▶) until the copy size you want appears on the display.

Pressing and holding the buttons allows you to quickly increase and decreases in increments of 5.

You can enter the value using the number keypad.

4 Press **Enter** to save the selection.



NOTE: When you make a reduced copy, black lines may appear at the bottom of your copy.

Changing the Default Settings

Copy options, including darkness, image, copy size and number of copies, can be set to the most frequently used modes. When you copy a document, the default settings are used unless they are changed by using the corresponding buttons on the control panel.

To create your own default settings:

- 1 Press **Menu** on the control panel until "Copy Setup" appears on the top line of the display.
The first menu item, "Default-Change", appears on the bottom line.
- 2 Press **Enter** to access the menu item. The first setup option, "Darkness," appears on the bottom line.
- 3 Press the scroll button (◀ or ▶) to scroll through the setup options.
- 4 When the option you want to set appears, press **Enter** to access the option.
- 5 Change the setting using the scroll button (◀ or ▶) or enter the value using the number keypad.
- 6 Press **Enter** to save the selection.
- 7 Repeat steps 3 through 6, as needed.
- 8 To return to Standby mode, press **Clear/Stop**.



NOTE: While you set copy options, pressing **Clear/Stop** cancels the changed settings and restores their default status.

Setting the Time Out Option

You can set the time the machine waits before it restores the default copy settings, if you do not start copying after changing them on the control panel.

- 1 Press **Menu** on the control panel until "Copy Setup" appears on the top line of the display.
- 2 Press the scroll button (◀ or ▶) to display "Timeout" on the bottom line.
- 3 Press **Enter** to access the menu item.
- 4 Press the scroll button (◀ or ▶) until the status you want appears on the display.

You can select from 15, 30, 60 and 180 (seconds).

Selecting "Off" means that the machine does not restore the default settings until you press **Start** to start copying, or **Clear/Stop** to cancel.

- 5 Press **Enter** to save the selection.
- 6 To return to Standby mode, press **Clear/Stop**.

Collation Copying

The Collation copying feature is available only when you load documents in the ADF.

- 1 Press **Menu** on the control panel until "Copy Setup" appears on the top line of the display.
- 2 Press the scroll button (◀ or ▶) to display "Copy Collated" on the bottom line.
- 3 Press **Enter** to access the menu item.
- 4 If you are making multiple copies and want to collate them, press the scroll button (◀ or ▶) to set Collated Copy to "On" and press **Enter**.

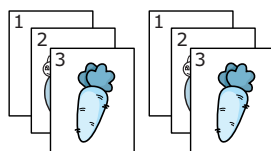

▲ Collated Copy On

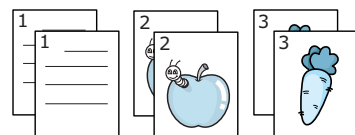

▲ Collated Copy Off

- 5 Press **Start** to begin copying.



4

FAXING

This chapter gives you information about using your machine as a fax machine.

This chapter includes:

- **Sending a Fax**
- **Receiving a Fax**
- **Automatic Dialing**
- **Advanced Fax Functions**
- **Additional Features**

Sending a Fax

Changing the Fax Setup options

- 1** Press **Menu** until "Fax Setup" appears on the top line of the display.

The first available menu item, "Ring To Answer," displays on the bottom line.
- 2** Press the scroll button (◀ or ▶) until the menu item you want on the bottom line and press **Enter**.
- 3** Use the scroll button (◀ or ▶) to find the status or use the number keypad to enter the value for the option you have selected.
- 4** Press **Enter** to save the selection.
- 5** If necessary, repeat steps 2 through 4.
- 6** To return to Standby mode, press **Clear/Stop**.

Available Fax Setup Options

You can use the following setup options for configuring the fax system:

Option	Description
Ring To Answer	You can specify the number of times the machine rings, 1 to 7, before answering an incoming call.
Darkness	You can select the default darkness mode to fax your documents lighter or darker. <ul style="list-style-type: none">• Lighten works well with dark print.• Normal works well with standard typed or printed documents.• Darken works well with light print or faint pencil markings.
Redial Term	Your machine can automatically redial a remote fax machine when the line is busy. Intervals from 1 to 15 minutes can be entered.
Redials	You can specify the number of redial attempts, 0 to 13. If you enter 0 , the machine will not redial.
MSG Confirm	You can set your machine to print a report showing whether the transmission was successful, how many pages were sent, and more. The available options are On , Off and On-Error , which prints only when a transmission is not successful.
Auto Report	A report with detailed information about the previous 50 communications operations, including time and dates. The available options are On or Off .
Auto Reduction	When receiving a document as long as or longer than the paper loaded in the paper tray, the machine can reduce the size of the document to fit the size of paper loaded in the machine. Select On if you want to automatically reduce an incoming page. With this feature set to Off , the machine cannot reduce the document to fit onto one page, the document is divided and printed in actual size on two or more pages.

Option	Description
Discard Size	<p>When receiving a document as long as longer than the paper installed in your machine, you can set the machine to discard any excess at the bottom of the page. If the received page is outside the margin you set, it will print on two sheets of paper at the actual size.</p> <p>When the document is within the margin and the Auto Reduction feature is turned on, the machine reduces the document to fit it onto the appropriate sized paper and discard does not occur. If the Auto Reduction feature is turned off or fails, the data within the margin will be discarded. Settings range from 0 to 30 mm.</p>
Receive Code	<p>The Receive Code allows you to initiate fax reception from an extension phone plugged into the EXT jack on the back of the machine. If you pick up the extension phone and hear fax tones, enter the Receive Code. The Receive Code is preset to *9* at the factory. Settings range from 0 to 9. See page 4.13 for more information about using the code.</p>
DRPD Mode	<p>You can receive a call using the Distinctive Ring Pattern Detection (DRPD) feature which enables a user to use a single telephone line to answer several different telephone numbers. In this menu, you can set the machine to recognize the ring patterns to answer. See page 4.13</p>

-
- 1 Pull the document input support all the way out. Fold out the extender, if necessary.

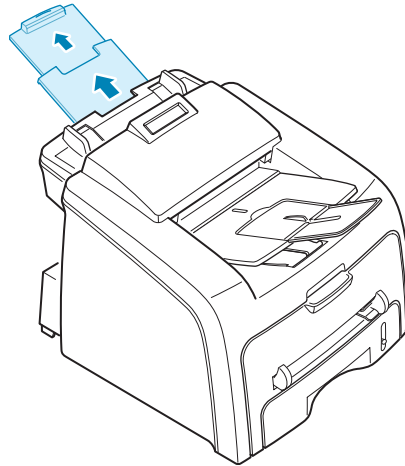

- 2 Load the documents up to 20 pages **face down** into the ADF and adjust the document guides to the document size.

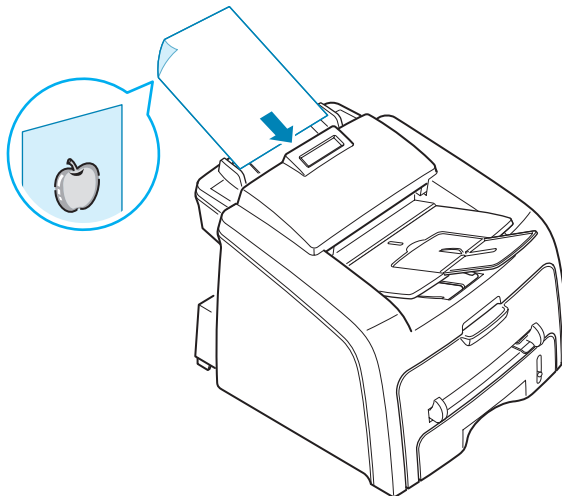

For detailed guidelines for preparing an original document, see page 3.2.

- 3 Adjust the document resolution, referring to page 4.6.

Adjusting the Document Resolution

The default document settings produce good results when setting typical text based documents.

However, if you send documents that are of a poor quality, or contain photographs, you can adjust the resolution to produce a higher quality fax.

- 1 Press **Resolution** on the control panel.
- 2 By pressing **Resolution** or the scroll button (◀ or ▶), you can choose from Standard, Fine, Super Fine and Photo.

The document types recommended for the resolution settings are described in the following table below:

Mode	Recommended for:
Standard	Documents with normal-sized characters.
Fine	Documents containing small characters or thin lines or documents printed using a dot-matrix printer.
Super Fine	Documents containing extremely fine detail. Super Fine mode is enabled only if the remote machine also supports the Super Fine resolution. See the notes below.
Photo	Documents containing shades of gray or photographs.



NOTES:

- For the memory transmission, Super Fine mode is not available. The resolution setting is automatically changed to Fine.
- When your machine is set to Super Fine resolution and the remote fax machine does not support the Super Fine resolution, the machine transmits using the highest resolution mode supported by the remote fax machine.

Sending a Fax Automatically

- 1** Load the document(s) face down into the ADF.
For details about loading a document, see page 4.5.
- 2** Adjust the document resolution to suit your fax needs. See page 4.6.
If you need to change the darkness, see page 4.3.
- 3** Enter the remote fax phone number using the number keypad.
You can use the one-touch keypad or speed or group dial numbers. For details about storing a number, see page 4.9.
- 4** Press **Start**.
The number is dialed and then the machine begins sending the fax when the remote fax machine is ready.



NOTE: When you want to cancel the fax job, press **Clear/Stop** at any time while sending the fax.

Sending a Fax Manually

- 1** Load the document(s) face down into the ADF.
For details about loading a document, see page 4.5.
- 2** Adjust the document resolution to suit your fax needs. See page 4.6.
If you need to change the darkness, see page 4.3.
- 3** Press **On Hook Dial** or lift the handset(for America only).
You hear a dial tone.
- 4** Enter the remote fax machine's fax number using the number keypad.
You can use the one-touch keypad or speed or group dial numbers. For details about storing a number, see page 4.9.
- 5** When you hear a high-pitched fax signal from the remote fax machine, press **Start**.



NOTE: When you want to cancel the fax job, press **Clear/Stop** at any time while sending the fax.

Redialing the Last Number

To redial the last number you dialed:

Press **Redial/Pause**.

If a document is loaded in the ADF, the machine automatically begins to send.

Confirming Transmission

When the last page of your document has been sent successfully, the machine beeps and returns to Standby Mode.

When something goes wrong while sending your fax, an error message appears on the display. For a listing of error messages and their meanings, see page 8.8.

If you receive an error message, press **Clear/Stop** to clear the message and try to send the document again.

You can set your machine to print a confirmation report automatically each time sending a fax is completed. For further details, see the MSG Confirm item on page 4.3.

Automatic Redialing

When the number you have dialed is busy or there is no answer when you send a fax, the machine automatically redials the number every three minutes up to seven times by the factory default settings.

When the display shows “[Retry Redial ?],” press **Enter** to redial the number without waiting. To cancel the automatic redialing, press **Clear/Stop**.

To change the time interval between redials and the number of redial attempts. See page 4.3.

Receiving a Fax

About Receiving Modes

- In **Fax** mode, the machine answers an incoming fax call and immediately goes into the fax reception mode.
- In **Tel** mode, you can receive a fax by picking up the handset(for America only) or pressing **On Hook Dial** (you can hear voice or fax tone from the remote machine) and then pressing **Start** on the control panel of your machine. You can also pick up the handset of the extension phone and then press the remote receive code(for America only); see page 4.13.
- In **Ans/Fax** mode, the answering machine answers an incoming call, and the caller can leave a message on the answering machine. If the fax machine senses a fax tone on the line, the call automatically switches to Fax mode.
- In **DRPD** mode, you can receive a call using the Distinctive Ring Pattern Detection (DRPD) feature. "Distinctive Ring" is a telephone company service which enables a user to use a single telephone line to answer several different telephone numbers. For further details. See page 4.13

The current receiving mode displays when the machine is in Standby mode.

When the memory is full, the receiving mode automatically switches to Tel.



NOTES:

- To use Ans/Fax mode, connect an answering machine to the EXT jack on the back of your machine. see page 1.16.
 - If you do not want other people to view your received documents, you can use Secure Receiving mode. In this mode, all of the received faxes are stored in the memory. For further details, see page 4.29.
-

Loading Paper for Receiving Faxes

The instructions for loading paper in the paper tray are the same whether you are printing, faxing, or copying, except that faxes can only be printed on Letter-, A4- or Legal-sized plain paper. For details about loading paper and setting the paper size in the tray, see page 1.13 and page 1.33.

Receiving Automatically in Fax Mode

Your machine is preset to Fax mode at the factory. If you have changed the receiving mode, take the following steps to receive faxes automatically:

- 1** Press **Receive Mode**.
- 2** Press and hold Receive Mode until "Fax" displays on the bottom line. You may have to repeat this action once or twice, depending on the mode you're in.
- 3** When you receive a fax, the machine answers the call on a specified number of rings and automatically receives the fax.

To change the number of rings, see page 4.3.

Receiving Automatically in Ans/Fax Mode

For using this mode, you must attach an answering machine to the EXT jack on the back of your machine. See page 1.16.

- 1 Press **Receive Mode**.
- 2 Press and hold Receive Mode until "Ans/Fax" displays on the bottom line. You may have to repeat this action once or twice, depending on the mode you're in.
- 3 When you receive a call, the answering machine answers.

If the caller leaves a message, the answering machine stores the message as it would normally. If your machine hears a fax tone on the line, it automatically starts to receive the fax.



NOTES:

- When you have set your machine to Ans/Fax mode and your answering machine is switched off or no answering machine is connected to the EXT jack, your machine automatically goes into Fax mode after a predefined number of rings.
 - If your answering machine has a "user-selectable ring counter," set it to answer incoming calls within 1 ring.
 - If you are in Tel mode, which is receiving faxes manually, when the answering machine is connected to your machine, you must switch off the answering machine, or the outgoing message from the answering machine will interrupt your phone conversation.
-

Receiving Manually in Tel Mode

You can answer calls using the handset(for America only) or the **On Hook Dial** button.

- 1 Press **Receive Mode**.
- 2 Press and hold Receive Mode until "Tel" displays on the bottom line. You may have to repeat this action once or twice, depending on the mode you're in.
- 3 When you receive a fax call, pick up the handset(for America only) or press **On Hook Dial**.
You can hear a fax tone or voice from the remote machine.
- 4 Press **Start** to receive the fax.

The machine begins receiving a fax and returns to Standby Mode when the reception is completed.

Receiving Manually Using Remote Receive Start Code

You can receive a fax from someone you are talking to on the extension telephone without going to the fax machine.

When you receive a call on the extension phone and hear fax tones, press the keys *9* on the extension telephone. The machine receives the document.

Press the buttons slowly in sequence. If you still hear the fax tone from the remote machine, try pressing *9* once again.

9 is the remote receive code preset at the factory. The first and the last asterisks are fixed, but you can change the middle number to whatever you choose. For details about changing the code, see page 4.4.

Receiving Faxes Using the DRPD Mode

“Distinctive Ring” is a telephone company service which enables a user to use a single telephone line to answer several different telephone numbers. The particular number someone uses to call you on is identified by different ringing patterns, which consist of various combinations of long and short ringing sounds. This feature is often used by answering services who answer telephones for many different clients and need to know which number someone is calling in on to properly answer the phone.

Using the Distinctive Ring Pattern Detection feature, your fax machine can “learn” the ring pattern you designate to be answered by the FAX machine. Unless you change it, this ringing pattern will continue to be recognised and answered as a FAX call, and all other ringing patterns will be forwarded to the extension telephone or answering machine plugged into the EXT. jack. You can easily suspend or change Distinctive Ring Pattern Detection at any time.

Before using the Distinctive Ring Pattern Detection option, Distinctive Ring service must be installed on your telephone line by the telephone company. To set up Distinctive Ring Pattern Detection, you will need another telephone line at your location, or someone available to dial your FAX number from outside.

To set up the DRPD mode:

- 1** Press **Menu** until "Fax Setup" appears on the top line of the display.
The first available menu item, "Receive Mode," displays on the bottom line.
- 2** Press the scroll button (◀ or ▶) until you see "DRPD Mode" on the bottom line and press **Enter**.
- 3** When "Set" displays on the bottom line, press **Enter**.
The LCD displays "[Waiting Ring]."
- 4** Call your fax number from another telephone. It is not necessary to place the call from a fax machine.
- 5** When your machine begins to ring, do not answer the call. The machine requires several rings to learn the pattern.
When the machine completes learning, the LCD displays "End DRPD [Setup]."
If the DRPD setup fails, "DRPD Ring Error" appears. Press **Enter** when "DRPD Mode" displays and retry from Step 3.
- 6** To return to Standby Mode, press **Clear/Stop**.

When the DRPD feature is set up, the DRPD option is available in the Receive Mode menu. To receive faxes in the DRPD mode, you need to set the menu to **DRPD**.



NOTES:

- DRPD must be set up again if you re-assign your fax number, or connect the machine to another telephone line.
 - After DRPD has been set up, call your fax number again to verify that the machine answers with a fax tone. Then have a call placed to a different number assigned to that same line to be sure the call is forwarded to the extension telephone or answering machine plugged into the EXT. jack.
-

Receiving Faxes in the Memory

Since your machine is a multi-tasking device, it can receive faxes while you are making copies or printing. If you receive a fax while you are copying or printing, your machine stores incoming faxes in the memory. Then, as soon as you finish copying or printing, the machine automatically prints the fax.

Automatic Dialing

One-touch Dialing

The 20 one-touch buttons on the control panel lets you store frequently-used fax numbers and dial a number automatically with a touch of a button.

Storing a Number for One-touch Dialing

- 1 Press and hold one of the one-touch dial buttons for about 2 seconds.

The display asks you to enter the fax number. "T" signifies that you are assigning a one-touch dial button.

If a number is already stored in the location you chose, the display shows the number to allow you to change it. To start over with another one-touch button, press **Clear/Stop**.

- 2 Enter the number you want to store using the number keypad and press **Enter**.

To insert a pause between numbers, press **Redial/Pause**. A symbol "-" appears on the display.

If you make a mistake while entering a number, press the < button and re-enter the correct number.

- 3 To assign a name to the number, enter the name you want. For details about entering characters, see page 1.30.

If you do not want to assign a name, skip this step.

- 4 Press **Enter** when the name appears correctly or without entering a name.

- 5 To store more numbers, press a one-touch button and repeat steps 2 through 4.

OR

To return to Standby mode, press **Clear/Stop**.

Sending a Fax using a One-touch Number

- 1** Load the document(s) face down into the ADF.
For details about loading a document, see page 4.5.
- 2** Adjust the document resolution to suit your fax needs. See page 4.6.
If you need to change the darkness, see page 4.3.
- 3** Press the one-touch button where you stored a number.
The document scans into the memory.
- 4** The machine dials the fax number stored in the one-touch dial location and the document is sent when the remote fax machine answers.

Speed Dialing

You can store up to 80 frequently-dialed numbers in one or two-digit speed dial locations (0-79).

Storing a Number for Speed Dialing

- 1** Press **Phone Book** on the control panel.
- 2** Press **Phone Book** or the scroll button (◀ or ▶) to display "Store&Edit" on the bottom line of the display. Press **Enter**.
- 3** Press **Enter** when "Speed Dials" appears on the display.
The display prompts you to enter a location number, showing the first available number.
- 4** Enter a one or two-digit speed dial number between 0 and 79, using the number keypad or scroll button (◀ or ▶) and press **Enter**.
If a number is already stored in the location you chose, the display shows the number to allow you to change it. To start over with another speed-dial number, press **Upper Level**.

- 5 Enter the number you want to store using the number keypad and press **Enter**.

To insert a pause between numbers, press **Redial/Pause**. A symbol “-” appears on the display.

- 6 To assign a name to the number, enter the name you want. For details about entering characters, see page 1.30.

OR

If you do not want to assign a name, skip this step.

- 7 Press **Enter** when the name appears correctly or without entering a name.

- 8 To store more fax numbers, repeat steps 4 through 7.

OR

To return to Standby mode, press **Clear/Stop**.

Sending a Fax using a Speed Number

- 1 Feed the document(s) face up into the ADF.

For details about loading a document, see page 4.5.

- 2 Adjust the document resolution to suit your fax needs. See page 4.6.

If you need to change the darkness, see page 4.3.

- 3 Enter the speed dial number.

- For a one-digit speed dial number, press and hold the appropriate digit button.
- For a two-digit speed dial number, press the first digit button and hold the last digit button.

The corresponding entry's name briefly displays.

- 4 The document scans into the memory.

The fax number stored in the speed dial location is automatically dialed. The document is sent when the remote fax machine answers.

Group Dialing

If you frequently send the same document to several destinations, you can create a group of these destinations and set them under a one or two-digit group dial location. This enables you to use a group dial number setting to send the same document to all the destinations in the group.

Setting a Group Dial Number

- 1** Press **Phone Book** on the control panel.
- 2** Press **Phone Book** or the scroll button (◀ or ▶) to display "Store&Edit" on the bottom line of the display. Press **Enter**.
- 3** Press the scroll button (◀ or ▶) to display "Group Dials" on the bottom line and press **Enter**.
- 4** Press **Enter** when "New" displays on the bottom line.

The display prompts you to enter a location number, showing the first available number.
- 5** Enter a group number between 0 and 79 using the number keypad or scroll button (◀ or ▶) and press **Enter**.
- 6** Press a one-touch dial button, or enter a one or two-digit speed number you want to include in the group and press **Enter**.
- 7** When the display confirms the number to be added to the group, press **Enter**.
- 8** Repeat steps 6 and 7 to enter other one-touch dial or speed dial numbers into the group.
- 9** Press **Upper Level** when you have entered all of the numbers. The display prompts you to enter a group ID.

10 To assign a name to the group, enter the name.

OR

If you do not want to assign a name, skip this step.

11 Press **Enter** when the name appears correctly or without entering a name.

12 If you want to assign another group, press **Enter** and repeat from step 5.

OR

To return to Standby mode, press **Clear/Stop**.



NOTE: You cannot include one group dial number in another group dial number.

Editing Group Dial Numbers

You can delete a specific speed dial number from a selected group or add a new number to the selected group.

- 1** Press **Phone Book** on the control panel.
- 2** Press **Phone Book** or the scroll button (◀ or ▶) to display "Store&Edit" on the bottom line of the display. Press **Enter**.
- 3** Press the scroll button (◀ or ▶) to display "Group Dials" on the bottom line and press **Enter**.
- 4** Press the scroll button (◀ or ▶) to display "Edit" on the bottom line and press **Enter**.
- 5** Enter the group number you want to edit and press **Enter**.
- 6** Press a one-touch dial button to enter a speed dial number you want to add or delete.
- 7** When you enter the specific number in the group, the display shows "Delete?."

When you enter a new number, the display shows "Add?."

- 8 Press **Enter** to add or delete the number.
 - 9 To change the group name, press **Upper Level**.
 - 10 Enter a new group name and press **Enter**.
 - 11 If you want to edit another group, press **Enter** and repeat from step 5.
- OR
- To return to Standby mode, press **Clear/Stop**.

Sending a Fax Using Group Dialing (Multi-address Transmission)

You can use group dialing for Broadcasting or Delayed transmissions.

Follow the procedure of the operation (Broadcasting transmission; see page 4.22, Delayed transmission; see page 4.23, Priority transmissionpage 4.25, Delayed RX Polling transmissionpage 4.26). When you come to a step in which the display asks you to enter the remote fax number:

- For a one-digit group number, press and hold the appropriate digit button.
- For a two-digit group number, press the first digit button and hold the last digit button.

You can use only one group number for one operation. Then continue the procedure to complete the operation.

Your machine automatically scans the document loaded in the ADF and then dials each of the numbers included in the group.

Searching for a Number in the Memory

There are two ways to search for a number in the memory. You can either scan from A to Z sequentially, or you can search using the first letter of the name associated with the number.

Searching Sequentially through the Memory

- 1 Press **Phone Book**.
- 2 Press **Enter** when "Search&Dial" appears on the display.
- 3 Press the scroll button (◀ or ▶) to scroll through the memory until the name and number you want to dial display. You can search upwards or downwards through the entire memory in alphabetical order, from A to Z.

While searching through the machine's memory, you can see that each entry is preceded by one of three letters; "T" for one-touch dial, "S" for speed dial or "G" for group dial number. These letters tell you how the number is stored.

- 4 When the name and/or the number you want displays, press **Start** or **Enter** to dial.

Searching with a Particular First Letter

- 1 Press **Phone Book**.
- 2 Press **Enter** when "Search&Dial" appears on the display.
- 3 Press the button labeled with the letter you want to search for. A name beginning with the letter displays.

For example, if you want to find the name "MOBILE," press the **6** button, which is labeled with "MNO."

- 4 Press the scroll button (◀ or ▶) to display the next name.
- 5 When the name and/or the number you want displays, press **Start** or **Enter** to dial.

Printing a Phone Book List

You can check your automatic dial setting by printing a Phone Book list.

- 1 Press **Phone Book**.
- 2 Press **Phone Book** or the scroll button (◀ or ▶) until "Print" appears on the bottom line and press **Enter**.

A list showing your one-touch dial, speed dial and group dial entries prints out.

Advanced Fax Functions

Sending Broadcasting Faxes

Using the **Broadcasting** button on the control panel, you can use the broadcasting fax feature, which allows you to send a document to multiple locations. Documents are automatically stored in the memory and sent to a remote station. After transmission, the documents are automatically erased from the memory.

- 1** Load the document(s) face down into the ADF.

For details about loading a document, see page 4.5.

- 2** Adjust the document resolution to suit your fax needs. See page 4.6.

If you need to change the darkness, see page 4.3.

- 3** Press **Broadcasting** on the control panel.

- 4** Enter the number of the remote machine using the number keypad.

You can use one-touch keypad or speed dial or group dial numbers. For details about storing a number, see page 4.15.

- 5** Press **Enter** to confirm the number. The display asks you to enter another fax number to send the document.



NOTE: The Another No. prompt does not appear if you have added numbers for another broadcasting or delay fax job. You must wait until the job is completed.

- 6** To enter more fax numbers, press **1** to select "Yes" and repeat steps 4 and 5. You can add up to 10 destinations.

Note that you cannot use group dial numbers for another fax number.

- 7 When you finish entering fax numbers, press **2** to select "No" at a Another No. prompt.

The document is scanned into the memory before transmission. The display shows the memory capacity and the number of pages being stored in the memory.

The machine begins sending the document in order of the numbers you entered.

Sending a Delayed Fax

You can set your machine to send a fax at a later time when you will not be present.

- 1 Load the document(s) face down into the ADF.

For details about loading a document, see page 4.5.

- 2 Adjust the document resolution to suit your fax needs. See page 4.6.

If you need to change the darkness, see page 4.3.

- 3 Press **Menu** until "Fax Feature" appears on the top line of the display. The first available menu item, "DelayFax," displays on the bottom line.

- 4 Press **Enter**.

- 5 Enter the number of the remote machine using the number keypad.

You can use one-touch keypad or speed dial or group dial numbers. For details about storing a number, see page 4.15.

- 6 Press **Enter** to confirm the number on the display. The display asks you to enter another fax number to send the document.



NOTE: The Another No. prompt does not appear if you have added numbers for another broadcasting or delay fax job. You must wait until the job is completed.

- 7 To enter more fax numbers, press **1** to select "Yes" and repeat steps 4 and 5. You can add up to 10 destinations.

Note that you cannot use group dial numbers for another fax number.

- 8 When you finish entering fax numbers, press **2** to select "No" at a Another No. prompt.

The display asks you to enter a name.

- 9 To assign a name to the transmission, enter the name. If not, skip this step.

For details on how to enter the name using the number keypad, see page 1.30.

- 10 Press **Enter**.

The display shows the current time and asks you to enter the starting time when the fax is to be sent.

- 11 Enter the time using the number keypad.

To select "AM" or "PM" for 12-hour format, press the * or # button or any number button.

If you set a time earlier than the current time, the document will be sent at that time on the following day.

- 12 Press **Enter** when the starting time displays correctly.

The document is scanned into the memory before transmission. The display shows the memory capacity and the number of pages being stored in the memory.

The machine returns to Standby mode. The display reminds you that you are in Standby mode and that a delayed fax is set.



NOTE: If you want to cancel the delayed transmission, see "Canceling a Scheduled Fax" on page 4.28.

Sending a Priority Fax

Using the Priority Fax feature, a high priority document can be sent ahead of reserved operations. The document is scanned into the memory and transmitted when the current operation is finished. In addition, the priority transmission interrupts a broadcast operation between stations (i.e., when the transmission to station A ends, before transmission to station B begins) or between redial attempts.

- 1 Load the document(s) face down into the ADF.

For details about loading a document, see page 4.5.

- 2 Adjust the document resolution to suit your fax needs. See page 4.6.

If you need to change the darkness, see page 4.3.

- 3 Press **Menu** until "Fax Feature" appears on the top line of the display.

- 4 Press the scroll button (◀ or ▶) to display "Priority Fax" on the bottom line and press **Enter**.

- 5 Enter the number of the remote machine using the number keypad.

To enter the number, you can use one-touch keypad or speed dial or group dial numbers. For details, see page 4.15.

- 6 Press **Enter** to confirm the number. The display asks you to enter a name.

- 7 To assign a name to the transmission, enter the name. If not, skip this step.

For details on how to enter a name using the number keypad, see page 1.30.

- 8 Press **Enter**.

The document is scanned into the memory before transmission. The display shows the memory capacity and the number of pages being stored in the memory.

The machine shows the number being dialed and begins sending the document.

Polling a Remote Machine

Polling is used when one fax machine requests another to send a document. This is useful when the person with the original document to be sent is not in the office. The person who wants to receive the document calls the machine holding it and requests that the document be sent. In other words, it "polls" the machine holding the original document.

You can set the machine to automatically receive documents from the unattended remote fax machine at any time. This feature permits unattended polling in the evening hours when telephone rates are lower.



NOTE: The machine must be ready for polling.

- 1 Press **Menu** until "Fax Feature" appears on the top line of the display.
- 2 Press the scroll button (◀ or ▶) to display "Delay Rx Poll" on the bottom line and press **Enter**.
- 3 Enter the number of the remote machine to be polled using the number keypad.

To enter the number, you can use a one-touch keypad or speed dial number. For details, see page 4.15.

- 4 Press **Enter** to confirm the number on the display. The display asks you to enter another fax number.



NOTE: The Another No. prompt does not appear if you have added numbers for another broadcasting or delay fax job. You must wait until the job is completed.

- 5 To enter more fax numbers, press **1** to select "Yes" and repeat steps 4 and 5. You can add up to 10 destinations.

Note that you cannot use group dial numbers for another fax number.

- 6 When you finish entering fax numbers, press **2** to select "No" at a Another No. prompt.
- 7 Enter the time using the number keypad.

To select "AM" or "PM" for 12-hour format, press the * or # button or any number button.

If you set a time earlier than the current time, your machine will poll at that time on the following day.

- 8 When the remote machine is secured with a 4-digit poll code, enter the correct code and press **Enter**.

If not, press **Enter** to accept "0000" which represents no code, or enter **0000**.

- 9 Press **Enter** when the starting time displays correctly.

At the specified time, the machine will dial the numbers in the order you entered and receive documents from the remote machines.

Adding Documents to a Scheduled Fax

You can add documents to the delayed transmission previously reserved in your machine's memory.

- 1 Load the document(s) face down into the ADF.
For details about loading a document, see page 4.5.
- 2 Adjust the document resolution to suit your fax needs. See page 4.6.
If you need to change the darkness, see page 4.3.
- 3 Press **Menu** until "Fax Feature" appears on the top line of the display.
- 4 Press the scroll button (◀ or ▶) to display "Add Page" on the bottom line and press **Enter**.
The display shows the last job reserved in the memory.
- 5 Press the scroll button (◀ or ▶) until you see the fax job to which you want to add documents and press **Enter**.

The machine automatically stores the documents in the memory, and the display shows the memory capacity and the number of pages.

After storing, the machine displays the numbers of total pages and added pages and then returns to Standby mode.

Canceling a Scheduled Fax

- 1** Press **Menu** until "Fax Feature" appears on the top line of the display.
- 2** Press the scroll button (◀ or ▶) to display "Cancel Job" and press **Enter**. The display shows the last job reserved in the memory.
- 3** Press the scroll button (◀ or ▶) until you see the fax job you want to cancel, and press **Enter**.
- 4** When the display confirms your selection, press **1** to select "Yes." The selected job is canceled and the machine returns to Standby mode.

To cancel your selection, press **2** to select "No."

Additional Features

Using Secure Receiving Mode

You may need to prevent your received faxes from being accessed by unauthorized people. You can turn on Secure Receiving mode to restrict printing out all of the received faxes when the machine is unattended. In Secure Receiving mode, all of the incoming faxes go into the memory. When the mode turns off, any faxes stored are printed.

To turn Secure Receiving mode on:

- 1 Press **Menu** until "Advanced Fax" appears on the top line of the display.
- 2 Press the scroll button (◀ or ▶) until "Secure Receive" appears on the bottom line and press **Enter**.
- 3 Press the scroll button (◀ or ▶) to display "On" on the bottom line and press **Enter**.
- 4 Enter a four-digit passcode you want to use and press **Enter**.



NOTE: You can activate Secure Receiving mode without setting a passcode, but cannot protect your faxes.

- 5 Re-enter the passcode to confirm it and press **Enter**.
- 6 To return to Standby mode, press **Clear/Stop**.

When a fax is received in Secure Receiving mode, your machine stores it into the memory and displays "Secure Receive" to let you know that there is a fax stored.

To print received documents:

- 1** Access the Secure Receive menu by following steps 1 and 2 on page 4.29.
- 2** Press the scroll button (◀ or ▶) to display "Print" on the bottom line and press **Enter**.
- 3** Enter the four-digit passcode and press **Enter**.

The machine prints all of the faxes stored in the memory.

To turn Secure Receiving mode off:

- 1** Access the Secure Receive menu by following steps 1 and 2 on page 4.29.
- 2** Press the scroll button (◀ or ▶) to display "Off" on the bottom line and press **Enter**.
- 3** Enter the four-digit passcode and press **Enter**.

The mode is deactivated and the machine prints all of the faxes stored in the memory.

- 4** To return to Standby mode, press **Clear/Stop**.

Printing Reports

Your machine can print reports containing useful information. The following reports are available:

Phone Book List

This list shows all of the numbers currently stored in the machine's memory as speed dial and group dial numbers.

You can print this Phone Book list using the **Phone Book** button; see page 4.21.

Sent Fax Report

This report shows information of the faxes you recently sent.

Received Fax Report

This report shows information of the faxes you recently received.

System Data List

This list shows the status of the user-selectable options. You may print this list to confirm your changes after changing any settings.

Scheduled Job Information

This list shows the document currently stored for Delayed faxes . The list shows the starting time and type of operation.

Message Confirmation

This report shows the fax number, the number of pages, the elapsed time of the job, the communication mode, and the communication results.

You can set up your machine to automatically print the message confirmation report after each fax job. See page 4.3.

Junk Fax Number List

This list shows up to 10 fax numbers specified as the junk fax numbers by using the Junk Fax Setup menu; see page 4.34.

When the Junk Fax Barrier feature is turned on, incoming faxes from those numbers are blocked.

This feature recognize the last 6 digits of the fax number set as a remote fax machine's ID.

Multi-communication Report

This report is printed automatically after sending documents from more than one location.

Power Failure Report

This report is printed out automatically when power is restored after a power failure, if there occurs any data loss due to the power failure.



NOTE: The lists you have set to print out automatically don't print out when there is no paper loaded or a paper jam has occurred.

Printing a Report

- 1** Press **Menu** until "Reports" appears on the top line of the display. The first available menu item, "Phone Book" displays on the bottom line.
- 2** Press the scroll button (◀ or ▶) to display the report or list you want to print on the bottom line.
 - Phone Book: Phone Book list
 - Sent Report: Sent fax report
 - RCV Report: Received fax report
 - System Data: System data list
 - Scheduled Jobs: Scheduled job information
 - MSG Confirm: Message confirmation
 - Junk Fax List: Junk fax number list
- 3** Press **Enter**.

The selected information prints out.

Using Advanced Fax Settings

Your machine has various user-selectable setting options for sending or receiving faxes. These options are preset at the factory, but you may need to change them. To find out how the options are currently set, print the System Data list. For details about printing the list, see page 4.31

Changing Setting Options

- 1** Press **Menu** until "Advanced Fax" appears on the top line of the display. The first available menu item, "Send Forward," displays on the bottom line.
- 2** Press the scroll button (◀ or ▶) until you see the desired menu item on the bottom line and press **Enter**.
- 3** When the option you want appears on the display, choose a status by pressing the scroll button (◀ or ▶) or enter a value using the number keypad.
- 4** Press **Enter** to save the selection.
- 5** You can exit from Setup mode at any time by pressing **Clear/Stop**.

Advanced Fax Setting Options

Option	Description
Send Forward	<p>You can set the machine to always forward all of the outgoing faxes to a specified destination, in addition to the fax numbers you entered.</p> <p>Select Off to turn this feature off. Select On to turn this feature on. You can set the number of the remote fax machine to which faxes are forwarded.</p>
RCV Forward	<p>You can set your machine to forward incoming faxes to another fax number during a specified period of time. When a fax arrives at your machine, it is stored in the memory. Then, the machine dials the fax number that you have specified and sends the fax.</p> <p>Select Off to turn this feature off. Select On to turn this feature on. You can set the fax number to which faxes are forwarded. Then, you can enter the starting time and/or the ending time. The Print Local Copy option allows you to set the machine to print the fax, if fax forwarding is completed without any error.</p>
Junk Fax Setup	<p>Using the Junk Fax Barrier feature, the system will not accept faxes sent from remote stations of which their numbers are stored in the memory as junk fax numbers. This feature is useful for blocking any unwanted faxes.</p> <p>Select Off to turn the feature off. Anybody can send you a fax. Select On to turn the feature on. You can set up to 10 fax numbers as junk fax numbers using the Set option. This feature recognize the last 6 digits of the fax number set as a remote fax machine's ID. After storing numbers, you do not receive any faxes from the registered stations. To delete all the junk fax numbers, use the All Delete option.</p>
Secure Receive	<p>You can keep your received faxes from being accessed by unauthorized people.</p> <p>For further details about setting this mode, see page 4.29.</p>
Prefix Dial No.	<p>You can set a prefix dial number of up to five digits. This number dials before any automatic dial number is started. It is useful for accessing the PABX exchange.</p>

Option	Description
Stamp RCV Name	<p>This option allows the machine to automatically print the page number, and the date and time of the reception at the bottom of each page of a received document.</p> <p>Select Off to turn this feature off. Select On to turn this feature on.</p>
ECM Mode (Error Correction Mode)	<p>Error Correction Mode helps with poor line quality and makes sure any fax you send are sent smoothly to any other ECM-equipped fax machine. If the line quality is poor, it takes more time to send a fax when you are using the ECM mode.</p> <p>Select Off to turn this feature off. Select On to turn this feature on.</p>

Using the Remote Control Panel (for MFP model only)

Using the Remote Control Panel, you can create and edit Phone Book entries or update the firmware program of your machine on the desktop of your computer.

When you install software, the Remote Control Panel program is automatically installed.

For information about installing software, see page 1.20.

To open the Remote Control Panel:

- 1 Start your Windows.
- 2 From the **Start** menu, select **Programs**.
- 3 Select **Type 1200** and then **Remote Control Panel**.

The Remote Control Panel program opens.

- 4 The Remote Control Panel window provides the two tabs; **Phone Book** and **Firmware Update**.

To exit, click the **Exit** button at the bottom of each tab.

For further details, click the **Help** button at the bottom of each tab.

The Phone Book Tab

Click the **Phone Book** tab to create and edit Phone Book entries.

Reads the Phone Book entries from the machine to the Remote Control Panel.

Downloads the Phone Book entries from the Remote Control Panel to the machine.

Shows Phone Book entries

Allows you to edit the selected Phone Book entry in a separate Edit window.

Deletes the selected Phone Book entry.

Deletes all Phone Book entries.

Allows you to set up group dial numbers. See below.

The screenshot shows the 'Remote Control Panel' window with the 'Phonebook' tab selected. It features a 'Type' section with radio buttons for 'One touch dial (1 ~ 20)' and 'Speed dial (0 ~ 79)'. Below this is a table with columns 'No.', 'Name', and 'Phone Number'. At the bottom, there are buttons for 'Read', 'Write', 'Edit', 'Delete', 'Delete All', 'Group dial...', 'Exit', and 'Help'.

When you click **Group Dial**, the following window opens.

Enter a name for the group.

Shows the numbers included in the group. To remove a number, select it and click **Remove**.

Shows the Phone Book entries you can include in the group. After selecting a number, click **Add** to move it to the Included numbers list.

Click to save the group dial number after adding or removing numbers for the group.

The 'Group dial' dialog box contains a 'Name' text field, 'Remove (>>)' and 'Add (<<)' buttons, and two list boxes: 'Included numbers' and 'Available numbers'. The 'Available numbers' list has a 'Type' dropdown menu set to 'Speed dial'. At the bottom are 'OK' and 'Cancel' buttons.

The Firmware Update Tab

Click the **Firmware Update** tab to update the firmware of your machine. This feature should be used by an authorized technician. Please consult with the purchase point.

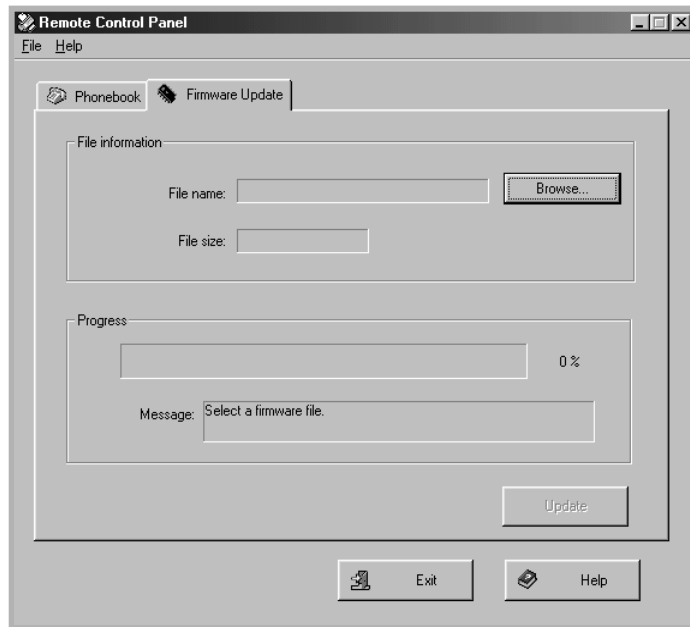

5

PRINTING

(for MFP model only)

This chapter explains how to print your documents in Windows and how to use the print settings.

This chapter includes:

- **Printing a Document in Windows**
- **Setting Paper Properties**
- **Setting Graphic Properties**
- **Printing Multiple Pages on One Sheet of the Paper**
- **Printing a Reduced or Enlarged Document**
- **Fitting Your Document to a Selected Paper Size**
- **Printing Posters**
- **Using Watermarks**
- **Using Overlays**
- **Setting Up the Locally Shared Printer**

Printing a Document in Windows

The following procedure describes the general steps required for printing from various Windows applications. The exact steps for printing a document may vary depending on the application program you are using. Refer to your software application's user's guide for the exact printing procedure.

- 1 Open the document you want to print.
- 2 Select **Print** from the **File** menu.

The Print window opens. It may look slightly different depending on your application.

You can select the basic print settings within the Print window. These settings include the number of copies and the print range.

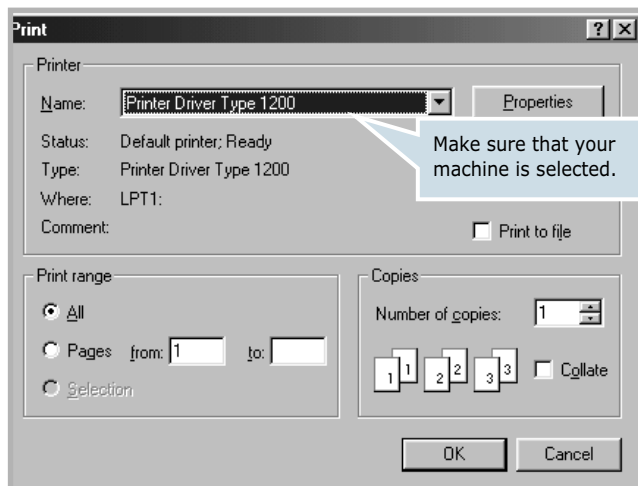

▲ Windows 98

- 3 To take advantage of the printer features provided by your machine, click **Properties** or **Preferences** in the application's print window and go to step 4.

If you see a **Setup, Printer** or **Options** button, click it instead. Then click **Properties** on the next screen.

- 4 Now you see the Printer Driver Type 1200 Properties window, which allows you to access all of information you need when using your machine.

The **Layout** tab first displays.

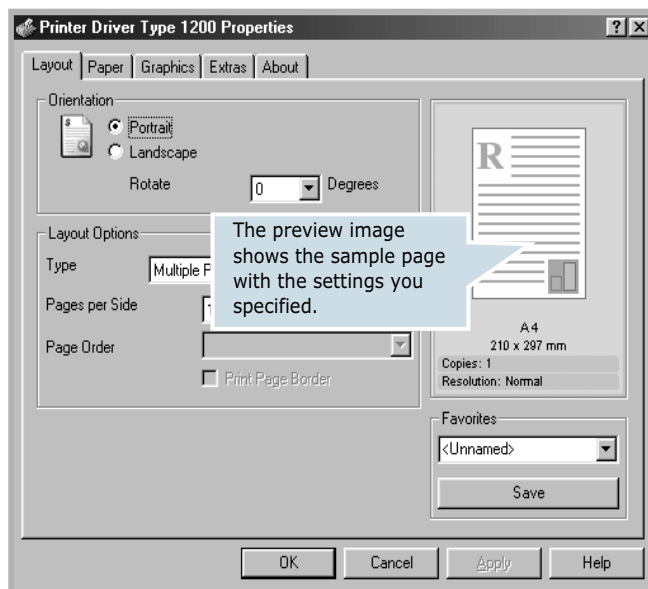

5

If necessary, select the **Orientation** option.

The **Orientation** option allows you to select the direction in which information is printed on a page.

- **Portrait** prints across the width of the page, letter style.
- **Landscape** prints across the length of the page, spreadsheet style.
- If you want to turn the page upside down, select **180** from the **Rotate** drop-down list.



▲ Landscape



▲ Portrait

- 5 From the **Paper** tab, select the paper source, size and type. For further details, see page 5.7.
- 6 If necessary, you can set the sequence for the pages to print from the **Extra** tab. Select the print order you want to use from the **Print Order** drop-down list.

- **Normal:** Your machine prints from the first page to the last page.
 - **Reverse All Pages:** Your machine prints from the last page to the first page.
 - **Print Odd Pages:** Your machine prints only the odd pages of the document.
 - **Print Even Pages:** Your machine prints only the even pages of the document.
- 7 Click other tabs on the top of the Printer Driver Type 1200 Properties window to access other features, if needed.
 - 8 When you finish setting the properties, click **OK** until the Print window displays.
 - 9 Click **OK** to start printing.

The printer's Properties window may differ, depending on your operating system. This Operating Instructions shows the Properties window on windows 98



Notes:

- Most Windows applications overrides the settings you specified in the printer driver. Change all of the print settings available in software application first, and change any remaining settings using the printer driver.
 - The settings you change remain in effect only while you are using the current program. To make your changes permanent, make them in the **Printers** folder. Follow these steps:
 1. Click the Windows **Start** menu.
 2. For Windows 95/98/Me/NT 4.0/2000, select **Settings** and then **Printers**.
For Windows XP, select **Printers and Faxes**.
 3. Select the **Printer Driver Type 1200** printer.
 4. Click the right mouse button on the printer icon and:
 - For Windows 95/98/Me, select **Properties**.
 - For Windows 2000/XP, select **Printing Preferences**.
 - For Windows NT 4.0, select **Document Default**.
 5. Change the settings on each tab and click **OK**.
-

Canceling a Print Job

There are two ways to cancel a print job:

To stop a print job from the control panel:

Press the **Clear/Stop** button.

Your machine finishes printing the page that is moving through the machine and deletes the rest of the print job. Pressing the button cancels only the current job. If more than one print job is in the machine's memory, you need to press the button once for each job.

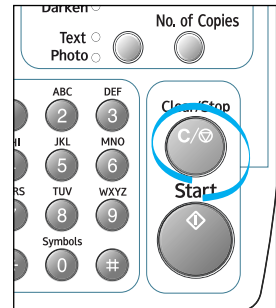

5

To stop a print job from the Printers folder:

If the print job is waiting in a print queue or print spooler, such as the Printer group in Windows, delete the job as follows:

- 1 Click the Windows **Start** menu.
- 2 For Windows 9x/NT4.0/2000/Me, Select **Settings** and then **Printers**.
For Windows XP, select **Printers and Faxes**.
- 3 Double-click the **Printer Driver Type 1200** icon.
- 4 From the **Document** menu:
For Windows 9x/Me, select **Cancel Printing**.
For Windows NT4.0/2000/XP, select **Cancel**.

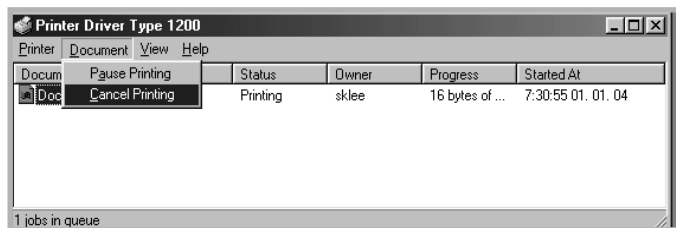

▲ Windows 98



NOTE: You can access this window simply by double-clicking the printer icon at the bottom right corner of the Windows desktop.

Using a Favorite Setting

The **Favorites** option, which is visible on each tab, allows you to save the current properties settings for future use.

To save a Favorites item:

- 1 Change the settings on each tab, as needed.
- 2 Enter a name for the item in the **Favorites** input box.

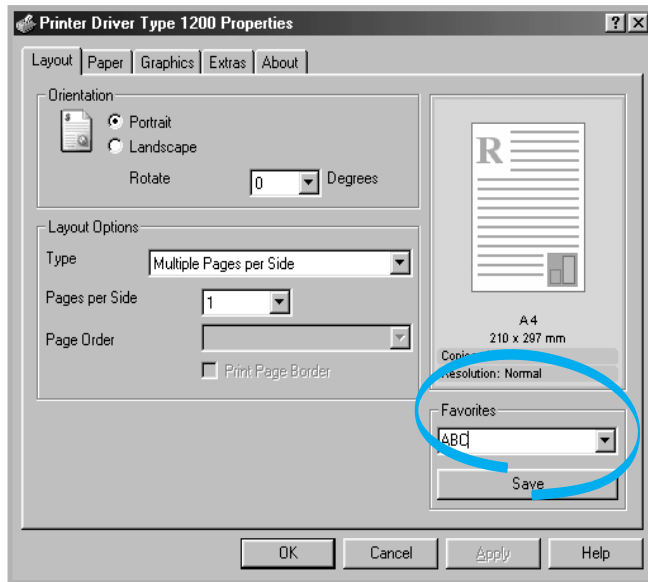

- 3 Click **Save**.

To use a saved setting, select it from the **Favorites** drop-down list. To delete a favorite setting item, select it from the list and click **Delete**.

You can also restore the printer driver's default settings by selecting **<Printer Default>** from the list.

Using Help

Your machine has a help screen that can be activated using the **Help** button in the printer's Properties window. The help screen gives detailed information about the printer features provided by the printer driver.

You can also click **?** in the upper right hand corner, and then click on any setting.

Setting Paper Properties

Use the following options for paper handling. See page 5.2 for more information about accessing printer's Properties.

Click the **Paper** tab to access many paper properties.

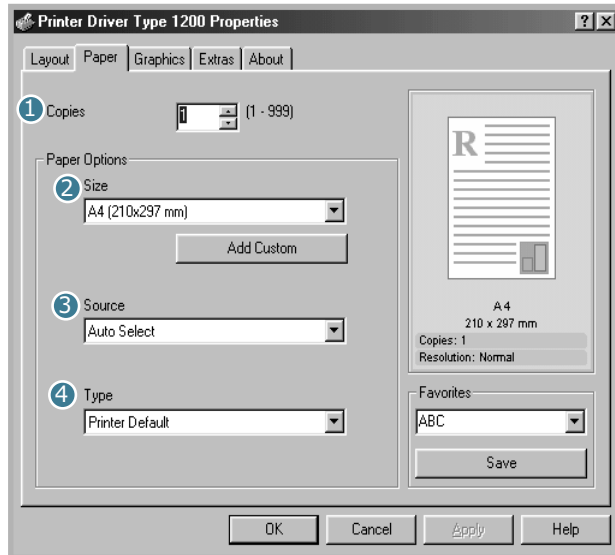

5

Property	Description
1 Copies	Copies allows you to choose the number of copies to be printed. You can enter up to 999.
2 Size	<p>Size allows you to choose the size of the paper loaded in the tray.</p> <p>If the required size is not listed in the Size box, click Add Custom. When the Custom Page Size window appears, set the size and click Ok. The setting appears on the list so that you can select it.</p> <p>Enter the custom name you want to use.</p> <p>Enter the paper size.</p>

Property	Description
<p>③ Source</p>	<p>Make sure that Source is set to the corresponding paper tray.</p> <p>Use the Manual Feed source when printing to special material. You need to load one sheet at a time into the manual feeder. See page 2.8.</p> <p>If the paper source is set to Auto Select, the machine automatically picks up print material in the following order: the manual feeder and the paper tray.</p>
<p>④ Type</p>	<p>Make sure that Type is set to Printer Default. If you load a different type of print material, select the corresponding paper type. For more information about print materials, see Chapter 2, Paper Handling.</p> <p>If you use cotton paper, set the paper type to Thick for the best printing.</p> <p>To use recycled paper, which weighs from 75g/m² to 90g/m² (20lb to 24lb), or colored paper, select Color Paper.</p>

Setting Graphic Properties

Use the following graphic options to adjust the print quality for your specific printing needs. See page 5.2 for more information about accessing printer properties.

Click the **Graphics** tab to display the properties shown below.

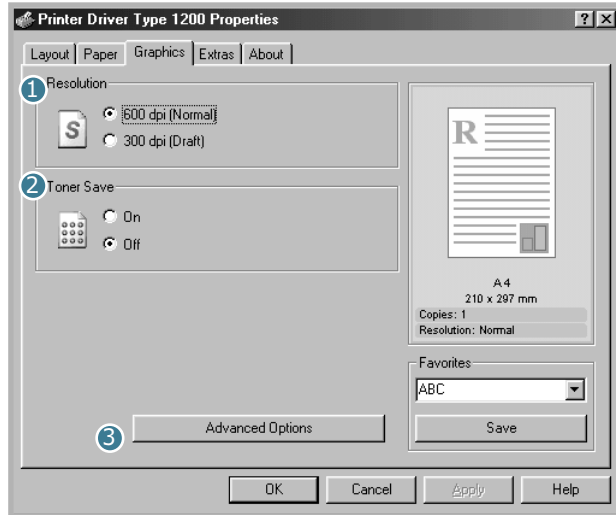

Property	Description
1 Resolution	You can select the printing resolution by choosing from 600 dpi (Normal) or 300 dpi (Draft) . The higher the setting, the sharper the printed characters and graphics. Higher settings may increase the time it takes to print a document.
2 Toner Save	Selecting this option extends the life of your toner cartridge and reduces your cost per page without a significant reduction in the print quality. <ul style="list-style-type: none">• On: Select this option to allow the machine to use less toner on each page.• Off: When you do not need to save toner to print a document, select this option.

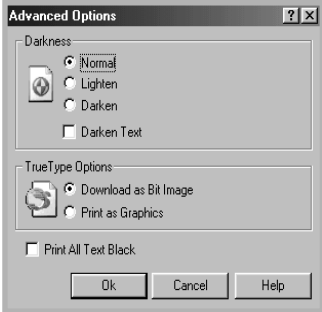
Property	Description
<p>3 Advanced Options</p>	<p>You can make advanced settings by clicking the Advanced Options button.</p>  <p>Darkness</p> <p>Use this option to lighten or darken the image appearance in your print.</p> <ul style="list-style-type: none"> • Normal: This setting is for normal documents. • Lighten: This setting is for bolder line widths or darker grayscale images. • Dark: This setting is for finer line width, higher definition in graphics and lighter grayscale images. <p>When the Darken Text option is checked, all text in your document is allowed to print darker than a normal document (Applicable only to DBCS¹ Windows such as Chinese, Japanese and Korean).</p> <hr/> <p><i>1 DBCS stands for Double Byte Character Set.</i></p>

Property	Description
<p>3 Advanced Options (continued)</p>	<p>True Type Options(for Win9x/Me only) This option determines what the driver tells the machine about how to image the text in your document. Select the appropriate setting according to the status of your document.</p> <ul style="list-style-type: none"> • Download as Bit Image: When this option is selected, the driver downloads the font data as bitmap images. Documents with complicated fonts, such as Korean or Chinese, or various types of fonts print faster in this setting. • Print as Graphics: When this option is selected, the driver downloads any fonts as graphics. When printing documents with high graphic content and relatively few TrueType fonts, printing performance (speed) may be enhanced in this setting. <p>Print All Text Black When the Print All Text Black option is checked, all text in your document prints in solid black, regardless of the color it appears on the screen. When it is not checked, colored text prints in shades of gray.</p>

Printing Multiple Pages on One Sheet of the Paper

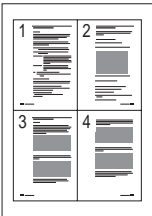

You can select the number of pages to print on a single sheet of paper. To print more than one page per sheet, the pages are smaller and arranged in the order you specified on the sheet. You can print up to 16 pages on one sheet.

- 1 To change the print settings from your software application, access the printer's Properties. See page 5.2.
- 2 From the **Layout** tab, choose **Multiple Pages per Side** from the **Type** drop-down list.

- 3 Select the number of pages you want to print per sheet (1, 2, 4, 9 or 16) on the **Pages per Side** drop-down list.

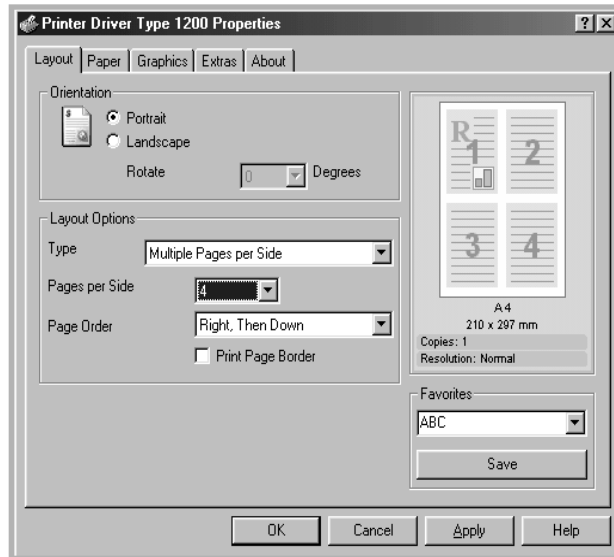

- 4 Select the page order on the **Page Order** drop-down list, if necessary.

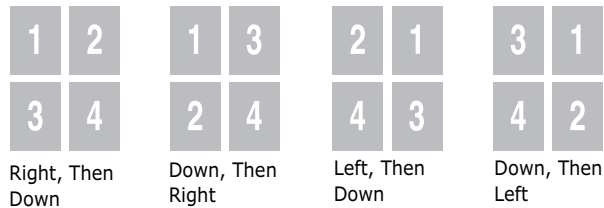

Check **Print Page Border** to print a border around each page on the sheet.



NOTE: Page Order and Print Page Border are enabled only when the number of pages per side is 2, 4, 9 or 16.

- 5 Click the **Paper** tab and select the paper source, size and type.
- 6 Click **OK** and print the document.

Printing a Reduced or Enlarged Document

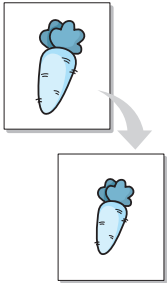

You can scale your print job on a page.

- 1 When you change the print settings from your software application, access the printer's Properties. See page 5.2.
- 2 From the **Layout** tab, select **Reduce/Enlarge** on the **Type** drop-down list.
- 3 Enter the scaling rate in the **Percentage** input box.

You can also click the ▲ or ▼ button.

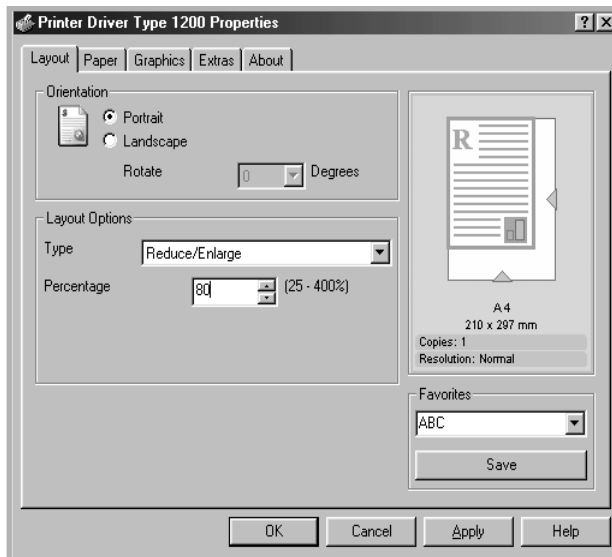

- 4 Click the **Paper** tab and select the paper source, size and type.
- 5 Click **OK** and print the document.

Fitting Your Document to a Selected Paper Size

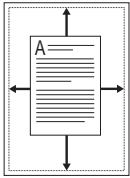

You can scale your print job to any paper size regardless of the digital document size. This can be useful when you want to check the fine details on a small document.

- 1 When you change the print settings from your software application, access the printer's Properties. See page 5.2.
- 2 From the **Layout** tab, select **Fit to Page** on the **Type** drop-down list.
- 3 Select the correct size from the **Target Page** drop-down list.

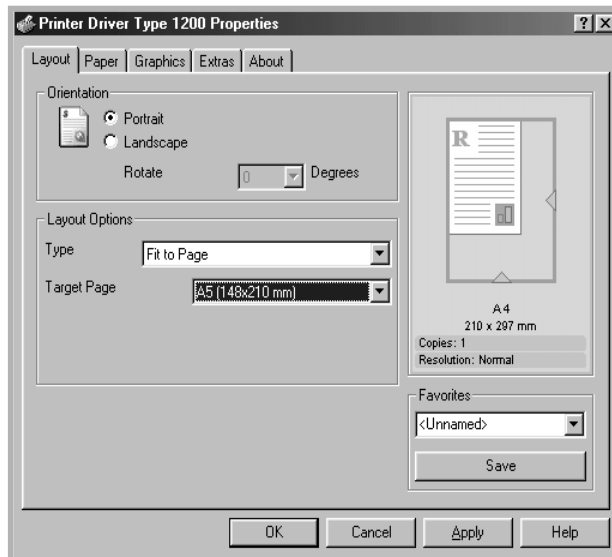

- 4 Click the **Paper** tab and select the paper source and type.
- 5 Click **OK** and print the document.

0.15 inches

Printing Posters

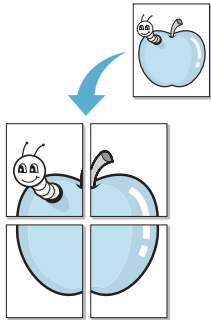

You can print a single-page document onto 4, 9 or 16 sheets of paper, for the purpose of pasting the sheets together to form one poster-sized document.

- 1 When you change the print settings from your software application, access the printer's Properties. See page 5.2.
- 2 From the **Layout** tab, select **Poster** on the **Type** drop-down list.

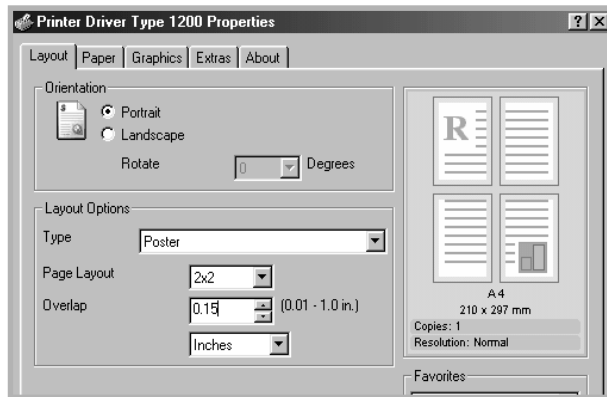

- 3 Configure the poster option:

You can select the page layout from **2x2**, **3x3** or **4x4**. If you select **2x2**, the image is automatically stretched to cover 4 physical pages.

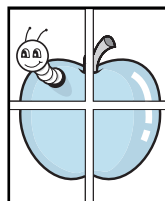

▲ 2 x 2

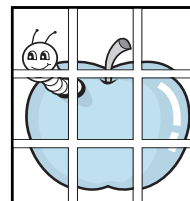

▲ 3 x 3

Specify an overlap in millimeters or inches to make it easier to reconstruct the resulting poster.

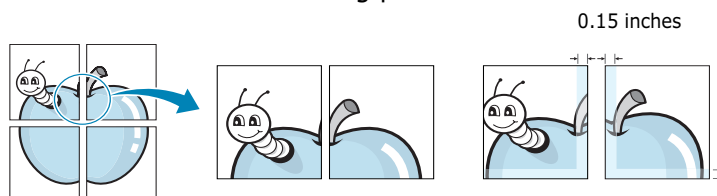

- 4 Click the **Paper** tab and select the paper source, size and type.
- 5 Click **OK** and print the document. You can complete the poster by posting the sheets together.

Using Watermarks



The Watermark option allows you to print text over an existing document. For example, you may want to have large gray letters reading "DRAFT" or "CONFIDENTIAL" printed diagonally across the first page or all of the pages of a document.

There are several predefined watermarks that come with your machine, and they can be modified or you can add new ones to the list.

Using an Existing Watermark

- 1 When you change the print settings from your software application, access the printer's Properties. See page 5.2.
- 2 Click the **Extras** tab and select a watermark on the **Watermark** drop-down list. It appears in the preview image window.

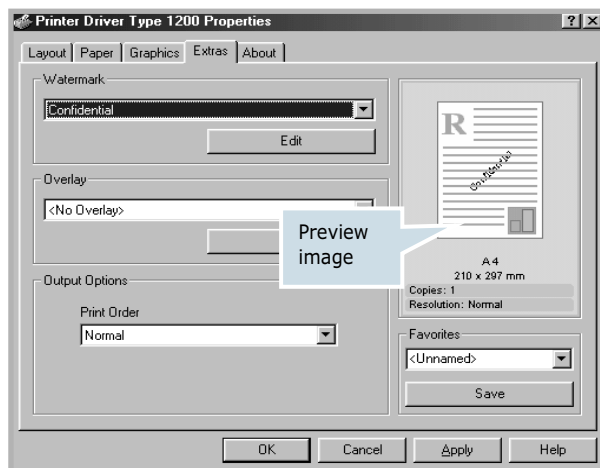

- 3 Click **Ok** and start printing.

Creating a Watermark

- 1 When you change the print settings from your software application, access the printer's Properties. See page 5.2.
- 2 Click the **Extras** tab and click **Edit** in the **Watermark** section. The Edit Watermarks window appears.

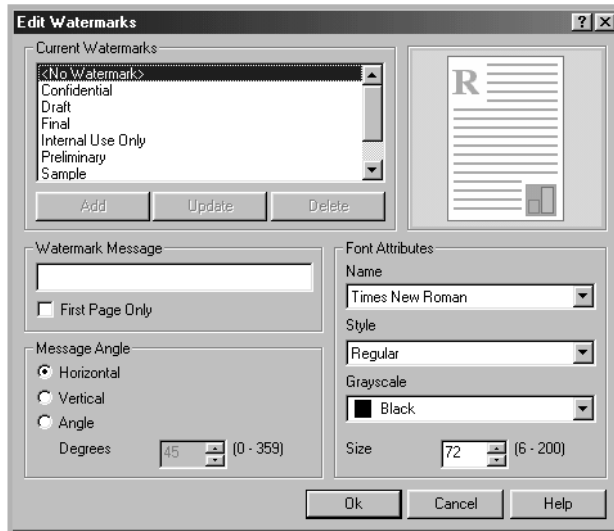

- 3 Enter text message you want to print in the **Watermark Message** box.

The message displays in the preview image window.

When the **First Page Only** box is checked, the watermark prints on the first page only.

- 4 Select the watermark options.

You can select the font name, style and size and gray scale level from the **Font Attributes** section and set the angle of the watermark from the **Message Angle** section.

- 5 Click **Add** to add a new watermark to the list.
- 6 When you finish creating, click **Ok** and start printing.

To stop printing the watermark, select **<No Watermark>** on the **Watermark** drop-down list.

Editing a Watermark

- 1 When you change the print settings from your software application, access the printer properties. See page 5.2.
- 2 Click the **Extras** tab and click **Edit** in the **Watermark** section. The Edit Watermarks window appears.
- 3 Select the watermark you want to edit on the **Current Watermarks** list, to change the watermark message and the options. Refer to page 5.17.
- 4 Click **Update** to save the changes.
- 5 Click **Ok**.

Deleting a Watermark

- 1 When you change the print settings from your software application, access the printer's Properties. See page 5.2.
- 2 From the **Extras** tab, click **Edit** in the **Watermark** section. The Edit Watermarks window appears.
- 3 Select the watermark you want to delete on the **Current Watermarks** list and click **Delete**.
- 4 When a confirming message window appears, click **Yes**.
- 5 Click **Ok**.

Using Overlays

What is an Overlay?

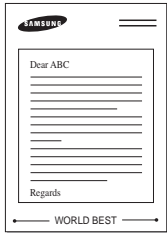

An overlay is text and/or images stored on the computer hard disk drive (HDD) as a special file format that can be printed on any document. Overlays are often used to take the place of preprinted forms and letterhead paper. Rather than using preprinted letterhead, you can create an overlay containing the exact same information that is currently on your letterhead. To print a letter with your company's letterhead, you need only tell the machine to print the letterhead overlay on your document.

Creating a New Page Overlay

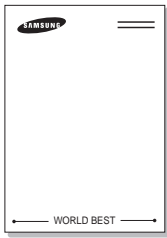

To use a page overlay, you must create a new page overlay containing your logo or image.

- 1 Create or open a document containing text or an image for use in a new page overlay. Position the items exactly as you wish them to appear when printed as an overlay. If needed, save the file for later use.
- 2 When you change the print settings from your software application, access the printer's Properties. See page 5.2.
- 3 Click the **Extras** tab and click **Edit** in the **Overlay** section.

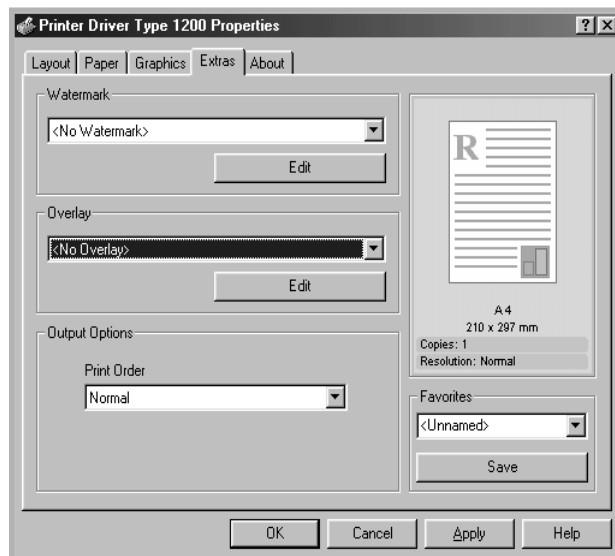

- 4 In the Edit Overlays window, click **Create Overlay**.

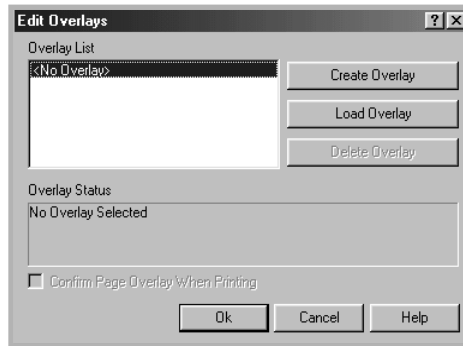

- 5 In the Create Overlay window, type a name of up to eight characters in the **File name** box. Select the destination path, if necessary. (The default is C:\Formover).

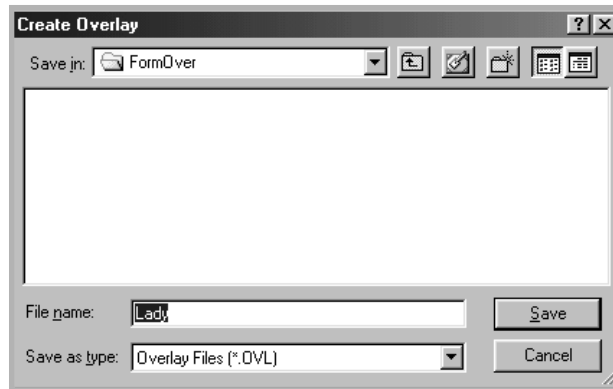

- 6 Click **Save**. The name appears on the Overlay List.
- 7 Click **Ok** or **Yes** to finish creating.

The file is not printed out. Instead it is stored in your computer HDD disk.



NOTE: The overlay document size must be the same as the documents you print with the overlay. Do not create an overlay with a watermark.

Using a Page Overlay

After an overlay has been created, it is ready to be printed with your document. To print an overlay with a document:

- 1 Create or open the document you want to print.
- 2 When you change the print settings from your software application, access the printer's Properties. See page 5.2.
- 3 Click the **Extras** tab.
- 4 Select the overlay you want to print from the **Overlay** drop-down list box.
- 5 When the overlay file you want doesn't appear on the Overlay List, click **Edit** and **Load Overlay**, and select the overlay file.

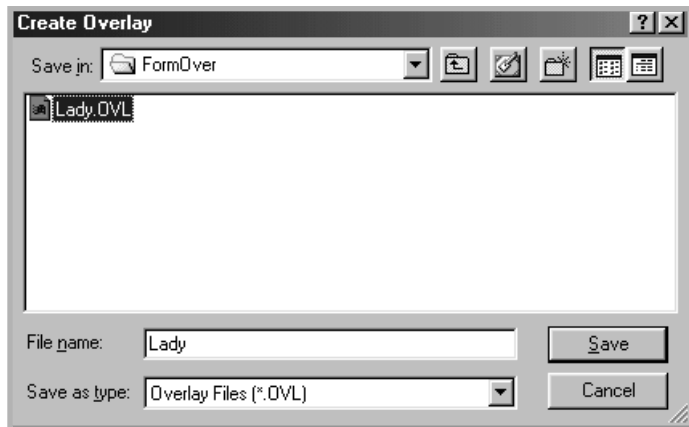

If you have stored the overlay file you want to use in an external source, you can also load the file when you access this Load Overlay window.

After you select the file, click **Open**. The file appears on the Overlay List and is available for printing. Select the overlay from the **Overlay List** box.

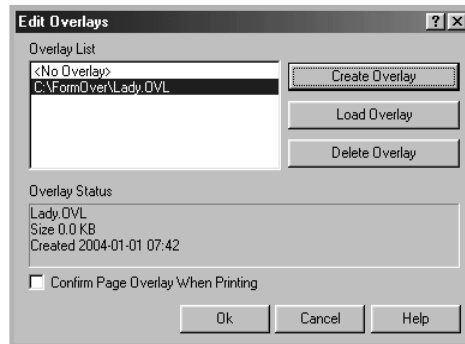

- 6 If necessary, click **Confirm Page Overlay When Printing**. When this box is checked, a message window appears each time you submit a document for printing, asking you to confirm your wish to print an overlay on your document.

Answering **Yes** to the window means that the selected overlay prints with your document. Answering **No** to the window cancels overlay printing.

If this box is empty and an overlay has been selected, the overlay will be automatically printed with your document.

- 7 Click **OK** or **Yes** until the printing starts.

The overlay downloads with your print job and prints on your document.



NOTE: The resolution of the overlay document must be the same as that of the document you will print with the overlay.

Deleting a Page Overlay

You can delete page overlays that you no longer use.

- 1** In the printer's properties window, click the **Extras** tab.
- 2** Click **Edit** in the Overlay section.
- 3** Select the overlay you want to delete from the Overlay List box.
- 4** Click **Delete Overlay**.
- 5** When a confirming message window appears, click **Yes**.
- 6** Click **OK** until you exit the Print window.

Setting Up the Locally Shared Printer

You can connect the machine directly to a selected computer, which is called "host computer," on the network. Your machine can be shared by other users on the network through a Windows 9x, Me, 2000, XP or NT 4.0 network printer connection.



NOTE: Whether the printer is locally connected or network-connected, you need to install the printer software on each computer that will print documents to the printer.

In Windows 9x/Me

Setting Up the Host Computer

- 1 Start Windows.
- 2 From the **Start** menu, select **Control Panel** and double-click on the **Network** icon.
- 3 Check the **File and Print Sharing** box and click **OK**.
- 4 Click **Start** and select **Printers** from **Settings**. Double-click your printer icon.
- 5 Select **Properties** in the **Printer** menu.
- 6 Click the **Sharing** tab and check the **Shared As** box. Fill in the **Share Name** field and then click **OK**.

Setting Up the Client Computer

- 1 Right-click **Start** and select **Explorer**.
- 2 Open your network folder in the left column.
- 3 Right-click the shared name and select **Capture Printer Port**.
- 4 Select the port you want, check the **Reconnect at log on** box and then click **OK**.

- 5 From the **Start** menu, select **Settings** and then **Printers**.
- 6 Double-click your printer icon.
- 7 From the **Printer** menu, select **Properties**.
- 8 From the **Details** tab, select the printer port and click **OK**.

In Windows NT 4.0/2000/XP

5

Setting Up the Host Computer

- 1 Start Windows.
- 2 For Windows NT 4.0/2000, from the **Start** menu, select **Settings** and then **Printers**.
For Windows XP, from the **Start** menu, select **Printers and Faxes**.
- 3 Double-click your printer icon.
- 4 From the **Printer** menu, select **Sharing**.
- 5 For Windows NT 4.0, check the **Shared** box.
For Windows 2000, check the **Shared As** box.
For Windows XP, check the **Share this printer** box.
- 6 For Windows NT 4.0, fill in the **Share Name** field and click **OK**.
For Windows 2000/XP, fill in the **Shared Name** field and click **OK**.

Setting Up the Client Computer

- 1 Right-click **Start** and select **Explorer**.
- 2 Open your network folder in the left column.
- 3 Click the shared name.
- 4 For Windows NT 4.0/2000, from the **Start** menu, select **Settings** and **Printers**.
For Windows XP, from the **Start** menu, select **Printers and Faxes**.
- 5 Double-click your printer icon.
- 6 From the **Printer** menu, select **Properties**.
- 7 Press the **Ports** tab and click **Add Port**.
- 8 Select **Local Port** and click **New Port**.
- 9 Fill in the **Enter a port name** field and enter the shared name.
- 10 Click **OK** and click **Close**.
- 11 For Windows NT 4.0, click **OK**.
For Windows 2000/XP, click **Apply** and click **OK**.



6

SCANNING

(for MFP model only)

Scanning with your machine lets you turn pictures and text into digital files on your computer. Then you can fax or e-mail the files, display them on your web site or use them to create projects that you can print software.

This chapter includes:

- **Scanning Basics**
- **Scanning Process with TWAIN-enabled Software**

Scanning Basics

Your machine offers a following way to begin scanning:

- From TWAIN-compliant software: You can use other software including Adobe PhotoDeluxe and Adobe Photoshop.



NOTES:

- To scan with your machine, you must install the Type 1200 Driver.
 - Scanning is done through the same LPT or USB port currently assigned for your printer port.
-

Scanning Process with TWAIN-enabled Software

If you want to scan documents using other software, you will need to use TWAIN-compliant software, such as Adobe PhotoDeluxe or Adobe Photoshop. The first time you scan with your machine, select it as your TWAIN source in the application you use.

The basic scanning process involves a number of steps:

- Place your photograph or page in the ADF.
- Open an application, such as PhotoDeluxe or Photoshop.
- Open the TWAIN window and set the scan options.
- Scan and save your scanned image.

You need to follow the program's instructions for acquiring an image. Please refer to the operating instructions of the application.



7

MAINTENANCE

This chapter provides information for maintaining your machine and the toner cartridge.

This chapter includes:

- **Clearing the Memory**
- **Adjusting Shading**
- **Cleaning Your Machine**
- **Maintaining the Toner Cartridge**

Clearing the Memory

You can selectively clear information stored in your machine's memory.

- 1 Press **Menu** on the control panel until "Maintenance" appears on the top line of the display.
- 2 Press the scroll button (◀ or ▶) until you see "Clear Memory" on the bottom line and press **Enter**

The first available menu item, "Clear All Mem." displays on the bottom line.

- 3 Press the scroll button (◀ or ▶) until you see the item you want to clear.
 - Clear All Mem.: Clears all of the data stored in the memory and resets all of your settings to the factory default.
 - Paper Setting: Restores all of the Paper Setting options to the factory default.
 - Copy Setup: Restores all of the Copy Setup options to the factory default.
 - Fax Setup: Restores all of the Fax Setup options to the factory default.
 - Fax Feature: Cancels all of the scheduled fax jobs in the machine's memory.
 - Advanced Fax: Restores all of the Advanced Fax setting options to the factory default.
 - Sound/Volume: Resets the sound and volume settings to the factory default.
 - Machine Setup: Resets all of the system settings, such as the machine ID, date and time, display language and save modes, to the factory default.
 - Sent Report: Clears all of records of your faxes sent.
 - RCV Report: Clears all of records of your faxes received.
 - Phone Book: Clears the one-touch, speed and group dial numbers stored in the memory.
- 4 Press **Enter**. The selected memory is cleared and the display asks you to continue clearing the next item.
- 5 To clear another item, press **Enter** and repeat steps 3 and 4

OR

To return to Standby mode, press **Clear/Stop**.

Adjusting Shading

When the scan unit becomes dirty, it can alter the shading value. If your copy has black lines or is blurred, adjust the shading setting.

- 1 Load a sheet of white paper into the ADF.
- 2 Press **Menu** on the control panel until "Maintenance" appears on the top line of the display.
- 3 Press the scroll button (◀ or ▶) until "Adjust Shading " appears on the bottom line and press **Enter**.
- 4 Press the scroll button (◀ or ▶) to select "On" and press **Enter**.

Your machine picks up the paper and adjusts the shading value.

Cleaning Your Machine

To maintain the print quality, follow the cleaning procedures below each time the toner cartridge is replaced or if print quality problems occur.



NOTES:

- While cleaning the inside of the machine, be careful not to touch the transfer roller, located underneath the toner cartridge. Oil from your fingers can cause print quality problems.
- Cleaning the cabinet of the machine with surfactants containing large amounts of alcohol, solvent or other strong substances can discolor or crack the cabinet.
- Keep the machine away from flammable liquids, gases, and aerosols. A fire or an electric shock might occur.

Cleaning the Outside

Clean the cabinet of the machine with a soft lint-free cloth. You can dampen the cloth slightly with water, but be careful not to let any water drip onto the machine or inside of it.

Cleaning the Inside

During the printing process, paper, toner and dust particles can accumulate inside the machine. This buildup can cause print quality problems, such as toner specks or smearing. Cleaning the inside of the machine clears or reduces these problems.

- 1 Turn the machine off and unplug the power cord. Wait for the machine to cool down.
- 2 Open the front cover and pull the toner cartridge out, lightly pushing it down.

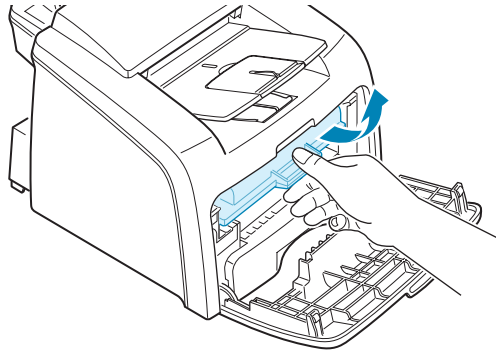

- 3 With a dry lint-free cloth, wipe away any dust and spilled toner from the toner cartridge area and the toner cartridge cavity.

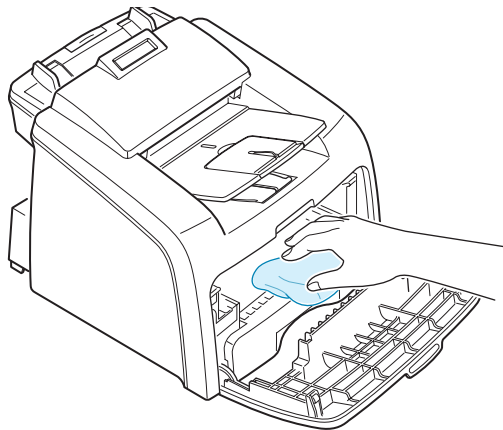

NOTE: To prevent damage to the toner cartridge, do not expose it to light for more than a few minutes. Cover it with a piece of paper, if necessary. Do not touch the black transfer roller inside the machine.

- 4 Reinsert the toner cartridge and close the cover.
- 5 Plug in the power cord and turn the machine on.

Cleaning the Scan Unit

Keeping the scan unit clean helps ensure the best possible copies. We suggest that you clean the scan unit at the start of each day and during the day, as needed.

- 1 Slightly dampen a soft lint-free cloth or paper towel with water.
- 2 Open the control panel by gripping its bottom and pulling it upward.

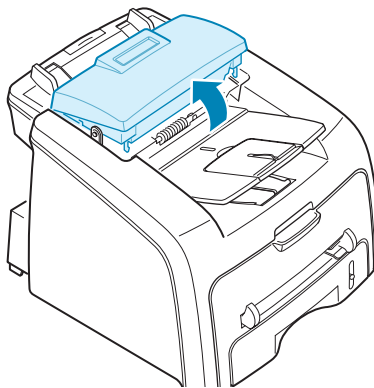

- 3 Disassemble the white roller as follows:

The right end of the white roller has a plastic bushing that is snapped shut with small tab on it. Pull the bushing slightly inward, then rotate the bushing until it reach a slot (①). Then pull the roller upward (②).

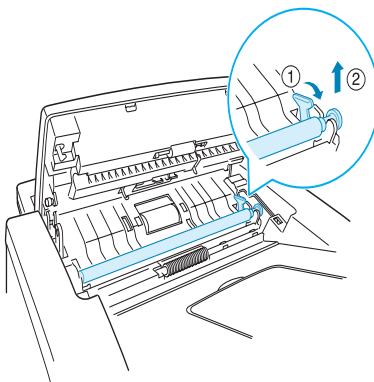

- 4 Wipe the roller surface with a soft cloth dampened with water.

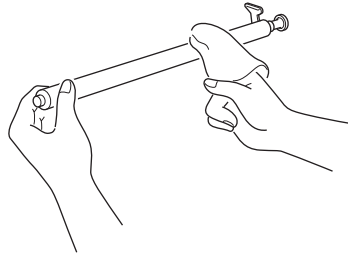

- 5 Carefully wipe the scanning glass with a soft dry cloth.

If the glass is very dirty, first wipe it with a slightly dampened cloth, and then with a dry cloth. Be very careful not to scratch the glass surface.

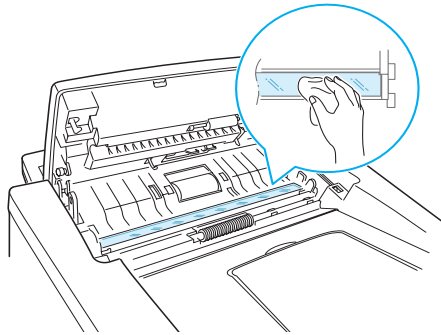

- 6 Replace the roller by inserting the left end first followed by the right end, then rotating the bushing until it locks into place.

- 7 Reconnect the support and the control panel and then close the control panel firmly until it clicks into place.

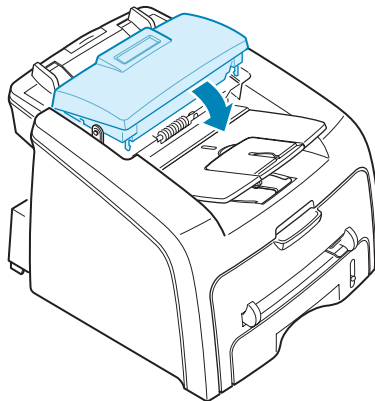

Maintaining the Toner Cartridge

Toner Cartridge Storage

To get the most from the toner cartridge, keep the following guidelines in mind:

- Do not remove the toner cartridge from its package until ready for use.
- Do not refill the toner cartridge. **The machine warranty does not cover damage caused by using a refilled cartridge.**
- Store toner cartridges in the same environment as your machine.
- To prevent damage to the toner cartridge, do not expose it to light for more than a few minute.

Redistributing Toner

When the toner cartridge is near the end of its life, white streaks or light print occurs. The LCD displays the warning message, “[Toner Low].” You can temporarily reestablish the print quality by redistributing the remaining toner in the cartridge.

- 1 Open the front cover.

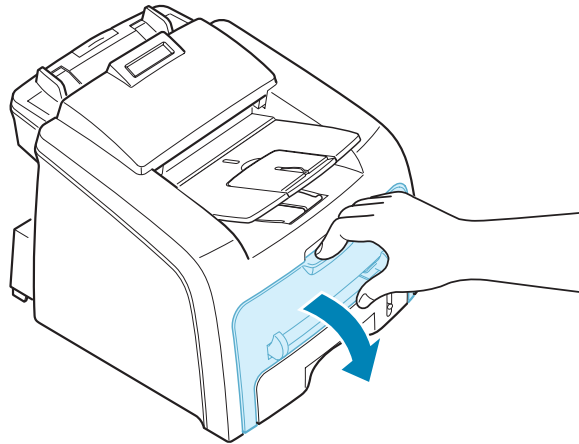

- 2 Pull the toner cartridge out and gently roll the cartridge 5 or 6 times to distribute the toner evenly inside the cartridge.

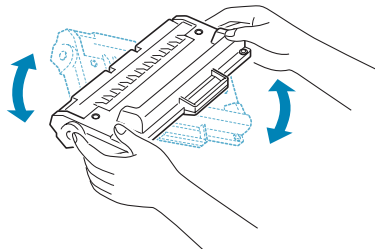

NOTE: If the toner gets on your clothing, wipe it off with a dry cloth and wash clothing in cold water. Hot water sets the toner into fabric.

- 3 Reinstall the cartridge and close the front cover.

Replacing the Toner Cartridge

When the toner eventually runs out, only blank pages print when a print job is sent or when a fax is received. At this stage, the toner cartridge needs to be replaced. The display on the control panel shows the warning message, "[Toner Empty]" and the machine stops printing.



NOTE: You can set the machine to ignore the "[Toner Empty]" message and continue printing. See page 7.11.

- 1 Open the front cover.
- 2 Lightly pushing the used cartridge down, pull it out.

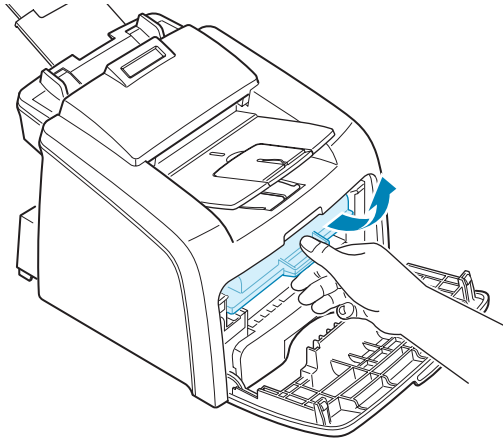

- 3 Unpack the new toner cartridge and gently roll it horizontally four or five times to distribute the toner evenly inside the cartridge.

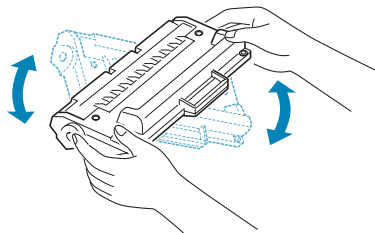

Save the box and the Plastic bag for shipping.

- 4 Slide the new toner cartridge in until it locks into place.

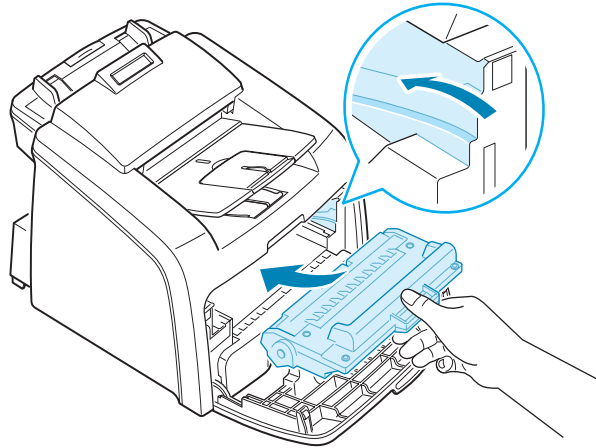

- 5 Close the front cover.

Setting the Notify Toner Option

If you have set the Notify Toner menu option to "On", your machine automatically sends a fax to your service company or the dealer to notify them that your machine requires a new toner cartridge when the toner cartridge needs to be replaced. The fax number is preset by your dealer when you bought your machine.

- 1 Press **Menu** on the control panel until "Maintenance" appears on the top line of the display.

The first available menu item, "Clean Drum," displays on the bottom line.

- 2 Press the scroll button (◀ or ▶) to display "Notify Toner" on the bottom line and press **Enter**.

- 3 Press the scroll button (◀ or ▶) to change the setting.

Select "On" to enable this feature. Selecting "Off" disables this feature.

- 4 Press **Enter** to save the selection.

Cleaning the Drum

If there are streaks or spots on your print, the OPC drum of the cartridge may require cleaning.

- 1** Before setting the cleaning procedure, make sure that paper is loaded in the machine.
- 2** Press **Menu** on the control panel until "Maintenance" appears on the top line of the display.

The first available menu item, "Clean Drum," displays on the bottom line.
- 3** Press **Enter**.
- 4** When the display asks you to confirm your selection, press **Enter**.

The machine prints a cleaning page. Toner particles on the drum surface are affixed to the paper.
- 5** If the problem remains, repeat steps 1 through 4.

Ignoring the Toner Empty Message

When the toner cartridge is empty, the machine shows a "[[Toner Empty]]" message and stops printing.

You can set the machine to ignore the message when it displays and to continue printing the pages.

- 1** Press **Menu** until "Machine Setup" appears on the display.
- 2** Press the scroll button (◀ or ▶) until "Ignore Toner" appears on the bottom line and press **Enter**.
- 3** Press the Scroll button (◀ or ▶) to select "On" or "Off."

Select "On" to ignore the Toner Empty message.

Select "Off" to stop printing when the message appears. This is the default setting.
- 4** Press **Enter** to save the selection.

MEMO



7.12 MAINTENANCE

8

TROUBLESHOOTING

This chapter gives helpful information for what to do if you encounter an error.

This chapter includes:

- **Clearing Document Jams**
- **Clearing Paper Jams**
- **Clearing LCD Error Messages**
- **Solving Problems**

Clearing Document Jams

When a document jams while it passes through the ADF (Automatic Document Feeder), “[Document Jam]” appears on the display.

Input Misfeed

- 1 Remove the remaining documents from the ADF.
- 2 Pull the jammed document gently out of the ADF.

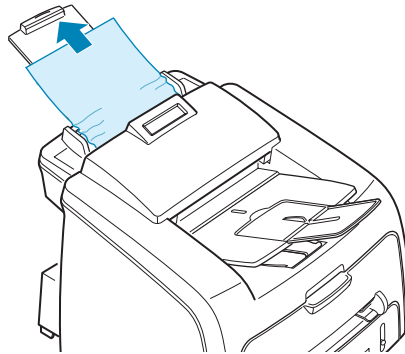

- 3 Load the documents back into the ADF.



NOTE: To prevent document jams, do not use thick, thin or mixed documents.

Exit Misfeed

- 1 Remove the remaining documents from the ADF.
- 2 Open the control panel by gripping its bottom and pulling it upward.

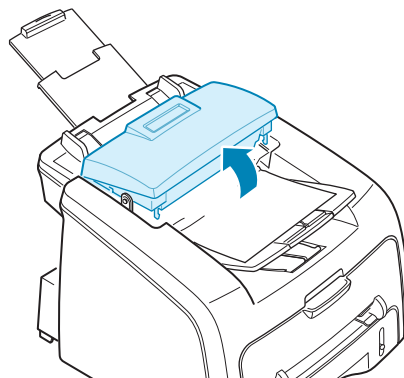

- 3 Pull the document gently out of the ADF.

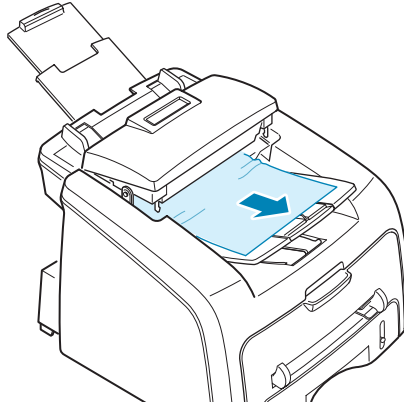

- 4 Close the control panel. Then load the documents back into the ADF.

Clearing Paper Jams

When a paper jam occurs, "Paper Jam" appears on the display. Refer to the table below to locate and clear the paper jam.

Message	Location of Jam	Go to
[Paper Jam 0] Open/Close Door	In the paper tray.	page 8.4
[Paper Jam 1] Open/Close Door	In the fuser area or around the toner cartridge. In the manual feeder	page 8.6
[Paper Jam 2] Check Inside	In the paper exit area	page 8.5

To avoid tearing the paper, pull the jammed paper out gently and slowly. Follow the steps on the next pages to clear the jam.

In the Paper Tray

- 1 Open and close the front cover. The jammed paper automatically exits the machine.

If the paper does not exit, continue to step 2.

- 2 Pull the paper tray open.
- 3 Remove the jammed paper by gently pulling it straight out.

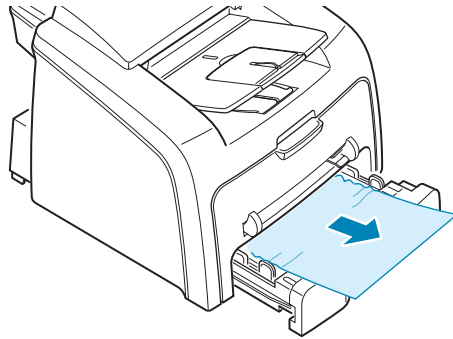

If there is any resistance and the paper does not move when you pull or if you cannot see the paper in this area, skip to the fuser area around the toner cartridge. See page 8.6.

- 4 Insert the paper tray into the machine until it snaps into place.
- 5 Open and close the front cover to resume printing.

In the Paper Exit Area

- 1 Open and close the front cover. The jammed paper automatically exits the machine.

If the paper does not exit, continue to step 2.

- 2 Gently pull the paper out of the front output tray. Skip to step 6.

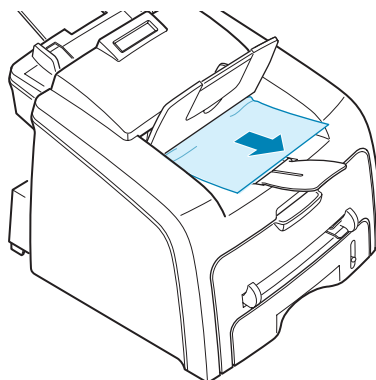

If there is any resistance and the paper does not move when you pull or if you cannot see the paper in the front output tray, continue to step 3.

- 3 Open the rear cover.
- 4 Remove the jammed paper by gently pulling it straight out.

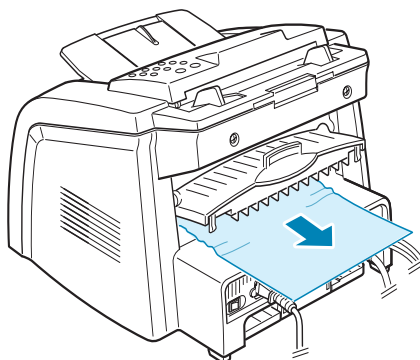

- 5 Close the rear cover.
- 6 Open and close the front cover to resume printing.

In the Fuser Area or Around the Toner Cartridge



WARNING: The fuser area is hot. Take care when removing paper from the machine.

- 1 Open the front cover and pull the toner cartridge out, lightly pushing it down.
- 2 Remove the jammed paper by gently pulling it straight out.

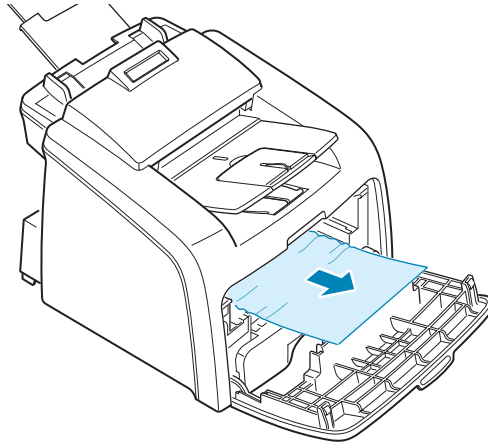

- 3 Replace the toner cartridge and close the front cover. Printing automatically resumes.

In the Manual Feeder

" [Paper Jam 1] Open/Close Door " appears on the display when you try to print using the manual feeder and the machine does not detect paper, due to no paper or improper paper loading.

The error message may also occur when the paper is not properly fed into the machine through the manual feeder. In that case, pull the paper out of the machine.

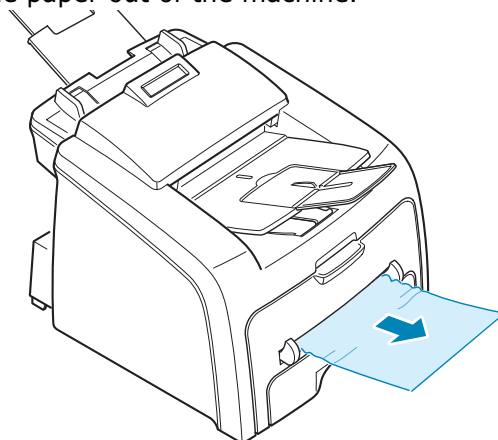

Tips for Avoiding Paper Jams

By selecting the correct paper types, most paper jams can be avoided. When a paper jam occurs, follow the steps outlined in page 8.3.

- Follow the procedures on page 1.13 when you load paper. Ensure that the adjustable guides are positioned correctly.
- Do not overload the paper tray. Ensure that the paper is below the paper capacity mark on the inside wall of the paper tray.
- Do not remove the paper from the tray while your machine is printing.
- Flex, fan and straighten the paper before loading.
- Do not use creased, damp or highly curled paper.
- Do not mix paper types in the paper tray.
- Use only recommended print materials. See "Paper Specification" on page A.5.
- Ensure that the print side of print materials is facing down in the paper tray and facing up in the manual feeder.
- If paper jams frequently occur when you print on the A5-sized paper:
 - Load the paper into the tray as shown below.

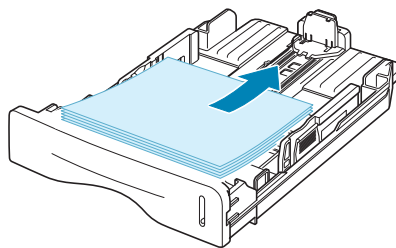

- Set the page orientation to **Landscape** in the printer's Properties window. See page 5.3.

Clearing LCD Error Messages

Messages appears on the display to indicate the control panel to indicate the machine's status or errors. Refer to the following table to understand the message's meaning and correct the problem, if necessary. Messages and their meanings are listed in alphabetical order.

Display	Meaning	Suggested solutions
Cancel ? 1:Yes 2:No	Your machine's memory is full during the machine stores the document into the memory.	To cancel the fax job, press the 1 button to accept "Yes." If you want to send the pages were stored, press the 2 button to accept "No." You should send the remaining pages later when the memory is available.
[Comm. Error]	The machine has a communication problem.	Ask the sender to try again.
CRU Fuse Error	The machine has a problem with recognizing the new toner cartridge.	Please contact a service representative.
[Document Jam]	The loaded document has jammed in the ADF (Automatic Document Feeder).	Clear the document jam. See page 8.2.
[Door Open]	The front or rear cover is not securely latched.	Close the cover until it locks into place.
Group Not Available	You have tried to select a group location number where only a single location number can be used, such as when adding locations for a broadcasting operation.	Just use a one-touch or speed dial number or dial a number manually using the number keypad.
[Incompatible]	The remote machine does not have the requested feature, such as a delayed transmission. It also occurs if the remote machine does not have enough memory space to complete the operation you are attempting.	Reconfirm the remote machine's features.

Display	Meaning	Suggested solutions
[Jam 1] or [No Cartridge]	The toner cartridge is not installed.	Install the toner cartridge. See page 1.11.
[Line Busy]	The remote person did not answer or the line is already engaged.	Try again after a few minutes.
[Line Error]	Your machine cannot connect with the remote machine or has lost contact because of a problem with the phone line.	Try again. If the problem persists, wait an hour or so for the line to clear and try again. Or, turn the ECM on. See page 4.35.
Load Document	You have attempted to set up a copy or fax operation with no document loaded.	Load a document and try again.
Low Heat Error Open Heat Error [Over Heat]	There is a problem in the fuser unit.	Unplug the power cord and plug it back in. If the problem persists, please contact a service representative.
[LSU Error]	A problem has occurred in the LSU (Laser Scanning Unit).	Unplug the power cord and plug it back in. If the problem persists, please call for service.
Memory Full	The memory is full.	Delete unnecessary documents, retransmit after more memory becomes available or split the transmission into more than one operation.
[No Answer]	The remote fax machine has not answered after several redial attempts.	Try again. Make sure that the remote machine is operational.
No. Not Assigned	The one-touch or speed dial location you tried to use has no number assigned to it.	Dial the number manually using the number keypad or assign the number. For storing a number, see "Automatic Dialing" on page 4.15.
[No Paper] Add Paper	The paper tray has run out of paper.	Load paper in the paper tray. See page 1.13.

Display	Meaning	Suggested solutions
Operation Not Assigned	You are doing in the Add/Cancel operation, but there is no jobs waiting.	Check the display to see if there is any scheduled job. The display should indicate them in Standby mode, for example, Delay Fax.
[Paper Jam 0] Open/Close Door	Paper has jammed in the feeding area of the paper tray.	Clear the jam. See page 8.4.
[Paper Jam 1] Open/Close Door	<ul style="list-style-type: none"> • Paper has jammed in the paper exit area. • A paper jam has occurred in the manual feeder or the machine detects non-feeding from the manual feeder. 	Clear the jam. See page 8.6.
[Paper Jam 2] Check Inside	Paper has jammed in the fuser area.	Clear the jam. See page 8.5.
[Power Failure]	Power has turned off then on and the machine's memory has not been saved.	You need to start again the job which you were trying to do before the power failure.
[Retry Redial?]	The machine is waiting for a specified time interval to redial a previously busy station.	You can press Enter to immediately redial, or Clear/Stop to cancel the redial operation.
[Stop Pressed]	The Clear/Stop button is pressed during a copy or fax operation.	Try again.
[Toner Empty]	The toner cartridge has run out. The machine stops printing.	Replace with a new toner cartridge. See page 7.9.
[Toner Low]	The toner cartridge is almost empty.	Take out the toner cartridge and gently shake it. By doing this, you can temporarily reestablish printing operations.

Solving Problems

The following chart lists some conditions that may occur and the recommended solutions. Follow the suggested solutions until the problem is corrected. If the problem persists, please call for service.

Paper Feeding Problems

Condition	Suggested solutions
Paper is jammed during printing.	Clear the paper jam. See page 8.3.
Paper sticks together.	<ul style="list-style-type: none">• Ensure that there is not too much paper in the paper tray. The paper tray can hold up to 250 sheets of paper, depending on the thickness of your paper.• Make sure that you are using the correct type of paper. See "Paper Specification" on page A.5.• Remove paper from the paper tray and flex or fan the paper.• Humid conditions may cause some paper to stick together.
Multiple sheets of paper do not feed.	<ul style="list-style-type: none">• Different types of paper may be stacked in the paper tray. Load the paper of only one type, size and weight.• If multiple sheets have caused a paper jam, clear the paper jam. See page 8.3.
Paper does not feed into the machine.	<ul style="list-style-type: none">• Remove any obstructions inside the machine.• Paper has not been loaded correctly. Remove paper from the tray and reload it correctly.• There is too much paper in the paper tray. Remove excess paper from the tray.• The paper is too thick. Use only paper that meets the specifications required by the machine. See "Paper Specification" on page A.5.
The paper keeps jamming.	<ul style="list-style-type: none">• There is too much paper in the paper tray. Remove excess paper from the tray.• An incorrect type of paper is being used. Use only paper that meets the specifications required by the machine. See "Paper Specification" on page A.5. If you are printing on special materials, use the manual feeder.• There may be debris inside the machine. Open the front cover and remove the debris.
Transparencies stick together in the paper exit.	Use only the transparencies specifically designed for a laser printer. Remove each transparency as it exits from the machine.
Envelopes skew or fail to feed correctly.	Ensure that the paper guides are against both sides of the envelopes.

Faxing Problems

Condition	Suggested solutions
The machine is not working, there is no display and the buttons are not working.	<ul style="list-style-type: none"> • Unplug the power cord and plug it in again. • Ensure that there is power to the electrical receptacle.
No dial tone sounds.	<ul style="list-style-type: none"> • Check that the phone line is connected properly. • Check that the phone socket in the wall is working by plugging in another phone.
The numbers stored in the memory do not dial correctly.	Make sure that the numbers are stored in the memory correctly. Print a Phone Book list, referring to page 4.21.
The document does not feed into the machine.	<ul style="list-style-type: none"> • Make sure that the document is not wrinkled and you are putting it in correctly. Check that the document is the right size, not too thick or thin. • Make sure that the control panel is firmly closed.
Faxes are not received automatically.	<ul style="list-style-type: none"> • Fax mode should be selected. • Make sure that there is paper in the tray. • Check to see if the display shows "Memory Full."
The machine does not send.	<ul style="list-style-type: none"> • Make sure that the document is loaded in the ADF. • "TX" should show up on the display. • Check the other fax machine you are sending to, to see if it can receive your fax.
The incoming fax has blank spaces or is received with a poor-quality.	<ul style="list-style-type: none"> • The fax machine sending you the fax may be faulty. • A noisy phone line can cause line errors. • Check your machine by making a copy. • The toner cartridge may be empty. Replace the toner cartridge, referring to page 7.9.
Some of the words on a incoming fax are stretched.	The fax machine sending you the fax had a temporary document jam.
There are lines on the documents you send.	Check your scan unit for marks and clean it. See page 7.5.
The machine dials a number, but a connection with another fax machine fails.	The other fax machine may be turned off, out of paper, or cannot answer incoming calls. Speak with the other machine operator and ask her/him to clear out the problem.

Condition	Suggested solutions
Documents are not stored in the memory.	There may not be enough memory to store the document. If the display shows a "Memory Full" message, delete any documents you no longer need from the memory and then restore the document.
Blank areas appear at the bottom of each page or on other pages, with a small strip of text at the top.	You may have chosen the wrong paper settings in the user option setting. See page 1.33.

Copying Problems

Condition	Suggested solutions
Copies are too light or too dark.	Use the Darknen button to darken or lighten the background of the copies.
Smears, lines, marks or spots appears on copies.	<ul style="list-style-type: none"> • If defects are on the original document, press the Darknen button to lighten the background of your copies. • If no defects are on the original document, clean the Scan unit. See page 7.5.
Copy image is skewed.	<ul style="list-style-type: none"> • Ensure that the original document is positioned correctly in the ADF (Automatic Document Feeder). • Check that the copy paper is loaded correctly.
Blank copies print out.	Ensure that the original document is face down in the ADF.
Image rubs off the copy easily.	<ul style="list-style-type: none"> • Replace the paper in the paper tray with paper from a new package. • In high humidity areas, do not leave paper in the machine for the extended periods of time.
Frequent copy paper jams occurs.	<ul style="list-style-type: none"> • Fan the stack of paper, then turn it over in the paper tray. Replace the paper in the tray with a fresh supply. Check/adjust the paper guides, if necessary. • Ensure that the paper is the proper paper weight. 75g/m² (20 lb) bond paper is recommended. • Check for copy paper or pieces of copy paper remaining in the machine after a paper jam has been cleared.
Fewer copies from the toner cartridge than expected prints out.	<ul style="list-style-type: none"> • Your original documents may contain pictures, solids or heavy lines. For example, they may be forms, newsletters, books or other documents that use more toner. • The machine may be turned frequently on and off.

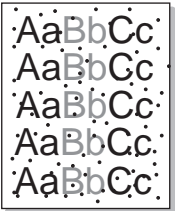
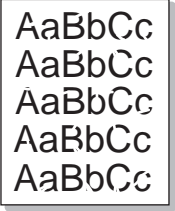

Printing Quality Problems

The dirty inside of the machine or improper paper loading may reduce the print quality. See the table below to clear the problem.

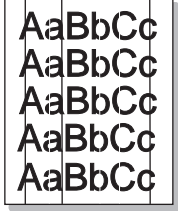
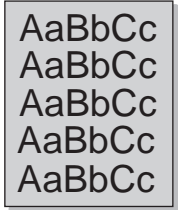
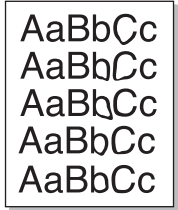
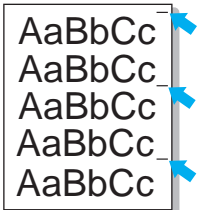
Condition	Suggested solutions
<p>Light or faded print</p> 	<p>If a vertical white streak or faded area appears on the page:</p> <ul style="list-style-type: none"> • The toner supply is low. You may be able to temporarily extend the toner cartridge life. See "Redistributing Toner" on page 7.8. If this does not improve the print quality, install a new toner cartridge. • The paper may not meet paper specifications; for example, the paper is too moist or too rough. See "Paper Specification" on page A.5. • If the entire page is light, the print resolution setting is too low or Toner Save mode is on. Adjust the print resolution and turn Toner Save mode off. See page 5.9 respectively. • A combination of faded or smeared defects may indicate that the toner cartridge needs cleaning. See "Cleaning the Drum" on page 7.11. • The surface of the scan unit may be dirty. Clean the scan unit. See page 7.5.
<p>Toner specs</p> 	<ul style="list-style-type: none"> • The paper may not meet specifications; for example, the paper is too moist or too rough. See "Paper Specification" on page A.5. • The transfer roller or paper path may be dirty. Clean the inside of your machine and the drum. See page 7.4 and page 7.11.
<p>Dropouts</p> 	<p>If generally rounded faded areas, occur randomly on the page:</p> <ul style="list-style-type: none"> • A single sheet of paper may be defective. Try reprinting the job. • The moisture content of the paper is uneven or the paper has moist spots on its surface. Try a different brand of paper. See "Paper Specification" on page A.5. • The paper lot is bad. The manufacturing process can cause some areas to reject toner. Try a different kind or brand of paper. • The toner cartridge may be defective. Vertical repetitive defects on the next page. • If these steps do not correct the problems, contact a service representative.

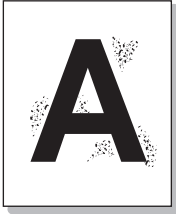
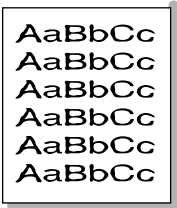
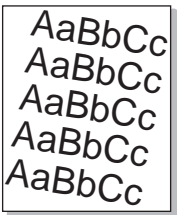
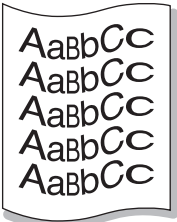
Condition	Suggested solutions
<p>Vertical lines</p> 	<p>If black vertical streaks appear on the page:</p> <ul style="list-style-type: none"> • The drum inside the toner cartridge has probably been scratched. Remove the toner cartridge and install a new one. See "Replacing the Toner Cartridge" on page 7.9.
<p>Gray background</p> 	<p>If the amount of background shading becomes unacceptable:</p> <ul style="list-style-type: none"> • Change to a lighter weight pages. See "Paper Specification" on page A.5. • Check the machine's environment; very dry (low humidity) or high humidity (higher than 80% RH) conditions can increase the amount of background shading. • Remove the old toner cartridge and install a new one. See "Replacing the Toner Cartridge" on page 7.9.
<p>Toner smear</p> 	<ul style="list-style-type: none"> • Clean the inside of the machine. See page 7.4. • Check the paper type and quality. See "Paper Specification" on page A.5. • Remove the toner cartridge and install a new one. See "Replacing the Toner Cartridge" on page 7.9.
<p>Vertical repetitive defects</p> 	<p>If marks repeatedly appear on the printed side of the page at even intervals:</p> <ul style="list-style-type: none"> • The toner cartridge may be damaged. If a repetitive mark occurs on the page, print a cleaning sheet several times to clean the cartridge; see "Cleaning the Drum" on page 7.11. After the printout, if you still have the same problems, remove the toner cartridge and install a new one. See "Replacing the Toner Cartridge" on page 7.9. • Parts of the machine may have toner on them. If the defects occur on the back of the page, the problem will likely correct itself after a few more pages. • The fusing assembly may be damaged. Contact a service representative.

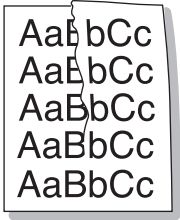
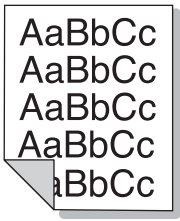
Condition	Suggested solutions
<p>Background scatter</p> 	<p>Background scatter results from bits of toner distributed on the printed page.</p> <ul style="list-style-type: none"> • The paper may be too damp. Try printing with a different batch of paper. Do not open packages of paper until necessary so that the paper does not absorb too much moisture. • If background scatter occurs on an envelope, change the printing layout to avoid printing over areas that have overlapping seams on the reverse side. Printing on seams can cause problems. • If background scatter covers the entire surface area of a printed page, adjust the print resolution through your software application or the printer properties.
<p>Misformed characters</p> 	<ul style="list-style-type: none"> • If characters are improperly formed and producing hollow images, the paper stock may be too slick. Try a different paper. See "Paper Specification" on page A.5. • If characters are improperly formed and producing a wavy effect, the scanner unit may need service. For service, contact a service representative.
<p>Page skew</p> 	<ul style="list-style-type: none"> • Ensure that the paper is loaded properly. • Check the paper type and quality. See "Paper Specification" on page A.5. • Ensure that the paper or other material is loaded correctly and the guides are not too tight or too loose against the paper stack.
<p>Curl or wave</p> 	<ul style="list-style-type: none"> • Ensure that the paper is loaded properly. • Check the paper type and quality. Both high temperature and humidity can cause paper curl. See "Paper Specification" on page A.5. • Turn the stack of paper over in the paper tray. Also try rotating the paper 180° in the tray. • Try printing to the rear output slot.

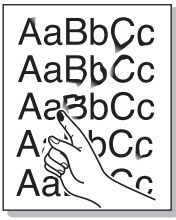
Condition	Suggested solutions
<p>Wrinkles or creases</p> 	<ul style="list-style-type: none"> • Ensure that the paper is loaded properly. • Check the paper type and quality. See "Paper Specification" on page A.5. • Turn the stack of paper over in the paper tray. Also try rotating the paper 180° in the tray. • Try printing to the rear output slot.
<p>Back of printouts are dirty</p> 	<p>Check for leaking toner. Clean the inside of the machine. See page 7.4.</p>
<p>Black pages</p> 	<ul style="list-style-type: none"> • The toner cartridge may not be installed properly. Remove the cartridge and reinsert. • The toner cartridge may be defective and need replacing. Remove the toner cartridge and install a new one. See "Replacing the Toner Cartridge" on page 7.9. • The machine may require repair. Contact a service representative.
<p>Loose toner</p> 	<ul style="list-style-type: none"> • Clean the inside of the machine. See page 7.4. • Check the paper type and quality. See "Paper Specification" on page A.5. • Remove the toner cartridge and install a new one. See "Replacing the Toner Cartridge" on page 7.9. • If the problem persists, the machine may require repair. Contact a service representative.

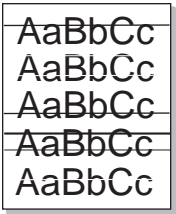
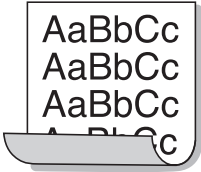
Condition	Suggested solutions
<p>Character Voids</p> 	<p>Character voids are white areas within the parts of characters that should be solid black:</p> <ul style="list-style-type: none"> • If you are using transparencies, try another type of transparency. Due to the composition of the transparency, some character voids are normal. • You may be printing on the wrong surface on the paper. Remove the paper and turn it around. • The paper may not meet paper specifications. See "Paper Specification" on page A.5.
<p>Horizontal stripes</p> 	<p>If horizontally aligned black streaks or smears appear:</p> <ul style="list-style-type: none"> • The toner cartridge may be installed improperly. Remove and reinsert the cartridge. • The toner cartridge may be defective. Remove the toner cartridge and install a new one. See "Replacing the Toner Cartridge" on page 7.9. • If the problem persists, the machine may require repair. Contact a service representative.
<p>Curl</p> 	<p>If the printed paper is curl or paper does not feed into the printer:</p> <ul style="list-style-type: none"> • Turn the stack of paper over in the paper tray. Also try rotating the paper 180° in the paper tray. • Try printing to the rear output slot.

Printing Problems(for MFP model only)

Condition	Possible cause	Suggested solutions
The machine does not print.	The machine is not receiving power.	Check the power cord connections. Check the power switch and the power source.
	The machine is not selected as the default printer.	Select Printer Driver Type 1200 as your default printer in your Windows.
	Check the machine for the following: <ul style="list-style-type: none"> • The front or rear cover is not closed. • Paper is jammed. • No paper is loaded. • The toner cartridge is not installed. 	After locating the problem, clear it. <ul style="list-style-type: none"> • Close the cover. • Clear the paper jam. See page 8.3. • Load paper. See page 1.13. • Install the toner cartridge. See page 1.11. If a printer system error occurs, contact your service representative.
	The connection cable between the computer and the machine is not connected properly.	Disconnect the printer cable and reconnect it.
	The connection cable between the computer and the machine is defective.	If possible, attach the cable to another computer that is working properly and print a document. You can also try using a different printer cable.
	The port setting is incorrect.	Check the Windows printer setting to make sure that the print job is sent to the correct port, for example, LPT1. If the computer has more than one port, make sure that the machine is attached to the correct one.
	The machine may be configured incorrectly.	Check the printer properties to ensure that all of the print settings are correct.
	The printer driver may be incorrectly installed.	Remove the printer driver and then reinstall it; see page 1.25 and page 1.27 respectively.
	The machine is malfunctioning.	Check the display message on the control panel to see if the machine is indicating a system error.
The machine selects print materials from the wrong paper source.	The paper source selection in the printer properties may be incorrect.	For many software applications, the paper source selection is found under the Paper tab within the printer properties. Select the correct paper source. See page 5.8.

Condition	Possible cause	Suggested solutions
A print job is extremely slow.	The job may be very complex.	Reduce the complexity of the page or try adjusting the print quality settings. The maximum print speed of your machine is 17 PPM for Letter-sized paper 16 PPM for A4-sized paper.
	If you are using Windows 9x/Me, the Spooling Setting may be set incorrectly.	From the Start menu, choose Settings and Printers . Right-click the this machine's printer icon, choose Properties , click the Details tab, and then choose the Spool Settings button. Select the spool setting you want.
Half the page is blank.	The page orientation setting may be incorrect.	Change the page orientation in your application. See page 5.3.
	The paper size and the paper size settings do not match.	Ensure that the paper size in the printer driver settings matches the paper in the tray.
The machine prints, but the text is wrong, garbled, or incomplete.	The printer cable is loose or defective.	Disconnect the printer cable and reconnect. Try a print job that you have already printed successfully. If possible, attach the cable and the machine to another computer and try a print job that you know works. Finally, try a new printer cable.
	The wrong printer driver was selected.	Check the application's printer selection menu to ensure that your machine is selected.
	Software application is malfunctioning.	Try printing a job from another application.
	The operating system is malfunctioning.	Exit Windows and reboot the computer. Turn the machine off and then back on again.

Condition	Possible cause	Suggested solutions
Pages print, but are blank.	The toner cartridge is defective or out of toner.	Redistribute the toner, if necessary. See page 7.8. If necessary, replace the toner cartridge.
	The file may have blank pages.	Check the file to ensure that it does not contain blank pages.
	Some parts, such as the controller or the board, may be defective.	Contact a service representative.
The illustrations print incorrectly in Adobe Illustrator.	The setting in software application is wrong.	Select Download as Bit Image in the Advanced Options window of the Graphic properties and print the document.
An error occurs repeatedly when you are printing with the USB connection.	When the USB mode is set to "Fast," some PC users may experience poor USB communication.	Change the USB mode to "Slow." To do so, follow these steps: 1. Press Menu on the control panel until "Machine Setup" appears on the top line of the display. 2. Press the scroll button (◀ or ▶) until "USB Mode" appears on the bottom line, and press Enter . 3. Press the scroll button (◀ or ▶) to select "Slow." 4. Press Enter to save the selection. 5. Press Clear/Stop to return to Standby Mode.

Scanning Problems(for MFP model only)

Condition	Suggested solutions
The scanner does not work.	<ul style="list-style-type: none"> • Make sure that you place the document to be scanned face down in the ADF. • There may not be enough available memory to hold the document you want to scan. Try the Prescan function to see if that works. Try lowering the scan resolution rate. • Check that the USB or parallel cable is connected properly. • Make sure that the USB or parallel cable is not defective. Switch the cable with a known good cable. If necessary, replace the cable. • If you are using a parallel cable, ensure that it is compliant with the IEEE 1284 standard. • Check that the scanner is configured correctly or the application you want to use to make certain that the scanner job is being sent to the correct port, for example, LPT1.
The unit scans very slowly.	<ul style="list-style-type: none"> • Check if the machine is printing received data. Scan the document after the current job is completed. • Graphics are scanned more slowly than text. • Communication speed becomes slow in scan mode because of the large amount of memory required to analyze and reproduce the scanned image. Set your computer to the ECP printer mode through BIOS setting. It will help to increase the speed. For details about how to set BIOS, refer to your computer operating instructions.
<p>Message appears on your computer screen:</p> <ul style="list-style-type: none"> • "Device can't be set to the H/W mode you want." • "Port is being used by another program." • "Port is Disabled." • "Scanner is busy receiving or printing data. When the current job is completed, try again." • "Invalid handle." • "Scanning has failed." 	<ul style="list-style-type: none"> • There may be a copying or printing job in progress. When the current job is complete, try the job again. • The selected port is currently being used. Restart your computer and try again. • The printer cable may be improperly connected or the power may be off. You must use a USB 1.1 compliant cable or a parallel cable that supports IEEE 1284 bi-directional communications. • The scanner driver is not installed or an operating environment is not set up properly. • Ensure that port is properly connected and power is on, and then restart your computer. • Do not use the parallel and the USB cables at the same time.





SPECIFICATIONS

This chapter includes:

- **General Specifications**
- **Facsimile Specifications**
- **Scanner and Copier Specifications**
- **Printer Specifications(for MFP model only)**
- **Paper Specification**

General Specifications

Item	Description
Automatic document feeder (ADF)	Up to 20 sheets (weight: 75 g/m ² , 20 lb)
ADF Document size	Width: 142 to 216 mm (5.6 to 8.5 inches) Length: 148 to 356 mm (5.8 to 14 inches)
Paper input capacity	Paper tray: 250 sheets (weight: 75 g/m ² , 20 lb) Manual feeder: 1 sheet (weight: 60~163 g/m ² , 16~43 lb)
Paper output capacity	Front output tray: 150 sheets (face down) Rear output slot: 1 sheet (face up)
Paper type	Paper tray: Plain paper (60 ~ 90 g/m ² , 16 ~ 24 lb) Manual feeder: Plain paper, Transparencies*, Labels*, Thick, Thin, Bond, Preprinted, Colored * For MFP model only
	Card stock, Envelopes(60 ~ 163 g/m ² , 16 ~ 43 lb)
Consumables	1-piece toner cartridge system
Power requirements	100 ~ 127 VAC, 50/60 Hz, 4.0 A 220 ~ 240 VAC, 50/60 Hz, 2.5 A
Power consumption	Sleep mode: 10W(100 ~ 127 VAC) / 12W(220 ~ 240 VAC) Standby mode: 85 W(100 ~ 127 VAC) / 95 W(220 ~ 240 VAC) Average: 300 W
Noise	Warm-up: 52 dB Standby mode: 39 dB Scanning: 52 dB Printing: 52 dB
Warm-up Time	35 seconds
Operating conditions	Temperature: 50 °F to 89 °F (10 °C to 32 °C) Humidity: 20 % to 80 % RH
LCD	16 characters x 2 lines
SET dimension (WxDxH)	363.0 x 398.5 x 308.3 mm (without the handset)
Weight	Net: 9.7Kg (including consumables) Gross: 11.7 Kg (including consumables, accessories and package)

Item	Description
Package Weight	Paper: 2.7 Kg Plastic: 0.7 Kg

Facsimile Specifications

Item	Description
Compatibility	ITU-T Group 3
Applicable line	Public Switched Telephone Network (PSTN) or behind PABX
Data coding	MH/MR/MMR (ECM Mode)
Modem speed	33600/31200/28800/26400/24000/21600/19200/16800/ 14400/12000/9600/7200/4800/2400 bps with fall back
Transmission speed	Approx. 3 seconds/page * Transmission time applies to memory transmission of text data with ECM compression using only ITU-T No.1 Chart.
Scan speed	Approx. 6 seconds/LTR (at standard fax resolution mode)
Paper Type	Planin paper(60~90 g/m ² , 16~24lb)
Paper size	Letter, A4, Legal, Folio, Executive, B5
Resolution	Standard: 203 x 98 dpi Fine: 203 x 196 dpi Super Fine: 203 x 392 dpi Photo: 203 x 196 dpi
User Memory	2 MB
Halftone	256 levels
Auto dialer	One-touch dialing (up to 20 numbers) Speed dialing (up to 80 numbers)

Scanner and Copier Specifications

Item	Description
Compatibility(for MFP model only)	TWAIN standard
Scan method	CIS, Mono
Scan resolution	200 X 200 dpi (optical)
Scan length	Maximum: 15.7 inches (400 mm)
Scan width	Maximum: 8.5 inches (216 mm) Effective: 8.2 inches (208 mm)
Mono bit depth	1 bit for Text mode 8 bit for Gray mode
Copy speed	Letter: 17 copies per minute A4: 16 copies per minute
Copy resolution	300 x 300 dpi
Zoom rate	50 ~ 150 %
Multiple copies	99 pages
Halftone	256 levels

Printer Specifications(for MFP model only)

Item	Description
Print method	Laser Beam Printing
Print speed	Letter: 17 pages per minute A4: 16 pages per minute
Paper size	Paper tray: Letter, A4, Legal, Folio, A5, A6, B5 Manual feeder: Letter, Legal, A4, Folio, Executive, A5, B5, A6, A6 card, Post Card 4x6, Hagaki, Envelope 7-3/4, Envelope 9, Envelope 10, Envelope DL, Envelope C5, Envelope C6, Envelope B5 * Min.: 76 x 127 mm (3 x 5 in.) Max.: 216 x 356 (8.5 x 14 in.)
Print resolution	600 x 600 dpi
Emulation	SPL (GDI)
PC Interface	Compatible with USB 2.0 Specifications and IEEE 1284 Parallel
Compatibility	Windows 95/98/2000/NT 4.0/Me/XP
Memory	4MB
First printing time	Standby mode: 12 seconds Power save mode: 47 seconds

Paper Specification

Overview

Your machine accepts a variety of print materials, such as cut-sheet paper, including up to 100% recycled fiber content paper, envelopes, *labels*, transparencies and custom-size paper. Properties, such as weight, composition, grain and moisture content, are important factors affecting the machine's performance and the output quality. Paper that does not meet the guidelines outlined in this operating instructions can cause the following problems:

- Poor print quality
- Increased paper jams
- Premature wear on the machine.

*for MFP model only

NOTES:

- Some paper may meet all of the guidelines in this guide and still not produce satisfactory results. This may be the result of improper handling, unacceptable temperature and humidity levels or other variables over which the manufacturer has no control.
- Before purchasing large quantities of paper, insure the paper meets the requirements specified in this operating instructions.

CAUTION: Using paper that does not meet these specifications may cause problems, requiring repairs. These repairs are not covered by the manufacturer's warranty or service agreements.

Supported Sizes of Paper

Size (mm/in.)	Weight	Capacity
Plain paper Letter (215.9 x 279/8.5 x 11) A4 (210 x 297/8.27 x 11.69) Folio (215.9 x 330.2/8.5 x 13) Legal (215.9 x 355.6/8.5 x 14) Executive (184.2 x 266.7/7.25 x 10.5) B5(182 x 257/7.2 x 10) A5 (148 x 210/5.83 x 8.27) A6 (105 x 148/4.13 x 5.88)	<ul style="list-style-type: none">• 60 to 90 g/m² bond (16 to 24 lb) for the paper tray• 60 to 163 g/m² bond (16 to 43 lb) for the manual feeder	<ul style="list-style-type: none">• 250 sheets of 75 g/m² bond (20 lb) paper for the paper tray• 1 sheet of paper for the manual feeder

Size (mm/in.)	Weight	Capacity
Envelopes No.9 (98.4 x 225.4/3.88 x 8.88) No.10 (104.8 x 241.3/4.13 x 9.5) DL (110 x 220/4.33 x 8.66) C5 (162 x 229/6.38 x 9.02) C6 (114 x 162/4.49 x 6.38) B5 (176 x 250/6.93 x 9.84) No.7 3/4 (98.4 x 190.5/3.88 x 7.5)	75 to 90 g/m ²	1 sheet of paper for the manual feeder
Labels Letter (215.9 x 279/8.5 x 11) A4 (210 x 297/8.27 x 11.69)	120 to 150 g/m ²	1 sheet of paper for the manual feeder
Transparency films Letter (215.9 x 279/8.5 x 11) A4 (210 x 297/8.27 x 11.69)	138 to 146 g/m ²	
Card stocks A6 card (105 x 148/4.13 x 5.88) Post Card (101.6 x 152.4/4 x 6) Hagaki (100 x 148/3.94 x 5.83)	90 to 163 g/m ²	
Minimum size (custom)	60 to 120 g/m ² bond (16 to 32 lb)	
Maximum size (Legal)		

***for MFP model only**

NOTE:

- You may experience jams when using print materials with a length of less than 127 mm (5 in.). For optimum performance, ensure that you are storing and handling the paper correctly. Please refer to "Paper Storage Environment" on page A.8.
- Capacity may vary depending on print materials' weight and thickness, and environmental conditions.

Guidelines for Using Paper

For the best result, use conventional 75 g/m² (20 lb) paper. Ensure that the paper is of good quality, and free of cuts, nicks, tears, spots, loose particles, dust, wrinkles, voids, and curled or bent edges.

If you are unsure of what type of paper you are loading, such as bond or recycled paper, check the label on the package.

The following problems may cause print quality deviations, jamming or even damage to the machine:

Symptom	Problem with Paper	Solution
Poor print quality or toner adhesion, problems with feeding	Too moist, too rough, too smooth or embossed; faulty paper lot	Try another kind of paper, between 100 ~ 400 Sheffield, 4 ~ 5 % moisture content.
Dropout, jamming, curl	Stored improperly	Store paper flat in its moisture-proof wrapping.
Increased gray background shading/machine wear	Too heavy	Use lighter paper, use the rear output slot.
Excessive curl problems with feeding	Too moist, wrong grain direction or short-grain construction	<ul style="list-style-type: none"> • Use the rear output slot. • Use long-grain paper.
Jamming, damage to machine	Cutouts or perforations	Do not use paper with cutouts or perforations.
Problems with feeding	Ragged edges	Use good quality paper.

NOTES:

- Do not use letterhead paper printed with low-temperature inks, such as those used in some types of thermography.
- Do not use raised or embossed letterhead.
- The machine uses heat and pressure to fuse toner to the paper. Insure that any colored paper or preprinted forms use inks that are compatible with this fusing temperature (200 °C or 392 °F for 0.1 second).

Paper Specifications

Category	Specifications
Acid Content	5.5 pH or lower
Caliper	0.094 ~ 0.18 mm (3.0 ~ 7.0 mils)
Curl in Ream	Flat within 5 mm (0.02 in.)
Cut Edge Conditions	Cut with sharp blades with no visible fray.
Fusing Compatibility	Must not scorch, melt, offset or release hazardous emissions when heated to 200 °C (392 °F) for 0.1 second.
Grain	Long Grain
Moisture Content	4 % ~ 6 % by weight
Smoothness	100 ~ 400 Sheffield

Paper Output Capacity

Output Location	Capacity
Face-down output tray	150 sheets of 75 g/m ² bond (20 lb) paper
Face-up output slot	1 sheet of 75 g/m ² bond (20 lb) paper

Paper Storage Environment

Paper storage environmental conditions directly affect the feed operation.

Ideally, the machine and paper storage environment should be at or near room temperature, and not too dry or humid. Remember that paper is hygroscopic; it absorbs and loses moisture rapidly.

Heat works with humidity to damage paper. Heat causes the moisture in paper to evaporate, while cold causes it to condense on the sheets. Heating systems and air conditioners remove most of the humidity from a room. As paper is opened and used, it loses moisture, causing streaks and smudging. Humid weather or water coolers can cause the humidity to increase in a room. As paper is opened and used it absorbs any excess moisture, causing light print and dropouts. Also, as paper loses and gains moisture it can become distorted. This can cause paper jams.

Care should be taken not to purchase more paper than can be used in a short time (about 3 months). Paper stored for long periods may experience heat and moisture

extremes, which can cause damage. Planning is important to prevent damage to large supplies of paper.

Unopened paper in sealed reams can remain stable for several months before use. Opened packages of paper have more potential for environment damage, especially if they are not wrapped with a moisture-proof barrier.

The paper storage environment should be properly maintained to ensure optimum performance. The required condition is 20 to 24 °C (68 to 75 °F), with a relative humidity of 45 % to 55 %. The following guidelines should be considered when evaluating the paper's storage environment:

- Paper should be stored at or near room temperature.
- The air should not be too dry or too humid.
- The best way to store an opened ream of paper is to rewrap it tightly in its moisture-proof wrapping. If the machine environment is subject to extremes, unwrap only the amount of paper to be used during the day's operation to prevent unwanted moisture changes.

Envelopes

Envelope construction is critical. Envelope fold lines can vary considerably, not only between manufacturers, but also within a box from the same manufacturer. Successful printing on envelopes depends upon the quality of the envelopes. When selecting envelopes, consider the following components:

- **Weight:** The weight of the envelope paper should not exceed 90g/m² (24lb) or jamming may occur.
- **Construction:** Prior to printing, envelopes should lie flat with less than 6mm (0.25in.) curl, and should not contain air.
- **Condition:** Envelopes should not be wrinkled, nicked or otherwise damaged.
- **Temperature:** You should use envelopes that are compatible with the heat and pressure of the machine.
- **Size:** You should only use envelopes within the following size ranges

NOTES:

- Use only the manual feeder to print envelopes.
 - You may experience some paper jams when using any media with a length less than 140 mm (5.5 in.). This may be caused by paper that has been affected by environmental conditions. For optimum performance, make sure you are storing and handling the paper correctly. Please refer to "Paper Storage Environment" on page A.8.
-

Envelopes with Double Side Seams

Double side-seams construction has vertical seams at both ends of the envelope rather than diagonal seams. This style may be more likely to wrinkle. Be sure the seam extends all the way to the corner of the envelope as illustrated below.

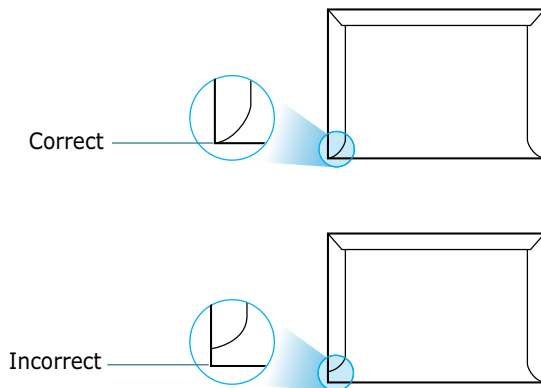

Envelopes with Adhesive Strips or Flaps

Envelopes with a peel-off adhesive strip or with more than one flap that folds over to seal must use adhesives compatible with the heat and pressure in the machine. The extra flaps and strips might cause wrinkling, creasing or even jams and may even damage the fuser.

Envelope Margins

The following gives typical address margins for a commercial #10 or DL envelope.

Type of Address	Minimum	Maximum
Return address	15 mm (0.6 in.)	51 mm (2 in.)
Delivery address	51 mm (2 in.)	90 mm (3.5 in.)

NOTES:

- For the best print quality, position margins no closer than 15 mm (0.6 in.) from the edges of the envelope.
- Avoid printing over the area where the envelope's seams meet.

Envelope Storage

Proper storage of envelopes helps contribute to print quality. Envelopes should be stored flat. If air is trapped in an envelope, creating an air bubble, then the envelope may wrinkle during printing.

Labels(for MFP model only)

CAUTIONS:

- To avoid damaging the machine, use only labels recommended for laser printers.
 - To prevent serious jams, always use the manual feeder to print labels and always use the rear output tray.
 - Never print on the same sheet of labels more than once and never print on a partial sheet of labels.
-

When selecting labels, consider the quality of each component:

- Adhesives: The adhesive material should be stable at 180°C (356°F), the machine's fusing temperature.
- Arrangement: Only use labels with no exposed backing between them. Labels can peel off sheets with spaces between the labels, causing serious jams.
- Curl: Prior to printing, labels must lie flat with no more than 13mm (5in.) of curl in any direction.
- Condition: Do not use labels with wrinkles, bubbles or other indications of separation.

Transparencies(for MFP model only)

Transparencies used in the machine must be able to withstand 180°C (356°F), the machine's fusing temperature.

CAUTION: To avoid damaging the machine, use only transparencies recommended for use in laser printers.



INDEX

A

- adding documents 4.27
- ADF (Automatic Document Feeder),
 - load 3.3
- automatic dialing
 - group 4.18
 - one-touch 4.15
 - speed 4.16
- automatic redialing 4.9

B

- broadcasting faxes 4.22

C

- canceling
 - fax 4.8
 - print 5.5
 - scheduled faxes 4.28
- characters, enter 1.30
- cleaning
 - drum 7.11
 - inside 7.4
 - outside 7.3
 - scan unit 7.5
- connection
 - AC power 1.19
 - parallel 1.18
 - telephone line cord 1.16
- control panel 1.7
- copying 3.3
 - default setting, change 3.7
 - number of pages 3.5
 - time out, set 3.8

D

- date and time, set 1.32
- delay receive polling 4.26
- delayed fax 4.23
- display language, change 1.28
- document
 - jam, clear 8.2

- loading 1.13
- preparing 3.2
- drum, clean 7.11

E

- error messages 8.8

F

- Favorite setting, use 5.6
- fax system, set
 - advanced settings 4.33
 - basic settings 4.2
- fitting to page, print 5.14
- front output tray, use 2.5

G

- graphic properties, set 5.9
- group dial
 - dialing 4.20
 - editing 4.19
 - setting 4.18

H

- handset, attach 1.10
- help, use 5.6

I

- Installing 1.22
- installing
 - toner cartridge 1.11
 - Windows software 1.22

J

- jam, clear
 - document 8.2
 - paper 8.3

M

- machine ID, set 1.29

memory, clear 7.2

N

network printer, set 5.24

notifying toner low 7.10

O

one-touch dial

dialing 4.16

storing 4.15

orientation, print 5.3

output location, select 2.4

overlay, use 5.19

P

paper guidelines 2.3

paper jam, clear 8.3

paper level indicator 2.7

paper load

in manual feeder 2.8

in paper tray 1.13

paper load capacity 2.2

paper properties, set 5.7

paper size, set

manual feeder 2.10

paper tray 1.33

print 5.7

paper source, set 5.8

paper type 2.2

paper type, set

manual feeder 2.10

paper tray 1.33

print 5.8

paper, load 4.11

parallel, connect 1.18

polling 4.26

poster, print 5.15

power save mode, use 1.36

print order, set 5.3

print resolution 5.9

printer driver, install

Windows 1.22

printer properties

windows 5.2

printing

fitting to a selected paper size 5.14

from Windows 5.2

multiple pages on one sheet 5.11

Phone Book list 4.21

posters 5.15

reduced or enlarged document

5.13

reports 4.31

using overlays 5.19

watermarks 5.16

priority fax 4.25

problems, solve

copying 8.22

error messages 8.8

paper feeding 8.11

printing 8.12

printing quality 8.22

scanning 8.22

R

rear output slot, use 2.5

receiving a fax

in Ans/Fax mode 4.12

in Fax mode 4.11

in Secure Receiving mode 4.29

in Tel mode 4.12

in the memory 4.14

redialing

automatically 4.8

manually 4.9

reduced/enlarged

copy 3.6

print 5.13

Remote Control Panel 4.36

reports, print 4.31

resolution

fax 4.6

print 5.9

S

- Safety information i.ii
- scanning
 - Windows 6.2
- searching Phone Book 4.20
- Secure Receiving mode 4.29
- sending a fax
 - automatically 4.7
 - manually 4.8
- sharing printer, set 5.24
- sounds, set 1.34
- specifications
 - facsimile A.5
 - general A.2
 - paper A.5
 - printer A.4
 - scanner and copier A.4
- speed dial
 - dialing 4.17
 - storing 4.16
- system requirements
 - Windows 1.22

T

- tel line, connect 1.16
- toner cartridge
 - install 1.11
 - redistribute 7.8
 - replace 7.9
- TWAIN, scan 6.2
- Type 1200 Driver, install 1.20

U

- uninstalling
 - Remote Control Panel 1.27
- USB
 - connect 1.18
 - mode, change 8.21

V

- volume, adjust
 - ringer 1.34
 - speaker 1.34

W

- watermarks, use 5.16



H914-8650

Quick Guide

Safety Information	ii
Safety During Operation	ii
Positions of Labels and Hallmarks for WARNING and CAUTION Labels	iv
Control Panel Functions	1
Changing the Display Language	3
Setting the Date and Time	3
Printing a Report	4
Using Advanced Fax Settings	5
Changing Setting Options	5
Loading a Document	5
Sending a Fax Automatically	6
Confirming Transmission	7
Automatic Redialing	7
Redialing the Last Number	7

For safe and correct use of this machine, please be sure to read the Safety Information in this Guide before you use it.

Safety Information

When using this machine, the following safety precautions should always be followed.

Safety During Operation

In this manual, the following important symbols are used:

⚠ WARNING:

Indicates a potentially hazardous situation which, if instructions are not followed, could result in death or serious injury.

⚠ CAUTION:

Indicates a potentially hazardous situation which, if instructions are not followed, may result in minor or moderate injury or damage to property.

⚠ WARNING:

- **Connect the power cord directly into a wall outlet and never use an extension cord.**
- **Disconnect the power plug (by pulling the plug, not the cable) if the power cable or plug becomes frayed or otherwise damaged.**
- **To avoid hazardous electric shock or laser radiation exposure, do not remove any covers or screws other than those specified in this manual.**
- **Turn off the power and disconnect the power plug (by pulling the plug, not the cable) if any of the following occurs:**
 - **You spill something into the machine.**
 - **You suspect that your machine needs service or repair.**
 - **The external housing of your machine has been damaged.**
- **Do not incinerate spilled toner or used toner. Toner dust might ignite when exposed to an open flame.**
- **Disposal can take place at our authorized dealer.**
- **Dispose of the used toner bottle in accordance with the local regulations.**
- **Keep the machine away from flammable liquids, gases, and aerosols. A fire or an electric shock might occur.**

⚠ CAUTION:

- *Protect the machine from dampness or wet weather, such as rain and snow.*
- *Unplug the power cord from the wall outlet before you move the machine. While moving the machine, you should take care that the power cord will not be damaged under the machine.*
- *When you disconnect the power plug from the wall outlet, always pull the plug (not the cable).*
- *Do not allow paper clips, staples, or other small metallic objects to fall inside the machine.*
- *Keep toner (used or unused) and toner bottle out of the reach of children.*
- *Be careful not to cut yourself on any sharp edges when you reach inside the product to remove misfed sheets of paper or masters.*
- *For environmental reasons, do not dispose of the machine or expended supply waste at household waste collection points. Disposal can take place at an authorized dealer.*
- *The inside of the machine could be very hot. Do not touch the parts with a label indicating the "hot surface". Otherwise, an injury might occur.*

Power Supply

The socket-outlet shall be installed near the product and shall be easily accessible.

Ozone Safety

This product generates ozone during operation. Normally, the ozone level is safe for operators. If ozone odor may appear, ventilate the room.

For Fax or Telephone

Do not use this product near water, for example, near a bathtub, wash bowl, kitchen sink or laundry tub, in a wet basement or near a swimming pool. Avoid using a telephone during an electrical storm. There may be a remote risk of electric shock from lightning. Do not use a telephone in the vicinity of a gas leak to report the leak.

Laser Safety:

This equipment is considered a class 1 laser device. This equipment contains a 5 milliwatt, 760-800 nanometer wavelength, AlGaAs laser diode. The following marking is attached on the back of the equipment.

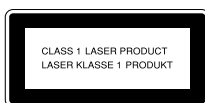
**Caution:**

Use of controls or adjustment or performance of procedures other than those specified in this Operating Instructions might result in hazardous radiation exposure.



Declaration of Conformity

Notice to Users in EEA Countries

This product complies with the essential requirements and provisions of Directive 1999/5/EC of the European Parliament and of the Council of 9 March 1999 on radio equipment and telecommunications terminal equipment and the mutual recognition of their conformity.

Notice to Users Accessing Analog PSTN in EEA Countries

This product is designed to be able to access analog PSTN in all EEA countries. Local PSTN compatibility is dependent on software switch settings. Please contact your service representative if relocating this product to another country. In the event of problems, please contact your service representative in the first instance.

FAX1130L/FAX1170L/F230/F250/LF120/LF125m: The CE declaration of Comformity is available on the Internet at URL :
http://www.ricoh.co.jp/fax/ce_doc

IF3030/IF3035 :The CE Declaration of Conformity is available by accessing the URL:
<http://jboard.danka.de/jboard/produkte/index.html> and selecting the product applicable.

Positions of Labels and Hallmarks for

⚠ WARNING and ⚠ CAUTION Labels

This machine has labels for ⚠ WARNING and ⚠ CAUTION at the positions shown below. For safety, please follow the instructions and handle the machine as indicated.

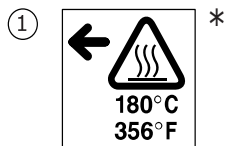
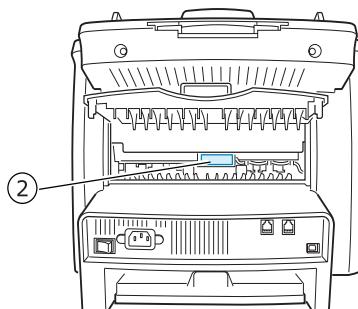
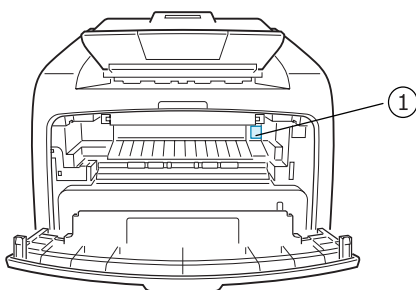

*This label is stuck to hot surfaces. Be careful not to touch these areas.







In accordance with IEC 60417, this machine uses the following symbols for the main power switch:

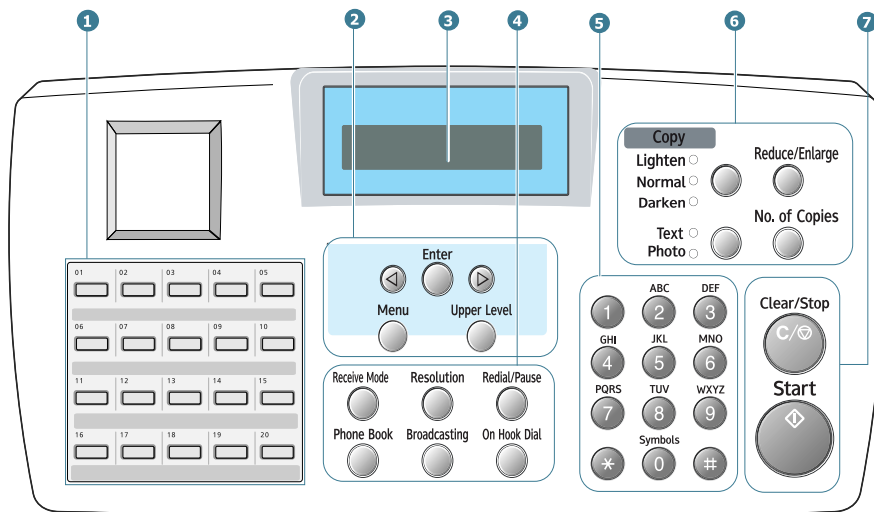











| means POWER ON.

○ means POWER OFF.

Control Panel Functions



1		Use to store frequently-dialed fax number and dial them with a touch of the buttons.
2		Scrolls through the options available for the selected menu item.
	Enter 	Confirms the selection on the display.
	Menu 	Enters Menu mode and scrolls through the menus available.
	Upper Level 	Returns you to the upper menu level.
3		Displays the current status and prompts during an operation.

4 F A X	Receive Mode 	Allows you to select the fax receiving mode.
	Phone Book 	<ul style="list-style-type: none"> Allows you to store frequently-dialed fax numbers using a one or two-digit speed dial or group number for automatic dialing and edit the stored numbers. Allows you to print a Phone book list.
	Resolution 	Adjusts the resolution of the documents for the current fax job.
	Broadcasting 	Allows you to send a fax to multiple destinations.
	On Hook Dial 	Engages the telephone line.
	Redial / Pause 	Redials the last number in Standby mode or inserts a pause into a fax number in Edit mode.
5		Dials a number or enters alphanumeric characters.
6 C O P Y	Lighten <input type="radio"/> Normal <input type="radio"/> Darken <input type="radio"/> 	Adjusts the brightness of the documents for the current copy job. *1This button is called "Darkness" in this manual.
	Text <input type="radio"/> Photo <input type="radio"/> 	Selects the document type for the current copy job. *2This button is called "Original Type" in this manual.
	Reduce/Enlarge 	Makes a copy smaller or larger than the original document.
	No. of Copies 	Selects the number of copies.
7	Clear/Stop 	Stops an operation at any time. In Standby mode, clears/stop the copy options, such as the darkness, the document type setting, the copy size and the number of copies.
	Start 	Starts a job.

Changing the Display Language

To change the language that displays on the display of the control panel, follow these steps:

- 1 Press **Menu** until "Machine Setup" appears on the top line of the display.
- 2 Press the scroll button (◀ or ▶) until "Language" appears on the bottom line of the display.
- 3 Press **Enter**. The current setting appears on the bottom line of the display.
- 4 Press the scroll button (◀ or ▶) until the language you want appears on the display.
- 5 Press **Enter** to save the selection.
- 6 To return to Standby Mode, press **Clear/Stop**.

Setting the Date and Time

The current date and time are shown on the display when your machine is on and ready to work. All of your faxes will have the date and time printed on them.



NOTE: If power to the machine is cut off, you need to reset the correct time and date once the power is restored.

- 1 Press **Menu** until "Machine Setup" appears on the top line of the display.
- 2 Press the scroll button (◀ or ▶) to display "Date & Time" on the bottom line and press **Enter**.
- 3 Enter the correct time and date using the number keypad.

Month	= 01 ~ 12
Day	= 01 ~ 31
Year	= requires all four digits
Hour	= 01 ~ 12 (12-hour mode) 00 ~ 23 (24-hour mode)
Minute	= 00 ~ 59



NOTE: The date format may differ from each country.

You can also use the scroll button (◀ or ▶) to move the cursor under the digit you want to correct and enter a new number.

- 4 To select "AM" or "PM" for 12-hour format, press the * or # button or any number button.

When the cursor is not under the AM or PM indicator, pressing the * or # button immediately moves the cursor to the indicator.

You can change the clock mode to 24-hour format (e.g. 01:00 PM as 13:00).

- 5 Press **Enter** when the time and date on the display is correct.

When you enter a wrong number, the machine beeps and does not proceed to the next step. If this happens, just reenter the correct number.

Printing a Report

- 1 Press **Menu** until "Reports" appears on the top line of the display. The first available menu item, "Phone Book" displays on the bottom line.
- 2 Press the scroll button (◀ or ▶) to display the report or list you want to print on the bottom line.
- 3 Press **Enter**.

The selected information prints out.

Using Advanced Fax Settings

Your machine has various user-selectable setting options for sending or receiving faxes. These options are preset at the factory, but you may need to change them. To find out how the options are currently set, print the System Data list. For details about printing the list, see Operating Instruction.

Changing Setting Options

- 1 Press **Menu** until "Advanced Fax" appears on the top line of the display. The first available menu item, "Send Forward," displays on the bottom line.
- 2 Press the scroll button (◀ or ▶) until you see the desired menu item on the bottom line and press **Enter**.
- 3 When the option you want appears on the display, choose a status by pressing the scroll button (◀ or ▶) or enter a value using the number keypad.
- 4 Press **Enter** to save the selection.
- 5 You can exit from Setup mode at any time by pressing **Clear/Stop**.

Loading a Document

- 1 Pull the document input support all the way out. Fold out the extender, if necessary.

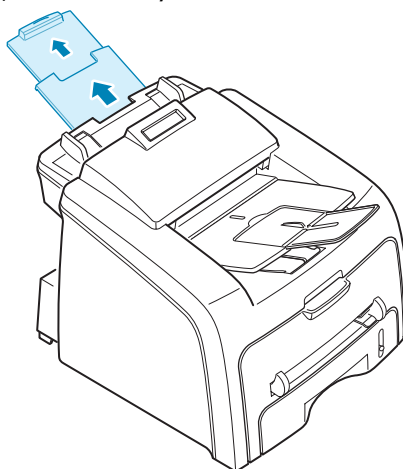

- 2 Load the documents up to 20 pages **face down** into the ADF and adjust the document guides to the document size.

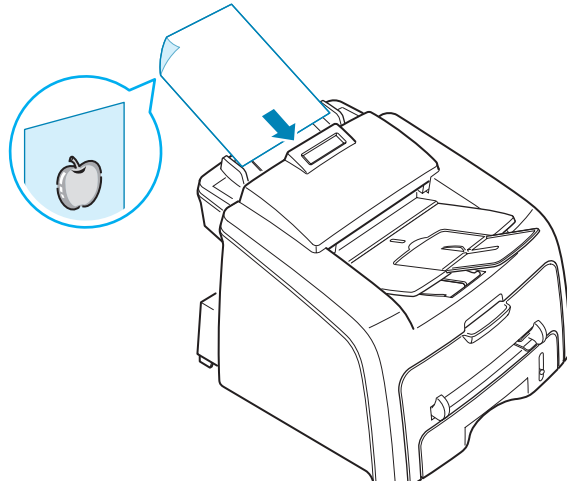

For detailed guidelines for preparing an original document.

- 3 Adjust the document resolution, referring to Operating Instruction.

Sending a Fax Automatically

- 1 Load the document(s) face down into the ADF.

For details about loading a document, see page 5.

- 2 Adjust the document resolution to suit your fax needs. See Operating Instruction.

If you need to change the darkness, see Operating Instruction.

- 3 Enter the remote fax phone number using the number keypad.

You can use the one-touch keypad or speed or group dial numbers. For details about storing a number, see Operating Instruction.

- 4 Press **Start**.

The number is dialed and then the machine begins sending the fax when the remote fax machine is ready.



NOTE: When you want to cancel the fax job, press **Clear/Stop** at any time while sending the fax.

Confirming Transmission

When the last page of your document has been sent successfully, the machine beeps and returns to Standby Mode.

When something goes wrong while sending your fax, an error message appears on the display. For a listing of error messages and their meanings, see Operating Instruction.

If you receive an error message, press **Clear/Stop** to clear the message and try to send the document again.

You can set your machine to print a confirmation report automatically each time sending a fax is completed. For further details, see the MSG Confirm item Operating Instruction.

Automatic Redialing

When the number you have dialed is busy or there is no answer when you send a fax, the machine automatically redials the number every three minutes up to seven times by the factory default settings.

When the display shows "[Retry Redial ?]," press **Enter** to redial the number without waiting. To cancel the automatic redialing, press **Clear/Stop**.

To change the time interval between redials and the number of redial attempts. See Operating Instruction.

Redialing the Last Number

To redial the last number you dialed:

Press **Redial/Pause**.

If a document is loaded in the ADF, the machine automatically begins to send.

Reference:

See Operating Instruction for installing printer and scanner software.

Memo



Operating Instructions

Laser Facsimile

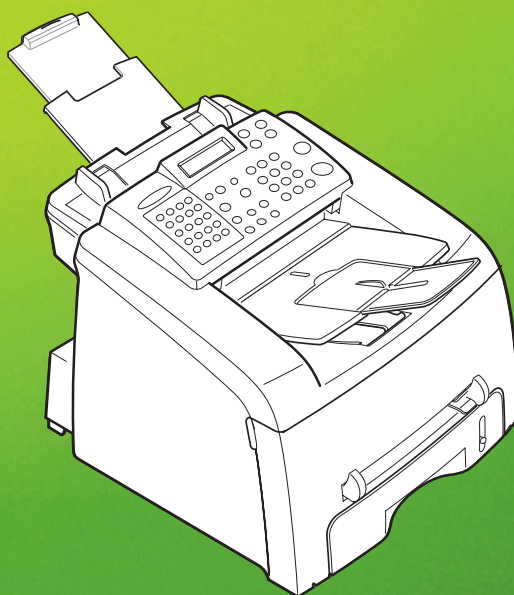

For safe and correct use of this machine, please be sure to read the Safety Information in this manual before you use it.

About the Operating Instructions

Your machine comes with the References:

This Operating Instructions provides information you need for setting up your machine and installing the supplied software. It also provides all of the detailed instructions for using your machine as a printer, a scanner and a copier and information for maintaining and troubleshooting the machine.

Contents of this manual are subject to change without prior notice. In no event will the company be liable for direct, indirect, incidental or consequential damages as a result of handling or operating the machine.

Copyright © 2004.

- Centronics is a trademark of Centronics Data Computer Corporation.
- IBM and IBM PC are Trademark of International Business Machines Corporation.
- Microsoft, Windows, Windows 9x, Window Me, Windows 2000, Windows NT 4.0 and Windows XP are registered trademarks of Microsoft Corporation.
- TrueType is a trademarks of Apple Computer, Inc.
- All other brand or product names are trademarks of their respective companies or organizations.

Safety Information

When using this machine, the following safety precautions should always be followed.

Safety During Operation

In this manual, the following important symbols are used:

 **WARNING:**

Indicates a potentially hazardous situation which, if instructions are not followed, could result in death or serious injury.

 **CAUTION:**

Indicates a potentially hazardous situation which, if instructions are not followed, may result in minor or moderate injury or damage to property.

 **WARNING:**

- **Connect the power cord directly into a wall outlet and never use an extension cord.**
- **Disconnect the power plug (by pulling the plug, not the cable) if the power cable or plug becomes frayed or otherwise damaged.**
- **To avoid hazardous electric shock or laser radiation exposure, do not remove any covers or screws other than those specified in this manual.**
- **Turn off the power and disconnect the power plug (by pulling the plug, not the cable) if any of the following occurs:**
 - **You spill something into the machine.**
 - **You suspect that your machine needs service or repair.**
 - **The external housing of your machine has been damaged.**
- **Do not incinerate spilled toner or used toner. Toner dust might ignite when exposed to an open flame.**
- **Disposal can take place at our authorized dealer.**
- **Dispose of the used toner bottle in accordance with the local regulations.**
- **Keep the machine away from flammable liquids, gases, and aerosols. A fire or an electric shock might occur.**

⚠ CAUTION:

- *Protect the machine from dampness or wet weather, such as rain and snow.*
- *Unplug the power cord from the wall outlet before you move the machine. While moving the machine, you should take care that the power cord will not be damaged under the machine.*
- *When you disconnect the power plug from the wall outlet, always pull the plug (not the cable).*
- *Do not allow paper clips, staples, or other small metallic objects to fall inside the machine.*
- *Keep toner (used or unused) and toner bottle out of the reach of children.*
- *Be careful not to cut yourself on any sharp edges when you reach inside the product to remove misfed sheets of paper or masters.*
- *For environmental reasons, do not dispose of the machine or expended supply waste at household waste collection points. Disposal can take place at an authorized dealer.*
- *The inside of the machine could be very hot. Do not touch the parts with a label indicating the "hot surface". Otherwise, an injury might occur.*

Power Supply

The socket-outlet shall be installed near the product and shall be easily accessible.

Ozone Safety

This product generates ozone during operation.

Normally, the ozone level is safe for operators. If ozone odor may appear, ventilate the room.

For Fax or Telephone

Do not use this product near water, for example, near a bathtub, wash bowl, kitchen sink or laundry tub, in a wet basement or near a swimming pool. Avoid using a telephone during an electrical storm. There may be a remote risk of electric shock from lightning. Do not use a telephone in the vicinity of a gas leak to report the leak.

Laser Safety:

This equipment is considered a class 1 laser device. This equipment contains a 5 milliwatt, 760-800 nanometer wavelength, AlGaAs laser diode. The following marking is attached on the back of the equipment.



Caution:

Use of controls or adjustment or performance of procedures other than those specified in this Operating Instructions might result in hazardous radiation exposure.

For North America

Laser Safety:

This equipment complies with requirements of 21 CFR subchapter J for class 1 laser products. This equipment contains a 5 milliwatt, 760-800 nanometer wavelength, AlGaAs laser diode.

Caution:

Use of controls or adjustment or performance of procedures other than those specified in this Operating Instructions might result in hazardous radiation exposure.



Declaration of Conformity

Notice to Users in EEA Countries

This product complies with the essential requirements and provisions of Directive 1999/5/EC of the European Parliament and of the Council of 9 March 1999 on radio equipment and telecommunications terminal equipment and the mutual recognition of their conformity.

Notice to Users Accessing Analog PSTN in EEA Countries

This product is designed to be able to access analog PSTN in all EEA countries. Local PSTN compatibility is dependent on software switch settings. Please contact your service representative if relocating this product to another country. In the event of problems, please contact your service representative in the first instance.

FAX2210L/LF215m : The CE declaration of Comformity is available on the Internet at URL :
http://www.ricoh.co.jp/fax/ce_doc

IF3050: The CE Declaration of Conformity is available by accessing the URL:
<http://jboard.danka.de/jboard/produkte/index.html>o and selecting the product applicable.

Positions of Labels and Hallmarks for ⚠️ WARNING and ⚠️ CAUTION Labels

This machine has labels for ⚠️ WARNING and ⚠️ CAUTION at the positions shown below. For safety, please follow the instructions and handle the machine as indicated.

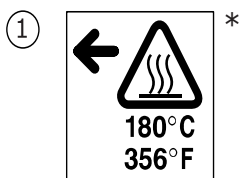
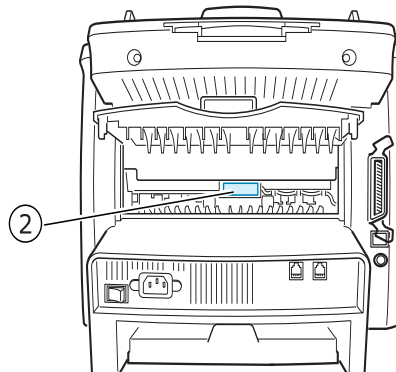
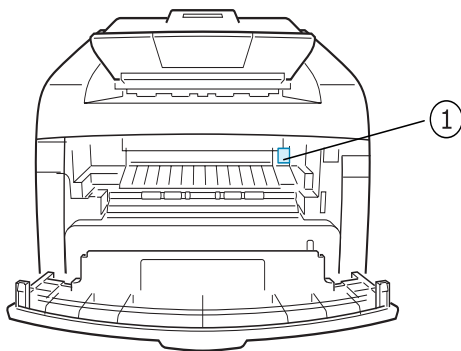

*This label is stuck to hot surfaces. Be careful not to touch these areas.

In accordance with IEC 60417, this machine uses the following symbols for the main power switch:

| means **POWER ON.**

○ means **POWER OFF.**

NOTICE

Note to users in the United States of America

Notice:

This equipment has been tested and found to comply with the limits for a Class B digital device, pursuant to Part 15 of the FCC Rules. These limits are designed to provide reasonable protection against harmful interference in a residential installation. This equipment generates, uses and can radiate radio frequency energy and, if not installed and used in accordance with the instructions, may cause harmful interference to radio communications. However, there is no guarantee that interference will not occur in a particular installation. If this equipment does cause harmful interference to radio or television reception, which can be determined by turning the equipment off and on, the user is encouraged to try to correct the interference by one more of the following measures:

- Reorient or relocate the receiving antenna.
 - Increase the separation between the equipment and receiver.
 - Connect the equipment into an outlet on a circuit different from that to which the receiver is connected.
 - Consult the dealer or an experienced radio /TV technician for help.
-

Caution

Changes or modifications not expressly approved by the party responsible for compliance could void the user's authority to operate the equipment.

Notice about the Telephone Consumer Protection Act (Valid in USA only).

The Telephone Consumer Protection Act of 1991 makes it unlawful for any person to use a computer or other electronic device, including FAX machines, to send any message unless such message clearly contains in a margin at the top or bottom of each transmitted page or on the first page of the transmission, the date and time it is sent and an identification of the business or other entity, or other individual sending the message and the telephone number of the sending machine or such business, other entity, or individual. (The telephone number provided may not be a 900 number or any other number for which charges exceed local or long-distance transmission charges.)

In order to program this information into your FAX machine, you should complete the following steps: Follow the FAX HEADER programming procedure in the Programming chapter of the operating instructions to enter the business identification and telephone number of the terminal or business. This information is transmitted with your document by the FAX HEADER feature. In addition to the information, be sure to program the date and time into your machine.

USA

◆ FCC Requirements

1. This equipment complies with Part 68 of the FCC rules and requirements adopted by the ACTA. On the cover of this equipment is a label that contains, among other information, a product identifier in the format US:AAAEQ##TXXXXX. If requested, this number must be provided to the telephone company.
2. This equipment uses the RJ11C USOC jack.
3. A plug and jack used to connect this equipment to the premises wiring and telephone network must comply with the applicable FCC Part 68 rules and requirements adopted by the ACTA. A compliant telephone cord and modular plug is provided with this product. It is designed to be connected to a compatible modular jack that is also compliant. See installation instructions for detail.
4. The REN is used to determine the number of devices that may be connected to a telephone line. Excessive RENs on a telephone line may result in the devices not ringing in response to an incoming call. In most but not all areas, the sum of RENs should not exceed five (5.0). To be certain of the number of devices that may be connected to a line, as determined by the total RENs, contact the local telephone company. The REN for this product is part of the product identifier that has the format US:AAAEQ##TXXXXX. The digits represented by ## are the REN without a decimal point (e.g., 03 is a REN of 0.3).
5. If this equipment causes harm to the telephone network, the telephone company will notify you in advance that temporary discontinuance of service may be required. But if advance notice is not practical, the telephone company will notify the customer as soon as possible. Also, you will be advised of your right to file a complaint with the FCC if you believe it is necessary.
6. The telephone company may make changes in its facilities, equipment, operations or procedures that could affect the operation of the equipment. If this happens the telephone company will provide advance notice in order for you to make necessary modifications to maintain uninterrupted service.
7. If trouble is experienced with this equipment, for repair or warranty information, please contact RICOH CORP. CUSTOMER SUPPORT DEPT. at 1-800-FASTFIX. If the equipment is causing harm to the telephone network, the telephone company may request that you disconnect the equipment until the problem is resolved.
8. In the event of operation problems (document jam, copy jam, communication error indication), refer to the solving problems section in this manual.
9. Connection to party line service is subject to state tariffs. Contact the state public utility commission, public service commission or corporation commission for information.

◆ WHEN PROGRAMMING EMERGENCY NUMBERS AND/OR MAKING TEST CALLS TO EMERGENCY NUMBERS:

1. Remain on the line and briefly explain to the dispatcher the reason for the call before hanging up.
2. Perform such activities in the off-peak hours, such as early morning hours or late evenings.

CANADA

The Ringer Equivalence Number is an indication of the maximum number of devices allowed to be connected to a telephone interface. The termination on an interface may consist of any combination of devices subject only to the requirement that the sum of the RENs of all the devices does not exceed five.

This product meets the applicable Industry Canada technical specifications.

Note:

This Class B digital apparatus complies with Canadian ICES-003.

Differences Between British and American English

British English	American English
(Re)dialling	(Re)dialing
Colour	Color
Emphasise	Emphasize
Recognise	Recognize
Organise	Organize
Authorise	Authorize
Cancelling	Canceling
Customise	Customize
Socket	Jack
Labelling	Labeling

WARNING

- Do not disassemble the machine as it may give you an electric shock.
- If you print large amount of copies, the surface of the output tray may become hot. Be careful not to touch the surface, especially for children.

CONTENTS

Chapter 1: GETTING STARTED

Setting Up Your Machine

Unpacking	1.2
Selecting a Location	1.4
Understanding the Component Location	1.5
Front View	1.5
Rear View	1.5
Control Panel Functions	1.6
Attaching Accessories	1.8
Document Output Support	1.8
Installing the Toner Cartridge	1.9
Loading Paper	1.11
Making Connections	1.15
Connecting to your computer	1.17
Turning the Machine On	1.18

Installing Software

About Software	1.19
Printer Driver Features	1.20
Installing Software in Windows	1.21
System Requirements	1.21
Installing Software In Windows	1.22
Repairing Software	1.24
Removing Software	1.26

Setting Up the Machine System

Changing the Display Language	1.27
Setting the Machine ID	1.28
Entering Characters Using the Number Keypad ..	1.29
Setting the Date and Time	1.31
Changing the Clock Mode	1.32
Setting the Paper Type and Size	1.32
Setting Sounds	1.33
Speaker, Ringer, Key Sound and Alarm Sound ...	1.33
Speaker Volume	1.34
Using the Save Mode	1.34
Power Save Mode	1.34

Chapter 2: PAPER HANDLING

Selecting Print Materials	2.2
Type, Input Sources and Capacities	2.2
Guidelines for Paper and Special Materials	2.3
Selecting an Output Location	2.4
Printing to the Front Output Tray (Face down)	2.5
Printing to the Rear Output Slot (Face up)	2.5
Loading Paper in the Paper Tray	2.7
Using the Manual Feeder	2.8
Setting the Paper Type and Size for the Manual Feeder	2.10

Chapter 3: COPYING

Loading Paper for Copying	3.2
Preparing a Document	3.2
Making a Copy	3.3
Setting Copy Options	3.4
Darkness	3.4
Original Type	3.5
Number of Copies	3.5
Reduced/Enlarged Copying	3.6
Changing the Default Settings	3.7
Setting the Time Out Option	3.8
Collation Copying	3.8

Chapter 4: FAXING

Sending a Fax

Changing the Fax Setup options	4.2
Available Fax Setup Options	4.3
Loading a Document	4.5
Adjusting the Document Resolution	4.6
Sending a Fax Automatically	4.7
Sending a Fax Manually	4.8
Redialing the Last Number	4.8
Confirming Transmission	4.9
Automatic Redialing	4.9

Receiving a Fax

About Receiving Modes	4.10
Loading Paper for Receiving Faxes	4.11
Receiving Automatically in Fax Mode	4.11
Receiving Automatically in Ans/Fax Mode	4.12

Receiving Manually in Tel Mode	4.12
Receiving Manually Using Remote Receive Start Code	4.13
Receiving Faxes Using the DRPD Mode	4.13
Receiving Faxes in the Memory	4.14

Automatic Dialing

One-touch Dialing	4.15
Storing a Number for One-touch Dialing	4.15
Sending a Fax using a One-touch Number	4.16
Speed Dialing	4.16
Storing a Number for Speed Dialing	4.16
Sending a Fax using a Speed Number	4.17
Group Dialing	4.18
Setting a Group Dial Number	4.18
Editing Group Dial Numbers	4.19
Sending a Fax Using Group Dialing (Multi-address Transmission)	4.20
Searching for a Number in the Memory	4.20
Searching Sequentially through the Memory	4.20
Searching with a Particular First Letter	4.21
Printing a Phone Book List	4.21

Advanced Fax Functions

Sending Broadcasting Faxes	4.22
Sending a Delayed Fax	4.23
Sending a Priority Fax	4.25
Polling a Remote Machine	4.26
Adding Documents to a Scheduled Fax	4.27
Canceling a Scheduled Fax	4.28

Additional Features

Using Secure Receiving Mode	4.29
Printing Reports	4.31
Using Advanced Fax Settings	4.33
Changing Setting Options	4.33
Advanced Fax Setting Options	4.34
Using the Remote Control Panel	4.36

Chapter 5: PRINTING

Printing a Document in Windows	5.2
Canceling a Print Job	5.5
Using a Favorite Setting	5.6
Using Help	5.6
Setting Paper Properties	5.7
Setting Graphic Properties	5.9
Printing Multiple Pages on One Sheet of the Paper ...	5.11

Printing a Reduced or Enlarged Document	5.13
Fitting Your Document to a Selected Paper Size	5.14
Printing Posters	5.15
Using Watermarks	5.16
Using an Existing Watermark	5.16
Creating a Watermark	5.17
Editing a Watermark	5.18
Deleting a Watermark	5.18
Using Overlays	5.19
What is an Overlay?	5.19
Creating a New Page Overlay	5.19
Using a Page Overlay	5.21
Deleting a Page Overlay	5.22
Setting Up the Locally Shared Printer	5.23
In Windows 9x/Me	5.23
In Windows NT 4.0/2000/XP	5.25

Chapter 6: SCANNING

Scanning Basics	6.2
Scanning Process with TWAIN-enabled Software	6.2

Chapter 7: MAINTENANCE

Clearing the Memory	7.2
Adjusting Shading	7.3
Cleaning Your Machine	7.3
Cleaning the Outside	7.3
Cleaning the Inside	7.4
Cleaning the Scanning Glass	7.5
Maintaining the Toner Cartridge	7.6
Redistributing Toner	7.7
Replacing the Toner Cartridge	7.8
Setting the Notify Toner Option	7.9
Cleaning the Drum	7.9
Ignoring the Toner Empty Message	7.10

Chapter 8: TROUBLESHOOTING

Clearing Document Jams	8.2
Clearing Paper Jams	8.3
In Tray 1	8.3
In Tray 2	8.4
In the Paper Exit Area	8.5
In the Fuser Area or Around the Toner Cartridge .	8.6
In the Manual Feeder	8.6
Tips for Avoiding Paper Jams	8.7
Clearing LCD Error Messages	8.8
Solving Problems	8.11
Paper Feeding Problems	8.11
Printing Problems	8.12
Printing Quality Problems	8.14
Copying Problems	8.19
Scanning Problems	8.20
Faxing Problems	8.21

Chapter 9: APPENDIX

Installing an Optional Tray	9.2
Setting Tray 2 in the Printer's Properties	9.3
Setting the Paper Type and Size for Tray 2	9.4
Specifications	9.5
General Specifications	9.5
Scanner Specifications	9.6
Copier Specifications	9.6
Printer Specifications	9.7
Facsimile Specifications	9.8
Paper Specifications	9.9

1

GETTING STARTED

Thank you for purchasing this multifunctional product. Your machine provides you with printing, copying, scanning, and faxing functions!

This chapter gives you step-by-step instructions for setting up your machine.

This chapter includes:

- **Setting Up Your Machine**
- **Installing Software**
- **Setting Up the Machine System**

Setting Up Your Machine

Unpacking

Remove the machine and all accessories from the packing carton. Make sure that the machine has been packed with the following items. If there is a missing item, contact the retailer where you bought the machine:

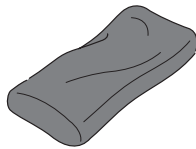

Starter Toner Cartridge

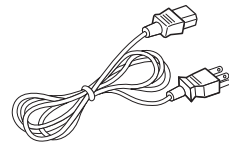

AC Power Cord*

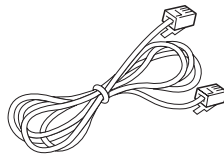

Telephone Line Cord*

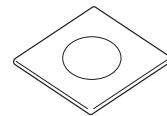

CD-ROM**

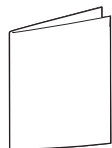

Quick Install Guide

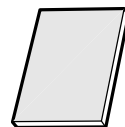

Quick Guide

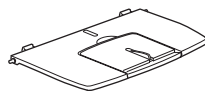

Document Output Support



USB Cable
(for America only)



Brand plaque***

(May already be affixed to the machine in some regions)

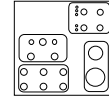

Key layout sheet

(for Europe only /May already be affixed to the machine in some regions)

* The appearance of the power cord and the telephone line cord may differ according to your country's specifications.

** The CD-ROM contains the Type 2200 Driver, the Operating Instructions and the Adobe Acrobat Reader program.

***Peel off the brand plaque's backing, and then stick down the plaque in the control panel's left corner.



NOTES:

- You should use the telephone line cord which is supplied with your machine. If you are replacing it with another vendor's, it should be AWG #26 or larger telephone line cord.
- The power cord must be plugged into a grounded power socket.
- Components may differ from one country to another.

Remove the packing tape from the front, back and sides of the machine.

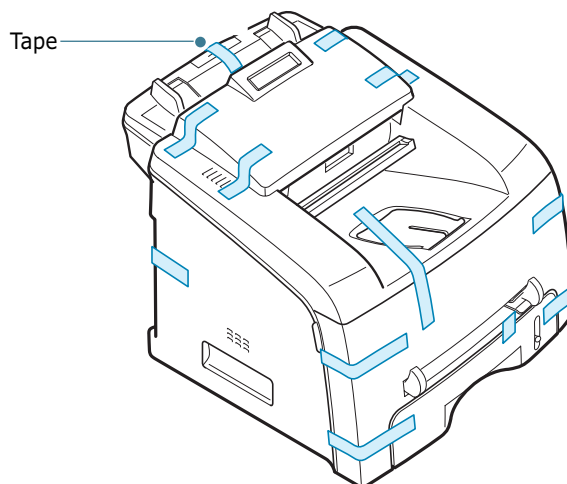

Selecting a Location

Select a level, stable place with adequate space for air circulation. Allow extra space for opening covers and trays.

The area should be well-ventilated and away from direct sunlight or sources of heat, cold and humidity. Do not set the machine close to the edge of your desk or table.

Clearance Space

- **Front:** 482.6 mm (enough space so that the paper tray can be removed)
- **Back:** 250 mm (enough space for ventilation)
- **Right:** 100 mm
- **Left:** 100 mm (enough space for ventilation)

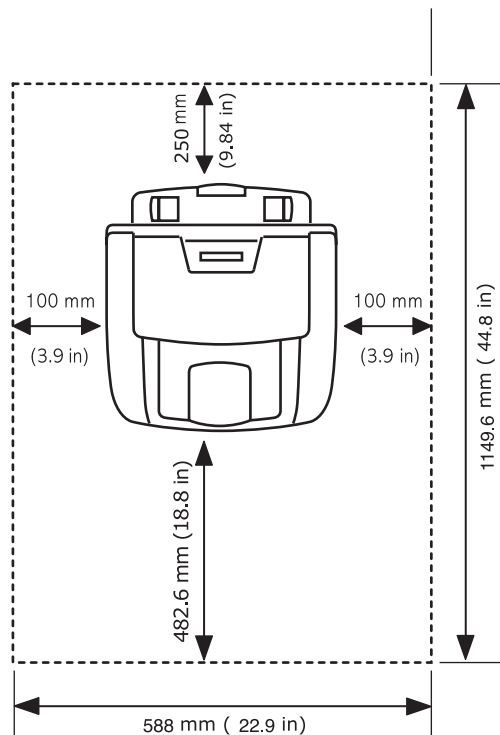

Understanding the Component Location

These are the main components of your machine:

Front View

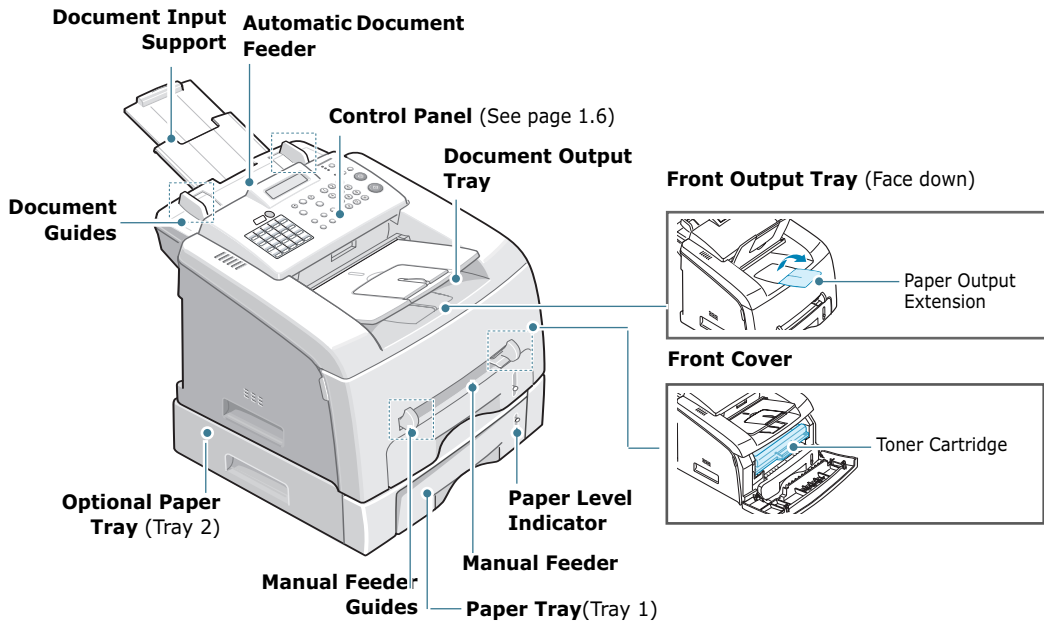



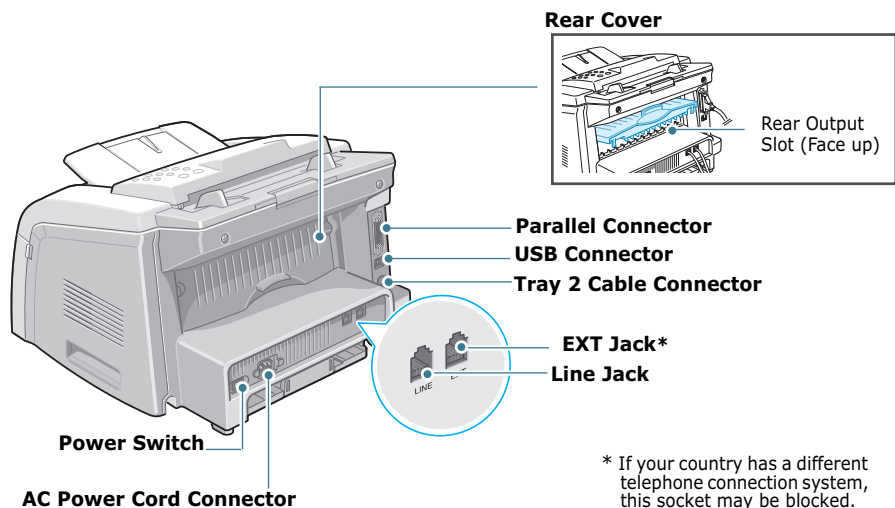



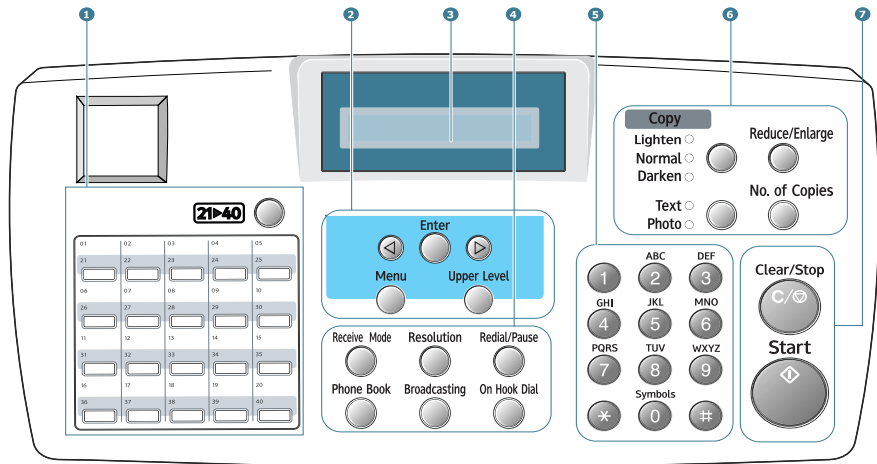





Rear View



Control Panel Functions



1		Use to store frequently-dialed fax number and dial them with a touch of the buttons.
		Allows you to shift the one-touch buttons to the numbers 21 through 40.
2		Scrolls through the options available for the selected menu item.
		Confirms the selection on the display.
		Enters Menu mode and scrolls through the menus available.
		Returns you to the upper menu level.
3		Displays the current status and prompts during an operation.

4 F A X	Receive Mode 	Allows you to select the fax receiving mode.
	Phone Book 	<ul style="list-style-type: none"> Allows you to store frequently-dialed fax numbers using a one or two-digit speed dial or group number for automatic dialing and edit the stored numbers. Allows you to print a Phone book list.
	Resolution 	Adjusts the resolution of the documents for the current fax job.
	Broadcasting 	Allows you to send a fax to multiple destinations.
	On Hook Dial 	Engages the telephone line.
	Redial / Pause 	Redials the last number in Standby mode or inserts a pause into a fax number in Edit mode.
5		Dials a number or enters alphanumeric characters.
6 C O P Y	Lighten <input type="radio"/> Normal <input type="radio"/> Darken <input type="radio"/> 	Adjusts the brightness of the documents for the current copy job. *1 This button is called "Darkness" in this manual.
	Text <input type="radio"/> Photo <input type="radio"/> 	Selects the document type for the current copy job. *2 This button is called "Original Type" in this manual.
	Reduce/Enlarge 	Makes a copy smaller or larger than the original document.
	No. of Copies 	Selects the number of copies.
7	Clear/Stop 	Stops an operation at any time. In Standby mode, clears/stop the copy options, such as the darkness, the document type setting, the copy size and the number of copies.
	Start 	Starts a job.

Attaching Accessories

Document Output Support

Insert the two tabs on the supplied document output support into the slots on both sides of the paper output tray.

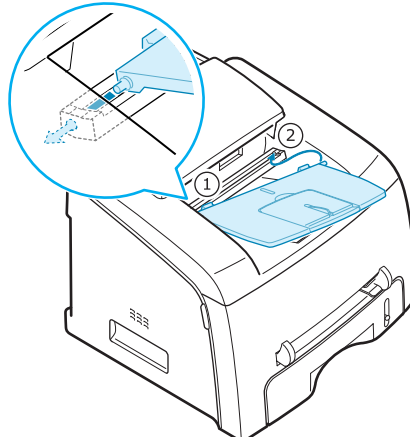

Fold out the extender, if necessary.



NOTE: When detaching the document output tray, detach it by pressing the front portion of document output tray as seen from the picture. As this time, even though the dull sound is heard the components are safe from damage.

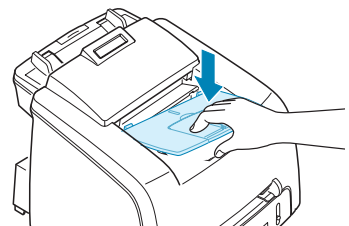

Installing the Toner Cartridge

- 1 Open the front cover.

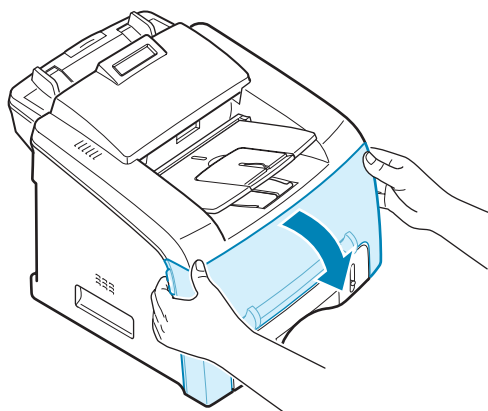

- 2 Remove the starter toner cartridge from its bag. Gently roll the cartridge 5 or 6 times to distribute the toner evenly inside the cartridge.

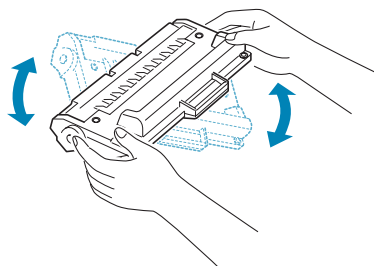

Thoroughly rolling the cartridge will assure the maximum copies per cartridge.



NOTES:

- To prevent damage, do not expose the toner cartridge to light for more than a few minutes. Cover it with a piece of paper, if left exposed for more than a few minutes.
- If toner gets on your clothing, wipe it off with a dry cloth and wash clothing in cold water. Hot water sets toner into fabric.

- 3 Slide the toner cartridge into the machine until it locks into place completely.

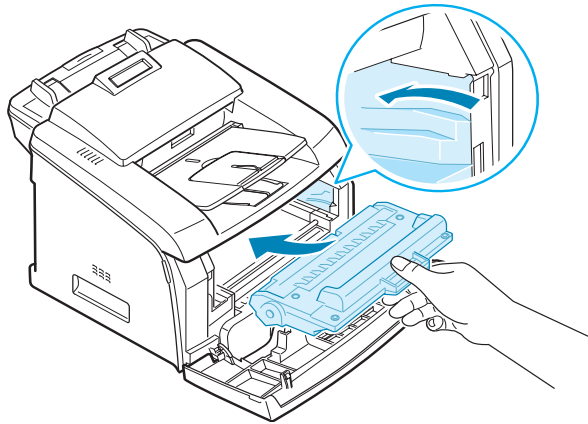

- 4 Close the front cover. Make sure that the cover is securely closed.

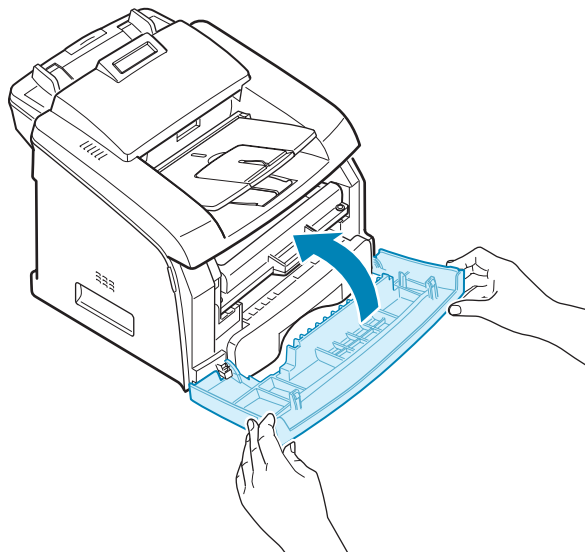

Loading Paper

You can load approximately 250 sheets.

To load a stack of Letter-sized paper:

- 1 Pull open the paper tray and remove it from the machine.



- 2 Push down on the pressure plate until it locks into place.

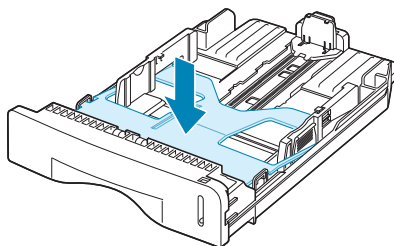

- 3 Fan the edges of the paper stack to separate the pages. Then tap the stack on a flat surface to even it up.

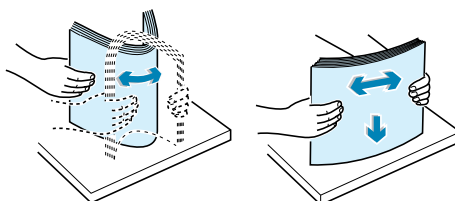

- 4 Insert the paper stack into the paper tray with the side you want to print facing up.

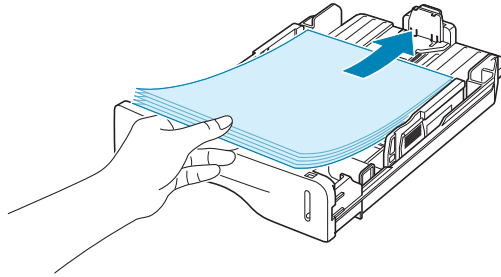

NOTE: If you want to load a different size of paper, you need to adjust the paper guides. For details, see page 1.13.

- 5 Pay attention to the paper limit mark on the left inside wall of the tray. Paper overloading may cause paper jams.

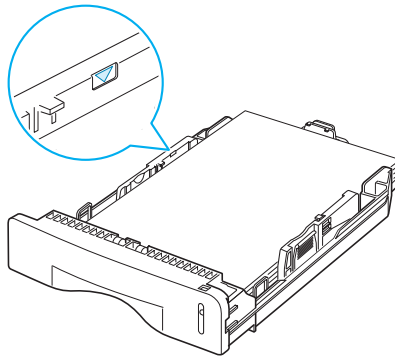

- 6 Insert and slide the paper tray back into the machine.

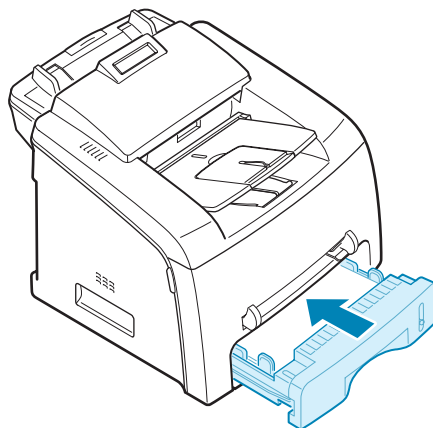

NOTE: After you load the paper, you need to set up your machine for the paper type and size you loaded. See page 1.32 for copying and faxing, or page 5.7 for PC-printing.

Changing the Paper Size in the Paper Tray

To load longer sizes of paper, such as Legal-sized paper, you need to adjust the paper guides to extend the paper tray.

- 1 After pressing and unlatching the guide lock, slide the paper length guide out completely to extend the paper tray to its full length.

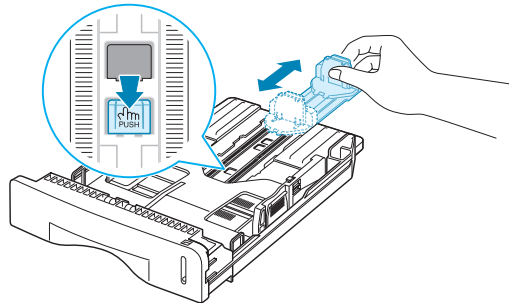

- 2 After inserting paper into the tray, slide in the guide until it lightly touches the end of the paper stack.

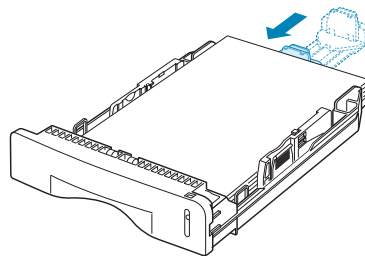

For the paper smaller than Letter, adjust the front paper length guide.

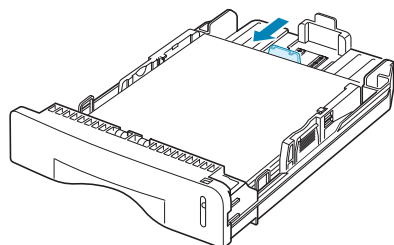

- 3** Pinching the paper width guide as shown, move it toward the stack of paper until it lightly touches the side of the stack.

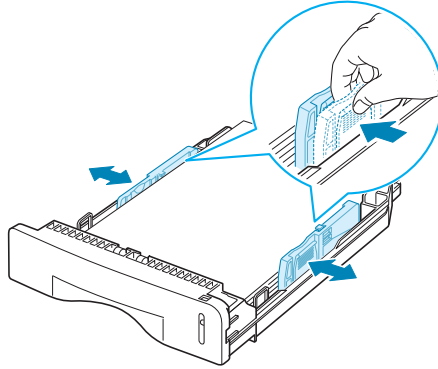

NOTES:

- Do not push the paper width guide far enough to cause the materials to warp.
- If you do not adjust the paper width guide, it may cause paper jams.

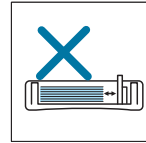
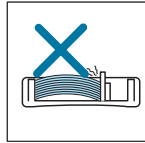
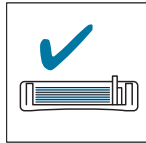

Making Connections

Plug the telephone line cord into the **LINE** jack and the other end into the wall jack.

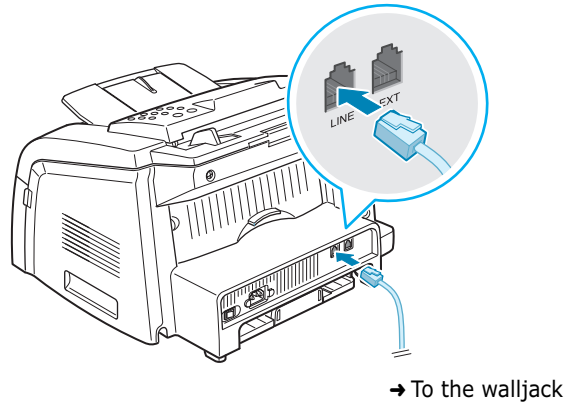

If you want to use your machine for receiving both faxes and voice calls, you will need to connect a telephone and/or answering machine to your machine.

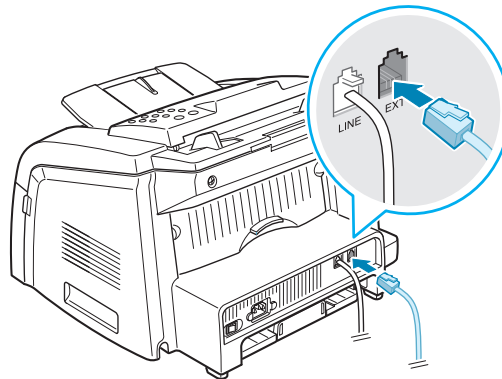

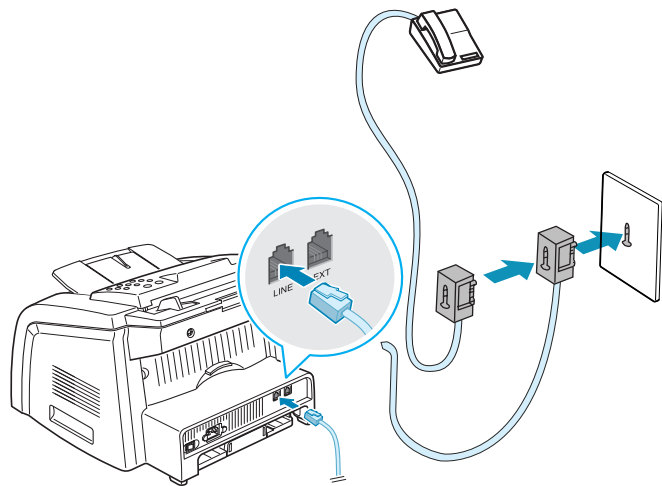
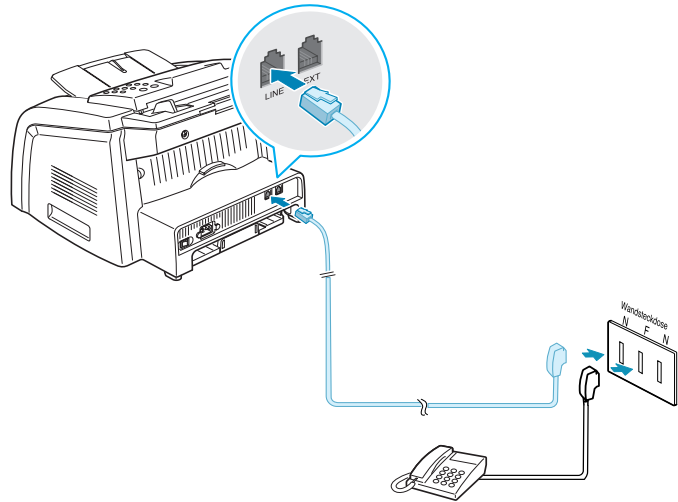

NOTE: In the United Kingdom, if a three-wire type (SHUNT-wire, older equipment) telephone or answering machine is connected to the EXT jack on the machine, the external equipment will fail to ring when receiving an incoming call as the machine is designed to operate with the latest technology. To prevent this incompatibility, use two-wire (newer equipment) telephone or answering machines.

Connecting to your computer

Plug the USB printer cable into the connector on the back of the printer.

You must use a USB 2.0 compliant cable that is no more than 3 m in length.

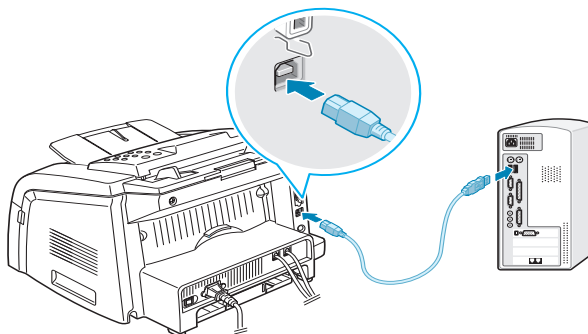

If you want to use a parallel printer cable, purchase only IEEE 1284 compliant parallel cable and connect it to the parallel connector on your machine.

Push the metal clips down to fit inside the notches on the cable plug.

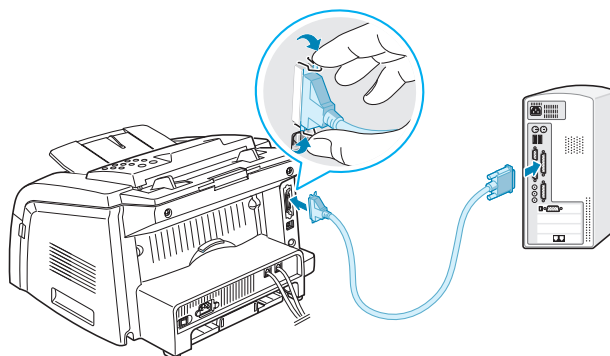

NOTES:

- You only need to connect one of the cables mentioned above. Do not use the parallel and the USB cables at the same time.
- If you are using a USB cable, you must be running Windows 98/Me/2000/XP.
- When using the USB connection, your machine provides two USB modes; Fast and Slow. Fast is the default mode. Some PC users may experience poor USB function in the default mode. If this occurs, select the Slow mode to achieve successful results. For details about changing the USB mode.

Turning the Machine On

- 1 Plug one end of the supplied three-pronged electrical type cord into the AC socket on the machine and the other end into a properly grounded AC outlet.
- 2 Press the power switch to turn the machine on.

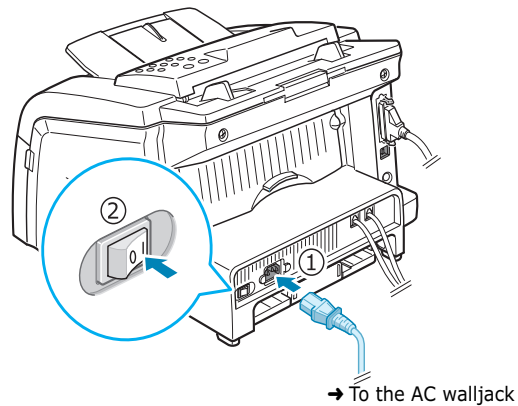

To view your display text in another language, see page 1.27.



WARNINGS:

- The fusing area inside the rear part of your machine becomes hot once the machine is turned on. Be careful when you access this area.
 - Do not disassemble the machine when it is turned on as it may give you an electric shock.
-

About Software

You must install software using the supplied CD-ROM after you have set up your machine and connected it to your computer. The CD-ROM includes:

- Software
- Operating Instructions
- Adobe Acrobat Reader

The CD-ROM provides you with the following software:

Type 2200 Driver

To use your machine as a printer and scanner in Windows, you must install the Type 2200 driver. For information about installing the Type 2200 driver in Windows, see page 1.21.

Remote Control Panel

This Windows-based program is automatically installed when you install the Type 2200 driver. For information about using the program, see page 4.36.

Printer Driver Features

Your printer drivers support the following standard features:

- Paper source selection
- Paper size, orientation and media type
- number of copies

The following table lists a general overview of features supported by your printer drivers.

Feature	Printer Driver		
	Win9x/Me	Win2000/XP	WinNT4.0
Toner Save	Y	Y	Y
Print quality option	Y	Y	Y
Poster printing	Y	Y	Y
Multiple pages per sheet (N-up)	Y	Y	Y
Fit to page printing	Y	Y	Y
Scale printing	Y	Y	Y
Watermark	Y	Y	Y
Overlay	Y	Y	Y

Installing Software in Windows

System Requirements

Before you begin, ensure that your system meets the minimum requirements.

Supported Operating System

- Windows 95 OSR2
- Windows 98/Windows 98 SE
- Windows Me
- Windows NT 4 Workstation or Server with Service Pack 3
- Windows 2000 Professional or Advanced Server
- Windows XP Home edition or Professional.

Minimal Requirements

- Disk space: 120 MB for installation
- Memory: 64 MB
- CPU: Pentium II 233 or higher
- Required software: Internet Explorer 4.01

Recommended

- Disk space: 300 MB for installation
- Memory: 128 MB
- CPU: Pentium II 400 or higher
- Required software: Internet Explorer 5.5



NOTES:

- For Windows NT 4.0/2000/XP, the system administrator should install software.
 - Windows 95 versions prior to OSR2 are not recommended due to incompatibility with OLE/COM libraries.
-

Installing Software In Windows



NOTES:

- Cancel the "**New Hardware Found**" window when your computer boots up.
- Make sure that your machine is turned on and connected to your computer's parallel port or USB port **before installing software**. Windows 95 and Windows NT 4.0 do not support the USB connection.

- 1 Insert the supplied CD-ROM into your CD-ROM drive.

The CD-ROM should automatically run and an maintenance window appears.

If the maintenance window does not appear, click **Start** and then **Run**. Type **X:\Setup.exe**, replacing "**X**" with the letter of your drive and click **OK**.



NOTES: If your machine is not connected to the computer, the following window will appear.

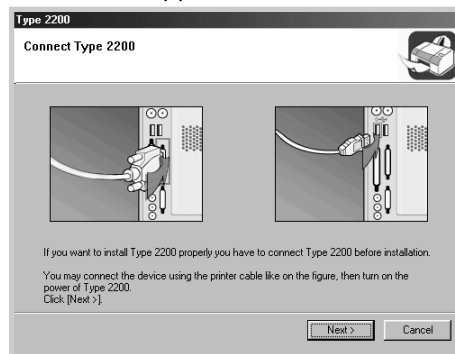

- After connecting the machine, click **Next**.
- If you want to skip the connection status, click Next, and No to the following screen. Then the installation will start and the test page will not be printed at the end of the installation.

2 Choose the installation type.

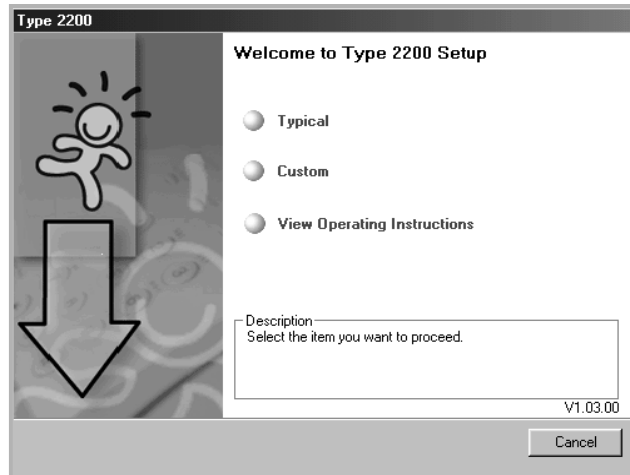

- **Typical:** Installs the common software for your printer, such as printer driver, Twain driver, Remote Control Panel. This is recommended for most users.
- **Custom:** Allows you to choose the language of the software and the components you want to install. After selecting the language and the component(s), click **Next**.

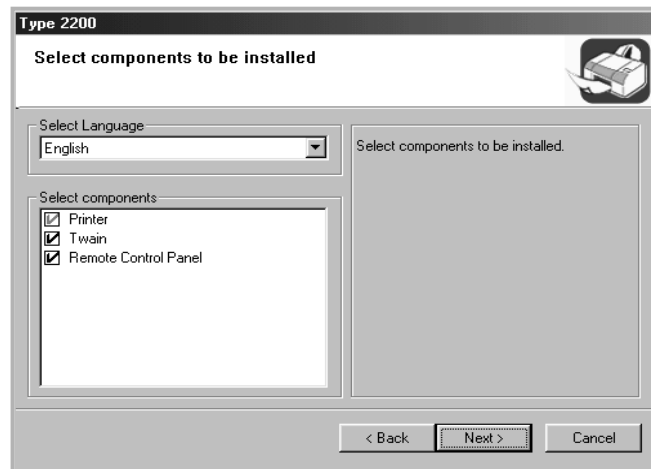

- **View Operating Instructions:** Allows you to view this Operating Instructions. If your computer doesn't have Adobe Acrobat, click on this option and it will automatically install Adobe Acrobat for you.

3 After the installation is finished, the window asking you to print a test page appears. If you choose to print a test page, select the check box and click **Next**.

4 When the test page prints out correctly, click **Yes**.

If not, click **No** to reprint it.

5 Click **Finish**.

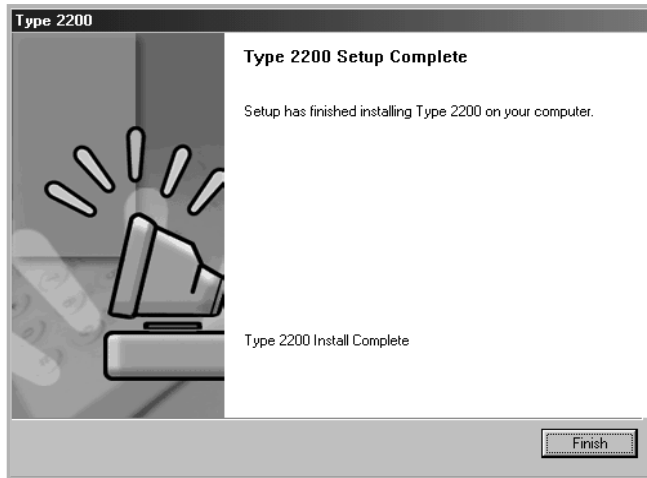

NOTES:

- When you want to use your machine with the parallel cable, remove the USB cable and connect the parallel cable. Then reinstall the printer driver; select **Start** → **Programs** → **Type 2200** → **Maintenance** → **Repair** → **Printer**. If you have replaced the parallel cable with the USB cable, do the same to reinstall the driver.
- If your printer doesn't work properly, reinstall the printer driver.

Repairing Software

Repairing is required if your installation fails or software does not work properly.

- 1 You can select **Start** → **Programs** → **Type 2200** → **Maintenance**.

Otherwise, insert the supplied CD-ROM into your CD-ROM drive.

The CD-ROM should automatically run and an maintenance window appears.

If the maintenance window does not appear, click **Start** and then **Run**. Type **X:\Setup.exe**, replacing "X" with the letter of your drive and click **OK**.

- 2 Click **Repair**.



NOTE: If your machine is not connected to the computer, the following window will appear.

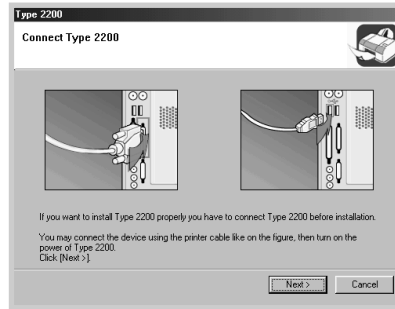

- After connecting the machine, click **Next**.
- If you want to skip the connection status, click Next, and No to the following screen. Then the installation will start and the test page will not be printed at the end of the installation.

3 Select the components you want to reinstall and click **Next**.

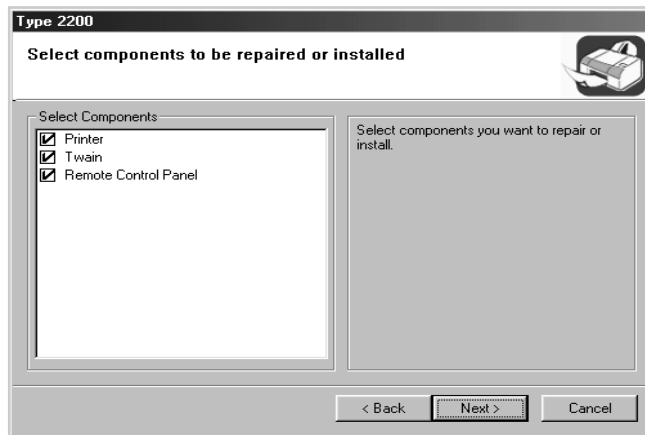

4 After the installation is finished, the window asking you to print a test page appears. If you choose to print a test page, select the check box and click **Next**.

5 When the test page prints out correctly, click **Yes**.
If not, click **No** to reprint it.

6 When the reinstallation is done, click **Finish**.

Removing Software

Uninstall is required if you are upgrading software or if your installation fails.

- 1 You can select **Start** → **Programs** → **Type 2200** → **Maintenance**.

Otherwise, insert the supplied CD-ROM into your CD-ROM drive.

The CD-ROM should automatically run and an maintenance window appears.

If the maintenance window does not appear, click **Start** and then **Run**. Type **X:\Setup.exe**, replacing "X" with the letter of your drive and click **OK**.

- 2 Click **Remove**.

Then you will see a component list so that you can remove any of them individually.

If you want to uninstall the printer driver, check **Printer**.

If you want to uninstall the Twain driver, check **Twain**.

If you want to uninstall the Remote Control Panel, check **Remote Control Panel**.

- 3 After selecting items you wish to remove, click **Next**.

- 4 When your computer asks you to confirm your selection, click **Yes**.

The selected driver and all of its components are removed from your computer.

- 5 When the uninstallation is done, click **Finish**.

Setting Up the Machine System

Changing the Display Language

To change the language that displays on the display of the control panel, follow these steps:

- 1** Press **Menu** until "Machine Setup" appears on the top line of the display.
- 2** Press the scroll button (◀ or ▶) until "Language" appears on the bottom line of the display.
- 3** Press **Enter**. The current setting appears on the bottom line of the display.
- 4** Press the scroll button (◀ or ▶) until the language you want appears on the display.
- 5** Press **Enter** to save the selection.
- 6** To return to Standby mode, press **Clear/Stop**.

Setting the Machine ID

In some countries, you are required by law to indicate your fax number on any fax you send. The Machine ID, containing your telephone number and name or company name, will be printed at the top of each page sent from your machine.

- 1 Press **Menu** until "Machine Setup" appears on the top line of the display. The first available menu item, "Machine ID" displays on the bottom line.
- 2 Press **Enter**. The display asks you to enter the fax number.
If there is a number already set, the number appears.
- 3 Enter your fax number using the number keypad.



NOTE: If you make a mistake while entering numbers, press the ◀ button to delete the last digit.

- 4 Press **Enter** when the number on the display is correct. The display asks you to enter the ID.
- 5 Enter your name or company name using the number keypad.

You can enter alphanumeric characters using the number keypad, and include special symbols by pressing the **0** button.

For details on how to use the number keypad to enter alphanumeric characters, see page 1.29.

If you want to enter the same letter or number in succession (e.g. SS, AA, 777), enter one digit, move the cursor by pressing the ▶ button and enter the next digit.



NOTE: When "Id" is printed at the top of each page you transmit, only the first 20 digits can be printed on the pages received at the other end.

If you want to insert a space in the name, you can also use the ▶ button to move the cursor to skip the position.

- 6 Press **Enter** when the name on the display is correct.
- 7 Press **Clear/Stop** to return to Standby mode.

Entering Characters Using the Number Keypad

As you perform various tasks, you need to enter names and numbers. For example, when you set up your machine, you enter your name or your company's name and telephone number. When you store one or two digit speed dial or group dial numbers, you may also enter the corresponding names.

To enter alphanumeric characters:

- 1 When you are prompted to enter a letter, locate the button labeled with the character you want. Press the button until the correct letter appears on the display.

For example, to enter the letter **O**, press **6**, labeled with "MNO."

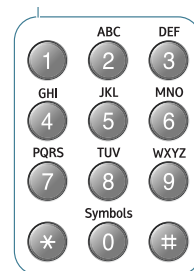

Each time you press **6**, the display shows a different letter, **M**, **N**, **O** and finally **6**.

You can enter special characters, such as space, plus sign, and so on. For details, see "Keypad Letters and Numbers" on page 1.30.

- 2 To enter additional letters, repeat step 1.

If the next letter is printed on the same button, move the cursor by pressing the **▷** button and then press the button labeled with the letter you want. The cursor moves to the right and the next letter appears on the display.

You can enter a space by pressing the **#** button.

- 3 When you finish entering letters, press **Enter**.

Keypad Letters and Numbers

Key	Assigned numbers, letters or characters
1	1 Space
2	A B C 2
3	D E F 3
4	G H I 4
5	J K L 5
6	M N O 6
7	P Q R S 7
8	T U V 8
9	W X Y Z 9
0	+ - , . ' / * # & 0

Changing Numbers or Names

If you make a mistake while entering a number or name, press the < button to delete the last digit or character. Then enter the correct numbers or characters.

Inserting a Pause

With some telephone systems, you must dial an access code (9, for example) and listen for a second dial tone. In such cases, you must insert a pause in the telephone number. You can insert a pause while you are setting up one-touch or speed dial numbers.

To insert a pause, press **Redial/Pause** at the appropriate place while entering the telephone number. A "--" appears on the display at the corresponding location.

Setting the Date and Time

The current date and time are shown on the display when your machine is on and ready to work. All of your faxes will have the date and time printed on them.



NOTE: If power to the machine is cut off, you need to reset the correct time and date once the power is restored.

- 1 Press **Menu** until "Machine Setup" appears on the top line of the display.
- 2 Press the scroll button (◀ or ▶) to display "Date & Time" on the bottom line and press **Enter**.
- 3 Enter the correct time and date using the number keypad.

Month	= 01 ~ 12
Day	= 01 ~ 31
Year	= requires all four digits
Hour	= 01 ~ 12 (12-hour mode)
	00 ~ 23 (24-hour mode)
Minute	= 00 ~ 59



NOTE: The date format may differ from each country.

You can also use the scroll button (◀ or ▶) to move the cursor under the digit you want to correct and enter a new number.

- 4 To select "AM" or "PM" for 12-hour format, press the * or # button or any number button.

When the cursor is not under the AM or PM indicator, pressing the * or # button immediately moves the cursor to the indicator.

You can change the clock mode to 24-hour format (e.g. 01:00 PM as 13:00). For details, see page 1.32.

- 5 Press **Enter** when the time and date on the display is correct.

When you enter a wrong number, the machine beeps and does not proceed to the next step. If this happens, just reenter the correct number.

Changing the Clock Mode

You can set your machine to display the current time using either 12-hour or 24-hour format.

- 1 Press **Menu** until "Machine Setup" appears on the top line of the display.
- 2 Press the scroll button (◀ or ▶) until you see "Clock Mode" on the bottom line and press **Enter**.
The clock mode currently set for the machine displays.
- 3 Press the scroll button (◀ or ▶) to select the other mode and then press **Enter** to save the selection.
- 4 To return to Standby mode, press **Clear/Stop**.

Setting the Paper Type and Size

After loading paper in the paper tray, you need to set the paper type and size using the control panel buttons. These settings will apply to Fax and Copy modes. For PC-printing, you need to select the paper type and size in the application program you use.

- 1 Press **Menu**.
The display shows "Paper Setting" on the top line and the first menu item, "Paper Type," on the bottom line.
- 2 Press **Enter** to access the menu item.
- 3 Use the scroll button (◀ or ▶) to find the paper type you are using and press **Enter** to save it.
- 4 Press the ▶ button to scroll to "Paper Size" and press **Enter** to access the menu item.
- 5 Press **Enter** when "Tray 1 Size" displays on the bottom line.
- 6 Use the scroll button (◀ or ▶) to find the paper size you are using and press **Enter** to save it.
- 7 To return to Standby mode, press **Clear/Stop**.

Setting Sounds

You can control the following sounds:

- **Ringer:** You can adjust the ringer volume.
- **Key Sound:** With this option set to "On," a key tone sounds each time any key is pressed.
- **Alarm Sound:** You can turn the alarm sound on or off. With this option set to "On," an alarm tone sounds when an error occurs or fax communication ends.
- **Speaker:** You can turn on or off the sounds from the telephone line through the speaker, such as a dial tone or a fax tone. With this option set to "Comm.," the speaker is on until the remote machine answers.

You can adjust the speaker volume level using the **On Hook Dial** button.

Speaker, Ringer, Key Sound and Alarm Sound

- 1** Press **Menu** until "Sound/Volume" appears on the top line of the display.
- 2** Press the scroll button (◀ or ▶) to scroll through the options. Press **Enter** when you see the sound option you want.
- 3** Press the scroll button (◀ or ▶) to display the status or loudness you want for the option you have selected.

For the ringer volume, you can select from "Off", "Low", "Med" and "High". Setting "Off" means that the ringer turns off. The machine works normally even if the ringer is turned off.

- 4** Press **Enter** to save the selection.
- 5** If necessary, repeat steps 2 through 4.
- 6** To return to Standby mode, press **Clear/Stop**.

Speaker Volume

To adjust the volume using the **On Hook Dial** button:

- 1 Press **On Hook Dial**. A dial tone sounds from the speaker.
- 2 Press the scroll button (◀ or ▶) until you hear the loudness you want. The display shows the current volume level.
- 3 Press **Clear/Stop** to save the change and return to Standby mode.

Using the Save Mode

Power Save Mode

Power Save mode allows your machine to reduce power consumption when it is not in actual use. You can turn this mode on by selecting the length of time for which the machine waits after a job is printed before it switches to a reduced power state.

- 1 Press **Menu** until "Machine Setup" appears on top line of the display.
- 2 Press the scroll button (◀ or ▶) until "Power Save" appears on the bottom line. Press **Enter**.
- 3 Press the scroll button (◀ or ▶) to display "On" on the bottom line and press **Enter**.
Selecting "Off" means that Power Save mode turns off.
- 4 Press the scroll button (◀ or ▶) until the time settings you want appears.
The available options are 5, 10, 15, 30 and 45 (minutes).
- 5 Press **Enter** to save the selection.
- 6 To return to Standby mode, press **Clear/Stop**.



2

PAPER HANDLING

This chapter introduces you to the basics of selecting print materials and loading them into your machine.

This chapter includes:

- **Selecting Print Materials**
- **Selecting an Output Location**
- **Loading Paper in the Paper Tray**
- **Using the Manual Feeder**

Selecting Print Materials

You can print on a variety of print materials, such as plain paper, envelopes, labels, transparencies and so on. Always use print materials that meet the guidelines for use with this machine. See "Paper Specifications" on page 9.9. To get the best possible print quality, use only high-quality copier-grade paper.

When you choose print materials, consider the following:

- **Desired outcome:** The paper you choose should be appropriate for your project.
- **Size:** You can use any size paper that fits easily within the paper adjusters of the paper tray.
- **Weight:** Your machine supports paper weights as follows:
 - 16 ~ 24 lb (60 ~ 90 g/m²) bond for the standard paper tray (Tray 1) and optional paper tray (Tray 2)
 - 16 ~ 43 lbs (60 ~ 163 g/m²) bond for the manual feeder
- **Brightness:** Some papers are whiter than others and produce sharper, more vibrant images.
- **Surface smoothness:** The smoothness of the paper affects how crisp the printing looks on the paper.



NOTE: Using print materials that do not conform to the specifications listed on page 9.9 may cause problems that may require service. This service is not covered by the warranty or service agreements.

Type, Input Sources and Capacities

Paper Type	Input Source/Capacity*		
	Tray 1	Optional Tray 2	Manual Feeder
Plain paper	250	250	1
Envelopes	-	-	1
Labels	-	-	1
Transparencies	-	-	1
Card stocks	-	-	1

* Maximum capacity may be reduced depending on the paper thickness.

Guidelines for Paper and Special Materials

When selecting or loading paper, envelopes, or other special material, keep these guidelines in mind:

- Always use paper and other materials that conform with the specifications listed under "Paper Specifications" on page 9.9.
- Attempting to print on damp, curled, wrinkled, or torn paper can cause paper jams and the poor print quality.
- Use only high quality copier grade paper for the best print quality.
- Avoid paper with embossed lettering, perforations, or a texture that is too smooth or too rough. Paper jams may occur.
- Store paper in its ream wrapper until you are ready to use. Place cartons on pallets or shelves, not on the floor. Do not place heavy objects on top of the paper, whether it is packaged or unpackaged. Keep it away from moisture, or other conditions that can cause it to wrinkle or curl.
- Store unused materials at temperatures between 15 °C and 30 °C (59 °F to 86 °F). The relative humidity should be between 10 % and 70 %.
- During storage, you should use moisture-proof wrap, such as any plastic container or bag, to prevent dust and moisture from contaminating your paper.
- Load special paper types one sheet at a time.
- Only use materials specifically recommended for use in laser printers.
- To prevent special materials, such as transparencies and label sheets from sticking together, remove them as they prints out.
- For envelopes:
 - Use only well-constructed envelopes with sharp, well creased folds.
 - Do not use envelopes with clasps and snaps.
 - Do not use envelopes with windows, coated lining, self-adhesive seals, or other synthetic materials.
 - Do not use damaged or poorly made envelopes.
- For transparencies:
 - Place them on a flat surface after removing them from the machine.
 - Do not leave them in the paper tray for long periods of time. Dust and dirt may accumulate on them resulting in spotty printing.
 - To avoid smudging caused by fingerprints, handle them and coated paper carefully.

- To avoid fading, do not expose the printed transparencies to prolonged sunlight.
- For labels:
 - Verify that their adhesive material can tolerate fusing temperature of 200 °C (392° F) for 0.1 second.
 - Make sure that there is no exposed adhesive material between them. Exposed areas can cause labels to peel off during printing, which can cause paper jams. Exposed adhesive can also cause damage to machine components.
 - Do not load a sheet of them through the machine more than once. The adhesive backing is designed for one pass through the machine.
 - Do not use labels that are separating from the backing sheet or are wrinkled, bubbled, or otherwise damaged.
- Do not use **Carbonless** paper and **Tracing** paper. They could make smell of chemicals and damage your machine.

Selecting an Output Location

The machine has two output locations; the rear output slot (face up) and the front output tray (face down).

To use the front output tray, make sure that the rear cover is closed. To use the rear output slot, open the rear cover.



NOTES:

- If paper coming out of the front output tray has problems, such as excessive curl, try printing to the rear output slot.
 - To avoid paper jams, do not open or close the rear cover while the machine is printing.
-

Printing to the Front Output Tray *(Face down)*

The front output tray collects printed paper face-down in correct order. The tray should be used for most print jobs.

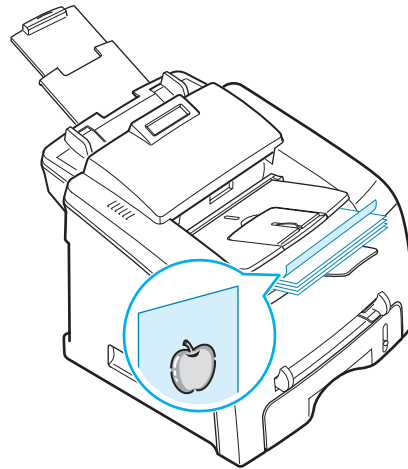

Printing to the Rear Output Slot *(Face up)*

Using the rear output slot, paper comes out of the machine face up.

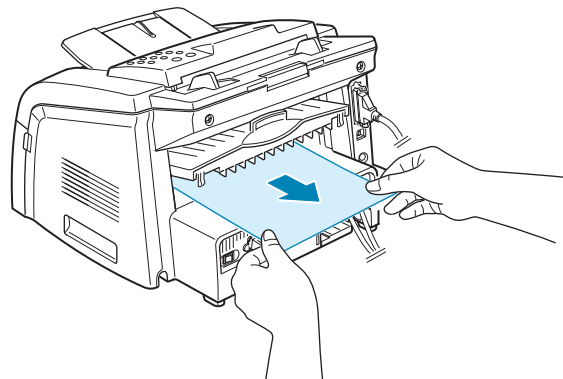

Printing from the manual feeder to the rear output slot provides the **straight paper path**. Using the rear output slot might improve the output quality with the following:

- envelopes
- labels
- small custom-sized paper
- postcards
- transparencies

To use the rear output slot:

- 1 Open the rear cover by pulling it upward.

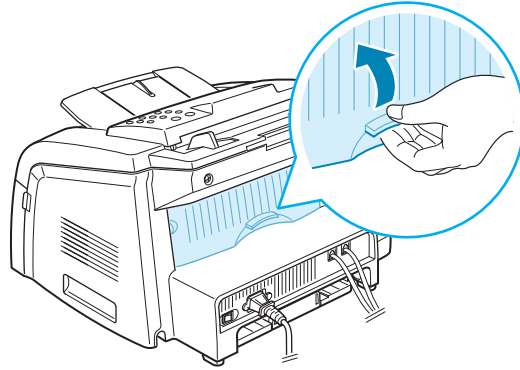

WARNING: The fusing area inside the rear part of your machine becomes hot once the machine is turned on. Be careful when you access this area.

- 2 If you do not want to use the rear output slot, close the rear cover. The pages stack on the front output tray.

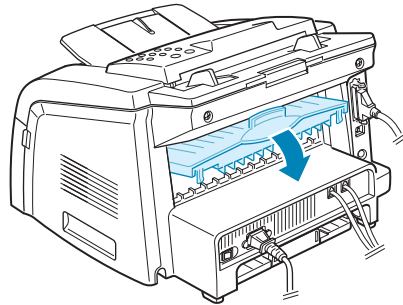

Loading Paper in the Paper Tray

The paper tray can hold a maximum of 250 sheets of 20 lb plain paper. For faxing and copying, you can use A4-, Letter- or Legal-sized paper only. For PC-printing, you can use many different sizes of paper; see page 9.9.

The paper level indicator on the front of the paper tray shows the amount of paper currently left in the tray. When the tray is empty, the indicator of the bar is lowered.

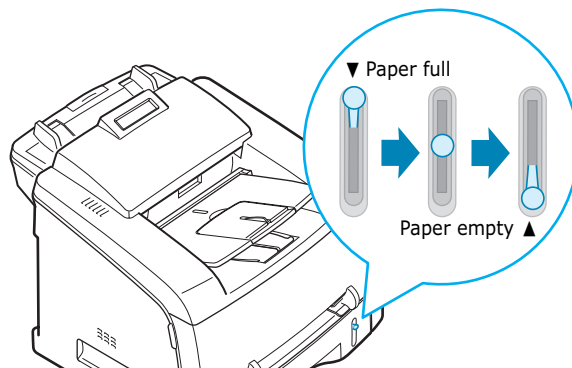

To load paper, pull open the paper tray and load paper with the print side face down.

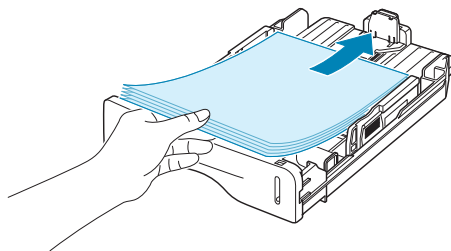

You can load letterhead paper with the design side face down. The top edge of the sheet with the logo should be placed at the front side of the tray.

For details about loading paper in the paper tray, see "Loading Paper" on page 1.11.



NOTES:

- If you experience problems with paper feed, place the paper in the manual feeder.
- You can load up to 150 sheets of previously printed paper. The printed side should be facing up with an uncurled edge at the top side. If you experience problems with paper feed, turn the paper around. Note that the print quality is not guaranteed.

Using the Manual Feeder

Use the manual feeder to print transparencies, labels, envelopes or postcards in addition to making quick runs of paper types or sizes that are not currently loaded in the paper tray.

Postcards, 3.5 by 5.83 in.(index) cards and other custom-sized materials can be printed with this printer. The minimum size is 76 by 127 mm (3.0 by 5.0 in.) and the maximum size is 216 by 356 mm (8.5 by 14 in.)

Acceptable print materials are plain paper with sizes ranging from 100 x 148 mm (3.9 x 5.8 in.) to Legal, 216 x 356 mm (8.5 x 14 in.), the largest size acceptable, and weighing between 16 lb and 32 lb.



NOTES:

- Always load only the print materials specified in the Specifications on page 9.9 to avoid paper jams and print quality problems.
- Flatten any curl on postcards, envelopes and labels before loading them into the manual feeder.
- When you print on 76 mm X 127 mm (3 X 5 in.) sized media with loading into the tray, open the rear output tray.

-
- 1** Load a sheet of the print material with the print side face up into the center of the manual feeder.

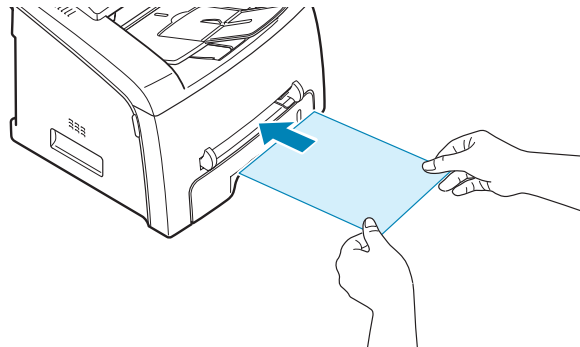

For envelopes, load a sheet with the flap side face down and with the stamp area on the top left side.

For transparencies, hold them by the edges and avoid touching the print side. Oils from your fingers can cause print quality problems.



NOTE: You must open the rear output slot when you print on transparencies. If not, they may tear while exiting the machine.

- 2 Adjust the paper guide to the width of the print material.

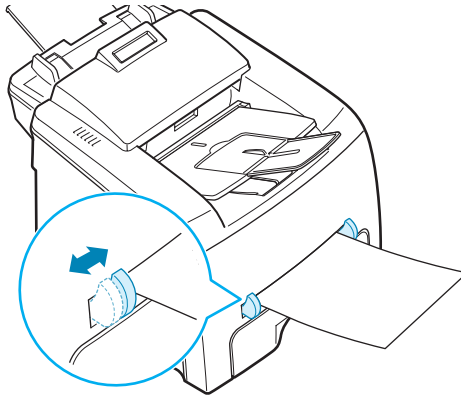

NOTE: When printing on previously printed paper from the manual feeder, the printed side should be facing down with an uncurled edge to the machine. If you experience problems with paper feed, turn the paper around.

- 3 Open the rear cover to use the rear output slot.

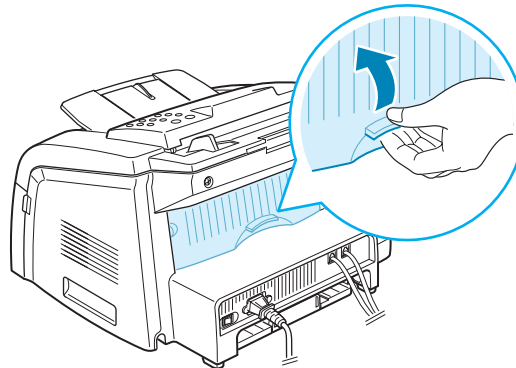

- 4 After printing, close the rear cover.

Setting the Paper Type and Size for the Manual Feeder

After loading paper in the manual feeder, you need to set the correct paper type and size using the control panel buttons. These settings will apply to Copy mode. For PC-printing, you need to select the paper size in the application program you use.

To set the paper size for the manual feeder:

1 Press **Menu**.

The display shows "Paper Setting" on the top line and the first item, "Paper Type," on the bottom line.

2 Press **Enter** to access the menu item.

3 Use the scroll button (◀ or ▶) to find the paper type you are using and press **Enter** to save it.

4 Press the ▶ button to scroll to "Paper Size" and press **Enter** to access the menu item.

5 Use the scroll button (◀ or ▶) to display "Manual Feed" on the bottom line. Press **Enter** to access the menu item.

6 Use the scroll button (◀ or ▶) to find the paper size you are using and press **Enter** to save it.

7 To return to Standby mode, press **Clear/Stop**.



3

COPYING

This chapter gives you step-by-step instructions for copying documents.

This chapter includes:

- **Loading Paper for Copying**
- **Preparing a Document**
- **Making a Copy**
- **Setting Copy Options**
- **Changing the Default Settings**
- **Setting the Time Out Option**
- **Collation Copying**

Loading Paper for Copying

The instructions for loading print materials are the same whether you are printing, faxing or copying. For copying, you can use Letter-, A4-, Legal-sized print materials. For further details, see page 1.11 for loading in the paper tray and page 2.8 for loading in the manual feeder.

Preparing a Document

Using the ADF (Automatic Document Feeder), you can load up to 20 documents (weight: 75 g/m², 20 lb) for one job.

When you use the ADF:

- Do not load documents smaller than 142 x 148 mm or larger than 216 x 356 mm.
- Do not attempt to feed the following types of documents:
 - carbon-paper or carbon-backed paper
 - coated paper
 - onion skin or thin paper
 - wrinkled or creased paper
 - curled or rolled paper
 - torn paper
- Remove all staples and paper clips before loading documents.
- Make sure any glue, ink or correction fluid on the paper is completely dry before loading documents.
- Do not load documents containing different sizes or weights of paper.
- Do not load booklet, pamphlet, transparencies or documents having other unusual characteristics.

Making a Copy

- 1 Pull the document support all the way out. Fold out the extender, if necessary.

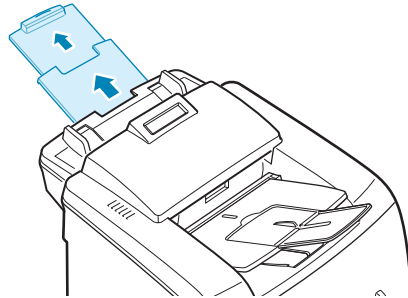

- 2 Load the documents up to 50 pages **face down** into the ADF.

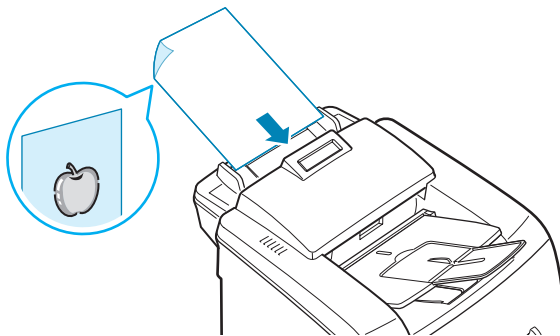

- 3 Adjust the document guides to the document size.

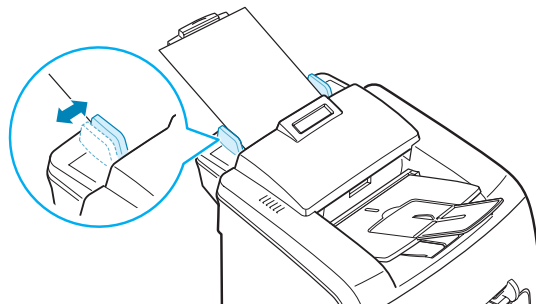

- 4 Customize the copy settings including number of copies, copy size, contrast and image by using the control panel buttons. See "Setting Copy Options" on page 3.4. Sorts the copy job. For example, if you make 2 copies of 3 page documents, one complete 3 page document will print followed by the second complete document. see page 3.8

To clear the settings, use the **Clear/Stop** button.

- 5 Press **Start**.

Setting Copy Options

The buttons on the control panel let you make all the basic copy options; contrast, document type, copy size and number of copies. Set the following options for the current copy job before pressing **Start** to make copies.



NOTE: If you press **Clear/Stop** while you set the copy options, all of the options you have set for the current copy job will be canceled and return to their default status. Or, they will automatically return to their default status after the machine completes the copy.

Darkness

If you have an original document containing faint markings and dark images, you can adjust the brightness to make a copy that is easier to read.

To adjust the contrast, press **Darkness** . Each time you press the button, the LED labeled with the selected mode turns on.

You can choose from the following darkness modes:

- **Lighten:** works well with dark print.
- **Normal:** works well with standard typed or printed documents.
- **Darken:** works well with light print or faint pencil markings.

Original Type

The image setting is used to improve the copy quality by selecting the document for the current copy job.

To select the document type, press Original Type . Each time you press the button, the LED labeled with the selected mode turns on.

You can choose from the following image modes:

- **Text:** Use for documents containing mostly text.
- **Photo:** Use when the originals are photographs.



NOTE: When you copy a document containing color on the background, such as a newspaper or a catalog, you can get the background on your copy. If you want to reduce the background, change the **Darknen** setting to **Lighten** and/or the Original Type  setting to **Text**.

Number of Copies

Using the **No. of Copies** button, you can select the number of copies from 1 to 99.

- 1 Press **No. of Copies**.
- 2 Press the scroll button (◀ or ▶) until the number you want appears on the display.

Pressing and holding the buttons allows you to quickly increase and decreases in increments of 5.

You can enter the value using the number keypad.

- 3 Press **Enter** to save the selection.

Reduced/Enlarged Copying

Using the **Reduce/Enlarge** button, you can reduce or enlarge the size of a copied image from 50% to 200%.

To select from the predefined copy sizes:

1 Press **Reduce/Enlarge**.

The default setting appears on the bottom line of the display.

2 Use **Reduce/Enlarge** or the scroll button (◀ or ▶) to find the size setting you want.

3 Press **Enter** to save the selection.

To fine-tune the size of copies:

1 Press **Reduce/Enlarge**.

2 Press **Reduce/Enlarge** or the scroll button (◀ or ▶) until "Custom:50-200%" displays on the bottom line. Press **Enter**.

3 Press the scroll button (◀ or ▶) until the copy size you want appears on the display.

Pressing and holding the buttons allows you to quickly increase and decreases in increments of 5.

You can enter the value using the number keypad.

4 Press **Enter** to save the selection.



NOTE: When you make a reduced copy, black lines may appear at the bottom of your copy.

Changing the Default Settings

Copy options, including contrast, image, copy size and number of copies, can be set to the most frequently used modes. When you copy a document, the default settings are used unless they are changed by using the corresponding buttons on the control panel.

To create your own default settings:

- 1 Press **Menu** on the control panel until "Copy Setup" appears on the top line of the display.
The first menu item, "Default-Change", appears on the bottom line.
- 2 Press **Enter** to access the menu item. The first setup option, "Darken," appears on the bottom line.
- 3 Press the scroll button (◀ or ▶) to scroll through the setup options.
- 4 When the option you want to set appears, press **Enter** to access the option.
- 5 Change the setting using the scroll button (◀ or ▶) or enter the value using the number keypad.
- 6 Press **Enter** to save the selection.
- 7 Repeat steps 3 through 6, as needed.
- 8 To return to Standby mode, press **Clear/Stop**.



NOTE: While you set copy options, pressing **Clear/Stop** cancels the changed settings and restores their default status.

Setting the Time Out Option

You can set the time the machine waits before it restores the default copy settings, if you do not start copying after changing them on the control panel.

- 1 Press **Menu** on the control panel until "Copy Setup" appears on the top line of the display.
- 2 Press the scroll button (◀ or ▶) to display "Timeout" on the bottom line.
- 3 Press **Enter** to access the menu item.
- 4 Press the scroll button (◀ or ▶) until the status you want appears on the display.

You can select from 15, 30, 60 and 180 (seconds).
Selecting "Off" means that the machine does not restore the default settings until you press **Start** to start copying, or **Clear/Stop** to cancel.

- 5 Press **Enter** to save the selection.
- 6 To return to Standby mode, press **Clear/Stop**.

Collation Copying

The Collation copying feature is available only when you load documents in the ADF.

- 1 Press **Menu** on the control panel until "Copy Setup" appears on the top line of the display.
- 2 Press the scroll button (◀ or ▶) to display "Copy Collated" on the bottom line.
- 3 Press **Enter** to access the menu item.
- 4 If you are making multiple copies and want to collate them, press the scroll button (◀ or ▶) to set Collated Copy to "On" and press **Enter**.

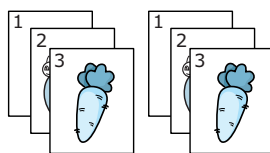

▲ Collated Copy On

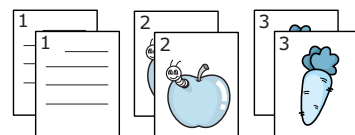

▲ Collated Copy Off

- 5 Press **Start** to begin copying.



4

FAXING

This chapter gives you information about using your machine as a fax machine.

This chapter includes:

- **Sending a Fax**
- **Receiving a Fax**
- **Automatic Dialing**
- **Advanced Fax Functions**
- **Additional Features**

Sending a Fax

Changing the Fax Setup options

- 1** Press **Menu** until "Fax Setup" appears on the top line of the display.

The first available menu item, "Ring To Answer," displays on the bottom line.
- 2** Press the scroll button (◀ or ▶) until the menu item you want on the bottom line and press **Enter**.
- 3** Use the scroll button (◀ or ▶) to find the status or use the number keypad to enter the value for the option you have selected.
- 4** Press **Enter** to save the selection.
- 5** If necessary, repeat steps 2 through 4.
- 6** To return to Standby mode, press **Clear/Stop**.

Available Fax Setup Options

You can use the following setup options for configuring the fax system:

Option	Description
Ring To Answer	You can specify the number of times the machine rings, 1 to 7, before answering an incoming call.
Darkness	You can select the default darkness mode to fax your documents lighter or darker. <ul style="list-style-type: none">• Lighten works well with dark print.• Normal works well with standard typed or printed documents.• Darken works well with light print or faint pencil markings.
Redial Term	Your machine can automatically redial a remote fax machine when the line is busy. Intervals from 1 to 15 minutes can be entered.
Redials	You can specify the number of redial attempts, 0 to 13. If you enter 0 , the machine will not redial.
MSG Confirm	You can set your machine to print a report showing whether the transmission was successful, how many pages were sent, and more. The available options are On , Off and On-Error , which prints only when a transmission is not successful.
Auto Report	A report with detailed information about the previous 50 communications operations, including time and dates. The available options are On or Off .
Auto Reduction	When receiving a document as long as or longer than the paper loaded in the paper tray, the machine can reduce the size of the document to fit the size of paper loaded in the machine. Select On if you want to automatically reduce an incoming page. With this feature set to Off , the machine cannot reduce the document to fit onto one page, the document is divided and printed in actual size on two or more pages.

Option	Description
Discard Size	<p>When receiving a document as long as longer than the paper installed in your machine, you can set the machine to discard any excess at the bottom of the page. If the received page is outside the margin you set, it will print on two sheets of paper at the actual size.</p> <p>When the document is within the margin and the Auto Reduction feature is turned on, the machine reduces the document to fit it onto the appropriate sized paper and discard does not occur. If the Auto Reduction feature is turned off or fails, the data within the margin will be discarded. Settings range from 0 to 30 mm.</p>
Receive Code	<p>The Receive Code allows you to initiate fax reception from an extension phone plugged into the EXT jack on the back of the machine. If you pick up the extension phone and hear fax tones, enter the Receive Code. The Receive Code is preset to *9* at the factory. Settings range from 0 to 9. See page 4.13 for more information about using the code.</p>
DRPD Mode	<p>You can receive a call using the Distinctive Ring Pattern Detection (DRPD) feature which enables a user to use a single telephone line to answer several different telephone numbers. In this menu, you can set the machine to recognize the ring patterns to answer. See page 4.13</p>

Loading a Document

- 1 Pull the document input support all the way out. Fold out the extender, if necessary.

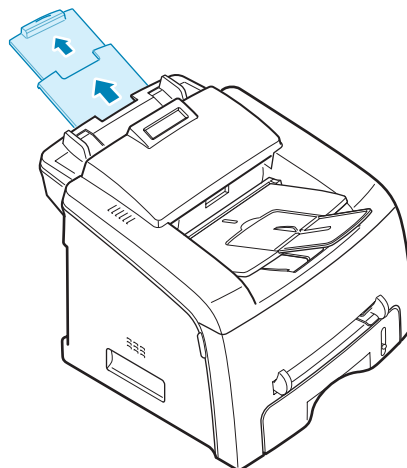

- 2 Load the documents up to 50 pages **face down** into the ADF and adjust the document guides to the document size.

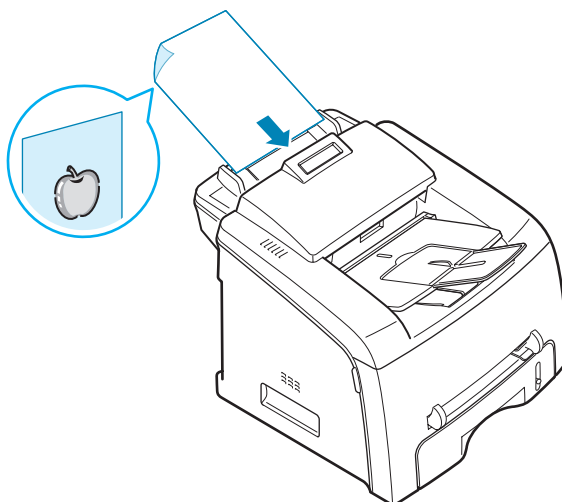

For detailed guidelines for preparing an original document, see page 3.2.

- 3 Adjust the document resolution, referring to page 4.6.

Adjusting the Document Resolution

The default document settings produce good results when setting typical text based documents.

However, if you send documents that are of a poor quality, or contain photographs, you can adjust the resolution to produce a higher quality fax.

- 1 Press **Resolution** on the control panel.
- 2 By pressing **Resolution** or the scroll button (◀ or ▶), you can choose from Standard, Fine, Super Fine, Photo.

The document types recommended for the resolution settings are described in the following table below:

Mode	Recommended for:
Standard	Documents with normal-sized characters.
Fine	Documents containing small characters or thin lines or documents printed using a dot-matrix printer.
Super Fine	Documents containing extremely fine detail. Super Fine mode is enabled only if the remote machine also supports the Super Fine resolution. See the notes below.
Photo	Documents containing shades of gray or photographs.



NOTES:

- For the memory transmission, Super Fine mode is not available. The resolution setting is automatically changed to Fine.
 - When your machine is set to Super Fine resolution and the remote fax machine does not support the Super Fine resolution, the machine transmits using the highest resolution mode supported by the remote fax machine.
-

Sending a Fax Automatically

- 1** Load the document(s) face down into the ADF.
For details about loading a document, see page 4.5.
- 2** Adjust the document resolution to suit your fax needs. See page 4.6.
If you need to change the darkness, see page 4.3.
- 3** Enter the remote fax phone number using the number keypad.
You can use the one-touch keypad or speed or group dial numbers. For details about storing a number, see page 4.9.
- 4** Press **Start**.
The number is dialed and then the machine begins sending the fax when the remote fax machine is ready.



NOTE: When you want to cancel the fax job, press **Clear/Stop** at any time while sending the fax.

Sending a Fax Manually

- 1** Load the document(s) face down into the ADF.
For details about loading a document, see page 4.5.
- 2** Adjust the document resolution to suit your fax needs. See page 4.6.
If you need to change the darkness, see page 4.3.
- 3** Press **On Hook Dial** . You hear a dial tone.
- 4** Enter the remote fax machine's fax number using the number keypad.
You can use the one-touch keypad or speed or group dial numbers. For details about storing a number, see page 4.9.
- 5** When you hear a high-pitched fax signal from the remote fax machine, press **Start**.



NOTE: When you want to cancel the fax job, press **Clear/Stop** at any time while sending the fax.

Redialing the Last Number

To redial the last number you dialed:

Press **Redial/Pause**.

If a document is loaded in the ADF, the machine automatically begins to send.

Confirming Transmission

When the last page of your document has been sent successfully, the machine beeps and returns to Standby Mode.

When something goes wrong while sending your fax, an error message appears on the display. For a listing of error messages and their meanings, See page 8.8.

If you receive an error message, press **Clear/Stop** to clear the message and try to send the document again.

You can set your machine to print a confirmation report automatically each time sending a fax is completed. For further details, see the MSG Confirm item on page 4.3.

Automatic Redialing

When the number you have dialed is busy or there is no answer when you send a fax, the machine automatically redials the number every three minutes up to seven times by the factory default settings.

When the display shows "[Retry Redial ?]," press **Enter** to redial the number without waiting. To cancel the automatic redialing, press **Clear/Stop**.

To change the time interval between redials and the number of redial attempts. See page 4.3.

Receiving a Fax

About Receiving Modes

- In **Fax** mode, the machine answers an incoming fax call and immediately goes into the fax reception mode.
- In **Tel** mode, you can receive a fax by pressing **On Hook Dial** (you can hear a fax tone from the remote machine) and then pressing **Start** on the control panel of your machine. You can also of the extension phone and then press the remote receive code; see page 4.13.
- In **Ans/Fax** mode, the answering machine answers an incoming call, and the caller can leave a message on the answering machine. If the fax machine senses a fax tone on the line, the call automatically switches to Fax mode.
- In **DRPD** mode, you can receive a call using the Distinctive Ring Pattern Detection (DRPD) feature. "Distinctive Ring" is a telephone company service which enables a user to use a single telephone line to answer several different telephone numbers. For further details. See page 4.13

The current receiving mode displays when the machine is in Standby mode.

When the memory is full, the receiving mode automatically switches to Tel.



NOTES:

- To use Ans/Fax mode, connect an answering machine to the EXT jack on the back of your machine. see page 1.15.
 - If you do not want other people to view your received documents, you can use Secure Receiving mode. In this mode, all of the received faxes are stored in the memory. For further details, see page 4.29.
-

Loading Paper for Receiving Faxes

The instructions for loading paper in the paper tray are the same whether you are printing, faxing, or copying, except that faxes can only be printed on Letter-, A4- or Legal-sized plain paper. For details about loading paper and setting the paper size in the tray, see page 1.11 and page 1.32.

Receiving Automatically in Fax Mode

Your machine is preset to Fax mode at the factory. If you have changed the receiving mode, take the following steps to receive faxes automatically:

- 1** Press **Receive Mode**.
- 2** Press and hold Receive Mode until "Fax" displays on the bottom line. You may have to repeat this action once or twice, depending on the mode you're in.
- 3** When you receive a fax, the machine answers the call on a specified number of rings and automatically receives the fax.

To change the number of rings, see page 4.3.

Receiving Automatically in Ans/Fax Mode

For using this mode, you must attach an answering machine to the EXT jack on the back of your machine. See page 1.15.

- 1 Press **Receive Mode**.
- 2 Press and hold Receive Mode until "Ans/Fax" displays on the bottom line. You may have to repeat this action once or twice, depending on the mode you're in.
- 3 When you receive a call, the answering machine answers.

If the caller leaves a message, the answering machine stores the message as it would normally. If your machine hears a fax tone on the line, it automatically starts to receive the fax.



NOTES:

- When you have set your machine to Ans/Fax mode and your answering machine is switched off or no answering machine is connected to the EXT jack, your machine automatically goes into Fax mode after a predefined number of rings.
 - If your answering machine has a "user-selectable ring counter," set it to answer incoming calls within 1 ring.
 - If you are in Tel mode, which is receiving faxes manually, when the answering machine is connected to your machine, you must switch off the answering machine, or the outgoing message from the answering machine will interrupt your phone conversation.
-

Receiving Manually in Tel Mode

You can answer calls using the **On Hook Dial** button.

- 1 Press **Receive Mode**.
- 2 Press and hold Receive Mode until "Tel" displays on the bottom line. You may have to repeat this action once or twice, depending on the mode you're in.
- 3 When you receive a fax call, press **On Hook Dial**.

You can hear a fax tone from the remote machine.

- 4 Press **Start** to receive the fax.

The machine begins receiving a fax and returns to Standby Mode when the reception is completed.

Receiving Manually Using Remote Receive Start Code

You can receive a fax from someone you are talking to on the extension telephone without going to the fax machine.

When you receive a call on the extension phone and hear fax tones, press the keys *9* on the extension telephone. The machine receives the document.

Press the buttons slowly in sequence. If you still hear the fax tone from the remote machine, try pressing *9* once again.

9 is the remote receive code preset at the factory. The first and the last asterisks are fixed, but you can change the middle number to whatever you choose. For details about changing the code, see page 4.4.

Receiving Faxes Using the DRPD Mode

“Distinctive Ring” is a telephone company service which enables a user to use a single telephone line to answer several different telephone numbers. The particular number someone uses to call you on is identified by different ringing patterns, which consist of various combinations of long and short ringing sounds. This feature is often used by answering services who answer telephones for many different clients and need to know which number someone is calling in on to properly answer the phone.

Using the Distinctive Ring Pattern Detection feature, your fax machine can “learn” the ring pattern you designate to be answered by the FAX machine. Unless you change it, this ringing pattern will continue to be recognised and answered as a FAX call, and all other ringing patterns will be forwarded to the extension telephone or answering machine plugged into the EXT. jack. You can easily suspend or change Distinctive Ring Pattern Detection at any time.

Before using the Distinctive Ring Pattern Detection option, Distinctive Ring service must be installed on your telephone line by the telephone company. To set up Distinctive Ring Pattern Detection, you will need another telephone line at your location, or someone available to dial your FAX number from outside.

To set up the DRPD mode:

- 1** Press **Menu** until "Fax Setup" appears on the top line of the display.
The first available menu item, "Receive Mode," displays on the bottom line.
- 2** Press the scroll button (◀ or ▶) until you see "DRPD Mode" on the bottom line and press **Enter**.
- 3** When "Set" displays on the bottom line, press **Enter**.
The LCD displays "[Waiting Ring]."
- 4** Call your fax number from another telephone. It is not necessary to place the call from a fax machine.
- 5** When your machine begins to ring, do not answer the call. The machine requires several rings to learn the pattern.
When the machine completes learning, the LCD displays "End DRPD [Setup]."
If the DRPD setup fails, "DRPD Ring Error" appears. Press **Enter** when "DRPD Mode" displays and retry from Step 3.
- 6** To return to Standby Mode, press **Clear/Stop**.

When the DRPD feature is set up, the DRPD option is available in the Receive Mode menu. To receive faxes in the DRPD mode, you need to set the menu to **DRPD**.



NOTES:

- DRPD must be set up again if you re-assign your fax number, or connect the machine to another telephone line.
 - After DRPD has been set up, call your fax number again to verify that the machine answers with a fax tone. Then have a call placed to a different number assigned to that same line to be sure the call is forwarded to the extension telephone or answering machine plugged into the EXT. jack.
-

Receiving Faxes in the Memory

Since your machine is a multi-tasking device, it can receive faxes while you are making copies or printing. If you receive a fax while you are copying or printing, your machine stores incoming faxes in the memory. Then, as soon as you finish copying or printing, the machine automatically prints the fax.

Automatic Dialing

One-touch Dialing

The 20 one-touch buttons on the control panel lets you store frequently-used fax numbers and dial a number automatically with a touch of a button.

Using the  button, you can store up to 40 fax numbers on the one-touch buttons.

Storing a Number for One-touch Dialing

- 1 Press and hold one of the one-touch dial buttons for about 2 seconds.

The display asks you to enter the fax number. "T" signifies that you are assigning a one-touch dial button.

If you want to use one-touch dial buttons from 21 to 40,

press  and hold down the one-touch dial button for about 2 seconds.

- 2 Enter the number you want to store using the number keypad and press **Enter**.

To insert a pause between numbers, press **Redial/Pause**. A symbol "-" appears on the display.

If you make a mistake while entering a number, press the  button and re-enter the correct number.

- 3 To assign a name to the number, enter the name you want. For details about entering characters, see page 1.29.

If you do not want to assign a name, skip this step.

- 4 Press **Enter** when the name appears correctly or without entering a name.

- 5 To store more numbers, press a one-touch button and repeat steps 2 through 4.

OR

To return to Standby mode, press **Clear/Stop**.

Sending a Fax using a One-touch Number

- 1** Load the document(s) face down into the ADF.
For details about loading a document, see page 4.5.
- 2** Adjust the document resolution to suit your fax needs. See page 4.6.
If you need to change the darkness, see page 4.3.
- 3** Press the one-touch button where you stored a number.
The document scans into the memory.
- 4** The machine dials the fax number stored in the one-touch dial location and the document is sent when the remote fax machine answers.

Speed Dialing

You can store up to 150 frequently-dialed numbers in one, two or three-digit speed dial locations (0-149).

Storing a Number for Speed Dialing

- 1** Press **Phone Book** on the control panel.
- 2** Press **Phone Book** or the scroll button (◀ or ▶) to display "Store&Edit" on the bottom line of the display. Press **Enter**.
- 3** Press **Enter** when "Speed Dials" appears on the display.
If you want to use one-touch dial buttons from 21 to 40, press  and hold down the one-touch dial button for about 2 seconds.
The display prompts you to enter a location number, showing the first available number.
- 4** Enter a one or two-digit speed dial number between 0 and 149, using the number keypad or scroll button (◀ or ▶) and press **Enter**.
If a number is already stored in the location you chose, the display shows the number to allow you to change it. To start over with another speed-dial number, press **Upper Level**.

- 5 Enter the number you want to store using the number keypad and press **Enter**.

To insert a pause between numbers, press **Redial/Pause**. A symbol “-” appears on the display.

- 6 To assign a name to the number, enter the name you want. For details about entering characters, see page 1.29.

OR

If you do not want to assign a name, skip this step.

- 7 Press **Enter** when the name appears correctly or without entering a name.

- 8 To store more fax numbers, repeat steps 4 through 7.

OR

To return to Standby mode, press **Clear/Stop**.

Sending a Fax using a Speed Number

- 1 Feed the document(s) face up into the ADF.

For details about loading a document, see page 4.5.

- 2 Adjust the document resolution to suit your fax needs. See page 4.6.

If you need to change the darkness, see page 4.3.

- 3 Enter the speed dial number.

- For a one-digit speed dial number, press and hold the appropriate digit button.
- For a two or three-digit speed dial number, press the first digit button and hold the last digit button.

The corresponding entry's name briefly displays.

- 4 The document scans into the memory.

The fax number stored in the speed dial location is automatically dialed. The document is sent when the remote fax machine answers.

Group Dialing

If you frequently send the same document to several destinations, you can create a group of these destinations and set them under a group dial location. This enables you to use a group dial number setting to send the same document to all the destinations within the group.

Setting a Group Dial Number

- 1 Press **Phone Book** on the control panel.
- 2 Press **Phone Book** or the scroll button (◀ or ▶) to display "Store&Edit" on the bottom line of the display. Press **Enter**.
- 3 Press the scroll button (◀ or ▶) to display "Group Dials" on the bottom line and press **Enter**.
- 4 Press **Enter** when "New" displays on the bottom line.

The display prompts you to enter a location number, showing the first available number.
- 5 Enter a group number between 0 and 149 using the number keypad or scroll button (◀ or ▶) and press **Enter**.
- 6 Press a one-touch dial button, or enter a speed number you want to include in the group and press **Enter**.
- 7 When the display confirms the number to be added to the group, press **Enter**.
- 8 Repeat steps 6 and 7 to enter other one-touch dial or speed dial numbers into the group.
- 9 Press **Upper Level** when you have entered all of the numbers. The display prompts you to enter a group ID.
- 10 To assign a name to the group, enter the name.

OR

If you do not want to assign a name, skip this step.
- 11 Press **Enter** when the name appears correctly or without entering a name.

12 If you want to assign another group, press **Enter** and repeat from step 5.

OR

To return to Standby mode, press **Clear/Stop**.



NOTE: You cannot include one group dial number in another group dial number.

Editing Group Dial Numbers

You can delete a specific speed dial number from a selected group or add a new number to the selected group.

- 1** Press **Phone Book** on the control panel.
- 2** Press **Phone Book** or the scroll button (◀ or ▶) to display "Store&Edit" on the bottom line of the display. Press **Enter**.
- 3** Press the scroll button (◀ or ▶) to display "Group Dials" on the bottom line and press **Enter**.
- 4** Press the scroll button (◀ or ▶) to display "Edit" on the bottom line and press **Enter**.
- 5** Enter the group number you want to edit and press **Enter**.
- 6** Press a one-touch dial button to enter a speed dial number you want to add or delete.
- 7** When you enter the specific number in the group, the display shows "Delete?."

When you enter a new number, the display shows "Add?."

- 8** Press **Enter** to add or delete the number.
- 9** To change the group name, press **Upper Level**.
- 10** Enter a new group name and press **Enter**.
- 11** If you want to edit another group, press **Enter** and repeat from step 5.

OR

To return to Standby mode, press **Clear/Stop**.

Sending a Fax Using Group Dialing (Multi-address Transmission)

You can use group dialing for Broadcasting or Delayed transmissions.

Follow the procedure of the operation (Broadcasting transmission; see page 4.22, Delayed transmission; see page 4.23, Priority transmissionpage 4.25, Delayed RX Polling transmissionpage 4.26). When you come to a step in which the display asks you to enter the remote fax number:

- For a one-digit group number, press and hold the appropriate digit button.
- For a two-digit group number, press the first digit button and hold the last digit button.

You can use only one group number for one operation. Then continue the procedure to complete the operation.

Your machine automatically scans the document loaded in the ADF and then dials each of the numbers included in the group.

Searching for a Number in the Memory

There are two ways to search for a number in the memory. You can either scan from A to Z sequentially, or you can search using the first letter of the name associated with the number.

Searching Sequentially through the Memory

- 1 Press **Phone Book**.
- 2 Press **Enter** when "Search&Dial" appears on the display.
- 3 Press the scroll button (◀ or ▶) to scroll through the memory until the name and number you want to dial display. You can search upwards or downwards through the entire memory in alphabetical order, from A to Z.

While searching through the machine's memory, you can see that each entry is preceded by one of three letters; "T" for one-touch dial, "S" for speed dial or "G" for group dial number. These letters tell you how the number is stored.

- 4 When the name and/or the number you want displays, press **Start** or **Enter** to dial.

Searching with a Particular First Letter

- 1 Press **Phone Book**.
- 2 Press **Enter** when "Search&Dial" appears on the display.
- 3 Press the button labeled with the letter you want to search for. A name beginning with the letter displays.

For example, if you want to find the name "MOBILE," press the **6** button, which is labeled with "MNO."

- 4 Press the scroll button (◀ or ▶) to display the next name.
- 5 When the name and/or the number you want displays, press **Start** or **Enter** to dial.

Printing a Phone Book List

You can check your automatic dial setting by printing a Phone Book list.

- 1 Press **Phone Book**.
- 2 Press **Phone Book** or the scroll button (◀ or ▶) until "Print" appears on the bottom line and press **Enter**.

A list showing your one-touch dial, speed dial and group dial entries prints out.

Advanced Fax Functions

Sending Broadcasting Faxes

Using the **Broadcasting** button on the control panel, you can use the broadcasting fax feature, which allows you to send a document to multiple locations. Documents are automatically stored in the memory and sent to a remote station. After transmission, the documents are automatically erased from the memory.

- 1** Load the document(s) face down into the ADF.
For details about loading a document, see page 4.5.
- 2** Adjust the document resolution to suit your fax needs. See page 4.6.
If you need to change the darkness, see page 4.3.
- 3** Press **Broadcasting** on the control panel.
- 4** Enter the number of the remote machine using the number keypad.
You can use one-touch keypad or speed dial or group dial numbers. For details about storing a number, see page 4.15.
- 5** Press **Enter** to confirm the number. The display asks you to enter another fax number to send the document.



NOTE: The Another No. prompt does not appear if you have added numbers for another broadcasting or delay fax job. You must wait until the job is completed.

- 6** To enter more fax numbers, press **1** to select "Yes" and repeat steps 4 and 5. You can add up to 10 destinations.

Note that you cannot use group dial numbers for another fax number.

- 7** When you finish entering fax numbers, press **2** to select "No" at a Another No. prompt.

The document is scanned into the memory before transmission. The display shows the memory capacity and the number of pages being stored in the memory.

The machine begins sending the document in order of the numbers you entered.

Sending a Delayed Fax

You can set your machine to send a fax at a later time when you will not be present.

- 1** Load the document(s) face down into the ADF.

For details about loading a document, see page 4.5.

- 2** Adjust the document resolution to suit your fax needs. See page 4.6.

If you need to change the darkness, see page 4.3.

- 3** Press **Menu** until "Fax Feature" appears on the top line of the display. The first available menu item, "DelayFax," displays on the bottom line.

- 4** Press **Enter**.

- 5** Enter the number of the remote machine using the number keypad.

You can use one-touch keypad or speed dial or group dial numbers. For details about storing a number, see page 4.15.

- 6** Press **Enter** to confirm the number on the display. The display asks you to enter another fax number to send the document.



NOTE: The Another No. prompt does not appear if you have added numbers for another broadcasting or delay fax job. You must wait until the job is completed.

- 7** To enter more fax numbers, press **1** to select "Yes" and repeat steps 4 and 5. You can add up to 10 destinations.

Note that you cannot use group dial numbers for another fax number.

- 8** When you finish entering fax numbers, press **2** to select "No" at a Another No. prompt.

The display asks you to enter a name.

- 9** To assign a name to the transmission, enter the name. If not, skip this step.

For details on how to enter the name using the number keypad, see page 1.29.

- 10** Press **Enter**.

The display shows the current time and asks you to enter the starting time when the fax is to be sent.

- 11** Enter the time using the number keypad.

To select "AM" or "PM" for 12-hour format, press the * or # button or any number button.

If you set a time earlier than the current time, the document will be sent at that time on the following day.

- 12** Press **Enter** when the starting time displays correctly.

The document is scanned into the memory before transmission. The display shows the memory capacity and the number of pages being stored in the memory.

The machine returns to Standby mode. The display reminds you that you are in Standby mode and that a delayed fax is set.



NOTE: If you want to cancel the delayed transmission, see "Canceling a Scheduled Fax" on page 4.28.

Sending a Priority Fax

Using the Priority Fax feature, a high priority document can be sent ahead of reserved operations. The document is scanned into the memory and transmitted when the current operation is finished. In addition, the priority transmission interrupts a broadcast operation between stations (i.e., when the transmission to station A ends, before transmission to station B begins) or between redial attempts.

- 1 Load the document(s) face down into the ADF.

For details about loading a document, see page 4.5.

- 2 Adjust the document resolution to suit your fax needs. See page 4.6.

If you need to change the darkness, see page 4.3.

- 3 Press **Menu** until "Fax Feature" appears on the top line of the display.

- 4 Press the scroll button (◀ or ▶) to display "Priority Fax" on the bottom line and press **Enter**.

- 5 Enter the number of the remote machine using the number keypad.

To enter the number, you can use one-touch keypad or speed dial or group dial numbers. For details, see page 4.15.

- 6 Press **Enter** to confirm the number. The display asks you to enter a name.

- 7 To assign a name to the transmission, enter the name. If not, skip this step.

For details on how to enter a name using the number keypad, see page 1.29.

- 8 Press **Enter**.

The document is scanned into the memory before transmission. The display shows the memory capacity and the number of pages being stored in the memory.

The machine shows the number being dialed and begins sending the document.

Polling a Remote Machine

Polling is used when one fax machine requests another to send a document. This is useful when the person with the original document to be sent is not in the office. The person who wants to receive the document calls the machine holding it and requests that the document be sent. In other words, it "polls" the machine holding the original document.

You can set the machine to automatically receive documents from the unattended remote fax machine at any time. This feature permits unattended polling in the evening hours when telephone rates are lower.



NOTE: The machine must be ready for polling.

- 1 Press **Menu** until "Fax Feature" appears on the top line of the display.
- 2 Press the scroll button (◀ or ▶) to display "Delay Rx Poll" on the bottom line and press **Enter**.
- 3 Enter the number of the remote machine to be polled using the number keypad.

To enter the number, you can use a one-touch keypad or speed dial number. For details, see page 4.15.

- 4 Press **Enter** to confirm the number on the display. The display asks you to enter another fax number.



NOTE: The Another No. prompt does not appear if you have added numbers for another broadcasting or delay fax job. You must wait until the job is completed.

- 5 To enter more fax numbers, press **1** to select "Yes" and repeat steps 4 and 5. You can add up to 10 destinations.

Note that you cannot use group dial numbers for another fax number.

- 6 When you finish entering fax numbers, press **2** to select "No" at a Another No. prompt.
- 7 Enter the time using the number keypad.

To select "AM" or "PM" for 12-hour format, press the * or # button or any number button.

If you set a time earlier than the current time, your machine will poll at that time on the following day.

- 8 When the remote machine is secured with a 4-digit poll code, enter the correct code and press **Enter**.

If not, press **Enter** to accept "0000" which represents no code, or enter **0000**.

- 9 Press **Enter** when the starting time displays correctly.

At the specified time, the machine will dial the numbers in the order you entered and receive documents from the remote machines.

Adding Documents to a Scheduled Fax

You can add documents to the delayed transmission previously reserved in your machine's memory.

- 1 Load the document(s) face down into the ADF.

For details about loading a document, see page 4.5.

- 2 Adjust the document resolution to suit your fax needs. See page 4.6.

If you need to change the darkness, see page 4.3.

- 3 Press **Menu** until "Fax Feature" appears on the top line of the display.

- 4 Press the scroll button (◀ or ▶) to display "Add Page" on the bottom line and press **Enter**.

The display shows the last job reserved in the memory.

- 5 Press the scroll button (◀ or ▶) until you see the fax job to which you want to add documents and press **Enter**.

The machine automatically stores the documents in the memory, and the display shows the memory capacity and the number of pages.

After storing, the machine displays the numbers of total pages and added pages and then returns to Standby mode.

Canceling a Scheduled Fax

- 1 Press **Menu** until "Fax Feature" appears on the top line of the display.
- 2 Press the scroll button (◀ or ▶) to display "Cancel Job" and press **Enter**. The display shows the last job reserved in the memory.
- 3 Press the scroll button (◀ or ▶) until you see the fax job you want to cancel, and press **Enter**.
- 4 When the display confirms your selection, press **1** to select "Yes." The selected job is canceled and the machine returns to Standby mode.

To cancel your selection, press **2** to select "No."

Additional Features

Using Secure Receiving Mode

You may need to prevent your received faxes from being accessed by unauthorized people. You can turn on Secure Receiving mode to restrict printing out all of the received faxes when the machine is unattended. In Secure Receiving mode, all of the incoming faxes go into the memory. When the mode turns off, any faxes stored are printed.

To turn Secure Receiving mode on:

- 1 Press **Menu** until "Advanced Fax" appears on the top line of the display.
- 2 Press the scroll button (◀ or ▶) until "Secure Receive" appears on the bottom line and press **Enter**.
- 3 Press the scroll button (◀ or ▶) to display "On" on the bottom line and press **Enter**.
- 4 Enter a four-digit passcode you want to use and press **Enter**.



NOTE: You can activate Secure Receiving mode without setting a passcode, but cannot protect your faxes.

- 5 Re-enter the passcode to confirm it and press **Enter**.
- 6 To return to Standby mode, press **Clear/Stop**.

When a fax is received in Secure Receiving mode, your machine stores it into the memory and displays "Secure Receive" to let you know that there is a fax stored.

To print received documents:

- 1** Access the Secure Receive menu by following steps 1 and 2 on page 4.29.
- 2** Press the scroll button (◀ or ▶) to display "Print" on the bottom line and press **Enter**.
- 3** Enter the four-digit passcode and press **Enter**.

The machine prints all of the faxes stored in the memory.

To turn Secure Receiving mode off:

- 1** Access the Secure Receive menu by following steps 1 and 2 on page 4.29.
- 2** Press the scroll button (◀ or ▶) to display "Off" on the bottom line and press **Enter**.
- 3** Enter the four-digit passcode and press **Enter**.

The mode is deactivated and the machine prints all of the faxes stored in the memory.

- 4** To return to Standby mode, press **Clear/Stop**.

Printing Reports

Your machine can print reports containing useful information. The following reports are available:

Phone Book List

This list shows all of the numbers currently stored in the machine's memory as speed dial and group dial numbers.

You can print this Phone Book list using the **Phone Book** button; see page 4.21.

Sent Fax Report

This report shows information of the faxes you recently sent.

Received Fax Report

This report shows information of the faxes you recently received.

System Data List

This list shows the status of the user-selectable options. You may print this list to confirm your changes after changing any settings.

Scheduled Job Information

This list shows the document currently stored for Delayed faxes . The list shows the starting time and type of operation.

Message Confirmation

This report shows the fax number, the number of pages, the elapsed time of the job, the communication mode, and the communication results.

You can set up your machine to automatically print the message confirmation report after each fax job. See page 4.3.

Junk Fax Number List

This list shows up to 10 fax numbers specified as the junk fax numbers by using the Junk Fax Setup menu; see page 4.34. When the Junk Fax Barrier feature is turned on, incoming faxes from those numbers are blocked.

This feature recognize the last 6 digits of the fax number set as a remote fax machine's ID.

Multi-communication Report

This report is printed automatically after sending documents from more than one location.

Power Failure Report

This report is printed out automatically when power is restored after a power failure, if there occurs any data loss due to the power failure.



NOTE: The lists you have set to print out automatically don't print out when there is no paper loaded or a paper jam has occurred.

Printing a Report

- 1** Press **Menu** until "Reports" appears on the top line of the display. The first available menu item, "Phone Book" displays on the bottom line.
- 2** Press the scroll button (◀ or ▶) to display the report or list you want to print on the bottom line.
 - Phone Book: Phone Book list
 - Sent Report: Sent fax report
 - RCV Report: Received fax report
 - System Data: System data list
 - Scheduled Jobs: Scheduled job information
 - MSG Confirm: Message confirmation
 - Junk Fax List: Junk fax number list
- 3** Press **Enter**.

The selected information prints out.

Using Advanced Fax Settings

Your machine has various user-selectable setting options for sending or receiving faxes. These options are preset at the factory, but you may need to change them. To find out how the options are currently set, print the System Data list. For details about printing the list, see page 4.31

Changing Setting Options

- 1** Press **Menu** until "Advanced Fax" appears on the top line of the display. The first available menu item, "Send Forward," displays on the bottom line.
- 2** Press the scroll button (◀ or ▶) until you see the desired menu item on the bottom line and press **Enter**.
- 3** When the option you want appears on the display, choose a status by pressing the scroll button (◀ or ▶) or enter a value using the number keypad.
- 4** Press **Enter** to save the selection.
- 5** You can exit from Setup mode at any time by pressing **Clear/Stop**.

Advanced Fax Setting Options

Option	Description
Send Forward	<p>You can set the machine to always forward all of the outgoing faxes to a specified destination, in addition to the fax numbers you entered.</p> <p>Select Off to turn this feature off. Select On to turn this feature on. You can set the number of the remote fax machine to which faxes are forwarded.</p>
RCV Forward	<p>You can set your machine to forward incoming faxes to another fax number during a specified period of time. When a fax arrives at your machine, it is stored in the memory. Then, the machine dials the fax number that you have specified and sends the fax.</p> <p>Select Off to turn this feature off. Select On to turn this feature on. You can set the fax number to which faxes are forwarded. Then, you can enter the starting time and/or the ending time. The Print Local Copy option allows you to set the machine to print the fax, if fax forwarding is completed without any error.</p>
Junk Fax Setup	<p>Using the Junk Fax Barrier feature, the system will not accept faxes sent from remote stations of which their numbers are stored in the memory as junk fax numbers. This feature is useful for blocking any unwanted faxes.</p> <p>Select Off to turn the feature off. Anybody can send you a fax. Select On to turn the feature on. You can set up to 10 fax numbers as junk fax numbers using the Set option. This feature recognize the last 6 digits of the fax number set as a remote fax machine's ID. After storing numbers, you do not receive any faxes from the registered stations. To delete all the junk fax numbers, use the All Delete option.</p>
Secure Receive	<p>You can keep your received faxes from being accessed by unauthorized people.</p> <p>For further details about setting this mode, see page 4.29.</p>
Prefix Dial No.	<p>You can set a prefix dial number of up to five digits. This number dials before any automatic dial number is started. It is useful for accessing the PABX exchange.</p>

Option	Description
Stamp RCV Name	<p>This option allows the machine to automatically print the page number, and the date and time of the reception at the bottom of each page of a received document.</p> <p>Select Off to turn this feature off. Select On to turn this feature on.</p>
ECM Mode (Error Correction Mode)	<p>Error Correction Mode helps with poor line quality and makes sure any fax you send are sent smoothly to any other ECM-equipped fax machine. If the line quality is poor, it takes more time to send a fax when you are using the ECM mode.</p> <p>Select Off to turn this feature off. Select On to turn this feature on.</p>

Using the Remote Control Panel

Using the Remote Control Panel, you can create and edit Phone Book entries or update the firmware program of your machine on the desktop of your computer.

When you install SF-565P software, the Remote Control Panel program is automatically installed.

For information about installing SF-565P software, see page 1.19.

To open the Remote Control Panel:

- 1 Start your Windows.
- 2 From the **Start** menu, select **Programs**.
- 3 Select **Type 1200** and then **Remote Control Panel**.

The Remote Control Panel program opens.

- 4 The Remote Control Panel window provides the two tabs; **Phone Book** and **Firmware Update**.

To exit, click the **Exit** button at the bottom of each tab.

For further details, click the **Help** button at the bottom of each tab.

The Phone Book Tab

Click the **Phone Book** tab to create and edit Phone Book entries.

The screenshot shows the 'Remote Control Panel' window with the 'Phonebook' tab selected. The interface includes a 'Type' section with radio buttons for 'One touch dial (1 ~ 40)' and 'Speed dial (0 ~ 149)'. Below this is a table with columns 'No.', 'Name', and 'Phone Number'. At the bottom are buttons for 'Edit', 'Delete', 'Delete All', 'Group dial...', 'Exit', and 'Help'.

- Read**: Reads the Phone Book entries from the machine to the Remote Control Panel.
- Write**: Downloads the Phone Book entries from the Remote Control Panel to the machine.
- Table**: Shows Phone Book entries.
- Edit**: Allows you to edit the selected Phone Book entry in a separate Edit window.
- Delete**: Deletes the selected Phone Book entry.
- Delete All**: Deletes all Phone Book entries.
- Group dial...**: Allows you to set up group dial numbers. See below.

When you click **Group Dial**, the following window opens.

The 'Group dial' dialog box features a 'Name' text field, 'Remove (>>)' and 'Add (<<)' buttons, and two list boxes: 'Included numbers' and 'Available numbers'. The 'Type' dropdown is set to 'Speed dial'. At the bottom are 'OK' and 'Cancel' buttons.

- Name field**: Enter a name for the group.
- Included numbers list**: Shows the numbers included in the group. To remove a number, select it and click **Remove**.
- Available numbers list**: Shows the Phone Book entries you can include in the group. After selecting a number, click **Add** to move it to the Included numbers list.
- OK button**: Click to save the group dial number after adding or removing numbers for the group.

The Firmware Update Tab

Click the **Firmware Update** tab to update the firmware of your machine. This feature should be used by an authorized technician. Please consult with the purchase point.

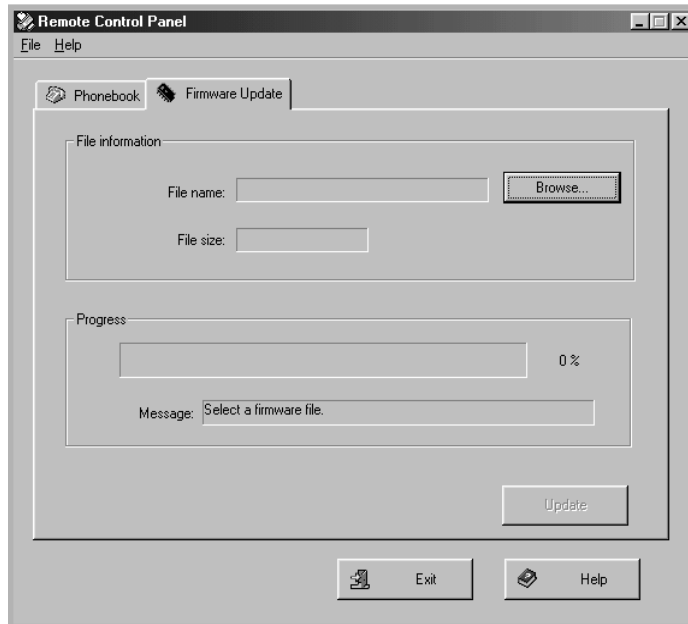

5

PRINTING

This chapter explains how to print your documents in Windows and how to use the print settings.

This chapter includes:

- **Printing a Document in Windows**
- **Setting Paper Properties**
- **Setting Graphic Properties**
- **Printing Multiple Pages on One Sheet of the Paper**
- **Printing a Reduced or Enlarged Document**
- **Fitting Your Document to a Selected Paper Size**
- **Printing Posters**
- **Using Watermarks**
- **Using Overlays**
- **Setting Up the Locally Shared Printer**

Printing a Document in Windows

The following procedure describes the general steps required for printing from various Windows applications. The exact steps for printing a document may vary depending on the application program you are using. Refer to your software application's user's guide for the exact printing procedure.

- 1 Open the document you want to print.
- 2 Select **Print** from the **File** menu.

The Print window opens. It may look slightly different depending on your application.

You can select the basic print settings within the Print window. These settings include the number of copies and the print range.

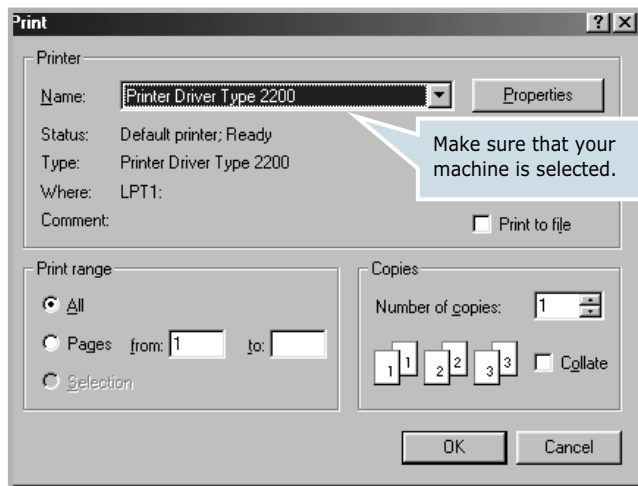

▲ Windows 98

- 3 To take advantage of the printer features provided by your machine, click **Properties** or **Preferences** in the application's print window and go to step 4.

If you see a **Setup**, **Printer** or **Options** button, click it instead. Then click **Properties** on the next screen.

- 4 Now you see the Printer Driver Type 2200 Properties window, which allows you to access all of information you need when using your machine.

The **Layout** tab first displays.

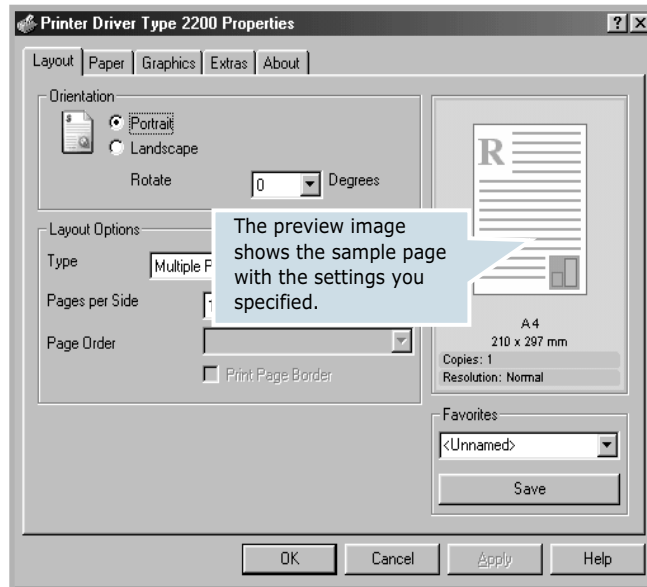

If necessary, select the **Orientation** option.

The **Orientation** option allows you to select the direction in which information is printed on a page.

- **Portrait** prints across the width of the page, letter style.
- **Landscape** prints across the length of the page, spreadsheet style.
- If you want to turn the page upside down, select **180** from the **Rotate** drop-down list.



▲ Landscape

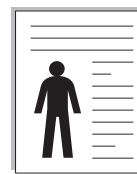

▲ Portrait

5 From the **Paper** tab, select the paper source, size and type. For further details, see page 5.7.

- 6 If necessary, you can set the sequence for the pages to print from the **Extra** tab. Select the print order you want to use from the **Print Order** drop-down list.
 - **Normal**: Your machine prints from the first page to the last page.
 - **Reverse All Pages**: Your machine prints from the last page to the first page.
 - **Print Odd Pages**: Your machine prints only the odd pages of the document.
 - **Print Even Pages**: Your machine prints only the even pages of the document.
- 7 Click other tabs on the top of the Printer Driver Type 2200 Properties window to access other features, if needed.
- 8 When you finish setting the properties, click **OK** until the Print window displays.
- 9 Click **OK** to start printing.

The printer's Properties window may differ, depending on your operating system. This Operating Instructions shows the Properties window on windows 98



Notes:

- Most Windows applications overrides the settings you specified in the printer driver. Change all of the print settings available in software application first, and change any remaining settings using the printer driver.
 - The settings you change remain in effect only while you are using the current program. To make your changes permanent, make them in the **Printers** folder. Follow these steps:
 1. Click the Windows **Start** menu.
 2. For Windows 95/98/Me/NT 4.0/2000, select **Settings** and then **Printers**.
For Windows XP, select **Printers and Faxes**.
 3. Select the **Printer Driver Type 2200** printer.
 4. Click the right mouse button on the printer icon and:
 - For Windows 95/98/Me, select **Properties**.
 - For Windows 2000/XP, select **Printing Preferences**.
 - For Windows NT 4.0, select **Document Default**.
 5. Change the settings on each tab and click **OK**.
-

Canceling a Print Job

There are two ways to cancel a print job:

To stop a print job from the control panel:

Press the **Clear/Stop** button.

Your machine finishes printing the page that is moving through the machine and deletes the rest of the print job. Pressing the button cancels only the current job. If more than one print job is in the machine's memory, you need to press the button once for each job.



5

To stop a print job from the Printers folder:

If the print job is waiting in a print queue or print spooler, such as the Printer group in Windows, delete the job as follows:

- 1 Click the Windows **Start** menu.
- 2 For Windows 9x/NT4.0/2000/Me, Select **Settings** and then **Printers**.
For Windows XP, select **Printers and Faxes**.
- 3 Double-click the **Printer Driver Type 2200** icon.
- 4 From the **Document** menu:
For Windows 9x/Me, select **Cancel Printing**.
For Windows NT4.0/2000/XP, select **Cancel**.

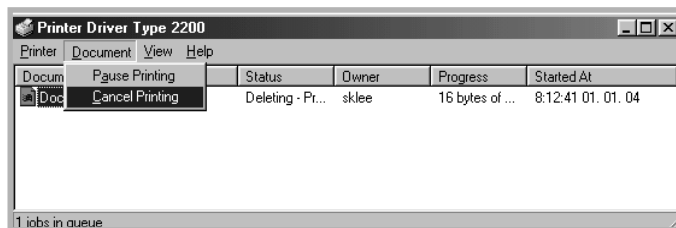

▲ Windows 98



NOTE: You can access this window simply by double-clicking the printer icon at the bottom right corner of the Windows desktop.

Using a Favorite Setting

The **Favorites** option, which is visible on each tab, allows you to save the current properties settings for future use.

To save a Favorites item:

- 1 Change the settings on each tab, as needed.
- 2 Enter a name for the item in the **Favorites** input box.

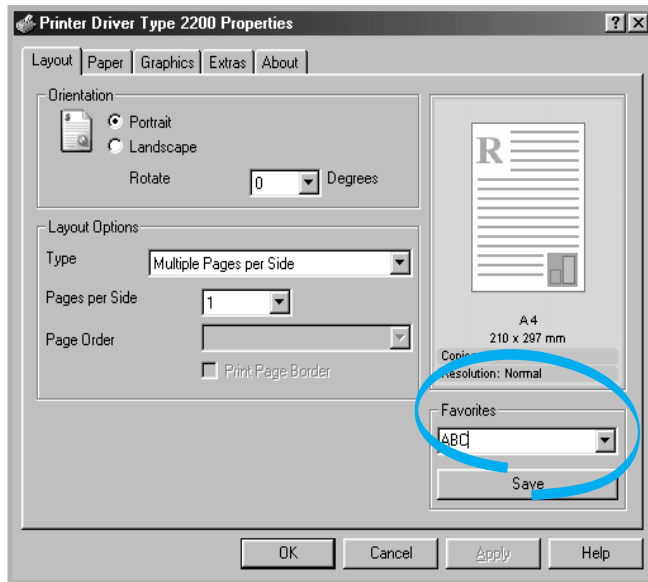

- 3 Click **Save**.

To use a saved setting, select it from the **Favorites** drop-down list.

To delete a favorite setting item, select it from the list and click **Delete**.

You can also restore the printer driver's default settings by selecting **<Printer Default>** from the list.

Using Help

Your machine has a help screen that can be activated using the **Help** button in the printer's Properties window. The help screen gives detailed information about the printer features provided by the printer driver.

You can also click **?** in the upper right hand corner, and then click on any setting.

Setting Paper Properties

Use the following options for paper handling. See page 5.2 for more information about accessing printer's Properties.

Click the **Paper** tab to access many paper properties.

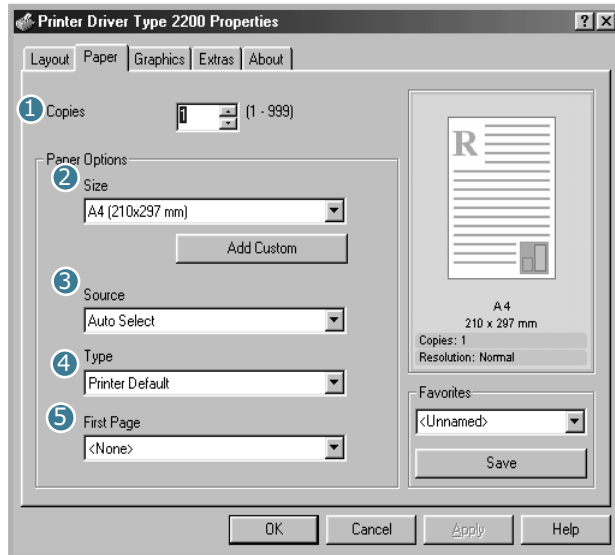

5

Property	Description
1 Copies	Copies allows you to choose the number of copies to be printed. You can enter up to 999.
2 Size	<p>Size allows you to choose the size of the paper loaded in the tray.</p> <p>If the required size is not listed in the Size box, click Add Custom. When the Custom Page Size window appears, set the size and click Ok. The setting appears on the list so that you can select it.</p>

Property	Description
<p>③ Source</p>	<p>Make sure that Source is set to the corresponding paper tray.</p> <p>Use the Manual Feed source when printing to special material. You need to load one sheet at a time into the manual feeder. See page 2.8.</p> <p>If you installed an optional Tray 2 and set the Tray 2 in the Printer's properties , you can select Tray 2.</p> <p>If the paper source is set to Auto Select, the machine automatically picks up print material in the following order: the manual feeder and the paper tray.</p>
<p>④ Type</p>	<p>Make sure that Type is set to Printer Default. If you load a different type of print material, select the corresponding paper type. For more information about print materials, see Chapter 2, Paper Handling.</p> <p>If you use cotton paper, set the paper type to Thick for the best printing.</p> <p>To use recycled paper, which weighs from 75g/m² to 90g/m² (20lb to 24lb), or colored paper, select Color Paper.</p>
<p>⑤ First Page</p>	<p>This property allows you to print the first page using a different paper type from the rest of the document. You can select the paper source for the first page.</p> <p>For example, load thick stock for the first page into the manual feeder and plain paper into Tray 1. Then, select 1 in the Source option and Manual Feed in the First Page option.</p>

Setting Graphic Properties

Use the following graphic options to adjust the print quality for your specific printing needs. See page 5.2 for more information about accessing printer properties.

Click the **Graphics** tab to display the properties shown below.

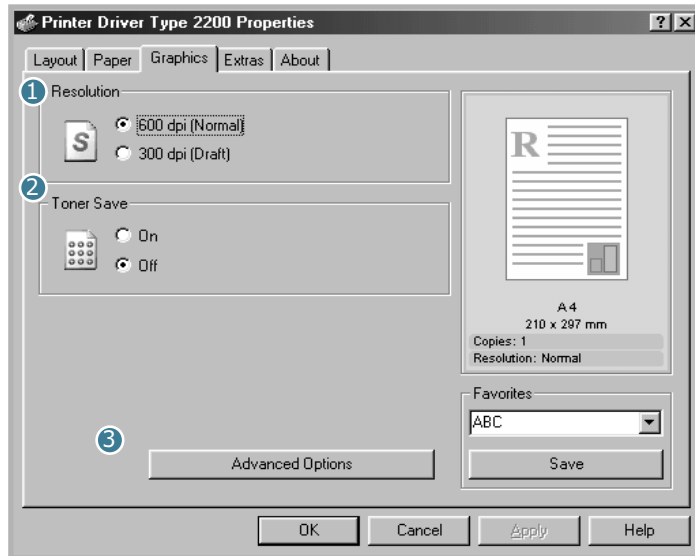

Property	Description
1 Resolution	You can select the printing resolution by choosing from 600 dpi (Normal) or 300 dpi (Draft) . The higher the setting, the sharper the printed characters and graphics. Higher settings may increase the time it takes to print a document.
2 Toner Save	Selecting this option extends the life of your toner cartridge and reduces your cost per page without a significant reduction in the print quality. <ul style="list-style-type: none">• On: Select this option to allow the machine to use less toner on each page.• Off: When you do not need to save toner to print a document, select this option.

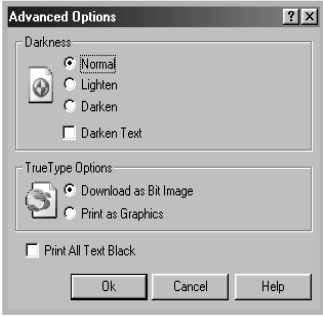
Property	Description
<p>3 Advanced Options</p>	<p>You can make advanced settings by clicking the Advanced Options button.</p>  <p>Darkness</p> <p>Use this option to lighten or darken the image appearance in your print.</p> <ul style="list-style-type: none"> • Normal: This setting is for normal documents. • Lighten: This setting is for bolder line widths or darker grayscale images. • Dark: This setting is for finer line width, higher definition in graphics and lighter grayscale images. <p>When the Darken Text option is checked, all text in your document is allowed to print darker than a normal document (Applicable only to DBCS* Windows such as Chinese, Japanese and Korean).</p> <hr/> <p>* <i>DBCS stands for Double Byte Character Set.</i></p>

Property	Description
3 Advanced Options (continued)	<p>True Type Options(for Win9x/Me only) This option determines what the driver tells the machine about how to image the text in your document. Select the appropriate setting according to the status of your document.</p> <ul style="list-style-type: none"> • Download as Bit Image: When this option is selected, the driver downloads the font data as bitmap images. Documents with complicated fonts, such as Korean or Chinese, or various types of fonts print faster in this setting. • Print as Graphics: When this option is selected, the driver downloads any fonts as graphics. When printing documents with high graphic content and relatively few TrueType fonts, printing performance (speed) may be enhanced in this setting. <p>Print All Text Black When the Print All Text Black option is checked, all text in your document prints in solid black, regardless of the color it appears on the screen. When it is not checked, colored text prints in shades of gray.</p>

Printing Multiple Pages on One Sheet of the Paper

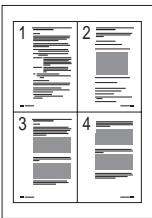

You can select the number of pages to print on a single sheet of paper. To print more than one page per sheet, the pages are smaller and arranged in the order you specified on the sheet. You can print up to 16 pages on one sheet.

- 1 To change the print settings from your software application, access the printer's Properties. See page 5.2.
- 2 From the **Layout** tab, choose **Multiple Pages per Side** from the **Type** drop-down list.

- 3 Select the number of pages you want to print per sheet (1, 2, 4, 9 or 16) on the **Pages per Side** drop-down list.

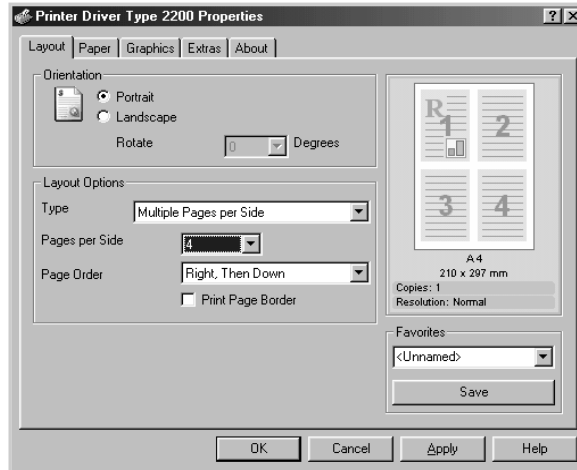

- 4 Select the page order on the **Page Order** drop-down list, if necessary.

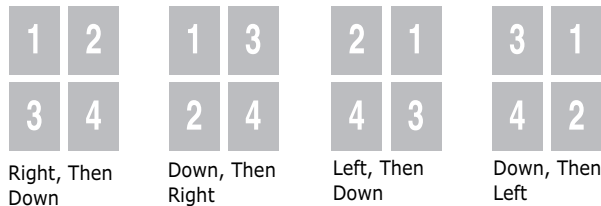

Check **Print Page Border** to print a border around each page on the sheet.



NOTE: Page Order and Print Page Border are enabled only when the number of pages per side is 2, 4, 9 or 16.

- 5 Click the **Paper** tab and select the paper source, size and type.
- 6 Click **OK** and print the document.

Printing a Reduced or Enlarged Document

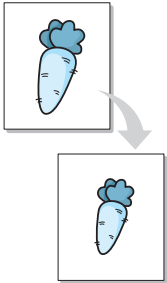

You can scale your print job on a page.

- 1 When you change the print settings from your software application, access the printer's Properties. See page 5.2.
- 2 From the **Layout** tab, select **Reduce/Enlarge** on the **Type** drop-down list.
- 3 Enter the scaling rate in the **Percentage** input box.

You can also click the ▲ or ▼ button.

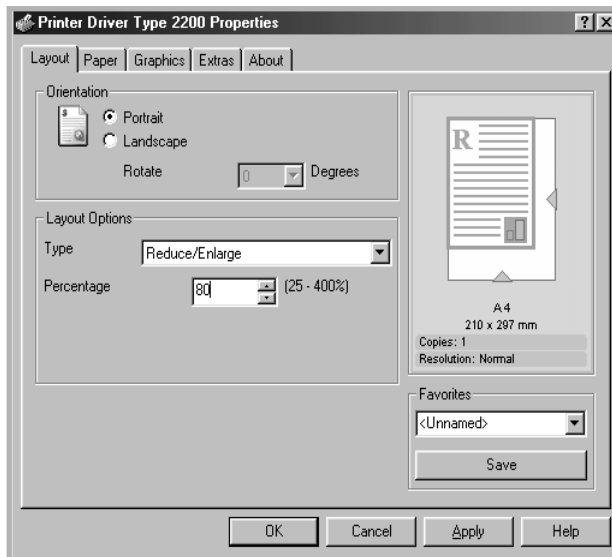

- 4 Click the **Paper** tab and select the paper source, size and type.
- 5 Click **OK** and print the document.

Fitting Your Document to a Selected Paper Size

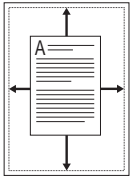

You can scale your print job to any paper size regardless of the digital document size. This can be useful when you want to check the fine details on a small document.

- 1 When you change the print settings from your software application, access the printer's Properties. See page 5.2.
- 2 From the **Layout** tab, select **Fit to Page** on the **Type** drop-down list.
- 3 Select the correct size from the **Target Page** drop-down list.

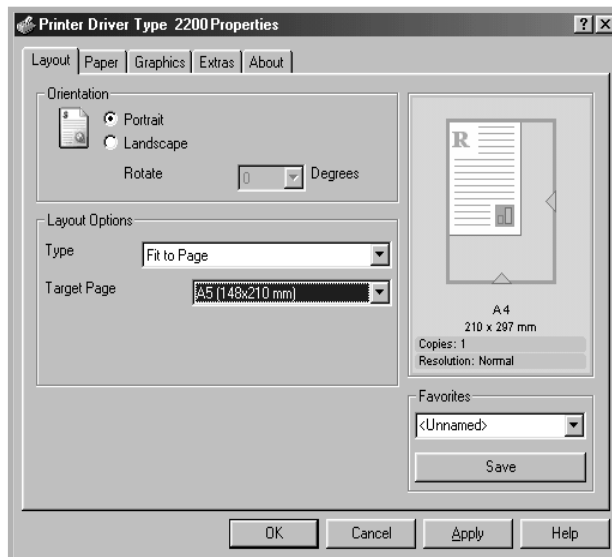

- 4 Click the **Paper** tab and select the paper source and type.
- 5 Click **OK** and print the document.

0.15 inches

Printing Posters

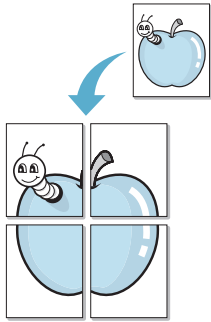

You can print a single-page document onto 4, 9 or 16 sheets of paper, for the purpose of pasting the sheets together to form one poster-sized document.

- 1 When you change the print settings from your software application, access the printer's Properties. See page 5.2.
- 2 From the **Layout** tab, select **Poster** on the **Type** drop-down list.

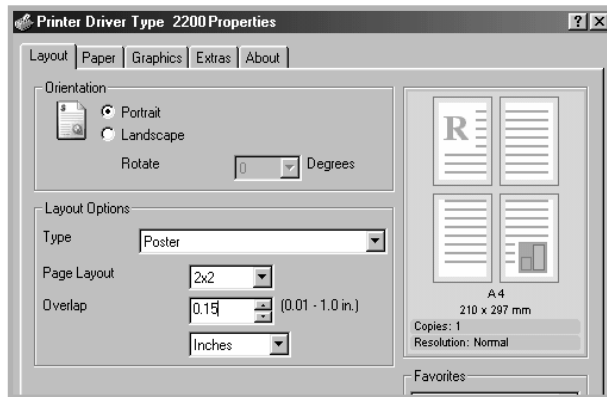

- 3 Configure the poster option:

You can select the page layout from **2x2**, **3x3** or **4x4**. If you select **2x2**, the image is automatically stretched to cover 4 physical pages.

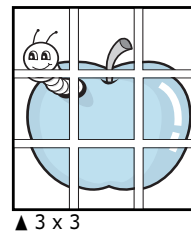
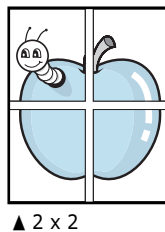

Specify an overlap in millimeters or inches to make it easier to reconstruct the resulting poster.

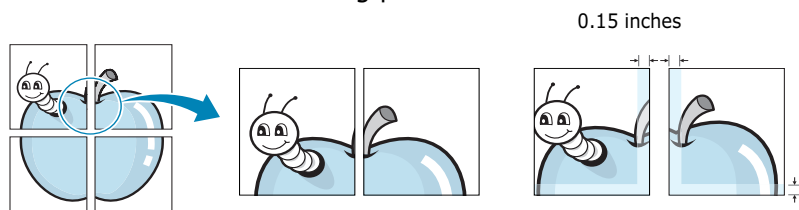

- 4 Click the **Paper** tab and select the paper source, size and type.
- 5 Click **OK** and print the document. You can complete the poster by posting the sheets together.

Using Watermarks



The Watermark option allows you to print text over an existing document. For example, you may want to have large gray letters reading "DRAFT" or "CONFIDENTIAL" printed diagonally across the first page or all of the pages of a document.

There are several predefined watermarks that come with your machine, and they can be modified or you can add new ones to the list.

Using an Existing Watermark

- 1 When you change the print settings from your software application, access the printer's Properties. See page 5.2.
- 2 Click the **Extras** tab and select a watermark on the **Watermark** drop-down list. It appears in the preview image window.

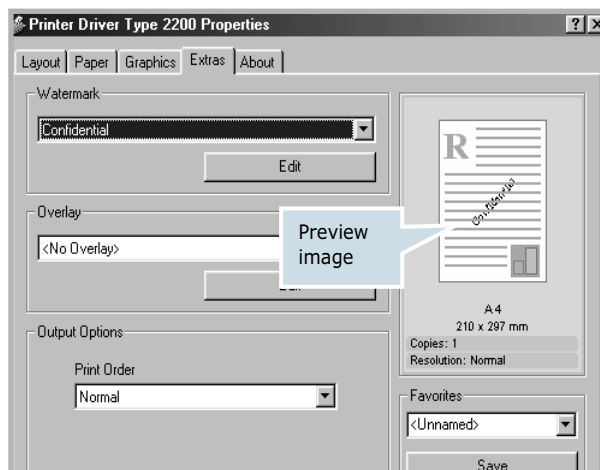

- 3 Click **Ok** and start printing.

Creating a Watermark

- 1 When you change the print settings from your software application, access the printer's Properties. See page 5.2.
- 2 Click the **Extras** tab and click **Edit** in the **Watermark** section. The Edit Watermarks window appears.

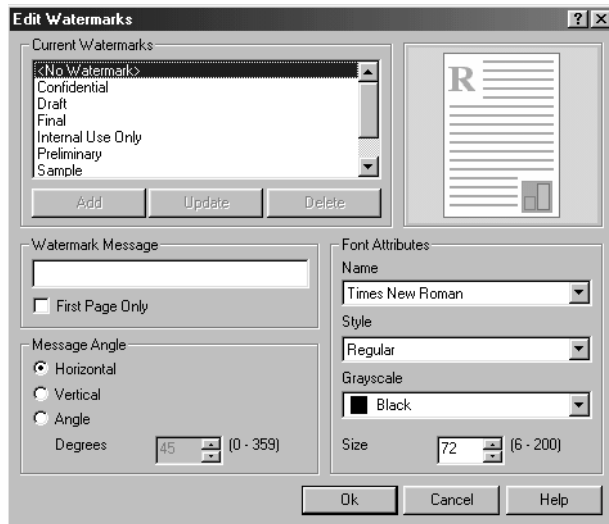

- 3 Enter text message you want to print in the **Watermark Message** box.

The message displays in the preview image window.

When the **First Page Only** box is checked, the watermark prints on the first page only.

- 4 Select the watermark options.

You can select the font name, style and size and gray scale level from the **Font Attributes** section and set the angle of the watermark from the **Message Angle** section.

- 5 Click **Add** to add a new watermark to the list.
- 6 When you finish creating, click **Ok** and start printing.

To stop printing the watermark, select **<No Watermark>** on the **Watermark** drop-down list.

Editing a Watermark

- 1 When you change the print settings from your software application, access the printer properties. See page 5.2.
- 2 Click the **Extras** tab and click **Edit** in the **Watermark** section. The Edit Watermarks window appears.
- 3 Select the watermark you want to edit on the **Current Watermarks** list, to change the watermark message and the options. Refer to page 5.17.
- 4 Click **Update** to save the changes.
- 5 Click **Ok**.

Deleting a Watermark

- 1 When you change the print settings from your software application, access the printer's Properties. See page 5.2.
- 2 From the **Extras** tab, click **Edit** in the **Watermark** section. The Edit Watermarks window appears.
- 3 Select the watermark you want to delete on the **Current Watermarks** list and click **Delete**.
- 4 When a confirming message window appears, click **Yes**.
- 5 Click **Ok**.

Using Overlays

What is an Overlay?

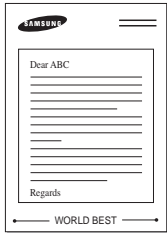

An overlay is text and/or images stored on the computer hard disk drive (HDD) as a special file format that can be printed on any document. Overlays are often used to take the place of preprinted forms and letterhead paper. Rather than using preprinted letterhead, you can create an overlay containing the exact same information that is currently on your letterhead. To print a letter with your company's letterhead, you need only tell the machine to print the letterhead overlay on your document.

Creating a New Page Overlay

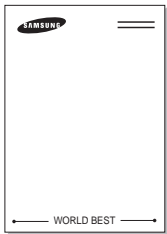

To use a page overlay, you must create a new page overlay containing your logo or image.

- 1 Create or open a document containing text or an image for use in a new page overlay. Position the items exactly as you wish them to appear when printed as an overlay. If needed, save the file for later use.
- 2 When you change the print settings from your software application, access the printer's Properties. See page 5.2.
- 3 Click the **Extras** tab and click **Edit** in the **Overlay** section.

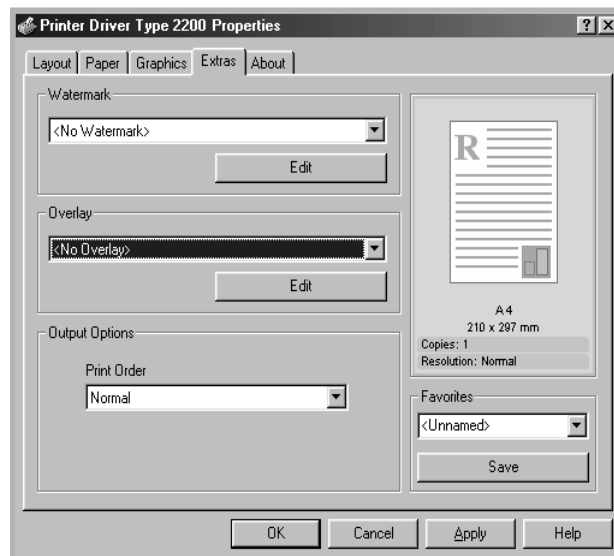

- 4 In the Edit Overlays window, click **Create Overlay**.

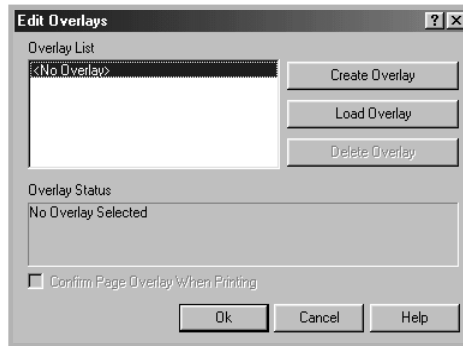

- 5 In the Create Overlay window, type a name of up to eight characters in the **File name** box. Select the destination path, if necessary. (The default is C:\Formover).

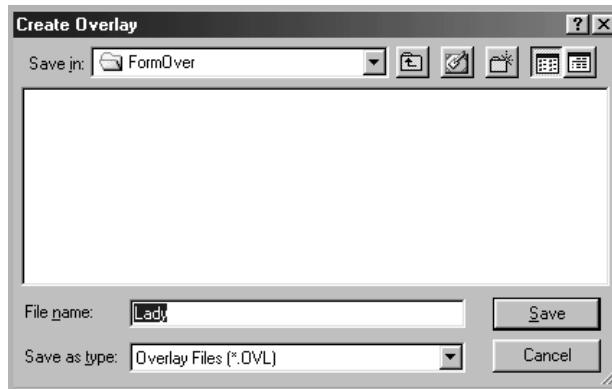

- 6 Click **Save**. The name appears on the Overlay List.
- 7 Click **Ok** or **Yes** to finish creating.

The file is not printed out. Instead it is stored in your computer HDD disk.



NOTE: The overlay document size must be the same as the documents you print with the overlay. Do not create an overlay with a watermark.

Using a Page Overlay

After an overlay has been created, it is ready to be printed with your document. To print an overlay with a document:

- 1 Create or open the document you want to print.
- 2 When you change the print settings from your software application, access the printer's Properties. See page 5.2.
- 3 Click the **Extras** tab.
- 4 Select the overlay you want to print from the **Overlay** drop-down list box.
- 5 When the overlay file you want doesn't appear on the Overlay List, click **Edit** and **Load Overlay**, and select the overlay file.

5

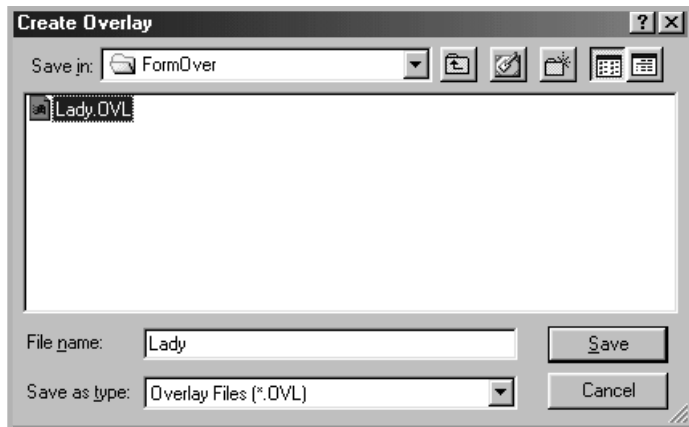

If you have stored the overlay file you want to use in an external source, you can also load the file when you access this Load Overlay window. After you select the file, click **Open**. The file appears on the Overlay List and is available for printing. Select the overlay from the **Overlay List** box.

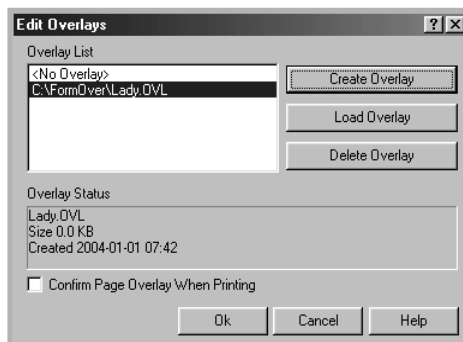

- 6 If necessary, click **Confirm Page Overlay When Printing**. When this box is checked, a message window appears each time you submit a document for printing, asking you to confirm your wish to print an overlay on your document.

Answering **Yes** to the window means that the selected overlay prints with your document. Answering **No** to the window cancels overlay printing.

If this box is empty and an overlay has been selected, the overlay will be automatically printed with your document.

- 7 Click **OK** or **Yes** until the printing starts.

The overlay downloads with your print job and prints on your document.



NOTE: The resolution of the overlay document must be the same as that of the document you will print with the overlay.

Deleting a Page Overlay

You can delete page overlays that you no longer use.

- 1 In the printer's properties window, click the **Extras** tab.
- 2 Click **Edit** in the Overlay section.
- 3 Select the overlay you want to delete from the Overlay List box.
- 4 Click **Delete Overlay**.
- 5 When a confirming message window appears, click **Yes**.
- 6 Click **OK** until you exit the Print window.

Setting Up the Locally Shared Printer

You can connect the machine directly to a selected computer, which is called "host computer," on the network. Your machine can be shared by other users on the network through a Windows 9x, Me, 2000, XP or NT 4.0 network printer connection.



NOTE: Whether the printer is locally connected or network-connected, you need to install the printer software on each computer that will print documents to the printer.

In Windows 9x/Me

Setting Up the Host Computer

- 1 Start Windows.
- 2 From the **Start** menu, select **Control Panel** and double-click on the **Network** icon.
- 3 Check the **File and Print Sharing** box and click **OK**.
- 4 Click **Start** and select **Printers** from **Settings**. Double-click your printer icon.
- 5 Select **Properties** in the **Printer** menu.
- 6 Click the **Sharing** tab and check the **Shared As** box. Fill in the **Share Name** field and then click **OK**.

Setting Up the Client Computer

- 1 Right-click **Start** and select **Explorer**.
- 2 Open your network folder in the left column.
- 3 Right-click the shared name and select **Capture Printer Port**.
- 4 Select the port you want, check the **Reconnect at log on** box and then click **OK**.
- 5 From the **Start** menu, select **Settings** and then **Printers**.
- 6 Double-click your printer icon.
- 7 From the **Printer** menu, select **Properties**.
- 8 From the **Details** tab, select the printer port and click **OK**.

In Windows NT 4.0/2000/XP

Setting Up the Host Computer

- 1 Start Windows.
- 2 For Windows NT 4.0/2000, from the **Start** menu, select **Settings** and then **Printers**.
For Windows XP, from the **Start** menu, select **Printers and Faxes**.
- 3 Double-click your printer icon.
- 4 From the **Printer** menu, select **Sharing**.
- 5 For Windows NT 4.0, check the **Shared** box.
For Windows 2000, check the **Shared As** box.
For Windows XP, check the **Share this printer** box.
- 6 For Windows NT 4.0, fill in the **Share Name** field and click **OK**.
For Windows 2000/XP, fill in the **Shared Name** field and click **OK**.

Setting Up the Client Computer

- 1** Right-click **Start** and select **Explorer**.
- 2** Open your network folder in the left column.
- 3** Click the shared name.
- 4** For Windows NT 4.0/2000, from the **Start** menu, select **Settings** and **Printers**.
For Windows XP, from the **Start** menu, select **Printers and Faxes**.
- 5** Double-click your printer icon.
- 6** From the **Printer** menu, select **Properties**.
- 7** Press the **Ports** tab and click **Add Port**.
- 8** Select **Local Port** and click **New Port**.
- 9** Fill in the **Enter a port name** field and enter the shared name.
- 10** Click **OK** and click **Close**.
- 11** For Windows NT 4.0, click **OK**.
For Windows 2000/XP, click **Apply** and click **OK**.



6

SCANNING

Scanning with your machine lets you turn pictures and text into digital files on your computer. Then you can fax or e-mail the files, display them on your web site or use them to create projects that you can print using software.

This chapter includes:

- **Scanning Basics**
- **Scanning Process with TWAIN-enabled Software**

Scanning Basics

Your machine offers a following way to begin scanning:

- From TWAIN-compliant software: You can use other software including Adobe PhotoDeluxe and Adobe Photoshop.



NOTES:

- To scan with your machine, you must install the Type 2200 Driver.
 - Scanning is done through the same LPT or USB port currently assigned for your printer port.
-

Scanning Process with TWAIN-enabled Software

If you want to scan documents using other software, you will need to use TWAIN-compliant software, such as Adobe PhotoDeluxe or Adobe Photoshop. The first time you scan with your machine, select it as your TWAIN source in the application you use.

The basic scanning process involves a number of steps:

- Place your photograph or page in the ADF.
- Open an application, such as PhotoDeluxe or Photoshop.
- Open the TWAIN window and set the scan options.
- Scan and save your scanned image.

You need to follow the program's instructions for acquiring an image. Please refer to the operating instructions of the application.



7

MAINTENANCE

This chapter provides information for maintaining your machine and the toner cartridge.

This chapter includes:

- **Clearing the Memory**
- **Adjusting Shading**
- **Cleaning Your Machine**
- **Maintaining the Toner Cartridge**

Clearing the Memory

You can selectively clear information stored in your machine's memory.

- 1 Press **Menu** on the control panel until "Maintenance" appears on the top line of the display.
- 2 Press the scroll button (◀ or ▶) until you see "Clear Memory" on the bottom line and press **Enter**.

The first available menu item, "Clear All Mem." displays on the bottom line.

- 3 Press the scroll button (◀ or ▶) until you see the item you want to clear.
 - Clear All Mem.: Clears all of the data stored in memory and resets all of your settings to the factory default.
 - Paper Setting: Restores all of the Paper Setting options to the factory default.
 - Copy Setup: Restores all of the Copy Setup options to the factory default.
 - Fax Setup: Restores all of the Fax Setup options to the factory default.
 - Fax Feature: Cancels all of the scheduled fax jobs in the machine's memory.
 - Advanced Fax: Restores all of the Advanced Fax setting options to the factory default.
 - Sound/Volume: Resets the sound and volume settings to the factory default.
 - Machine Setup: Resets all of the system settings, such as the machine ID, time and date, display language and save modes, to the factory default.
 - Sent Report: Clears all the records of your faxes sent.
 - RCV Report: Clears all the records of your faxes received.
 - Phone Book: Clears the one-touch, speed and group dial numbers stored in memory.
- 4 Press **Enter**. The selected memory is cleared and the display asks you to continue clearing the next item.
- 5 To clear another item, press **Enter** and repeat steps 3 and 4.

OR

To return to Standby mode, press **Clear/Stop**.

Adjusting Shading

When the scanning glass becomes dirty, it can alter the shading value. If your copy has black lines or is blurred, adjust the shading setting.

- 1 Load a sheet of white paper into the ADF.
- 2 Press **Menu** on the control panel until "Maintenance" appears on the top line of the display.
- 3 Press the scroll button (◀ or ▶) until "Adjust Shading " appears on the bottom line and press **Enter**.
- 4 Press the scroll button (◀ or ▶) to select "On" and press **Enter**.

Your machine picks up the paper and adjusts the shading value.

Cleaning Your Machine

To maintain the print quality, follow the cleaning procedures below each time the toner cartridge is replaced or if print quality problems occur.



NOTES:

- While cleaning the inside of the machine, be careful not to touch the transfer roller, located underneath the toner cartridge. Oil from your fingers can cause print quality problems.
 - Cleaning the cabinet of the machine with surfactants containing large amounts of alcohol, solvent or other strong substances can discolor or crack the cabinet.
 - Keep the machine away from flammable liquids, gases, and aerosols. A fire or an electric shock might occur.
-

Cleaning the Outside

Clean the cabinet of the machine with a soft lint-free cloth. You can dampen the cloth slightly with water, but be careful not to be let any water drip onto or into the machine.

Cleaning the Inside

During the printing process, paper, toner and dust particles can accumulate inside the machine. This buildup can cause print quality problems, such as toner specks or smearing. Cleaning the inside of the machine clears or reduces these problems.

- 1 Turn the machine off and unplug the power cord. Wait for the machine to cool down.
- 2 Open the front cover and pull the toner cartridge out, lightly pushing it down.

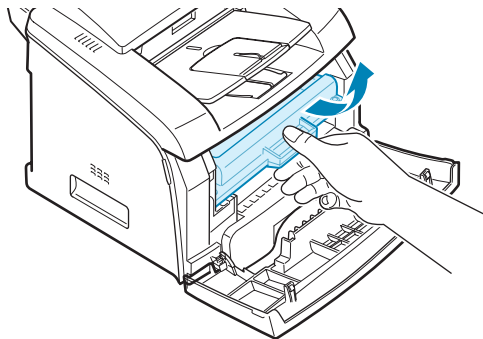

- 3 With a dry lint-free cloth, wipe away any dust and spilled toner from the toner cartridge area and the toner cartridge cavity.

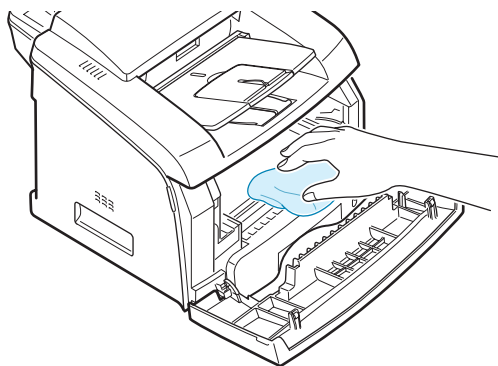

NOTE: To prevent damage to the toner cartridge, do not expose it to light for more than a few minutes. Cover it with a piece of paper, if necessary. Do not touch the black transfer roller inside the machine.

- 4 Reinsert the toner cartridge and close the cover.
- 5 Plug in the power cord and turn the machine on.

Cleaning the Scanning Glass

Keeping the scanning glass clean helps ensure the best possible copies. We suggest that you clean the scanning glass at the start of each day and during the day, as needed.

- 1 Slightly dampen a soft lint-free cloth or paper towel with water.
- 2 Open the control panel by gripping its top and pulling it.

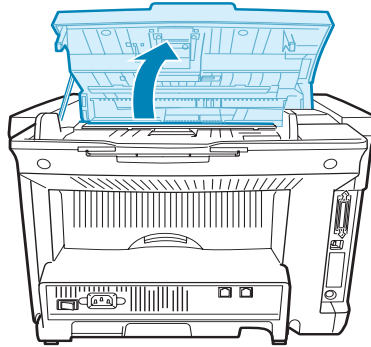

- 3 Carefully wipe the scanning glass with a soft dry cloth.

If the glass is very dirty, first wipe it with a slightly dampened cloth, and then with a dry cloth. Be very careful not to scratch the glass surface.

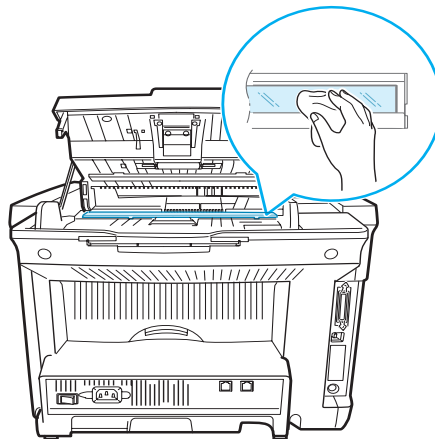

- 4 Close the control panel firmly until it clicks into place.

Maintaining the Toner Cartridge

Toner Cartridge Storage

To get the most from the toner cartridge, keep the following guidelines in mind:

- Do not remove the toner cartridge from its package until ready for use.
- Do not refill the toner cartridge. **The machine warranty does not cover damage caused by using a refilled cartridge.**
- Store toner cartridges in the same environment as your machine.
- To prevent damage to the toner cartridge, do not expose it to light for more than a few minute.

Redistributing Toner

When the toner cartridge is near the end of its life, white streaks or light print occurs. The LCD displays the warning message, “[Toner Low].” You can temporarily reestablish the print quality by redistributing the remaining toner in the cartridge.

- 1 Open the front cover.

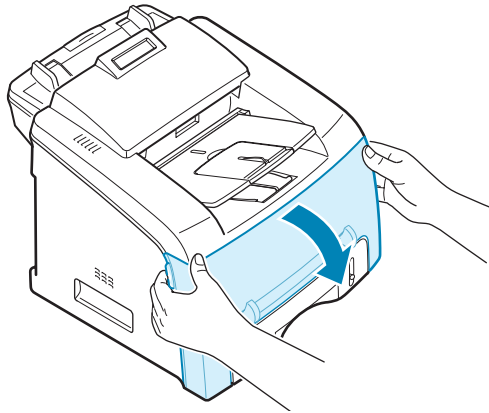

- 2 Pull the toner cartridge out and gently roll the cartridge 5 or 6 times to distribute the toner evenly inside the cartridge.

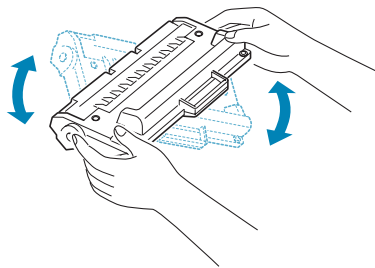

NOTE: If the toner gets on your clothing, wipe it off with a dry cloth and wash clothing in cold water. Hot water sets the toner into fabric.

- 3 Reinstall the cartridge and close the front cover.

Replacing the Toner Cartridge

When the toner eventually runs out, only blank pages print when a print job is sent or when a fax is received. At this stage, the toner cartridge needs to be replaced. The display on the control panel shows the warning message, "[Toner Empty]" and the machine stops printing.



NOTE: You can set the machine to ignore the "[Toner Empty]" message and continue printing. See page 7.10.

- 1 Open the front cover.
- 2 Lightly pushing the used cartridge down, pull the cartridge out.
- 3 Unpack the new toner cartridge and gently roll it horizontally four or five times to distribute the toner evenly inside the cartridge.
Save the box and the plastic bag for shipping.
- 4 Slide the new toner cartridge in until it locks into place.

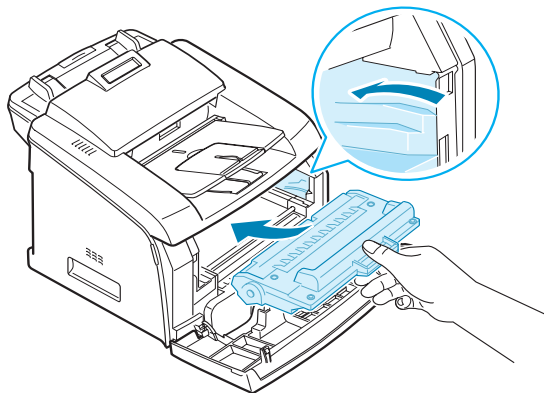

- 5 Close the front cover.

Setting the Notify Toner Option

If you have set the Notify Toner menu option to "On", your machine automatically sends a fax to your service company or the dealer to notify them that your machine requires a new toner cartridge when the toner cartridge needs to be replaced. The fax number is preset by your dealer when you bought your machine.

- 1** Press **Menu** on the control panel until "Maintenance" appears on the top line of the display.

The first available menu item, "Clean Drum," displays on the bottom line.
- 2** Press the scroll button (◀ or ▶) to display "Notify Toner " on the bottom line and press **Enter**.
- 3** Press the scroll button (◀ or ▶) to change the setting.

Select "On" to enable this feature. Selecting "Off" disables this feature.
- 4** Press **Enter** to save the selection.

Cleaning the Drum

If there are streaks or spots on your print, the OPC drum of the cartridge may require cleaning.

- 1** Before setting the cleaning procedure, make sure that paper is loaded in the machine.
- 2** Press **Menu** on the control panel until "Maintenance" appears on the top line of the display.

The first available menu item, "Clean Drum," displays on the bottom line.
- 3** Press **Enter**.
- 4** When the display asks you to confirm your selection, press **Enter**.

The machine prints a cleaning page. Toner particles on the drum surface are affixed to the paper.
- 5** If the problem remains, repeat steps 1 through 4.

Ignoring the Toner Empty Message

When the toner cartridge is empty, the machine shows a "[Toner Empty]" message and stops printing.

You can set the machine to ignore the message when it displays and to continue printing the pages.

- 1** Press **Menu** until "Machine Setup" appears on the display.
- 2** Press the scroll button (◀ or ▶) until "Ignore Toner" appears on the bottom line and press **Enter**.
- 3** Press the Scroll button (◀ or ▶) to select "On" or "Off."
Select "On" to ignore the Toner Empty message.
Select "Off" to stop printing when the message appears.
This is the default setting.
- 4** Press **Enter** to save the selection.



8

TROUBLESHOOTING

This chapter gives helpful information for what to do if you encounter an error.

This chapter includes:

- **Clearing Document Jams**
- **Clearing Paper Jams**
- **Clearing LCD Error Messages**
- **Solving Problems**

Clearing Document Jams

When a document jams while it passes through the ADF (Automatic Document Feeder), “[Document Jam]” appears on the display.

- 1 Remove the remaining documents from the ADF.
- 2 Pull the jammed document gently out of the ADF and skip to step 5.

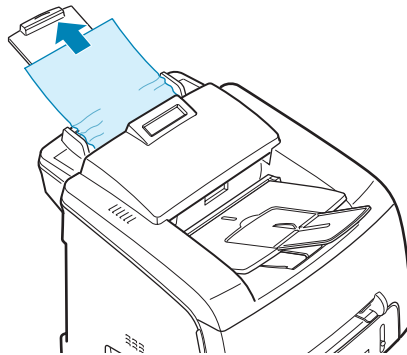

If there is any resistance and the document does not move when you pull it, continue to the next step.

- 3 Open the control panel by gripping its top and pulling on it.

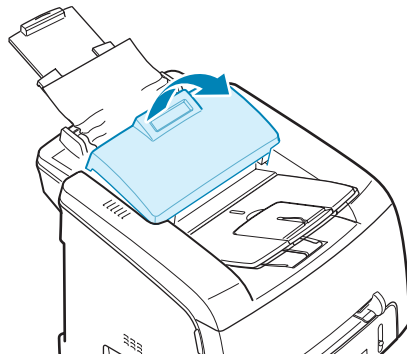

- 4 Pull the document gently out of the ADF and close the control panel.
- 5 Load the documents back into the ADF.



NOTE: To prevent document jams, do not use thick, thin or mixed documents.

Clearing Paper Jams

When a paper jam occurs, "Paper Jam" appears on the display. Refer to the table below to locate and clear the paper jam.

Message	Location of Jam	Go to
[Paper Jam 0] Open/Close Door	In the paper tray. (Tray 1 or Tray 2)	page 8.3
[Paper Jam 1] Open/Close Door	In the fuser area or around the toner cartridge. In the manual feeder	page 8.6
[Paper Jam 2] Check Inside	In the paper exit area	page 8.5

To avoid tearing the paper, pull the jammed paper out gently and slowly. Do as the instructions in the following sections to clear the jam.

In Tray 1

- 1 Open and close the front cover. The jammed paper automatically exits the machine.

If the paper does not exit, continue to step 2.

- 2 Pull Tray 1 open.
- 3 Remove the jammed paper by gently pulling it straight out.

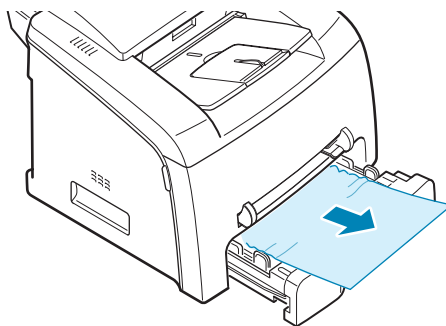

If there is any resistance and the paper does not move when you pull it or if you cannot see the paper in this area, skip to the fuser area around the toner cartridge. See page 8.6.

- 4 Insert the paper tray into the machine until it snaps into place.
- 5 Open and close the front cover to resume printing.

In Tray 2

- 1 Open and close the front cover. The jammed paper automatically exits the machine.

If the paper does not exit, continue to step 2.

- 1 Pull Tray 2 open.
- 2 Remove the jammed paper by gently pulling it straight out.

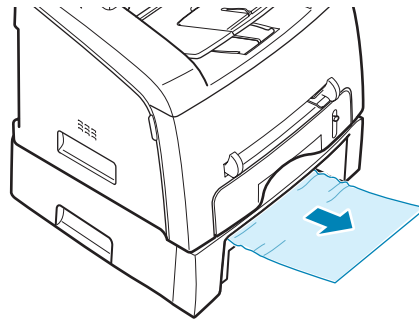

- 3 Insert the paper tray into the machine until it snaps into place.
- 4 Open and close the front cover to resume printing.

In the Paper Exit Area

- 1 Open and close the front cover. The jammed paper automatically exits the machine.

If the paper does not exit, continue to step 2.

- 2 Gently pull the paper out of the front output tray. Skip to step 6.

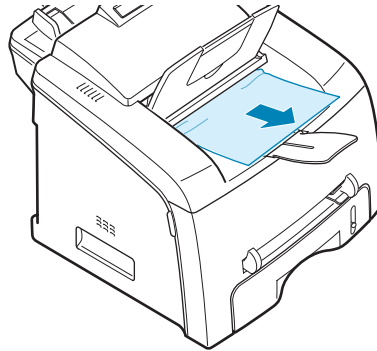

If there is any resistance and the paper does not move when you pull it or if you cannot see the paper in the front output tray, continue to step 3.

- 3 Open the rear cover.
- 4 Remove the jammed paper by gently pulling it straight out.

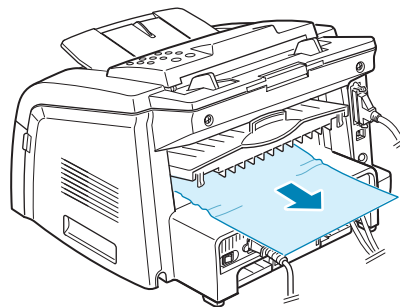

- 5 Close the rear cover.
- 6 Open and close the front cover to resume printing.

In the Fuser Area or Around the Toner Cartridge



WARNING: The fuser area is hot. Take care when removing paper from the machine.

- 1 Open the front cover and pull the toner cartridge out, lightly pushing it down.
- 2 Remove the jammed paper by gently pulling it straight out.

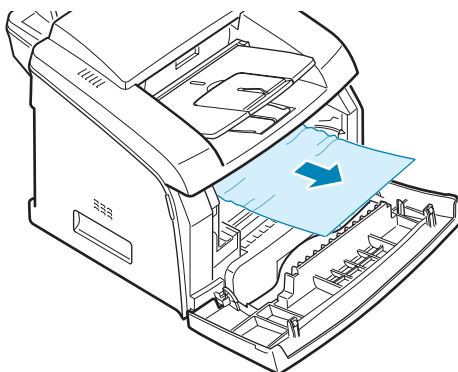

- 3 Replace the toner cartridge and close the front cover. Printing automatically resumes.

In the Manual Feeder

" [Paper Jam 1] Open/Close Door " appears on the display when you try to print using the manual feeder and the machine does not detect paper, due to no paper or improper paper loading.

The error message may also occur when the paper is not properly fed into the machine through the manual feeder. In that case, pull the paper out of the machine.

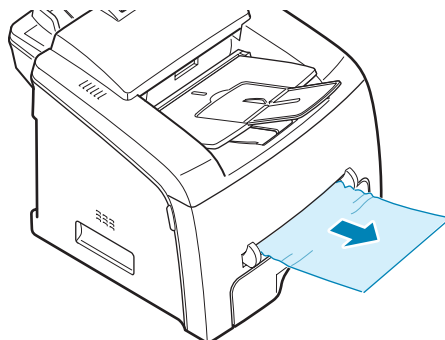

Tips for Avoiding Paper Jams

By selecting the correct paper types, most paper jams can be avoided. When a paper jam occurs, follow the steps outlined in page 8.3.

- Follow the procedures on page 1.11 when you load paper. Ensure that the adjustable guides are positioned correctly.
- Do not overload the paper tray. Ensure that the paper is below the paper capacity mark on the inside wall of the paper tray.
- Do not remove the paper from the tray while your machine is printing.
- Flex, fan and straighten the paper before loading.
- Do not use creased, damp or highly curled paper.
- Do not mix paper types in the paper tray.
- Use only recommended print materials. See "Paper Specifications" on page 9.9.
- Ensure that the print side of print materials is facing down in the paper tray and facing up in the manual feeder.
- If paper jams frequently occur when you print on the A5-sized paper:
 - Load the paper into the tray as shown below.

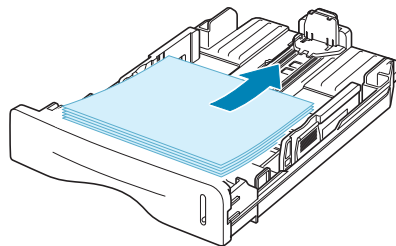

- Set the page orientation to **Landscape** in the printer's Properties window. See page 5.3.

Clearing LCD Error Messages

Messages appear on the display of the control panel to indicate the machine's status or errors. Refer to the following table to understand the messages and correct the problem, if necessary. Messages and their meanings are listed in alphabetical order.

Display	Meaning	Suggested solutions
Cancel ? 1:Yes 2:No	Your machine's memory is full and cannot store the document into memory.	To cancel the fax job, press the 1 button to accept "Yes." If you want to send the pages that were stored, press the 2 button to accept "No." You should send the remaining pages later when memory is available.
[Comm. Error]	The machine has a communication problem.	Ask the sender to try again.
CRU Fuse Error	The machine has a problem with recognizing the new toner cartridge.	Please contact a service representative or re-install the cartridge.
[Document Jam]	The loaded document has jammed in the ADF (Automatic Document Feeder).	Clear the document jam. See page 8.2.
[Door Open]	The front or rear cover is not securely latched.	Close the cover until it locks into place.
Group Not Available	You have tried to select a group location number where only a single location number can be used, such as when adding locations for a broadcasting operation.	Just use a one-touch or speed dial number or dial a number manually using the number keypad.

Display	Meaning	Suggested solutions
[Incompatible]	<p>The remote machine does not have the requested feature, such as a delayed transmission.</p> <p>It also occurs if the remote machine does not have enough memory space to complete the operation you are attempting.</p>	Reconfirm the remote machine's features.
[Jam 1] or [No Cartridge]	The toner cartridge is not installed.	Install the toner cartridge. See page 1.9.
[Line Busy]	The remote person did not answer or the line is already engaged.	Try again after a few minutes.
[Line Error]	Your machine cannot connect with the remote machine or has lost contact because of a problem with the phone line.	<p>Try again. If the problem persists, wait an hour or so for the line to clear and try again.</p> <p>Or, turn the ECM on. See page 4.35.</p>
Load Document	You have attempted to set up a copy or fax operation with no document loaded.	Load a document and try again.
Low Heat Error	There is a problem in the fuser unit.	Unplug the power cord and plug it back in. If the problem persists, please contact a service representative.
Open Heat Error		
[Over Heat]		
[LSU Error]	A problem has occurred in the LSU (Laser Scanning Unit).	Unplug the power cord and plug it back in. If the problem persists, please call for service.
Memory Full	The memory is full.	Delete unnecessary documents, retransmit after more memory becomes available or split the transmission into more than one operation.
[No Answer]	The remote fax machine has not answered after several redial attempts.	Try again. Make sure that the remote machine is operational.

Display	Meaning	Suggested solutions
No. Not Assigned	The one-touch or speed dial location you tried to use has no number assigned to it.	Dial the number manually using the number keypad or assign the number. For storing a number, see "Automatic Dialing" on page 4.15.
[No Paper] Add Paper	The paper tray has run out of paper.	Load paper in the paper tray. See page 1.11.
Operation Not Assigned	You are in the Add/Cancel operation, but there are no jobs waiting.	Check the display to see if there are any scheduled jobs. The display should indicate them in Standby mode, for example, Delay Fax.
[Paper Jam 0] Open/Close Door	Paper has jammed in the feeding area of the paper tray.	Clear the jam. See page 8.3.
[Paper Jam 1] Open/Close Door	<ul style="list-style-type: none"> Paper has jammed in the paper exit area. A paper jam has occurred in the manual feeder or the machine detects non-feeding from the manual feeder. 	Clear the jam. See page 8.6.
[Paper Jam 2] Check Inside	Paper has jammed in the fuser area.	Clear the jam. See page 8.5.
[Power Failure]	Power has turned off then on and the machine's memory has not been saved.	You need to restart the job you were trying to do before the power failure.
[Retry Redial?]	The machine is waiting for a specified time interval to redial a previously busy station.	You can press Enter to immediately redial, or Clear/Stop to cancel the redial operation.
[Stop Pressed]	The Clear/Stop button is pressed during a copy or fax operation.	Try again.
[Toner Empty]	The toner cartridge has run out. The machine stops printing.	Replace with a new toner cartridge. See page 7.8.
[Toner Low]	The toner cartridge is almost empty.	Take out the toner cartridge and gently shake it. By doing this, you can temporarily reestablish printing operations.

8.10 TROUBLESHOOTING

Solving Problems

The following chart lists some conditions that may occur and the recommended solutions. Follow the suggested solutions until the problem is corrected. If the problem persists, please call for service.

Paper Feeding Problems

Condition	Suggested solutions
Paper is jammed during printing.	Clear the paper jam. See page 8.3.
Paper sticks together.	<ul style="list-style-type: none">• Ensure that there is not too much paper in the paper tray. The paper tray can hold up to 250 sheets of paper, depending on the thickness of your paper.• Make sure that you are using the correct type of paper. See "Paper Specifications" on page 9.9.• Remove paper from the paper tray and flex or fan the paper.• Humid conditions may cause some paper to stick together.
Multiple sheets of paper do not feed.	<ul style="list-style-type: none">• Different types of paper may be loaded in the paper tray. Load the paper of only one type, size and weight.• If multiple sheets have caused a paper jam, clear the paper jam. See page 8.3.
Paper does not feed into the machine.	<ul style="list-style-type: none">• Remove any obstructions from inside the machine.• Paper has not been loaded correctly. Remove paper from the tray and reload it correctly.• There is too much paper in the paper tray. Remove excess paper from the tray.• The paper is too thick. Use only paper that meets the specifications required by the machine. See "Paper Specifications" on page 9.9.
The paper keeps jamming.	<ul style="list-style-type: none">• There is too much paper in the paper tray. Remove excess paper from the tray.• An incorrect type of paper is being used. Use only paper that meets the specifications required by the machine. See "Paper Specifications" on page 9.9. If you are printing on special materials, use the manual feeder.• There may be debris inside the machine. Open the front cover and remove the debris.
Transparencies stick together in the paper exit.	Use only the transparencies specifically designed for a laser printer. Remove each transparency as it exits from the machine.
Envelopes skew or fail to feed correctly.	Ensure that the paper guides are against both sides of the envelopes.

Printing Problems

Condition	Possible cause	Suggested solutions
The machine does not print.	The machine is not receiving power.	Check the power cord connections. Check the power switch and the power source.
	The machine is not selected as the default printer.	Select Printer Driver Type 2200 as your default printer in your Windows.
	Check the machine for the following: <ul style="list-style-type: none"> • The front cover is not closed. • Paper is jammed. • No paper is loaded. • The toner cartridge is not installed. 	After locating the problem, clear it. <ul style="list-style-type: none"> • Close the cover. • Clear the paper jam. See page 8.3. • Load paper. See page 1.11. • Install the toner cartridge. See page 1.9. If a printer system error occurs, contact your service representative.
	The connection cable between the computer and the machine is not connected properly.	Disconnect the printer cable and reconnect it.
	The connection cable between the computer and the machine is defective.	If possible, attach the cable to another computer that is working properly and print a document. You can also try using a different printer cable.
	The port setting is incorrect.	Check the Windows printer setting to make sure that the print job is sent to the correct port, for example, LPT1. If the computer has more than one port, make sure that the machine is attached to the correct one.
	The machine may be configured incorrectly.	Check the printer properties to ensure that all of the print settings are correct.
	The printer driver may be incorrectly installed.	Repair the printer software. See page 1.24.
	The machine is malfunctioning.	Check the display message on the control panel to see if the machine is indicating a system error.
The machine selects print materials from the wrong paper source.	The paper source selection in the printer properties may be incorrect.	For many software applications, the paper source selection is found under the Paper tab within the printer properties. Select the correct paper source. See page 5.8.



Condition	Possible cause	Suggested solutions
A print job is extremely slow.	The job may be very complex.	Reduce the complexity of the page or try adjusting the print quality settings. The maximum print speed of your machine is 17 PPM for Letter-sized paper 16 PPM for A4-sized paper.
	If you are using Windows 9x/Me, the Spooling Setting may be set incorrectly.	From the Start menu, choose Settings and Printers . Right-click the Printer Driver Type 2200 printer icon, choose Properties , click the Details tab, and then choose the Spool Settings button. Select the spool setting you want.
Half the page is blank.	The page orientation setting may be incorrect.	Change the page orientation in your application. See page 5.3.
	The paper size and the paper size settings do not match.	Ensure that the paper size in the printer driver settings matches the paper in the tray.
The machine prints, but the text is wrong, garbled or incomplete.	The printer cable is loose or defective.	Disconnect the printer cable and reconnect. Try a print job that you have already printed successfully. If possible, attach the cable and the machine to another computer and try a print job that you know works. Finally, try a new printer cable.
	The wrong printer driver was selected.	Check the application's printer selection menu to ensure that your machine is selected.
	Software application is malfunctioning.	Try printing a job from another application.
	The operating system is malfunctioning.	Exit Windows and reboot the computer. Turn the machine off and then back on again.
Pages print, but are blank.	The toner cartridge is defective or out of toner.	Redistribute the toner, if necessary. See page 7.7. If necessary, replace the toner cartridge.
	The file may have blank pages.	Check the file to ensure that it does not contain blank pages.
	Some parts, such as the controller or the board, may be defective.	Contact a service representative.



Condition	Possible cause	Suggested solutions
The illustrations print incorrectly in Adobe Illustrator.	The setting in software application is wrong.	Select Download as Bit Image in the Advanced Options window of the Graphic properties and print the document.
An error occurs repeatedly when you are printing with the USB connection.	When the USB mode is set to "Fast," some PC users may experience poor USB communication.	Change the USB mode to "Slow." To do so, follow these steps: <ol style="list-style-type: none"> 1. Press Menu on the control panel until "Machine Setup" appears on the top line of the display. 2. Press the scroll button (◀ or ▶) until "USB Mode" appears on the bottom line, and press Enter. 3. Press the scroll button (◀ or ▶) to select "Slow." 4. Press Enter to save the selection. 5. Press Clear/Stop to return to Standby Mode.

Printing Quality Problems

The dirty inside of the machine or improper paper loading may reduce the print quality. See the table below to clear the problem.

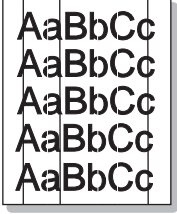
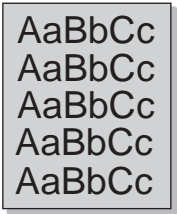
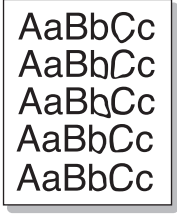
Condition	Suggested solutions
<p>Light or faded print</p> 	<p>If a vertical white streak or faded area appears on the page:</p> <ul style="list-style-type: none"> • The toner supply is low. You may be able to temporarily extend the toner cartridge life. See "Redistributing Toner" on page 7.7. If this does not improve the print quality, install a new toner cartridge. • The paper may not meet paper specifications; for example, the paper is too moist or too rough. See "Paper Specifications" on page 9.9. • If the entire page is light, the print resolution setting is too low or Toner Save mode is on. Adjust the print resolution and turn Toner Save mode off. See page 5.9 respectively. • A combination of faded or smeared defects may indicate that the toner cartridge needs cleaning. See "Cleaning the Drum" on page 7.9. • The surface of the scanning glass may be dirty. Clean the glass. See page 7.5.

Condition	Suggested solutions
<p>Toner specs</p> 	<ul style="list-style-type: none"> • The paper may not meet specifications; for example, the paper is too moist or too rough. See "Paper Specifications" on page 9.9. • The transfer roller or paper path may be dirty. Clean the inside of your machine and the drum. See page 7.4 and page 7.9.
<p>Dropouts</p> 	<p>If generally rounded faded areas, occur randomly on the page:</p> <ul style="list-style-type: none"> • A single sheet of paper may be defective. Try reprinting the job. • The moisture content of the paper is uneven or the paper has moist spots on its surface. Try a different brand of paper. See "Paper Specifications" on page 9.9. • The paper lot is bad. The manufacturing process can cause some areas to reject toner. Try a different kind or brand of paper. • The toner cartridge may be defective. Vertical repetitive defects on the next page. • If these steps do not correct the problems, contact a service representative.
<p>Vertical lines</p> 	<p>If black vertical streaks appear on the page:</p> <ul style="list-style-type: none"> • The drum inside the toner cartridge has probably been scratched. Remove the toner cartridge and install a new one. See "Replacing the Toner Cartridge" on page 7.8.
<p>Gray background</p> 	<p>If the amount of background shading becomes unacceptable:</p> <ul style="list-style-type: none"> • Change to a lighter weight pages. See "Paper Specifications" on page 9.9. • Check the machine's environment; very dry (low humidity) or high humidity (higher than 80 % RH) conditions can increase the amount of background shading. • Remove the old toner cartridge and install a new one. See "Replacing the Toner Cartridge" on page 7.8.
<p>Toner smear</p> 	<ul style="list-style-type: none"> • Clean the inside of the machine. See page 7.4. • Check the paper type and quality. See "Paper Specifications" on page 9.9. • Remove the toner cartridge and install a new one. See "Replacing the Toner Cartridge" on page 7.8.

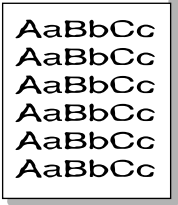
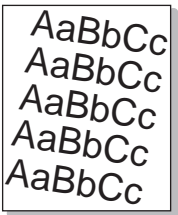
Condition	Suggested solutions
<p>Vertical repetitive defects</p> 	<p>If marks repeatedly appear on the printed side of the page at even intervals:</p> <ul style="list-style-type: none"> • The toner cartridge may be damaged. If a repetitive mark occurs on the page, print a cleaning sheet several times to clean the cartridge; see "Cleaning the Drum" on page 7.9. After the printout, if you still have the same problems, remove the toner cartridge and install a new one. See "Replacing the Toner Cartridge" on page 7.8. • Parts of the machine may have toner on them. If the defects occur on the back of the page, the problem will likely correct itself after a few more pages. • The fusing assembly may be damaged. Contact a service representative.
<p>Background scatter</p> 	<p>Background scatter results from bits of toner distributed on the printed page.</p> <ul style="list-style-type: none"> • The paper may be too damp. Try printing with a different batch of paper. Do not open packages of paper until necessary so that the paper does not absorb too much moisture. • If background scatter occurs on an envelope, change the printing layout to avoid printing over areas that have overlapping seams on the reverse side. Printing on seams can cause problems. • If background scatter covers the entire surface area of a printed page, adjust the print resolution through your software application or the printer properties.
<p>Misformed characters</p> 	<ul style="list-style-type: none"> • If characters are improperly formed and producing hollow images, the paper stock may be too slick. Try a different paper. See "Paper Specifications" on page 9.9. • If characters are improperly formed and producing a wavy effect, the scanner unit may need service. For service, contact a service representative.
<p>Page skew</p> 	<ul style="list-style-type: none"> • Ensure that the paper is loaded properly. • Check the paper type and quality. See "Paper Specifications" on page 9.9. • Ensure that the paper or other material is loaded correctly and the guides are not too tight or too loose against the paper stack.

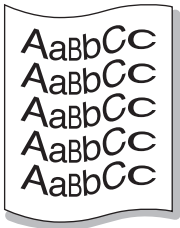
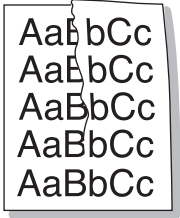
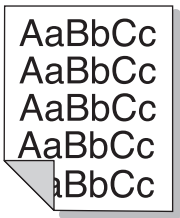
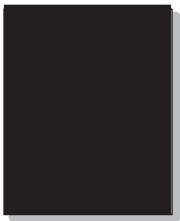
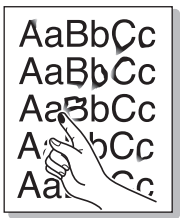
Condition	Suggested solutions
<p>Curl or wave</p> 	<ul style="list-style-type: none"> • Ensure that the paper is loaded properly. • Check the paper type and quality. Both high temperature and humidity can cause paper curl. See "Paper Specifications" on page 9.9. • Turn the stack of paper over in the paper tray. Also try rotating the paper 180° in the tray. • Try printing to the rear output slot.
<p>Wrinkles or creases</p> 	<ul style="list-style-type: none"> • Ensure that the paper is loaded properly. • Check the paper type and quality. See "Paper Specifications" on page 9.9. • Turn the stack of paper over in the paper tray. Also try rotating the paper 180° in the tray. • Try printing to the rear output slot.
<p>Back of printouts are dirty</p> 	<p>Check for leaking toner. Clean the inside of the machine. See page 7.4.</p>
<p>Black pages</p> 	<ul style="list-style-type: none"> • The toner cartridge may not be installed properly. Remove the cartridge and reinsert. • The toner cartridge may be defective and need replacing. Remove the toner cartridge and install a new one. See "Replacing the Toner Cartridge" on page 7.8. • The machine may require repair. Contact a service representative.
<p>Loose toner</p> 	<ul style="list-style-type: none"> • Clean the inside of the machine. See page 7.4. • Check the paper type and quality. See "Paper Specifications" on page 9.9. • Remove the toner cartridge and install a new one. See "Replacing the Toner Cartridge" on page 7.8. • If the problem persists, the machine may require repair. Contact a service representative.

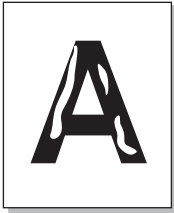
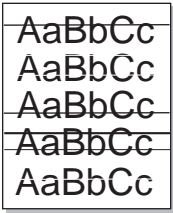
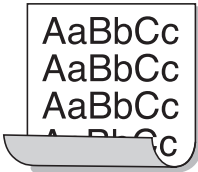
Condition	Suggested solutions
<p>Character Voids</p> 	<p>Character voids are white areas within the parts of characters that should be solid black:</p> <ul style="list-style-type: none"> • If you are using transparencies, try another type of transparency. Due to the composition of the transparency, some character voids are normal. • You may be printing on the wrong surface on the paper. Remove the paper and turn it around. • The paper may not meet paper specifications. See "Paper Specifications" on page 9.9.
<p>Horizontal stripes</p> 	<p>If horizontally aligned black streaks or smears appear:</p> <ul style="list-style-type: none"> • The toner cartridge may be installed improperly. Remove and reinsert the cartridge. • The toner cartridge may be defective. Remove the toner cartridge and install a new one. See "Replacing the Toner Cartridge" on page 7.8. • If the problem persists, the machine may require repair. Contact a service representative.
<p>Curl</p> 	<p>If the printed paper is curl or paper does not feed into the printer:</p> <ul style="list-style-type: none"> • Turn the stack of paper over in the paper tray. Also try rotating the paper 180° in the paper tray. • Try printing to the rear output slot.

Copying Problems

Condition	Suggested solutions
Copies are too light or too dark.	Use the Darknen button to darken or lighten the background of the copies.
Smears, lines, marks or spots appears on copies.	<ul style="list-style-type: none"> • If defects are on the original document, press the Darknen button to lighten the background of your copies. • If no defects are on the original document, clean the Scan unit. See page 7.5.
Copy image is skewed.	<ul style="list-style-type: none"> • Ensure that the original document is positioned correctly in the ADF (Automatic Document Feeder). • Check that the copy paper is loaded correctly.
Blank copies print out.	Ensure that the original document is face down in the ADF.
Image rubs off the copy easily.	<ul style="list-style-type: none"> • Replace the paper in the paper tray with paper from a new package. • In high humidity areas, do not leave paper in the machine for the extended periods of time.
Frequent copy paper jams occurs.	<ul style="list-style-type: none"> • Fan the stack of paper, then turn it over in the paper tray. Replace the paper in the tray with a fresh supply. Check/adjust the paper guides, if necessary. • Ensure that the paper is the proper paper weight. 75g/m² (20 lb) bond paper is recommended. • Check for copy paper or pieces of copy paper remaining in the machine after a paper jam has been cleared.
Fewer copies from the toner cartridge than expected prints out.	<ul style="list-style-type: none"> • Your original documents may contain pictures, solids or heavy lines. For example, they may be forms, newsletters, books or other documents that use more toner. • The machine may be frequently turned on and off.

Scanning Problems

Condition	Suggested solutions
<p>The scanner does not work.</p>	<ul style="list-style-type: none"> • Make sure that you place the document to be scanned face down in the ADF. • There may not be enough available memory to hold the document you want to scan. Try the Prescan function to see if that works. Try lowering the scan resolution rate. • Check that the USB or parallel cable is connected properly. • Make sure that the USB or parallel cable is not defective. Switch the cable with a known good cable. If necessary, replace the cable. • If you are using a parallel cable, ensure that it is compliant with the IEEE 1284 standard. • Check that the scanner is configured correctly or the application you want to use to make certain that the scanner job is being sent to the correct port, for example, LPT1.
<p>The unit scans very slowly.</p>	<ul style="list-style-type: none"> • Check if the machine is printing received data. Scan the document after the current job is completed. • Graphics are scanned more slowly than text. • Communication speed becomes slow in scan mode because of the large amount of memory required to analyze and reproduce the scanned image. Set your computer to the ECP printer mode through BIOS setting. It will help to increase the speed. For details about how to set BIOS, refer to your computer operating instructions.
<p>Message appears on your computer screen:</p> <ul style="list-style-type: none"> • "Device can't be set to the H/W mode you want." • "Port is being used by another program." • "Port is Disabled." • "Scanner is busy receiving or printing data. When the current job is completed, try again." • "Invalid handle." • "Scanning has failed." 	<ul style="list-style-type: none"> • There may be a copying or printing job in progress. When the current job is complete, try the job again. • The selected port is currently being used. Restart your computer and try again. • The printer cable may be improperly connected or the power may be off. You must use a USB 2.0 compliant cable or a parallel cable that supports IEEE 1284 bi-directional communications. • The scanner driver is not installed or an operating environment is not set up properly. • Ensure that port is properly connected and power is on, and then restart your computer. • Do not use the parallel and the USB cables at the same time.

Faxing Problems

Condition	Suggested solutions
The machine is not working, there is no display and the buttons are not working.	<ul style="list-style-type: none"> • Unplug the power cord and plug it in again. • Ensure that there is power to the electrical receptacle.
No dial tone sounds.	<ul style="list-style-type: none"> • Check that the phone line is connected properly. • Check that the phone socket in the wall is working by plugging in another phone.
The numbers stored in the memory do not dial correctly.	Make sure that the numbers are stored in the memory correctly. Print a Phone Book list, referring to page 4.21.
The Phone bookdocument does not feed into the machine.	<ul style="list-style-type: none"> • Make sure that the document is not wrinkled and you are putting it in correctly. Check that the document is the right size, not too thick or thin. • Make sure that the control panel is firmly closed.
Faxes are not received automatically.	<ul style="list-style-type: none"> • Fax mode should be selected. • Make sure that there is paper in the tray. • Check to see if the display shows "Memory Full."
The machine does not send.	<ul style="list-style-type: none"> • Make sure that the document is loaded in the ADF. • "TX" should show up on the display. • Check the other fax machine you are sending to, to see if it can receive your fax.
The incoming fax has blank spaces or is received with a poor-quality.	<ul style="list-style-type: none"> • The fax machine sending you the fax may be faulty. • A noisy phone line can cause line errors. • Check your machine by making a copy. • The toner cartridge may be empty. Replace the toner cartridge, referring to page 7.8.
Some of the words on an incoming fax are stretched.	The fax machine sending you the fax had a temporary document jam.
There are lines on the documents you send.	Check your scanning glass for marks and clean it. See page 7.5.
The machine dials a number, but a connection with another fax machine fails.	The other fax machine may be turned off, out of paper or cannot answer incoming calls. Speak with the other machine operator and ask her/him to clear out the problem.

Condition	Suggested solutions
Documents do not store in memory.	There may not be enough memory space to store the document. If the display shows a "Memory Full" message, delete any documents you no longer need from the memory and then restore the document.
Blank areas appear at the bottom of each page or on other pages, with a small strip of text at the top.	You may have chosen the wrong paper settings in the user option setting. See page 1.32 for Tray 1, page 9.4 for the optional Tray 2 and page 2.10 for the manual feeder.





APPENDIX

This chapter includes:

- **Installing an Optional Tray**
- **Specifications**
- **Scanner Specifications**
- **Printer Specifications**
- **Facsimile Specifications**
- **Paper Specifications**

Installing an Optional Tray

You can increase the paper handling capacity of your machine by installing an optional Tray 2. This tray holds 250 sheets of paper.

- 1 Turn the machine off and unplug all cables from the machine.
- 2 Remove the packing material from the tray and remove the tape fixing the interface cable to the tray.

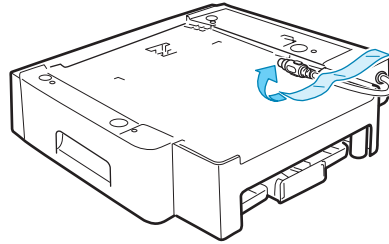

- 3 Find the location of the optional tray positioners.

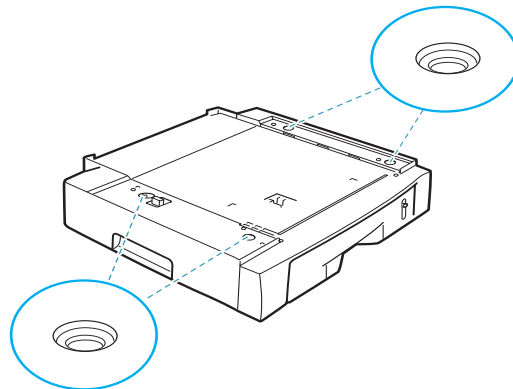

- 4 Place the machine over the tray, aligning the feet on the machine with the positioners of the tray.

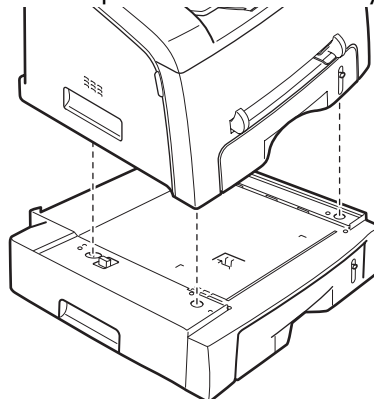

- 5 Plug the interface cable of the tray into the Tray 2 cable connector on the back of the machine.

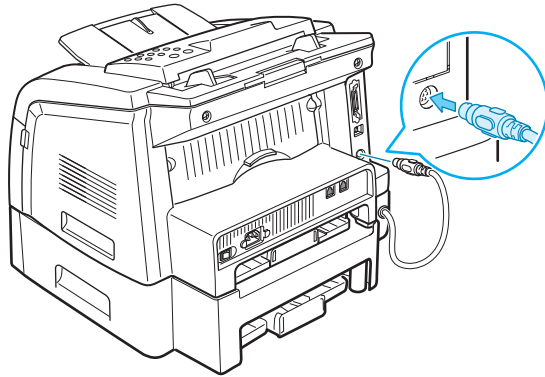

- 6 Load paper in the optional Tray 2. The instructions for loading paper in this tray is the same as you would when loading the standard paper tray. See page 1.11.
- 7 Reconnect the power cord and cables and then turn the machine on.

Setting Tray 2 in the Printer's Properties

If you installed Tray 2 with your machine on, the machine does not recognize it. In this case, you need to set the tray in the printer's Properties window so that you can use it for PC-printing.

- 1 Click the Windows Start menu.
- 2 For Windows 95/98/Me/NT4.0/2000, select **Settings** and then **Printers**.
For Windows XP, select **Printers and Faxes**.
- 3 Select the **Printer Driver Type 2200** printer.
- 4 Click the right mouse button on the printer icon and select **Properties**.
- 5 Click the **Printer** tab, select **Tray 2** from the Optional Tray drop down list and click **OK**.

Setting the Paper Type and Size for Tray 2

After installing the optional Tray 2 and loading paper in the tray, you need to set the paper type and size using the control panel buttons. These settings will apply to Fax and Copy modes. For PC-printing, you need to select the paper type and size in the application program you use.

1 Press **Menu**.

The display shows "Paper Setting" on the top line and the first menu item, "Paper Type," on the bottom line.

2 Press **Enter** to access the menu item.

3 Use the scroll button (◀ or ▶) to find the paper type you are using and press **Enter** to save it.

4 Press the ▶ button to scroll to "Paper Size" and press **Enter** to access the menu item.

5 Press the scroll button (◀ or ▶) until "Tray 2 Size" appears on the bottom line.

6 Use the scroll button (◀ or ▶) to find the paper size you are using and press **Enter** to save it.

To return to Standby mode, press **Stop/Clear**.

Specifications

General Specifications

Item	Description
Automatic document feeder (ADF)	Up to 50 sheets (weight: 75 g/m ² , 20 lb)
ADF Document size	Width: 142 to 216 mm (5.6 to 8.5 inches) Length: 148 to 356 mm (5.8 to 14 inches)
Paper input capacity	Paper tray: 250 sheets (weight: 75 g/m ² , 20 lb) Manual feeder: 1 sheet (weight: 60~163 g/m ² , 16~43 lb) Optional Paper tray: 250 sheets (weight: 75 g/m ² , 20 lb)
Paper output capacity	Front output tray: 150 sheets (face down) Rear output slot: 1 sheet (face up)
Paper type	Paper tray: Plain paper (60 ~ 90 g/m ² , 16 ~ 24 lb) Manual feeder: Plain paper, Transparencies, Labels, Thick, Thin, Bond, Preprinted, Colored.
	Card stock, Envelopes (60 ~ 163 g/m ² , 16 ~ 43 lb)
Consumables	1-piece toner cartridge system
Power requirements	100 ~ 127 VAC, 50/60 Hz, 4.5 A 220 ~ 240 VAC, 50/60 Hz, 2.5 A
Power consumption	Sleep mode: 15W(100 ~ 127 VAC) / 15W(220 ~ 240 VAC) Standby mode: 75 W(100 ~ 127 VAC) / 75 W(220 ~ 240 VAC) Average: 320 W
Noise	Warm-up: 52 dB Standby mode: 39 dB Scanning: 52 dB Printing: 52 dB
Warm-up Time	35 seconds
Operating conditions	Temperature: 50 °F to 89 °F (10 °C to 32 °C) Humidity: 20 % to 80 % RH
LCD	16 characters x 2 lines
SET dimension (W x D x H)	Main: 388 x 417 x 335 mm Optional Paper Tray(Tray2): 386 x 392 x 90 mm

Item	Description
Weight	Net: 11 Kg (including toner cartridge, excluding package) Optional Paper Tray(Tray2): 2.5 Kg
Package weight	Paper: 2.7 Kg Plastic: 0.7 Kg

Scanner Specifications

Item	Description
Compatibility	TWAIN standard
Scan method	Color CIS
Scan resolution	600 X 300 dpi (optical)/4800 X 4800 (maximum)
Scan length	Maximum: 15.7 inches (400 mm)
Scan width	Maximum: 8.5 inches (216 mm) Effective: 8.2 inches (208 mm)
Bit depth	1 bit for B/W mode 8 bit for Gray mode 24 bit for Color mode

Copier Specifications

Item	Description
Scan method	Color CIS
Scan length	Maximum: 15.7 inches (400 mm)
Scan width	Maximum 8.5 inches (216 mm) Effective 8.2 inches (208 mm)
Copy speed (SDMC)*1	Letter: 17 copies per minute A4: 16 copies per minute
Copy speed (MDMC)*2	Letter: 8 copies per minute A4: 7 copies per minute
Copy resolution	600 x 300 dpi (optical)/ 600 X 600 (printing)
Zoom rate	50 ~ 200 %

Item	Description
Multiple copies	99 pages
Bit depth	1 bit for Text mode 8 bit for Gray mode
Halftone	256 levels

*1 Single Document Multi Copy

*2 Multi Document Multi Copy

Printer Specifications

Item	Description
Print method	Laser Beam Printing
Print speed	Letter: 17 pages per minute A4: 16 pages per minute
Paper size	Paper tray: Letter, A4, Legal, Folio, A5, A6 Manual feeder: Letter, Legal, A4, Folio, Executive, A5, A6, A6 card, Post Card 4x6, Hagaki, Envelope 7-3/4, Envelope 9, Envelope 10, Envelope DL, Envelope C5, Envelope C6, Envelope B5 * Min.: 76 x 127 mm (3 x 5 in.) Max.: 216 x 356 (8.5 x 14 in.)
Print resolution	600 x 600 dpi
Emulation	SPL (GDI)
PC Interface	IEEE 1284 (ECP Only), USB 2.0
Compatibility	Windows 95/98/2000/NT 4.0/Me/XP
First printing time	Standby mode: 12 seconds Power save mode: 42 seconds
Memory	16 MB

Facsimile Specifications

Item	Description
Compatibility	ITU-T Group 3
Applicable line	Public Switched Telephone Network (PSTN) or behind PABX
Data coding	MH/MR/MMR (ECM Mode)/JBIG
Modem speed	33600/31200/28800/26400/24000/21600/19200/16800/14400/12000/9600/7200/4800/2400 bps with fall back
Transmission speed	Approx. 3 seconds/page * Transmission time applies to memory transmission of text data with ECM compression using only ITU-T No.1 Chart.
Scan speed	Approx. 1.5 seconds/LTR (at standard fax resolution mode)
Paper Type	Planin paper(60~90 g/m ² , 16~24lb)
Paper size	Letter, A4, Legal, Folio, Executive, B5
Resolution	Standard: 203 x 98 dpi Fine: 203 x 196 dpi Super Fine: 300 x 300 dpi Photo: 203 x 196 dpi
User Memory	5 MB
Halftone	256 levels
Auto dialer	One-touch dialing (up to 40 numbers) Speed dialing (up to 150 numbers)

Paper Specifications

Overview

Your machine accepts a variety of print materials, such as cut-sheet paper, including up to 100 % recycled fiber content paper, envelopes, labels, transparencies and custom-size paper. Properties, such as weight, composition, grain and moisture content, are important factors affecting the machine's performance and the output quality. Paper that does not meet the guidelines outlined in this operating instructions can cause the following problems:

- Poor print quality
- Increased paper jams
- Premature wear on the machine.

NOTES:

- Some paper may meet all of the guidelines in this guide and still not produce satisfactory results. This may be the result of improper handling, unacceptable temperature and humidity levels or other variables over which the manufacturer has no control.
 - Before purchasing large quantities of paper, insure the paper meets the requirements specified in this operating instructions.
-

CAUTION: Using paper that does not meet these specifications may cause problems, requiring repairs. These repairs are not covered by the manufacturer's warranty or service agreements. Supported Sizes of Paper

Size (mm/in.)	Weight	Capacity
Plain paper Letter (215.9 x 279/8.5 x 11) A4 (210 x 297/8.27 x 11.69) Folio (215.9 x 330.2/8.5 x 13) Legal (215.9 x 355.6/8.5 x 14) Executive (184.2 x 266.7/7.25 x 10.5) B5(182 x 257/7.2 x 10) A5 (148 x 210/5.83 x 8.27) A6 (105 x 148/4.13 x 5.88)	<ul style="list-style-type: none"> • 60 to 90 g/m² bond (16 to 24 lb) for the paper tray (Tray 1/2) • 60 to 163 g/m² bond (16 to 43 lb) for the manual feeder 	<ul style="list-style-type: none"> • 250 sheets of 75 g/m² bond (20 lb) paper for the paper tray (Tray 1/2) • 1 sheet of paper for the manual feeder
Envelopes No.9 (98.4 x 225.4/3.88 x 8.88) No.10 (104.8 x 241.3/4.13 x 9.5) DL (110 x 220/4.33 x 8.66) C5 (162 x 229/6.38 x 9.02) C6 (114 x 162/4.49 x 6.38) B5 (176 x 250/6.93 x 9.84) No.7 3/4 (98.4 x 190.5/3.88 x 7.5)	75 to 90 g/m ²	1 sheet of paper for the manual feeder

Size (mm/in.)	Weight	Capacity
Labels Letter (215.9 x 279/8.5 x 11) A4 (210 x 297/8.27 x 11.69)	120 to 150 g/m ²	1 sheet of paper for the manual feeder
Transparency films Letter (215.9 x 279/8.5 x 11) A4 (210 x 297/8.27 x 11.69)	138 to 146 g/m ²	
Card stocks A6 card (105 x 148/4.13 x 5.88) Post Card (101.6 x 152.4/4 x 6) Hagaki (100 x 148/3.94 x 5.83)	90 to 163 g/m ²	
Minimum size (custom)	60 to 120 g/m ² bond (16 to 32 lb)	
Maximum size (Legal)		

NOTES:

- You may experience jams when using print materials with a length of less than 127 mm (5 in.). For optimum performance, ensure that you are storing and handling the paper correctly. Please refer to "Paper Storage Environment" on page .12.
- Capacity may vary depending on print materials' weight and thickness, and environmental conditions.

Guidelines for Using Paper

For best results, use conventional 75 g/m² (20 lb) paper. Ensure that the paper is of good quality, and free of cuts, nicks, tears, spots, loose particles, dust, wrinkles, voids, and curled or bent edges.

If you are unsure of what type of paper you are loading, such as bond or recycled paper, check the label on the package.

The following problems may cause print quality deviations, jamming or even damage to the machine:

Symptom	Problem with Paper	Solution
Poor print quality or toner adhesion, problems with feeding	Too moist, too rough, too smooth or embossed; faulty paper lot	Try another kind of paper, between 100 ~ 400 Sheffield, 4 ~ 5 % moisture content.
Dropout, jamming, curl	Stored improperly	Store paper flat in its moisture-proof wrapping.
Increased gray background shading/machine wear	Too heavy	Use lighter paper, use the rear output slot.

Symptom	Problem with Paper	Solution
Excessive curl problems with feeding	Too moist, wrong grain direction or short-grain construction	<ul style="list-style-type: none"> • Use the rear output slot. • Use long-grain paper.
Jamming, damage to machine	Cutouts or perforations	Do not use paper with cutouts or perforations.
Problems with feeding	Ragged edges	Use good quality paper.

NOTES:

- Do not use letterhead paper printed with low-temperature inks, such as those used in certain types of thermography.
- Do not use raised or embossed letterhead.
- The machine uses heat and pressure to fuse toner to the paper. Insure that any colored paper or preprinted forms use inks that are compatible with this fusing temperature (200 °C or 392 °F for 0.1 second).

Paper Specifications

Category	Specifications
Acid Content	5.5 pH or lower
Caliper	0.094 ~ 0.18 mm (3.0 ~ 7.0 mils)
Curl in Ream	Flat within 5 mm (0.02 in.)
Cut Edge Conditions	Cut with sharp blades with no visible fray.
Fusing Compatibility	Must not scorch, melt, offset or release hazardous emissions when heated to 200 °C (392 °F) for 0.1 second.
Grain	Long Grain
Moisture Content	4 % ~ 6 % by weight
Smoothness	100 ~ 400 Sheffield

Paper Output Capacity

Output Location	Capacity
Face-down output tray	150 sheets of 75 g/m ² bond (20 lb) paper
Face-up output slot	1 sheet of 75 g/m ² bond (20 lb) paper

Paper Storage Environment

Paper storage environmental conditions directly affect the feed operation.

Ideally, the machine and paper storage environment should be at or near room temperature, and not too dry or humid. Remember that paper is hygroscopic; it absorbs and loses moisture rapidly.

Heat works with humidity to damage paper. Heat causes the moisture in paper to evaporate, while cold causes it to condense on the sheets. Heating systems and air conditioners remove most of the humidity from a room. As paper is opened and used, it loses moisture, causing streaks and smudging. Humid weather or water coolers can cause the humidity to increase in a room. As paper is opened and used it absorbs any excess moisture, causing light print and dropouts. Also, as paper loses and gains moisture it can become distorted. This can cause paper jams.

Care should be taken not to purchase more paper than can be used in a short time (about 3 months). Paper stored for long periods may experience heat and moisture extremes, which can cause damage. Planning is important to prevent damage to large supplies of paper.

Unopened paper in sealed reams can remain stable for several months before use. Opened packages of paper have more potential for damage, especially if they are not wrapped with a moisture-proof barrier.

The paper storage environment should be properly maintained to ensure optimum performance. The required condition is 20 to 24 °C (68 to 75 °F), with a relative humidity of 45 % to 55 %. The following guidelines should be considered when evaluating the paper's storage environment:

- Paper should be stored at or near room temperature.
- The air should not be too dry or too humid.
- The best way to store an opened ream of paper is to rewrap it tightly in its moisture-proof wrapping. If the machine environment is subject to extremes, unwrap only the amount of paper to be used during the day's operation to prevent unwanted moisture changes.

Envelopes

Envelope construction is critical. Envelope fold lines can vary considerably, not only between manufacturers, but also within a box from the same manufacturer. Successful printing on envelopes depends upon the quality of the envelopes. When selecting envelopes, consider the following components:

- **Weight:** The weight of the envelope paper should not exceed 90g/m² (24lb) or jamming may occur.
- **Construction:** Prior to printing, envelopes should lie flat with less than 6mm (0.25in.) curl, and should not contain air.
- **Condition:** Envelopes should not be wrinkled, nicked or otherwise damaged.
- **Temperature:** You should use envelopes that are compatible with the heat and pressure of the machine.
- **Size:** You should only use envelopes within the following size ranges

NOTES:

- Use only the manual feeder to print envelopes.
 - You may experience some paper jams when using any media with a length less than 140 mm (5.5 in.). This may be caused by paper that has been affected by environmental conditions. For optimum performance, make sure you are storing and handling the paper correctly. Please refer to "Paper Storage Environment" on page .12.
-

Envelopes with Double Side Seams

Double side-seams construction has vertical seams at both ends of the envelope rather than diagonal seams. This style may be more likely to wrinkle. Be sure the seam extends all the way to the corner of the envelope as illustrated below.

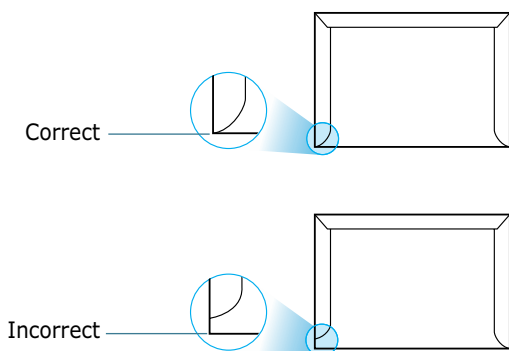

Envelopes with Adhesive Strips or Flaps

Envelopes with a peel-off adhesive strip or with more than one flap that folds over to seal must use adhesives compatible with the heat and pressure in the machine. The extra flaps and strips might cause wrinkling, creasing or even jams and may even damage the fuser.

Envelope Margins

The following gives typical address margins for a commercial #10 or DL envelope.

Type of Address	Minimum	Maximum
Return address	15 mm (0.6 in.)	51 mm (2 in.)
Delivery address	51 mm (2 in.)	90 mm (3.5 in.)

NOTES:

- For the best print quality, position margins no closer than 15 mm (0.6 in.) from the edges of the envelope.
 - Avoid printing over the area where the envelope's seams meet.
-

Envelope Storage

Proper storage of envelopes helps contribute to print quality. Envelopes should be stored flat. If air is trapped in an envelope, creating an air bubble, then the envelope may wrinkle during printing.

Labels

CAUTION:

- To avoid damaging the machine, use only labels recommended for laser printers.
 - To prevent serious jams, always use the manual feeder to print labels and always use the rear output tray.
 - Never print on the same sheet of labels more than once and never print on a partial sheet of labels.
-

When selecting labels, consider the quality of each component:

- Adhesives: The adhesive material should be stable at 180°C (356°F), the machine's fusing temperature.
- Arrangement: Only use labels with no exposed backing between them. Labels can peel off sheets with spaces between the labels, causing serious jams.
- Curl: Prior to printing, labels must lie flat with no more than 13mm (5in.) of curl in any direction.
- Condition: Do not use labels with wrinkles, bubbles or other indications of separation.

Transparencies

Transparencies used in the machine must be able to withstand 180°C (356°F), the machine's fusing temperature.

CAUTION: To avoid damaging the machine, use only transparencies recommended for use in laser printers.



INDEX

A

- adding documents 4.27
- ADF (Automatic Document Feeder),
 - load 3.3
- ADF rubber pad, replace 7.11
- automatic dialing
 - group 4.18
 - one-touch 4.15
 - speed 4.16
- automatic redialing 4.9

B

- broadcasting faxes 4.22

C

- canceling
 - fax 4.8
 - print 5.5
 - scheduled faxes 4.28
- characters, enter 1.29
- cleaning
 - drum 7.9
 - inside 7.4
 - outside 7.3
 - scan unit 7.5
- connection
 - AC power 1.18
 - parallel 1.17
 - telephone line cord 1.15
- control panel 1.6
- copying 3.3
 - default setting, change 3.7
 - image 3.5
 - number of pages 3.5
 - time out, set 3.8

D

- date and time, set 1.31
- delay receive polling 4.26
- delayed fax 4.23
- display language, change 1.27

- document
 - jam, clear 8.2
 - loading 1.11
 - preparing 3.2
- drum, clean 7.9

E

- error messages 8.8

F

- Favorite setting, use 5.6
- fax system, set
 - advanced settings 4.33
 - basic settings 4.2
- fitting to page, print 5.14
- front output tray, use 2.5

G

- graphic properties, set 5.9
- group dial
 - dialing 4.20
 - editing 4.19
 - setting 4.18

H

- help, use 5.6

I

- installing
 - optional tray 9.2
 - toner cartridge 1.9

J

- jam, clear
 - document 8.2
 - paper 8.3

M

- machine ID, set 1.28

memory, clear 7.2

N

network printer, set 5.23

notifying toner low 7.9

O

one-touch dial

dialing 4.16

storing 4.15

optional tray, install 9.2

orientation, print 5.3

output location, select 2.4

overlay, use 5.19

P

paper guidelines 2.3

paper jam, clear 8.3

paper level indicator 2.7

paper load

in manual feeder 2.8

in paper tray 1.11

paper load capacity 2.2

paper properties, set 5.7

paper size, set

manual feeder 2.10

paper tray 1.32

print 5.7

paper source, set 5.8

paper type 2.2

paper type, set

manual feeder 2.10

paper tray 1.32

print 5.8

paper, load 4.11

parallel, connect 1.17

polling 4.26

poster, print 5.15

print order, set 5.4

print resolution 5.9

printer properties

windows 5.2

printing

fitting to a selected paper size 5.14

from Windows 5.2

multiple pages on one sheet 5.11

Phone Book list 4.21

posters 5.15

reduced or enlarged document

5.13

reports 4.31

using overlays 5.19

watermarks 5.16

priority fax 4.25

problems, solve

copying 8.19

error messages 8.8

faxing 8.21

paper feeding 8.11

printing 8.12

printing quality 8.14

scanning 8.20

R

rear output slot, use 2.5

receiving a fax

in Ans/Fax mode 4.12

in Fax mode 4.11

in Secure Receiving mode 4.29

in Tel mode 4.12

in the memory 4.14

redialing

automatically 4.8

manually 4.9

reduced/enlarged

copy 3.6

print 5.13

Remote Control Panel 4.36

reports, print 4.31

resolution

fax 4.6

print 5.9

S

- Safety information i.ii
- scanning
 - Windows 6.2
- searching Phone Book 4.20
- Secure Receiving mode 4.29
- sending a fax
 - automatically 4.7
 - manually 4.8
- sharing printer, set 5.23
- sounds, set 1.33
- specifications
 - copier 9.6
 - facsimile 9.8
 - general 9.5
 - paper 9.9
 - printer 9.7
 - scanner 9.6
- speed dial
 - dialing 4.17
 - storing 4.16
- system requirements
 - Windows 1.21

T

- tel line, connect 1.15
- toner cartridge
 - install 1.9
 - redistribute 7.7
 - replace 7.8
- TWAIN, scan 6.2
- Type 2200 Driver, install Windows 1.19

U

- uninstalling
 - Remote Control Panel 1.26
- USB
 - connect 1.17
 - mode, change 8.14

V

- volume, adjust
 - ringer 1.33
 - speaker 1.33

W

- watermarks, use 5.16



H916-8650

Quick Guide

Safety Information	ii
Safety During Operation	ii
Positions of Labels and Hallmarks for WARNING and CAUTION Labels	iv
Control Panel Functions	1
Changing the Display Language	3
Setting the Date and Time	3
Printing a Report	4
Using Advanced Fax Settings	5
Changing Setting Options	5
Loading a Document	5
Sending a Fax Automatically	6
Confirming Transmission	7
Automatic Redialing	7
Redialing the Last Number	7

For safe and correct use of this machine, please be sure to read the Safety Information in this Guide before you use it.

Safety Information

When using this machine, the following safety precautions should always be followed.

Safety During Operation

In this manual, the following important symbols are used:

⚠ WARNING:

Indicates a potentially hazardous situation which, if instructions are not followed, could result in death or serious injury.

⚠ CAUTION:

Indicates a potentially hazardous situation which, if instructions are not followed, may result in minor or moderate injury or damage to property.

⚠ WARNING:

- **Connect the power cord directly into a wall outlet and never use an extension cord.**
- **Disconnect the power plug (by pulling the plug, not the cable) if the power cable or plug becomes frayed or otherwise damaged.**
- **To avoid hazardous electric shock or laser radiation exposure, do not remove any covers or screws other than those specified in this manual.**
- **Turn off the power and disconnect the power plug (by pulling the plug, not the cable) if any of the following occurs:**
 - **You spill something into the machine.**
 - **You suspect that your machine needs service or repair.**
 - **The external housing of your machine has been damaged.**
- **Do not incinerate spilled toner or used toner. Toner dust might ignite when exposed to an open flame.**
- **Disposal can take place at our authorized dealer.**
- **Dispose of the used toner bottle in accordance with the local regulations.**
- **Keep the machine away from flammable liquids, gases, and aerosols. A fire or an electric shock might occur.**

⚠ CAUTION:

- *Protect the machine from dampness or wet weather, such as rain and snow.*
- *Unplug the power cord from the wall outlet before you move the machine. While moving the machine, you should take care that the power cord will not be damaged under the machine.*
- *When you disconnect the power plug from the wall outlet, always pull the plug (not the cable).*
- *Do not allow paper clips, staples, or other small metallic objects to fall inside the machine.*
- *Keep toner (used or unused) and toner bottle out of the reach of children.*
- *Be careful not to cut yourself on any sharp edges when you reach inside the product to remove misfed sheets of paper or masters.*
- *For environmental reasons, do not dispose of the machine or expended supply waste at household waste collection points. Disposal can take place at an authorized dealer.*
- *The inside of the machine could be very hot. Do not touch the parts with a label indicating the "hot surface". Otherwise, an injury might occur.*

Power Supply

The socket-outlet shall be installed near the product and shall be easily accessible.

Ozone Safety

This product generates ozone during operation. Normally, the ozone level is safe for operators. If ozone odor may appear, ventilate the room.

For Fax or Telephone

Do not use this product near water, for example, near a bathtub, wash bowl, kitchen sink or laundry tub, in a wet basement or near a swimming pool. Avoid using a telephone during an electrical storm. There may be a remote risk of electric shock from lightning. Do not use a telephone in the vicinity of a gas leak to report the leak.

Laser Safety:

This equipment is considered a class 1 laser device. This equipment contains a 5 milliwatt, 760-800 nanometer wavelength, AlGaAs laser diode. The following marking is attached on the back of the equipment.

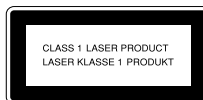
**Caution:**

Use of controls or adjustment or performance of procedures other than those specified in this Operating Instructions might result in hazardous radiation exposure.



Declaration of Conformity

Notice to Users in EEA Countries

This product complies with the essential requirements and provisions of Directive 1999/5/EC of the European Parliament and of the Council of 9 March 1999 on radio equipment and telecommunications terminal equipment and the mutual recognition of their conformity.

Notice to Users Accessing Analog PSTN in EEA Countries



This product is designed to be able to access analog PSTN in all EEA countries. Local PSTN compatibility is dependent on software switch settings. Please contact your service representative if relocating this product to another country. In the event of problems, please contact your service representative in the first instance.

FAX2210L/LF215m : The CE declaration of Comformity is available on the Internet at URL :
http://www.ricoh.co.jp/fax/ce_doc

IF3050 : The CE Declaration of Conformity is available by accessing the URL:
<http://jboard.danka.de/jboard/produkte/index.html> and selecting the product applicable.

Positions of Labels and Hallmarks for

WARNING and **CAUTION** Labels

This machine has labels for  **WARNING** and  **CAUTION** at the positions shown below. For safety, please follow the instructions and handle the machine as indicated.

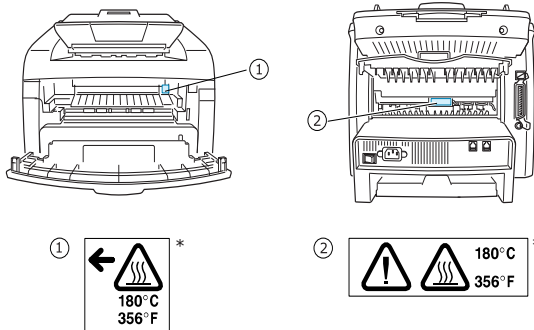







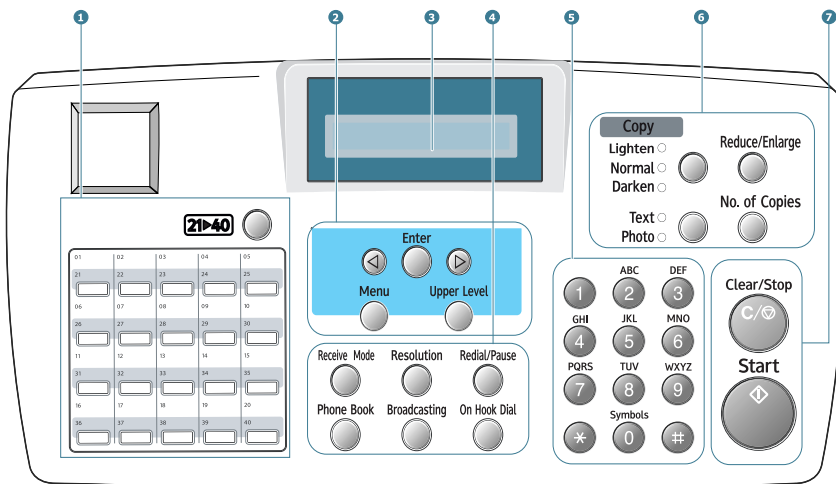

*This label is stuck to hot surfaces. Be careful not to touch these areas.













In accordance with IEC 60417, this machine uses the following symbols for the main power switch:

- | means **POWER ON.**
- means **POWER OFF.**

Control Panel Functions



1		Use to store frequently-dialed fax number and dial them with a touch of the buttons.
		Allows you to shift the one-touch buttons to the numbers 21 through 40.
2		Scrolls through the options available for the selected menu item.
	Enter 	Confirms the selection on the display.
	Menu 	Enters Menu mode and scrolls through the menus available.
	Upper Level 	Returns you to the upper menu level.
3		Displays the current status and prompts during an operation.

4 F A X		Allows you to select the fax receiving mode.
		<ul style="list-style-type: none"> Allows you to store frequently-dialed fax numbers using a one or two-digit speed dial or group number for automatic dialing and edit the stored numbers. Allows you to print a Phone book list.
		Adjusts the resolution of the documents for the current fax job.
		Allows you to send a fax to multiple destinations.
		Engages the telephone line.
		Redials the last number in Standby mode or inserts a pause into a fax number in Edit mode.
5		Dials a number or enters alphanumeric characters.
6 C O P Y		Adjusts the brightness of the documents for the current copy job. *1This button is called "Darkness" in this manual.
		Selects the document type for the current copy job. *2This button is called "Original Type" in this manual.
		Makes a copy smaller or larger than the original document.
		Selects the number of copies.
7		Stops an operation at any time. In Standby mode, clears/stop the copy options, such as the darkness, the document type setting, the copy size and the number of copies.
		Starts a job.

Changing the Display Language

To change the language that displays on the display of the control panel, follow these steps:

- 1 Press **Menu** until "Machine Setup" appears on the top line of the display.
- 2 Press the scroll button (◀ or ▶) until "Language" appears on the bottom line of the display.
- 3 Press **Enter**. The current setting appears on the bottom line of the display.
- 4 Press the scroll button (◀ or ▶) until the language you want appears on the display.
- 5 Press **Enter** to save the selection.
- 6 To return to Standby Mode, press **Clear/Stop**.

Setting the Date and Time

The current date and time are shown on the display when your machine is on and ready to work. All of your faxes will have the date and time printed on them.



NOTE: If power to the machine is cut off, you need to reset the correct time and date once the power is restored.

- 1 Press **Menu** until "Machine Setup" appears on the top line of the display.
- 2 Press the scroll button (◀ or ▶) to display "Date & Time" on the bottom line and press **Enter**.
- 3 Enter the correct time and date using the number keypad.

Month	= 01 ~ 12
Day	= 01 ~ 31
Year	= requires all four digits
Hour	= 01 ~ 12 (12-hour mode) 00 ~ 23 (24-hour mode)
Minute	= 00 ~ 59



NOTE: The date format may differ from each country.

You can also use the scroll button (◀ or ▶) to move the cursor under the digit you want to correct and enter a new number.

- 4 To select "AM" or "PM" for 12-hour format, press the * or # button or any number button.

When the cursor is not under the AM or PM indicator, pressing the * or # button immediately moves the cursor to the indicator.

You can change the clock mode to 24-hour format (e.g. 01:00 PM as 13:00).

- 5 Press **Enter** when the time and date on the display is correct.

When you enter a wrong number, the machine beeps and does not proceed to the next step. If this happens, just reenter the correct number.

Printing a Report

- 1 Press **Menu** until "Reports" appears on the top line of the display. The first available menu item, "Phone Book" displays on the bottom line.
- 2 Press the scroll button (◀ or ▶) to display the report or list you want to print on the bottom line.
- 3 Press **Enter**.

The selected information prints out.

Using Advanced Fax Settings

Your machine has various user-selectable setting options for sending or receiving faxes. These options are preset at the factory, but you may need to change them. To find out how the options are currently set, print the System Data list. For details about printing the list, see Operating Instruction.

Changing Setting Options

- 1 Press **Menu** until "Advanced Fax" appears on the top line of the display. The first available menu item, "Send Forward," displays on the bottom line.
- 2 Press the scroll button (◀ or ▶) until you see the desired menu item on the bottom line and press **Enter**.
- 3 When the option you want appears on the display, choose a status by pressing the scroll button (◀ or ▶) or enter a value using the number keypad.
- 4 Press **Enter** to save the selection.
- 5 You can exit from Setup mode at any time by pressing **Clear/Stop**.

Loading a Document

- 1 Pull the document input support all the way out. Fold out the extender, if necessary.

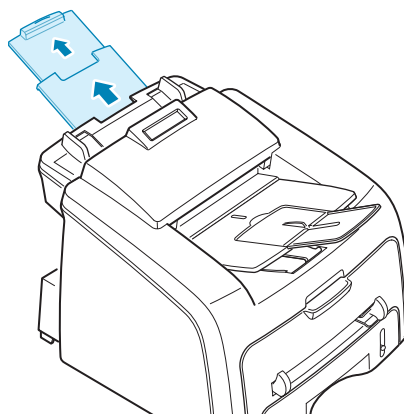

- 2 Load the documents up to 50 pages **face down** into the ADF and adjust the document guides to the document size.

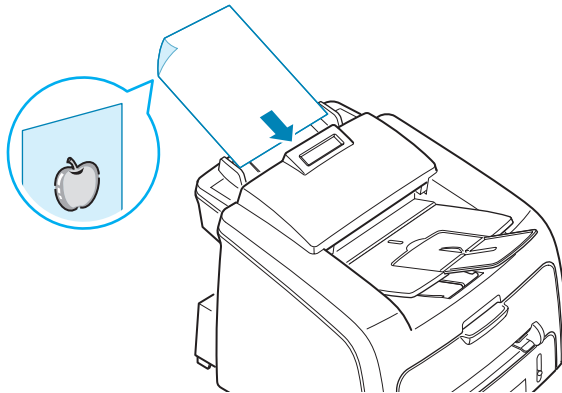

For detailed guidelines for preparing an original document.

- 3 Adjust the document resolution, referring to Operating Instruction.

Sending a Fax Automatically

- 1 Load the document(s) face down into the ADF.

For details about loading a document, see page 5.

- 2 Adjust the document resolution to suit your fax needs. See Operating Instruction.

If you need to change the darkness, see Operating Instruction.

- 3 Enter the remote fax phone number using the number keypad.

You can use the one-touch keypad or speed or group dial numbers. For details about storing a number, see Operating Instruction.

- 4 Press **Start**.

The number is dialed and then the machine begins sending the fax when the remote fax machine is ready.



NOTE: When you want to cancel the fax job, press **Clear/Stop** at any time while sending the fax.

Confirming Transmission

When the last page of your document has been sent successfully, the machine beeps and returns to Standby Mode.

When something goes wrong while sending your fax, an error message appears on the display. For a listing of error messages and their meanings, see Operating Instruction.

If you receive an error message, press **Clear/Stop** to clear the message and try to send the document again.

You can set your machine to print a confirmation report automatically each time sending a fax is completed. For further details, see the MSG Confirm item Operating Instruction.

Automatic Redialing

When the number you have dialed is busy or there is no answer when you send a fax, the machine automatically redials the number every three minutes up to seven times by the factory default settings.

When the display shows "Retry Redial ?," press **Enter** to redial the number without waiting. To cancel the automatic redialing, press **Clear/Stop**.

To change the time interval between redials and the number of redial attempts. See Operating Instruction.

Redialing the Last Number

To redial the last number you dialed:

Press **Redial/Pause**.

If a document is loaded in the ADF, the machine automatically begins to send.

Reference:

See Operating Instruction for installing printer and scanner software.

Memo



Free Manuals Download Website

<http://myh66.com>

<http://usermanuals.us>

<http://www.somanuals.com>

<http://www.4manuals.cc>

<http://www.manual-lib.com>

<http://www.404manual.com>

<http://www.luxmanual.com>

<http://aubethermostatmanual.com>

Golf course search by state

<http://golfingnear.com>

Email search by domain

<http://emailbydomain.com>

Auto manuals search

<http://auto.somanuals.com>

TV manuals search

<http://tv.somanuals.com>