



Operating Instructions Facsimile Reference <Basic Features>

c1-fax-350.tif



-
- 1 Getting Started
 - 2 Faxing
 - 3 Using Internet Fax Functions
 - 4 Programming
 - 5 Troubleshooting

For safe and correct use of this machine, please be sure to read the Safety Information in the Copy Reference before you use it.

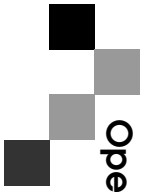

Operating Instructions Facsimile Reference <Basic Features>



Introduction

This manual describes detailed instructions on the operation and notes about the use of this machine. To get maximum versatility from this machine all operators are requested to read this manual carefully and follow the instructions. Please keep this manual in a handy place near the machine.

Notes

Some illustrations in this manual might be slightly different from the machine.

Certain options might not be available in some countries. For details, please contact your local dealer.

Two kinds of size notation are employed in this manual. With this machine refer to the inch version.

Important

Contents of this manual are subject to change without prior notice. In no event will the company be liable for direct, indirect, special, incidental, or consequential damages as a result of handling or operating the machine.

Trademarks

Microsoft® and Outlook® are either registered trademarks or trademarks of Microsoft Corporation in the United States and/or other countries.

Adobe®, PostScript® and Acrobat® are registered trademarks of Adobe Systems Incorporated.

Other product names used herein are for identification purposes only and might be trademarks of their respective companies. We disclaim any and all rights to those marks.

USA (This information is for facsimile users only.)

❖ **FCC Requirements**

1. This equipment complies with Part 68 of the FCC rules and requirements adopted by the ACTA. On the cover of this equipment is a label that contains, among other information, a product identifier in the format US:AAAEQ##TXXXXX. If requested, this number must be provided to the telephone company.
2. This equipment uses the RJ11C USOC jack.
3. A plug and jack used to connect this equipment to the premises wiring and telephone network must comply with the applicable FCC Part 68 rules and requirements adopted by the ACTA. A compliant telephone cord and modular plug is provided with this product. It is designed to be connected to a compatible modular jack that is also compliant. See installation instructions for detail.
4. The REN is used to determine the number of devices that may be connected to a telephone line. Excessive RENs on a telephone line may result in the devices not ringing in response to an incoming call. In most but not all areas, the sum of RENs should not exceed five (5.0). To be certain of the number of devices that may be connected to a line, as determined by the total RENs, contact the local telephone company. The REN for this product is part of the product identifier that has the format US:AAAEQ##TXXXXX. The digits represented by ## are the REN without a decimal point (e.g., 03 is a REN of 0.3).
5. If this equipment causes harm to the telephone network, the telephone company will notify you in advance that temporary discontinuance of service may be required. But if advance notice is not practical, the telephone company will notify the customer as soon as possible. Also, you will be advised of your right to file a complaint with the FCC if you believe it is necessary.
6. The telephone company may make changes in its facilities, equipment, operations or procedures that could affect the operation of the equipment. If this happens the telephone company will provide advance notice in order for you to make necessary modifications to maintain uninterrupted service.
7. If trouble is experienced with this equipment, for repair or warranty information, please contact RICOH CORP. CUSTOMER SUPPORT DEPT. at 1-800-FASTFIX. If the equipment is causing harm to the telephone network, the telephone company may request that you disconnect the equipment until the problem is resolved.
8. In the event of operation problems (document jam, copy jam, communication error indication), refer to the solving problems section in this manual.
9. Connection to party line service is subject to state tariffs. Contact the state public utility commission, public service commission or corporation commission for information.

❖ **WHEN PROGRAMMING EMERGENCY NUMBERS AND/OR MAKING TEST CALLS TO EMERGENCY NUMBERS:**

1. Remain on the line and briefly explain to the dispatcher the reason for the call before hanging up.
2. Perform such activities in the off-peak hours, such as early morning hours or late evenings.

CANADA

The Ringer Equivalence Number is an indication of the maximum number of devices allowed to be connected to a telephone interface. The termination on an interface may consist of any combination of devices subject only to the requirement that the sum of the RENs of all the devices does not exceed five.

This product meets the applicable Industry Canada technical specifications.

Manuals for This Machine

The following manuals describe the operational procedures of this machine. For particular functions, see the relevant parts of the manual.

Note

- Manuals provided are specific to machine type.
- Adobe Acrobat Reader is necessary to view the manuals as a PDF file.
- Three CD-ROMs are provided:
 - CD-ROM 1“Operating Instructions for Printer/Scanner”
 - CD-ROM 2“Scanner Driver & Document Management Utilities”

❖ **General Settings Guide**

Provides an overview of the machine and describes System Settings (paper trays, Key Operator Tools, etc.) and troubleshooting.
Refer to this manual for Address Book procedures such as registering fax numbers, e-mail addresses, and user codes.

❖ **Network Guide (PDF file - CD-ROM1)**

Describes procedures for configuring the machine and computers in a network environment.

❖ **Copy Reference**

Describes operations, functions, and troubleshooting for the machine’s copier function.

❖ **Facsimile Reference <Basic Features> (this manual)**

Describes operations, functions, and troubleshooting for the machine’s facsimile function.

❖ **Facsimile Reference <Advanced Features>**

Describes advanced functions and settings for key operators.

❖ **Printer Reference 1**

Describes system settings and operations for the machine’s printer function.

❖ **Printer Reference 2 (PDF file - CD-ROM1)**

Describes operations, functions, and troubleshooting for the machine’s printer function.

❖ **Scanner Reference (PDF file - CD-ROM1)**

Describes operations, functions, and troubleshooting for the machine’s scanner function.

❖ **Manuals for DeskTopBinder V2 Lite**

DeskTopBinder V2 Lite is a utility included on the CD-ROM labeled “Scanner Driver & Document Management Utilities”.

- DeskTopBinder V2 Lite Setup Guide (PDF file - CD-ROM2)
Describes installation of, and the operating environment for DeskTopBinder V2 Lite in detail. This guide can be displayed from the **[Setup]** dialog box when DeskTopBinder V2 Lite is installed.
- DeskTopBinder V2 Introduction Guide (PDF file - CD-ROM2)
Describes operations of DeskTopBinder V2 Lite and provides an overview of its functions. This guide is added to the **[Start]** menu when DeskTopBinder V2 Lite is installed.
- Auto Document Link Guide (PDF file - CD-ROM2)
Describes operations and functions of Auto Document Link installed with DeskTopBinder V2 Lite. This guide is added to the **[Start]** menu when DeskTopBinder V2 Lite is installed.

❖ **Manuals for ScanRouter V2 Lite**

ScanRouter V2 Lite is a utility included on the CD-ROM labeled “Scanner Driver & Document Management Utilities”.

- ScanRouter V2 Lite Setup Guide (PDF file - CD-ROM2)
Describes installation of, settings, and the operating environment for ScanRouter V2 Lite in detail. This guide can be displayed from the **[Setup]** dialog box when ScanRouter V2 Lite is installed.
- ScanRouter V2 Lite Management Guide (PDF file - CD-ROM2)
Describes delivery server management and operations, and provides an overview of ScanRouter V2 Lite functions. This guide is added to the **[Start]** menu when ScanRouter V2 Lite is installed.

❖ **Other manuals**

- PostScript3 Supplement (PDF file - CD-ROM1)
- UNIX Supplement (Available from an authorized dealer, or as a PDF file on our Web site.)

TABLE OF CONTENTS

Manuals for This Machine	i
NOTICE	1
Important Safety Instructions	3
Caution	3
How to Read This Manual	4
Symbols	4

1. Getting Started

Control Panel	5
Reading the Display	7
Reading the display and using keys	7
Standby display	8
Communication display	9
User code entry display	10

2. Faxing

Transmission Modes	11
Switching between Memory Transmission and Immediate Transmission.....	12
Placing Originals	13
Placing a Single Original on the Exposure Glass.....	14
Placing Originals in the ADF	14
Originals unsuitable for the ADF.....	15
Memory Transmission	16
Canceling a Memory Transmission	19
Before the Original Is Scanned	19
While the Original Is Being Scanned.....	19
While the Original Is Being Transmitted or Before the Transmission Is Started	19
Immediate Transmission	21
Canceling an Immediate Transmission	24
Before You Have Pressed [Start] Key	24
After You Have Pressed [Start] Key	24
Scan Settings	25
Resolution	25
Original Type.....	26
Image Density (Contrast)	27
Mixing Scan Settings for a Multiple Page Original	27
When placing originals on the exposure glass	27
When placing originals in the ADF	28
Specifying a Destination	29
Entering a Fax Number	29
Pause	30
Tone	30
Entering an E-mail Address	31
Using the Destination List	31
Specifying a destination using the Quick Dial key	32
Specifying a group of destinations using the Quick Dial key	32
Checking the Specified Destination	33

Searching for a Destination	34
Search by Destination Name	34
Selecting from Destination List.....	35
Specifying a Registration Number.....	36
Search by Fax Number	37
Search by E-mail Address.....	38
Reception.....	40
Switching the Reception Mode.....	40
Receiving a Fax in Manual Reception Mode.....	41

3. Using Internet Fax Functions

Internet Fax Functions	43
Internet Fax Precautions	44
Functions Not Supported by E-mail Transmission	44
Functions Not Supported by E-mail Reception	44
T.37 Full Mode	45
Transmitting Internet Fax.....	47
Confirming Reception.....	52
Canceling Internet Fax Transmission	53
Before the Original Is Scanned	53
While the Original Is Being Scanned.....	53
Receiving Internet Fax.....	54
Auto E-mail Reception	54
Manual E-mail Reception	54
Received Images	56

4. Programming

Initial Settings and Adjustments	57
Programming.....	58
Editing	59
Deleting.....	60
Programming Fax Numbers and E-mail addresses.....	62

5. Troubleshooting

Adjusting the Volume	63
When [Facsimile] Key Is Lit in Red	65
When Toner Runs Out.....	66
Error Messages and Their Meanings	67
Solving Problems.....	70
When Things Don't Go as Expected	72
INDEX.....	73

NOTICE

Note to users in the United States of America



 **Notice:**

This equipment has been tested and found to comply with the limits for a Class B digital device, pursuant to Part 15 of the FCC Rules. These limits are designed to provide reasonable protection against harmful interference in a residential installation. This equipment generates, uses and can radiate radio frequency energy and, if not installed and used in accordance with the instructions, may cause harmful interference to radio communications. However, there is no guarantee that interference will not occur in a particular installation. If this equipment does cause harmful interference to radio or television reception, which can be determined by turning the equipment off and on, the user is encouraged to try to correct the interference by one more of the following measures:

- Reorient or relocate the receiving antenna.
- Increase the separation between the equipment and receiver.
- Connect the equipment into an outlet on a circuit different from that to which the receiver is connected.
- Consult the dealer or an experienced radio /TV technician for help.

 **Warning**

Changes or modifications not expressly approved by the party responsible for compliance could void the user's authority to operate the equipment.





Notice about the Telephone Consumer Protection Act (Valid in USA only).

The Telephone Consumer Protection Act of 1991 makes it unlawful for any person to use a computer or other electronic device, including FAX machines, to send any message unless such message clearly contains in a margin at the top or bottom of each transmitted page or on the first page of the transmission, the date and time it is sent and an identification of the business or other entity, or other individual sending the message and the telephone number of the sending machine or such business, other entity, or individual. (The telephone number provided may not be a 900 number or any other number for which charges exceed local or long-distance transmission charges.)

In order to program this information into your FAX machine, you should complete the following steps: Follow the FAX HEADER programming procedure in the Programming chapter of the operating instructions to enter the business identification and telephone number of the terminal or business. This information is transmitted with your document by the FAX HEADER feature. In addition to the information, be sure to program the date and time into your machine.

Note to users in Canada



Note:

This Class B digital apparatus complies with Canadian ICES-003.

Remarque concernant les utilisateurs au Canada



Avertissement:

Cet appareil numérique de la classe B est conforme à la norme NMB-003 du Canada.

Important Safety Instructions

Caution

When using your telephone equipment, basic safety precautions should always be followed to reduce the risk of fire, electric shock and injury to persons, including the following:

- Do not use this product near water, for example, near a bathtub, wash bowl, kitchen sink or laundry tub, in a wet basement or near a swimming pool.
- Avoid using a telephone during an electrical storm. There may be a remote risk of electric shock from lightning.
- Do not use a telephone in the vicinity of a gas leak to report the leak.
- Use only the power cord and batteries indicated in this manual. Do not dispose of batteries in a fire. They may explode. Check with local codes for possible special disposal instructions.

Save these instructions.

IMPORTANTES MESURES DE SÉCURITÉ

Certaines mesures de sécurité doivent être prises pendant l'utilisation de matériel téléphonique afin de réduire les risques d'incendie, de choc électrique et de blessures. En voici quelquesunes:

- Ne pas utiliser l'appareil près de l'eau, p.ex., près d'une baignoire, d'un lavabo, d'un évier de cuisine, d'un bac à laver, dans un sous-sol humide ou près d'une piscine.
- Éviter d'utiliser le téléphone (sauf s'il s'agit d'un appareil sans fil) pendant un orage électrique. Ceci peut présenter un risque de choc électrique causé par la foudre.
- Ne pas utiliser l'appareil téléphonique pour signaler une fuite de gaz s'il est situé près de la fuite.
- Utiliser seulement le cordon d'alimentation et le type de piles indiqués dans ce manual. Ne pas jeter les piles dans le feu: elles peuvent exploser. Se conformer aux ègrlements pertinents quant à l'élimination des piles.

Conserver ces instructions.

How to Read This Manual

Symbols

In this manual, the following symbols are used:

 **WARNING:**

This symbol indicates a potentially hazardous situation that might result in death or serious injury when you misuse the machine without following the instructions under this symbol. Be sure to read the instructions, all of which are included in "Safety Information", *Copy Reference*.

 **CAUTION:**

This symbol indicates a potentially hazardous situation that might result in minor or moderate injury or property damage that does not involve personal injury when you misuse the machine without following the instructions under this symbol. Be sure to read the instructions, all of which are included in "Safety Information", *Copy Reference*.

* The statements above are notes for your safety.

 **Important**

If this instruction is not followed, paper might be misfed, originals might be damaged, or data might be lost. Be sure to read this.

 **Preparation**

This symbol indicates information or preparations required prior to operating.

 **Note**

This symbol indicates precautions for operation, or actions to take after abnormal operation.

 **Limitation**

This symbol indicates numerical limits, functions that cannot be used together, or conditions under which a particular function cannot be used.

 **Reference**

This symbol indicates a reference.

[]

Keys that appear on the machine's display panel.

[]

Keys and buttons that appear on the computer's display.

[]

Keys built into the machine's control panel.

1. Getting Started

Control Panel

The illustration shows the control panel when options are installed.

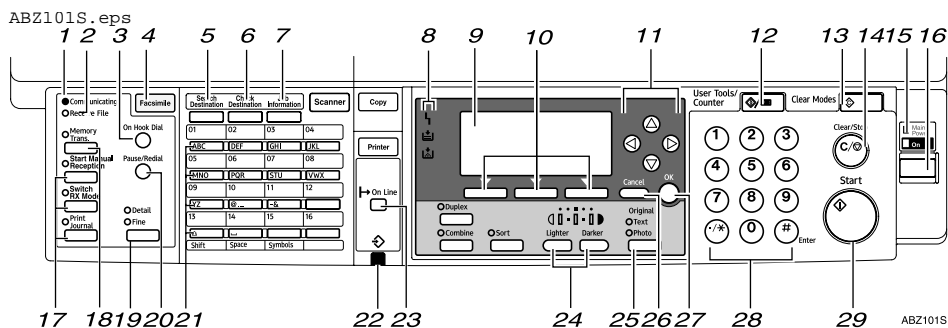

1. Communicating indicator

Lights during transmission or reception.

2. Receive File indicator

Lights to tell you a message has been received into memory. Blinks when a Memory Lock file has been received. See p.75 "Memory Lock", *Facsimile Reference <Advanced Features>*.

3. [On Hook Dial] key

Use to dial a number while hearing tone.

4. [Facsimile] key

Press to switch to Facsimile mode.

5. [Search Destination] key

Press to search for destination from the destination list.

6. [Check Destination] key

Press to check destinations which are currently selected.

7. [Job Information] key

Press to check the status of sending faxes or e-mail.

8. Indicators

Display errors and the machine status.

⚡: Error indicator. See *Network Guide* and *General Settings Guide*.

📄: Load Paper indicator. See *Copy Reference*.

⚡: Add Toner indicator. See *Copy Reference*.

🔍 Reference

For more information, see *General Settings Guide*.

9. Display

Display the operation status and messages.

10. Selection keys

These keys correspond to the items on the display. Press the corresponding key to select the item.

11. Scroll keys

Use to select an item.

▲ key: Press to scroll upward

▼ key: Press to scroll downward

▶ key: Press to scroll right

◀ key: Press to scroll left

12. [User Tools/Counter] key

Use to change default or operation parameters according to the operating conditions.

13. [Clear Modes] key

Press to clear the current setting.

14. [Clear/Stop] key

Clear: Clears an entered numeric value.
Stop: Stops scanning or other operations.

15. Main power indicator and On indicator

The main power indicator lights up when the main power switch is set to on. The On indicator lights up when the machine is on.

16. Operation switch

Press to turn the machine on. The On indicator lights up. To turn the machine off, press this switch again.

Note

- This key is inactivate while scanning or setting Facsimile Features.

17. User Function keys

Each of these can be programmed for rapid access to frequently used features.

❖ Features Programmed by Default

Key	Function
F1	Start Manual Reception
F2	Switch RX Mode
F3	Print Journal

18. [Memory Trans.] key

Press to toggle between Memory Transmission and Immediate Transmission modes. The indicator lights up when Memory Transmission is selected.

19. [Resolution] key

Press to switch between Standard, Detail and Fine. When the resolution type is selected, the corresponding indicator lights.

Note

- The indicators are off when the resolution is set to Standard.

20. [Pause/Redial] key

Pause:

Inserts a pause when you are dialing or storing a fax number. A pause cannot be inserted as the first digit.

Redial:

Press to redial one of the last ten destinations.

21. Quick Dial keys

Use to select the programmed destination at a single touch or to enter letters and symbols.

🔍 Reference

For more information, see *General Settings Guide*.

📝 Note

- You can program up to 16 destinations in the Quick Dial key.

22. Data In indicator/Online indicator**23. [Online] key****24. [Lighter] and [Darker] keys**

Press to change the setting of image density. Select the image density in five steps from Lighter to Darker.

25. [Original Type] key

Press to select the original type programmed with Text or Photo. When the original type is selected, the corresponding indicator lights.

26. [Cancel] key

Press to cancel an operation or return to the previous display.

27. [OK] key

Press to set a selected item or entered characters.

28. Number keys

Use to enter numeric values.

29. [Start] key

Press to begin faxing, printing reports or lists.

Reading the Display

The display shows you the machine status, messages, and guides you through operations.

Note

- ❑ This machine automatically returns to standby mode if you do not use the machine for a certain period of time. You can select the period using "Facsimile Auto Reset Timer". See "Timer Settings", *General Settings Guide*.

Reading the display and using keys

Display contents will differ depending on installed optional units.

Note

- ❑ The copy display is set as the default display when the machine is turned on. You can change the settings in the System Settings. See *General Settings Guide*.

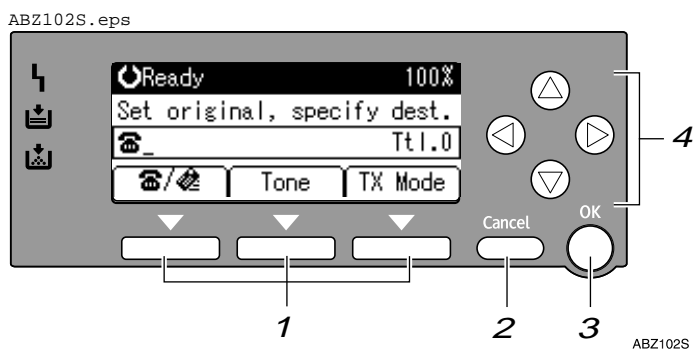

1. Selection keys

Correspond to items at the bottom line on the display.

Example: The standby display

- When the instruction "Press [Ⓜ/Ⓚ]" appears in this manual, press the left selection key.
- When the instruction "Press [Tone]" appears in this manual, press the middle selection key.
- When the instruction "Press [TX Mode]" appears in this manual, press the right selection key.

2. [Cancel] key

Press to cancel an operation or return to the previous display.

3. [OK] key

Press to set a selected item or entered numeric values.

4. Scroll keys

Press to move the cursor to each direction on by one.

When [▲], [▼], [▶] or [◀] appears in this manual, press the scroll key of the same direction.

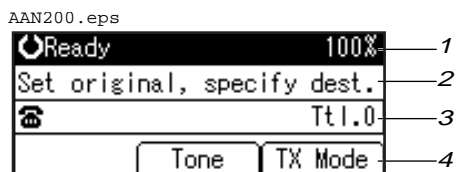

1. Machine status or currently selected function

2. Message

❖ When Internet Fax Settings is ON

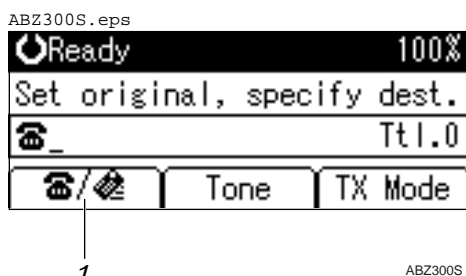

1. Switches the destination between fax number and e-mail address.

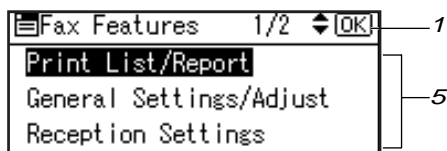

3. Destination entry

4. Selection keys

5. Selectable items

Note

- ❑ To use the Internet Fax functions, the optional printer/scanner unit is required.
- ❑ You need to set Internet Fax Settings to On in Fax Features. See p.68 "E-mail Settings", *Facsimile Reference <Advanced Features>*.

Standby display

While the machine is in standby mode (immediately after the **[Facsimile]** key is pressed or after the **[Clear Modes]** key is pressed), the following display appears.

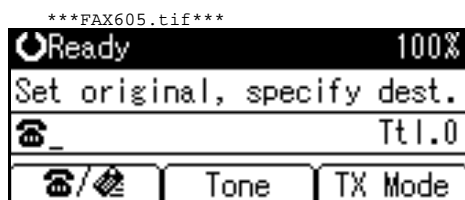

Note

- ❑ To return to standby mode, do one of the following:
 - If you have placed the original in the ADF (Auto Document Feeder) and have not pressed the **[Start]** key, remove the original.
 - If you are in User Tools mode, press the **[User Tools/Counter]** key.

Communication display

While communicating, the machine status is displayed.

❖ Memory Transmission (fax transmission)

FAX606.tif

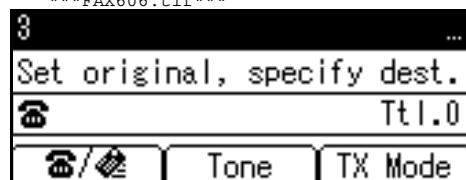

❖ Reception

FAX407.tif

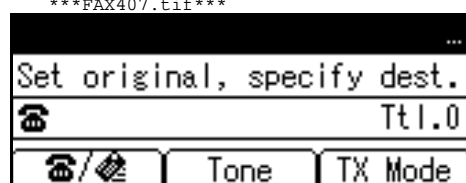

❖ Immediate Transmission

FAX607.tif

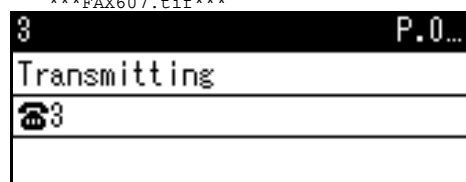

❖ TX Mode

When a function is set to on, a “clip” mark is attached to that function name.

FAX608.tif

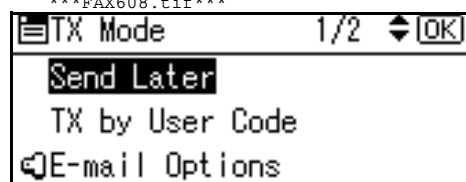

Note

- To set the transmission mode item, press **[TX Mode]**.

User code entry display

When the following message appears on the display, User Code Management is active. Enter a user code to deactivate User Code Management.

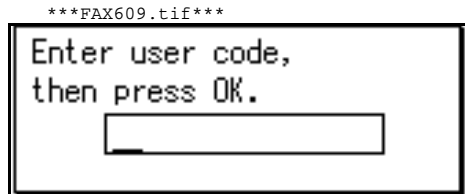

The machine can be set up so that no one can use it without entering a user code. This prevents unauthorized people from sending fax messages and helps track the activity of each user or department.

Note

- You can specify a user code with "System Settings". See "Registering a New User Code", *General Settings Guide*.
- Even when User Code Management is on, you can still receive and print fax messages as normal.

1 Enter a user code of up to eight digits using the number keys.

2 Press the [OK] or [#] key.

Note

- If an unprogrammed user code is entered, the display returns to that of step **1**.

2. Faxing

Transmission Modes

There are two types of transmission:

- Memory Transmission
- Immediate Transmission

Note

❑ You can use Parallel Memory Transmission that dials while the original is being scanned. See p.28 “Parallel Memory Transmission”, *Facsimile Reference <Advanced Features>* .

❖ Memory Transmission

Transmission starts automatically after the original has been stored in memory. It is a convenient method for when you are in a hurry and want to take the document away with you. You can also send the same original to several destinations (broadcasting).

Gfdoho2e . eps

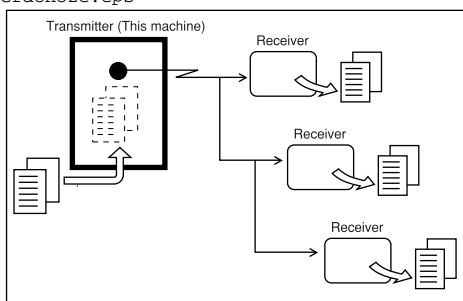

GFDOHO2E

❖ Immediate Transmission

Immediately dials the destination number, and while scanning the original, sends it. This is convenient when you want to send an original quickly, or when you want to check if original was sent to the specified destination (since Immediate Transmission is made after establishing the connection). When using this type of transmission, the original is not stored in memory, and you can only specify one destination.

GDRH240E . eps

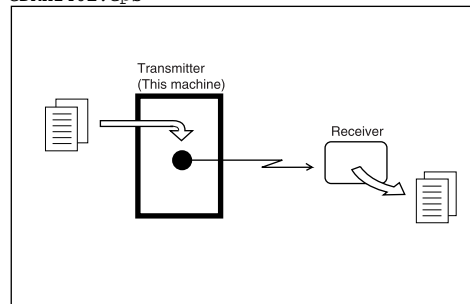

GDRH240E

Important

- ❑ If power outage lasts about an hour, or the machine is disconnected from the power outlet for about an hour, documents stored in the fax machine's memory are deleted. If any document is deleted, the Power Failure Report is automatically printed out when the main power switch is turned on. Use this report to check which documents were deleted. Simply turning off the power by pressing the Operation switch does not delete stored documents. See p.98 "Turning Off the Main Power/In Case of a Power Failure", *Facsimile Reference <Advanced Features>* .

Switching between Memory Transmission and Immediate Transmission

Check the indicators on the operation panel to check which mode is currently active and press the **[Memory Trans.]** key to toggle between them.

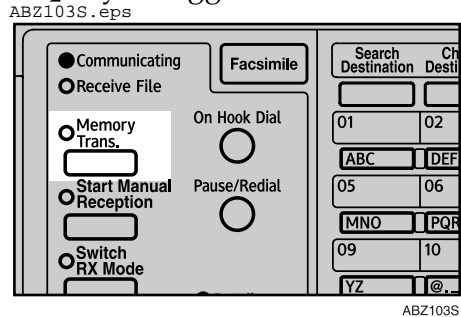

Note

- ❑ You can select the transmission mode (Memory Transmission or Immediate Transmission) that is operative when the machine is turned on or when the **[Clear Modes]** key is pressed, using **[Home Position]** under **[Key Operator Tools]**. See p.81 "Home Position", *Facsimile Reference <Advanced Features>* (switch 02, bit 2).
- ❑ You can have the machine return to the status obtained by pressing the **[Clear Modes]** key after each transmission using **[Home Position]** under **[Key Operator Tools]**. See p.81 "Home Position", *Facsimile Reference <Advanced Features>* (switch 01, bit 7).



Placing Originals

You can set your originals either in the Document Feeder or on the exposure glass. Some types of originals are unsuitable for the Document Feeder so they must be set on the exposure glass.

Which way you place your original depends on its size and whether you are using the Document Feeder or the exposure glass.

❖ How to place A4, B5 JIS (Japanese Industrial Standard), A5, 5¹/₂"×8¹/₂" and 8¹/₂"×11" size originals

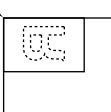
AAN055S . eps

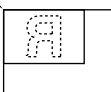
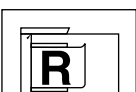
Original	Where original is placed	
	Exposure glass	For ADF
*1 		
*2 		



AAN055S

Note

- ❑ When you place originals as shown in the above illustration, the fax header will be printed on the received faxes at the destination as follows:
 - *1 On the top of the fax
 - *2 On the left side of the fax

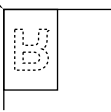
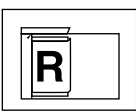

❖ How to place A5, 5¹/₂"×8¹/₂" and B5 JIS size originals

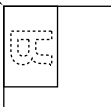
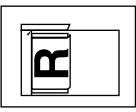
AAN056S . eps

Original	Where original is placed	
	Exposure glass	For ADF
*2 	*3 	
*1 		

AAN056S

Note

- ❑ When you place originals as shown in the above illustration, the fax header will be printed on the received faxes at the destination as follows:
 - *1 On the top of the fax
 - *2 On the left side of the fax
 - *3 When the scanning size is set to A4  or 8¹/₂"×11"  on the original size specifying display.
- ❑ When sending a fax, the image output at the other end depends on the size and orientation of paper used in the receiver's terminal. If the receiver does not use paper of the same size and orientation as that of the original, the fax image may be reduced in size, trimmed at both edges, or divided into two or more sheets. When sending an important original, we recommend you ask the receiver about the size and orientation of the paper used in their terminal.

- ❑ Make sure that all ink, correcting fluid etc., has completely dried before placing your original. If it is still wet, the exposure glass will be marked and those marks will appear on the received image.
- ❑ You can send the first pages from the exposure glass then the remaining pages from the ADF. After you have removed the last page from the exposure glass, insert the remaining pages in the ADF, and then press the **[Start]** key.

Reference

For acceptable types of originals, see p.107 "Acceptable Types of Originals", *Facsimile Reference <Advanced Features>* .

Placing a Single Original on the Exposure Glass

Place originals that cannot be placed in the ADF (Auto Document Feeder), such as a book, on the exposure glass one page at a time.

- 1** Place the original face down and align its upper left corner with the reference mark at the upper left corner of the exposure glass.

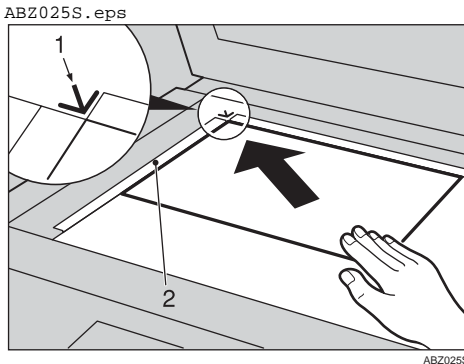

1. Positioning mark
2. Left Scale

- 2** Lower the exposure glass cover or the ADF.

Note

- ❑ When setting a bound original, the received image may contain some black areas. To reduce this effect, hold down the original to prevent the bound part from rising.

Placing Originals in the ADF

Use the ADF to scan in a stack of originals in one operation.

Limitation

- ❑ Place all the originals to be sent in a single stack. You cannot place originals in the ADF one page at a time or in successive stacks.

Note

- ❑ To send an original longer than the following lengths, use Memory Transmission. However, the maximum length of an original for Memory Transmission is 1200 mm (47").
 - A4 size: 600 mm (23.6") for Detail, 300 mm (11.8") for Fine
- ❑ If you frequently send long documents, set Long Document Transmission to on with the User Parameters. If a jam occurs, the document might be damaged because scanning will not stop. See p.76 "User Parameters", *Facsimile Reference <Advanced Features>* (switch 14, bit 1).
- ❑ If your original is bent or folded, flatten it before you place it.
- ❑ When sending thin originals, place them on the exposure glass.
- ❑ If an original jammed, press the **[Clear/Stop]** key, and then slowly remove the original.

- ❑ You can check information about the sizes and number of originals that can be placed in the ADF. See p.107 “Acceptable Types of Originals”, *Facsimile Reference <Advanced Features>* .

1 Adjust the document guide to match the size of the originals.

2 Align the edges of the originals and stack them in the ADF face up.

ABZ026S . eps

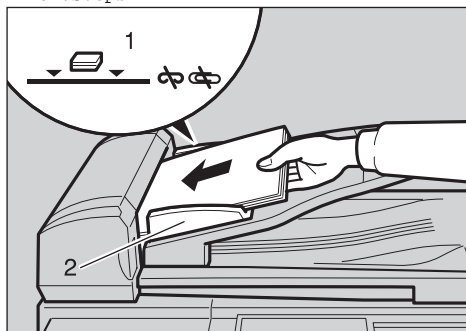

1. Limit mark

2. Document guide

Originals unsuitable for the ADF

Do not place the following types of originals in the ADF because they may be damaged. Place them on the exposure glass instead.

- Originals in unacceptable sizes (See p.107 “Acceptable Types of Originals”, *Facsimile Reference <Advanced Features>* .)
- Originals containing staples or clips
- Perforated or torn originals
- Curled, folded, or creased originals
- Pasted originals
- Originals with any kind of coating, such as thermosensitive paper, art paper, aluminum foil, carbon paper, or conductive paper
- Originals with index tabs, tags, or other projecting parts
- Sticky originals, such as translucent paper
- Thin and soft originals
- Originals of inappropriate weight (See p.107 “Acceptable Types of Originals”, *Facsimile Reference <Advanced Features>* .)
- Originals in bound form, such as books
- Transparent originals, such as OHP transparencies or translucent paper

Memory Transmission

2

In Memory Transmission mode, after you press the **[Start]** key, the machine does not dial the destination until all pages of your fax message have been scanned into memory (in contrast to Immediate Transmission, where the number is dialed first and pages are scanned and sent one by one).

Memory Transmission is useful because:

- You can take your original away from the machine without having to wait too long.
- While your message is being sent, other people can use the machine.
- You can send the same message to more than one place in a single operation (broadcasting).

Memory transmission mode has normal fax and Internet Fax functions.

Important

If there is a power failure (the main power switch is off) or the machine is unplugged out for more than one hour, all the documents stored in memory are deleted. As soon as the main power switch is turned on, the Power Failure Report is printed to help you identify deleted files. If you turn only the operation switch off, documents are not deleted. See p.98 "Turning Off the Main Power/In Case of a Power Failure", *Facsimile Reference <Advanced Features>*.

We recommend you call the receiver and confirm with them when sending important messages.

Limitation

If memory is full (0% appears on the display), Memory Transmission is disabled. Use Immediate Transmission instead.

Note

- Maximum number of destinations per Memory Transmission: 300.
- Combined total number of destinations of standby messages stored in memory: 300.
- After the total number of programmed destination numbers exceeds 300, you can perform only Immediate Transmission.
- The number of documents you can store is 200.
- The number of pages you can store in memory depends on the original images and the scan settings. You can store up to 160 standard pages (ITU-T #4 chart, Resolution: Standard, Original Type: Text).
- Allows you to specify fax number and e-mail address simultaneously.

Reference

p.47 "Transmitting Internet Fax"

Make sure the Memory Trans. indicator lights.

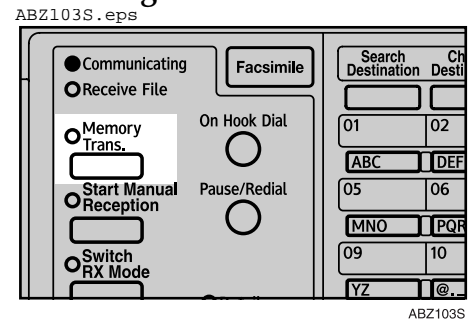

Note

If it is not, press the **[Memory Trans.]** key.

2 Place the original in the ADF, or on the exposure glass.

Note

- You can send the first few pages from the exposure glass then the remaining pages from the ADF. After you remove the last page from the exposure glass, you have 60 seconds to insert the remaining pages in the ADF.
- Note that you cannot place originals on the exposure glass after you start using the ADF.

Reference

p.13 "Placing Originals"

3 Make the settings you require.

Reference

p.25 "Scan Settings"
p.26 "Original Type"
p.27 "Image Density (Contrast)"

4 Specify a destination.

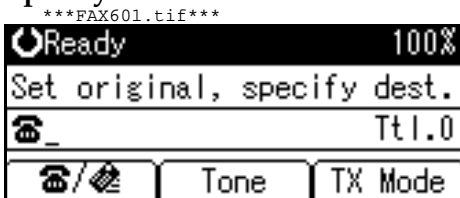

Note

- If you make a mistake, press the **[Clear/Stop]** key, and then enter the correct number.

Reference

p.29 "Entering a Fax Number"
p.31 "Entering an E-mail Address"
p.31 "Using the Destination List"
p.23 "Chain Dial", *Facsimile Reference <Advanced Features>*
p.24 "Redial", *Facsimile Reference <Advanced Features>*

5 When sending the same original to several destinations (broadcasting), press **[Add Dest]** to specify other destinations.

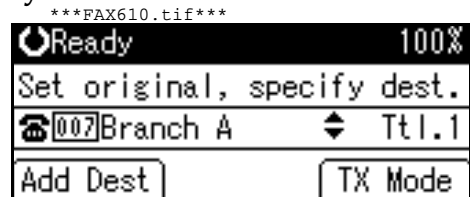

Note

- You do not have to press **[Add Dest]** when adding a destination using a Quick Dial key.
- If you do not want to do a broadcast transmission, proceed to step **7**.

6 Specify a destination.

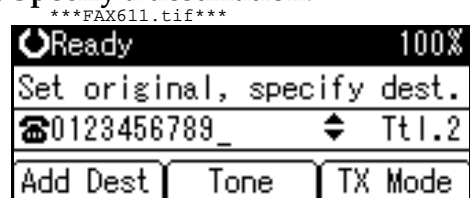

Note

- Press **[☎/📧]** to switch the destination between fax number and e-mail address.
- If you want to specify another destination, repeat steps **5** and **6**.
- Entered destinations can be checked using **[▲]** or **[▼]**.

- ❑ To delete an entered destination, find it using [▲] or [▼], press the [Clear/Stop] key, and then press [Delete].

7 Press the [Start] key.

 **Note**

- ❑ Do not lift the ADF during scanning.

After scanning, the standby display appears.

 **Sending originals using the exposure glass**

- ① Make sure the Memory Trans. indicator lights. If it is not, press the [Memory Trans.] key.
- ② Place the first page of your original face down on the exposure glass.
- ③ Specify a destination.
- ④ Make the scan settings you require.
- ⑤ Press the [Start] key.
The machine starts scanning.
- ⑥ Place the next original on the exposure glass within 60 seconds after the machine has finished scanning the first original.

FAX612.tif

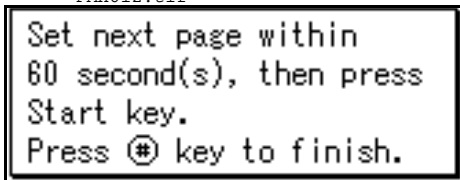

- ⑦ Repeat steps ④ to ⑥ for all originals.
- ⑧ Place the last original, press the [Start] key, and then press the [#] key.

 **Broadcasting Sequence**

If you dial several destinations for the same message (broadcasting), the messages are sent in the order in which they were dialed. If the fax message could not be transmitted, the machine redials that destination after the last destination specified for broadcasting. For example, if you specify four destinations, A through D, for broadcasting, and if the lines to destinations A and C are busy, the machine dials the destinations in the following order: A, B, C, D, A, and C.

 **Checking the Transmission Progress**

To check which destinations the fax message has been sent to so far, print the Journal. See p.19 "Printing the Journal", *Facsimile Reference <Advanced Features>*.

Canceling a Memory Transmission

Even when fax number and e-mail address are simultaneously specified, or only e-mail address is specified, you can cancel the mode using the same procedure. However, you cannot cancel the transmission of a sent Internet Fax document.

Before the Original Is Scanned

Use this procedure to cancel a transmission before pressing the **[Start]** key.

1 Press the **[Clear Modes]** key.

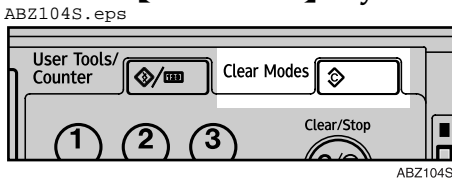

Note

- When documents are placed in the ADF, you can cancel transmission simply by removing them.

While the Original Is Being Scanned

Use this procedure to cancel a transmission after pressing the **[Start]** key.

1 Press the **[Clear/Stop]** key.

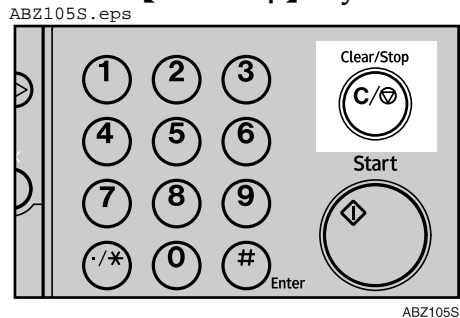

The machine stops scanning.

Note

- Scanning may be completed while you are performing the cancel operation.

While the Original Is Being Transmitted or Before the Transmission Is Started

Use this procedure to cancel a transmission after scanning finishes. While transmitting, you can cancel transmission by pressing the **[Clear/Stop]** key. After canceling, skip steps 1 and 2.

Note

- If the transmission finishes while you are carrying out this procedure, it will not be canceled.

- ❑ If you cancel a message while it is being sent, the transmission is halted as soon as you finish the cancellation procedure. However, some pages of your message may have already been sent and received at the other end.

2

1 Make sure that the standby display appears.

Note

- ❑ If you press the **[Clear/Stop]** key while the original is being scanned, scanning stops.

2 Press the **[Clear/Stop]** key.

ABZ105S.eps

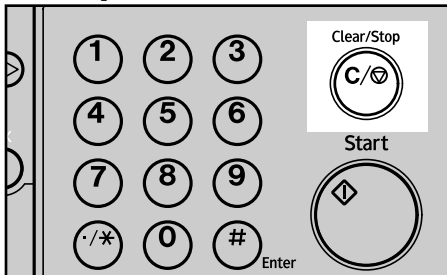

3 Press **[Stop TX]**.

FAX613.tif

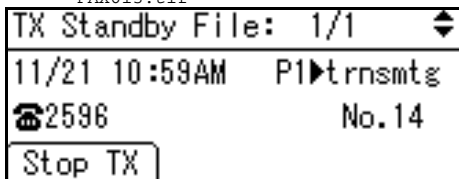

4 Press **[Delete]**.

FAX614.tif

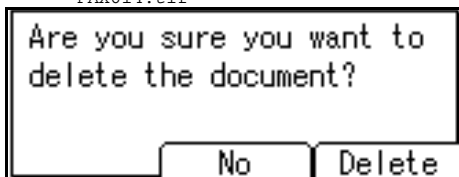

The standby display appears.

Note

- ❑ If you want to cancel stopping, press **[No]**.

Immediate Transmission

With Immediate Transmission, when you press the **[Start]** key, the fax number is dialed immediately. The message is scanned and transmitted page by page without being stored in memory. This contrasts with Memory Transmission which scans all pages into memory before dialing the destination.

Immediate Transmission is useful if you want immediate confirmation that the message is being sent to the correct destination (just check the other terminal's Own Name or Own Fax Number on the control panel during transmission).

Limitation

- ❑ Internet Fax is performed only with Memory Transmission which starts transmission automatically after storing documents in memory. If you specify Immediate Transmission in Internet Fax, the "Try again after switching to memory transmission." message appears. When this happens, press **[Exit]**, and then switch to Memory Transmission.

Note

- ❑ You cannot send the same document to multiple destinations (broadcasting). Memory Transmission allows this function.
- ❑ You can have the machine set to Memory Transmission mode or Immediate Transmission mode right after the power is turned on. See p.81 "Home Position", *Facsimile Reference <Advanced Features>*.

- ❑ You can have the machine return to the default transmission mode (Memory Transmission or Immediate Transmission) after every transmission. You can change this so that the desired setting is maintained. See p.66 "General Settings/Adjust", *Facsimile Reference <Advanced Features>*.

1 Make sure the Memory Trans. indicator is off.

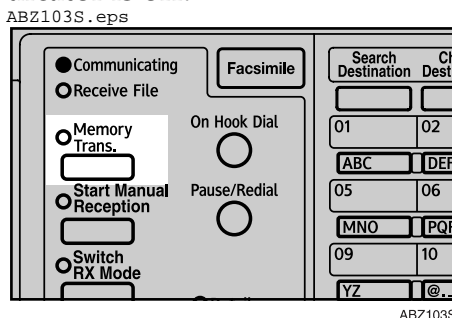

Note

- ❑ If it is not, press the **[Memory Trans.]** key.

2 Place the original.

Note

- ❑ You can scan a few pages of your original from the exposure glass and the remaining pages from the ADF. When you have finished scanning from the exposure glass, remove the original from the exposure glass and place the remaining pages in the ADF within 10 seconds.
- ❑ To send two or more pages using the exposure glass, set them one page at a time.
- ❑ The original can be placed whenever, before the **[Start]** key is pressed.

Reference

p.13 "Placing Originals".

3 Select the scan settings you require.

Reference

p.25 "Scan Settings"

p.26 "Original Type"

p.27 "Image Density (Contrast)"

4 Specify a destination.

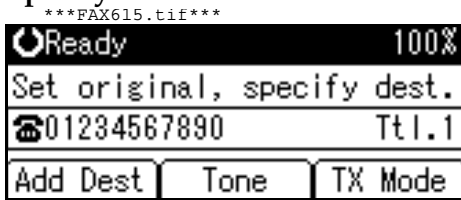

Note

- ❑ If you make a mistake, press the **[Clear/Stop]** key, and then enter the correct number.

Reference

p.29 "Specifying a Destination"

p.31 "Using the Destination List"

p.23 "Chain Dial", *Facsimile Reference* <Advanced Features>

p.24 "Redial", *Facsimile Reference* <Advanced Features>

5 Press the **[Start]** key.

The machine calls the destination. While it is dialing, the number or name which is programmed as the Own Name or Own Fax Number in the machine of the other party is shown on the display. When connected, the machine starts scanning the original.

ABZ106S.eps

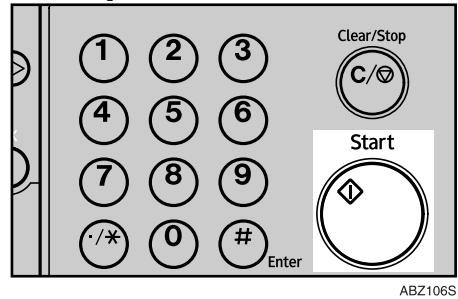

Note

- ❑ Do not lift the ADF during scanning.

After transmission, the standby display appears.

 **Sending originals using the exposure glass**

- ① Make sure the Memory Trans. indicator is off. If it is not, press the **【Memory Trans.】** key.
- ② Place the first page face down on the exposure glass.
- ③ Specify a destination.
- ④ Make the scan settings you require.
- ⑤ Press the **【Start】** key.
- ⑥ Place the next original on the exposure glass within 10 seconds after the machine has finished scanning the first original.

FAX616.tif

Set next page within
10 second(s), then press
Start key.
Press **Ⓜ** key to finish.

- ⑦ Repeat steps ④ to ⑥ for all originals.
- ⑧ Place the last original, and then press the **【#】** key.

Canceling an Immediate Transmission

Before You Have Pressed 【Start】 Key

2

1 Press the 【Clear Modes】 key.

ABZ104S.eps

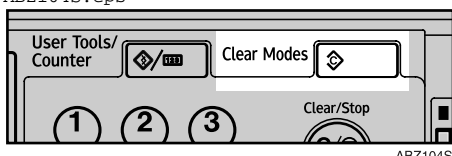

ABZ104S

Note

- When the original is placed in the ADF, you can also cancel an Immediate Transmission by removing the original.

After You Have Pressed 【Start】 Key

1 Press the 【Clear/Stop】 key, and then remove the original.

ABZ105S.eps

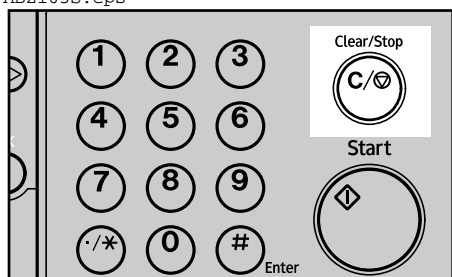

ABZ105S

Note

- If the transmission finishes while you are carrying out this procedure, it will not be canceled.

Scan Settings

You may want to send many different types of fax messages. Some of these may be difficult to reproduce at the receiver's end. However, your machine has three settings that you can adjust to help you transmit your document with the best possible image quality.

- ❖ **Resolution:**
Standard, Detail, Fine
- ❖ **Original Type:**
Text, Photo
- ❖ **Image Density (Contrast):**
Manual Image Density (five levels)

Resolution

Images and text are scanned into the machine by converting them to sequences of dots. The density of the dots determines the quality of the image and how long it takes to transmit. Therefore, images scanned at high resolution (Fine) have high quality but transmission takes longer. Conversely, low resolution (Standard) scanning results in lower quality but your original is sent more quickly. Select the setting that matches your needs based upon this trade off between speed and image clarity.

- ❖ **Standard (8 x 3.85 lines/mm, 200 x 100 dpi)**
Select for originals containing normal size characters.
- ❖ **Detail (8 x 7.7 lines/mm, 200 x 200 dpi)**
Select for originals containing small characters or when you require greater clarity. This resolution is twice as fine as Standard.

- ❖ **Fine (8 x 15.4 lines/mm, 200 x 400 dpi)**
Select for originals with fine details or when you require the best possible image clarity. This resolution is four times finer than Standard.

! Limitation

- If the other party's machine does not support the resolution at which you are sending, this machine automatically switches to a resolution that is supported. You can check the resolution at which you sent actually. See p.19 "Printing the Journal", *Facsimile Reference <Advanced Features>* .
- Transmission at Fine resolution is possible with originals of A4, 8¹/₂"x11" and smaller. Even if you select the Fine resolution for the original exceeding A4, 8¹/₂"x11", the resolution type is forcibly changed to Detail.
- In Internet Fax transmission, if the destination is not set in full mode, the original is scanned using Detail, even if you select **[Fine]**.

📝 Note

- The machine supports Standard, Detail, and Fine resolutions.
- The resolution type selected as soon as the machine is turned on or modes cleared is set to **[Standard]**.

1 Press the **[Resolution]** key to switch between resolutions. The indicators above the key shows the current selection.

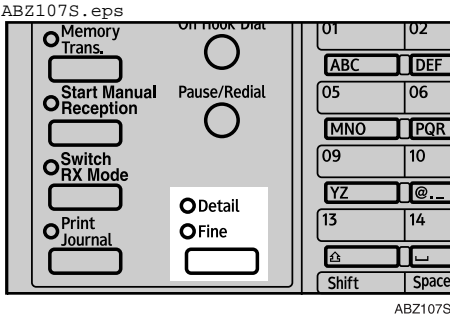

Note

- ❑ The indicators are off when the resolution is set to Standard.

Original Type

If your original contains photographs, illustrations, or diagrams with complex shading patterns or grays, select the appropriate original type to optimize image clarity.

❖ **Text**

Select Text to send an original containing a high-contrast black-and-white image. Use this setting even if your original contains text and photographs or if you only want to send clearer text.

❖ **Photo**

Select Photo to send an original containing a halftone image such as a photograph or a color original.

Note

- ❑ If you select Photo, the transmission will take longer than if you select Text.
- ❑ If you send a fax message with Photo and the background of the received image is dirty, reduce the density and re-send.

- ❑ You can select which original type (Text or Photo) is active when the machine is first turned on, or when the **[Clear Modes]** key is pressed, using **[Home Position]** under **[Key Operator Tools]**. See p.81 “Home Position”, *Facsimile Reference <Advanced Features>* (switch 02, bit 1).

- ❑ You can set the machine to return to the initial status obtained by pressing the **[Clear Modes]** key after each transmission using **[Home Position]** under **[Key Operator Tools]**. See p.81 “Home Position”, *Facsimile Reference <Advanced Features>* (switch 01, bit 7).

1 Press the **[Original Type]** key for the type you require.

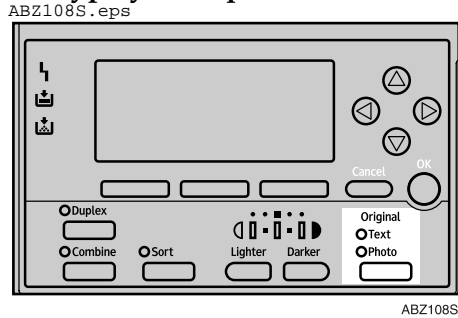

Image Density (Contrast)

The text and diagrams in your original should stand out clearly from the paper they are written on. If your original has a darker background than normal (for example, a newspaper clipping), or if the writing is faint, adjust the image density.

Use the **[Image Density]** key to vary the image density within 5 levels.

- 1 Press the **[Lighter]** or **[Darker]** key to change the density from five density level.

ABZ109S.eps

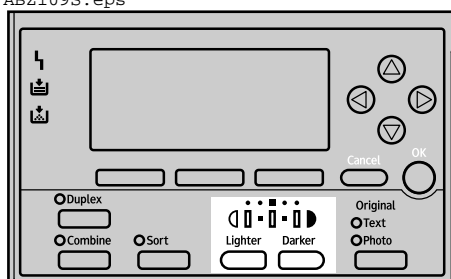

ABZ109S

Mixing Scan Settings for a Multiple Page Original

When sending an original of several pages, you can select a different image density, resolution, and original type setting for each page.

Place the original, select the scan settings for the first page, dial, and then press the **[Start]** key as you would normally. Then follow one of the following two procedures.

Note

- It is recommended that originals be placed on the exposure glass when mixing scan settings for a multiple page original.

When placing originals on the exposure glass

Note

- Select density, resolution, and original type within 60 seconds for Memory Transmission (10 seconds for Immediate Transmission). The remaining time is shown on the display.

- 1 Check which pages you want to scan with different settings.
- 2 Remove the previous page and place the next page.
- 3 Select the image density, resolution, and original type.

ABZ110S.eps

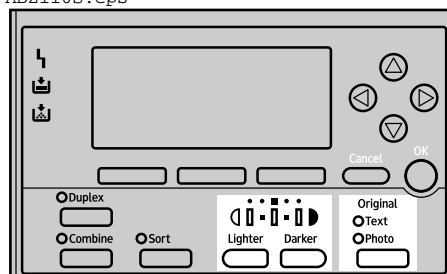

ABZ110S

ABZ107S.eps

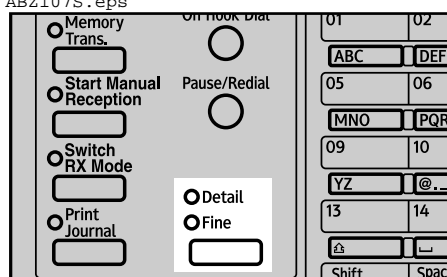

ABZ107S

Note

- Adjust the settings for each page before you press the **[Start]** key.

When placing originals in the ADF

 **Note**

Depending on what time the scan settings are adjusted, the settings may not be reflected in the resulting operation.

1 Check which pages you want to scan with different settings.

2 Select the image density, resolution, and original type before the next page is scanned.

ABZ110S.eps

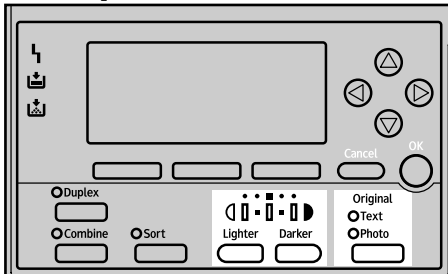

ABZ110S

ABZ107S.eps

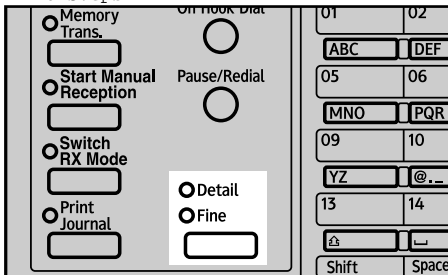

ABZ107S

Specifying a Destination

You can specify the destination using one of three methods.

- ❖ **Fax number**
p.29 "Entering a Fax Number"
- ❖ **E-mail address**
p.31 "Entering an E-mail Address"
- ❖ **Destination list**
p.31 "Using the Destination List"

This section covers these functions and others in more detail.

Note

- The display shows the percentage of free memory space for storing originals. Since fax numbers and e-mail addresses are programmed in separate memory, dialing fax numbers using the number keys does not change the percentage on the display.

Entering a Fax Number

Enter numbers directly using the key pad on the right side of the control panel.



Note

- Maximum length of a fax number: 128 digits.
- You can insert pauses and tones in a fax number. See p.30 "Pause", p.30 "Tone".

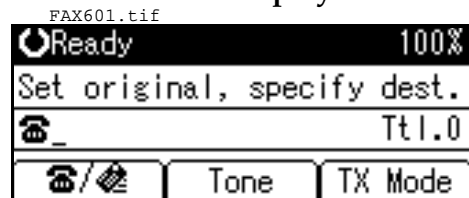
- 1** Make sure that  is displayed in the destination display column.



Note

- If it is not displayed, press [ / ].

- 2** Enter the fax number using the number keys.

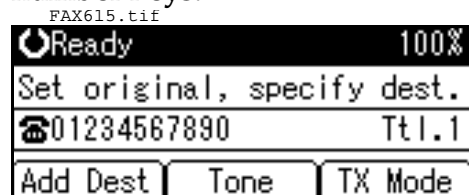

Note

- If you make a mistake, press the [**Clear/Stop**] key, and then enter again.

Pause

Press the **[Pause/Redial]** key when dialing or storing a number to insert a pause of about two seconds.

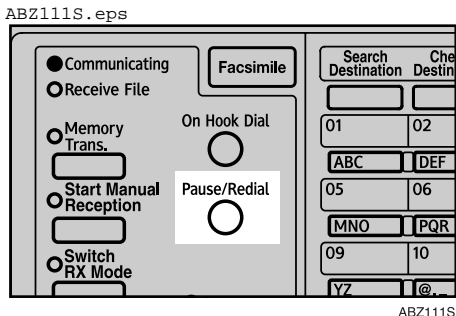

Note

- You cannot insert a pause before the first digit of a fax number. If you press the **[Pause/Redial]** key at the first digit, a redial occurs. See p.24 "Redial", *Facsimile Reference <Advanced Features>*.
- A pause is shown as a "-" on the display.

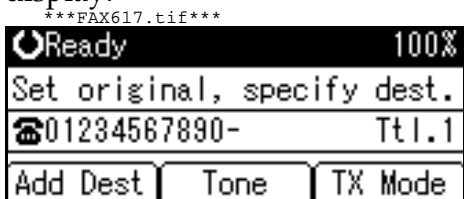

Note

- You can also program numbers including pauses in destination lists.

Tone

This function allows a machine connected to a pulse dialing line to send tonal signals (for example if you want to use a special service on a tone dialing line).

Limitation

- Certain services may be unavailable when using the Tone function.

Note

- A tone is shown as a "•" on the display.

Using the Tone function with On Hook Dial

1 Press the **[On Hook Dial]** key.

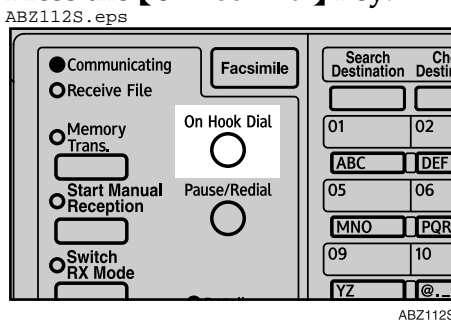

2 Enter the fax number using the number keys.

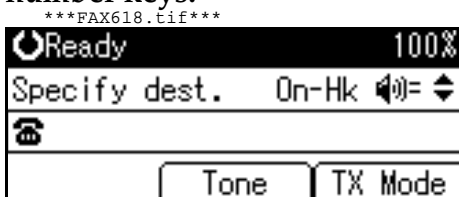

3 Press **[Tone]**.



4 Enter the number you want to tone dial using the number keys.



Entering an E-mail Address

When using Internet Fax transmission, specify the e-mail address in place of the fax number.

Note

- You can enter up to 128 characters.

- 1** Make sure that  is displayed in the destination display column.

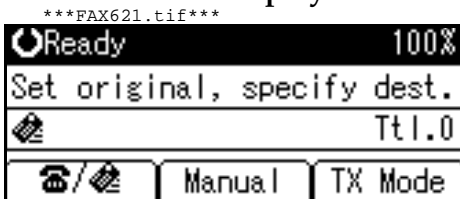

Note

- If it is not displayed, press .

- 2** Press **[Manual]**.

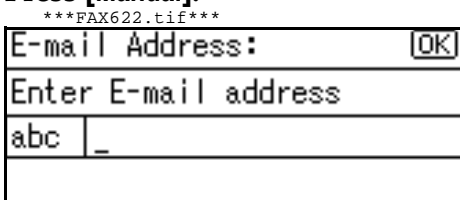

- 3** Enter the e-mail address destination, and then press the **[OK]** key.



Note

- If you make a mistake, press the **[Clear/Stop]** key, and then enter again.
- To change the e-mail address after pressing the **[OK]** key, press **[EditDest]**, re-enter an e-mail address, and then press the **[OK]** key.

Reference

“Entering Text”, *General Settings Guide*

The destination is specified.



Using the Destination List

You can program up to 150 destinations (fax numbers and e-mail addresses) into the destination list. The destinations programmed into destination numbers 001 to 016 can be specified by pressing Quick Dial keys 01 to 16. Hence, you should program frequently used destinations in the Quick Dial keys. In a Quick Dial key, you can program a single destination or multiple destinations (fax numbers and/or e-mail addresses). A Quick Dial key programmed with multiple destinations is called a Group Dial. You can send (broadcast) the same message to the destinations in the Group Dial.

You can also program a name for a Quick Dial key (for example "Brown", or "Branch Office") that will appear before you press the **[Start]** key to start sending.

Preparation

In the destination list, program individual fax numbers, e-mail addresses and/or groups of destinations. See “Registering a Fax Destination”, “Registering an E-mail Destination”, and “Registering a New Group”, *General Settings Guide*.

Limitation

Group Dial can be used for Memory Transmission only; not Immediate Transmission. If you specify Immediate Transmission in Group Dial, the "Try again after switching to memory transmission." message appears. When this happens, press **[Exit]**, and then switch to Memory Transmission.

Note

- ❑ To check the contents of Quick Dial, print the destination list. See "Key Operator Tools", *General Settings Guide*.
- ❑ A stored name can be printed out on the first page of a received fax at the other end. See p.9 "Label Insertion", *Facsimile Reference <Advanced Features>*.
- ❑ To check the contents of the Groups, print the list. See "Key Operator Tools", *General Settings Guide*.

Specifying a destination using the Quick Dial key

1 Press the Quick Dial key in which the destination's number is programmed.

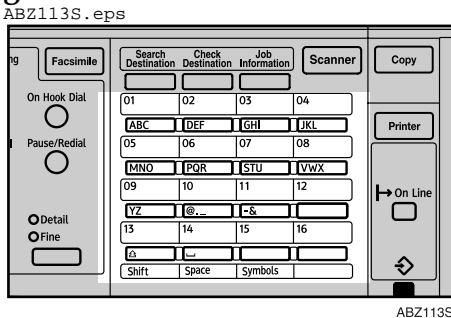

If the destination's name has been stored, the name is shown on the display. If it is not, the fax number or e-mail address is shown.

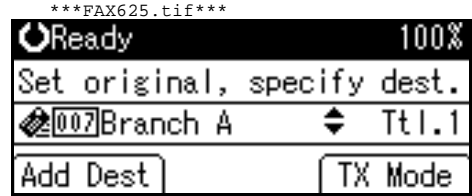

Note

- ❑ If you make a mistake, press the **[Clear/Stop]** key and try again.
- ❑ If you want to specify another destination, press **[Add Dest]** and specify another fax number or e-mail address.
- ❑ You do not have to press **[Add Dest]** when adding a destination using the Quick Dial keys.

2 Press the **[Start]** key.

Specifying a group of destinations using the Quick Dial key

1 Place the original, and then select the scan settings you require.

2 Press the Quick Dial key in which the Group is programmed.

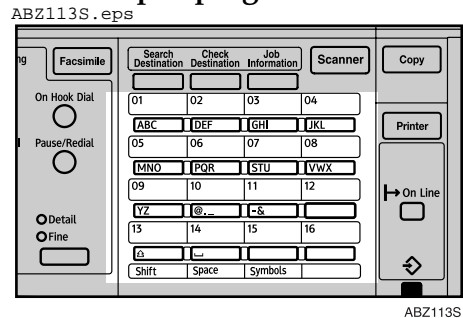

Note

- If you make a mistake, press the **[Clear/Stop]** key and try again.
- If you want to specify other destinations, press **[Add Dest]**.

3 Press the **[Start]** key.**Note**

- If you press an incorrect Quick Dial key, press the **[Clear/Stop]** key, and then press the Quick Dial key you want.
- To cancel all the destinations specified by the Quick Dial key, press the **[Clear Mode]** key. Then, repeat from step **2**.

Checking the Specified Destination

If you specified from the destination list, you can display the name and fax numbers or e-mail addresses. If the group is specified for the destination, you can display fax numbers or e-mail addresses in the group.

1 Make sure the destination name appears on the display.**Note**

- If you want to specify other destinations, press **[Add Dest]**.

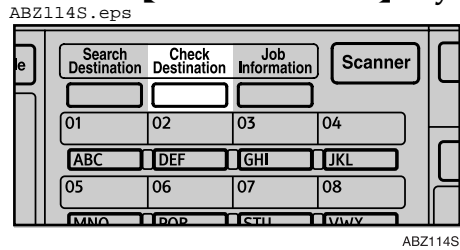
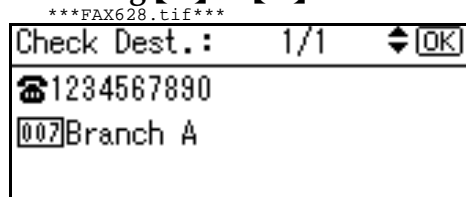
2 Press the **[Check Destination]** key.**3** If you specified more than one destination, display them one by one using **[▲]** or **[▼]**.**Note**

- If you specified a group using the Quick Dial keys, **[*]**, the group icon appears to the right of the destination name.

4 Press the **[OK]** key when confirmation is complete.

The display returns to that of step **1**.

Searching for a Destination

Use this procedure to search through the destination lists for a particular destination.

2

- ❖ **Search by Destination Name**
p.34 "Search by Destination Name"
- ❖ **Select by Display Destination List**
p.35 "Selecting from Destination List"
- ❖ **Specifying a Registration Number**
p.36 "Specifying a Registration Number"
- ❖ **Search by Fax Number**
p.37 "Search by Fax Number"
- ❖ **Search by E-mail Address**
p.38 "Search by E-mail Address"

Search by Destination Name

Note

- The search returns only destinations whose beginnings match the entered name.
- This function distinguishes between lowercase and uppercase letters.

1 Press the **[Search Destination]** key.

ABZ115S.eps

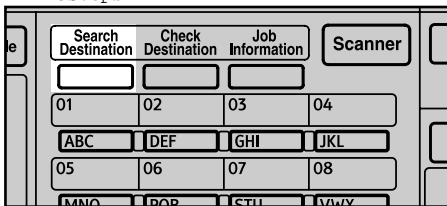

ABZ115S

2 Make sure **[Search by Name]** is selected.

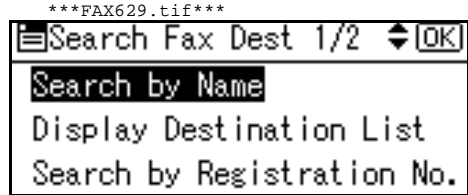

Note

- If **[Search by Name]** is not selected, press **[▲]** or **[▼]** to display.

3 Press the **[OK]** key.

[Search by Name] entry display appears.

4 Enter characters to search.

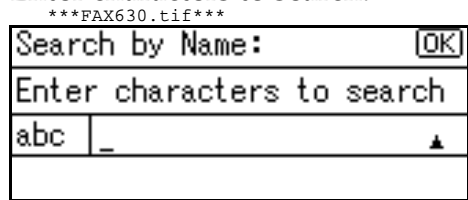

Reference

"Entering Text", *General Settings Guide*.

Note

- If you enter a wrong destination name, press **[◀]**, **[▶]** or the **[Clear/Stop]** key, and then enter the destination name again.

5 Press the **[OK]** key.

[Search by Name] confirmation display appears.

6 Press the [OK] key.

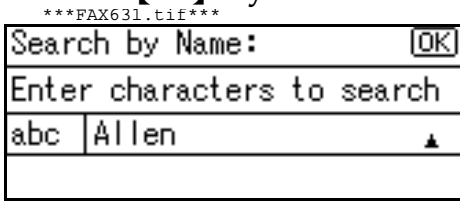

A search progress starts, then search result appears.

Note

- If no destination is matched for specified text, "Specified destination is not programmed. " is displayed. Press [Exit] to return to the display of 2.

7 Select the destination name to specify using [▲] or [▼].

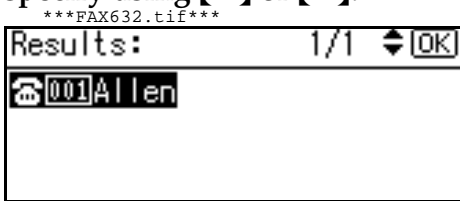

8 Press the [OK] key.

The destination which you searched is specified for the destination.

Note

- Press [Add Dest] to specify other destinations.

Selecting from Destination List

Destinations can be selected from the destination list. Destinations appear in order of registration number.

Limitation

- Fax and e-mail destinations are not displayed at the same time.

1 Press [☎/✉] to switch the destination to fax number ☎ or e-mail address ✉.

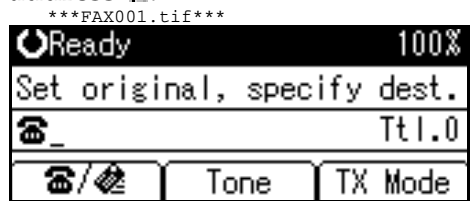

2 Press the [Search Destination] key.

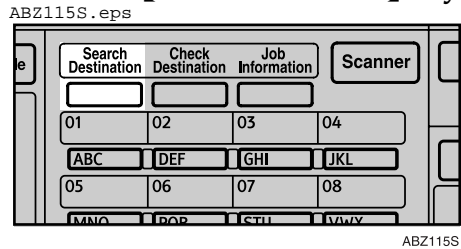

3 Select [Display Destination List] using [▼] or [▲].

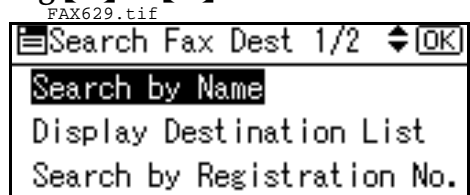

4 Press the [OK] key.

Destinations appear in order of registration number.

5 Select the destination you want to specify using [▼] or [▲].

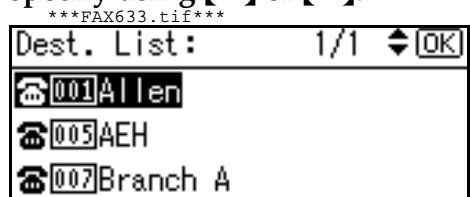

6 Press the **[OK]** key.

The specified destination is selected.

Note

- Press **[Add Dest]** to specify other destinations.
- You cannot specify destinations twice. If you try to, the "This destination has already been programmed." message appears. Press **[Exit]** to return to the standby display.

Specifying a Registration Number

You can search by Destination Lists.

Limitation

- Fax and e-mail destination are not displayed at the same time.

1 Press the **[Search Destination]** key.

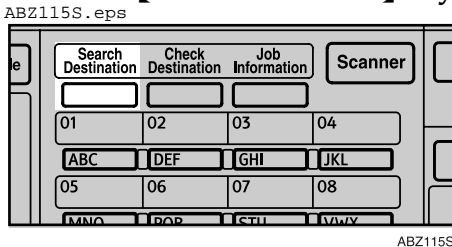

2 Select **[Search by Registration No.]** using **[▲]** or **[▼]**.

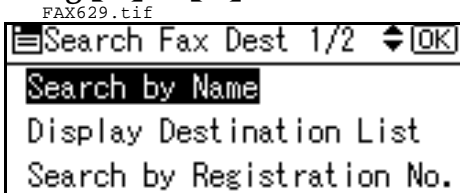

3 Press the **[OK]** key.

[Search by Registration No.] entry display appears.

4 Enter the three-digit registration number of desired Quick Dial key by number keys.

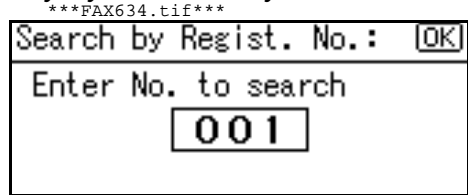

Note

- If you enter a wrong registration number, press the **[Clear/Stop]** key, and then enter the code again.

5 Press the **[OK]** key.

Search result appears.

Note

- If no destination is matched for specified registration number, "Specified destination is not programmed." is displayed. Press **[Exit]** to return to the display of **2**.

6 Press the **[OK]** key.

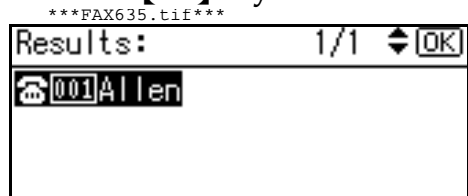

The destination which you searched is specified for the destination.

Note

- If you try to specify the destination again, "This destination has already been programmed." is displayed. Press **[Exit]** to return to the destination specifying display.
- Press **[Add Dest]** to specify other destinations.

Search by Fax Number

Note

- The search returns only destinations whose beginnings match the entered fax number.

1 Press [**☎/📠**] to display **☎**.

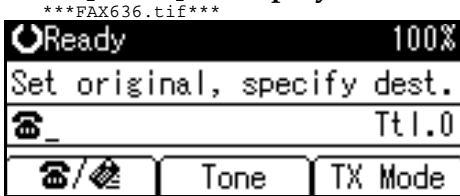

2 Press the [**Search Destination**] key.

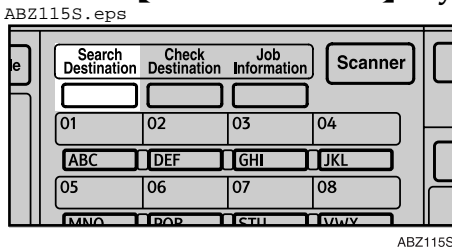

3 Select [**Search by Fax No.**] using [**▲**] or [**▼**].

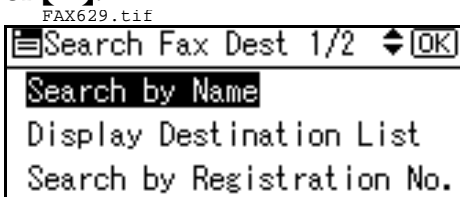

Note

- If [**Search by Fax No.**] does not appear, **☎** is not selected in step **1**. Press the [**Cancel**] key to return to step **1**.

4 Press the [**OK**] key.

[**Search by Fax No.**] entry display appears.

5 Enter a fax number to search for.

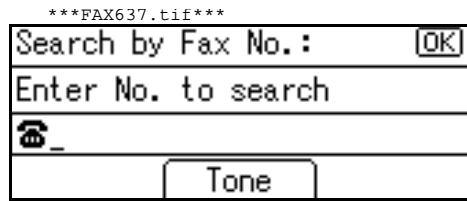

Note

- You can search with a part of the fax number. However, you must enter a number from top for beginning matching.
- If you enter a wrong fax number, press [**◀**], [**▶**] or the [**Clear/Stop**] key, and then enter the number again.

6 Press the [**OK**] key.

[**Search by Fax No.**] confirmation display appears.

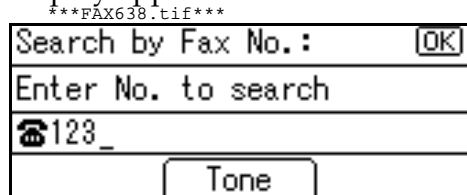

7 Press the [**OK**] key.

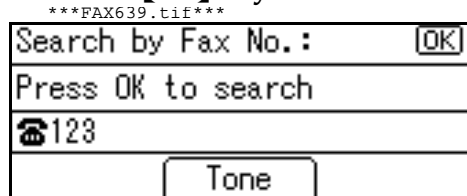

Search result appears.

Note

- If no destination is matched for specified fax number, "Specified destination is not programmed." is displayed. Press [**Exit**] to return to step **5**.

- 8** Select the number to specify using **[▲]** or **[▼]**.

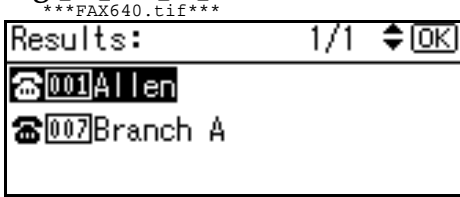

- 9** Press the **[OK]** key.

The destination which you searched is specified.

Note

- Press **[Add Dest]** to specify other destinations.

Search by E-mail Address

Note

- The search returns only destinations whose beginnings match the entered e-mail address.

- 1** Press **[📠/📡]** to display **📠**.

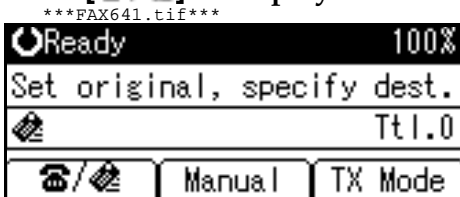

- 2** Press the **[Search Destination]** key.

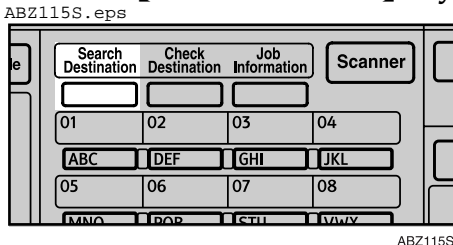

- 3** Select **[Search by E-mail Address]** using **[▲]** or **[▼]**.

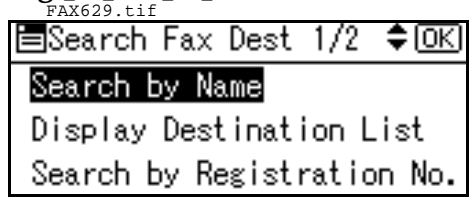

Note

- If **[Search by E-mail Address]** does not appear, **📠** is not selected in step **1**. Press the **[Cancel]** key to return to step **1**.

- 4** Press the **[OK]** key.

[Search by E-mail Address] entry display appears.

- 5** Enter an e-mail address to search for.

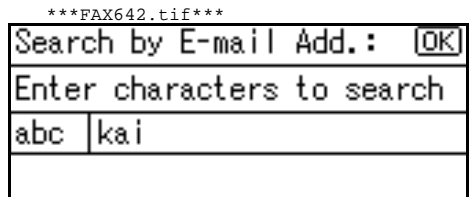

Reference

"Entering Text", *General Settings Guide*

Note

- You can search with a part of the e-mail address. However, you must enter a number from top for beginning matching.
- If you enter a wrong e-mail address, press **[◀]**, **[▶]** or the **[Clear/Stop]** key, and then enter the address again.

- 6** Press the **[OK]** key.

[Search by E-mail Address] confirmation display appears.

7 Press the [OK] key.

```

***FAX643.tif***
Search by E-mail Add. : [OK]
Press OK to search
kai

```

Search result appears.

Note

- If no destination is matched for specified e-mail address, "Specified destination is not programmed. " is displayed. Press [Exit] to return to the display of **8**.

8 Select the e-mail address to specify using [▲] or [▼].

```

***FAX644.tif***
Results: 1/1 [OK]
[001]Allen

```

9 Press the [OK] key.

The destination which you searched is specified.

Note

- Press [Add Dest] to specify other destinations.

Reception

There are two ways you can set up your machine to handle incoming calls:

- Manual Reception (external telephone required)
- Auto Reception

❖ Auto Switch

In this mode, the machine rings a number of times. You can answer the call while the machine is ringing. If you do not answer the call, the machine automatically changes to receive fax messages.

❖ Manual Reception

When a telephone call comes in, the machine rings. If the call is a fax message, you must switch manually to facsimile mode.

❖ Auto Reception

When a telephone call comes in, the machine automatically receives it as a fax message. Use this setting on a dedicated fax line.

Note

- The external telephone is required to use this machine as a telephone.
- You can change the number of rings. See p.67 "RX Mode Auto Switch Time", *Facsimile Reference <Advanced Features>* .
- When the other party send a fax message, the machine changes to receive the fax message automatically.
- You can connect a telephone answering machine with Auto Select.

- Set a smaller number of rings for the telephone answering machine than for the fax machine.
- This function will not work with certain answering machines.

Switching the Reception Mode

You can switch reception modes using the Reception Settings menu (under Fax Features). See p.67 "Reception Settings", *Facsimile Reference <Advanced Features>* .

If you program a User Function key with Switch Reception Mode, you can switch reception mode quickly. See p.66 "General Settings/Adjust", *Facsimile Reference <Advanced Features>* . This function is set to the User Function key **[F2]** as default.

Press the **[Switch RX Mode]** key.

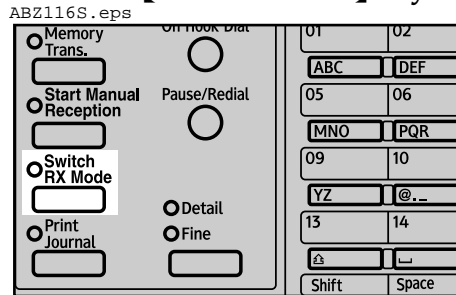

- 2 Select the reception mode using [▲] or [▼], and then press the [OK] key.

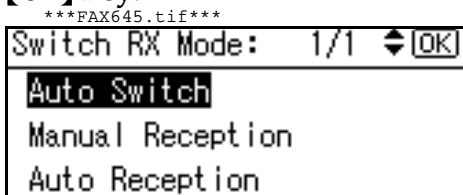

The standby display appears.

 **Note**

- To cancel the selection, press the [Cancel] key.

Receiving a Fax in Manual Reception Mode

- 1 When the machine rings, pick up the handset of the external telephone.
- 2 If you hear beeps, press the [Start] key. (The [Start] key is only available in facsimile mode when an original is not placed.)
- 3 Select [Start RX] using [▲] or [▼].



- 4 Replace the handset of the external telephone. The machine will start receiving.

3. Using Internet Fax Functions

Internet Fax Functions

The optional printer/scanner unit is required.

This machine converts scanned document images to e-mail format and transmits the data over the Internet.

The e-mail sent by this machine can be received by another Internet Fax machine. Instead of dialing the telephone number of the destination you want to send to, you enter the relevant e-mail address.

You can also print or forward received e-mail messages.

ABZ028S . eps

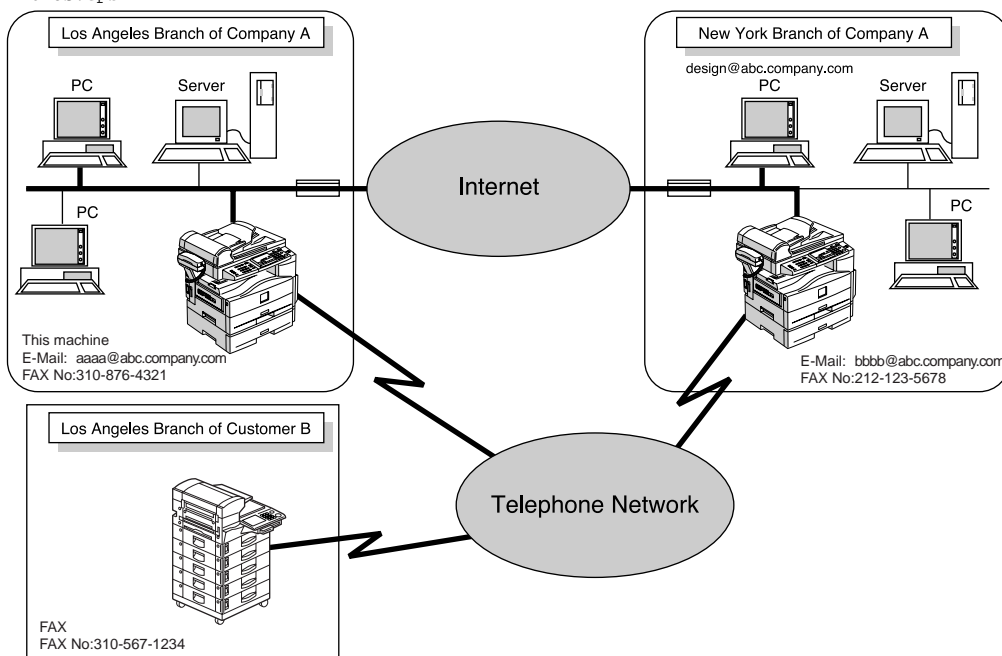

ABZ028S

Note

- This machine must be connected to a LAN and set up correctly in order to use its Internet Fax functions. See *Network Guide*.
- The Internet Fax function supported by this machine is compliant with ITU-T Rec. T.37.
- You can receive e-mail messages with an attached TIFF-F image sent from computers.

Internet Fax Precautions

3

- Internet Fax communicates with a server over a LAN. It cannot communicate directly with other parties.
- If a transmission is not successful, this machine usually receives an e-mail error notification. See p.99 "Server-Generated Error E-mail", *Facsimile Reference <Advanced Features>* . However, e-mail error notifications may not be transmitted for various reasons. We recommend you confirm receipt of important document by calling the other party.
- The level of security for Internet communications is low. We recommend you use the telephone network for confidential communications.
- Voice communication is not supported over a LAN.
- Internet Fax delivery might be delayed due to network congestion. Use a standard fax whenever communication is time sensitive.
- If you use this machine with dial-up connection, the Auto E-mail Reception function accesses the provider's server via telephone line and may incur call charges even if you do not receive e-mail. To reduce the frequency of server access, specify a large E-mail Reception Interval. For the E-mail Reception Interval setting, see "Settings You Can Change with User Tools - File Transfer", *Network Guide*.

Functions Not Supported by E-mail Transmission

The following functions are supported with standard fax transmission, but not with Internet Faxing.

- Immediate Transmission
- Chain Dial
- On Hook Dial
- Manual Dial
- JBIG Transmission
- Batch Transmission
- ECM (Error Correction Mode)

Functions Not Supported by E-mail Reception

The following functions are supported with standard fax reception, but not with Internet Faxing.

- Memory Lock Reception
- Authorized Reception

T.37 Full Mode

This machine is T.37 full mode compatible. T.37 full mode is an international standard for Internet Fax transmission. (ITU-T announcement, RFC2532)

When an Internet Fax communication is made between T.37 full mode compatible machines, the receiver side sends the return receipt (dispatched) in response to the reception confirmation request attached to the sent e-mail. This return receipt includes the receiver's reception capability information (compression type, paper size, and resolution). When the receiver is programmed in the Address Book as the full mode destination, the sender side automatically registers the received information in the Address Book. This allows you to send subsequent an Internet Fax document to that receiver based on this information.

Note

- When you program a destination in the Address Book via a Web browser, program the T.37 full mode supporting machine as the T.37 full mode destination. See p.58 "Editing Receiver's Fax Information Via Web Browser", *Facsimile Reference <Advanced Features>* .
- When you use Internet Fax transmission, you can send a document to multiple destinations at once. However, when you specify full mode destinations, since each destination may have a different reception capability, transmission is done one by one in the specified transmission order.

❖ Returning a Return Receipt

When an e-mail is received, if the sender requests reception confirmation, the receiver sends a return receipt that includes the receiving machine's capability (compression type, paper size, and resolution).

❖ Registering the Received Reception Confirmation Contents

When the sender receives the return receipt that includes the receiver's reception capability, the sender checks the sent final recipient address is programmed in the Address Book. If it is programmed as a full mode destination, the sender automatically registers the receiver's reception capability. The registered reception capability is updated each time the sender receives new reception capability information. The sender can send documents to the receiver based on this information.

❖ Requesting a Reception Confirmation

When the receiver's machine supports T.37 full mode and is programmed as a full mode machine and its reception capability is set in the Address Book, the machine requests the reception confirmation from the receiver. Then, the machine will receive the return receipt (sent) that includes the receiver's reception capability.

 **Note**

- If the receiver is programmed as the simple mode machine or not programmed in the Address Book, the receiver's reception capability cannot be registered.
- If you know the receiver's reception capability, you can set it manually. However, this setting will be overwritten when the machine receives the return receipt. See p.58 "Editing Receiver's Fax Information Via Web Browser", *Facsimile Reference <Advanced Features>* .

Transmitting Internet Fax

Preparation

You need to make System Settings beforehand. See "Setting Up the Machine on a Network", *Network Guide*.

This section describes how to scan a document into the memory and send it as e-mail. Specify the destination's e-mail address instead of fax number.

You can send Internet Fax documents only with Memory Transmission. If you specify Immediate Transmission in Internet Fax, the "Try again after switching to memory transmission." message appears. When this happens, press **[Exit]**, and then switch to Memory Transmission.

When sending documents, you can set e-mail options using **[TX Mode]**.

You can set the following options:

❖ Attach Subject

Allows you to enter a subject for the document you want to send.

Note

- For convenience, program frequently-used subject. "Urgent", and "High" are programmed as default. See "Settings You Can Change with User Tools - File Transfer", *Network Guide*.
- You can enter up to 64 characters in total.
- If you send e-mail without setting a subject in "E-mail Options" under "TX Mode", the subject is automatically inserted. For more details about how a subject is automatically inserted, see p.51 "About the E-mail Subject".
- You cannot send a subject only as e-mail without an original.

❖ Return Receipt

You can confirm sent documents were properly received using e-mail or Journal.

Important

- If power outage lasts about an hour, or the machine is disconnected from the power outlet for about an hour, documents stored in the fax machine's memory are deleted. If any document is deleted, the Power Failure Report is automatically printed out when the main power switch is turned on. Use this report to check which documents were deleted. Simply turning off the power by pressing the Operation switch does not delete stored documents. See p.98 "Turning Off the Main Power/In Case of a Power Failure", *Facsimile Reference <Advanced Features>*.
 - You may not be able to send large files as e-mail, depending on e-mail environment conditions.
 - The level of security for Internet communications is low. Use of the telephone network is recommended for confidential communications.
- ### Limitation
- When available memory is low, you may not be able to send the Internet Faxes.
- #### Note
- Because the machine sends documents as e-mail messages with an attached TIFF-F image, viewer applications are required in order to view documents when they are received on a computer.

- ❑ You can limit the size of transmitted e-mail messages. See p.68 "E-mail Settings", *Facsimile Reference <Advanced Features>*.
- ❑ See p.56 "Received Images" for how e-mail is actually received by the computer when it is sent with mail options selected.
- ❑ When you transmit an Internet Fax specifying a user code, and the e-mail address is set as the routing destination of the specified user code, a Communication Result Report is sent after the transmission is completed. This makes it possible to verify the result of a transmission.
- ❑ You can specify fax destination and Internet Fax destination simultaneously.
- ❑ You cannot send e-mails to a destination as cc.

1 Press [📠/📡] to display 📡.

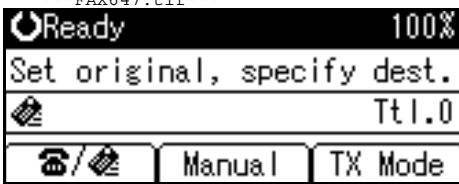

2 When you set an e-mail option, press [TX Mode].

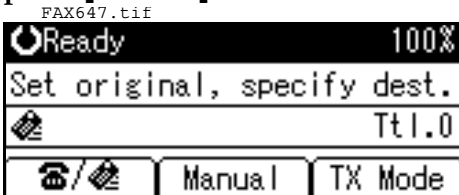

If you are not setting e-mail options, proceed to step **4**.

3 Select [E-mail Options] using [▲] or [▼], and then press the [OK] key.

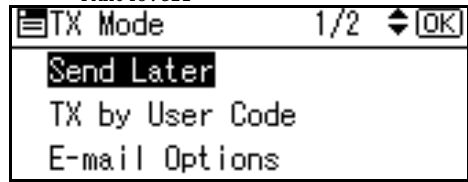

To enter the subject directly

A Select [Attach Subject] using [▲] or [▼], and then press the [OK] key.

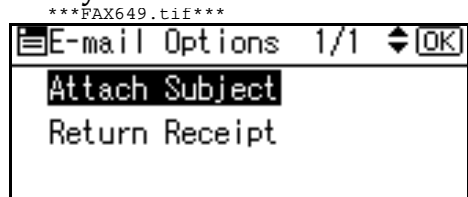

B Select [Manual Input] using [▲] or [▼], and then press the [OK] key.

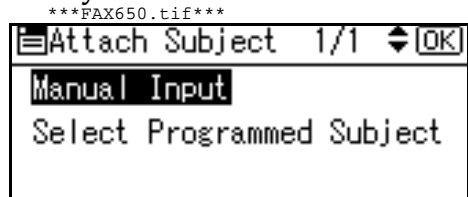

C Enter the subject.

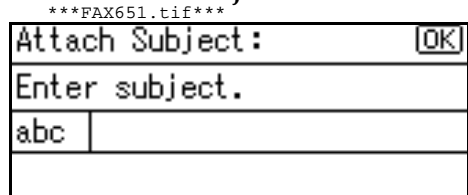

Reference

"Entering Text", *General Settings Guide*.

Note

- ❑ If you enter a wrong subject, press the [Clear/Stop] key, and then enter the subject again.

D Press the [OK] key.

The display returns to that of step A.

Note

- If you press the **[Cancel]** key, entering a subject is canceled. The display returns to that of step A.

To enter the programmed subject

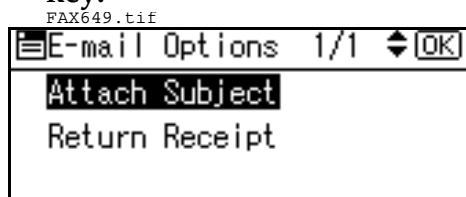
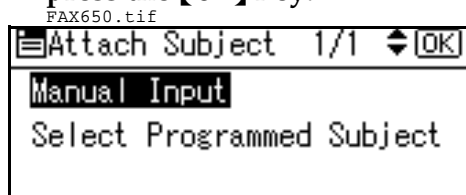
A Select [Attach Subject] using [▲] or [▼], and then press the [OK] key.**B Select [Select Programmed Subject] using [▲] or [▼], and then press the [OK] key.****C After selecting the subject, press the [OK] key.****Note**

- You can register up to 5 programmed subjects. See p.48 "To enter the subject directly".
- If you press the **[Cancel]** key, attaching a subject is canceled. The display returns to that of step A.

The display returns to that of step A.

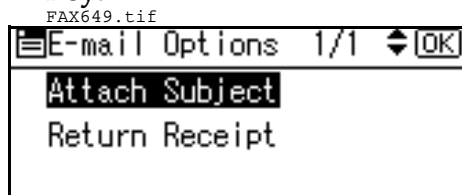
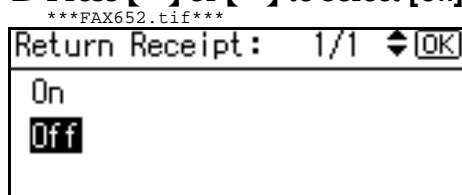
Setting Return Receipt**A Select [Return Receipt] using [▲] or [▼], and then press the [OK] key.****B Press [▲] or [▼] to select [On].****Note**

- Select **[Off]**, if you do not want to confirm the reception.

C Press the [OK] key.

The display returns to that of step A.

Note

- If you press the **[Cancel]** key, the setting is canceled. The display returns to that of step A.

4 Press the [Cancel] key twice to return to the standby display.**5 Place the original.****Note**

- You can send the first few pages from the exposure glass then the remaining pages from the ADF. After you remove the last page from the exposure glass, you have 60 seconds to insert the remaining pages in the ADF.
- Note that you cannot place pages on the exposure glass after you have started using the ADF.

- The original can be placed either in the ADF or on the exposure glass, until the **[Start]** key is pressed.

 **Reference**

p.13 "Placing Originals".

- 6** Select the scan settings you require.

 **Note**

- In Internet Fax transmission, the original is scanned using "Detail" resolution for transmission, even if you select "Fine".

 **Reference**

p.25 "Resolution"

p.26 "Original Type"

p.27 "Image Density (Contrast)"

- 7** Enter the e-mail address.

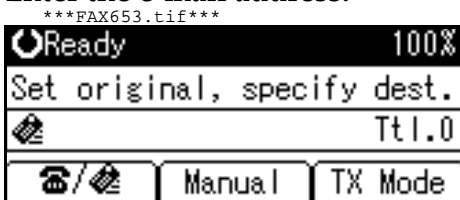

 **Note**

- If  is not displayed in the destination display column, press **[Fax/E]**.

 **Reference**

p.31 "Entering an E-mail Address".

p.31 "Using the Destination List".

p.24 "Redial", *Facsimile Reference <Advanced Features>* .

- 8** To send the same document to multiple destinations, press **[Add Dest]**.

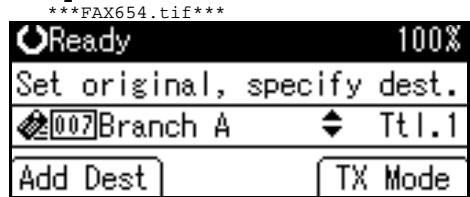

To send e-mail to one destination only, proceed to step 10.

 **Note**

- It is not necessary to press **[Add Dest]** when adding destinations using the Quick Dial key.

- 9** Specify the next destination.

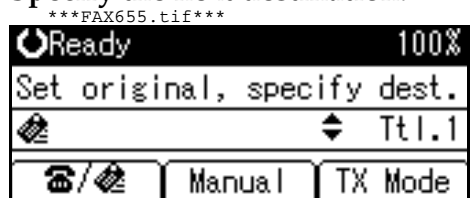

 **Note**

- Press **[Fax/E]** to switch the destination between fax number and e-mail address.
- To specify more destinations, repeat steps 8 and 9.
- If you want to delete an entered destination, find it using **[▲]** or **[▼]**, press the **[Clear/Stop]** key, and then press **[Delete]**.

10 Press the **[Start]** key.

This machine starts scanning the document into memory. The e-mail send operation starts after the scanning operation is complete. When scanning is complete, the Communicating indicator lights and transmission starts.

Note

- With a large volume of document, it may take some time before transmission starts. This is due to the time the machine requires to convert the data in memory.
- To cancel transmission of an Internet Fax, see p.53 "Canceling Internet Fax Transmission".

About the E-mail Subject

If there is no subject specified in "Program Fax Information" under "General Settings/Adjust", a subject is automatically inserted.

- If Own Fax Number and Own Name are programmed:
From "Own Fax Number" ("Own Name") (Fax Message NO.xxxx)
- If only Own Fax Number is programmed:
From "Own Fax Number" (Fax Message NO.xxxx)
- If only Own Name is programmed:
From "Own Name" (Fax Message NO.xxxx)
- If neither Own Fax Number nor Own Name are programmed:
Fax Message NO.xxxx

Note

- "xxxx" is the document number that appears in the Journal.

Reference

p.57 "Initial Settings and Adjustments"

E-mail Text

When Internet Fax e-mail is sent to computer, the following information is always inserted in the e-mail text. To check the host name and e-mail address, see "Settings You can Change with User Tools", *Network Guide*.

This e-mail was sent from "Host Name" (product name)

Queries to: "Key Operator's e-mail address"

Confirming Reception

When Return Receipt is set under "E-mail Options", the receiver sends back a return receipt message. Once the return receipt message has been received, "OK" appears in the Result column of Journal, allowing the originator to verify that the transmission has been received.

Limitation

- ❑ The Return Receipt feature is only available if the receiver supports MDN (Message Disposition Notification).
- ❑ Simultaneous Broadcast is not available in this function. Message is sent to a receiver at a time in the order of specified destinations.

Note

- ❑ If your fax is not received normally, "Error" appears in the Result column.
- ❑ Information regarding the last 200 messages is recorded, but only the last 50 communications appear in Journal. If you do not receive a return receipt message for one of the last 50 communications from the receiver's machine, you may not be able to confirm that the e-mail has been received by the Journal's Result column.
- ❑ If you specify mailing list addresses, do not set for Return Receipt. Otherwise, you will receive multiple return receipt messages from e-mail recipients, and the Result column will be overwritten each time a new notice message is received. However, if you receive a return receipt message indicating an error, "Error" appears in the Result column and will not be overwritten, even if you subsequently receive a return receipt message as "OK" following the error message.
- ❑ Return receipt results are only shown in Journal. The Result column in all other files, lists, and transmission reports show "- -".
- ❑ Return receipt messages themselves are not recorded in Journal.
- ❑ The return receipt can be printed out. This can be set with User Parameters. See p.76 "User Parameters", *Facsimile Reference <Advanced Features>* (switch 21, bit 0).

Canceling Internet Fax Transmission

When fax and Internet Fax destinations are specified simultaneously, you can cancel sending using the same method.

Note

- You cannot cancel a transmission once scanning is complete.

Before the Original Is Scanned

Use this procedure to cancel a transmission before pressing the **[Start]** key.

1 Press the **[Clear Modes]** key.

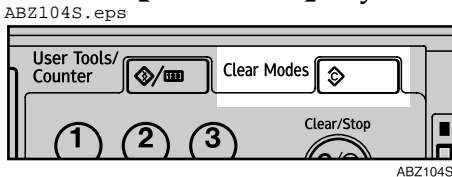

Note

- When documents are placed in the ADF, you can cancel transmission simply by removing them.

While the Original Is Being Scanned

Use this procedure to cancel a transmission after pressing the **[Start]** key.

1 Press the **[Clear/Stop]** key.

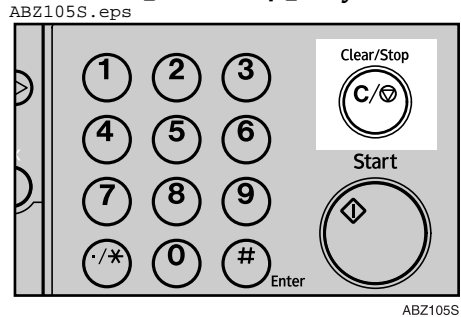

The machine stops scanning.

Note

- Scanning may be completed while you are performing the cancel operation.
- If transmission finishes while you are carrying out this procedure, it is not canceled.

Receiving Internet Fax

You can receive e-mail documents by Internet Fax.

There are two methods of receiving e-mail: Auto E-mail Reception and Manual E-mail Reception.

Limitation

- ❑ E-mail with attachments other than TIFF-F format files cannot be received. Senders receive an Error Mail Notification if their e-mail contains attachments. You can select whether or not the machine sends this message with User Parameters. See p.76 "User Parameters", *Facsimile Reference <Advanced Features>* (switch 21, bit 7). However, TIFF-F documents created by the Saving function of Desktop-Binder V2 Professional Lite can be received.

Note

- ❑ When Reception Protocol is set to POP3 or IMAP4, you can set the machine to retain incoming e-mail or delete it from the server in "System Settings". See "Settings You Can Change with User Tools - File Transfer", *Network Guide*.
- ❑ With User Parameters, you can have the machine return the acknowledgment of e-mail to the sender. See p.76 "User Parameters", *Facsimile Reference <Advanced Features>* (switch 21, bit 1).

Auto E-mail Reception

When this function is turned on, the machine periodically checks the e-mail server for incoming e-mail and downloads it as necessary.

E-mail auto-reception should be set in "System Settings". When you select auto-reception, set the reception interval in minutes.

See "Settings You Can Change with User Tools - File Transfer", *Network Guide*.

Note

- ❑ If memory runs out, e-mail will not be received at the specified intervals. Reception will resume when sufficient memory becomes available.

Manual E-mail Reception

The following operation allows you to receive e-mail at all times.

Preparation

Program the Manual E-mail RX function to a User Function key ([F1] to [F3]) beforehand. See p.66 "Set User Function Key", *Facsimile Reference <Advanced Features>*.

1 Press the programmed User Function key ([F1] to [F3]).

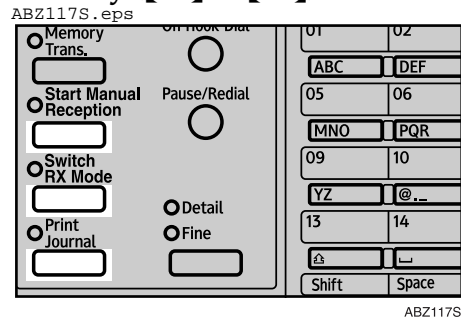

Guide display appears.

2 Press the **[Start]** key.

FAX656.tif

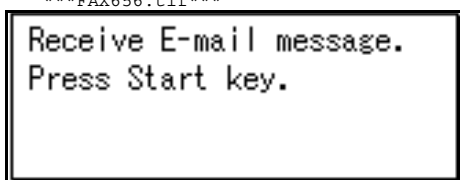

ABZ106S.eps

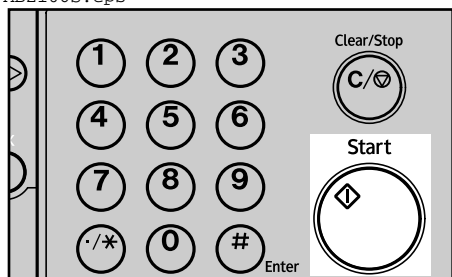

ABZ106S

Accesses the server to check for e-mail.

E-mail is in the server

A Start printing and receiving in the memory. If the receiving is finished, the standby display appears.

FAX657.tif

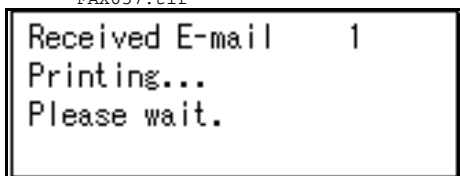

E-mail is not in the server

A Press [Exit].

FAX658.tif

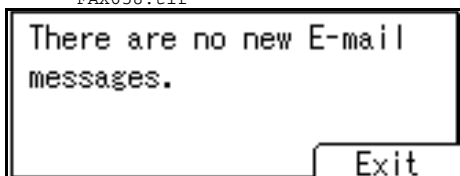

The standby display appears.

Received Images

Here is an example of an Internet Fax message sent from this machine and received on a computer using Outlook e-mail software.

The received image varies according to e-mail software.

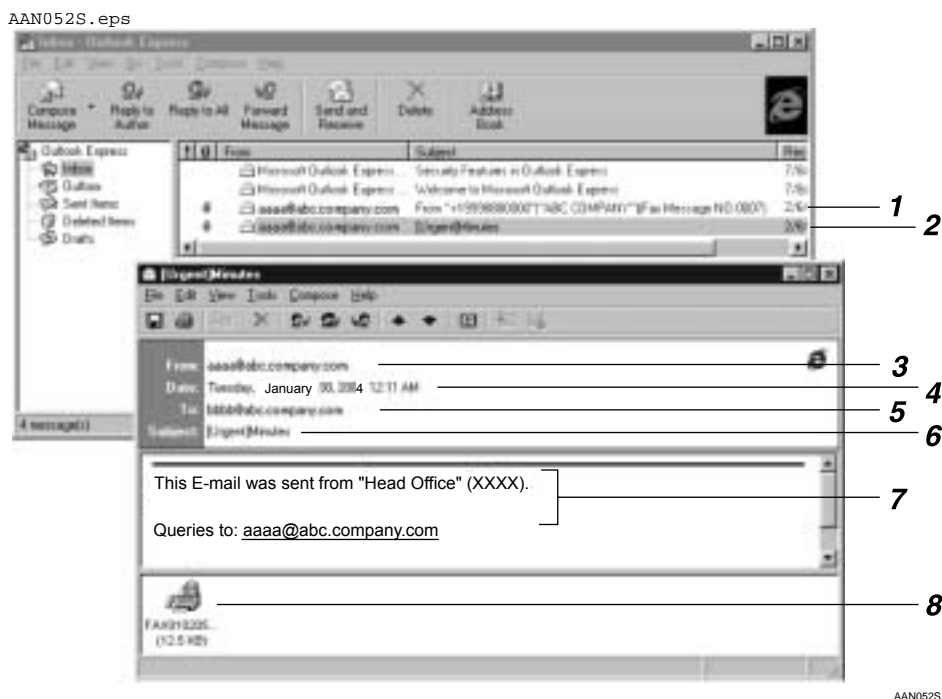

1. E-mail transmitted without specifying a subject in "E-mail Options".

2. E-mail transmitted with a subject specified in "E-mail Options".

3. From

The name (e-mail address) of the sender

4. Date

The date and time of e-mail transmission

5. To

The e-mail address of the recipient

6. Subject

Shows the subject specified in "E-mail Options" at the time of transmission. If no subject is specified, one is automatically assigned in the format shown in 1 above. From "Own Fax Number" ("Own Name") (Fax Message NO. document number)

7. The message is inserted in all e-mails.

XXXX is a product name.

8. Attachment File

Any message included by the sender is displayed as an attached document.

4. Programming

Initial Settings and Adjustments

You can send information to the other party when transmitting or receiving a fax message. This information is shown on the display of the other machine and printed as a report. The following information can be sent.

Important

- You can confirm programmed settings from the User Parameter List. We recommend that you print and keep the User Parameter List when you program or change settings. See p.80 "Printing the User Parameter List", *Facsimile Reference <Advanced Features>* .

❖ Fax Header

The Fax Header is printed as the header of every fax you send. You should include your name in the Fax Header.

Important

- In the USA, the Fax Header must contain the telephone number of the line your machine is connected to. It will be printed on the header of every page you send. Required in the USA.

Note

- You can program up to 32 characters in the Fax Header.
- You can use characters, symbols, numbers, and spaces.
- You can set whether or not to print a Fax Header using **[Print Fax Header]** under **[TX Mode]**. See p.8 "Fax Header Print", *Facsimile Reference <Advanced Features>* .

- In the USA, law requires that your fax number be included in the Fax Header. Program the fax number and switch on Fax Header Print with User Parameters. See, p.76 "User Parameters", *Facsimile Reference <Advanced Features>* .

❖ Own Name

The Own Name is sent to the other party when you send or receive a fax using a G3 line. This name should include your name. The Own Name is shown on the display of the other machine and printed in a report.

Limitation

- Own Name works only when the other machine is of the same manufacturer, and has the Own Name function.

Note

- You can use characters, symbols, numbers, and spaces.
- You can program up to 20 characters as an Own Name.

❖ Own Fax Number (facsimile number of sender)

The sender's Own Fax Number is sent to the other party when sending a fax using a G3 line. The received facsimile number is shown on the display of the other machine and printed in a report. This function is available regardless of the manufacturer of the other party's machine.

Note

- ❑ You can program up to 20 characters in Own Fax Number.

Note

- ❑ When the Key Operator Code is programmed and turned on, user have to enter programmed the Key Operator Code (maximum 8 digit) to operate Key Operator Tools.
- ❑ This prevents unauthorized people from changing registration.

4

Programming

- 1 Press the [User Tools/Counter] key.

ABZ118S.eps

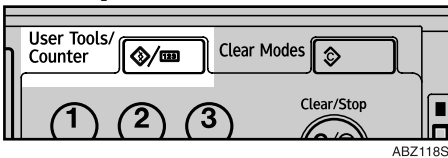

- 2 Select [Fax Features] using [▲] or [▼], and then press the [OK] key.

FAX659.tif

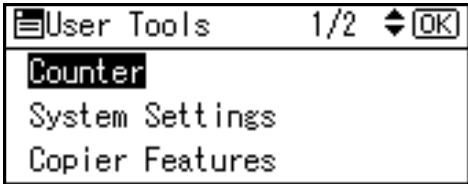

Note

- ❑ If the Key Operator Code is programmed and turned on, enter the Key Operator Code (maximum 8 digit) using number keys, and then press the [OK] key.

- 3 Select [General Settings/Adjust] using [▲] or [▼], and then press the [OK] key.

FAX660.tif



- 4 Select [Program Fax Information] using [▲] or [▼], and then press the [OK] key.

FAX661.tif

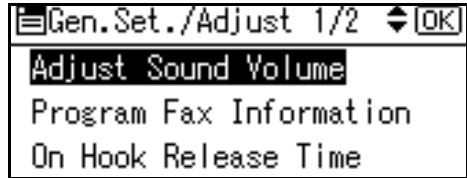

- 5 Program your name and fax number.

Programming a Fax Header

- A Select [Fax Header] using [▲] or [▼], and then press the [OK] key.

FAX662.tif

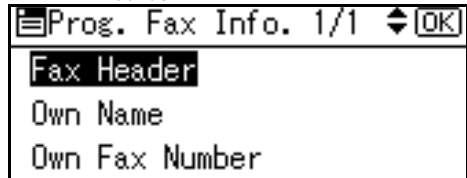

- B Enter a Fax Header, and then press the [OK] key.

FAX065.tif

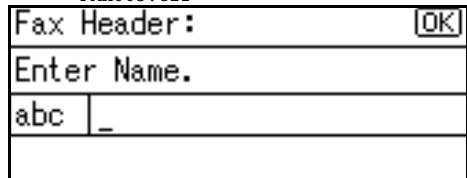

Reference

"Entering Text", *General Settings Guide*

Programming an Own Name

- A Select [Own Name] using [▲] or [▼], and then press the [OK] key.

FAX662.tif

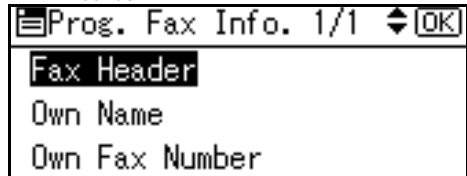

B Enter an Own Name, and then press the **[OK]** key.

FAX067.tif

Own Name:	[OK]
Enter Name.	
ABC	▲

Reference

"Entering Text", *General Settings Guide*.

Programming an Own Fax Number

A Select **[Own Fax Number]** using **[▲]** or **[▼]**, and then press the **[OK]** key.

FAX662.tif

Prog. Fax Info. 1/1	◆	[OK]
Fax Header		
Own Name		
Own Fax Number		

B Enter an Own Fax Number using number keys, and then press the **[OK]** key.

FAX069.tif

Own Fax Number:	[OK]
Enter Number.	
☎	
+	Space

Note

- To enter a + sign or a space, press **[+]** or **[Space]**.
- If you enter a wrong number, press **[◀]**, **[▶]** or the **[Clear/Stop]** key, and then enter the number again.

6 Press the **[User Tools/Counter]** key.
The standby display appears.

Editing

Note

- This following procedure explains how to edit Fax Header, as an example of editing.
- When the Key Operator Code is programmed and turned on, user have to enter programmed the Key Operator Code (maximum 8 digit) to operate Key Operator Tools.

1 Press the **[User Tools/Counter]** key.

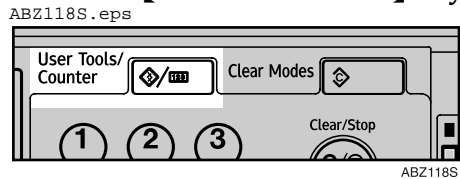

2 Select **[Fax Features]** using **[▲]** or **[▼]**, and then press the **[OK]** key.



Note

- If the Key Operator Code is programmed and turned on, enter the Key Operator Code (maximum 8 digit) using number keys, and then press the **[OK]** key.

3 Select **[General Settings/Adjust]** using **[▲]** or **[▼]**, and then press the **[OK]** key.



- 4** Select [Program Fax Information] using [▲] or [▼], and then press the [OK] key.

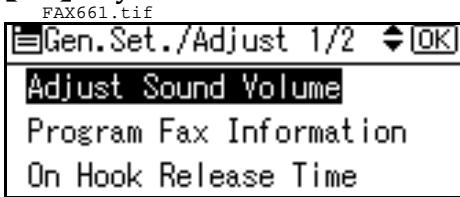

- 5** Select [Fax Header] using [▲] or [▼], and then press the [OK] key.

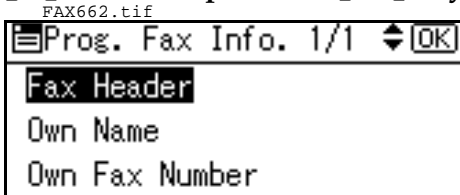

- 6** Press the [Clear/Stop] key.

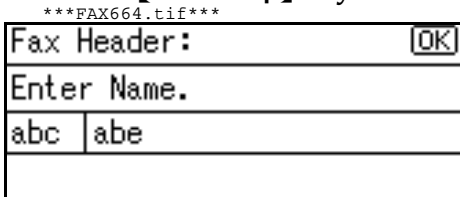

All characters are deleted.

- 7** Enter the characters you want to program, and then press the [OK] key.

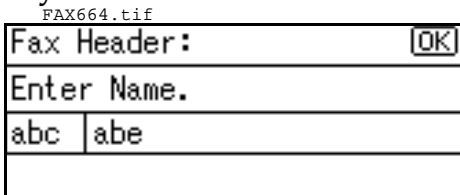

The information for editing are programmed.

Reference

"Entering Text", *General Settings Guide*.

Note

- Press the [Cancel] key to cancel editing. The display returns to that of step 5.

- 8** Press the [User Tools/Counter] key. The standby display appears.

Deleting

This following procedure explains how to delete Fax Header, as an example of deleting.

Note

- If the Key Operator Code is programmed and turned on, enter the Key Operator Code(maximum 8 digit) using number keys, and then press the [OK] key.

- 1** Press the [User Tools/Counter] key.

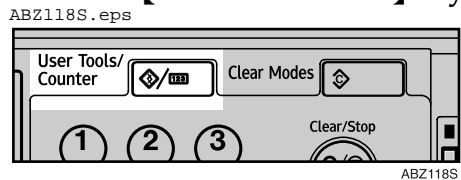

- 2** Select [Fax Features] using [▲] or [▼], and then press the [OK] key.



- 3** Select [General Settings/Adjust] using [▲] or [▼], and then press the [OK] key.



- 4** Select [Program Fax Information] using [▲] or [▼], and then press the [OK] key.

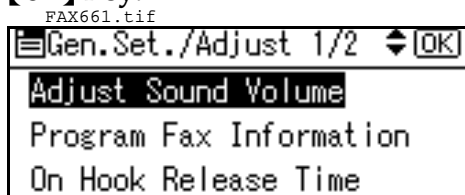

- 5** Select [Fax Header] using [▲] or [▼], and then press the [OK] key.

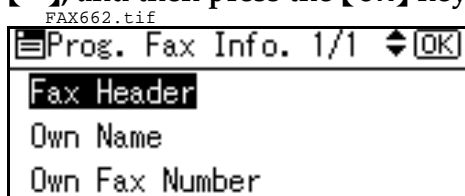

- 6** Press the [Clear/Stop] key.

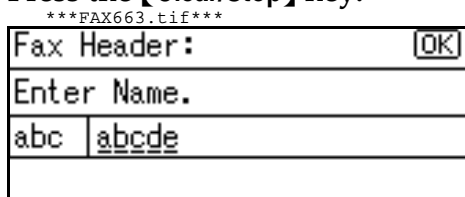

All registered characters are deleted.

Note

- Press the [Cancel] key to cancel deleting. The display returns to that of step **5**.

- 7** Press the [OK] key.

The display returns to that of step **5**.

- 8** Press the [User Tools/Counter] key.

The standby display appears.

Programming Fax Numbers and E-mail addresses

You can program fax destinations using Address Book Management in the Key Operator Tools menu under System Settings.

You can also register the programmed fax numbers and e-mail addresses in a Group.

Note

- ❑ When you try to return to the standby display after changing the contents of the Address Book, a message appears stating the destination list has been updated. Press **[Exit]**. The standby display then reappears.

Reference

“Key Operator Tools”, *General Settings Guide*

“E-mail Destination”, *General Settings Guide*

“Registering Destinations to a Group”, *General Settings Guide*

5. Troubleshooting

Adjusting the Volume

You can change the volume of the following sounds that the machine makes.

❖ On Hook Mode

Heard when the **[On Hook Dial]** key is pressed.

❖ At Transmission

Heard when the machine sends a message.

❖ At Reception

Heard when the machine receives a message.

❖ At Dialing

Heard after pressing the **[Start]** key, until the line connects to the destination.

❖ At Printing

Heard when a received message is printed. See p.40 "Print Completion Beep", *Facsimile Reference <Advanced Features>* .

Note

- ❑ You can adjust the On Hook volume when you press the **[On Hook Dial]** key. See p.25 "On Hook Dial", *Facsimile Reference <Advanced Features>* .

1 Press the **[User Tools/Counter]** key.

ABZ118S.eps

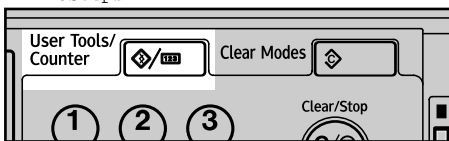

ABZ118S

2 Select **[Fax Features]** using **[▲]** or **[▼]**, and then press the **[OK]** key.

FAX659.tif

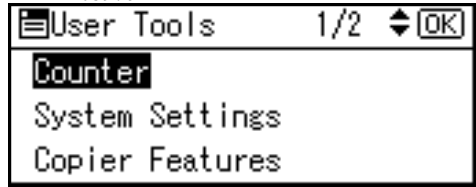

3 Select **[General Settings/Adjust]** using **[▲]** or **[▼]**, and then press the **[OK]** key.

FAX660.tif

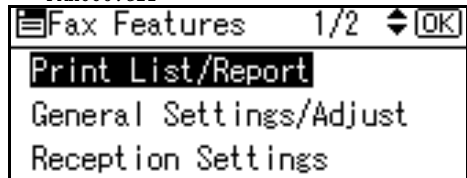

4 Select **[Adjust Sound Volume]** using **[▲]** or **[▼]**, and then press the **[OK]** key.

FAX661.tif

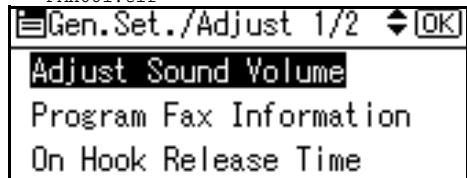

5 Select the item you want to adjust using **[▲]** or **[▼]**.

FAX665.tif

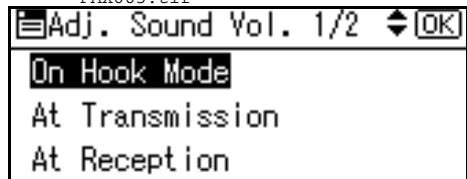

6 Press the **[OK]** key.

- 7** You can adjust the volume using [◀] or [▶].

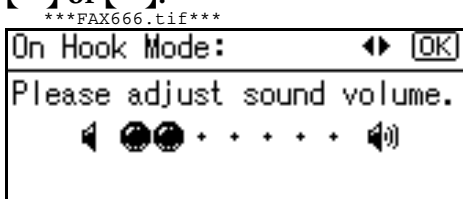

Note

- You can adjust the volume by seven levels.

- 8** Press the [OK] key.

Note

- Press the [Cancel] key to cancel setting and the display returns to that of step 5.

- 9** Press the [User Tools/Counter] key.
The standby display appears.

When [Facsimile] Key Is Lit in Red

If this key is lit, press the key to enter the facsimile mode. Then, refer to the table below and take the appropriate action.

ABZ119S.eps

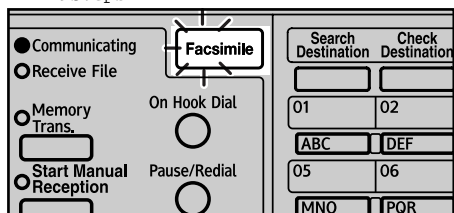

Problem	Solutions
A facsimile error has occurred.	The facsimile has a problem. Contact your service representative. See p.67 "Error Messages and Their Meanings" The copier will still function normally.
Out of paper	Add more paper. "Loading Paper", <i>Copy Reference</i>
A network error has occurred.	<ul style="list-style-type: none"> • Check the displayed message. See p.67 "Error Messages and Their Meanings". • Check the machine is correctly connected to the network, and the machine is correctly set. See <i>Network Guide</i>. • Consult your network administrator. • When the key is still lit in red even if you take the measures above, please contact your service representative.

When Toner Runs Out

When the machine has run out of toner, the symbol appears on the display. Note that even if there is no toner left, you can still send fax messages.

Important

- The number of communications, that have been executed after the toner has run out and that automatically-output Journal has not list, exceeds 100, communication will not be possible.

Limitation

- The Memory Storage Report is not printed.

1 Make sure that the machine is in facsimile mode.

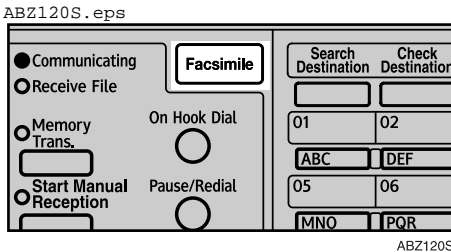

Note

- If the standby display is not displayed, press the **[Facsimile]** key.

2 Press **[Exit]**, and then perform transmission operation.

The error message disappears.

Reference

- p.16 "Memory Transmission"
- p.21 "Immediate Transmission"

Error Messages and Their Meanings

If there is an error, one of the following messages may appear on the display. If other message appears, follow the message.

Message	Causes and solutions
Put original back, check it and press Start key.	Original jammed during Memory Transmission. Place originals that have not been scanned again.
Error occurred, and trans. was cancelled.	<p>A document jam occurred during Immediate Transmission. Press the [OK] key, and then resend the pages that have not been sent.</p> <p>An error occurred during Immediate Transmission. Press the [OK] key, and then resend the original.</p> <p> Note</p> <p><input type="checkbox"/> There may be a problem with the machine or the telephone line (for example noise or cross talk). If the error reoccurs frequently, contact your service representative.</p>
Memory is full. Scanning will be stopped and only scanned page(s) will be stored.	If you press [Exit] , the machine returns to standby mode and starts transmitting the pages that have been stored.
Cannot send fax as scanner is in use by another function.	<p>The Copy function is in use. To cancel the job in process, do the following, and then try faxing again.</p> <p>Press [Exit], and then press the [Copy] key. Next press the [Clear/Stop] key. When the message "[Stop] key was pressed. Stop copying?" appears, press [Stop].</p>
Updating the settings. Re-select dest./functions after update finishes.	Wait with the main power switch on. The machine will enter standby mode after it exits from RDS mode.
Check whether there are any network problems. [14-01]	<p>Cannot find the DNS server or SMTP server.</p> <ul style="list-style-type: none"> • Check the DNS server is correctly programmed using the Web browser. See the Web browser's Help. • Check the SMTP server is correctly programmed using the Web browser. See the Web browser's Help. • Check the LAN cable is correctly connected to the machine. See "Connecting the Network Cable to the Network", <i>Network Guide</i>. • Check the network connection and radio wave status. • Consult your network administrator.

Message	Causes and solutions
<p>Check whether there are any network problems. [14-09]</p>	<p>E-mail transmission was refused by SMTP authentication or POP before SMTP authentication.</p> <ul style="list-style-type: none"> • Check the user name and password for SMTP or POP before SMTP authentication are correctly programmed in Fax Mail Reception Account under File Transfer in System Settings. See "Settings You Can Change with User Tools-File Transfer", <i>Network Guide</i>. • Check the user name and password of the e-mail account are correctly programmed from Fax Mail Reception Account under File Transfer in System Settings. See "Settings You Can Change with User Tools-File Transfer", <i>Network Guide</i>. • Consult your network administrator.
<p>Check whether there are any network problems. [14-33]</p>	<p>No machine's e-mail address is programmed.</p> <ul style="list-style-type: none"> • Check the fax machine's e-mail address is correctly programmed from Fax Mail Reception Account under File Transfer in System Settings. See "Settings You Can Change with User Tools-File Transfer", <i>Network Guide</i>. • Consult your network administrator.
<p>Check whether there are any network problems. [15-01]</p>	<p>No POP3/IMAP4 server's address is programmed.</p> <ul style="list-style-type: none"> • Check the host name or IP address of the POP3/IMAP4 server is correctly programmed using the Web browser. See the Web browser's Help. • Consult your network administrator.
<p>Check whether there are any network problems. [15-02]</p>	<p>No account name is programmed.</p> <ul style="list-style-type: none"> • Check the user name and password of the e-mail account are correctly programmed from Fax Mail Reception Account under File Transfer in System Settings. See "Settings You Can Change with User Tools-File Transfer", <i>Network Guide</i>. • Consult your network administrator.
<p>Check whether there are any network problems. [15-03]</p>	<p>No machine's e-mail address is programmed.</p> <ul style="list-style-type: none"> • Check the fax machine's e-mail address is correctly programmed from Fax Mail Reception Account under File Transfer in System Settings. See "Settings You Can Change with User Tools-File Transfer", <i>Network Guide</i>. • Consult your network administrator.

Message	Causes and solutions
Check whether there are any network problems. [15-11]	Cannot find the DNS server or POP3/IMAP4 server. <ul style="list-style-type: none"> • Check the DNS server is correctly programmed using the Web browser. See the Web browser's Help. • Check the POP3/IMAP4 server is correctly programmed using the Web browser. See the Web browser's Help. • Check the network connection and radio wave status. • Consult your network administrator.
Check whether there are any network problems. [15-12]	Cannot log on to the POP3/IMAP4 server. <ul style="list-style-type: none"> • Check the user name and password of the e-mail account are correctly programmed from Fax Mail Reception Account under File Transfer in System Settings. See "Settings You Can Change with User Tools-File Transfer", <i>Network Guide</i>. • Consult your network administrator.

Out of paper display message

If the paper tray runs out of paper, "Out of paper. Load it, then press [Exit]." appears on the display, asking you to add more paper.

Note

- If there is paper left in the other paper trays, you can receive messages as usual, even if the message appears on the display.
- You can turn this function on or off with the User Parameters. See p.76 "User Parameters", *Facsimile Reference <Advanced Features>* (switch 05, bit 7).

Network error display message



If the "Check whether there are any network problems." message appears, the machine is not correctly connected to the network or the settings of the machine is not correct. If you do not need to connect the machine to the network, you can select so that the message disappear and the key goes out with User Parameters. See p.76 "User Parameters", *Facsimile Reference <Advanced Features>* (switch 21, bit 6).

Note

- When you restart connecting the machine to the network, make sure to set "Display" with User Parameters. Otherwise, you cannot check the status of the network connection.

Solving Problems

This table lists some common problems and their solutions.

Problem	Causes and solutions	Reference
Image background appears dirty when received at the other end. Images from the back page appear.	Adjust scan density.	p.27 "Image Density (Contrast)"
Printed or sent image contains spots.	The ADF or exposure glass is dirty. Clean them. Make sure that ink or correction fluid is dry before placing originals.	"Maintaining Your Machine", <i>Copy Reference</i>
Received image is too light.	Request the sender to increase image density.	---
	When using moist, rough, or processed paper, the printed image may be partly invisible. Only use recommended paper.	"Copy Paper", <i>General Settings Guide</i>
	When  appears on the display, toner is beginning to run out. Replace the toner cartridge soon.	"  Adding Toner", <i>Copy Reference</i>
The machine failed to print received fax messages.	If this happened when the receive file indicator was lit, a problem such as run out of paper or toner might disable printing.	p.34 "Substitute Reception", <i>Facsimile Reference <Advanced Features></i>
	When  is lit, load paper into the tray.	"Loading Paper", <i>Copy Reference</i>
Message appears blank at the other end.	The original was placed upside down. Place it properly.	p.13 "Placing Originals"
Both transmission and receiving are impossible.	Make sure that the modular cord is correctly connected.	p.101 "Connecting the Machine to a Telephone Line and Telephone", <i>Facsimile Reference <Advanced Features></i>
	The terminal adaptor setting is incorrect. Check the setting.	---
Transmission is possible, though receiving is impossible.	The optional terminal adaptor setting is incorrect. Check the setting.	---
Receiving is possible, though transmission is impossible.	The optional terminal adaptor setting is incorrect. Check the setting.	---

Problem	Causes and solutions	Reference
When using On Hook Dial or Manual Dial, "Receiving" appears and transmission is not allowed.	If the machine fails to detect the size of the original when the [Start] key is pressed, it performs a receiving operation.	
All fax messages stored in memory have been lost. Those messages include ones stored through Memory Transmission/Reception or Substitute Reception.	When about one hour passes after power of the machine is turned off, all fax messages stored in memory are lost. If any messages have been lost for this reason, a Power Failure Report is automatically printed when the machine is turned on. If fax messages stored for Memory Transmission have been lost, check the destinations and resend the messages. If fax messages received through Memory or Substitute Reception have been lost, ask the senders to resend the messages.	p.98 "Turning Off the Main Power/In Case of a Power Failure", <i>Facsimile Reference <Advanced Features></i>
Transmission failed due to "Exceeded max. E-mail size." error.	If the e-mail size specified on the machine is exceeded, an Internet Fax document cannot be sent. Set Max. E-mail Size to OFF, or specify the maximum e-mail size to a larger value. Then, resend the document.	p.68 "E-mail Settings", <i>Facsimile Reference <Advanced Features></i>
Other fax machine's name is not correctly printed or displayed.	When a destination is programmed in the Address Book using SmartDeviceMonitor for Admin or Web browser, in some languages, the programmed destination may not print or display correctly. When this happens, use ASCII characters (for example: a-z, 0-9).	

When Things Don't Go as Expected

I Want...	Operation	Reference
to cancel a Memory Transmission.	If the original is being scanned, press the [Clear/Stop] key.	p.19 "Canceling a Memory Transmission"
	If the original is being sent, press the [Clear/Stop] key, [Stop TX] , and then [Delete] .	p.19 "Canceling a Memory Transmission" p.11 "Canceling a Transmission", <i>Facsimile Reference <Advanced Features></i>
to cancel an Immediate Transmission.	Press the [Clear/Stop] key.	p.24 "Canceling an Immediate Transmission"
to cancel Internet Fax transmission. ! Limitation <input type="checkbox"/> Canceling Internet Fax transmission is possible only during scanning. It is impossible during communication.	Press the [Clear/Stop] key.	p.53 "Canceling Internet Fax Transmission"

5

INDEX

A

- Adjusting the Volume, 63
 - At Dialing*, 63
 - At Printing*, 63
 - At Reception*, 63
 - At Transmission*, 63
 - On Hook Mode*, 63
- Attach Subject, 47
- Authorized Reception, 44
- Auto E-mail Reception, 54

B

- Batch Transmission, 44
- Broadcasting, 16
- Broadcasting Sequence, 18

C

- Chain Dial, 44
- Control Panel, 5
- CSI->Own Fax Number, 57

D

- Destination List, 31, 35
- Destination Name, 34
- Detail, 25
- Display, 7
- Display panel, 7

E

- ECM, 44
- E-mail Address, 38
- Entering a fax number, 29
- Entering an E-mail Address, 31
- Error Messages, 67

F

- Facsimile key, 65
- Fax Header, 57
 - Deleting*, 60
 - Editing*, 59
 - Programming*, 58
- Faxing, 11
- Fax Number, 37
- Fine, 25
- Functions Not Supported by e-mail Reception, 44
- Functions Not Supported by e-mail Transmission, 44

G

- Getting Started, 5

I

- Image Density (Contrast), 27
- Immediate Transmission, 11, 21
 - Canceling*, 24
- Internet Fax, 43
 - Canceling a Transmission*, 53
 - Precautions*, 44
 - Receiving*, 54
 - Transmitting*, 47

J

- JBIG Transmission, 44

M

- Manual Dial, 44
- Manual E-mail Reception, 54
- Manual Reception Mode, 41
- Memory Lock Reception, 44
- Memory Transmission, 11, 16
 - Canceling*, 19

N

- Network error, 69

O

- On Hook Dial, 44
- Original Type, 26
- Out of paper, 69
- Own Fax Number, 57
 - Deleting*, 60
 - Editing*, 59
 - Programming*, 58
- Own Name, 57
 - Deleting*, 60
 - Editing*, 59
 - Programming*, 58

P

- Pause, 30
- Photo, 26
- Placing Originals, 13
- Programming, 57

Q

Quick Dial

Specifying a destination, 32

Specifying a group of destinations, 32

R

Received Images, 56

Reception, 40

Auto Reception, 40

Manual Reception, 40

Registration Number, 36

Resolution, 25

Return Receipt, 47

RTI->Own Name, 57

S

Scan Settings, 25

Standard, 25

Switching the Reception Mode, 40

T

T.37 Full Mode, 45

Text, 26

Tone, 30

Toner, 66

Transmission Modes, 11

TTI->Fax Header, 57

U

User code, 10

MEMO

MEMO

Free Manuals Download Website

<http://myh66.com>

<http://usermanuals.us>

<http://www.somanuals.com>

<http://www.4manuals.cc>

<http://www.manual-lib.com>

<http://www.404manual.com>

<http://www.luxmanual.com>

<http://aubethermostatmanual.com>

Golf course search by state

<http://golfingnear.com>

Email search by domain

<http://emailbydomain.com>

Auto manuals search

<http://auto.somanuals.com>

TV manuals search

<http://tv.somanuals.com>