

DSm616/DSm620
LDI16/LDI20
Aficio™ 2016/2020

Operating Instructions
General Settings Guide

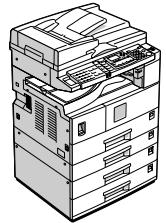

-
- 1** Getting Started
 - 2** Combined Function Operations
 - 3** User Tools (System Settings)
 - 4** Troubleshooting
 - 5** Other Functions
 - 6** Entering Text
 - 7** Security
 - 8** Specifications

Read this manual carefully before you use this machine and keep it handy for future reference. For safe and correct use of this machine, please be sure to read the Safety Information in the "Copy Reference" before you use it.

Introduction

This manual contains detailed instructions and notes on the operation and use of this machine. For your safety and benefit, read this manual carefully before using the machine. Keep this manual in a handy place for quick reference.

Important

Contents of this manual are subject to change without prior notice. In no event will the company be liable for direct, indirect, special, incidental, or consequential damages as a result of handling or operating the machine.

Notes:

Some illustrations in this manual might be slightly different from the machine.

Certain options might not be available in some countries. For details, please contact your local dealer.

Laser Safety:

This machine is considered a class 1 laser device, safe for office/EDP use. The machine contains a 5-milliwatt, 760-800 nanometer wavelength, GaAlAs laser diode. Direct (or indirect reflected) eye contact with the laser beam might cause serious eye damage. Safety precautions and interlock mechanisms have been designed to prevent any possible laser beam exposure to the operator.

The following label is attached on the back side of the machine.

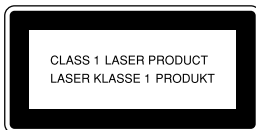

Caution:

Use of controls or adjustment or performance of procedures other than those specified in this manual might result in hazardous radiation exposure.

Notes:

The model names of the machines do not appear in the following pages. Check the type of your machine before reading this manual. (For details, see P.iii "Machine Types".)

- Type 1: DS*m*616/LD116/Aficio 2016
- Type 2: DS*m*620/LD120/Aficio 2020

Certain types might not be available in some countries. For details, please contact your local dealer.

Two kinds of size notation are employed in this manual. With this machine refer to the metric version.

For good copy quality, the supplier recommends that you use genuine toner from the supplier.

The supplier shall not be responsible for any damage or expense that might result from the use of parts other than genuine parts from the supplier with your office products.

Power Source

220 - 240V, 50/60Hz, 7A or more

Please be sure to connect the power cord to a power source as above. For details about power source, see "Power Connection" in the Copy Reference.

Manuals for This Machine

The following manuals describe the operational procedures of this machine. For particular functions, see the relevant parts of the manual.

Note

- Manuals provided are specific to machine type.
- Adobe Acrobat Reader is necessary to view the manuals as a PDF file.
- Two CD-ROMs are provided:
 - CD-ROM 1 “Operating Instructions for Printer/Scanner”
 - CD-ROM 2 “Scanner Driver & Document Management Utilities”

❖ **General Settings Guide (this manual)**

Provides an overview of the machine and describes System Settings (paper trays, Key Operator Tools, etc.), and troubleshooting. Refer to this manual for Address Book procedures such as registering fax numbers, e-mail addresses, and user codes.

❖ **Network Guide (PDF file - CD-ROM1)**

Describes procedures for configuring the machine and computers in a network environment.

❖ **Copy Reference**

Describes operations, functions, and troubleshooting for the machine's copier function.

❖ **Facsimile Reference <Basic Features>**

Describes operations, functions, and troubleshooting for the machine's facsimile function.

❖ **Facsimile Reference <Advanced Features>**

Describes advanced functions and settings for key operators.

❖ **Printer Reference 1**

Describes system settings and operations for the machine's printer function.

❖ **Printer Reference 2 (PDF file - CD-ROM1)**

Describes operations, functions, and troubleshooting for the machine's printer function.

❖ **Scanner Reference (PDF file - CD-ROM1)**

Describes operations, functions, and troubleshooting for the machine's scanner function.

❖ **Manuals for DeskTopBinder Lite**

DeskTopBinder Lite is a utility included on the CD-ROM labeled “Scanner Driver & Document Management Utilities”.

- DeskTopBinder Lite Setup Guide (PDF file - CD-ROM2)
Describes the installation of, and the operating environment for DeskTopBinder Lite in detail. This guide can be displayed from the **[Setup]** dialog box when DeskTopBinder Lite is installed.
- DeskTopBinder Lite Introduction Guide (PDF file - CD-ROM2)
Describes operations of DeskTopBinder Lite and provides an overview of its functions. This guide is added to the **[Start]** menu when DeskTopBinder Lite is installed.
- Auto Document Link Guide (PDF file - CD-ROM2)
Describes operations and functions of Auto Document Link installed with DeskTopBinder Lite. This guide is added to the **[Start]** menu when DeskTopBinder Lite is installed.

❖ **Manuals for ScanRouter V2 Lite**

ScanRouter V2 Lite is a utility included on the CD-ROM labeled “Scanner Driver & Document Management Utilities”.





- ScanRouter V2 Lite Setup Guide (PDF file - CD-ROM2)
Describes the installation of, settings, and the operating environment for ScanRouter V2 Lite in detail. This guide can be displayed from the **[Setup]** dialog box when ScanRouter V2 Lite is installed.
- ScanRouter V2 Lite Management Guide (PDF file - CD-ROM2)
Describes delivery server management and operations, and provides an overview of ScanRouter V2 Lite functions. This guide is added to the **[Start]** menu when ScanRouter V2 Lite is installed.

❖ **Other manuals**

- PostScript3 Supplement (PDF file - CD-ROM1)
- Unix Supplement (available from an authorized dealer, or as a PDF file on our Web site)

Machine Types

This machine comes in two models which vary by copy speed.

	Type 1	Type 2 ^{*1}
Copy speed	16 copies/minute (A4  , 8 1/2" x 11" )	20 copies/minute (A4  , 8 1/2" x 11" )

^{*1} 18 copies/minute (feeding from Optional Paper Tray Unit)

What You Can Do with This Machine

The following introduces the functions of this machine, and the relevant manuals containing detailed information about them.

Products marked with * are optional. For details about optional products, see p.13 "Options", or contact your local dealer.

Copier, Facsimile, Printer, and Scanner Functions

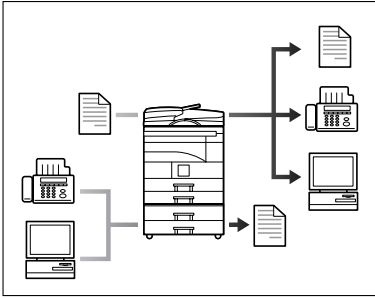

AAI0085

This machine provides copier, facsimile*, printer*, and scanner* functions.

- You can make copies of originals. See *Copy Reference*.
- You can send originals by fax or e-mail, and receive faxes from other parties. See *Facsimile Reference <Basic Features>*, and *Facsimile Reference <Advanced Features>*.
- You can print documents created in computer applications. See *Printer Reference 1*, and *Printer Reference 2*.
- You can scan originals and send scan files to a computer. See *Scanner Reference*.

Paperless Fax Transmission

Transmission

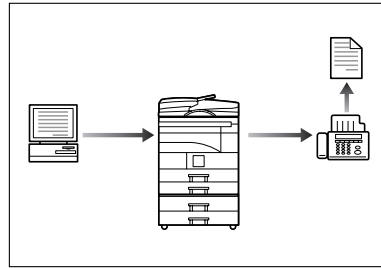

AAI0165

- You can send documents created in computer applications to another party's fax machine directly, without printing (Sending fax documents from computers). See *Facsimile Reference <Advanced Features>*.

Fax Transmission and Reception through the Internet

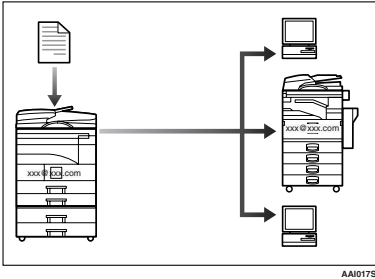

- You can send fax documents through e-mail by specifying the recipient's e-mail address (Transmitting Internet Fax). You can receive sent documents via Internet Fax, or from computers (Receiving Internet Fax). See *Facsimile Reference*<Basic Features>.

Using the Scanner in a Network Environment

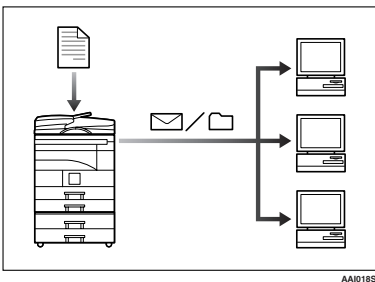

- You can send scan files to a specified destination using e-mail (Sending scan file by e-mail). See *Scanner Reference*.

- With ScanRouter V2 Professional*/Lite, you can save scan files in specified destinations on network computers (Using the network delivery scanner function). See *Scanner Reference*.

Administrating the Machine (Security Functions)

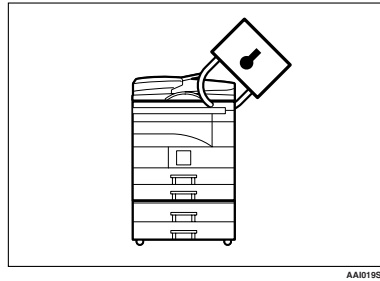

The security functions protect documents from being copied without permission or unauthorized access via the network. See p.97 "Security".

Note

- This function is only available when the printer/scanner and fax units are installed.

Security Functions

- Protecting against unauthorized access via phone lines
- Authenticating administrator (setting the key operator code) See p.34 "Key Operator Code".

Monitoring the Machine Using a Computer

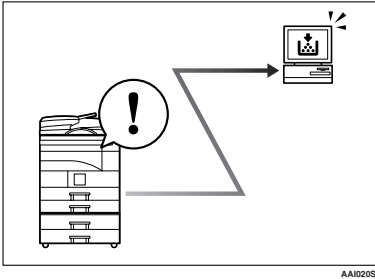

You can monitor machine status and change settings using a computer.

- Using SmartDeviceMonitor for Admin, SmartDeviceMonitor for Client, or a Web browser, you can use a computer to view the machine's status, such as to check on paper quantities, or misfeeds, etc. See *Network Guide*.
- You can use a Web browser to make network settings. See *Network Guide*.
- You can also use a Web browser to register and manage items such as user codes, fax numbers, and e-mail addresses in the Address Book. See the Web browser's Help.

 **Note**

- Monitoring and management using a Web browser are only available when the expansion board is installed.

TABLE OF CONTENTS

Manuals for This Machine	i
Machine Types	iii
What You Can Do with This Machine	iv
Copier, Facsimile, Printer, and Scanner Functions	iv
Paperless Fax Transmission	iv
Fax Transmission and Reception through the Internet	v
Using the Scanner in a Network Environment	v
Administrating the Machine (Security Functions)	v
Monitoring the Machine Using a Computer	vi
Copyrights and Trademarks	1
Trademarks	1
Information about Installed Software	2
How to Read This Manual	7
Name of Major Option	7
ENERGY STAR Program	8
1. Getting Started	
<hr/>	
Guide to Components	11
Options	13
External Options	13
Internal Options	14
Control Panel	15
Display	17
Reading the Display and Using Keys	17
2. Combined Function Operations	
<hr/>	
Changing Modes	19
Multi-Access	21
3. User Tools (System Settings)	
<hr/>	
User Tools Menu (System Settings)	23
Accessing User Tools (System Settings)	26
Changing Default Settings	26
Quitting User Tools	27
Settings You Can Change with User Tools	28
General Features	28
Tray Paper Settings	30
Timer Settings	32
Key Operator Tools	34
User Code (For machine with copier function only)	39
Registering a New User Code	39
Changing a User Code	40
Deleting a User Code	40
Displaying the Counter for Each User Code	41
Printing the Counter for Each User Code	42
Clearing the Counter	42

Address Book	43
Registering Destination Information	44
Registering Sender Information	44
User Code (MFP)	45
Registering a New User Code.....	45
Changing a User Code.....	46
Deleting a User Code	49
Displaying the Counter for Each User Code	52
Printing the Counter for Each User Code.....	53
Clearing the Counter	54
Fax Destination	55
Registering a Fax Destination	55
Changing a Registered Fax Destination	57
Deleting a Registered Fax Destination.....	60
E-mail Destination	64
Registering an E-mail Destination.....	64
Changing a Registered E-mail Destination	66
Deleting a Registered E-mail Destination	69
Registering Destinations to a Group	73
Registering a New Group.....	73
Registering a Destination to a Group	74
Deleting a Destination from a Group.....	75
Displaying the Destinations Registered in Groups.....	78
Changing a Group Name	79
Deleting a Group	81

4. Troubleshooting

If Your Machine Does Not Operate As You Want	83
✚ Clearing Misfeeds	85
Changing the Paper Size	88
Changing the Paper Size of the Paper Tray	88
Changing the Paper Size in the Optional Paper Tray Unit.....	90

5. Other Functions

Other Functions	93
Displaying the Total Counter	93
Changing the Language.....	93

6. Entering Text

Entering Text	95
Available Characters	95
Keys	95
How to Enter Text	95

7. Security

Security	97
Primary Security Functions	97
Extended Security Function	97
Operating Environment and Notes	99
Operating Environment	99
For Administrator.....	99
For User	99

8. Specifications

Main Unit	101
Options	104
Exposure Glass Cover	104
Auto Document Feeder (ADF)	104
Internal Tray 2 (1 bin tray).....	105
Paper Tray Unit (1-tray type).....	105
Paper Tray Unit (2-tray type).....	106
Copy Paper	107
Recommended Paper Sizes and Types.....	107
Unusable Paper	109
Paper Storage.....	110
INDEX	111

Copyrights and Trademarks

Trademarks

Microsoft[®], Windows[®] and Windows NT[®] are registered trademarks of Microsoft Corporation in the United States and/or other countries.

PostScript[®] and Acrobat[®] are a registered trademark of Adobe Systems Incorporated.

Bluetooth[™] is a trademark of the Bluetooth SIG, Inc. (Special Interest Group) and is used by RICOH Company Limited under license.

Copyright ©2001 Bluetooth SIG, Inc.

The Bluetooth Trademarks are owned by Bluetooth SIG, Inc. USA.

Other product names used herein are for identification purposes only and might be trademarks of their respective companies. We disclaim any and all rights in those marks.

The proper names of the Windows operating systems are as follows:

- The product name of Windows[®] 95 is Microsoft[®] Windows[®] 95
- The product name of Windows[®] 98 is Microsoft[®] Windows[®] 98
- The product name of Windows[®] Me is Microsoft[®] Windows[®] Millennium Edition (Windows Me)
- The product names of Windows[®] 2000 are as follows:
 - Microsoft[®] Windows[®] 2000 Professional
 - Microsoft[®] Windows[®] 2000 Server
 - Microsoft[®] Windows[®] 2000 Advanced Server
- The product names of Windows[®] XP are as follows:
 - Microsoft[®] Windows[®] XP Home Edition
 - Microsoft[®] Windows[®] XP Professional
- The product names of Windows Server[™] 2003 are as follows:
 - Microsoft[®] Windows Server[™] 2003 Standard Edition
 - Microsoft[®] Windows Server[™] 2003 Enterprise Edition
 - Microsoft[®] Windows Server[™] 2003 Web Edition
- The product names of Windows NT[®] 4.0 are as follows:
 - Microsoft[®] Windows NT[®] Workstation 4.0
 - Microsoft[®] Windows NT[®] Server 4.0

Information about Installed Software

expat

- The software including controller, etc. (hereinafter “software”) installed on this product uses the expat Version 1.95.2 (hereinafter “expat”) under the conditions mentioned below.
- The product manufacturer provides warranty and support to the software of the product including the expat, and the product manufacturer makes the initial developer and copyright holder of the expat, free from these obligations.
- Information relating to the expat is available at:
<http://expat.sourceforge.net/>

Copyright (c) 1998, 1999, 2000 Thai Open Source Software Centre, Ltd. and Clark Cooper.

Permission is hereby granted, free of charge, to any person obtaining a copy of this software and associated documentation files (the “Software”), to deal in the Software without restriction, including without limitation the rights to use, copy, modify, merge, publish, distribute, sublicense, and/or sell copies of the Software, and to permit persons to whom the Software is furnished to do so, subject to the following conditions:

The above copyright notice and this permission notice shall be included in all copies or substantial portions of the Software.

THE SOFTWARE IS PROVIDED “AS IS”, WITHOUT WARRANTY OF ANY KIND, EXPRESS OR IMPLIED, INCLUDING BUT NOT LIMITED TO THE WARRANTIES OF MERCHANTABILITY, FITNESS FOR A PARTICULAR PURPOSE AND NONINFRINGEMENT. IN NO EVENT SHALL THE AUTHORS OR COPYRIGHT HOLDERS BE LIABLE FOR ANY CLAIM, DAMAGES OR OTHER LIABILITY, WHETHER IN AN ACTION OF CONTRACT, TORT OR OTHERWISE, ARISING FROM, OUT OF OR IN CONNECTION WITH THE SOFTWARE OR THE USE OR OTHER DEALINGS IN THE SOFTWARE.

NetBSD

1. Copyright Notice of NetBSD

For all users to use this product:

This product contains NetBSD operating system:

For the most part, the software constituting the NetBSD operating system is not in the public domain; its authors retain their copyright.

The following text shows the copyright notice used for many of the NetBSD source code. For exact copyright notice applicable for each of the files/binaries, the source code tree must be consulted.

A full source code can be found at <http://www.netbsd.org/>.

Copyright © 1999, 2000 The NetBSD Foundation, Inc.

All rights reserved.

Redistribution and use in source and binary forms, with or without modification, are permitted provided that the following conditions are met:

- ① Redistributions of source code must retain the above copyright notice, this list of conditions and the following disclaimer.
- ② Redistributions in binary form must reproduce the above copyright notice, this list of conditions and the following disclaimer in the documentation and/or other materials provided with the distribution.
- ③ All advertising materials mentioning features or use of this software must display the following acknowledgment:
This product includes software developed by The NetBSD Foundation, Inc. and its contributors.
- ④ Neither the name of The NetBSD Foundation nor the names of its contributors may be used to endorse or promote products derived from this software without specific prior written permission.

THIS SOFTWARE IS PROVIDED BY THE NETBSD FOUNDATION, INC. AND CONTRIBUTORS "AS IS" AND ANY EXPRESS OR IMPLIED WARRANTIES, INCLUDING, BUT NOT LIMITED TO, THE IMPLIED WARRANTIES OF MERCHANTABILITY AND FITNESS FOR A PARTICULAR PURPOSE ARE DISCLAIMED. IN NO EVENT SHALL THE FOUNDATION OR CONTRIBUTORS BE LIABLE FOR ANY DIRECT, INDIRECT, INCIDENTAL, SPECIAL, EXEMPLARY, OR CONSEQUENTIAL DAMAGES (INCLUDING, BUT NOT LIMITED TO, PROCUREMENT OF SUBSTITUTE GOODS OR SERVICES; LOSS OF USE, DATA, OR PROFITS; OR BUSINESS INTERRUPTION) HOWEVER CAUSED AND ON ANY THEORY OF LIABILITY, WHETHER IN CONTRACT, STRICT LIABILITY, OR TORT (INCLUDING NEGLIGENCE OR OTHERWISE) ARISING IN ANY WAY OUT OF THE USE OF THIS SOFTWARE, EVEN IF ADVISED OF THE POSSIBILITY OF SUCH DAMAGE.

2. Authors Name List

All product names mentioned herein are trademarks of their respective owners. The following notices are required to satisfy the license terms of the software that we have mentioned in this document:

- This product includes software developed by the University of California, Berkeley and its contributors.
- This product includes software developed by Jonathan R. Stone for the NetBSD Project.
- This product includes software developed by the NetBSD Foundation, Inc. and its contributors.
- This product includes software developed by Manuel Bouyer.
- This product includes software developed by Charles Hannum.
- This product includes software developed by Charles M. Hannum.
- This product includes software developed by Christopher G. Demetriou.
- This product includes software developed by TooLs GmbH.
- This product includes software developed by Terrence R. Lambert.
- This product includes software developed by Adam Glass and Charles Hannum.
- This product includes software developed by Theo de Raadt.

- This product includes software developed by Jonathan Stone and Jason R. Thorpe for the NetBSD Project.
- This product includes software developed by the University of California, Lawrence Berkeley Laboratory and its contributors.
- This product includes software developed by Christos Zoulas.
- This product includes software developed by Christopher G. Demetriou for the NetBSD Project.
- This product includes software developed by Paul Kranenburg.
- This product includes software developed by Adam Glass.
- This product includes software developed by Jonathan Stone.
- This product includes software developed by Jonathan Stone for the NetBSD Project.
- This product includes software developed by Winning Strategies, Inc.
- This product includes software developed by Frank van der Linden for the NetBSD Project.
- This product includes software developed for the NetBSD Project by Frank van der Linden.
- This product includes software developed for the NetBSD Project by Jason R. Thorpe.
- The software was developed by the University of California, Berkeley.
- This product includes software developed by Chris Provenzano, the University of California, Berkeley, and contributors.

Sablotron

Sablotron (Version 0.82) Copyright (c) 2000 Ginger Alliance Ltd. All Rights Reserve

a) The application software installed on this product includes the Sablotron software Version 0.82 (hereinafter, "Sablotron 0.82"), with modifications made by the product manufacturer. The original code of the Sablotron 0.82 is provided by Ginger Alliance Ltd., the initial developer, and the modified code of the Sablotron 0.82 has been derived from such original code provided by Ginger Alliance Ltd.

b) The product manufacturer provides warranty and support to the application software of this product including the Sablotron 0.82 as modified, and the product manufacturer makes Ginger Alliance Ltd., the initial developer of the Sablotron 0.82, free from these obligations.

c) The Sablotron 0.82 and the modifications thereof are made available under the terms of Mozilla Public License Version 1.1 (hereinafter, "MPL 1.1"), and the application software of this product constitutes the "Larger Work" as defined in MPL 1.1. The application software of this product except for the Sablotron 0.82 as modified is licensed by the product manufacturer under separate agreement(s).

d) The source code of the modified code of the Sablotron 0.82 is available at: <http://support-download.com/services/device/sablot/notice082.html>.

e) The source code of the Sablotron software is available at: <http://www.ginger-all.com>.

f) MPL 1.1 is available at: <http://www.mozilla.org/MPL/MPL-1.1.html>.

JPEG LIBRARY

- The software installed on this product is based in part on the work of the Independent JPEG Group.

SASL

CMU libsasl

Tim Martin

Rob Earhart

Rob Siemborski

Copyright (c) 2001 Carnegie Mellon University. All rights reserved.

Redistribution and use in source and binary forms, with or without modification, are permitted provided that the following conditions are met:

- ① Redistributions of source code must retain the above copyright notice, this list of conditions and the following disclaimer.
- ② Redistributions in binary form must reproduce the above copyright notice, this list of conditions and the following disclaimer in the documentation and/or other materials provided with the distribution.
- ③ The name “Carnegie Mellon University” must not be used to endorse or promote products derived from this software without prior written permission. For permission or any other legal details, please contact:

Office of Technology Transfer
Carnegie Mellon University
5000 Forbes Avenue
Pittsburgh, PA 15213-3890
(412) 268-4387, fax: (412) 268-7395
tech-transfer@andrew.cmu.edu

- ④ Redistributions of any form whatsoever must retain the following acknowledgment:

“This product includes software developed by Computing Services at Carnegie Mellon University (<http://www.cmu.edu/computing/>).”

CARNEGIE MELLON UNIVERSITY DISCLAIMS ALL WARRANTIES WITH REGARD TO THIS SOFTWARE, INCLUDING ALL IMPLIED WARRANTIES OF MERCHANTABILITY AND FITNESS, IN NO EVENT SHALL CARNEGIE MELLON UNIVERSITY BE LIABLE FOR ANY SPECIAL, INDIRECT OR CONSEQUENTIAL DAMAGES OR ANY DAMAGES WHATSOEVER RESULTING FROM LOSS OF USE, DATA OR PROFITS, WHETHER IN AN ACTION OF CONTRACT, NEGLIGENCE OR OTHER TORTIOUS ACTION, ARISING OUT OF OR IN CONNECTION WITH THE USE OR PERFORMANCE OF THIS SOFTWARE.

MD4

Copyright (C) 1990-2, RSA Data Security, Inc. All rights reserved.

License to copy and use this software is granted provided that it is identified as the "RSA Data Security, Inc. MD4 Message-Digest Algorithm" in all material mentioning or referencing this software or this function.

License is also granted to make and use derivative works provided that such works are identified as "derived from the RSA Data Security, Inc. MD4 Message-Digest Algorithm" in all material mentioning or referencing the derived work.

RSA Data Security, Inc. makes no representations concerning either the merchantability of this software or the suitability of this software for any particular purpose. It is provided "as is" without express or implied warranty of any kind.

These notices must be retained in any copies of any part of this documentation and/or software.

MD5

Copyright (C) 1991-2, RSA Data Security, Inc. Created 1991. All rights reserved.

License to copy and use this software is granted provided that it is identified as the "RSA Data Security, Inc. MD5 Message-Digest Algorithm" in all material mentioning or referencing this software or this function.

License is also granted to make and use derivative works provided that such works are identified as "derived from the RSA Data Security, Inc. MD5 Message-Digest Algorithm" in all material mentioning or referencing the derived work.

RSA Data Security, Inc. makes no representations concerning either the merchantability of this software or the suitability of this software for any particular purpose. It is provided "as is" without express or implied warranty of any kind.

These notices must be retained in any copies of any part of this documentation and/or software.

How to Read This Manual

Symbols

The following set of symbols is used in this manual.

WARNING:

This symbol indicates a potentially hazardous situation that might result in death or serious injury when you misuse the machine without following the instructions under this symbol. Be sure to read the instructions, all of which are described in the Safety Information section.

CAUTION:

This symbol indicates a potentially hazardous situation that might result in minor or moderate injury or property damage that does not involve personal injury when you misuse the machine without following the instructions under this symbol. Be sure to read the instructions, all of which are described in the Safety Information section.

* The statements above are notes for your safety.

Important

If this instruction is not followed, paper might be misfed, originals might be damaged, or data might be lost. Be sure to read this.

Preparation

This symbol indicates information or preparations required prior to operating.

Note

This symbol indicates precautions for operation, or actions to take after abnormal operation.

Limitation

This symbol indicates numerical limits, functions that cannot be used together, or conditions in which a particular function cannot be used.

Reference

This symbol indicates a reference.

[]

Keys that appear on the machine's display panel.

[]

Keys built into the machine's control panel.

Name of Major Option

Major option of this machine is referred to as follow in this manual:

- Auto Document Feeder → ADF

ENERGY STAR Program

 <p>ENERGY STAR®</p>	<p>As an ENERGY STAR Partner, we have determined that this machine model meets the ENERGY STAR Guidelines for energy efficiency.</p>
---	--

The ENERGY STAR Guidelines intend to establish an international energy-saving system for developing and introducing energy-efficient office equipment to deal with environmental issues, such as global warming.

When a product meets the ENERGY STAR Guidelines for energy efficiency, the Partner shall place the ENERGY STAR logo onto the machine model.

This product was designed to reduce the environmental impact associated with office equipment by means of energy-saving features, such as Low-power mode.

- **Low Power mode**
This product automatically lowers its power consumption 1 minute after finishing the last copy or print job. Fax reception and printing is still possible in Low Power mode, but to make copies, you have to press the operation switch first.
For details about how to change the interval between last job and Low Power mode, see p.32 “Energy Saver Timer”.
- **Off mode (Copier only)**
To conserve energy, this product automatically turns off 1 minute after finishing the last copy or print job. In this manual, the Off mode is called the Auto Off mode.
For details about how to change the interval between last job and Auto Off mode, see p.32 “Auto Off Timer”.
- **Sleep mode (Fax, printer, or scanner installed)**
If there is a fax, printer, or scanner unit installed, this product automatically lowers its power consumption even further 1 minute after finishing the last copy or print job. Fax reception and printing is still possible in Sleep mode, but to make copies, you have to press the operation switch first.
For details about how to change the interval between last job and Sleep mode, see p.32 “Auto Off Timer”.

 **Note**

- If you want to operate this product while it is in either of these modes, do one of the following:
 - Turn on the operation switch.
 - Place originals in the ADF.
 - Lift the exposure glass cover or ADF.

Specifications

		Copier only	Fax, printer, or scanner installed
Low Power mode	Power consumption	40 W	45 W
	Default interval	1 minute	1 minute
	Recovery time	Less than 10 seconds	Less than 10 seconds
Sleep mode	Power consumption	-	Less than 10 W
	Default interval	-	1 minute
	Recovery time	-	Less than 10 seconds
Off mode	Power consumption	less than 1 W	-
	Default interval	1 minute	-
	Recovery time	Less than 10 seconds	-

Recycled Paper

In accordance with the ENERGY STAR Program, we recommend use of recycled paper which is environmentally friendly. Please contact your sales representative for recommended paper.

1. Getting Started

Guide to Components

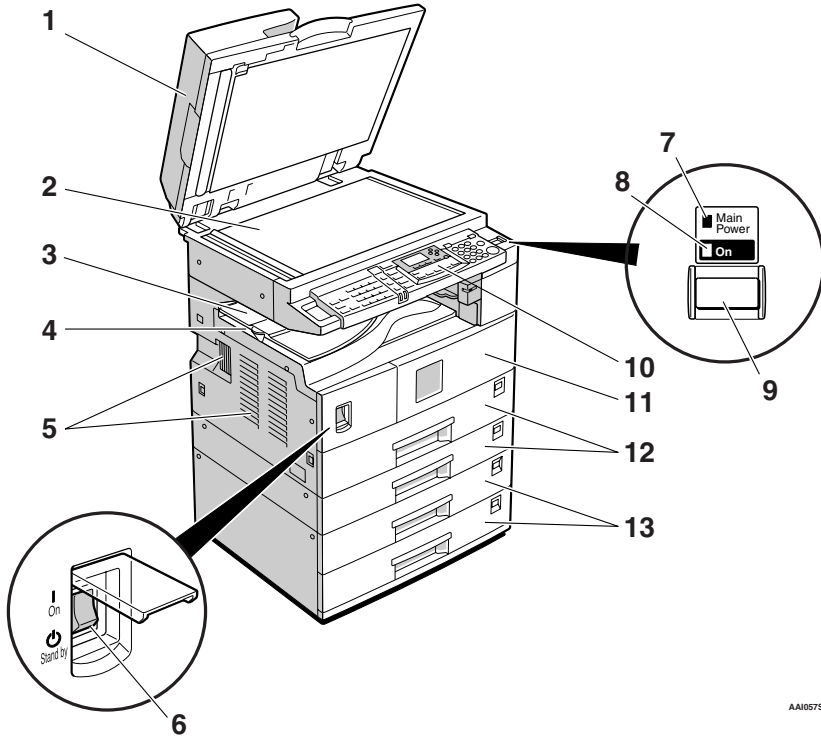

1. Exposure glass cover (optional) or ADF (optional).

See p.13 "External Options"

2. Exposure glass

Place originals here face down.

3. Internal tray 2 (1 bin tray) (optional)

The indicator lights when paper is delivered to internal tray 2. If internal tray 2 has not been installed, the indicator does not light. See p.13 "External Options".

Note

- When paper larger than A3 is delivered, release the 1 bin tray stand, and then pull out the tray extension.

4. Internal tray

Copied, printed paper or fax messages are delivered here.

5. Ventilation holes

Prevents overheating. Do not obstruct the ventilation holes by placing objects near them or leaning things against them. If the machine overheats, a fault might occur.

AA10575

6. Main power switch

If the machine does not operate after turning on the operation switch, check the main power switch is turned on. If it is off, turn it on.

7. Main power indicator

Lights when the main power switch is turned on, and goes off when the switch is turned off.

8. On indicator

Lights when the operation switch is turned on, and goes off when the switch is turned off.

9. Operation switch

Press to turn the power on (the On indicator lights). To turn the power off, press again (the On indicator goes off).

10. Control panel

See p.15 "Control Panel".

11. Front cover

Open to access the inside of the machine.

12. Paper tray

Load paper here.

13. Paper tray unit (optional)

See p.13 "External Options".

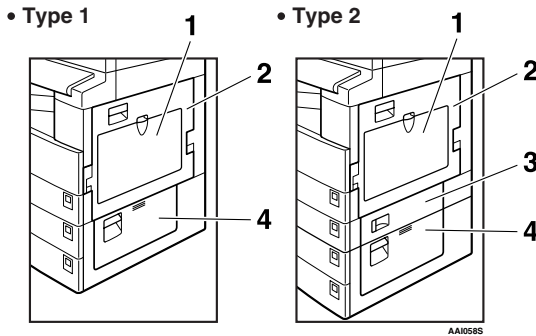

1. Bypass tray

Use to copy onto OHP transparencies, adhesive labels, translucent paper, envelopes, and custom size paper.

2. Right cover

Open this cover to remove jammed paper fed from the paper tray.

3. Lower right cover (Type 2 only)

Open this cover to remove jammed paper fed from the paper tray unit.

4. Lower right cover

Open this cover to remove jammed paper from the optional paper tray unit.

Options

External Options

1

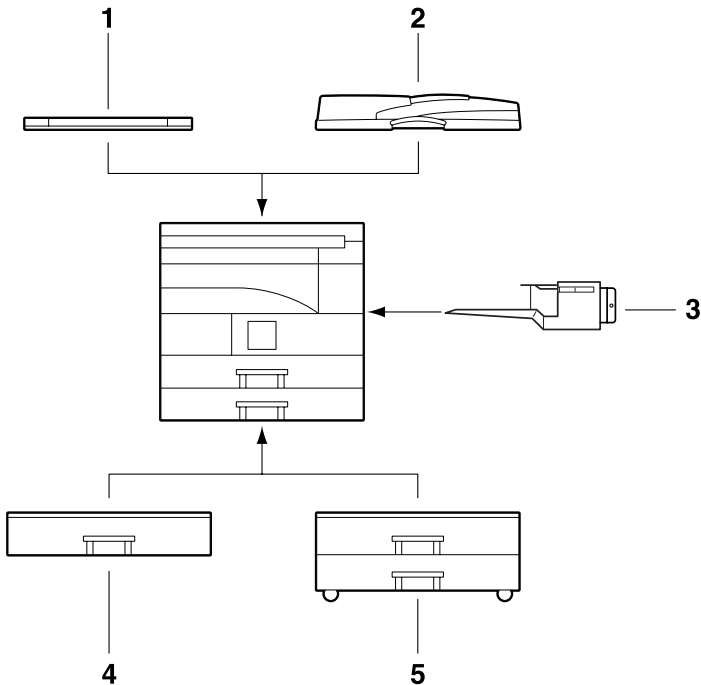

AAI0595

1. Exposure glass cover

Lower this cover over originals.

2. ADF

Place stacks of originals here. They will feed in automatically.

3. Internal tray 2 (1 bin tray)

If you select this as the output tray, copied paper is delivered here face down.

Note

- Internal tray 2 can only be installed for Type 2 (MFP).

4. Paper tray unit (1-tray type)

Holds 500 sheets.

5. Paper tray unit (2-tray type)

Holds up to 1,000 sheets of paper. Each paper tray holds 500 sheets.

Internal Options

1

- ① Fax unit
Allows you to use the facsimile function.
- ② Printer/Scanner unit
Allows you to use the printer and scanner functions.
- ③ Parallel port IEEE 1284 interface board
Allows you to connect to an IEEE 1284 cable.
- ④ IEEE 1394 interface board
Allows you to connect to an IEEE 1394 cable.
- ⑤ IEEE 802.11b wireless LAN board
Allows you to install a wireless LAN interface.
- ⑥ Bluetooth unit
Allows you to expand the interface.
- ⑦ PostScript3 unit
Allows you to use PostScript3.



Note

- You cannot install two or more of the options below: Parallel port IEEE 1284 interface board, IEEE 1394 interface board, IEEE 802.11b wireless LAN board, Bluetooth unit.

Control Panel

This illustration shows the control panel of the machine with options fully installed.

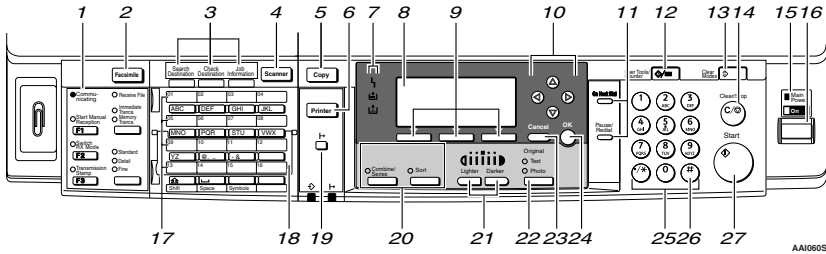

1. Fax function keys

🔍 Reference

Facsimile Reference <Basic Features> and *Facsimile Reference <Advanced Features>*

2. **[Facsimile]** key

Press to activate the facsimile function.

3. Scanner/Fax function keys

🔍 Reference

Scanner Reference, Facsimile Reference <Basic Features>, and *Facsimile Reference <Advanced Features>*

4. **[Scanner]** key

Press to activate the scanner function.

5. **[Copy]** key

Press to activate the copy function.

6. **[Printer]** key

Press to activate the printer function.

7. Indicators

Display errors and machine status.

🔴: Error indicator. See *Network Guide* and see p.85 "🔴 Clearing Misfeeds".

📄: Load Paper indicator. See *Copy Reference*.

🖨️: Add Toner indicator. See *Copy Reference*.

8. Display

Displays operation status and messages.

9. Selection keys

Correspond to items on the display. Press to select the corresponding item.

10. Scroll keys

Press to select an item.

⬆️: scroll upward

⬇️: scroll downward

➡️: scroll right

⬅️: scroll left

11. Dial function keys

🔍 Reference

Facsimile Reference <Basic Features> and *Facsimile Reference <Advanced Features>*

12. **[User Tools/Counter]** key

- User Tools
Press to change default or operation parameters according to requirement. See p.26 "Accessing User Tools (System Settings)".
- Counter
Press to check or print the counter value. See p.93 "Other Functions".

13. **[Clear Modes]** key

Press to clear the current settings.

14. [Clear/Stop] key

- Clear:
Clears an entered numeric value.
- Stop:
Stops a job in progress, such as scanning, faxing, or printing.

15. Main power indicator and On indicator

The main power indicator lights when the main power switch is turned on. The On indicator lights when the operation switch is on.

Important

- Do not turn off the main power switch while the On indicator is lit or blinking. Doing so may damage the memory.

16. Operation switch

Press to turn the power on. The On indicator lights. To turn the power off, press again.

17. Quick Dial keys

Press to select the registered destination at a single touch, or to enter letters and symbols.

18. Quick Dial Flip Plate

Flip this plate down to access Quick Dial keys 01 through 16; flip it up to access keys 17 through 32.

19. [On Line] key**Reference**

Printer Reference 1 and Printer Reference 2

20. Copier function keys**Reference**

Copy Reference

21. [Lighter] and [Darker] keys

Press to change the image density setting. Select the image density in five increments, Lighter to Darker.

22. [Original Type] key

Press to select the original type registered in [Original Type 1 (Text)] or [Original Type 2 (Photo)]. When the original type is selected, the corresponding indicator lights.

23. [Cancel] key

Press to cancel an operation or return to the previous display.

24. [OK] key

Press to set a selected item or an entered numeric value.

25. Number keys

Press to enter numeric values.

26. [#] key

Press to set a selected item or an entered numeric value.

27. [Start] key

Press to start copying, printing, or scanning or sending.

Display

The display panel shows machine status, error messages, and function menus.

Important

- A force or impact of more than 30 N (about 3 kgf) will damage the display. The copy display is set as the default screen when the machine is turned on.

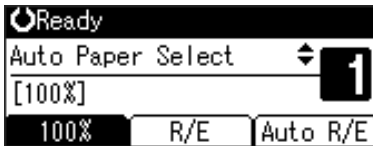

When you select or specify an item on the display, it is highlighted like **Auto R/E**.

Reading the Display and Using Keys

This section explains how to read the display and use the Selection keys.

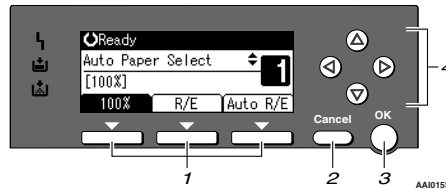

1. Selection keys

Correspond to items at the bottom line on the display.

Example: The Copy display

- When the instruction “press **[100%]**” appears in this manual, press the left selection key.
- When the instruction “press **[R/E]**” appears in this manual, press the centre selection key.
- When the instruction “press **[Auto R/E]**” appears in this manual, press the right selection key.

2. [Cancel] key

Press to cancel an operation or return to the previous display.

3. [OK] key

Press to set a selected item or an entered numeric value.

4. Scroll keys

Press to move the cursor in each direction, step by step.

When the **[▲]**, **[▼]**, **[◀]**, or **[▶]** key appears in this manual, press the scroll key of the same direction.

Common key operations

The following keys are common to all screens:

1

◆ Key list

[Cancel]	Deletes a selected function or entered values, and then the previous display returns.
[Exit]	The previous display returns.
[Stop]	Stops a job in progress.
[Yes]	Acknowledges a selected function or an entered values.
[Stop]	Cancels a selected function or entered values, and then the previous display returns.

2. Combined Function Operations

Changing Modes

Note

- ❑ You cannot switch modes in any of the following situations:
 - When scanning a fax message for transmission
 - During immediate transmission
 - When accessing User Tools
 - During On hook dialing for fax transmission
 - While scanning an original
- ❑ The copying screen is displayed as default when the power is turned on. You can change this default setting. See p.28 “Function Priority”.

Facsimile

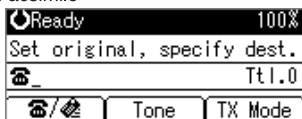

Scanner

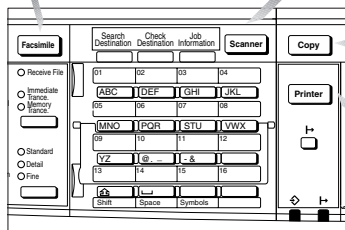
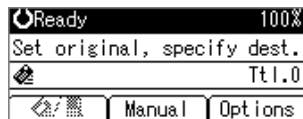

Copier

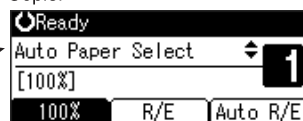

Printer



AAI061S

 **System Reset**

The machine returns automatically to its initial condition when the job is finished, after a certain period of time has elapsed. This function is called “System Reset”.

 **Note**

You can change the System Reset time. See p.32 “System Auto Reset Timer”.



Multi-Access

You can carry out another job using a different function while the current job is being performed. Performing multiple functions simultaneously like this is called “Multi-accessing”.

This allows you to handle jobs efficiently, regardless of how the machine is being used. For example:

- You can make copies while receiving fax data.
- While printing, you can make operations for copying.

Note

- See p.28 “Print Priority” for setting function priority. As default, **[Display mode]** is set to first priority.
- You can specify the output tray where documents are delivered. For details about how to specify the output tray for each function, see the following descriptions:
 - p.29 “Output: Copier (copier)”
 - p.29 “Output: Facsimile (facsimile)”
 - p.29 “Output: Printer (printer)”

Function compatibility

The chart shows function compatibility when print priority is set to “Interleave”. See p.28 “Print Priority”.

Mode after you select		Copy		Facsimile						Printer		Scanner		
				Transmission			Reception			Receive Data	Print	Using the control panel	Scanning	
														Using the control panel
Mode before you select		Using the control panel	Copying	Transmission Operation	Scanning An Original for Memory Transmission	Memory Transmission	Immediate Transmission	Memory Reception	Printing Received Data	Receive Data	Print	Using the control panel	Scanning	
Copy	Using the control panel	×	×	●	●	○	●	○	○	○	○	●	●	
	Copying	×	×	●	● ^{*1}	○	● ^{*1}	○	○	○	○	●	● ^{*1}	
Facsimile	Transmission Operation	●	●	×	×	○	×	○	○	○	○	●	●	
	Transmission	Scanning An Original for Memory Transmission	×	×	×	×	○	×	○	○	○	○	×	×
		Memory Transmission	○	○	○	○	×	×	×	○	○	○	○	○
		Immediate Transmission	×	×	×	×	×	×	×	○	○	○	×	×
	Reception	Memory Reception	○	○	○	○	×	×	×	○	○	○	○	○
Printing Received Data		○	○	○	○	○ ^{*2}	○ ^{*2}	○ ^{*2}	×	○	○	○	○	
Printer	Receive Data	○	○	○	○	○	○	○	○	△	△	○	○	
	Printing	○	○	○	○	○	○	○	○	○	△	○	○	
Scanner	Using the control panel	●	●	●	●	○	●	○	○	○	○	×	×	
	Scanning	●	● ^{*1}	●	● ^{*1}	○	● ^{*1}	○	○	○	○	×	×	

○...means that these functions can be used together.

●...means that you can interrupt the current job with Function keys to proceed to a subsequent job.

△...means that another job will automatically start after the current job is finished.

×...means that you must manually start another job after the current job is finished (i.e., these functions cannot be used together).

^{*1} You can scan a document once the preceding job documents are all scanned.

^{*2} During parallel reception, any subsequent job is suspended until reception is completed.

3. User Tools (System Settings)

User Tools Menu (System Settings)

Reference









For details about Interface Settings and File Transfer, see *Network Guide*.

For details about parallel interface, see *Printer Reference 2*.

❖ General Features (See p.28 “General Features”.)

	Default (MFP)	Default (Copier only)
Panel Tone		On
Copy Count Display		Up
Function Priority	Copier	
Print Priority	Display mode	
Output: Copier	Internal tray 1	
Output: Facsimile	Internal tray 2	
Output: Printer	Internal tray 1	
Display Contrast		Centre
Key Repeat		On
Measurement Unit		mm

❖ Tray Paper Settings (See p.30 “Tray Paper Settings”.)

	Default (MFP)	Default (Copier only)
Tray Paper Size:Tray 1	Metric version: 8 ¹ / ₂ " × 11" 	
	Inch version: A4 	
Tray Paper Size:Tray 2	Metric version: A5  (Type 1), 8 ¹ / ₂ " × 11"  (Type 2)	
	Inch version: A5  (Type 1), A4  (Type 2)	
Tray Paper Size:Tray 3		A5 
Tray Paper Size:Tray 4 (Type 2 or 3 only)		A5 
Paper Type: Bypass tray		Thick Paper
Paper Type: Tray 1	No Display (Plain Paper)/APS On	
Paper Type: Tray 2	No Display (Plain Paper)/APS On	

	Default (MFP)	Default (Copier only)
Paper Type: Tray 3	No Display (Plain Paper)/APS On	
Paper Type: Tray 4	No Display (Plain Paper)/APS On	
Ppr Tray Priority: Copier	Tray 1	
Ppr Tray Priority: Printer	Tray 1	
Ppr Tray Priority: Fax	Tray 1	

3

❖ **Timer Settings (See p.32 “Timer Settings”).**

	Default (MFP)	Default (Copier only)
Auto Off Timer	1 min.	
Energy Saver Timer	1 min.	
System Auto Reset Timer	60 sec.	
Copier Auto Reset Timer	60 sec.	
Facsimile Auto Reset Timer	30 sec.	
Scanner Auto Reset Timer	60 sec.	
Set Date	—	
Set Time	—	

❖ **Interface Settings**

- For details about network settings, see *Network Guide*.
- For details about parallel interface, see *Printer Reference 2*.

❖ **File Transfer**

See *Network Guide*.

◆ **Key Operator Tools (See p.34 “Key Operator Tools”.)**

		Default (MFP)	Default (Copier only)
User Code Management	Copier	<i>Off</i>	<i>Off</i>
	Facsimile	<i>Off</i>	
	Scanner	<i>Off</i>	
	Printer	<i>Auto Program</i>	
Key Counter Management		<i>All Off</i>	<i>Off</i>
Key Operator Code		<i>Off</i>	
Extended Security		<i>Off</i>	
Display/Print Counter		—	
Counter per User Code	Display	<i>Copier Counter</i>	—
	Print	<i>All User Codes</i>	—
	Clear	<i>All User Codes</i>	—
Address Book Management	Program/Change	—	
	Delete	—	
Prgm./Change/Delete Group	Program/Change	—	
	Delete	—	
Program/Change User Code	Program		—
	Change		—
	Delete		—
Address Book:Print List	Destination List	—	
	Group Destination List	—	
	Quick Dial Label	—	
AOF (Always On)		<i>On</i>	

Accessing User Tools (System Settings)

This section is for key operators in charge of this machine.

User Tools allow you to change or set defaults.

Note

- ❑ Operations for system settings differ from normal operations. Always quit User Tools when you have finished. See p.27 “Quitting User Tools”.
- ❑ Any changes you make with User Tools remain in effect even if the main power switch or operation switch is turned off, or the **[Clear Modes]** key is pressed.

Changing Default Settings

Note

- ❑ If a key operator code is already set, the key operator code entry display appears. Enter the key operator code, and then press the **[OK]** key. See p.34 “Key Operator Code”.

1 Press the **[User Tools/Counter]** key.

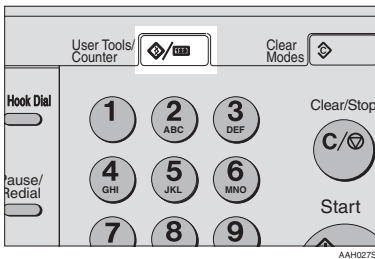

2 Select **[System Settings]** using **[▲]** or **[▼]**, and then press the **[OK]** key.



3 Select the menu using **[▲]** or **[▼]**, and then press the **[OK]** key.

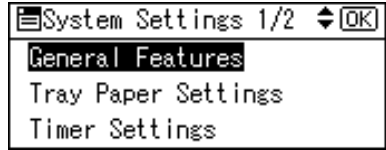

Reference

p.23 “User Tools Menu (System Settings)”.

4 Select the item using **[▲]** or **[▼]**, and then press the **[OK]** key.

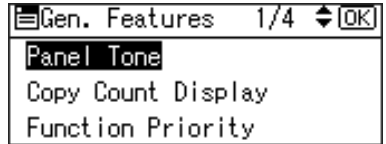

5 Change settings by following instructions on the display, and then press the **[OK]** key.

Note

- ❑ To cancel changes made to settings and return to the initial display, press the **[User Tools/Counter]** key.

Quitting User Tools

- 1 Press the **[User Tools/Counter]** key.

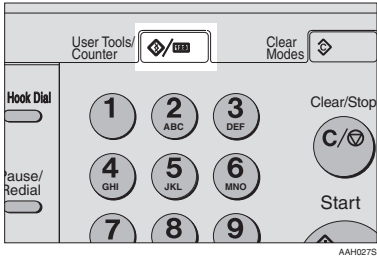

Settings You Can Change with User Tools

Reference

To access User Tools, see p.26 “Accessing User Tools (System Settings)”.

General Features

◆ Panel Tone

The beeper (key tone) sounds when a key is pressed.

Note

Default: *On*

◆ Copy Count Display

The copy counter can be set to show the number of copies made (count up), or the number of copies yet to be made (count down).

Note

Default: *Up (count up)*

◆ Function Priority

You can specify the mode to be displayed immediately after the operation switch is turned on, or when System Reset mode is turned on.

Note

Default: *Copier*

◆ Print Priority

Set the print priority for each mode.

Reference

p.21 “Multi-Access”

Note

Default: *Display mode*

When **[Interleave]** is selected, the current print job will be interrupted after a maximum of five sheets.

When the optional Internal tray 2 is installed on the machine, you can specify an output tray for document. For details about how to specify an output tray for each function, see the following sections:

- p.29 “Output: Copier (copier)”
- p.29 “Output: Facsimile (facsimile)”
- p.29 “Output: Printer (printer)”

❖ Output: Copier (copier)

You can specify a tray to which documents are delivered.

 Note

Default: *Internal tray 1*

❖ Output: Facsimile (facsimile)

You can specify a tray to which documents are delivered.

 Note

Default: *Internal tray 2*

❖ Output: Printer (printer)

You can specify a tray to which documents are delivered.

 Note

Default: *Internal tray 1*

The output trays set on the printer driver have priority over the output tray specified above.

❖ Display Contrast

You can adjust the brightness of the display.

❖ Key Repeat

You can select whether or not to use the key repeat function.

 Note

Default: *On*

❖ Measurement Unit

You can switch the measurement between “mm” and “inch”.

 Note

Default: *mm*

Output tray settings

 Limitation

You cannot use the Internal tray 2 as the output tray when copying from the bypass tray.

Tray Paper Settings

◆ Tray Paper Size:Tray 1–4

Select the size of the paper loaded in the paper tray.

- Type 1
 - The paper sizes you can set for Tray 1 are as follows:
A3☐, B4JIS (Japanese Industrial Standard)☐, A4☐☐, B5JIS☐☐, A5☐, 11" × 17"☐, 8¹/₂" × 14"☐, 8¹/₂" × 13"☐, 8¹/₄" × 14"☐, 8¹/₄" × 13"☐, 8" × 13"☐, 8¹/₂" × 11"☐☐, 7¹/₄" × 10¹/₂"☐☐, 5¹/₂" × 8¹/₂"☐, 8K☐, 16K☐☐
 - The paper sizes you can set for Tray 2, 3 are as follows:
A3☐, B4JIS☐, A4☐☐, B5JIS☐☐, A5☐, 11" × 17"☐, 8¹/₂" × 14"☐, 8¹/₂" × 13"☐, 8¹/₄" × 14"☐, 8¹/₄" × 13"☐, 8" × 13"☐, 8¹/₂" × 11"☐☐, 7¹/₄" × 10¹/₂"☐☐, 5¹/₂" × 8¹/₂"☐, 8K☐, 16K☐☐
- Type 2
 - The paper sizes you can set for Tray 1, 2 are as follows:
A3☐, B4JIS (Japanese Industrial Standard)☐, A4☐☐, B5JIS☐☐, A5☐, 11" × 17"☐, 8¹/₂" × 14"☐, 8¹/₂" × 13"☐, 8¹/₄" × 14"☐, 8¹/₄" × 13"☐, 8" × 13"☐, 8¹/₂" × 11"☐☐, 7¹/₄" × 10¹/₂"☐☐, 5¹/₂" × 8¹/₂"☐, 8K☐, 16K☐☐
 - The paper sizes you can set for Tray 3, 4 are as follows:
A3☐, B4JIS☐, A4☐☐, B5JIS☐☐, A5☐, 11" × 17"☐, 8¹/₂" × 14"☐, 8¹/₂" × 13"☐, 8¹/₄" × 14"☐, 8¹/₄" × 13"☐, 8" × 13"☐, 8¹/₂" × 11"☐☐, 7¹/₄" × 10¹/₂"☐☐, 5¹/₂" × 8¹/₂"☐, 8K☐, 16K☐☐

🚫 Important

- ☐ If the specified paper size differs from the actual size of the paper loaded in the paper tray, a misfeed might occur because the correct paper size was not detected.

📝 Note

- ☐ Default:
 - Tray 1
 - Metric version: 8¹/₂" × 11"☐
 - Inch version: A4☐
 - Tray 2
 - Metric version: A5☐ (Type 1), 8¹/₂" × 11"☐ (Type 2)
 - Inch version: A5☐ (Type 1), A4☐ (Type 2)
 - Tray 3: A5☐
 - Tray 4 (Type 2 only): A5☐
- ☐ If the paper size set for the selector in the paper tray is different from the paper size for this setting, the paper size of the selector has priority.
- ☐ If you load paper of a size not indicated on the paper size selector in the paper tray, set the selector to "✖".

Reference

p.88 "Changing the Paper Size"

❖ Paper Type: Bypass tray

Set the display so you can see what type of paper is loaded in the bypass tray.

- The paper types you can set for the bypass tray are as follows:
 - recycled paper, special paper, colour paper, letterhead, prepunched paper, label paper, bond paper, thick paper, OHP, cardstock

Note

- Default: *Thick Paper*
- Paper types you can set in the bypass tray for machines with the copy function only are plain paper, thick paper and OHP.

❖ Paper Type: Tray 1– 4

Set the display so you can see what type of paper is loaded in each paper tray. The print function uses this information to automatically select the paper tray.

- The paper types you can set are as follows:
 - recycled paper, special paper, colour paper, letterhead, preprinted paper, prepunched paper, bond paper, cardstock

Note

- Default:
 - Paper Type: *No Display (Plain Paper)*
 - APS: *On*

❖ Paper Tray Priority: Copier (copier)

You can specify the tray to supply paper for output.

Note

- Default: *Tray 1*

❖ Paper Tray Priority: Facsimile (facsimile)

You can specify the tray to supply paper for output.

Note

- Default: *Tray 1*

❖ Paper Tray Priority: Printer (printer)

You can specify the tray to supply paper for output.

Note

- Default: *Tray 1*

Timer Settings

◆ Auto Off Timer

After a specified period has passed, following job completion, the machine automatically turns off, in order to conserve energy. This function is called "Auto Off".

The machine status after the Auto Off operation is referred to as "Off mode", or "Sleep mode". For the Auto Off Timer, specify the time to elapse before Auto Off.

Note

- Default: 1 min.
- The time can be set from 1 to 240 minutes, using the number keys.
- From "Off mode" or "Sleep mode", the machine is ready to use within 10 seconds.
- Auto Off may not work when error messages appear.

◆ Energy Saver Timer

The machine automatically enters Low Power mode automatically after a job is finished, and the selected time elapsed.

Note

- Default: 1 min.
- The time can be set from 1 to 240 minutes, using the number keys.
- Energy Saver may not work when error messages appear.
- The machine automatically prints any fax or printer data received while in Energy Saver mode.

◆ System Auto Reset Timer

The System Reset setting automatically switches the screen to that of the function set in Function Priority when no operations are in progress, or when an interrupted job is cleared. This setting determines the system reset interval. See p.28 "Function Priority".

Note

- Default: On, 60 sec.
- The time can be set from 10 to 999 seconds in 1 second increments, using the number keys.

◆ Copier Auto Reset Timer

Specify the time to elapse before copier modes reset.

 Note

- If **[Off]** is selected, the machine does not automatically switch to the user code entry screen.
- Default: *On, 60 sec.*
- The time can be set from 10 to 999 seconds, using the number keys.

◆ Facsimile Auto Reset Timer (facsimile)

Specify the time to elapse before the facsimile mode resets.

 Note

- Default: *30 sec.*
- The time can be set from 30 to 999 seconds, using the number keys.

◆ Scanner Auto Reset Timer (scanner)

Specifies the time to elapse before the scanner function resets.

 Note

- If **[Off]** is selected, the machine will not automatically switch to the user code entry screen.
- Default: *On, 60 sec.*
- The time can be set from 10 to 999 seconds, using the number keys.

◆ Set Date

Set the date for the machine's internal clock using the number keys.

◆ Set Time

Set the time for the machine's internal clock using the number keys.

 Note

- Enter the time using the number keys.
- When the summer time function is set, you cannot make the time setting if the current time falls on the transition time zone. Try to set the time again after a while, or contact your service representative.

Key Operator Tools

The key operator must set the following items. For settings or more information, contact the key operator.

It is recommended that the key operator program a key operator code when performing the settings. See p.34 “Key Operator Code”.

◆ User Code Management

Allows you to control who uses the machine by setting codes for users.

User codes must be registered for user code management. See p.45 “User Code (MFP)”.

Note

- Default: *Copier/Off, Facsimile/Off, Scanner/Off, Printer/Auto Program*
- By using **[Auto Program]** for the printer, you can keep a print log for each user code entered from the driver.

◆ Key Counter Management

Use the key counter to specify whether users are restricted or not.

Note

- Default: *Copier/Off, Facsimile/Off, Scanner/Off, Printer/Off*
- [Key Counter Management]** will only be displayed when the key counter is set.

◆ Key Operator Code

Specify whether or not to use passwords (max. eight digits) to control Key Operator Tools settings for key operator code.

Note

- Default: *Off*
- If you select **[On]**, enter the key operator code (max. eight digits) using the number keys, and then select **[On: Partial]** or **[On: All]** to set the access limit.
 - If you selected **[On: Partial]**
A key operator code is only required for the Timer Settings, Key Operator Tools for System Settings, and Key Operator Tools for Fax Features. **[Menu Protect]** can be set for **[Maintenance]** in Printer Features. If you set **[Menu Protect]**, you can set the key operator code for some Printer Features. See “Printer Features Parameters”, *Printer Reference 2*.
 - If you selected **[On: All]**
A key operator code is required to access all items in System Settings, Copier Features, Fax Features, Printer Features, and Scanner Features.
- If you select **[On: All]**, you must enter a key operator code to access the Key Operator Code display.

◆ Extended Security

Specify whether or not to use the security function.

Note

- Default : *Off*
- You have to set a 6-digit key operator code to enable Extended Security. See p.34 “Key Operator Code”.

Reference

For details about security, see p.97 “Security”.

◆ Display/Print Counter

Allows you to view and print the number of prints.

- Display/Print Counter
Displays the number of prints for each function (Total, Copier, Facsimile, Printer, and A3/DLT).
- Print Counter List
Prints out a list of the number of prints made under each function.
- To print the counter list
 - ① Press the **[User Tools/Counter]** key.

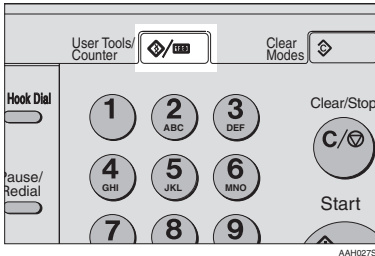

- ② Select **[System Settings]** using **[▲]** or **[▼]**, and then press the **[OK]** key.

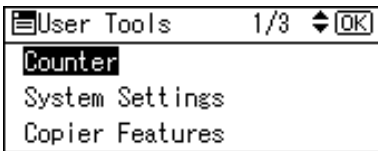

- ③ Select **[Key Operator Tools]** using **[▲]** or **[▼]**, and then press the **[OK]** key.

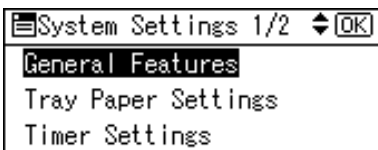

- ④ Select **[Display/Print Counter]** using **[▲]** or **[▼]**, and then press the **[OK]** key.

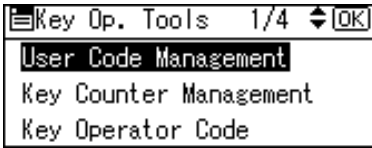

- ⑤ Press **[Print]**.

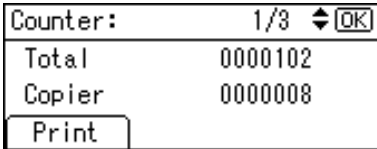

- ⑥ Press the **[Start]** key.

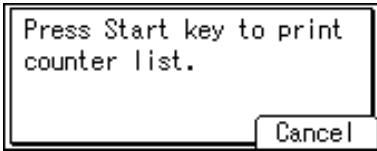

- ⑦ Press the **[User Tools/Counter]** key.

❖ Counter per User Code

Allows you to view and print the numbers of prints accessed with user codes, and to set those values to 0.

Note

- Press **[▲]** and **[▼]** to show all the numbers of prints.
- The number of prints may differ from the counter value shown in Display/Print Counter.
 - Print counter per user code
Prints the number of prints made under each user code.
 - Clear counter per user code
Sets the number of prints made under each user code to 0.
- Print list for each user code, see p.42 "Printing the Counter for Each User Code".
 - Print counter for all user codes
Prints the number of prints made under all user codes.
 - Clear counter for all user codes
Sets the number of prints made under all user codes to 0.

◆ Address Book Management

You can add, change, or delete user information in the Address Book, and facsimile/scanner functions destinations.

For details about these operations, see p.45 “User Code (MFP)”, p.55 “Fax Destination”, and p.64 “E-mail Destination”.

- **[Program/Change]**

This registers new user information, or registers and changes the items below:

- User (destination) name
- Destination
Facsimile number, International TX Mode, Label Insertion, e-mail address, sender's password, Program Group
- User code
User code, available functions
- Registration number

- **[Delete]**

Deletes a user information.

Note

- You can register up to 150 users.
- You can also register and manage data in the Address Book, using Smart-DeviceMonitor for Admin (printer option required).
- You can also register and manage data in the Address Book using a Web browser. See the Web browser's Help.

◆ Program/Change User Code (For machine with copier function only)

You can register, change, and delete user codes. For details about these operations, see p.39 “User Code (For machine with copier function only)”.

Note

- You can register up to 50 user codes.

◆ Address Book: Program/Change/Delete Group

You can register multiple users in a group.

This allows you to easily control registered users in each group.

For details about operations, see p.73 “Registering Destinations to a Group”.

- **[Program/Change]**

This registers new groups, or changes the group name or registration number.

- **[Delete]**

Deletes a group.

Note

- You can register up to 10 groups.
- You can also register and manage data in the Address Book, using Smart-DeviceMonitor for Admin (printer option required).
- You can also group users (destinations) using a Web browser. See the Web browser's Help.

❖ **Address Book: Print List**

You can print the destination list registered in the Address Book.

- Destination List
Prints the destination list registered in the Address Book.
- Group Destination List
Prints the group destination list registered in the Address Book.
- Quick Dial Label
To print the Quick Dial label:
 - ① Select the item using **▲** or **▼**, and then press the **OK** key.
 - ② Press the **Start** key.
The list prints out.

❖ **AOF (Always On)**

Specify whether or not to use Auto Off.

 **Note**

- Default: *On*

User Code (For machine with copier function only)

Register user codes to restrict copier functions to certain users, and check on their use of copier functions:

Registering a New User Code

- 1 Press the **[User Tools/Counter]** key.

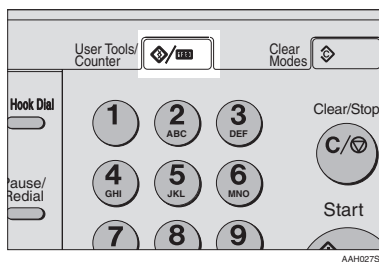

- 2 Select **[System Settings]** using **[▲]** or **[▼]**, and then press the **[OK]** key.



- 3 Select **[Key Operator Tools]** using **[▲]** or **[▼]**, and then press the **[OK]** key.

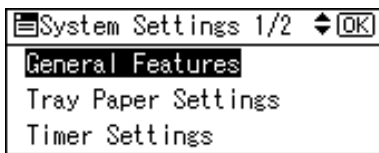

- 4 Select **[Program/Change User Code]** using **[▲]** or **[▼]**, and then press the **[OK]** key.

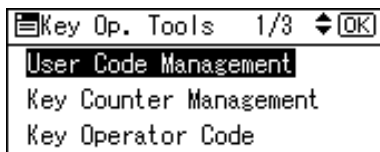

- 5 Select **[Program]** using **[▲]** or **[▼]**, and then press the **[OK]** key.

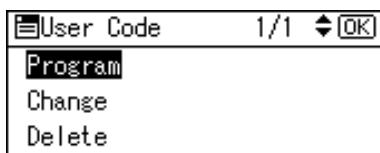

- 6 Enter the user code using the number keys, and then press the **[OK]** or **[#]** key.

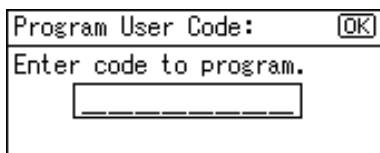

The "Programmed" message appears, and then the "User Code" display returns.

- 7 Press the **[User Tools/Counter]** key.

Changing a User Code

 **Note**

- Even if you change a user code, the counter value will not be cleared.

- 1** Press the **[User Tools/Counter]** key.
- 2** Select **[System Settings]** using **[▲]** or **[▼]**, and then press the **[OK]** key.
- 3** Select **[Key Operator Tools]** using **[▲]** or **[▼]**, and then press the **[OK]** key.
- 4** Select **[Program/Change User Code]** using **[▲]** or **[▼]**, and then press the **[OK]** key.
- 5** Select **[Change]** using **[▲]** or **[▼]**, and then press the **[OK]** key.
- 6** Enter the registered user code you want to change using the number keys, and then press the **[OK]** or **[#]** key.

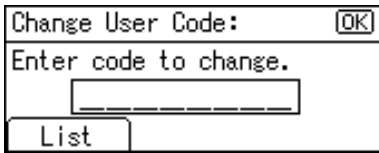

 **Note**

- When you select the user code from the User Code List, press **[List]**. Select the user code you want to change using **[▲]** or **[▼]**, and then press the **[OK]** key twice.

- 7** Enter the new user code using the number keys, and then press the **[OK]** or **[#]** key.

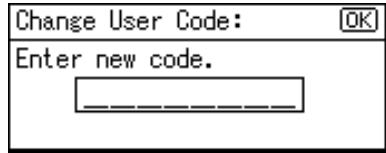

The “Programmed” message appears, and then the “User Code” display returns.

- 8** Press the **[User Tools/Counter]** key.

Deleting a User Code

 **Important**

- This operation also deletes user codes registered to multiple functions. User control via the deleted user code is no longer possible.

- 1** Press the **[User Tools/Counter]** key.
- 2** Select **[System Settings]** using **[▲]** or **[▼]**, and then press the **[OK]** key.
- 3** Select **[Key Operator Tools]** using **[▲]** or **[▼]**, and then press the **[OK]** key.
- 4** Select **[Program/Change User Code]** using **[▲]** or **[▼]**, and then press the **[OK]** key.
- 5** Select **[Delete]** using **[▲]** or **[▼]**, and then press the **[OK]** key.

- 6** Select [Per User Code] or [All User Codes] using [▲] or [▼], and then press the [OK] key.

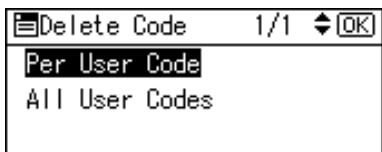

When selecting [All User Codes], a confirmation message appears. Press [Yes], and then proceed to step 9.

- 7** Enter the registered user code you want to delete using the number keys, and then press the [OK] or [#] key.

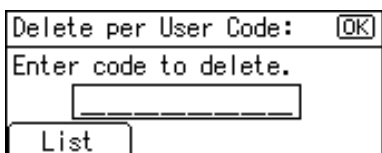

 **Note**

- When you select the user code from the User Code List, press [List]. Select the user codes you want to delete using [▶], and then press the [OK] key.

A confirmation message appears.

- 8** Press [Yes].

The "Deleted." message appears, and then the "User Code" display returns.

- 9** Press the [User Tools/Counter] key.

Displaying the Counter for Each User Code

You can check the counter for each user code.

- 1** Press the [User Tools/Counter] key.
- 2** Select [System Settings] using [▲] or [▼], and then press the [OK] key.
- 3** Select [Key Operator Tools] using [▲] or [▼], and then press the [OK] key.
- 4** Select [Counter per User Code] using [▲] or [▼], and then press the [OK] key.
- 5** Select [Display] using [▲] or [▼], and then press the [OK] key.

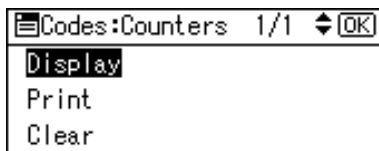

The counter for each user code will be displayed.

- 6** Press the [User Tools/Counter] key.

Printing the Counter for Each User Code

You can print out the counter for each user code.

- 1** Press the **[User Tools/Counter]** key.
- 2** Select **[System Settings]** using **[▲]** or **[▼]**, and then press the **[OK]** key.
- 3** Select **[Key Operator Tools]** using **[▲]** or **[▼]**, and then press the **[OK]** key.
- 4** Select **[Counter per User Code]** using **[▲]** or **[▼]**, and then press the **[OK]** key.
- 5** Select **[Print]** using **[▲]** or **[▼]** and then press the **[OK]** key.
- 6** Press the **[Start]** key.
The counter list prints out.
- 7** Press the **[User Tools/Counter]** key.

Clearing the Counter

- 1** Press the **[User Tools/Counter]** key.
- 2** Select **[System Settings]** using **[▲]** or **[▼]**, and then press the **[OK]** key.
- 3** Select **[Key Operator Tools]** using **[▲]** or **[▼]**, and then press the **[OK]** key.
- 4** Select **[Counter per User Code]** using **[▲]** or **[▼]**, and then press the **[OK]** key.
- 5** Select **[Clear]** using **[▲]** or **[▼]**, and then press the **[OK]** key.
A confirmation message appears.
- 6** Press **[Yes]**.
The "Counter has been cleared." message appears, and then the "Codes:Counters" display returns.
- 7** Press the **[User Tools/Counter]** key.

Address Book

Registering user information, such as fax numbers and e-mail addresses, in the Address Book allows you to manage them together.

Important

- ❑ Address Book data is stored in memory. It can be lost if there is some kind of memory failure. The manufacturer shall not be responsible for any damage resulting from data loss.

Note

- ❑ You can backup Address Book data using **[Address Management Tool]** in SmartDeviceMonitor for Admin. We recommend backing up data when using the Address Book.

Reference

For details about SmartDeviceMonitor for Admin and how to install it, see *Printer Reference 1*.

For operating instructions, see SmartDeviceMonitor for Admin Help.

You can register and manage the following items in the Address Book:

◆ To manage registered items

- User Code
Register user codes to restrict particular functions to certain users, and check their use of each function.

Reference

p.45 "User Code (MFP)"

- Sender's Password

Reference

p.44 "When using the scanner function"

p.44 "Registering Sender Information"

- Program Group
Use this to display the group the selected user (destination) belongs to.

You can group registered fax destinations and e-mail destinations to manage them better. For details about operations, see p.73 "Registering Destinations to a Group".

◆ Items to register

- User Name

Reference

p.44 "Registering the destination name"

p.44 "Registering Sender Information"

- Fax Settings

Reference

p.44 "When using the fax function"

- E-mail Settings

Reference

p.44 "When using the fax function"

p.44 "When using the scanner function"

p.44 "Registering Sender Information"

Registering Destination Information

❖ Registering the destination name

- **User Name**
Register the destination name. This is the basic information required for managing destinations.

Reference

p.45 "User Code (MFP)"

❖ When using the fax function

- **Fax Settings**
Register fax numbers in the Address Book. To send a fax, select the destination from the Destination List, so you can specify the fax number. When you set Label Insertion to **[On]**, the registered destination name, preceded by "To:", is printed at the top of the page when it is received at the other end.

Reference

p.55 "Fax Destination"

- **E-mail Settings**
Register e-mail addresses in the Address Book. To send an Internet Fax document, select the destination from the Destination List, so you can specify the e-mail address.

Reference

p.64 "E-mail Destination"

❖ When using the scanner function

- **E-mail**
Register e-mail addresses in the Address Book. To send scan files by e-mail, select the destination from the Destination List, so you can specify the e-mail address.

Reference

p.64 "E-mail Destination"

Registering Sender Information

❖ When using the scanner function

You can set Register as Sender to **[On]** for an e-mail address. If you do this, you can use it as the sender address when sending scan files by e-mail.

- **User Name**
Register the user name. This is useful when selecting the sender from the Destination List. Also, the user name automatically appears in the From field of the e-mail.

Reference

p.45 "User Code (MFP)"

- **E-mail Settings**
Register the e-mail address. You can use it as the sender address when sending scan files by e-mail using the scanner function. Also, the sender address automatically appears in the From field of the e-mail.

Reference

p.64 "E-mail Destination"

You can prevent misuse of sender name by setting sender's password on the e-mail address.

User Code (MFP)

Register user codes to restrict the following functions to certain users, and check their use of each function:

- Copier
- Facsimile
- Scanner
- Printer

Note

- ❑ The number of copies scanned in using the scanner function is counted for each user code. This allows you to check each user's usage.
- ❑ To automatically register the printer driver user code, select **[Auto Program]** for the printer in User Code Management. To use the user code set in User Tools, select **[On]**. Set the user codes registered in User Tools for the printer driver. See p.34 "User Code Management".

Reference

For details about setting user codes for the printer driver, see *Printer Reference 1* or the printer driver Help.

Important

- ❑ The functions associated with each user code are the same. If you change or delete user codes, management data and limits associated with that code become invalid.

Registering a New User Code

- 1 Press the **[User Tools/Counter]** key.

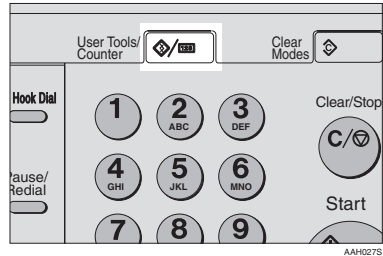

- 2 Select **[System Settings]** using **[▲]** or **[▼]**, and then press the **[OK]** key.

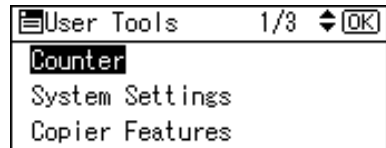

- 3 Select **[Key Operator Tools]** using **[▲]** or **[▼]**, and then press the **[OK]** key.

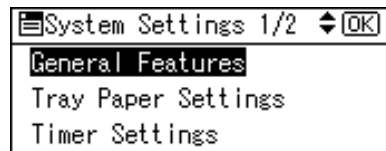

- 4 Select **[Address Book Management]** using **[▲]** or **[▼]**, and then press the **[OK]** key.

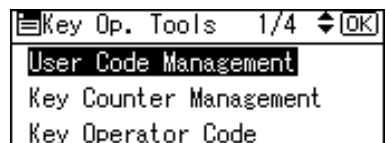

3

- 5** Select [Program/Change] using [▲] or [▼], and then press the [OK] key.

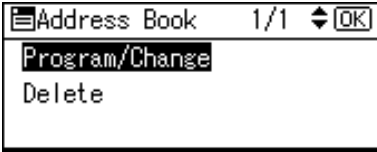

- 6** Enter the registration number you want to program using the number keys or the Quick Dial keys, and then press the [OK] key.

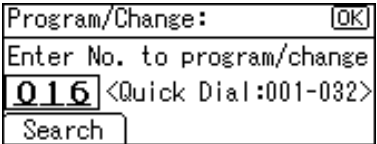

- 7** Enter the user (destination) name using the number keys and the Quick Dial keys, and then press the [OK] key.

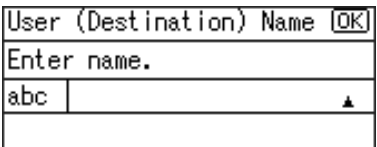

Reference

For details about entering text, see p.95 "Entering Text".

- 8** Press [UserCode].

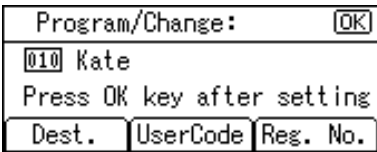

- 9** Enter the user code using the number keys, and then press the [OK] key.

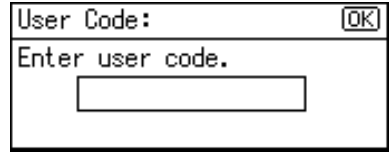

- 10** Select the function you want to set the user code for using [▶], and then press the [OK] key.

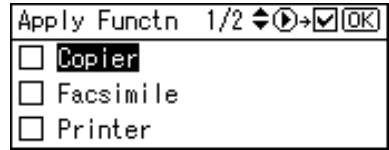

- 11** Press the [OK] key.

The "Programmed" message appears, and then the "Address Book" display returns.

- 12** Press the [User Tools/Counter] key.

Changing a User Code

- 1** Press the [User Tools/Counter] key.

- 2** Select [System Settings] using [▲] or [▼], and then press the [OK] key.

- 3** Select [Key Operator Tools] using [▲] or [▼], and then press the [OK] key.

- 4** Select [Address Book Management] using [▲] or [▼], and then press the [OK] key.

- 5** Select [Program/Change] using [▲] or [▼], and then press the [OK] key.

- 6** Enter the registration number of the destination you want to change using the number keys or the Quick Dial keys, and then press the **[OK]** key.

Searching to select a registered user code by name

- 1** Press **[Search]**.

Program/Change:	[OK]
Enter No. to program/change	
016 <Quick Dial:001-032>	
Search	

- 2** Select **[Search by Name]** using **[▲]** or **[▼]**, and then press the **[OK]** key.

Address Book	1/2	[OK]
Search by Name		
Display Destination List		
Search by Registration No.		

- 3** Enter the characters of the destination you want to change using the number keys and the Quick Dial keys, and then press the **[OK]** key.

Search by Name:	[OK]
Enter characters to search	
abc _	



Reference

For details about entering text, see p.95 "Entering Text".

- 4** Press the **[OK]** key.

Search by Name:	[OK]
Press OK to search	
A	

- 5** Select the destination you want to change using **[▲]** or **[▼]**, and then press the **[OK]** key.

Results:	1/1	[OK]
 001 Alien		
 004 Alex		
 005 AEH		

Searching to select a registered user code from Destination List

- 1** Press **[Search]**.
- 2** Select **[Display Destination List]** using **[▲]** or **[▼]**, and then press the **[OK]** key.
- 3** Select the destination you want to change using **[▲]** or **[▼]**, and then press the **[OK]** key.

Dest. List:	1/5	[OK]
 001 Alien		
 002 Brown		
 003 James		

Searching to select a registered user code by registration number

- 1** Press **[Search]**.
- 2** Select **[Search by Registration No.]** using **[▲]** or **[▼]**, and then press the **[OK]** key.

- Enter the registration number of the destination you want to change using the number keys, and then press the [OK] or [#] key.

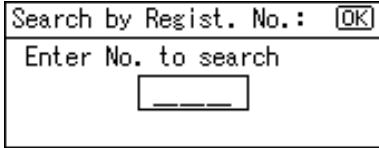

- Press the [OK] key.

Searching to select a registered user code by user code

- Press [Search].
- Select [Search by User Code] using [▲] or [▼], and then press the [OK] key.
- Enter the user code of the destination you want to change using the number keys, and then press the [OK] or [#] key.

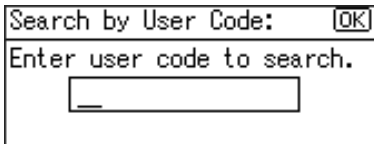

- Press the [OK] or [#] key.

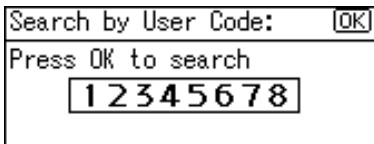

- Press the [OK] key.

Searching to select a registered user code by fax number

- Press [Search].
- Select [Search by Fax No.] using [▲] or [▼], and then press the [OK] key.
- Enter the fax number of the destination you want to change using the number keys, and then press the [OK] key.

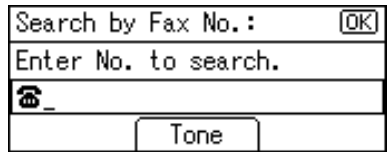

- Press the [OK] key.

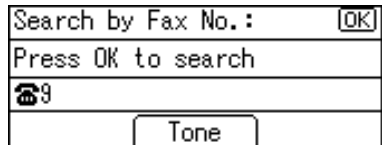

- Select the destination you want to change using [▲] or [▼], and then press the [OK] key.

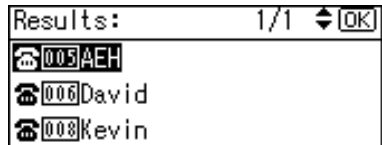

Searching to select a registered user code by e-mail address

- Press [Search].
- Select [Search by E-mail Address] using [▲] or [▼], and then press the [OK] key.

- 3** Enter the e-mail address of the destination you want to change using the number keys and the Quick Dial keys, and then press the **[OK]** key.

Search by E-mail Add. :	[OK]
Enter characters to search	
abc	_



Reference

For details about entering text, see p.95 “Entering Text”.

- 4** Press the **[OK]** key.

Search by E-mail Add. :	[OK]
Press OK to search	
a	

- 5** Select the destination you want to change using **[▲]** or **[▼]**, and then press the **[OK]** key.

Results:	1/1	[OK]
 001	Allen	
 003	James	
 004	Alex	

- 7** Press the **[OK]** key.

- 8** Press **[UserCode]**.

Program/Change :	[OK]
001	Allen
Press OK key after setting	
Dest.	UserCode Reg. No.

- 9** Enter the new user code using the number keys, and then press the **[OK]** key.

User Code :	[OK]
Enter user code.	
	1 2 3 4 5 6 7 8

- 10** Select the function you want to change the user code for using **[▶]**, and then press the **[OK]** key.

Apply Functn	1/2	[▶]	[OK]
<input type="checkbox"/>	Copier		
<input type="checkbox"/>	Facsimile		
<input type="checkbox"/>	Printer		

- 11** Press the **[OK]** key.

The “Programmed” message appears, and then the “Address Book” display returns.

- 12** Press the **[User Tools/Counter]** key.

Deleting a User Code

- 1** Press the **[User Tools/Counter]** key.

- 2** Select **[System Settings]** using **[▲]** or **[▼]**, and then press the **[OK]** key.

- 3** Select **[Key Operator Tools]** using **[▲]** or **[▼]**, and then press the **[OK]** key.

- 4** Select **[Address Book Management]** using **[▲]** or **[▼]**, and then press the **[OK]** key.

- 5** Select **[Program/Change]** using **[▲]** or **[▼]**, and then press the **[OK]** key.

- Enter the registration number you want to delete using the number keys or the Quick Dial keys, and then press the [OK] key.

Searching to select a registered user code by name

- Press [Search].
- Select [Search by Name] using [▲] or [▼], and then press the [OK] key.
- Enter the characters of the destination you want to delete using the number keys and the Quick Dial keys, and then press the [OK] key.

Search by Name:	[OK]
Enter characters to search	
abc	_ ▲

Reference

For details about entering text, see p.95 “Entering Text”.

- Press the [OK] key.

Search by Name:	[OK]
Press OK to search	
A	

- Select the destination you want to delete using [▲] or [▼], and then press the [OK] key.

Results:	1/1	▲ [OK]						
<table border="1"> <tr><td>☎001</td><td>Allen</td></tr> <tr><td>☎004</td><td>Alex</td></tr> <tr><td>☎005</td><td>AEH</td></tr> </table>			☎001	Allen	☎004	Alex	☎005	AEH
☎001	Allen							
☎004	Alex							
☎005	AEH							

Searching to select a registered user code from Destination List

- Press [Search].
- Select [Display Destination List] using [▲] or [▼], and then press the [OK] key.
- Select the destination you want to delete using [▲] or [▼], and then press the [OK] key.

Dest. List:	1/5	▲ [OK]						
<table border="1"> <tr><td>☎001</td><td>Allen</td></tr> <tr><td>☎002</td><td>Brown</td></tr> <tr><td>☎003</td><td>James</td></tr> </table>			☎001	Allen	☎002	Brown	☎003	James
☎001	Allen							
☎002	Brown							
☎003	James							

Searching to select a registered user code by registration number

- Press [Search].
- Select [Search by Registration No.] using [▲] or [▼], and then press the [OK] key.
- Enter the registration number of the destination you want to delete using the number keys, and then press the [OK] or [#] key.

Search by Regist. No.:	[OK]
Enter No. to search	
<input type="text"/>	

- Press the [OK] key.

Searching to select a registered user code by user code

- Press [Search].
- Select [Search by User Code] using [▲] or [▼], and then press the [OK] key.

- ③ Enter the user code of the destination you want delete using the number keys, and then press the [OK] or [#] key.

Search by User Code:	[OK]
Enter user code to search.	
	<input type="text"/>

- ④ Press the [OK] or [#] key.

Search by User Code:	[OK]
Press OK to search	
	<input type="text" value="12345678"/>

- ⑤ Press the [OK] key.

Searching to select a registered user code by fax number

- ① Press [Search].
- ② Select [Search by Fax No.] using [▲] or [▼], and then press the [OK] key.
- ③ Enter the fax number of the destination you want to delete using the number keys, and then press the [OK] key.

Search by Fax No.:	[OK]
Enter No. to search.	
	<input type="text" value=""/>
	<input type="button" value="Tone"/>

- ④ Press the [OK] key.

Search by Fax No.:	[OK]
Press OK to search	
	<input type="text" value="9"/>
	<input type="button" value="Tone"/>

- ⑤ Select the destination you want to delete using [▲] or [▼], and then press the [OK] key.

Results:	1/1	[OK]
	<input type="text" value="009AEH"/>	
	<input type="text" value="006David"/>	
	<input type="text" value="008Kevin"/>	

Searching to select a registered user code by e-mail address

- ① Press [Search].
- ② Select [Search by E-mail Address] using [▲] or [▼], and then press the [OK] key.
- ③ Enter the e-mail address of the destination you want to delete using the number keys and the Quick Dial keys, and then press the [OK] key.

Search by E-mail Add.:	[OK]
Enter characters to search	
	<input type="text" value="abc"/>

Reference

For details about entering text, see p.95 “Entering Text”.

- ④ Press the [OK] key.

Search by E-mail Add.:	[OK]
Press OK to search	
	<input type="text" value="a"/>

- 5 Select the destination you want to delete using **[▲]** or **[▼]**, and then press the **[OK]** key.



- 7 Press the **[OK]** key.

- 8 Press **[UserCode]**.

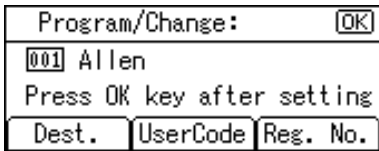

- 9 Press the **[Clear/Stop]** key, and then press the **[OK]** key.

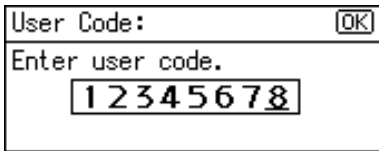

- 10 Press the **[OK]** key.

The “Programmed” message appears, and then the “Address Book” display returns.

- 11 Press the **[User Tools/Counter]** key.

Displaying the Counter for Each User Code

You can check the counter made under each function's user code.

- 1 Press the **[User Tools/Counter]** key.

- 2 Select **[System Settings]** using **[▲]** or **[▼]**, and then press the **[OK]** key.

- 3 Select **[Key Operator Tools]** using **[▲]** or **[▼]**, and then press the **[OK]** key.

- 4 Select **[Counter per User Code]** using **[▲]** or **[▼]**, and then press the **[OK]** key.

- 5 Select **[Display]** using **[▲]** or **[▼]**, and then press the **[OK]** key.

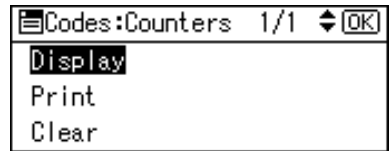

- 6 Select the function you want to display the counter for using **[▲]** or **[▼]**, and then press the **[OK]** key.

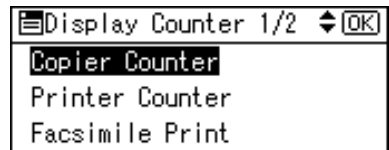

The counter for each user code will be displayed.

- 7 Press the **[User Tools/Counter]** key.

Printing the Counter for Each User Code

You can print out the counter made under each user code using [Print Counter], [Transmission Counter], or [Scanner Counter].

- 1 Press the [User Tools/Counter] key.
- 2 Select [System Settings] using [▲] or [▼], and then press the [OK] key.
- 3 Select [Key Operator Tools] using [▲] or [▼], and then press the [OK] key.
- 4 Select [Counter per User Code] using [▲] or [▼], and then press the [OK] key.
- 5 Select [Print] using [▲] or [▼], and then press the [OK] key.

To print the counter for all user codes

- 1 Select [All User Codes] using [▲] or [▼], and then press the [OK] key.

Print Counter 1/1 [OK]

All User Codes

Per User Code

- 2 Select the function you want to print the counter for using [▶], and then press the [OK] key.

Select: 1/1 [OK]

Print Counter

Transmission Counter

Scanner Counter

- 3 Press the [Start] key.
The counter list prints out.

To print the counter for each user code

- 1 Select [Per User Code] using [▲] or [▼], and then press the [OK] key.
- 2 Enter the user code you want to print the counter for, and then press the [OK] key.

Print Counter per Code: [OK]

Enter code to print counter

[List]

Note

- When you select the user code from the User Code List, press [List]. Select the user code you want to print the counter for using [▶], and then press the [OK] key.
- 3 Select the function you want to print the counter for using [▶], and then press the [OK] key.

Select: 1/1 [OK]

Print Counter

Transmission Counter

Scanner Counter

- 4 Press the [Start] key.
The counter list prints out.
- 6 Press the [User Tools/Counter] key.

Clearing the Counter

- 1** Press the **[User Tools/Counter]** key.
- 2** Select **[System Settings]** using **[▲]** or **[▼]**, and then press the **[OK]** key.
- 3** Select **[Key Operator Tools]** using **[▲]** or **[▼]**, and then press the **[OK]** key.
- 4** Select **[Counter per User Code]** using **[▲]** or **[▼]**, and then press the **[OK]** key.
- 5** Select **[Clear]** using **[▲]** or **[▼]**, and then press the **[OK]** key.

To clear the counter for all use codes

- 1** Select **[All User Codes]** using **[▲]** or **[▼]**, and then press the **[OK]** key.

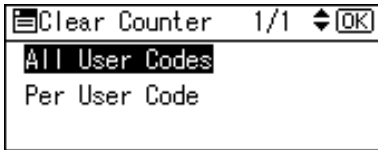

- 2** Select the function you want to clear the counter for using **[▶]**, and then press the **[OK]** key.

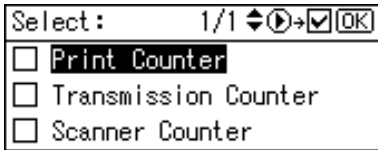

A confirmation message appears.

- 3** Press **[Yes]**.

The "Counter has been cleared." message appears, and then the "Codes:Counters" display returns.

To clear the counter for each user code

- 1** Select **[Per User Code]** using **[▲]** or **[▼]**, and then press the **[OK]** key.
- 2** Enter the user code you want to clear the counter for, and then press the **[OK]** key.

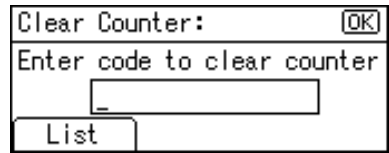

Note

- When you select the user code from the User Code List, press **[List]**. Select the user code you want to clear the counter for using **[▶]**, and then press the **[OK]** key.

- 3** Select the function you want to clear the counter using **[▶]**, and then press the **[OK]** key.

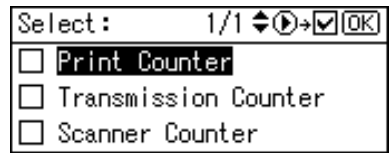

A confirmation message appears.

- 4** Press **[Yes]**.

The "Counter has been cleared." message appears, and then the "Codes:Counters" display returns.

- 6** Press the **[User Tools/Counter]** key.

Fax Destination

Register fax destinations, so you do not need to enter them each time, and can send documents scanned in using the fax function.

- It is easy to select the fax destination if you register a “User (Destination) Name” for the fax destination.
- You can register fax destinations as a group.

You can program the following items in a fax destination:

❖ Fax number

Registers the destination's fax number. You can enter a fax number using up to 128 digits. You must include every digit in the number. In addition to numbers, symbols are available for entering a fax number.

❖ Label Insertion

With this function you can have the receiver's name printed on the message when it is received at the other end. The name is printed at the top of the page and will be preceded by “To:”.

Note

- Label insertions are also printed when sending by e-mail using fax functions.

❖ International TX mode

When setting the International TX mode to [On], the machine transmits more carefully by reducing transmission speed. However, communication time increases.

Registering a Fax Destination

- 1 Press the [User Tools/Counter] key.

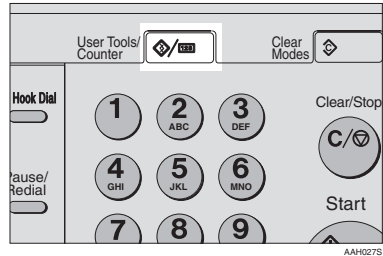

- 2 Select [System Settings] using [▲] or [▼], and then press the [OK] key.

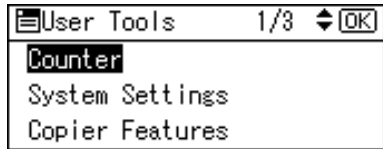

- 3 Select [Key Operator Tools] using [▲] or [▼], and then press the [OK] key.

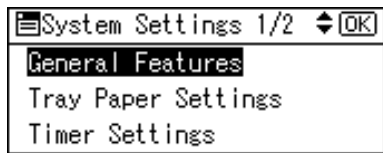

- 4 Select [Address Book Management] using [▲] or [▼], and then press the [OK] key.

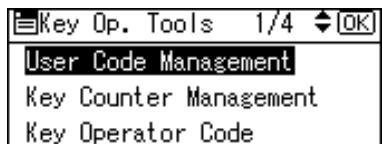

3

- 5** Select [Program/Change] using [▲] or [▼], and then press the [OK] key.

Address Book	1/1	◆	OK
Program/Change			
Delete			

- 6** Enter the registration number you want to program using the number keys or the Quick Dial keys, and then press the [OK] key.

Program/Change:	OK
Enter No. to program/change	
016	<Quick Dial:001-032>
Search	

- 7** Enter the user (destination) name using the number keys and the Quick Dial keys, and then press the [OK] key.

User (Destination) Name	OK
Enter name.	
abc	▲

Note

- You can use the user name when selecting a fax destination.
- You can register the user code after the user name. For details, see p.45 “User Code (MFP)”.

Reference

For details about entering text, see p.95 “Entering Text”.

- 8** Press [Dest.].

Program/Change:	OK
010 Kate	
Press OK key after setting	
Dest.	UserCode Reg. No.

- 9** Select [Fax Settings] using [▲] or [▼], and then press the [OK] key.

Dest. Settings	1/1	◆	OK
Fax Settings			
E-mail Settings			
Program Group			

To set the International TX mode

- 1** Press [Option].

Fax Settings:	OK
Enter Fax No.	
☎_	
Option	Tone

- 2** Select [On] or [Off] using [▲] or [▼], and then press the [OK] key.

Internl. TX Mode: 1/1	◆	OK
On		
Off		

To set label insertion

When Label Insertion is set to On, the receiver's name is printed on the fax message when it is received at the other end.

- 1 Select [On] or [Off] using [▲] or [▼], and then press the [OK] key.

Label Insertion: 1/1	◆	[OK]
On		
Off		

- 10 Enter the fax number using the number keys, and then press the [OK] key.

Fax Settings:	[OK]
Enter Fax No.	
☎_	
Option	Tone

To use the Tone function

This function allows the machine to send tonal signals when it is connected to a pulse dialing line (for example: to use a special service on a tone dialing line).

- 1 Press [Tone].
- 2 Enter the number you want to tone dial using the number keys.

A tone is shown as a "•" on the display.

Fax Settings:	[OK]
Enter Fax No.	
☎•	
Option	Tone

- 3 Press the [OK] key.

- 11 Press the [Cancel] key.

- 12 Press the [OK] key.

The "Programmed" message appears, and then the "Address Book" display returns.

- 13 Press the [User Tools/Counter] key.

Changing a Registered Fax Destination

- 1 Press the [User Tools/Counter] key.

- 2 Select [System Settings] using [▲] or [▼], and then press the [OK] key.

- 3 Select [Key Operator Tools] using [▲] or [▼], and then press the [OK] key.

- 4 Select [Address Book Management] using [▲] or [▼], and then press the [OK] key.

- 5 Select [Program/Change] using [▲] or [▼], and then press the [OK] key.

- 6 Enter the registration number you want to change using the number keys or the Quick Dial keys, and then press the [OK] key.

Searching to select a registered fax destination by name

- 1 Press [Search].

Program/Change:	[OK]
Enter No. to program/change	
016	<Quick Dial:001-032>
Search	

- 2 Select **[Search by Name]** using **[▲]** or **[▼]**, and then press the **[OK]** key.

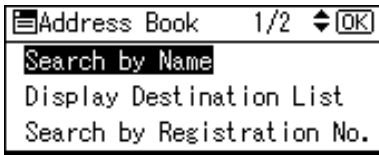

- 3 Enter the characters of the destination you want to change using the number keys and the Quick Dial keys, and then press the **[OK]** key.

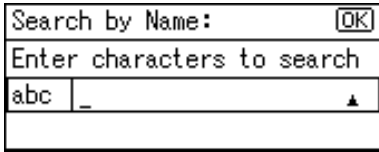

Reference

For details about entering text, see p.95 “Entering Text”.

- 4 Press the **[OK]** key.

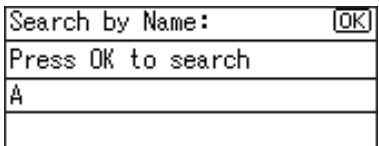

- 5 Select the destination you want to change using **[▲]** or **[▼]**, and then press the **[OK]** key.

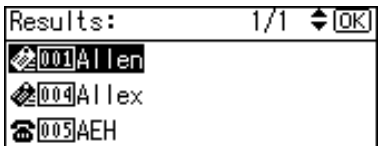

Searching to select a registered fax destination from Destination List

- 1 Press **[Search]**.
- 2 Select **[Display Destination List]** using **[▲]** or **[▼]**, and then press the **[OK]** key.
- 3 Select the destination you want to change using **[▲]** or **[▼]**, and then press the **[OK]** key.

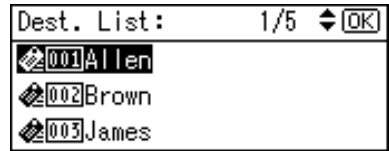

Searching to select a registered fax destination by registration number

- 1 Press **[Search]**.
- 2 Select **[Search by Registration No.]** using **[▲]** or **[▼]**, and then press the **[OK]** key.
- 3 Enter the registration number of the destination you want to change using the number keys, and then press the **[OK]** or **[#]** key.

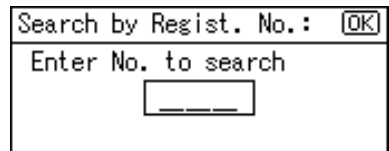

- 4 Press the **[OK]** key.

Searching to select a registered fax destination by user code

- ① Press [Search].
- ② Select [Search by User Code] using [▲] or [▼], and then press the [OK] key.
- ③ Enter the user code of the destination you want to change using the number keys, and then press the [OK] or [#] key.

Search by User Code:	[OK]
Enter user code to search.	
<input type="text" value=""/>	

- ④ Press the [OK] or [#] key.

Search by User Code:	[OK]
Press OK to search	
<input type="text" value="12345678"/>	

- ⑤ Press the [OK] key.

Searching to select a registered fax destination by fax number

- ① Press [Search].
- ② Select [Search by Fax No.] using [▲] or [▼], and then press the [OK] key.
- ③ Enter the fax number of the destination you want to change using the number keys, and then press the [OK] key.

Search by Fax No.:	[OK]
Enter No. to search.	
<input type="text" value=""/>	
<input type="button" value="Tone"/>	

- ④ Press the [OK] key.

Search by Fax No.:	[OK]
Press OK to search	
<input type="text" value="9"/>	
<input type="button" value="Tone"/>	

- ⑤ Select the destination you want to change using [▲] or [▼], and then press the [OK] key.

Results:	1/1	[OK]
<input type="checkbox"/> 005AEH		
<input type="checkbox"/> 006David		
<input type="checkbox"/> 008Kevin		

Searching to select a registered fax destination by e-mail address

- ① Press [Search].
- ② Select [Search by E-mail Address] using [▲] or [▼], and then press the [OK] key.
- ③ Enter the e-mail address of the destination you want to change using the number keys and the Quick Dial keys, and then press the [OK] key.

Search by E-mail Add.:	[OK]
Enter characters to search	
<input type="text" value="abc"/>	

Reference

For details about entering text, see p.95 “Entering Text”.

- 4** Press the **[OK]** key.

Search by E-mail Add. :	[OK]
Press OK to search	
a	

- 5** Select the destination you want to change, and then press the **[OK]** key.

Results:	1/1	◆	[OK]
◆001	Allen		
◆003	James		
◆004	Alex		

- 7** Press the **[OK]** key.

- 8** Press **[Dest.]**.

Program/Change :	[OK]
005	AEH
Press OK key after setting	
Dest.	UserCode Reg. No.

- 9** Select **[Fax Settings]** using **[▲]** or **[▼]**, and then press the **[OK]** key.

Dest. Settings	1/1	◆	[OK]
Fax Settings			
E-mail Settings			
Program Group			

- 10** Enter the new fax number using the number keys, and then press the **[OK]** key.

Fax Settings :	[OK]
Enter Fax No.	
☎987654321	
Option	Tone

- 11** Press the **[Cancel]** key.

- 12** Press the **[OK]** key.

The “Programmed” message appears, and then the “Address Book” display returns.

- 13** Press the **[User Tools/Counter]** key.

Deleting a Registered Fax Destination

- 1** Press the **[User Tools/Counter]** key.

- 2** Select **[System Settings]** using **[▲]** or **[▼]**, and then press the **[OK]** key.

- 3** Select **[Key Operator Tools]** using **[▲]** or **[▼]**, and then press the **[OK]** key.

- 4** Select **[Address Book Management]** using **[▲]** or **[▼]**, and then press the **[OK]** key.

- 5** Select **[Program/Change]** using **[▲]** or **[▼]**, and then press the **[OK]** key.

- 6** Enter the registration number you want to delete using the number keys or the Quick Dial keys, and then press the **[OK]** key.

Searching to select a registered fax destination by name

- 1** Press **[Search]**.
- 2** Select **[Search by Name]** using **[▲]** or **[▼]**, and then press the **[OK]** key.

- Enter the characters of the destination you want to delete using the number keys and the Quick Dial keys, and then press the **[OK]** key.

Search by Name:	[OK]
Enter characters to search	
abc	_

Reference

For details about entering text, see p.95 "Entering Text".

- Press the **[OK]** key.

Search by Name:	[OK]
Press OK to search	
A	

- Select the destination you want to delete using **[▲]** or **[▼]**, and then press the **[OK]** key.

Results:	1/1	[OK]									
<table border="0"> <tr><td>☒</td><td>001</td><td>Allen</td></tr> <tr><td>☒</td><td>004</td><td>Alex</td></tr> <tr><td>☒</td><td>005</td><td>AEH</td></tr> </table>			☒	001	Allen	☒	004	Alex	☒	005	AEH
☒	001	Allen									
☒	004	Alex									
☒	005	AEH									

Searching to select a registered fax destination from Destination List

- Press **[Search]**.
- Select **[Display Destination List]** using **[▲]** or **[▼]**, and then press the **[OK]** key.

- Select the destination you want to delete using **[▲]** or **[▼]**, and then press the **[OK]** key.

Dest. List:	1/5	[OK]									
<table border="0"> <tr><td>☒</td><td>001</td><td>Allen</td></tr> <tr><td>☒</td><td>002</td><td>Brown</td></tr> <tr><td>☒</td><td>003</td><td>James</td></tr> </table>			☒	001	Allen	☒	002	Brown	☒	003	James
☒	001	Allen									
☒	002	Brown									
☒	003	James									

Searching to select a registered fax destination by registration number

- Press **[Search]**.
- Select **[Search by Registration No.]** using **[▲]** or **[▼]**, and then press the **[OK]** key.
- Enter the registration number of the destination you want to delete using the number keys, and then press the **[OK]** key.

Search by Regist. No.:	[OK]
Enter No. to search	
<input type="text" value=""/>	

- Press the **[OK]** key.

Searching to select a registered fax destination by user code

- Press **[Search]**.
- Select **[Search by User Code]** using **[▲]** or **[▼]**, and then press the **[OK]** key.

- Enter the user code of the destination you want delete using the number keys, and then press the [OK] or [#] key.

Search by User Code:	[OK]
Enter user code to search.	
	<input type="text"/>

- Press the [OK] or [#] key.

Search by User Code:	[OK]
Press OK to search	
	<input type="text" value="12345678"/>

- Press the [OK] key.

Searching to select a registered fax destination by fax number

- Press [Search].
- Select [Search by Fax No.] using [▲] or [▼], and then press the [OK] key.
- Enter the fax number of the destination you want to delete using the number keys, and then press the [OK] key.

Search by Fax No.:	[OK]
Enter No. to search.	
	<input type="text" value=""/>
	<input type="button" value="Tone"/>

- Press the [OK] key.

Search by Fax No.:	[OK]
Press OK to search	
	<input type="text" value="9"/>
	<input type="button" value="Tone"/>

- Select the destination you want to delete using [▲] or [▼], and then press the [OK] key.

Results:	1/1	[OK]
	<input type="checkbox"/> 009 AEH	
	<input type="checkbox"/> 006 David	
	<input type="checkbox"/> 008 Kevin	

Searching to select a registered fax destination by e-mail address

- Press [Search].
- Select [Search by E-mail Address] using [▲] or [▼], and then press the [OK] key.
- Enter the e-mail address of the destination you want to delete using the number keys and the Quick Dial key, and then press the [OK] key.

Search by E-mail Add.:	[OK]
Enter characters to search	
	<input type="text" value="abc"/>

 Reference

For details about entering text, see p.95 “Entering Text”.

- Press the [OK] key.

Search by E-mail Add.:	[OK]
Press OK to search	
	<input type="text" value="a"/>

- 5 Select the destination you want to delete using **[▲]** or **[▼]**, and then press the **[OK]** key.

Results:	1/1	◆	[OK]
◆001	Allen		
◆003	James		
◆004	Alex		

- 7 Press the **[OK]** key.

- 8 Press **[Dest.]**.

Program/Change:	[OK]
005 AEH	
Press OK key after setting	
Dest.	UserCode Reg. No.

- 9 Select **[Fax Settings]** using **[▲]** or **[▼]**, and then press the **[OK]** key.

Dest. Settings	1/1	◆	[OK]
Fax Settings			
E-mail Settings			
Program Group			

- 10 Press the **[Clear/Stop]** key, and then press the **[OK]** key.

Fax Settings:	[OK]
Enter Fax No.	
☎987654321	
Option	Tone

- 11 Press the **[Cancel]** key.

- 12 Press the **[OK]** key.

The "Programmed" message appears, and then the "Address Book" display returns.

- 13 Press the **[User Tools/Counter]** key.

E-mail Destination

Register e-mail destinations, so you do not need to enter e-mail addresses every time, and can send scan files by e-mail, or send fax documents by Internet Fax.

- It is easy to select the e-mail destination if you register "User (Destination) Name" for the e-mail destination.
- You can register e-mail destinations as a group.
- You can use the e-mail address as the sender address when sending scan files in scanner mode. If you do this, set a sender's password on the sender address to prevent use by other people.

Registering an E-mail Destination

1 Press the **[User Tools/Counter]** key.

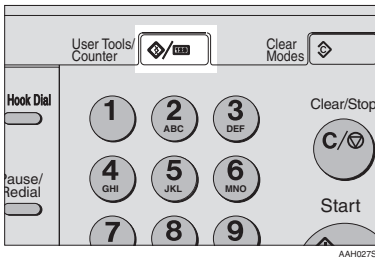

2 Select **[System Settings]** using **[▲]** or **[▼]**, and then press the **[OK]** key.

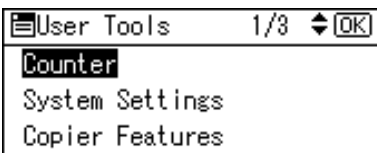

3 Select **[Key Operator Tools]** using **[▲]** or **[▼]**, and then press the **[OK]** key.

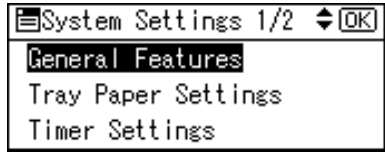

4 Select **[Address Book Management]** using **[▲]** or **[▼]**, and then press the **[OK]** key.

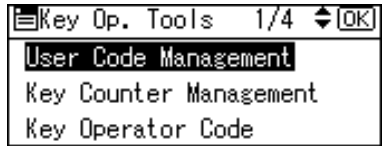

5 Select **[Program/Change]** using **[▲]** or **[▼]**, and then press the **[OK]** key.

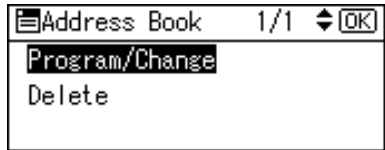

6 Enter the registration number you want to program using the number keys or the Quick Dial keys, and then press the **[OK]** key.

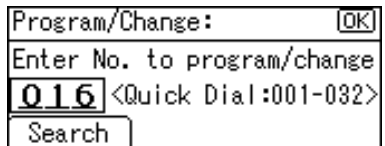

- 7** Enter the user (destination) name using the number keys and the Quick Dial keys, and then press the **[OK]** key.

User (Destination) Name [OK]	
Enter name.	
abc	▲

Note

- You can use the user name when selecting an address to send to.
- You can register the user code after the user name. For details, see p.45 "User Code (MFP)".

Reference

For details about entering text, see p.95 "Entering Text".

- 8** Press **[Dest.]**.

Program/Change: [OK]	
[010] Kate	
Press OK key after setting	
Dest.	UserCode Reg. No.

- 9** Select **[E-mail Settings]** using **[▲]** or **[▼]**, and then press the **[OK]** key.

Dest. Settings 1/1 [OK]
Fax Settings
E-mail Settings
Program Group

- 10** Enter the e-mail address using the number keys and the Quick Dial keys, and then press the **[OK]** key.

E-mail Settings: [OK]
Enter e-mail address.
abc _

Note

- You can register the e-mail address up to 128 characters.
- When a group is registered, other e-mail destinations can be added to the group. See p.74 "Registering a Destination to a Group"

Using the e-mail address as the sender

- 1** Select **[On]** using **[▲]** or **[▼]**, and then press the **[OK]** key.

Regist. as Sender 1/1 [OK]
On
Off

Registering a sender's password

Note

- You can stop sender's names being accessed by setting a sender's password.
- This function is not available when using Internet Fax to send e-mails.

- 1 Select [On] using [▲] or [▼], and then press the [OK] key.

- 2 Enter the sender's password using the number keys, and then press the [OK] key.

Note

- You can enter up to eight digits.

- 11 Press the [Cancel] key.

- 12 Press the [OK] key.

The “Programmed” message appears, and then the “Address Book” display returns.

- 13 Press the [User Tools/Counter] key.

Changing a Registered E-mail Destination

- 1 Press the [User Tools/Counter] key.

- 2 Select [System Settings] using [▲] or [▼], and then press the [OK] key.

- 3 Select [Key Operator Tools] using [▲] or [▼], and then press the [OK] key.

- 4 Select [Address Book Management] using [▲] or [▼], and then press the [OK] key.

- 5 Select [Program/Change] using [▲] or [▼], and then press the [OK] key.

- 6 Enter the registration number you want to change using the number keys or the Quick Dial keys, and then press the [OK] key.

Searching to select a registered e-mail destination by name

- 1 Press [Search].

- 2 Select [Search by Name] using [▲] or [▼], and then press the [OK] key.

- 3 Enter the characters of the destination you want to change using the number keys and the Quick Dial keys, and then press the [OK] key.

Reference

For details about entering text, see p.95 “Entering Text”.

- 4 Press the **[OK]** key.

Search by Name:	[OK]
Press OK to search	
A	

- 5 Select the destination you want to change using **[▲]** or **[▼]**, and then press the **[OK]** key.

Results:	1/1	[OK]
[001] Allen		
[004] Alex		
[005] AEH		

Searching to select a registered e-mail destination from Destination List

- 1 Press **[Search]**.
- 2 Select **[Display Destination List]** using **[▲]** or **[▼]**, and then press the **[OK]** key.
- 3 Select the destination you want to change using **[▲]** or **[▼]**, and then press the **[OK]** key.

Dest. List:	1/5	[OK]
[001] Allen		
[002] Brown		
[003] James		

Searching to select a registered e-mail destination by registration number.

- 1 Press **[Search]**.
- 2 Select **[Search by Registration No.]** using **[▲]** or **[▼]**, and then press the **[OK]** key.

- 3 Enter the registration number of the destination you want to change using the number keys, and then press the **[OK]** or **[#]** key.

Search by Regist. No.:	[OK]
Enter No. to search	<input type="text"/>

- 4 Press the **[OK]** key.

Searching to select a registered e-mail destination by user code

- 1 Press **[Search]**.
- 2 Select **[Search by User Code]** using **[▲]** or **[▼]**, and then press the **[OK]** key.
- 3 Enter the user code of the destination you want change using the number keys, and then press the **[OK]** or **[#]** key.

Search by User Code:	[OK]
Enter user code to search.	<input type="text"/>

- 4 Press the **[OK]** or **[#]** key.

Search by User Code:	[OK]
Press OK to search	<input type="text" value="12345678"/>

- 5 Press the **[OK]** key.

Searching to select a registered e-mail destination by fax number

- 1 Press [Search].
- 2 Select [Search by Fax No.] using [▲] or [▼], and then press the [OK] key.
- 3 Enter the fax number of the destination you want to change using the number keys, and then press the [OK] key.

Search by Fax No. :	[OK]
Enter No. to search.	
☎_	
	Tone

- 4 Press the [OK] key.

Search by Fax No. :	[OK]
Press OK to search	
☎9	
	Tone

- 5 Select the destination you want to change using [▲] or [▼], and then press the [OK] key.

Results:	1/1	◆ [OK]
☎005	AEH	
☎006	David	
☎008	Kevin	

Searching to select a registered e-mail destination by e-mail address

- 1 Press [Search].
- 2 Select [Search by E-mail Address] using [▲] or [▼], and then press the [OK] key.

- 3 Enter the e-mail address of the destination you want to change using the number keys and the Quick Dial keys, and then press the [OK] key.

Search by E-mail Add. :	[OK]
Enter characters to search	
abc _	

 Reference

For details about entering text, see p.95 “Entering Text”.

- 4 Press the [OK] key.

Search by E-mail Add. :	[OK]
Press OK to search	
a	

- 5 Select the destination you want to change using [▲] or [▼], and then press the [OK] key.

Results:	1/1	◆ [OK]
☎001	Allen	
☎003	James	
☎004	Alex	

- 7 Press the [OK] key.

- 8 Press [Dest.].

Program/Change :	[OK]
001	Allen
Press OK key after setting	
Dest.	UserCode Reg. No.

- 9** Select [E-mail Settings] using [▲] or [▼], and then press the [OK] key.

Dest. Settings 1/1 [OK]

Fax Settings

E-mail Settings

Program Group

- 10** Enter the new e-mail address using the number keys and the Quick Dial keys, and then press the [OK] key.

- 11** When using the e-mail address as a sender, select [On] using [▲] or [▼], and then press the [OK] key.

When [Off] is selected, proceed to step 12.

Regist. as Sender 1/1 [OK]

On

Off

- 12** When using a sender's password, select [On] using [▲] or [▼], and then press the [OK] key.

When [Off] is selected, proceed to step 13.

Sender's Password 1/1 [OK]

On

Off

- 13** Enter the sender's password using the number keys, and then press the [OK] key.

Password: [OK]

Enter password.

- 14** Press the [Cancel] key.

- 15** Press the [OK] key.

The "Programmed" message appears, and then the "Address Book" display returns.

- 16** Press the [User Tools/Counter] key.

Deleting a Registered E-mail Destination

- 1** Press the [User Tools/Counter] key.

- 2** Select [System Settings] using [▲] or [▼], and then press the [OK] key.

- 3** Select [Key Operator Tools] using [▲] or [▼], and then press the [OK] key.

- 4** Select [Address Book Management] using [▲] or [▼], and then press the [OK] key.

- 5** Select [Program/Change] using [▲] or [▼], and then press the [OK] key.

- 6** Enter the registration number you want to delete using the number keys or the Quick Dial keys, and then press the [OK] key.

Searching to select a registered e-mail destination by name

- 1** Press [Search].
- 2** Select [Search by Name] using [▲] or [▼], and then press the [OK] key.

- Enter the characters of the destination you want to delete using the number keys and the Quick Dial keys, and then press the [OK] key.

Search by Name:	[OK]
Enter characters to search	
abc	_

Reference

For details about entering text, see p.95 “Entering Text”.

- Press the [OK] key.

Search by Name:	[OK]
Press OK to search	
A	

- Select the destination you want to delete using [▲] or [▼], and then press the [OK] key.

Results:	1/1	[OK]						
<table border="1"> <tr><td>001</td><td>Allen</td></tr> <tr><td>004</td><td>Alex</td></tr> <tr><td>005</td><td>AEH</td></tr> </table>			001	Allen	004	Alex	005	AEH
001	Allen							
004	Alex							
005	AEH							

Searching to select a registered e-mail destination from Destination List

- Press [Search].
- Select [Display Destination List] using [▲] or [▼], and then press the [OK] key.
- Select the destination you want to delete using [▲] or [▼], and then press the [OK] key.

Dest. List:	1/5	[OK]						
<table border="1"> <tr><td>001</td><td>Allen</td></tr> <tr><td>002</td><td>Brown</td></tr> <tr><td>003</td><td>James</td></tr> </table>			001	Allen	002	Brown	003	James
001	Allen							
002	Brown							
003	James							

Searching to select a registered e-mail destination by registration number

- Press [Search].
- Select [Search by Registration No.] using [▲] or [▼], and then press the [OK] key.
- Enter the registration number of the destination you want to delete using the number keys, and then press the [OK] or [#] key.

Search by Regist. No.:	[OK]
Enter No. to search	
<input type="text"/>	

- Press the [OK] key.

Searching to select a registered e-mail destination by user code

- ① Press [Search].
- ② Select [Search by User Code] using [▲] or [▼], and then press the [OK] key.
- ③ Enter the user code of the destination you want delete using the number keys, and then press the [OK] or [#] key.

Search by User Code:	[OK]
Enter user code to search.	
<input type="text" value=""/>	

- ④ Press the [OK] or [#] key.

Search by User Code:	[OK]
Press OK to search	
<input type="text" value="12345678"/>	

- ⑤ Press the [OK] key.

Searching to select a registered e-mail destination by fax number

- ① Press [Search].
- ② Select [Search by Fax No.] using [▲] or [▼], and then press the [OK] key.
- ③ Enter the fax number of the destination you want to delete using the number keys, and then press the [OK] key.

Search by Fax No.:	[OK]
Enter No. to search.	
<input type="text" value=""/>	
<input type="button" value="Tone"/>	

- ④ Press the [OK] key.

Search by Fax No.:	[OK]
Press OK to search	
<input type="text" value="9"/>	
<input type="button" value="Tone"/>	

- ⑤ Select the destination you want to delete using [▲] or [▼], and then press the [OK] key.

Results:	1/1	[OK]
<input type="checkbox"/> 005 AEH		
<input type="checkbox"/> 006 David		
<input type="checkbox"/> 008 Kevin		

Searching to select a registered e-mail destination by e-mail address

- ① Press [Search].
- ② Select [Search by E-mail Address] using [▲] or [▼], and then press the [OK] key.
- ③ Enter the e-mail address of the destination you want to delete using the number keys and the Quick Dial keys, and then press the [OK] key.

Search by E-mail Add.:	[OK]
Enter characters to search	
<input type="text" value="abc"/>	

Reference

For details about entering text, see p.95 "Entering Text".

4 Press the **[OK]** key.

Search by E-mail Add. :	[OK]
Press OK to search	
a	

5 Select the destination you want to delete using **[▲]** or **[▼]**, and then press the **[OK]** key.

Results:	1/1	[OK]
001 Allen		
003James		
004Alex		

7 Press the **[OK]** key.

8 Press **[Dest.]**.

Program/Change :	[OK]
001 Allen	
Press OK key after setting	
Dest.	UserCode Reg. No.

9 Select **[E-mail Settings]** using **[▲]** or **[▼]**, and then press the **[OK]** key.

Dest. Settings	1/1	[OK]
Fax Settings		
E-mail Settings		
Program Group		

10 Press the **[Clear/Stop]** key, and then press the **[OK]** key .

11 Select **[Off]** using **[▲]** or **[▼]**, and then press the **[OK]** key.

Regist. as Sender	1/1	[OK]
On		
Off		

12 Press the **[Cancel]** key.

13 Press the **[OK]** key.

The “Programmed” message appears, and then the “Address Book” display returns.

14 Press the **[User Tools/Counter]** key.

Registering Destinations to a Group

Register destinations to a group to easily control registered fax, e-mail and folders for each group.

To group destinations, the groups must be registered beforehand.

 **Note**

- You can register up to 10 groups.

Registering a New Group

- 1 Press the [User Tools/Counter] key.

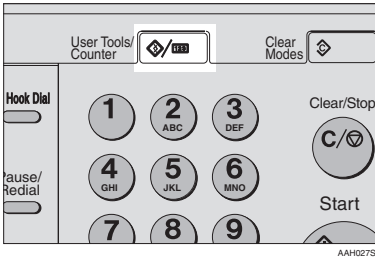

- 2 Select [System Settings] using [▲] or [▼], and then press the [OK] key.

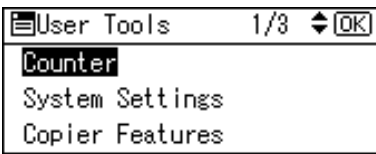

- 3 Select [Key Operator Tools] using [▲] or [▼], and then press the [OK] key.

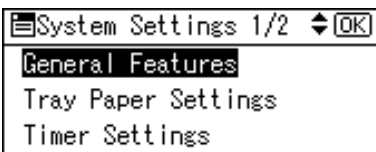

- 4 Select [Prgrm./Change/Delete Group] using [▲] or [▼], and then press the [OK] key.

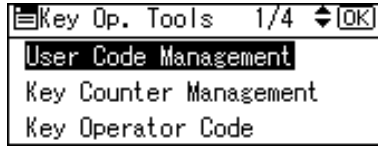

- 5 Select [Program/Change] using [▲] or [▼], and then press the [OK] key.

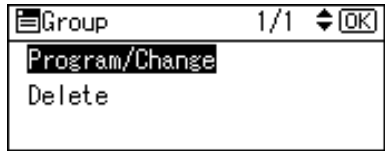

- 6 Enter the registration number you want to program using the number keys or the Quick Dial keys, and then press the [OK] key.

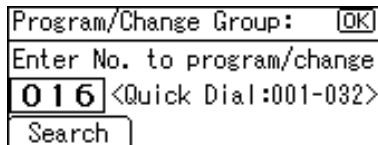

- 7 Enter the group name using the number keys and the Quick Dial keys, and then press the [OK] key.

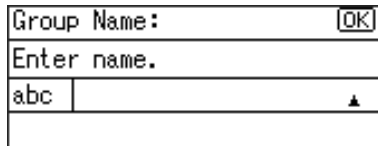

 **Reference**

For details about entering text, see p.95 "Entering Text".

8 Press the **[OK]** key.

The “Programmed” message appears, and then the “Group” display returns.

9 Press the **[User Tools/Counter]** key.

Registering a Destination to a Group

1 Press the **[User Tools/Counter]** key.

2 Select **[System Settings]** using **[▲]** or **[▼]**, and then press the **[OK]** key.

3 Select **[Key Operator Tools]** using **[▲]** or **[▼]**, and then press the **[OK]** key.

4 Select **[Address Book Management]** using **[▲]** or **[▼]**, and then press the **[OK]** key.

5 Select **[Program/Change]** using **[▲]** or **[▼]**, and then press the **[OK]** key.

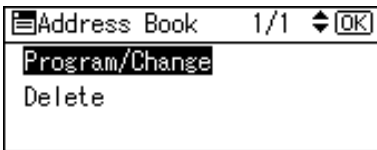

6 Enter the registration number you want to program using the number keys or the Quick Dial keys, and then press the **[OK]** key.

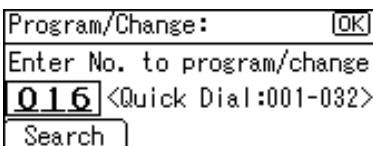

7 Enter the user (destination) name using the number keys and the Quick Dial keys, and then press the **[OK]** key.

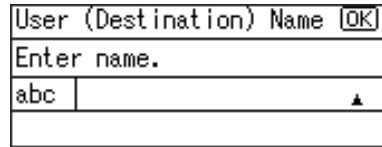

Reference

For details about entering text, see p.95 “Entering Text”.

8 Press **[Dest.]**.

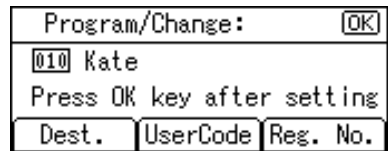

9 Select **[Program Group]** using **[▲]** or **[▼]**, and then press the **[OK]** key.

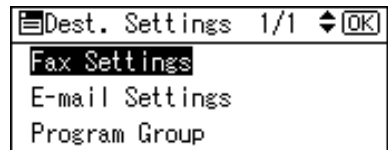

10 Select the group name to which you want to register using **[▶]**, and then press the **[OK]** key.



11 Press the **[Cancel]** key.

- 12 Press the [OK] key.
The "Programmed" message appears, and then the "Address Book" display returns.

- 13 Press the [User Tools/Counter] key.

Deleting a Destination from a Group

- 1 Press the [User Tools/Counter] key.
- 2 Select [System Settings] using [▲] or [▼], and then press the [OK] key.
- 3 Select [Key Operator Tools] using [▲] or [▼], and then press the [OK] key.
- 4 Select [Address Book Management] using [▲] or [▼], and then press the [OK] key.
- 5 Select [Program/Change] using [▲] or [▼], and then press the [OK] key.
- 6 Enter the registration number you want to delete using the number keys or the Quick Dial keys, and then press the [OK] key.

Searching to select a destination registered in a group by name

- 1 Press [Search].

Program/Change:	[OK]
Enter No. to program/change	
016 <Quick Dial:001-032>	
Search	

- 2 Select [Search by Name] using [▲] or [▼], and then press the [OK] key.

Address Book	1/2	[OK]
Search by Name		
Display Destination List		
Search by Registration No.		

- 3 Enter the characters of the destination you want to delete using the number keys and the Quick Dial keys, and then press the [OK] key.

Search by Name:	[OK]
Enter characters to search	
abc	▲

Reference

For details about entering text, see p.95 "Entering Text".

- 4 Press the [OK] key.

Search by Name:	[OK]
Press OK to search	
A	

- 5 Select the destination you want to delete using [▲] or [▼], and then press the [OK] key.

Results:	1/1	[OK]
001 Alien		
004 Allex		
005 AEH		

Searching to select a destination registered in a group from Destination List

- 1 Press [Search].
- 2 Select [Display Destination List] using [▲] or [▼], and then press the [OK] key.
- 3 Select the destination you want to delete using [▲] or [▼], and then press the [OK] key.

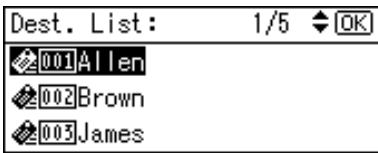

Searching to select a destination registered in a group by registration number

- 1 Press [Search].
- 2 Select [Search by Registration No.] using [▲] or [▼], and then press the [OK] key.
- 3 Enter the registration number of the destination you want to delete using the number keys, and then press the [OK] or [#] key.

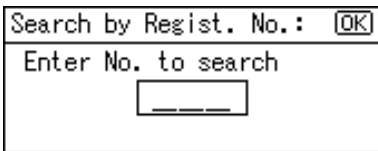

- 4 Press the [OK] key.

Searching to select a destination registered in a group by user code

- 1 Press [Search].
- 2 Select [Search by User Code] using [▲] or [▼], and then press the [OK] key.
- 3 Enter the user code of the destination you want to delete using the number keys, and then press the [OK] or [#] key.

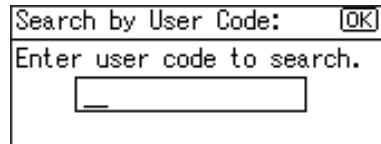

- 4 Press the [OK] key.

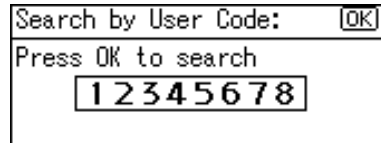

- 5 Press the [OK] key.

Searching to select a destination registered in a group by fax number

- 1 Press [Search].
- 2 Select [Search by Fax No.] using [▲] or [▼], and then press the [OK] key.
- 3 Enter the fax number of the destination you want to delete using the number keys, and then press the [OK] key.

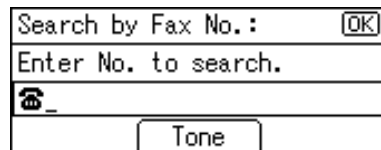

- 4 Press the [OK] key.

Search by Fax No. :	[OK]
Press OK to search	
☎9	
	Tone

- 5 Select the destination you want to delete using [▲] or [▼], and then press the [OK] key.

Results:	1/1	◆ [OK]
☎005	AEH	
☎006	David	
☎008	Kevin	

Searching to select a destination registered in a group by e-mail address

- 1 Press [Search].
- 2 Select [Search by E-mail Address] using [▲] or [▼], and then press the [OK] key.
- 3 Enter the e-mail address of the destination you want to delete using the number keys and the Quick Dial keys, and then press the [OK] key.

Search by E-mail Add. :	[OK]
Enter characters to search	
abc	_

 **Reference**

For details about entering text, see p.95 “Entering Text”.

- 4 Press the [OK] key.

Search by E-mail Add. :	[OK]
Press OK to search	
a	

- 5 Select the destination you want to delete using [▲] or [▼], and then press [OK] key.

Results:	1/1	◆ [OK]
☎001	Allen	
☎003	James	
☎004	Alex	

- 7 Press the [OK] key.

- 8 Press [Dest.].

Program/Change :	[OK]
001	Allen
Press OK key after setting	
Dest.	UserCode Reg. No.

- 9 Select [Program Group] using [▲] or [▼], and then press the [OK] key.

Dest. Settings	1/1	◆ [OK]
Fax Settings		
E-mail Settings		
Program Group		

- 10 Select the group name from which you want to delete using [◀], and then press the [OK] key.

- 11 Press the [Cancel] key.

- 12 Press the [OK] key.

The “Programmed” message appears, and then the “Address Book” display returns.

- 13 Press the [User Tools/Counter] key.

Displaying the Destinations Registered in Groups

- 1 Press the [User Tools/Counter] key.
- 2 Select [System Settings] using [▲] or [▼], and then press the [OK] key.
- 3 Select [Key Operator Tools] using [▲] or [▼], and then press the [OK] key.
- 4 Select [Prgrm./Change/Delete Group] using [▲] or [▼], and then press the [OK] key.
- 5 Select [Program/Change] using [▲] or [▼], and then press the [OK] key.
- 6 Enter the registration number you want to display using the number keys or the Quick Dial keys, and then press the [OK] key.

Searching to select a registered group by name

- 1 Press [Search].

Program/Change Group:	[OK]
Enter No. to program/change	
016 <Quick Dial:001-032>	
Search	

- 2 Select [Search by Name] using [▲] or [▼], and then press the [OK] key.

Address Book	1/1	[OK]
Search by Name		
Display Destination List		
Search by Registration No.		

- 3 Enter the characters of the destination you want to display using the number keys and the Quick Dial keys, and then press the [OK] key.

Search by Name:	[OK]
Enter characters to search	
abc _	▲

Reference

For details about entering text, see p.95 "Entering Text".

- 4 Press the [OK] key.

Search by Name:	[OK]
Press OK to search	
B	

- 5 Select the group you want to display using [▲] or [▼], and then press the [OK] key.

Results:	1/1	[OK]
025 Branch A		
026 Branch B		
027 Bay area		

Searching to select a registered group from Destination List

- 1 Press [Search].
- 2 Select [Display Destination List] using [▲] or [▼], and then press the [OK] key.

- 3 Select the group you want to display using [▲] or [▼], and then press the [OK] key.

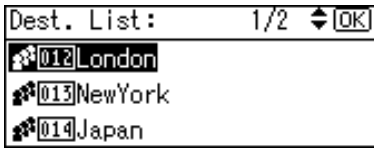

Searching to select a registered group by registration number

- 1 Press [Search].
- 2 Select [Search by Registration No.] using [▲] or [▼], and then press the [OK] key.
- 3 Enter the registration number of the group you want to display using the number keys, and then press the [OK] or [#] key.

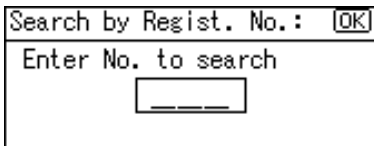

- 4 Press the [OK] key.
- 7 Press the [OK] key.
- 8 Press [Users].

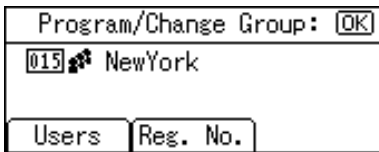

All the user (destination) names in the specified group appear.

- 9 Press the [User Tools/Counter] key.

Changing a Group Name

- 1 Press the [User Tools/Counter] key.
- 2 Select [System Settings] using [▲] or [▼], and then press the [OK] key.
- 3 Select [Key Operator Tools] using [▲] or [▼], and then press the [OK] key.
- 4 Select [Prgrm./Change/Delete Group] using [▲] or [▼], and then press the [OK] key.
- 5 Select [Program/Change] using [▲] or [▼], and then press the [OK] key.
- 6 Enter the registration number you want to change using the number keys and the Quick Dial keys, and then press the [OK] key.

Searching to select a registered group by name

- 1 Press [Search].

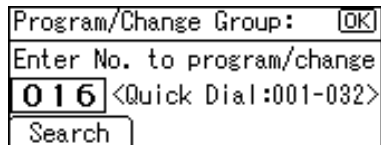

- 2 Select [Search by Name] using [▲] or [▼], and then press the [OK] key.

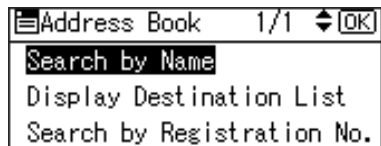

- Enter the characters of the destination you want to change using the number keys and the Quick Dial keys, and then press the [OK] key.

Search by Name:	[OK]
Enter characters to search	
abc	_

Reference

For details about entering text, see p.95 “Entering Text”.

- Press the [OK] key.

Search by Name:	[OK]
Press OK to search	
B	

- Select the group you want to change using [▲] or [▼], and then press the [OK] key.

Results:	1/1	[OK]
[025]Branch A		
[026]Branch B		
[027]Bay area		

Searching to select a registered group from Destination List

- Press [Search].
- Select [Display Destination List] using [▲] or [▼], and then press the [OK] key.

- Select the group you want to change using [▲] or [▼], and then press the [OK] key.

Dest. List:	1/2	[OK]
[012]London		
[013]NewYork		
[014]Japan		

Searching to select a registered group by registration number

- Press [Search].
- Select [Search by Registration No.] using [▲] or [▼], and then press the [OK] key.
- Enter the registration number of the group you want to change using the number keys, and then press the [OK] or [#] key.

Dest. List:	1/2	[OK]
[012]London		
[013]NewYork		
[014]Japan		

- Press the [OK] key.
- Enter the new group name using the number keys and the Quick Dial keys, and then press the [OK] key.

Reference

For details about entering text, see p.95 “Entering Text”.

- Press the [OK] key.
The “Programmed” message appears, and then the “Group” display returns.
- Press the [User Tools/Counter] key.

Deleting a Group

- 1 Press the [User Tools/Counter] key.
- 2 Select [System Settings] using [▲] or [▼], and then press the [OK] key.
- 3 Select [Key Operator Tools] using [▲] or [▼], and then press the [OK] key.
- 4 Select [Prgrm./Change/Delete Group] using [▲] or [▼], and then press the [OK] key.
- 5 Select [Delete] using [▲] or [▼], and then press the [OK] key.
- 6 Enter the registration number you want to delete using the number keys or the Quick Dial keys, and then press the [OK] key.

Delete Group:	[OK]
Enter No. to delete.	
<input type="text" value=""/>	<Quick Dial:001-032>
Search	

Searching to select a registered group by name

- 1 Press [Search].
- 2 Select [Search by Name] using [▲] or [▼], and then press the [OK] key.

Address Book	1/1	[OK]
Search by Name		
Display Destination List		
Search by Registration No.		

- 3 Enter the characters of the destination you want to delete using the number keys and the Quick Dial keys, and then press the [OK] key.

Search by Name:	[OK]
Enter characters to search	
abc	▲

Reference

For details about entering text, see p.95 "Entering Text".

- 4 Press the [OK] key.

Search by Name:	[OK]
Press OK to search	
B	

- 5 Select the group you want to delete using [▲] or [▼], and then press the [OK] key.

Results:	1/1	[OK]
025 Branch A		
026 Branch B		
027 Bay area		

Searching to select a registered group from Destination List

- 1 Press [Search].
- 2 Select [Display Destination List] using [▲] or [▼], and then press the [OK] key.

- 3 Select the group you want to delete using [▲] or [▼], and then press the [OK] key.

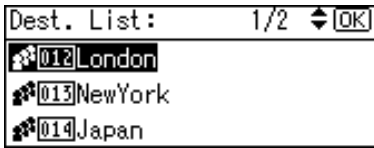

3

Searching to select a registered group by registration number

- 1 Press [Search].
- 2 Select [Search by Registration No.] using [▲] or [▼], and then press the [OK] key.
- 3 Enter the registration number of the group you want to delete using the number keys, and then press the [OK] or [#] key.

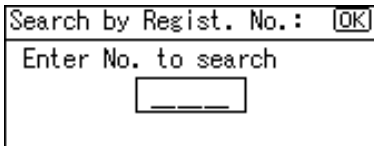

- 4 Press the [OK] key.
A confirmation message appears.

- 7 Press [Yes].
The "Deleted." message appears, and then the "Group" display returns.

- 8 Press the [User Tools/Counter] key.

4. Troubleshooting

If Your Machine Does Not Operate As You Want

The following chart gives explanations of common problems and messages. If other messages appear, follow the instructions displayed.

Note

- For further "Troubleshooting", refer to the other manuals for this machine. See p.i "Manuals for This Machine".

Problem	Causes	Solutions
"Please wait." appears.	This message appears when you turn on the operation switch or change the toner bottle.	Wait for the machine to get ready.
The display is off.	The machine is in Energy Saver mode.	Turn on the operation switch.
	The operation switch is turned off.	
Nothing happens when the operation switch is turned on.	The main power switch is turned off.	Turn on the main power switch.
The user code entry display appears.	Users are restricted by user management.	Enter the user code (up to eight digits), and then press the [OK] or [#] key.

Problem	Causes	Solutions
The main power indicator continues blinking and does not turn off when pressed.	This occurs in the following case: <ul style="list-style-type: none"> The machine is communicating with external equipment. 	Check if the machine is communicating with a computer.
Original images are printed on the reverse side of the paper.	You may have loaded the paper incorrectly.	Load paper correctly. Load paper into Tray 1-4 with the print side up, and bypass tray with the print side down.
Misfeeds occur frequently.	The tray's side fences may not be locked.	Check the side fences are locked. p.88 "Changing the Paper Size".
	The tray's end fence may not be set properly.	Check the end fence is set properly. See p.88 "Changing the Paper Size".
	You may have loaded paper of a size not shown on the paper size selector.	When using paper of a size that cannot be detected automatically, use Tray Paper Settings to set the paper size. See p.30 "Tray Paper Size:Tray 1-4" and p.107 "Copy Paper".
An error message remains, even if misfed paper is removed.	When a misfeed message appears, it remains until you open and close the cover, as required.	Clear misfed paper, and then open and close the front cover. See p.85 "Clearing Misfeeds".
You forgot your key operator code.	—	Contact your service representative.

Clearing Misfeeds

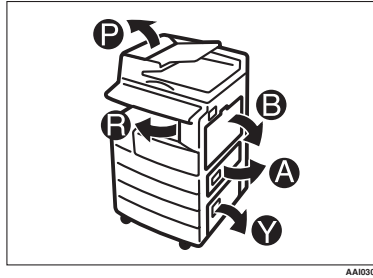

AA10305

⚠ CAUTION:

- The fusing section of this machine might be very hot. Caution should be taken when removing misfed paper.

🔧 Important

- When clearing misfeeds, do not turn off the power switch. If you do, your copy settings are cleared.
- To prevent misfeeds, do not leave any torn scraps of paper inside the machine.
- If paper misfeeds occur repeatedly, contact your service representative.

📝 Note

- More than one misfeed area may be indicated. If this is the case, check every applicable area. Refer to the following charts: A, B, P, R, Y.
- You can find a sticker explaining how to remove misfed paper inside the right cover.
- When the machine instructs you to reset originals, reset them in the feeding position. The display will show you the number of originals to return.

■ When P is displayed (ADF)

1



1. Open the ADF cover, and then remove the misfed original.

2



2. Open the ADF.

3

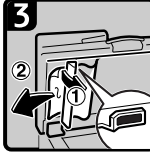

3. Pull the green lever in the upper left corner, and then remove the misfed original.

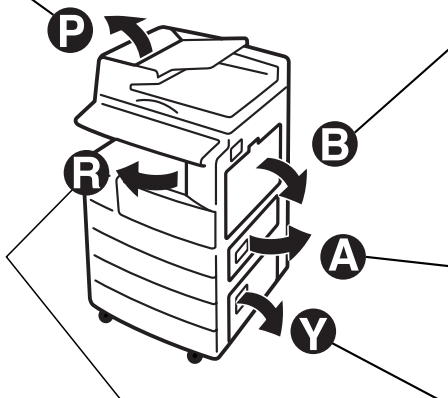

4

■ When R is displayed

1

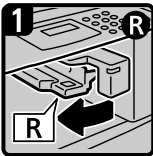

1. Open the right cover of the bridge unit to the left

2

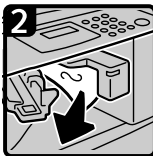

2. Remove the misfed paper.

3. Close the right cover.

When B is displayed



1. Open the right cover and remove the misfed paper.

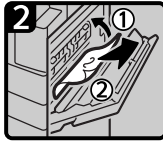

2. Remove the misfed paper.



4. Open the right cover and remove the misfed paper.

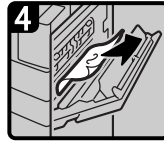

5. Remove the misfed paper.

When A is displayed



1. Open the lower right cover and remove the misfed paper.

2. Close the cover.

When Y is displayed

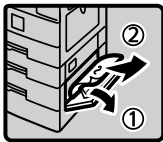

1. Open the lower right cover of the optional paper tray unit and remove the misfed paper.

2. Close the cover.

AA029S

Changing the Paper Size

Preparation

Be sure to select the paper size with User Tools and the paper size selector. If you do not, misfeeds might occur. See p.30 "Tray Paper Size:Tray 1-4".

Reference

For details about paper sizes and types, see p.107 "Copy Paper".

4

Changing the Paper Size of the Paper Tray

1 Make sure the paper tray is not in use.

2 Pull the paper tray out slowly until it stops.

Note

Remove any remaining copy paper.

3 While pressing the release lever, adjust the back fence.

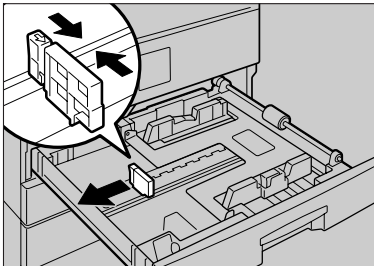

ZENY380E

When using 11"× 17" size paper

1 Pull the back fence off from the tray.

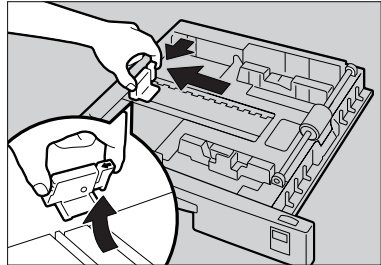

ZENY410E

2 Place it in the corner pocket on the left.

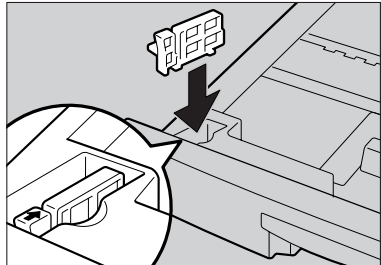

ZENY420E

4 Press down the release button.



ZENY291E

- 5** While pressing the release lever, adjust the side fences.

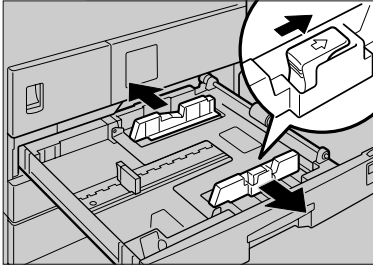

ZENY390E

- 6** Push the metal plate down.

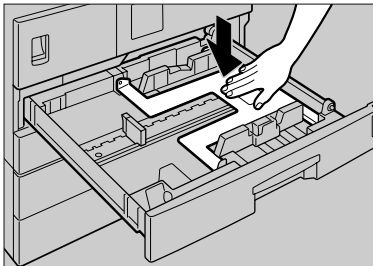

ZENY300E

- 7** Square the paper and set it in the tray.

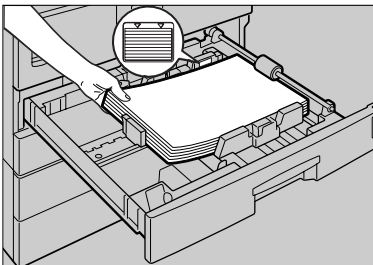

AA022S

Important

- Be sure to set the paper under the roller.
- Do not stack paper over the limit mark.

- 8** While pressing the release lever, adjust the side and back fences to the new paper size.

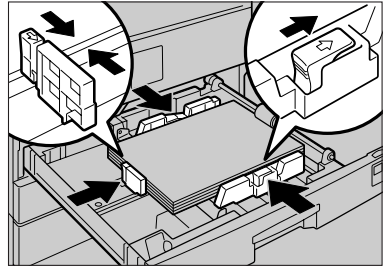

ZENY320E

Important

- When setting small quantities of copy paper, be careful not to squeeze in the side fence too much or paper will not feed in properly.

- 9** Press down the lock button.

- 10** Adjust the tray size to the new paper size using the paper size selector.

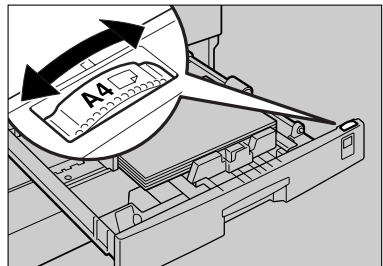

ZENY281E

Note

- Be sure to set the correct size, otherwise a paper jam might occur.

- 11** Push the paper tray in until it stops.

Changing the Paper Size in the Optional Paper Tray Unit

1 Make sure the paper tray is not in use.

2 Pull out the paper tray until it stops.

 **Note**

- Remove any remaining copy paper.

4

3 While pinching the release lever, adjust the back fence.

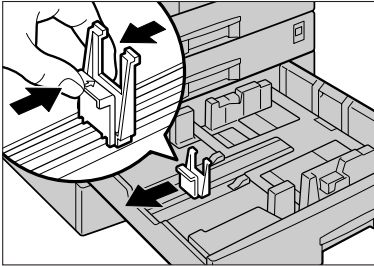

ZENY460E

4 Press down the release button.



ZENY470E

5 While pressing the release lever, adjust the side fences.

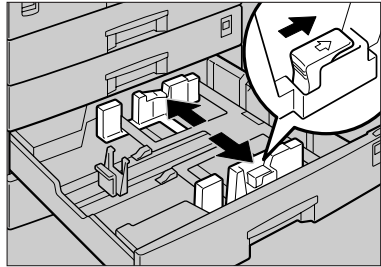

ZENY480E

6 Square the paper and set it in the tray.

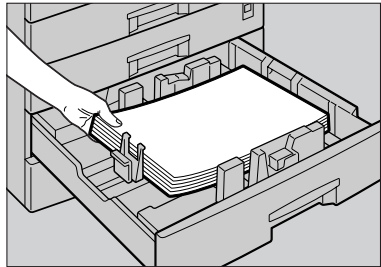

AAID345

 **Important**

- Do not stack paper over the limit mark.

7 While pinching the release lever, adjust the side and back fences to the new paper size.

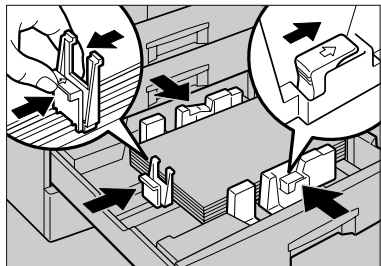

ZENY500E

Important

- ❑ When setting small quantities of copy paper, be careful not to squeeze in the side fence too much or paper will not feed in properly.

8 Press down the lock button.

9 Adjust the tray size to the new paper size using the paper size selector.

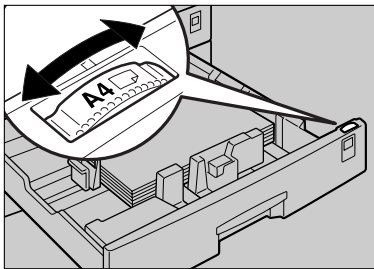

ZENY510E

Note

- ❑ Be sure to set the correct size, otherwise a paper jam might occur.

10 Push the paper tray in until it stops.

5. Other Functions

Other Functions

Displaying the Total Counter

You can display the total counter value used for all functions.

- 1 Press the **[User Tools/Counter]** key.

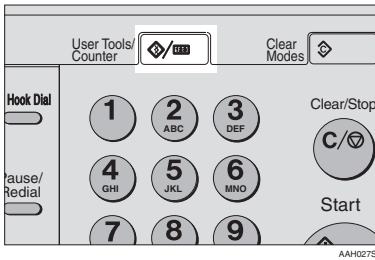

- 2 Select **[Counter]** using **[▲]** or **[▼]**, and then press the **[OK]** key.

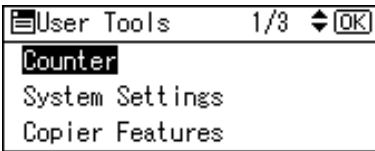

- 3 To print the counter list, press **[Print]**.

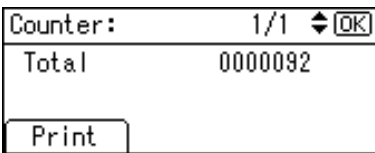

Note

- To print the counter list, set the paper size to larger than A4 or $8\frac{1}{2}'' \times 11''$.

- 4 Press the **[Start]** key.

A counter list prints out.

- 5 Press the **[User Tools/Counter]** key.

Changing the Language

You can change the language used on the display. English is set as default.

- 1 Press the **[User Tools/Counter]** key.

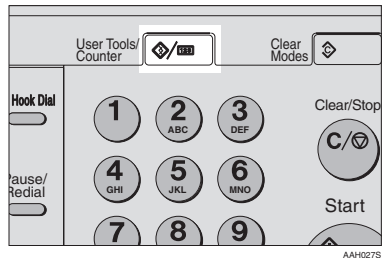

- 2 Select **[Language]** using **[▲]** or **[▼]**, and then press the **[OK]** key.

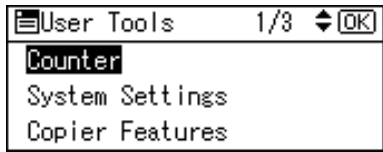

- 3 Select the language using **[▲]** or **[▼]**, and then press the **[OK]** key.

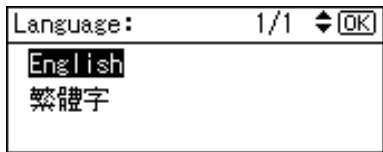

The "Programmed" message appears, and then the "User Tools" display returns.

- 4 Press the **[User Tools/Counter]** key.

6. Entering Text

Entering Text

This section describes how to enter characters. When you enter a character, it appears at the cursor position. If there is a character already at the cursor position, the newly entered character appears before it.

Available Characters

- Alphabetic characters
ABCDEFGHIJKLMNOPQRSTUVWXYZ-
vwxyz
- Symbols
0123456789

Keys

- ◆ **Number keys**
Use to enter numbers.
- ◆ **Quick Dial 01/17 to Quick Dial 09/25 (A to Z)**
Press these to enter upper and lower case letters.
- ◆ **[Shift] key (Quick Dial 13/29)**
Use to switch between uppercase and lowercase.
- ◆ **[Space] key (Quick Dial 14/30)**
Press to enter a space.
- ◆ **[Clear/Stop] key**
Deletes a character at the cursor position. You can delete a character at the right end of a line even if the cursor is placed to the right of the character.

◆ [◀] or [▶]

Use to move the cursor left or right.

✎ Note

- To enter symbols, press the **[Symbols]** key.

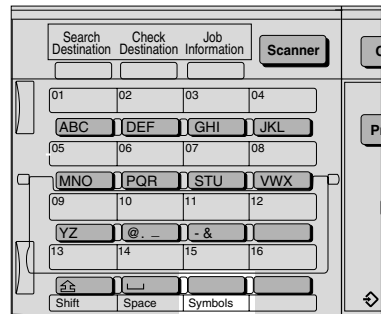

AA10635

How to Enter Text

Use the Quick Dial keys 01/17 to 09/25 for entering letters.

To enter letter, press the key again until it appears.

Quick Dial Key	Letters	Quick Dial Key	Letters
01/17	A, B, C	09/25	Y, Z
02/18	D, E, F	10/26	@, ., _
03/19	G, H, I	11/27	-, &
04/20	J, K, L	12/28	Nothing
05/21	M, N, O	13/29	Shift
06/22	P, Q, R	14/30	Space
07/23	S, T, U	15/31	Symbols
08/24	V, W, X	16/32	Nothing

Entering letters

- 1 Press the **[Shift]** key to switch between uppercase and lowercase.

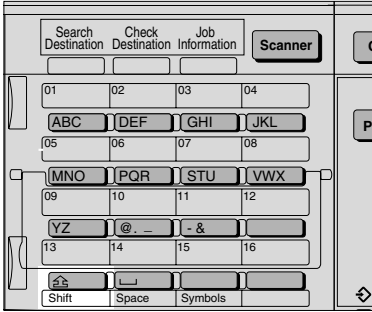

AA10648

- 2 Press a Quick Dial key.

A letter is entered and the cursor moves along one space.

Note

- To enter a character repeatedly, repeat step 2.
- To insert a character, press **[◀]** or **[▶]** to move the cursor to the character you want to enter.

Entering symbols

- 1 Press the **[Symbols]** key.

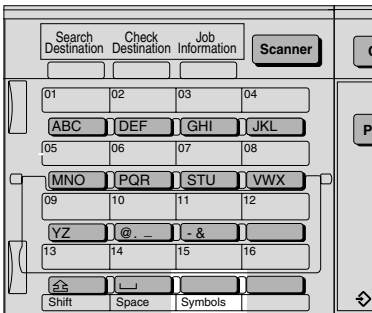

AA10638

- 2 Select the desired symbol using the cursor keys, and then press the **[OK]** key.

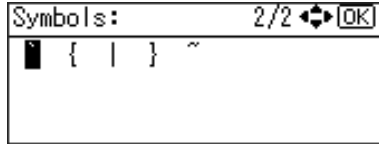
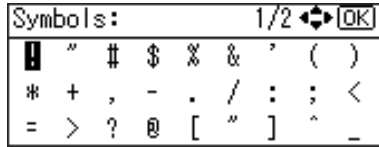

Note

- To enter another symbol, repeat steps 1 to 2.

Entering numbers

- 1 Press a number key.

The numeral is entered and the cursor moves.

Note

- To insert a character, press **[◀]** or **[▶]** to move the cursor to the character you want to enter.

Deleting characters

- 1 Move the cursor to the character you want to delete using **[◀]** or **[▶]**.

- 2 Press the **[Clear/Stop]** key.

The character at the cursor position is deleted.

Note

- To delete another character, repeat steps 1 and 2.

Security

Confidential information is always at risk of being copied without permission or subject to unauthorized access through the network. To protect documents from such intrusion, not only can passwords be set, but also the Extended Security function can be used to strengthen security.

For those who require increased document protection, we recommend the Extended Security function.

Primary Security Functions

❖ **Protecting Image Data Remaining in Memory**

Protects image data remaining in memory. When a copy or print job is completed, or a job is canceled, the data is secure.

❖ **Protecting against Unauthorized Access via Phone Line**

Accepts only facsimile calls.

❖ **Authenticating Administrator**

Protects essential functions for administrating document security using an access code. See p.34 "Key Operator Code".

Extended Security Function

 **Note**

- When the Extended Security function is on, delivery server settings cannot be changed. Turn the function off to change the settings.

Setting Extended Security

 **Preparation**

The Extended Security setting is not available unless the key operator code set in the Key Operator Code settings of the System Settings has six or more digits. See p.34 "Key Operator Code".

 **Note**

- To ensure increased document protection under the Extended Security setting, we recommend you select **[On: All]** when programming a key operator code.

1 Press the **[User Tools/Counter]** key.

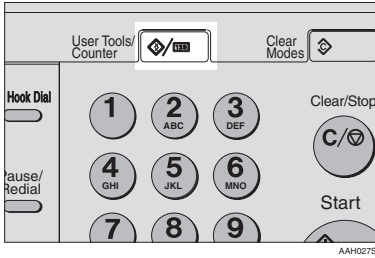

2 Select **[System Settings]** using **[▲]** or **[▼]**, and then press the **[OK]** key.

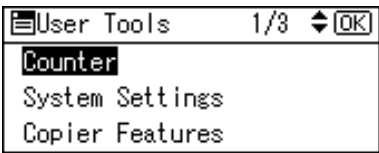

3 Select **[Key Operator Tools]** using **[▲]** or **[▼]**, and then press the **[OK]** key.

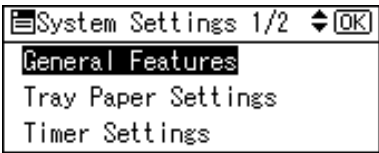

4 Select **[Extended Security]** using **[▲]** or **[▼]**, and then press the **[OK]** key.

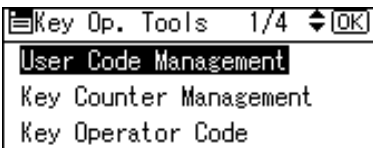

5 Select **[On]** using **[▲]** or **[▼]**, and then press the **[OK]** key.

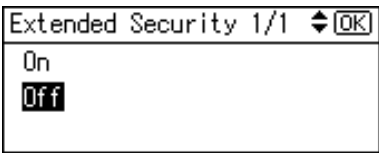

The “Programmed” message appears, and then the “User Tools” display returns.

6 Press the **[User Tools/Counter]** key.

Operating Environment and Notes

Security for this machine is assured on the premises that the machine is used under the following conditions:

Operating Environment

- The condition of the machine is normal. (For example, it is not damaged, modified, or lacking components.)
- When the machine is connected to a network, the machine is protected from illegitimate access including unauthorized packet sniffing.
- The machine is managed by an administrator with thorough knowledge of the machine and capable of providing the proper conditions under which users can use the machine safely.

For Administrator

- This machine does not protect against illegitimate actions on the network. To avoid any risks on the network, further security is required.
- Security of this machine cannot be assured if any hardware component is detached or replaced with an inappropriate component. If these things have the possibility of occurring, other security measures are necessary.
- Regularly check that the Extended Security function is on. Be sure to check it particularly after the machine is moved or a power failure occurs. See p.97 "Setting Extended Security".
- Avoid using a single number or consecutive numbers for a key operator code such as "00000000" or "12345678". Since the numbers like this are easy to guess, using them will not provide the appropriate level of security.
- Remote document management using SmartDeviceMonitor for Admin is not available when the Extended Security function is on.
- User code is a function to help manage the use of the machine. It is not to protect confidential documents from others. See p.45 "User Code (MFP)".

For User

- Before scanning originals using the scanner function, make sure all other operations are complete.

8. Specifications

Main Unit

- ❖ **Configuration:**
Desktop
- ❖ **Photosensitivity type:**
OPC drum
- ❖ **Original scanning:**
One-dimensional solid scanning system through CCD
- ❖ **Copy process:**
Dry electrostatic transfer system
- ❖ **Development:**
Dry two-component magnetic brush development system
- ❖ **Fusing:**
Heating roll pressure system
- ❖ **Resolution:**
600 dpi
- ❖ **Exposure glass:**
Stationary original exposure type
- ❖ **Original reference position:**
Rear left corner
- ❖ **Warm-up time:**
From the main power switch
15 seconds or less (20 °C)
From the operation switch
10 seconds or less (20 °C)
- ❖ **Originals:**
Sheet/book/objects
- ❖ **Maximum original size:**
A3☐, 11" × 17"☐

❖ **Copy paper size:**

- Trays: A3 \square – A5 \square , 11" \square – 17" \square – 5¹/₂" \square × 8¹/₂" \square
- Bypass: A3 \square – A6 \square , 11" \square – 17" \square – 5¹/₂" \square × 8¹/₂" \square
- Bypass (custom size):
Vertical: 90 – 305 mm, 3.5" – 12.0"
Horizontal: 148 – 1,260 mm, 5.8" – 49.6"

❖ **Copy paper weight:**

- Paper trays (Standard size): 60 – 90 g/m², 16 – 24 lb
- Bypass tray: 52 – 162 g/m², 14 – 43 lb

❖ **Non-reproduction area:**

- Leading edge: 2 ± 1.5 mm (0.08 ± 0.06 inch)
- Trailing edge: more than 0.5 mm (0.02 inch)
- Left edge: 2 ± 1.5 mm (0.08 ± 0.06 inch)
- Right edge: more than 0.5 mm (0.02 inch)

❖ **First copy time:**

6.5 seconds or less
(A4 \square , 8¹/₂" × 11" \square 100%, feeding from Tray 1)

❖ **Copying speed: (Type 1)**

- 16 copies/minute (A4 \square , 8¹/₂" × 11" \square)

❖ **Copying speed: (Type 2)**

- 20 copies/minute (A4 \square , 8¹/₂" × 11" \square)
18 copies/minute (feeding from Optional Paper Tray Unit)

❖ **Reproduction ratio:**

Preset reproduction ratios:

—	Metric version	Inch version
Enlargement	200%	155%
	141%	129%
	122%	121%
Full Size	100%	100%
Reduction	93%	93%
	82%	78%
	71%	65%
	50%	50%

Zoom: From 50% to 200% in 1% steps.

❖ **Continuous copying count:**

1 – 99 copies

❖ **Copy paper capacity:**

Type 1:

- Tray 1: 250 sheets (80 g/m², 20 lb)
- Bypass: 100 sheets (80 g/m², 20 lb)

Type 2:

- Tray 1, 2: 250 sheets (80 g/m², 20 lb)
- Bypass: 100 sheets (80 g/m², 20 lb)

❖ **Power consumption:**

	Main unit only	Complete system ^{*1}
Warm up	Less than 1,280 W	Less than 1,280 W
Stand-by	About 110 W	About 130 W
During printing	About 440 W	About 450 W
Maximum	Less than 1,280 W	Less than 1,280 W

^{*1} Main unit with the optional fax unit, printer/scanner unit, and paper tray unit.

❖ **Dimensions (W × D × H up to exposure glass):**

Type 1: 550 × 568 × 420 mm, 21.65" × 22.36" × 16.54"

Type 2: 550 × 568 × 558 mm, 21.65" × 22.36" × 21.97"

❖ **Noise Emission ^{*1} :**

- Sound power level

	Main unit only	Complete system ^{*3}
Stand-by	40 dB (A)	40 dB (A)
During printing	59 dB (A)	66 dB (A)

- Sound pressure level ^{*2}

	Main unit only	Complete system ^{*3}
Stand-by	26 dB (A)	26 dB (A)
During printing	46 dB (A)	55 dB (A)

^{*1} The above measurements made in accordance with ISO 7779 are actual values.

^{*2} Measured at the position of the operator.

^{*3} The Complete system consists of a main unit with full options installed.

❖ **Weight:**

Type 1: 35 kg (78 lb) or less

Type 2: 44 kg (96 lb) or less

 **Note**

- Specifications are subject to change without notice.

Options

Exposure Glass Cover







Lower this over originals.

Auto Document Feeder (ADF)

◆ **Mode:**

- ADF mode

◆ **Original size:**

- A3  – A5  
- 11" × 17"  – 5¹/₂" × 8¹/₂"  

◆ **Original weight:**

- 52 – 105 g/m² (14 – 28 lb)

◆ **Number of originals to be set:**

- 30 sheets (80 g/m², 20 lb)

◆ **Maximum power consumption:**

- less than 25 W (power is supplied from the main unit.)

◆ **Dimensions (W × D × H):**

- 550 × 470 × 90 mm, 21.7" × 18.6" × 3.6"

◆ **Weight:**

- 7 kg (15 lb) or less

 **Note**

- Specifications are subject to change without notice.

Internal Tray 2 (1 bin tray)

◆ **Number of bins:**

1

◆ **Paper size:**

- A3 - A5
- 11" × 17" - 5¹/₂" × 8¹/₂"

◆ **Paper capacity:**

100 sheets (80 g/m², 20 lb.)

◆ **Paper weight:**

60 - 105 g/m² (20 - 28lb.)

◆ **Maximum power consumption:**

20 W

◆ **Dimension (W × D × H)**

Unit: 222 × 478 × 104 mm

Tray: 335 × 390 × 26 mm

◆ **Weight:**

2 kg (4 lb) or less

 **Note**

Specifications are subject to change without notice.

8

Paper Tray Unit (1-tray type)

◆ **Paper weight:**

60 - 105 g/m² (16 - 28 lb.)

◆ **Paper size:**

A3☐, B4 JIS☐, A4☐☐, B5 JIS☐☐, A5☐, 11" × 17"☐, 8¹/₂" × 14"☐, 8¹/₂" × 13"☐, 8¹/₂" × 11"☐☐, 8¹/₄" × 13"☐, 8" × 13"☐, 7¹/₄" × 10¹/₂"☐☐, 8¹/₄" × 14"☐, 5¹/₂" × 8¹/₂"☐, 8K☐, 16K☐☐

◆ **Maximum power consumption:**

23 W (power is supplied from the main frame.)

◆ **Paper capacity:**

500 sheets (80 g/m², 20 lb)

◆ **Dimensions (W × D × H):**

550 × 520 × 134 mm, 21.7" × 20.5" × 5.36"

◆ **Weight:**

12 kg (26 lb) or less



Note

☐ Specifications are subject to change without notice.

Paper Tray Unit (2-tray type)

◆ **Paper weight:**

60 – 105 g/m² (16 – 28 lb.)

◆ **Paper size:**

A3☐, B4 JIS☐, A4☐☐, B5 JIS☐☐, A5☐, 11" × 17"☐, 8¹/₂" × 14"☐, 8¹/₂" × 13"☐, 8¹/₂" × 11"☐☐, 8¹/₄" × 13"☐, 8" × 13"☐, 7¹/₄" × 10¹/₂"☐☐, 8¹/₄" × 14"☐, 5¹/₂" × 8¹/₂"☐, 8K☐, 16K☐☐

◆ **Maximum power consumption:**

28 W (power is supplied from the main frame.)

◆ **Paper capacity:**

500 sheets (80 g/m², 20 lb.) × 2 trays

◆ **Dimensions (W × D × H):**

550 × 520 × 271 mm, 21.7" × 20.5" × 10.7"

◆ **Weight:**

25 kg (55 lb) or less





Note









































☐ Specifications are subject to change without notice.

Copy Paper

Recommended Paper Sizes and Types

The following limitations apply to each tray:

	Metric version	Inch version	Paper weight	Paper capacity
Paper tray 1 (Type 1) Paper tray 1, 2 (Type 2)	A3, B4JIS, A4, B5JIS, A5, 11" × 17", 8 ¹ / ₂ " × 14", 8 ¹ / ₂ " × 13", 8 ¹ / ₄ " × 14", 8 ¹ / ₄ " × 13", 8" × 13", 8 ¹ / ₂ " × 11", 7 ¹ / ₄ " × 10 ¹ / ₂ ", 5 ¹ / ₂ " × 8 ¹ / ₂ ", 8K ^{*3} , 16K ^{*4}		60 – 90 g/m ² , 16 – 24 lb	250 sheets ^{*1}
	<p> Note</p> <p><input type="checkbox"/> You can specify the paper size with the user tools or the paper size selector. See p.88 "Changing the Paper Size".</p>			
Paper tray unit (optional)	A3, B4JIS, A4, B5JIS, A5, 11" × 17", 8 ¹ / ₂ " × 14", 8 ¹ / ₂ " × 13", 8 ¹ / ₄ " × 14", 8 ¹ / ₄ " × 13", 8" × 13", 8 ¹ / ₂ " × 11", 7 ¹ / ₄ " × 10 ¹ / ₂ ", 5 ¹ / ₂ " × 8 ¹ / ₂ ", 8K ^{*3} , 16K ^{*4}		60 – 105 g/m ² , 16 – 28 lb	500 sheets ^{*1}
	<p> Note</p> <p><input type="checkbox"/> You can specify the paper size with User Tools or the paper size selector. See p.88 "Changing the Paper Size".</p>			

		Metric version	Inch version	Paper weight	Paper capacity
Bypass tray	Standard Sizes	A3  , B4JIS 		52 – 162 g/m ² , 14 – 43 lb	10 sheets ^{*1}
		A4  , B5JIS  , A5  , B6JIS 			100 sheets ^{*1}
		11" × 17"  ^{*2} , 8 ¹ / ₂ " × 14"  , 8 ¹ / ₂ " × 13" (F4)  , 8 ¹ / ₄ " × 14"  , 8 ¹ / ₄ " × 13"  8" × 13" (F)  , 8 ¹ / ₂ " × 11"  , 7 ¹ / ₄ " × 10 ¹ / ₂ "  , 5 ¹ / ₂ " × 8 ¹ / ₂ "  , 8K  ^{*3} , 16K  ^{*4}			
		A3  , B4JIS 		60 – 157 g/m ² , 16 – 42 lb	10 sheets ^{*1}
		A4  , B5JIS  , A5  , B6JIS 			40 sheets ^{*1}
		11" × 17"  , 8 ¹ / ₂ " × 14"  , 8 ¹ / ₂ " × 13"  8" × 13"  , 8" × 13"  , 8 ¹ / ₂ " × 11"  , 7 ¹ / ₄ " × 10 ¹ / ₂ "  , 5 ¹ / ₂ " × 8 ¹ / ₂ "  , 8K  ^{*3} , 16K  ^{*4}			
	 Note <input type="checkbox"/> You can specify the paper size. See <i>Copy Reference</i> .				
	Custom sizes ^{*5}	Translucent paper (A3  , B4JIS ), OHP transparencies			10 sheets
		Translucent paper (A4  , B5JIS )			40 sheets
		Adhesive labels (B4JIS  , A4 )			1 sheet
Envelope (C5, C6, DL, Monarch, Commercial #10)			10 sheets		

^{*1} Paper weight: 80 g/m², 20 lb

^{*2} When you set custom size paper in the bypass tray, you can specify the size. See *Copy Reference*.

^{*3} 8K(Ba-Kai) = 267 × 390 mm, 10.6" × 15.4"

^{*4} 16K(Shi-Lui-Kai) = 195 × 267 mm, 7.7" × 10.6"

^{*5} Set one sheet at a time for your needs. See *Copy Reference*.

 **Important**

- If you use damp or curled paper, a misfeed might occur. In such a case, try turning over the paper stack in the paper tray. If there is no improvement, change to copy paper with less curl.

 **Note**

- When using the bypass tray, we recommend you set the copy paper direction to .
- If you load paper of the same size and in the same direction in two or more trays, the machine automatically shifts to another tray when the tray in use runs out of paper. This function is called Auto Tray switching. This saves interrupting a copy run to replenish paper even when making a large number of copies. You can cancel this setting.

Reference

To add paper, see *Copy Reference*.

To change the paper size, see p.88 “Changing the Paper Size”.

Unusable Paper

CAUTION:

- *Do not use aluminum foil, carbon paper, or similar conductive paper to avoid a fire or machine failure.*

Important

- Do not use any of the following kinds of paper or a fault might occur:
 - Thermal fax paper
 - Art paper
 - Aluminum foil
 - Carbon paper
 - Conductive paper
- Do not use copy paper that has been already copied on. Otherwise, a paper misfeed might occur.

Note

- Do not use any of the following kinds of paper or a misfeed might occur.
 - Bent, folded, or creased paper
 - Torn paper
 - Slippery paper
 - Perforated paper
 - Rough paper
 - Thin paper that has low stiffness
 - Paper with a dusty surface
- If you make copies on rough grain paper, the copy image might come out blurred.
- Do not use paper already copied or printed on.

Paper Storage

 **Note**

- When storing paper, the following precautions should always be followed:
 - Do not store paper where it will be exposed to direct sunlight.
 - Avoid storing paper in humid areas (humidity: 70% or less).
 - Store on a flat surface.
- Keep open reams of papers in the package, and store as you would unopened paper.
- Under conditions of high temperature and high humidity, or low temperature and low humidity conditions, store papers in a plastic bag.

INDEX

A

- Accessing user tools (System Settings), 26
- Address Book, 43
 - Print List*, 38
 - Program/Change/Delete Group*, 37
- Address Book Management, 37
- AOF (Always On), 38
- Auto Document Feeder (ADF), 13, 104
- Auto off timer, 32
- Auto reset timer, 32
 - copier*, 33
 - facsimile*, 33
 - scanner*, 33

B

- Bypass tray, 12

C

- Changing a group name, 79
- Changing a registered e-mail destination, 66
- Changing a registered fax destination, 57
- Changing a user code, 40, 46
- Changing default settings, 26
- Changing modes, 19
- Changing the language, 93
- Changing the paper size, 88
- Changing the paper size in the optional paper tray unit, 90
- Changing the paper size of the paper tray, 88
- Clearing misfeeds, 85
- Clearing the counter, 42, 54
- Combined function operations, 19
- Common key operations, 18
- Control panel, 12, 15
- Copy Count Display, 28
- Copy paper, 107
- Counter per User Code, 36

D

- Deleting a destination from a group, 75
- Deleting a group, 81
- Deleting a registered e-mail destination, 69
- Deleting a registered fax destination, 60
- Deleting a user code, 40, 49

- Display, 17
- Display Contrast, 29
- Displaying the counter for each user code, 41, 52
- Displaying the destinations registered in groups, 78
- Displaying the total counter, 93
- Display/Print Counter, 35

E

- E-mail destination, 64
- Energy Saver Timer, 32
- Entering Text, 95
 - Available Characters*, 95
 - Deleting characters*, 96
 - Entering letters*, 96
 - Entering numbers*, 96
 - Entering symbols*, 96
 - Keys*, 95
- Entering text, 95
- Exposure glass, 11
- Exposure glass cover, 13, 104
- Extended Security, 35
- Extended Security Function, 97
- External options, 13

F

- Fax destination, 55
- For administrator, 99
- For user, 99
- Front cover, 12
- Function Priority, 28

G

- General Features, 28
- Guide to components, 11

I

- If your machine does not operate as you want, 83
- Internal options, 14
- Internal tray, 11
- Internal tray 2 (1 bin tray), 105

K

Key Counter Management, 34
Key Operator Code, 34
Key Operator Tools, 34
Key Repeat, 29

L

Letters, 96
Lower right cover, 12

M

Main power indicator, 12
Main power switch, 12
Main unit, 101
Measurement Unit, 29
Multi-access, 21

O

On indicator, 12
Operating environment, 99
Operation switch, 12
Options, 13, 104
Other functions, 93
Output
 copier (copier), 29
 facsimile (facsimile), 29
 printer (printer), 29
Output tray settings, 29

P

Panel Tone, 28
Paper Storage, 110
Paper tray, 12
Paper tray priority
 copier, 31
 facsimile, 31
 printer, 31
Paper tray unit, 12
Paper tray unit (1-tray type), 13, 105
Paper tray unit (2-tray type), 13, 106
Paper type
 Bypass tray, 31
 Tray 1-4, 31
Primary security functions, 97
Printing the counter for each user code, 42, 53
Print Priority, 28
Program/Change User Code
 (for machine with copier function only), 37

Q

Quitting user tools, 27

R

Reading the display and using keys, 17
Recommended paper sizes and types, 107
Registering a destination to a group, 74
Registering a fax destination, 55
Registering an e-mail destination, 64
Registering a new group, 73
Registering a new user code, 39, 45
Registering destination information, 44
Registering destinations to a group, 73
Registering sender information, 44
Right cover, 12

S

Security, 97
Set date, 33
Set time, 33
Settings you can change with user tools, 28
Specifications, 101
Symbols, 96
System Auto Reset Timer, 32
System reset, 20

T

Timer settings, 32
Tray paper settings, 30
Tray paper size, 30
Troubleshooting, 83

U

Unusable paper, 109
User code
 machine with copier function, 39
 MFP, 45
User Code Management, 34
User Tools Menu (System Settings), 23

V

Ventilation holes, 11

MEMO

MEMO

In accordance with IEC 60417, this machine uses the following symbols for the main power switch:

I means **POWER ON.**

⏻ means **STAND BY.**

Type for DSm616/LD116/Aficio 2016
Type for DSm620/LD120/Aficio 2020
Printed in China
AE **AE** B259-6508



Free Manuals Download Website

<http://myh66.com>

<http://usermanuals.us>

<http://www.somanuals.com>

<http://www.4manuals.cc>

<http://www.manual-lib.com>

<http://www.404manual.com>

<http://www.luxmanual.com>

<http://aubethermostatmanual.com>

Golf course search by state

<http://golfingnear.com>

Email search by domain

<http://emailbydomain.com>

Auto manuals search

<http://auto.somanuals.com>

TV manuals search

<http://tv.somanuals.com>