



**8035/8045**  
DSm735 / DSm745  
*LD235 / LD245*  
**Aficio™ 3035 / 3045**

**Operating Instructions**  
**Copy Reference**



- 
- 1** Placing Originals
  - 2** Copying
  - 3** Troubleshooting
  - 4** User Tools (Copier/Document Server Features)
  - 5** Specifications

---

Read this manual carefully before you use this machine and keep it handy for future reference. For safe and correct use, be sure to read the Safety Information in the "General Settings Guide" before using the machine.

## Introduction

This manual contains detailed instructions and notes on the operation and use of this machine. For your safety and benefit, read this manual carefully before using the machine. Keep this manual in a handy place for quick reference.

## Important

Contents of this manual are subject to change without prior notice. In no event will the company be liable for direct, indirect, special, incidental, or consequential damages as a result of handling or operating the machine.



## Notes

Some illustrations in this manual might be slightly different from the machine.

Certain options might not be available in some countries. For details, please contact your local dealer.



## Caution:

Use of controls or adjustments or performance of procedures other than those specified in this manual might result in hazardous radiation exposure.

## Notes:

The model names of the machines do not appear in the following pages. Check the type of your machine before reading this manual. (For details, see p.3 "Machine Types".)

- Type 1: 8035/DSm735/LD235/Aficio3035
- Type 2: 8045/DSm745/LD245/Aficio3045

Certain types might not be available in some countries. For details, please contact your local dealer.

Two kinds of size notation are employed in this manual. With this machine refer to the inch version.

For good copy quality, the supplier recommends that you use genuine toner from the supplier.

The supplier shall not be responsible for any damage or expense that might result from the use of parts other than genuine parts from the supplier with your office products.

## Power Source

120V, 60Hz, 12A or more

Please be sure to connect the power cord to a power source as above. For details about power source, see "Power Connection" in the General Settings Guide.

# Manuals for This Machine

The following manuals describe the operational procedures of this machine. For particular functions, see the relevant parts of the manual.

## **Note**

- Manuals provided are specific to machine type.
- Adobe Acrobat Reader/Adobe Reader is necessary to view the manuals as a PDF file.
- Two CD-ROMs are provided:
  - CD-ROM 1 "Operating Instructions"
  - CD-ROM 2 "Scanner Driver and Document Management Utility"

## **❖ General Settings Guide**

Provides an overview of the machine and describes System Settings (such as Tray Paper Settings), Document Server functions, and troubleshooting. Refer to this manual for Address Book procedures such as registering fax numbers, e-mail addresses, and user codes.

## **❖ Security Reference**

This manual is for administrators of this machine. It describes security functions that the administrators can use to protect data from being tampered, or prevent the machine from unauthorized use. Also refer to this manual for the procedures for registering administrators, as well as setting user and administrator authentication.

## **❖ Network Guide (PDF file - CD-ROM1)**

Provides information about configuring and operating the printer in a network environment or using software. This manual covers all models, and therefore contains functions and settings that may not be available for your model. Images, illustrations, functions, and supported operating systems may differ from those of your model.

## **❖ Copy Reference (this manual)**

Describes operations, functions, and troubleshooting for the machine's copier function.

## **❖ Facsimile Reference <Basic Features>**

Describes operations, functions, and troubleshooting for the machine's facsimile function.

## **❖ Facsimile Reference <Advanced Features>**

Describes advanced facsimile functions such as line settings and procedures for registering IDs.

## **❖ Printer Reference**

Describes system settings, operations, functions, and troubleshooting for the machine's printer function.

❖ **Scanner Reference (PDF file - CD-ROM1)**

Describes operations, functions, and troubleshooting for the machine's scanner function.

❖ **Manuals for DeskTopBinder Lite**

DeskTopBinder Lite is a utility included on the CD-ROM labeled "Scanner Driver and Document Management Utility".

- DeskTopBinder Lite Setup Guide (PDF file - CD-ROM2)  
Describes installation of, and the operating environment for DeskTopBinder Lite in detail. This guide can be displayed from the **[Setup]** display when DeskTopBinder Lite is installed.
- DeskTopBinder Introduction Guide (PDF file - CD-ROM2)  
Describes operations of DeskTopBinder Lite and provides an overview of its functions. This guide is added to the **[Start]** menu when DeskTopBinder Lite is installed.
- Auto Document Link Guide (PDF file - CD-ROM2)  
Describes operations and functions of Auto Document Link installed with DeskTopBinder Lite. This guide is added to the **[Start]** menu when DeskTopBinder Lite is installed.

❖ **Other manuals**

- PS3 Supplement (PDF file - CD-ROM1)
- Unix Supplement (Available from an authorized dealer, or as a PDF file on our Web site.)

# What You Can Do with This Machine

## Types of Duplex Copies

- 1-sided 2 Pages → 2-sided 1 Page (see p.46  
"❖ 1 Sided → 2 Sided")

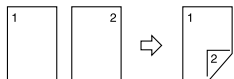

- 2-sided 1 Page → 2-sided 1 Page (see p.46  
"❖ 2 Sided → 2 Sided")

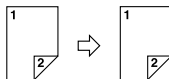

- 1-sided 4 Pages → 2-sided 1 Page (see p.49  
"❖ 1 Sided 4 Pages → Combine 2 Side")

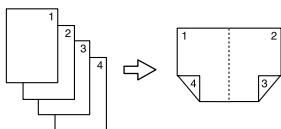

- 2-sided 2 Pages → 2-sided 1 Page (see p.50  
"❖ 2 Sided 4 Pages → Combine 2 Side")

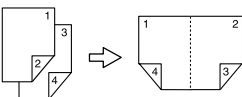

- 1-sided 8 Pages → 2-sided 1 Page (see p.49  
"❖ 1 Sided 8 Pages → Combine 2 Side")

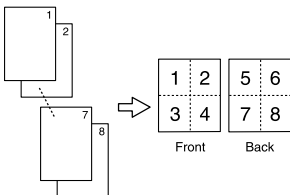

- 2-sided 4 Pages → 2-sided 1 Page (see p.50  
"❖ 2 Sided 8 Pages → Combine 2 Side")

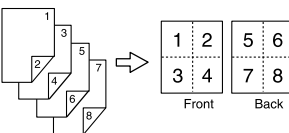

- 1-sided 16 Pages → 2-sided 1 Page (see p.50  
"❖ 1 Sided 16 Pages → Combine 2 Side")

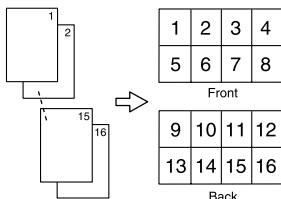

- 2-sided 8 Pages → 2-sided 1 Page (see p.50  
"❖ 2 Sided 16 Pages → Combine 2 Side")

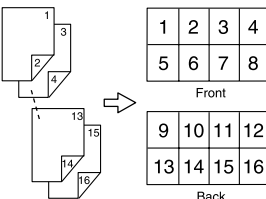

- Bound Originals → 2-sided Pages (see p.51  
"❖ Book → 2 Sided")

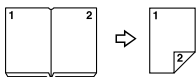

- Front/Back Bound Originals → 2-sided Pages (see p.51  
"❖ Front & Back → 2 Sided")

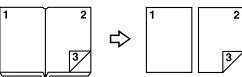

## Copying Book Originals

● 1-sided 4 Pages → Booklet (see p.52 " ❖ 1 Sided → Booklet")

Open to Left

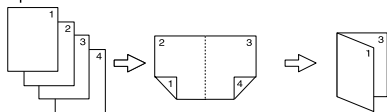

Open to Right

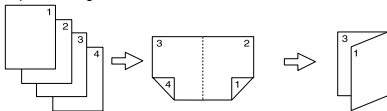

● 2-sided 2 Pages → Booklet (see p.52 " ❖ 2 Sided → Booklet")

Open to Left

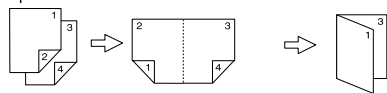

Open to Right

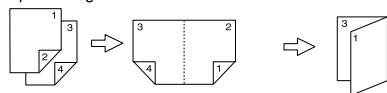

● 1-sided → Magazine (see p.53 " ❖ 1 Sided → Magazine")

Open to Left

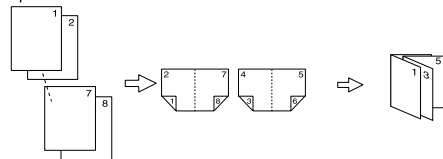

Open to Right

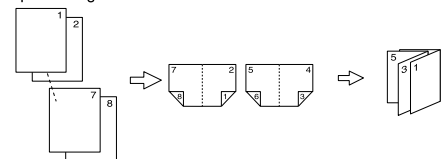

● 2-sided → Magazine (see p.53 " ❖ 2 Sided → Magazine")

Open to Left

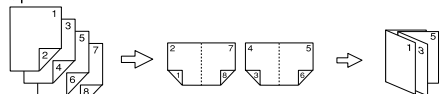

Open to Right

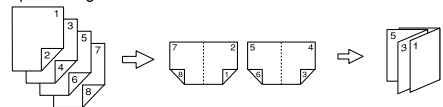

## Combining Multiple Pages onto a Single Page (see p.48 "One-Sided Combine")

● 1-sided 2 Pages → 1-sided 1 Page

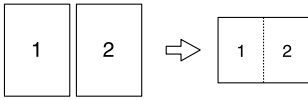

● 2-sided 1 Page → 1-sided 1 Page

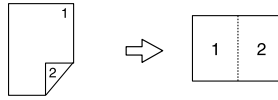

● 1-sided 4 Pages → 1-sided 1 Page

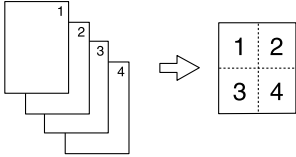

● 2-sided 2 Pages → 1-sided 1 Page

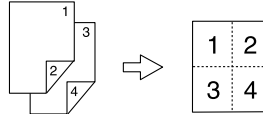

● 1-sided 8 Pages → 1-sided 1 Page

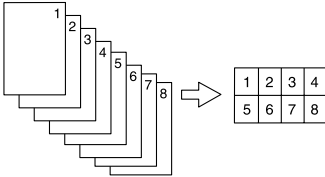

● 2-sided 4 Pages → 1-sided 1 Page

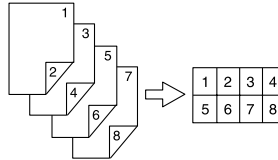

## Copying Originals Such as Books (see p.51 "Series Copies")

● Bound Originals → 1-sided Pages

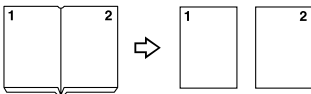

## Copying 2-Sided Pages onto 1-Sided Pages (see p.46 "2 Sided → 1 Sided")

● 2-sided 1 page → 1-sided 2 pages

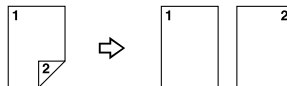

● Bound Originals → 2-sided Pages

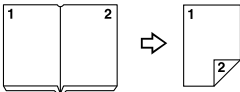

● Front/Back Bound Originals → 2-sided Pages

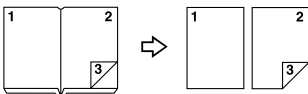

# TABLE OF CONTENTS

<b>Manuals for This Machine</b> .....	<b>i</b>
<b>What You Can Do with This Machine</b> .....	<b>iii</b>
<b>Notice</b> .....	<b>1</b>
<b>How to Read This Manual</b> .....	<b>2</b>
<b>Machine Types</b> .....	<b>3</b>
<b>Functions that Require Options</b> .....	<b>4</b>
<b>Control Panel</b> .....	<b>5</b>
Display Panel.....	7

## 1. Placing Originals

---

<b>Originals</b> .....	<b>9</b>
Sizes and Weights of Recommended Originals.....	9
Sizes Detectable by the Auto Paper Select.....	10
Missing Image Area.....	11
<b>Placing Originals</b> .....	<b>12</b>
Original Orientation.....	12
Placing Originals on the Exposure Glass.....	13
Placing Originals in the Auto Document Feeder.....	14

## 2. Copying

---

<b>Basic Procedure</b> .....	<b>17</b>
Interrupt Copy.....	18
Original Beeper.....	18
Job Preset.....	19
<b>Copying from the Bypass Tray</b> .....	<b>20</b>
<b>Copier Functions</b> .....	<b>23</b>
Adjusting Image Density.....	23
Selecting Original Type Setting.....	24
Selecting Copy Paper.....	25
Preset Reduce/Enlarge.....	28
Zoom.....	29
Auto Reduce/Enlarge.....	30
Size Magnification.....	30
Directional Magnification (%).....	31
Directional Size Magnification (inch).....	32
Sort.....	33
Stack.....	36
Staple.....	37
Punch.....	43
Duplex.....	46
One-Sided Combine.....	48
Two-Sided Combine.....	49
Series Copies.....	51
Booklet/Magazine.....	52
Image Repeat.....	54
Double Copies.....	55
Centring.....	56
Positive/Negative.....	57



Erase .....	57
Margin Adjustment .....	60
Background Numbering .....	61
Preset Stamp .....	61
User Stamp .....	62
Date Stamp .....	65
Page Numbering .....	66
Covers.....	70
Designate.....	71
Chapter .....	72
Slip Sheets.....	72
<b>Storing Data in the Document Server .....</b>	<b>74</b>
<b>Programs .....</b>	<b>75</b>
Storing a Program .....	75
Changing a Stored Program .....	76
Deleting a Program .....	76
Recalling a Program.....	76
<b>3. Troubleshooting</b>	
<hr/>	
<b>If Your Machine Does Not Operate As You Want.....</b>	<b>77</b>
When a Message Is Displayed.....	77
<b>If You Cannot Make Clear Copies.....</b>	<b>79</b>
<b>If You Cannot Make Copies As You Want .....</b>	<b>80</b>
When Memory Is Full .....	83
<b>4. User Tools (Copier/Document Server Features)</b>	
<hr/>	
<b>User Tools Menu (Copier/Document Server Features) .....</b>	<b>85</b>
<b>Accessing User Tools (Copier/Document Server Features).....</b>	<b>91</b>
Changing Default Settings .....	91
Exiting User Tools .....	91
General Features P. <sup>1</sup> / <sub>4</sub> .....	92
General Features P. <sup>2</sup> / <sub>4</sub> .....	94
General Features P. <sup>3</sup> / <sub>4</sub> .....	94
General Features P. <sup>4</sup> / <sub>4</sub> .....	95
Reproduction Ratio P. <sup>1</sup> / <sub>2</sub> .....	95
Reproduction Ratio P. <sup>2</sup> / <sub>2</sub> .....	96
Edit P. <sup>1</sup> / <sub>2</sub> .....	96
Edit P. <sup>2</sup> / <sub>2</sub> .....	98
Stamp.....	99
Input/Output .....	102
Administrator Tools .....	103
<b>5. Specifications</b>	
<hr/>	
<b>Combination Chart.....</b>	<b>105</b>
<b>Supplementary Informations .....</b>	<b>106</b>
<b>INDEX.....</b>	<b>119</b>



# Notice

Do not copy or print any item for which reproduction is prohibited by law.

Copying or printing the following items is generally prohibited by local law:

bank notes, revenue stamps, bonds, stock certificates, bank drafts, checks, passports, driver's licenses.

The preceding list is meant as a guide only and is not inclusive. We assume no responsibility for its completeness or accuracy. If you have any questions concerning the legality of copying or printing certain items, consult with your legal advisor.

# How to Read This Manual

---

## Symbols

---

The following set of symbols is used in this manual.

### **WARNING:**

This symbol indicates a potentially hazardous situation that might result in death or serious injury when you misuse the machine without following the instructions under this symbol. Be sure to read the instructions, all of which are described in the Safety Information section.

### **CAUTION:**

This symbol indicates a potentially hazardous situation that might result in minor or moderate injury or property damage that does not involve personal injury when you misuse the machine without following the instructions under this symbol. Be sure to read the instructions, all of which are described in the Safety Information section.

\* The statements above are notes for your safety.

### **Important**

If this instruction is not followed, paper might be misfed, originals might be damaged, or data might be lost. Be sure to read this.

### **Preparation**

This symbol indicates information or preparations required prior to operating.

### **Note**

This symbol indicates precautions for operation, or actions to take after abnormal operation.

### **Limitation**

This symbol indicates numerical limits, functions that cannot be used together, or conditions in which a particular function cannot be used.

### **Reference**

This symbol indicates a reference.

[   ]





Keys that appear on the machine's display panel.

[   ]

Keys built into the machine's control panel.

# Machine Types

This machine comes in two models which vary by copy speed. To make sure which model you have, see the inside front cover of this manual.

	Type 1	Type 2
Copy speed	35 copies/minute (A4  , 8 1/2" x 11"  )	45 copies/minute (A4  , 8 1/2" x 11"  )

# Functions that Require Options

The available functions depend on your machine configuration and which options you have. See the table below.

○ Required options

Functions		Shift Sort	Shift Stack	Staple	Saddle Stitch	Punch
Options	1000-Sheet finisher *1	○	○	○		
	2 Tray finisher *1	○	○	○		○
	Booklet finisher *1	○	○	○	○	

\*1 The bridge unit and paper tray unit are required when you install the finisher.

# Control Panel

## Note

- This illustration shows the control panel of the machine with options fully installed.

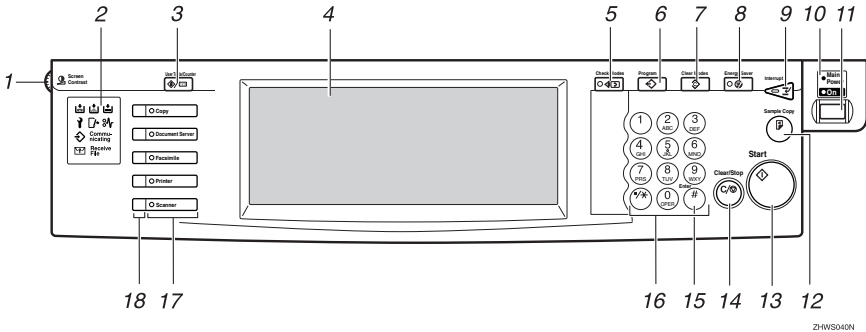

### 1. Screen Contrast knob

Adjusts the brightness of the display panel.

### 2. Indicators

Shows errors and machine status.

- : Add Staple indicator
- : Add Toner indicator
- : Load Paper indicator
- : Service Call indicator
- : Open Cover indicator
- : Misfeed indicator

See "Control Panel", *General Settings Guide*.

### 3. [User Tools/Counter] key

- User Tools  
Press to change the default and conditions to meet your requirements.
- Counter  
Press to check or print the counter value.

### 4. Display panel

Shows operation status, error messages, and function menus.

### 5. [Check Modes] key

Press to check the entered copy job settings.

### 6. [Program] key

Press to select the program mode. See p.75 "Programs".

### 7. [Clear Modes] key

Press to clear previously entered copy job settings.

### 8. [Energy Saver] key

Press to switch to and from the Energy Saver mode. See *General Settings Guide*.

### 9. [Interrupt] key

Press to interrupt a long copy job to make copies. See p.18 "Interrupt Copy".

### 10. Main power indicator

The main power indicator goes on when you turn on the main power. The power indicator lights when the power is on.

### Important

- Do not turn off the main power switch while the power indicator goes on or is flashing. The hard disk may malfunction.

### 11. Operation switch

Press to turn the power on (the **On** indicator goes on). To turn the power off, press again (the **On** indicator goes off).

## **12. [Sample Copy] key**

Use this key to make a single sample copy before starting a long copy run. By checking the sample copy and making any necessary changes to the image quality settings before you make multiple copies, you can save time and paper. See p.35 "Sample copy".

## **13. [Start] key**

Press to start copying. Press to start scanning and printing in Document Server mode.

## **14. [Clear/Stop] key**

- Clear  
Press to delete a number entered.
- Stop  
Press to stop a copy job in progress.

## **15. [#] key**

Press to enter a value.

## **16. Number keys**

Use to enter the desired number of copies and data for selected modes.

## **17. Function keys**

Press to select the following functions:

- Copier
- Document Server
- Facsimile
- Printer
- Scanner

## **18. Function status indicator**

These show the status of the above functions:

- Green: the function is active.
- Red: the function has been interrupted.



# Display Panel

## Note

- The following illustrations are examples for the machine with the optional 2 Tray finisher and Large Capacity Tray (LCT) installed.

## ❖ Initial copy display

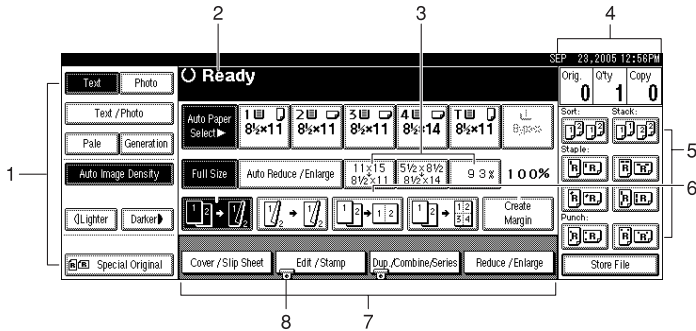

AHJ018S

**1. Original mode, Image Density and Special Original mode.**

**2. Operational status or messages.**

**3. You can register up to three frequently used reduce/enlarge ratios other than the fixed reduce/enlarge ratios. See p.95 "Shortcut R/E".**

**4. The number of originals scanned into memory, number of copies set, and number of copies made.**

**5. Sort, Stack, Staple or Punch mode.**

**6. Displays the contents of the Shortcut keys. You can register frequently used functions in these keys. See p.94 "Copy Function Key: F1-F5".**

**7. Shows the available functions. Press a function name to display its menu. For example, press the [Reduce/Enlarge] key to bring up the Reduce/Enlarge menu.**

**8. A clip mark appears for a currently selected function.**



# 1. Placing Originals

## Originals

---

### Sizes and Weights of Recommended Originals

---

#### ❖ Metric version

Where original is placed	Original size	Original weight
Exposure glass	Up to A3	--
ADF	One-sided originals: A3☐ – B6 JIS (Japanese Industrial Standard) ☐☐	40–128 g/m <sup>2</sup>
	Two-sided originals: A3☐ – A5☐☐	52–105 g/m <sup>2</sup>

#### ❖ Inch version

Where original is placed	Original size	Original weight
Exposure glass	Up to 11" × 17"	--
ADF	One-sided originals: 11" × 17"☐ – 5 <sup>1</sup> / <sub>2</sub> " × 8 <sup>1</sup> / <sub>2</sub> "☐☐	11–34 lb.
	Two-sided originals: 11" × 17"☐ – 5 <sup>1</sup> / <sub>2</sub> " × 8 <sup>1</sup> / <sub>2</sub> "☐☐	14–28 lb.

#### Note

- ☐ About 80 originals can be placed in the Auto Document Feeder (ADF).
- ☐ The weight range for originals in the Mixed Size mode is 52–81 g/m<sup>2</sup>, 13.8–21.5 lb.

---

### Non-compatible originals for the Auto Document Feeder

---

Placing the following types of originals in the ADF can cause paper misfeeds or result in damage to the originals. Place these originals on the exposure glass instead.

- Originals other than those specified on p.9 “Sizes and Weights of Recommended Originals”.
- Stapled or clipped originals
- Perforated or torn originals
- Curled, folded, or creased originals
- Pasted originals

1











- Originals with any kind of coating, such as thermal fax paper, art paper, aluminum foil, carbon paper, or conductive paper
- Originals with perforated lines
- Originals with indexes, tags, or other projecting parts
- Sticky originals such as translucent paper
- Thin, highly flexible originals
- Thick originals such as postcards
- Bound originals such as books
- Transparent originals such as OHP transparencies or translucent paper

 **Note**

- The original might become dirty if it is written with a pencil or a similar tool.

## Sizes Detectable by the Auto Paper Select

❖ **Metric version**











Size	A3 	B4 JIS 	A4 	B5 JIS 	A5 	B6 JIS 	11" × 17" 	8 <sup>1</sup> / <sub>2</sub> " × 14" 	8 <sup>1</sup> / <sub>2</sub> " × 11" 	5 <sup>1</sup> / <sub>2</sub> " × 8 <sup>1</sup> / <sub>2</sub> " 	8 <sup>1</sup> / <sub>2</sub> " × 13" 
Location of the original											
Exposure glass	○	○	○	○	×	×	×	×	○	×	○
ADF	○	○	○	○	○	○ <sup>*2</sup>	○	×	○	×	○

<sup>\*1</sup> You can select from 8<sup>1</sup>/<sub>2</sub>" × 13", 8<sup>1</sup>/<sub>4</sub>" × 13", 8" × 13" with User Tools (System Settings). See "<F/F4>Size Setting" in "General Features", *General Settings Guide*.

<sup>\*2</sup> The machine cannot detect two-sided originals of B6 JIS size.

○ : Detectable size × : Undetectable size

❖ **Inch version**

Size	A3 	B4 JIS 	A4 	B5 JIS 	A5 	11" × 17" 	8 <sup>1</sup> / <sub>2</sub> " × 14" 	8 <sup>1</sup> / <sub>2</sub> " × 11" 	5 <sup>1</sup> / <sub>2</sub> " × 8 <sup>1</sup> / <sub>2</sub> " 	8 <sup>1</sup> / <sub>2</sub> " × 13" 	10" × 14" 
Location of the original											
Exposure glass	×	×	×	×	×	○	○	○	×	×	×
ADF	○	×	○	×	×	○	○	○	○	×	○

○ : Detectable size × : Undetectable size

## ❖ Exposure glass

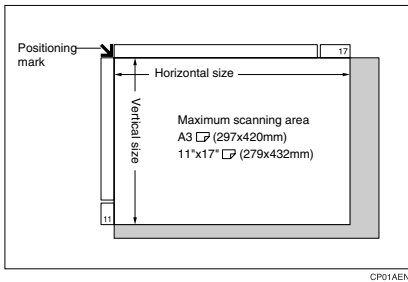

## ❖ ADF

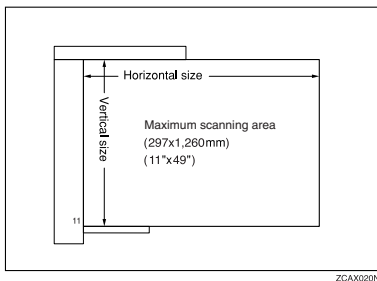

## 📌 Note

- ❑ When you copy custom size originals, make sure you specify the size of the originals. If not, the image may not be copied properly. See p.16 "Placing custom size originals".

## Sizes difficult to detect

It is difficult for the machine to detect the sizes of the following originals, so select the paper size manually.

- Originals with indexes, tags, or other projecting parts
- Transparent originals such as OHP transparencies or translucent paper
- Dark originals with a lot of text and drawings
- Originals which partially contain a solid image
- Originals which have solid images at their edges

## Missing Image Area

Even if you place originals in the ADF or on the exposure glass correctly, 3 mm (0.1") margins on all four sides might not be copied.

# Placing Originals

**Note**

- Take care to place originals after any correction fluid and ink has completely dried. Not taking this precaution could cause marks on the exposure glass that will be copied onto paper.

**Reference**

For original sizes you can set, see p.9 "Originals".

## Original Orientation

You can set the original orientation in the following ways.

This function is useful for copying torn originals or large originals.

❖ **Standard orientation** 

Select this function when the original orientation is the same as the copy paper orientation.

❖ **90° turn** 

Use this function when you want to copy A3, B4 JIS or 11" x 17" size originals. The machine rotates the copy image by 90° and you can make copies as you want. This is useful for copying large originals with the Staple, Duplex, Combine or Stamp functions.

For example, to copy A3 or 11" x 17" originals with the Staple function selected:

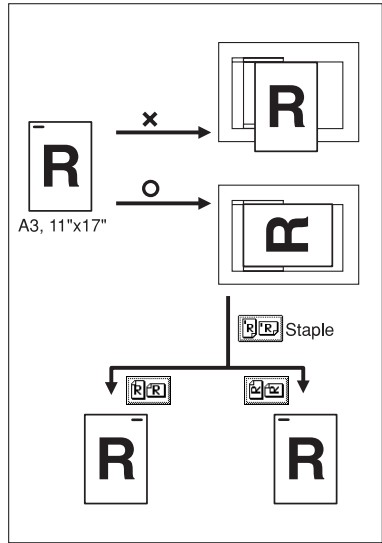

GGGSET3E

**Note**

- It is recommended to use this function together with the Auto Paper Select or the Preset Reduce/Enlarge function.

**1** Press [Special Original].

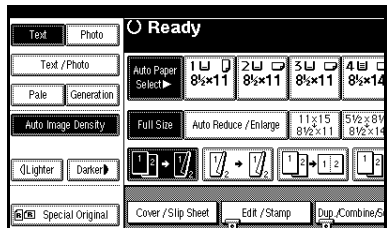

## 2 Select the original orientation.

Standard orientation

- 1 Make sure that  is selected.

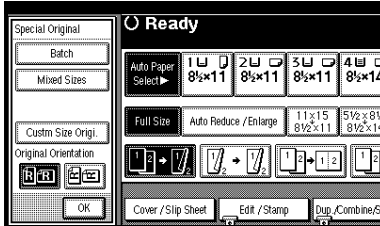

90° turn

- 1 Place your original in the landscape orientation, and then press .

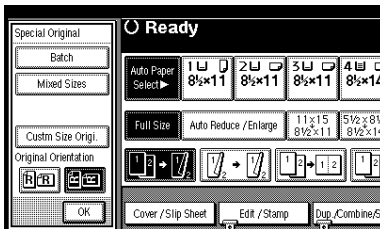

- 3 Press [OK].

## Placing Originals on the Exposure Glass

- 1 Lift the exposure glass cover or ADF.

### Important

- Do not lift the exposure glass cover or ADF forcefully. Otherwise, the cover of the ADF might open or be damaged.

### Note

- Be sure to lift the exposure glass cover or ADF by more than 30°. Otherwise, the size of the original might not be detected correctly.

- 2 Place the original face down on the exposure glass. The original should be aligned to the rear left corner.

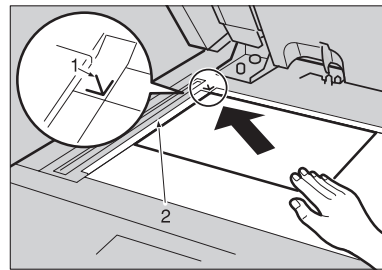

ZEW4050E

### 1. Positioning mark

### 2. Left scale

### Note

- Start with the first page to be copied.

- 3 Lower the exposure glass cover or ADF.

## Placing Originals in the Auto Document Feeder

1

Settings should be made in the following situations:

- ❖ **When placing originals one by one:**  
p.15 "SADF mode"
- ❖ **When placing originals consisting of more than 80 pages:**  
p.14 "Batch mode"
- ❖ **When copying originals of various sizes:**  
p.15 "Mixed size mode"
- ❖ **When placing custom size originals:**  
p.16 "Placing custom size originals"

### Note

- Do not stack originals beyond the limit mark on the side fence of the ADF.
- The last page should be on the bottom.
- Be sure not to block the sensor or load the original untidily. Doing so may cause the machine to detect the size of the scanned image incorrectly or display a paper mis-feed message. Also, be sure not to place originals or other objects on the top cover. Doing so may cause a malfunction.

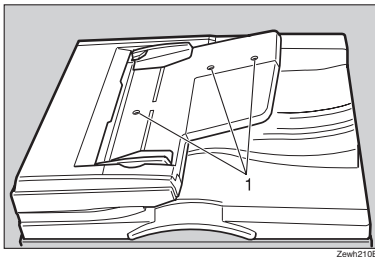

### 1. Sensors

- 1 Set the document guide to the original size.
- 2 Align the edges of the original and place it on the ADF with the side to be copied facing up.

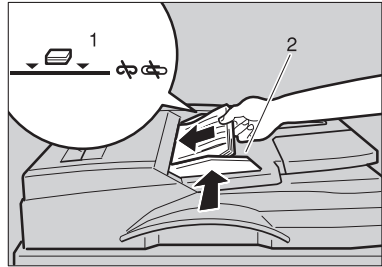

ZGHS060E

1. Limit mark
2. Document guide

### Note

- Straighten curls in the originals before placing them on the ADF.
- To prevent multiple sheets from being fed at once, fan the original before placing it on the ADF.
- Set the original squarely.

### Batch mode

In Batch mode, the machine copies an original including more than 80 pages as one document, even if it is placed on the ADF in parts.

- 1 Press [Special Original].

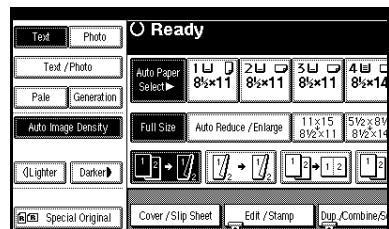



**2** Select [Batch], and then press [OK].

**Note**

- When [Batch] is not displayed, change the settings. See p.102 "Switch to Batch (SADF)".

**3** Place the first part of the original, and then press the [Start] key.

**4** After the first part of the original has been fed, place the next part.

**5** When the Sort, Combine or 1 Sided→2 Sided mode has been set, press the [#] key after all originals have been scanned.

**6** Press the [Start] key.

**SADF mode**

In SADF mode, even when an original is placed page by page in the ADF, each page is automatically fed when placed.

**Preparation**

To use the SADF function, you should make a setting in User Tools (Copier/Document Server Features), so that [SADF] will be displayed when you press [Special Original]. See p.102 "Switch to Batch (SADF)".

**Reference**

Related default settings, see p.95 "Shortcut R/E".

**1** Press [Special Original].

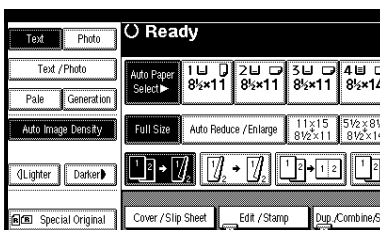

**2** Press [SADF], and then press [OK].

**3** Place one page of an original, and then press the [Start] key.

The Auto Feed indicator is shown on the display.

**4** When the machine instructs you to place another original, place the next page.

The second and subsequent pages will be fed automatically without pressing the [Start] key.

**Mixed size mode**

When placing different size originals of the same width in the ADF at the same time, the machine automatically checks the size of the originals and makes copies.

**Note**

- When placing originals of different sizes in the ADF and making copies without using the Mixed size mode, parts of the original image might not be copied or paper might become jammed.
- Copy speed and scanning speed may be reduced.
- You can place originals of two different sizes at a time.
- The sizes of the originals that can be placed together using this function are as follows:

Metric version	A3, B4 JIS, A4, B5 JIS
Inch version	11" x 17", 8 1/2" x 14", 8 1/2" x 11", 5 1/2" x 8 1/2"

**1** Press [Special Original].

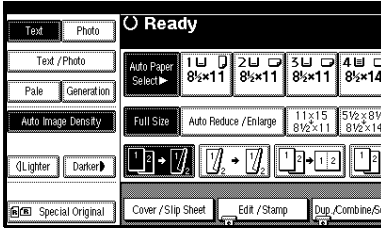

**2** Press [Mixed Size], and then press [OK].

**3** Align the rear and left edges of the originals as shown.

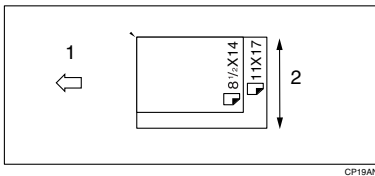

**1.** Place into the ADF

**2.** Vertical size

**4** Adjust the guide to the widest original size.

**5** Place the aligned originals face up into the ADF.

**6** Press the [Start] key.

### Placing custom size originals

When placing custom size originals in the ADF, specify the size of the originals.

**Note**

- Paper that has a vertical length of 128–297 mm (5"–11") and a horizontal length of 128–1,260 mm (5"–49") can be placed with this function.

**1** Press [Special Original].

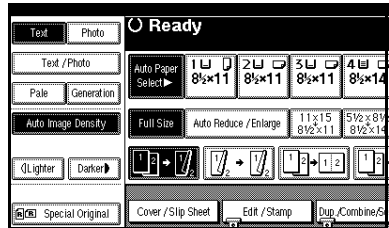

**2** Press [Custm Size Ori.].

**3** Enter the horizontal size of the original with the number keys, and then press [#].

**Note**

- If you make a mistake, press [Clear] or the [Clear/Stop] key, and then enter the value again.

**4** Enter the vertical size of the original with the number keys, and then press [#].

**5** Press [OK].

# 2. Copying

## Basic Procedure

### Preparation

When User Code Authentication is set, the screen for entering a user code will be displayed. Enter your user code using the number keys, and then press the **[#]** key. For user codes, see "Authentication Information", *General Settings Guide*.

When Basic Authentication, Windows Authentication, LDAP Authentication, or Integration Server Authentication is set, the authentication screen will be displayed. Enter your login user name and user password, and then press **[Login]**. See "When the Authentication Screen is Displayed", *General Settings Guide*.

### **1** Make sure "Ready" appears on the display.

If any other function is displayed, press the **[Copy]** key.

#### ❖ Initial copy display

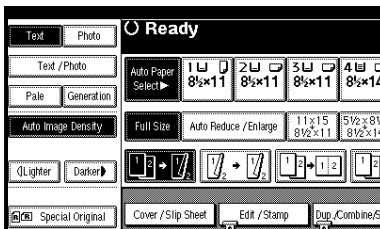

### **2** Make sure no previous settings remain.

#### Note

- When there are previous settings remaining, press the **[Reset]** key and enter again.

### **3** Place your originals.

-  **Reference**  
p.12 "Placing Originals"

### **4** Set your desired settings.

-  **Reference**  
Please refer to each function.

### **5** Enter the required number of copies using the number keys.

-  **Note**
  - The maximum copy quantity that can be set is 999.

### **6** Press the **[Start]** key.

Copying begins.

#### Note

- When placing originals on the exposure glass, press the **[#]** key after all originals are scanned.
- Copies are delivered face down.

#### Important

- When Basic Authentication, Windows Authentication, LDAP Authentication, or Integration Server Authentication is set, always log off when you have finished using the machine prevent unauthorized users from using the machine.

## How to operate

- ❖ **To stop the machine during a multi-copy run.**  
Press the **[Clear/Stop]** key.
- ❖ **To return the machine to the initial condition after copying.**  
Press the **[Clear Modes]** key.
- ❖ **When clearing entered values.**  
Press the **[Clear/Stop]** key or **[Clear]** on the display.
- ❖ **To check the settings.**  
Press the **[Check Modes]** key.

## Interrupt Copy

Use this function if you want to interrupt a long copy job to make urgently needed copies.

### Limitation

- You cannot use the Interrupt Copy function when fax originals are being scanned or the scanner function is being used.

### 1 Press the **[Interrupt]** key.

The **Interrupt** indicator goes on.

### When the originals stop scanning

- 1 **Remove the originals that were being copied and place the originals you want to copy.**
- 2 **Press the **[Start]** key.**  
The machine starts making the copies.
- 3 **When copying is complete, remove the originals and copies.**
- 4 **Press the **[Interrupt]** key again.**  
The **Interrupt** indicator goes off.

- 5 **When the display prompts you, place the remaining originals again before interrupting.**

### 6 Press the **[Start]** key.

#### Note

- The interrupt copy job settings will be restored and the machine will continue copying from where it left off.

### When the machine keeps copying

#### 1 Place the originals you want to copy.

#### 2 Press the **[Start]** key.

The machine stops the previous original job and starts copying the original.

#### 3 When copying is complete, remove originals and copies.

#### 4 Press the **[Interrupt]** key again.

The **Interrupt** indicator goes off.  
The interrupt copy job settings will be restored and the machine will continue copying from where it left off.

## Original Beeper

The beeper sounds and an error message is displayed when you leave your originals on the exposure glass after copying.

#### Note

- See p.94 "Tone: Original remains".

## Job Preset

You can set up the next copy content during copying.

If a long copy job is in progress and you do not want to wait for it to finish, you can use this function to set up the next copy job in advance. When the current copy job is finished, the next job will start automatically.

- 1 Press **[Next Job]** when "Copying" is shown.

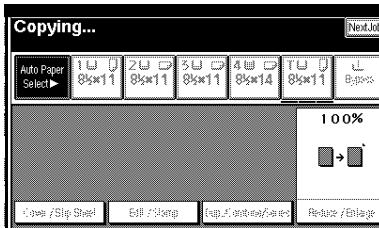

- 2 Set up the next copy job.
- 3 Place the originals in the ADF, and then press the **[Start]** key.

All originals are scanned.

- 4 Press **[To "Printing"]**.

Returns to the initial copy display.

After the current copy job, the next job starts automatically.

### Note

- You can switch the display to the current copy job by pressing **[To "Printing"]**. You can switch the display to the preset job by pressing **[To "Reserving"]**.

# Copying from the Bypass Tray

Use the bypass tray to copy onto OHP transparencies, adhesive labels, translucent paper, postcards and copy paper that cannot be loaded in the paper trays.

## Preparation

When the duplex unit is attached, the default is **[1 Sided→2 Sided]**.

When copying from the bypass tray, select **[1 Sided]** for copying in **[Dup./Combine/Series]** (for example **[1 Sided→1 Sided]** or **[2 Sided→1 Sided]**). You can change the initial settings. See p.94 "Duplex Mode Priority".

## Important

- ❑ When paper larger than 433 mm in size is used, the paper may become wrinkled, may not be fed into the machine, or may cause paper jams.

## Note

- ❑ If you do not use the standard size copy paper or if you use special paper, you should input vertical and horizontal dimensions. See p.16 "Placing custom size originals". The sizes that you can input are as follows:

Metric version	<ul style="list-style-type: none"> <li>• Vertical: 100–297 mm</li> <li>• Horizontal: 148–600 mm <sup>*1</sup></li> </ul>
Inch version	<ul style="list-style-type: none"> <li>• Vertical: 3.9"–11.6"</li> <li>• Horizontal: 5.8"–23.4" <sup>*1</sup></li> </ul>

<sup>\*1</sup> The range is 148–432 mm (5.8"–17") when the booklet finisher is installed.

- ❑ The machine can automatically detect the following sizes as standard size copy paper:

Metric version	A3, A4, A5, 8 1/2" × 13"
Inch version	A3, 11" × 17", 8 1/2" × 11", 5 1/2" × 8 1/2"

- ❑ When copying on OHP transparencies or paper heavier than 128 g/m<sup>2</sup> (about 34 lb.), you need to specify the paper type. See p.22 "When copying onto special paper".
- ❑ The maximum number of sheets you can load at the same time depends on paper type. The maximum number of sheets should not exceed the upper limit.

## Open the bypass tray.

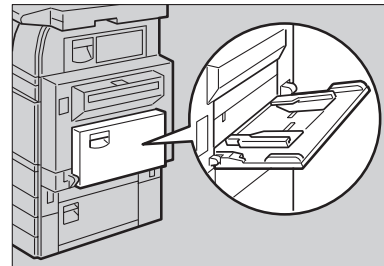

ZDSH110J

- 2 Insert the paper with the side you want to copy facing down until you hear the beep, and then align the paper guide to the paper size.

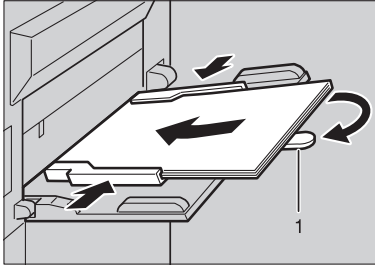

ZDSH100J

## 1. Extender

### Note

- If the guides are not flush against the copy paper, images might be skewed or paper mis-feeds might occur.
- Do not stack paper over the limit mark, otherwise images might be skewed or paper mis-feeds might occur.
- Swing out the extender to support paper sizes larger than A4,  $8\frac{1}{2}'' \times 11''$ .
- Fan paper to get air between the sheets and avoid a multi-sheet feed.

- 3 Select the type and size of the paper.

When copying onto standard size paper

- 1 Press the [#] key.
- 2 Press [Select Size].

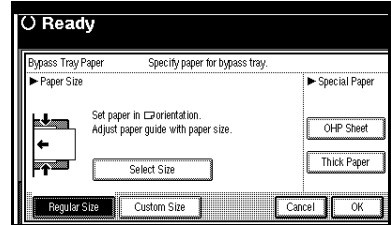

- 3 Select the paper size.
- 4 Press [OK].

When copying onto custom size paper

### Note

- Paper will be automatically delivered to the internal tray.

- 1 Press the [#] key.
- 2 Press [Custom Size].

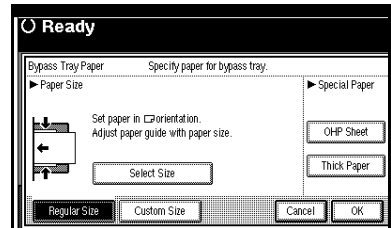

- 3 Press [Vertical], enter the vertical size with the number keys, and then press the [#] key.
- 4 Enter the horizontal size of the paper with the number keys, and then press the [#] key.

**Note**

- If [**Horiz**] is not highlighted, press [**Horiz**].
- To register the custom size entered, press [**Program**], and then press [**Exit**].

2

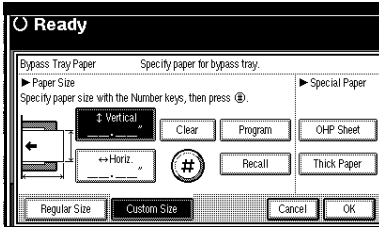

5 Press [OK].

When copying onto special paper

- 1 Press the [#] key.
- 2 Select paper type in Special paper.
- 3 Press [OK].

4 Place your originals, and then press the [Start] key.

**Note**

- When copying onto OHP transparencies, remove copied sheets one by one.

5 When your copy job is finished, press the [Clear Modes] key to clear the settings.



# Copier Functions

## Adjusting Image Density

There are three types of adjustment available:

- ❖ **Auto Image Density**  
The machine automatically adjusts image density.
- ❖ **Manual image density**  
You can adjust the density of the overall original in seven increments.
- ❖ **Combined auto and manual image density**  
Use when copying originals with a dirty background (such as newspapers). You can adjust foreground density while leaving the background unchanged.

### Auto image density

- 1** Make sure that [Auto Image Density] is selected.

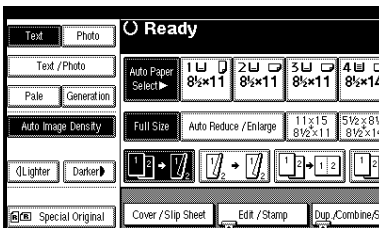

### Manual image density

- 1** Press [Auto Image Density] to cancel it.
- 2** Press [Lighter] or [Darker] to adjust the image density.

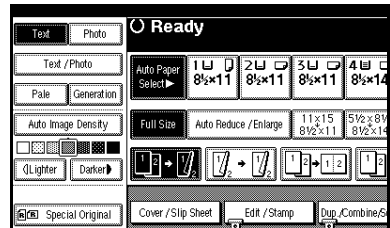

### Combined auto and manual image density

- 1** Make sure that [Auto Image Density] is selected.
- 2** Press [Lighter] or [Darker] to adjust the density.

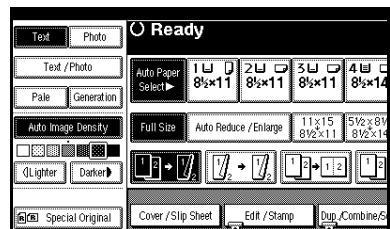

2

## Selecting Original Type Setting

Select one of the following six types to match your originals:

- ❖ **Text**  
Select this mode when your originals contain only text (no pictures).
- ❖ **Text/Photo**  
Select [**Text/Photo**] when your originals contain photographs or pictures with text.
- ❖ **Photo**  
Delicate tones of photographs and pictures can be reproduced with this mode.
- ❖ **Pale**  
Select this mode for originals that have lighter lines in pencil, or for faint copied slips. The faint lines will be clearly copied.
- ❖ **Generation Copy**  
If your originals are copies (generation copies), the copy image can be reproduced sharply and clearly.

### 🔍 Reference

p.92 "Original Type Display"

p.93 "Copy Quality"

- 1 Press the appropriate key to select the original type.

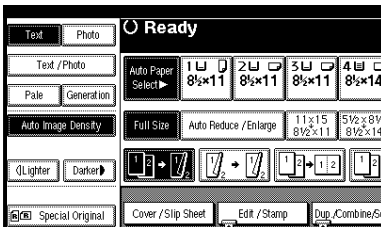

When the original type keys are not displayed

- 1 Press [**Original Type**].
- 2 Select the original type, and then press [**OK**].

## Selecting Copy Paper

There are two ways to select copy paper:

### ❖ Auto Paper Select

The machine selects a suitable size of copy paper automatically based on original size and reproduction ratio.

### ❖ Manual Paper Select

Choose the tray containing the paper you want to copy onto: a paper tray, bypass tray or LCT.

#### Reference

p.11 "Sizes difficult to detect"

p.92 "Paper Display"

#### Note

- See the following table for copy paper sizes and orientations that can be used with Auto Paper Select (when copying at a ratio of 100%).

#### ❖ Metric version

Where original is placed	Paper size and orientation
Exposure glass	A3☐, B4 JIS☐, A4☐☐, B5 JIS☐☐
ADF	A3☐, B4 JIS☐, A4☐☐, B5 JIS☐☐, A5☐☐, B6 JIS☐☐, 11"×17"☐, 8 <sup>1</sup> / <sub>2</sub> "×11"☐☐

#### ❖ Inch version

Where original is placed	Paper size and orientation
Exposure glass	11"×17"☐, 8 <sup>1</sup> / <sub>2</sub> "×14"☐, 8 <sup>1</sup> / <sub>2</sub> "×11"☐☐
ADF	A3☐, A4☐☐, 11"×17"☐, 8 <sup>1</sup> / <sub>2</sub> "×14"☐, 8 <sup>1</sup> / <sub>2</sub> "×11"☐☐, 5 <sup>1</sup> / <sub>2</sub> "×8 <sup>1</sup> / <sub>2</sub> "☐☐, 10"×14"☐

- Only the paper trays set to **[No display]** or **[Recycled paper]** in Paper Type and also set to **[Yes]** in Apply Auto Paper Select can be selected in Auto Paper Select mode. See "Paper Type: Tray 1-4" in "Tray Paper Settings", *General Settings Guide*.

## Auto Paper Select

**1** Make sure that [Auto Paper Select] is selected.

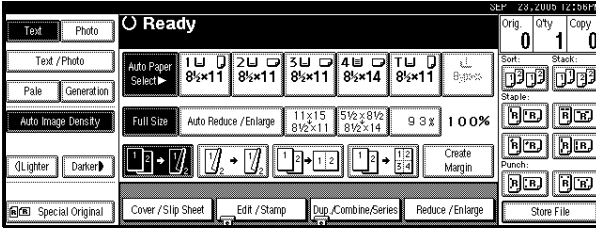

2

### Note

❑ Trays with a key mark will not be automatically selected. See “Paper Type” in “Tray Paper Settings”, *General Settings Guide*.

## Manual Paper Select

**1** Select the paper tray, bypass tray or the LCT.

The indicator corresponding to the selected paper tray is highlighted.

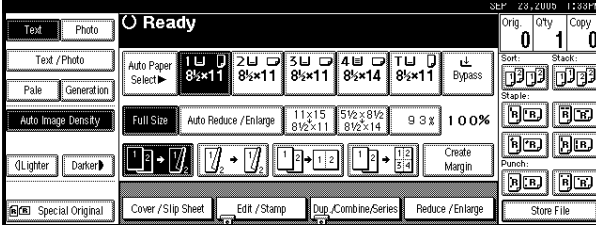

### Reference

p.20 “Copying from the Bypass Tray”

## When the paper type keys are not displayed

- 1** Press [Auto Paper Select].
- 2** Select the paper type.

**Rotated copy**

If the orientation in which your original is placed (☐ or ☐) is different from that of the paper you are copying onto, this function rotates the original image by 90° to fit it on the copy paper. This function works when Auto Paper Select or Auto Reduce/Enlarge is selected. See p.25 “Auto Paper Select”.

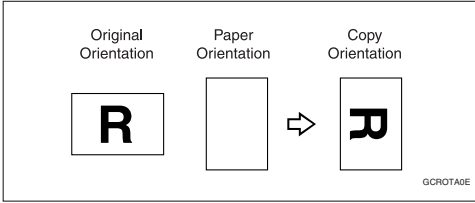

**Note**

- ☐ The default for Auto Tray Switching is With image rotation, you cannot use the Rotated Copy function if this setting is changed to Without image rotation or Off. See p.92 “Auto Tray Switching”.
- ☐ You cannot use the Rotated Copy function when enlarging onto A3, B4 JIS or 11" × 17", 8 1/2" × 14" size paper. In this case, place your original in the ☐ orientation.

	Original size and orientation		Copy paper size and orientation
You cannot rotate:	8 1/2" × 11" or 5 1/2" × 8 1/2" ☐		When enlarging to → 8 1/2" × 14" or 11" × 17"
However, you can use:	8 1/2" × 11" or 5 1/2" × 8 1/2" ☐		When enlarging to → 8 1/2" × 14" or 11" × 17"

- ☐ You cannot use the Rotated Copy function when “Left 2” or “Top 2” is selected for stapling or if the Punch function is selected when using the 2 Tray finisher. See p.37 “Staple” and p.43 “Punch”.
- ☐ You cannot use the Rotate Copy function if “Left 2”, “Top 2” or “Saddle Stitch” is selected for the stapling when using the booklet finisher.

## Preset Reduce/Enlarge

You can select a preset ratio for copy-

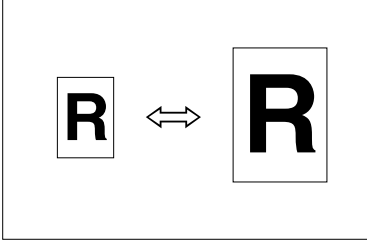

2

### ❖ Base Point

The base point of Reduce/Enlarge differs depending on how the original is scanned. When the original is placed on the exposure glass, the upper left corner will be the base point. When it is placed in the ADF, the bottom left corner will be the base point.

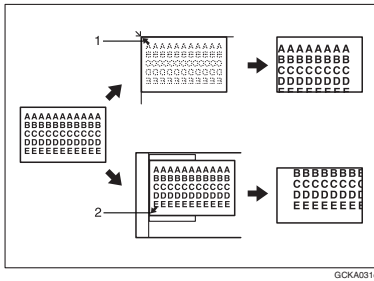

**1. Base point when placing on the exposure glass.**

**2. Base point when placing in the ADF.**

### 🔍 Reference

- Related initial settings
- p.95 "Shortcut R/E"
- p.96 "R/E Priority"

**1** Press [Reduce/Enlarge].

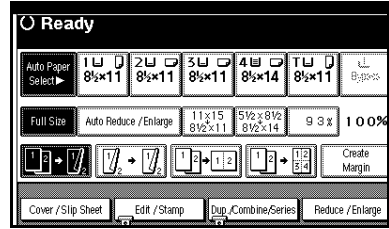

### 🔑 Note

- To select a preset ratio on the initial display, press the shortcut reduce/enlarge key and proceed to step 4.

**2** Press [Enlarge] or [Reduce].

**3** Select a ratio, and then press [OK].

**4** Place your originals, and then press the [Start] key.

### 💡 Create margin mode

Use Create Margin to reduce the image to 93% of its original size with the center as reference. You can assign this function to a shortcut key on the initial display. By combining it with the Reduce/Enlarge function, you can also provide the Reduce/Enlarge copy with a margin.

### 🔍 Reference

- Related initial settings
- p.94 "Copy Function Key: F1-F5"
- p.96 "Ratio for Create Margin"

- 1 Press **[Create Margin]** displayed on the initial display.

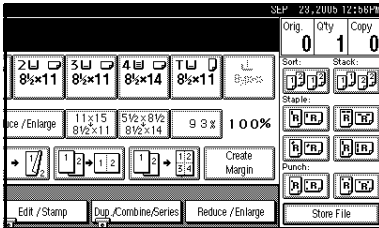

- 2 If you do not want to combine it with the Reduce/Enlarge function, place your originals, and then press the **[Start]** key.

## Zoom

You can change the reproduction ratio in increments of 1%.

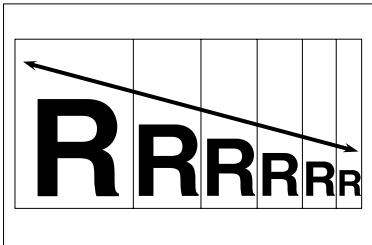

### Note

- You can also select a preset ratio near the desired ratio using **[Reduce]** or **[Enlarge]**, and then adjust the ratio with **[+]** or **[-]**.

- 1 Press **[Reduce/Enlarge]**.

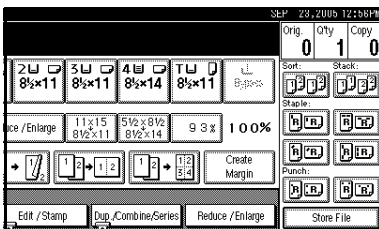

- 2 Enter the ratio.

To select the ratio with **[+]** and **[-]**

- 1 Select a preset ratio close to the desired ratio by using **[Reduce]** or **[Enlarge]**.
- 2 Adjust the ratio with **[+]** or **[-]**.

### Note

- To change the ratio in increments of 1%, press **[+]** or **[-]**. To change the ratio in increments of 10%, press and hold down **[+]** or **[-]**.
- If you have incorrectly entered the ratio, readjust with **[+]** or **[-]**.

To enter the ratio with the number keys

- 1 Press **[Mag. Ratio]**.
  - 2 Enter the desired ratio with the number keys.
  - 3 Press **[#]**.
  - 4 Press **[OK]**.
- 3 Place your originals, and then press the **[Start]** key.

## Auto Reduce/Enlarge

The machine can choose an appropriate reproduction ratio based on the paper and original sizes you select.

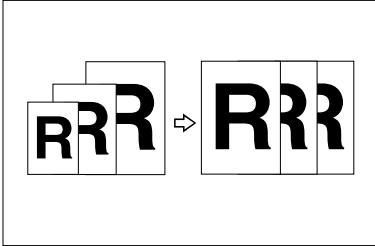

**Note**

- You cannot use the bypass tray with this function.
- When using Auto Reduce/Enlarge, see the following table for original sizes and orientations you can use:

❖ **Metric version**

Where original is placed	Original size and orientation
Exposure glass	A3, B4, A4, B5 JIS
ADF	A3, B4 JIS, A4, B5 JIS, A5, B6 JIS, 11" x 17", 8 1/2" x 11"

❖ **Inch version**

Where original is placed	Original size and orientation
Exposure glass	11" x 17", 8 1/2" x 14", 8 1/2" x 11"
ADF	A4, 11" x 17", 8 1/2" x 14", 8 1/2" x 11", 5 1/2" x 8 1/2"

**Reference**

p.11 "Sizes difficult to detect"

**1** Press [Auto Reduce/Enlarge].

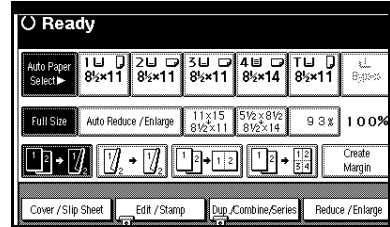

**2** Select the paper tray.

**3** Place your originals, and then press the [Start] key.

## Size Magnification

This function calculates an enlargement or reduction ratio based on the lengths of the original and copy.

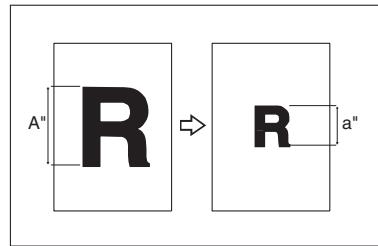

**Note**

- Measure and specify the lengths of the original and copy by comparing "A" with "a".

**1** Press [Reduce / Enlarge].

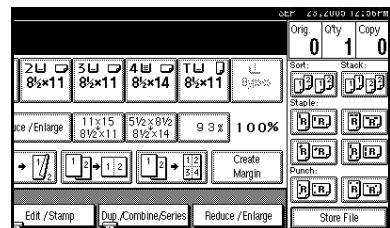



- 2** Press [Specifd. Ratio].
- 3** Make sure that [Specifd. Ratio] is highlighted.
- 4** Enter the length of the original with the number keys, and then press the [#] key.

**Note**

- You can enter sizes within the following ranges:

Metric version	1-999 mm (in increments of 1 mm)
Inch version	0.1"-99.9" (in increments of 0.1")

- 5** Enter the length of the copy with the number keys, and then press [#].

**Note**

- To change the length after pressing [#], select [Original] or [Copy] and enter the desired length.

- 6** Press [OK].

- 7** Press [OK].

- 8** Place your originals, and then press the [Start] key.

## Directional Magnification (%)

Copies can be reduced or enlarged at different reproduction ratios, horizontally and vertically.

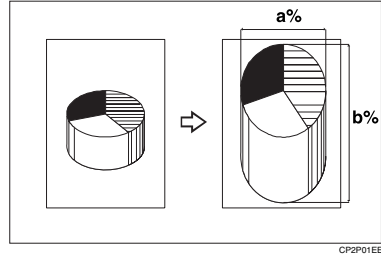

1. Horizontal ratio
2. Vertical ratio

**Note**

- You can also select a preset ratio close to the desired ratio using [Reduce] or [Enlarge], then adjust with [+] or [-].

- 1** Press [Reduce/Enlarge].

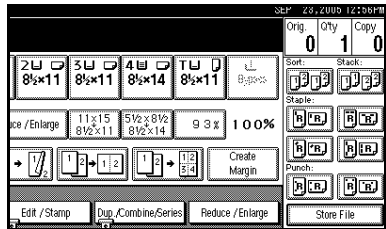

- 2** Press [Specifd. Ratio].

- 3** Press [Direct. Mag.%].

To enter the ratio with the number keys

- 1** Press [Horizontal].
- 2** Enter the desired ratio with the number keys, followed by [#].
- 3** Press [Vertical].

4 Enter the desired ratio with the number keys, followed by [#].

5 Press [OK].

To specify a ratio with [+ ] and [- ]

1 Press [With + -].

2 Press [Horizontal].

3 Adjust the ratio using [+ ] or [- ].

**Note**

- Pressing [+ ] or [- ] changes the ratio in increments of 1%. Pressing and holding down [+ ] or [- ] changes it in increments of 10%.

- If you have incorrectly entered the ratio, readjust the ratio with [+ ] or [- ].

4 Press [Vertical].

5 Adjust the ratio with [+ ] or [- ].

6 Press [OK].

4 Press [OK].

5 Place your originals, and then press the [Start] key.

## Directional Size Magnification (inch)

The suitable reproduction ratios will be automatically selected when you enter the horizontal and vertical lengths of the original and copy image you require.

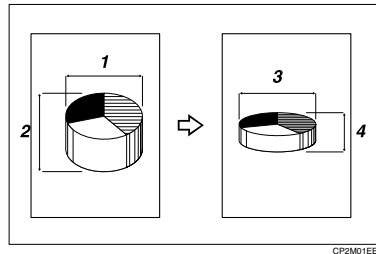

1. Horizontal original size

2. Vertical original size

3. Horizontal copy size

4. Vertical copy size

**Note**

- Specify the vertical and horizontal sizes of the original and those of the copy, as shown.

- You can enter sizes within the following ranges:

Metric version	Vertical: 1-999 mm (in increments of 1 mm) Horizontal: 1-999 mm (in increments of 1 mm)
Inch version	0.1"-99.9" (in increments of 0.1")

**1** Press [Reduce/Enlarge].

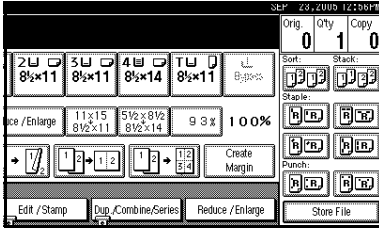

**2** Press [Specifd. Ratio].

**3** Press [Dir. Size Mag In].

**4** Enter the horizontal size of the original with the number keys, and then press [#].

**5** Enter the horizontal size of the copy with the number keys, and then press [#].

**6** Enter the vertical size of the original with the number keys, and then press [#].

**7** Enter the vertical size of the copy with the number keys, and then press [#].

**Note**

- To change a length, press the key you want to change and enter the new value.

**8** Press [OK].

**9** Press [OK].

**10** Place the originals, and then press the [Start] key.

## Sort

The machine can scan originals into memory and automatically sort copies.

**Reference**

Related initial settings

p.103 "Select Stack Function"

p.103 "Memory Full Auto Scan Restart"

p.102 "Rotate Sort: Auto Paper Continue"

p.92 "Auto Tray Switching"

**Sort**

Copies are assembled as sets in sequential order.

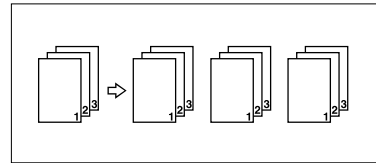

**Rotate Sort**

Every other copy set is rotated by 90° and delivered to the copy tray.

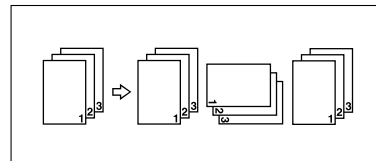

**Note**

- To use the Rotate Sort function, two paper trays loaded with same size and type paper, but in different orientation, are required. See "Paper Type: Tray 1-4" in "Tray Paper Settings", *General Settings Guide*.

❖ Shift Sort

- 1000-Sheet finisher (optional)  
Each time the copies of one set or those of each job are delivered, the next copy is shifted when delivered so you can separate each set or job.
- 2 Tray finisher (optional)  
The shift tray moves backward or forward each time the copies of one set or those of each job are delivered, causing the next copy to shift when delivered so that you can differentiate each set or job.

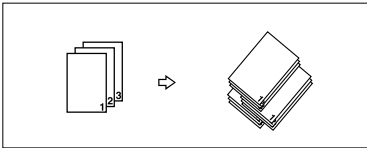

- Booklet finisher (optional)  
Each time a set of copies or a job is delivered, the finisher shift tray moves backward or forward, causing the top sheet of each set to shift when delivered, separating each set or job.

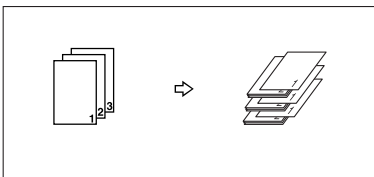

GCANS01E

**1** Press [Sort] or [Rotate Sort].

❖ When a finisher is not installed

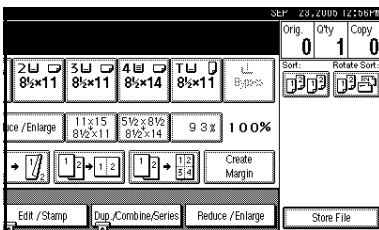

❖ When the 1000-Sheet finisher is installed

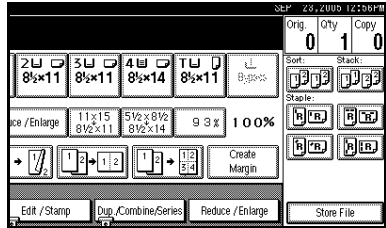

❖ When the 2 Tray finisher is installed

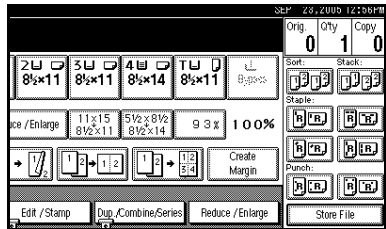

❖ When the booklet finisher is installed

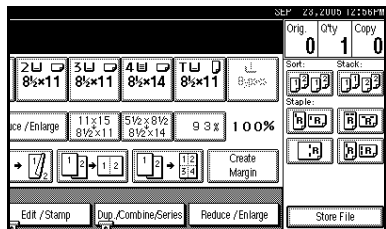

**2** Enter the number of copy sets with the number keys.

**Note**

- To confirm the type of finishing, press the [Sample Copy] key. See p.35 "Sample copy".

**3** Place your originals.

**Note**

- ❑ When placing an original on the exposure glass, start with the first page to be copied. When placing an original in the ADF, set so the first page is on the top.
- ❑ When placing an original on the exposure glass or in the ADF using Batch mode, press the **[#]** key after all the originals have been scanned.

**4** Press the **[Start]** key.**Sample copy**

Use this function to check the copy settings before making a long copy run.

**Note**

- ❑ This function can be used only when the Sort function is turned on.

**1** Select Sort and any other necessary functions, and then place the originals.

**2** Press the **[Sample Copy]** key.

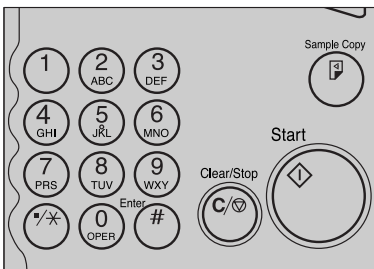

AHJ0021S

One copy set is delivered as a sample.

**3** If the sample is acceptable, press **[Print]**.

The number of copies made is the number specified, minus one for the proof copy.

**Note**

- ❑ If you press **[Suspend]** after checking the results, return to step **1** to adjust the copy settings as necessary. You can change the settings for Staple, Duplex (one-sided → one-sided, one-sided → two-sided), Copy Orientation, Margin Adjust., and Cover/Slip Sheet. However, depending on the combination of functions, you may not be able to change some settings.

**Changing the number of sets**

You can change the number of copy sets during copying.

**Note**

- ❑ This function can only be used when the Sort function is turned on.

**1** While "Copying" is displayed, press the **[Clear/Stop]** key.

**2** Press **[Change Quantity]**.

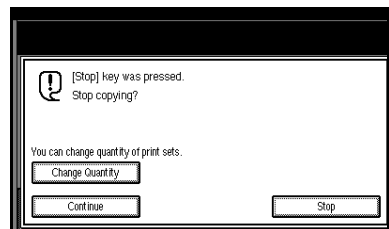

**3** Enter the number of copy sets with the number keys, and then press the **[#]** key.

**Note**

- ❑ The number of sets you can enter differs depending on when the **[Clear/Stop]** key is pressed.

**4** Press **[Continue]**.

Copying starts again.

## Stack

Copies can be assembled with each page placed.

- 1000-Sheet finisher (optional)  
Each time the copies of one page are delivered, the next copy is shifted when delivered so you can separate each job by page.
- 2 Tray finisher (optional)  
The shift tray moves backward or forward each time the copies of one page are delivered, causing the next copy to shift when delivered so that you can separate each job by page.

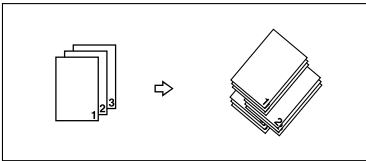

- Booklet finisher (optional)  
Each time the copies of one page are delivered, the finisher shift tray moves backward or forward, causing the top sheet of each page stack to shift when delivered, separating each job by page.

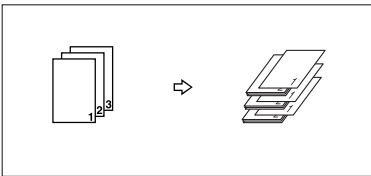

GCANS01E

### 1 Press [Stack].

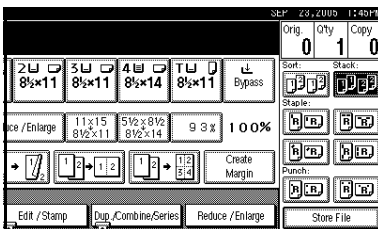

**2** Enter the number of copies with the number keys.

**3** Place your originals, and then press the [Start] key.

#### Note

- When placing an original on the exposure glass, start with the first page to be copied. When placing an original in the ADF, set so the last page is on the bottom.
- When placing an original on the exposure glass or in the ADF using Batch mode, press the [#] key after all the originals have been scanned.

---

## Staple

---

*An optional finisher and the bridge unit are required for this function.*

Each copy set can be stapled together.

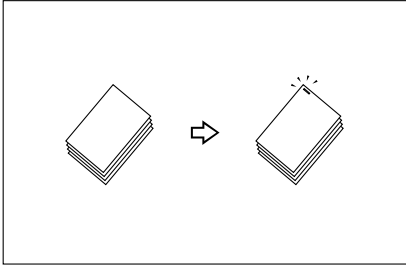

### Note

- You cannot use the bypass tray with this function.

### Reference

Related initial settings

p.103 "Select Stapling Position"

---





































## Stapling position and original setting

---

Place all the originals in the ADF in the orientation in which they can be read normally. When placing the original on the exposure glass, keep the same orientation, but set the original facing downwards. When there is copy paper that is identical in size and orientation to your original, the staple positions are as follows:





































❖ 1000-Sheet finisher









2

		Original location		Stapling position *1	
			Exposure glass		ADF
 STAPLEAE	Top				
					
 STAPLECE	Bottom				
					
 STAPLEDE	Left 2				
					
 STAPLEEE	Top 2				
					















































❖ 2 Tray finisher

		Original location		Stapling position *1	
			Exposure glass		ADF
 STAPLEAE	Top				
					
 STAPLEBE	Top Slant				
					
 STAPLECE	Bottom		 STAPLE25	 STAPLE26	 STAPLE27
			 STAPLE28	 STAPLE29	 STAPLE30
 STAPLEDE	Left 2				*2 
			 STAPLE31	 STAPLE32	 STAPLE33

		Original location		Stapling position *1	
		Exposure glass	ADF		
 STAPLEEE	Top 2		 STAPLE22ADA	 STAPLE23ADA	 STAPLE24ADA
			 STAPLE10ADA	 STAPLE14ADA	 STAPLE20ADA
			*2		

❖ Booklet finisher

		Original location		Stapling position *1	
		Exposure glass	ADF		
 STAPLEAE	Top		 STAPLE25	 STAPLE26	 STAPLE27
			 STAPLE28	 STAPLE29	 STAPLE30
 STAPLECE	Bottom		 STAPLE25	 STAPLE26	 STAPLE27
			 STAPLE28	 STAPLE29	 STAPLE30

		Original location		Stapling position *1	
		Exposure glass	ADF		
 STAPLEDE	Left 2				*2
			 STAPLE31	 STAPLE32	 STAPLE33
 STAPLEEE	Top 2		 STAPLE22ADA	 STAPLE23ADA	 STAPLE24ADA
			 STAPLE10ADA	 STAPLE14ADA	 STAPLE20ADA
 STAPLEFE	Saddle Stitch		 STAPLE34	 STAPLE35	 STAPLE36
			 STAPLE37	 STAPLE38	 STAPLE39

\*1 This table shows the stapling positions, not the orientation of delivery.

\*2 Not available for A3 and B4 JIS size paper.

**1** Select one of the stapling positions.

❖ 1000-Sheet finisher

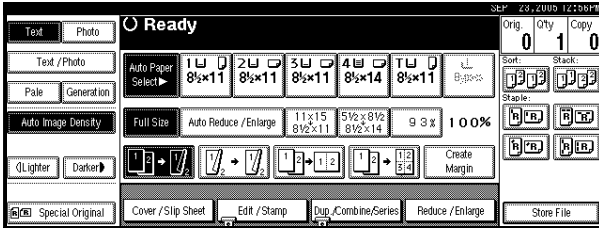

❖ 2 Tray finisher

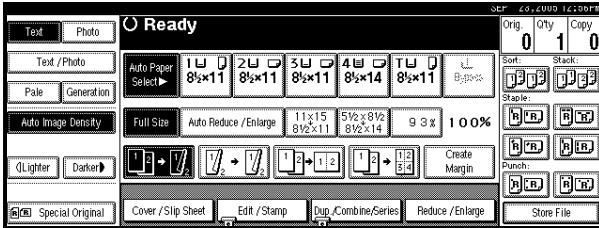

❖ Booklet finisher

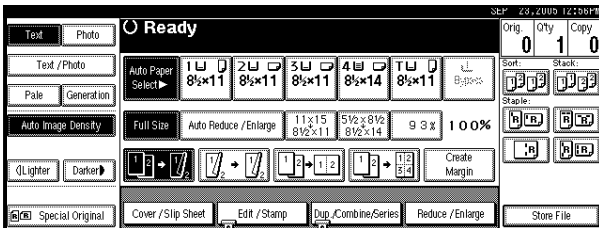

**Note**

- ❑ When you select the stapling position, Sort mode is automatically selected.

**Reference**

p.37 “Stapling position and original setting”

**2** Enter the number of copy sets with the number keys.

**3** Place your originals, and then press the [Start] key.

**Note**

- ❑ When placing an original on the exposure glass, start with the first page to be copied. When placing an original in the ADF, set so the last page is on the bottom.
- ❑ When placing an original on the exposure glass or in the ADF using Batch mode, press the [#] key after all the originals have been scanned.

## Punch

*The optional 2 Tray finisher and the bridge unit are required for this function.*

You can make punch holes in copies.

### ❖ 2 holes

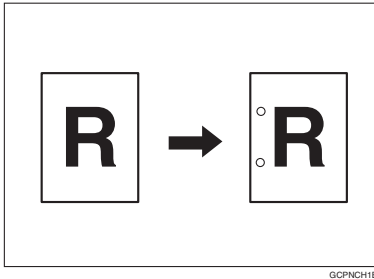

### ❖ 3 holes

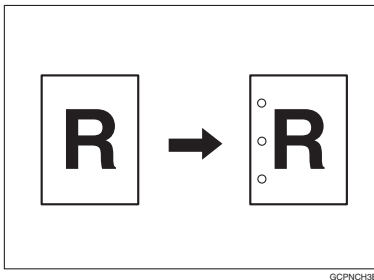

### ❖ 4 holes

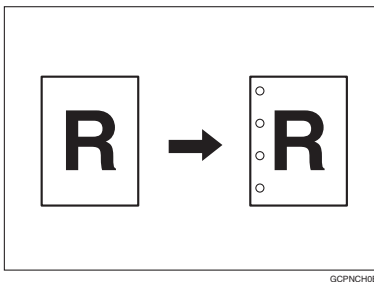

### Note

- You cannot use the bypass tray with this function.
- The relationship between the orientation in which you place the original and the punch hole positions is as follows:

❖ Punch hole positions

	Original location			Punch hole positions *1	
		Exposure glass	ADF		
Standard	2 holes				
	3 holes				
	4 holes				

2

	Original location			Punch hole positions *1	
		Exposure glass	ADF		
90° Turn	2 holes				
	3 holes				
	4 holes				

\*1 This table shows the punch hole positions, not the orientation of delivery.

**1** Select one of the punch hole positions.

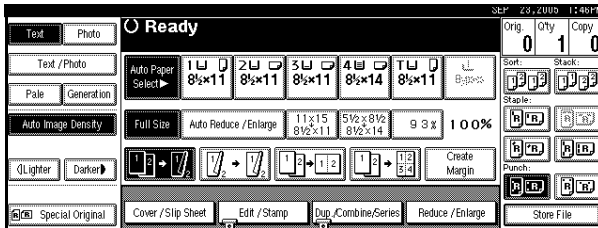

**2** Enter the number of copy sets with the number keys.

**3** Place your originals, and then press the [Start] key.

## Duplex

There are three types of duplex.

### ❖ 1 Sided→2 Sided

Copies 2 one-sided pages on 1 two-sided page.

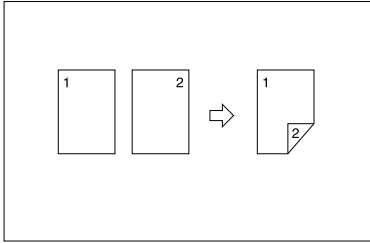

### ❖ 2 Sided→2 Sided

Copies 1 two-sided page on 1 two-sided page.

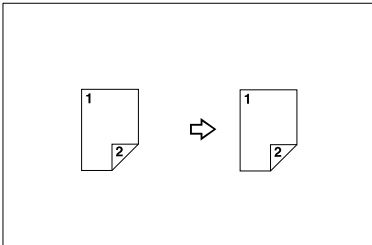

### ❖ 2 Sided→1 Sided

Copies each side of a two-sided original onto two separate pages.

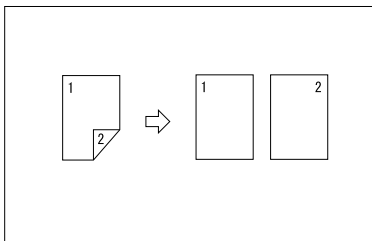

## Original orientation and completed copies

The resulting copy image will differ according to the orientation in which you place your originals (vertical or horizontal ).

Original	How to Set Your Original	Copy
Vertical 	Standard 	Top to Top 
	90° turn 	Top to Bottom 
Horizontal 	Standard 	Top to Top 
	90° turn 	Top to Bottom 

GCRYOU1E

\*1 The table shows the orientation of images on the front and back of copies, not the orientation of delivery.

### Note

- You cannot use the bypass tray with this function.
- The maximum paper weight that can be used with duplex copying is 64–105 g/m<sup>2</sup>, 17–28 lb. (55–90 kg, 121.3–198.4 lb.).

### Reference

- p.60 "Margin Adjustment"
- Related initial settings
- p.97 "Front Margin: Left/Right"
- p.97 "Back Margin: Left/Right"
- p.97 "Front Margin: Top/Bottom"
- p.97 "Back Margin: Top/Bottom"



**1** Press [Dup./Combine/Series].

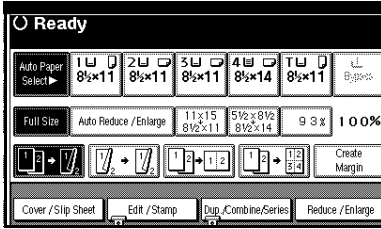

**Note**

- You can also select “1 Sided to 2 Sided” or “2 Sided to 2 Sided” directly by pressing the Copy Function Key. In that case, proceed to **4**.

**2** Select [1 Sided] or [2 Sided] for Original, and then select [1 Sided] or [2 Sided] for Copy.

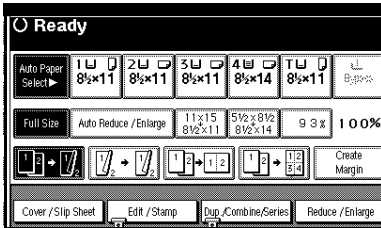

**Note**

- To change the copy orientation, press [Orientation]. See p.47 “Originals and copy orientation”.

**3** Press [OK].

**4** Place your originals, and then press the [Start] key.

**Note**

- When placing an original on the exposure glass, start with the first page to be copied. When placing an original in the ADF, set so the last page is on the bottom.

- When placing an original on the exposure glass or in the ADF using Batch mode, press the [#] key after all the originals have been scanned.

**Originals and copy orientation**

You can select the orientation.

- Top to Top

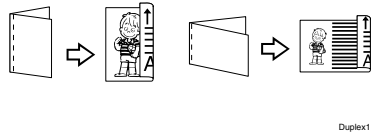

- Top to Bottom

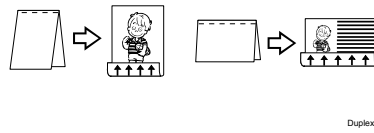

**Note**

- You can change the default orientation with User Tools. See p.94 “Copy Orientation in Duplex Mode” and p.94 “Original Orientation in Duplex Mode”.

**1** Press [Dup./Combine/Series].

**2** Press [Orientation], select the orientation (Original/Copy), and then press [OK].

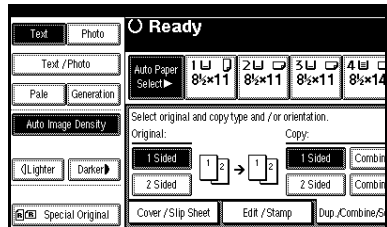

## One-Sided Combine

Combine several pages onto one side of a sheet.

❖ **1 Sided 2 Pages → Combine 1 Side**

Copies 2 one-sided originals to one side of a sheet.

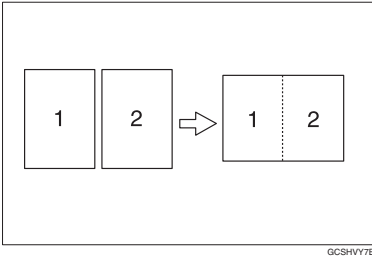

❖ **1 Sided 4 Pages → Combine 1 Side**

Copies 4 one-sided originals to one side of a sheet.

❖ **1 Sided 8 Pages → Combine 1 Side**

Copies 8 one-sided originals to one side of a sheet.

❖ **2 Sided 1 Page → Combine 1 Side**

Copies 1 two-sided original to one side of a sheet.

❖ **2 Sided 2 Pages → Combine 1 Side**

Copies 2 two-sided originals to one side of a sheet.

❖ **2 Sided 4 Pages → Combine 1 Side**

Copies 4 two-sided originals to one side of a sheet.

❖ **Orientation of the original and image position of combine**

Open to left originals

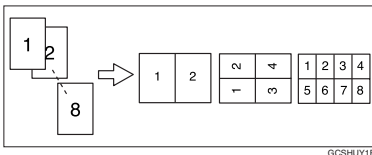

Open to top originals

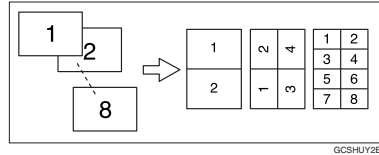

❖ **Placing originals (originals placed in the ADF)**

- Originals read from left to right

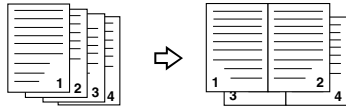

- Originals read from top to bottom

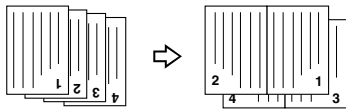

**Note**

- You cannot use the bypass tray with this function.

**Reference**

Related initial settings

p.97 "Erase Original Shadow in Combine"

p.99 "Copy Order in Combine"

p.98 "Separation Line in Combine"

**1** Press [Dup./Combine/Series].

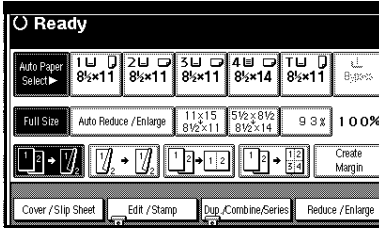

**2** Press [1 Sided] or [2 Sided] for Original, and then press [Combine 1 Side] for Copy.

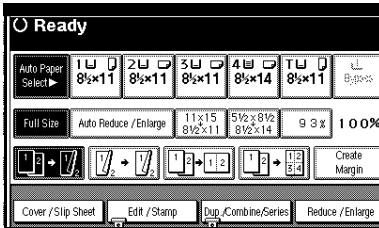

**Reference**

p.47 "Originals and copy orientation"

**3** Select the number of originals to combine, and then press [OK].

**4** Select the paper size.

**5** Press [OK].

**6** Place your originals, and then press the [Start] key.

## Two-Sided Combine

Combines various pages of originals into one sheet with two sides.

❖ **1 Sided 4 Pages → Combine 2 Side**

Copies 4 one-sided originals to one sheet with two pages per side.

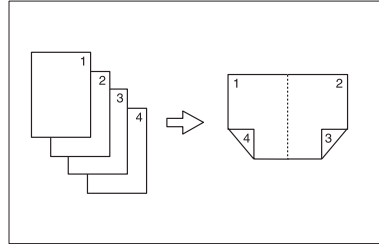

GCSHVYBE

❖ **1 Sided 8 Pages → Combine 2 Side**

Copies 8 one-sided originals to one sheet with four pages per side.

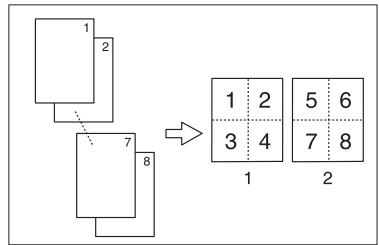

GCSHVYAE

**1.** Front

**2.** Back

2

- ❖ **1 Sided 16 Pages → Combine 2 Side**  
Copies 16 one-sided originals to one sheet with eight pages per side.

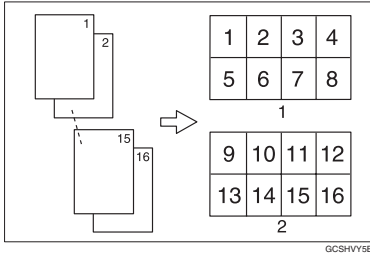

1. Front
2. Back

- ❖ **2 Sided 4 Pages → Combine 2 Side**  
Copies 2 two-sided originals to one sheet with two pages per side.

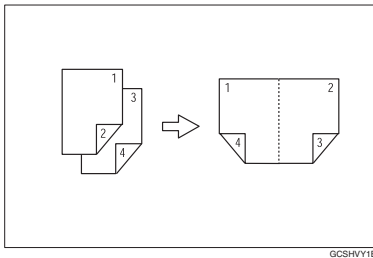

- ❖ **2 Sided 8 Pages → Combine 2 Side**  
Copies 4 two-sided originals to one sheet with four pages per side.

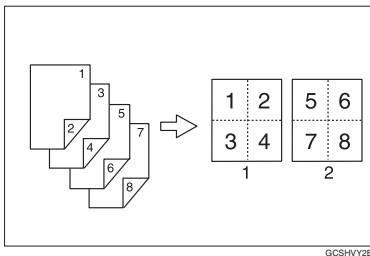

- ❖ **2 Sided 16 Pages → Combine 2 Side**  
Copies 8 two-sided originals to one sheet with eight pages per side.

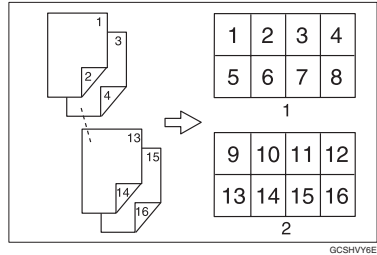

**Reference**

- Related initial settings
- p.48 "Orientation of the original and image position of combine"
- p.97 "Erase Original Shadow in Combine"
- p.99 "Copy Order in Combine"
- p.98 "Separation Line in Combine"

**1** Press [Dup./Combine/Series].

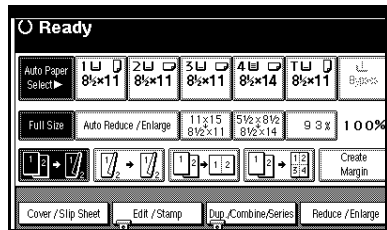

**2** Press [1 Sided] or [2 Sided] for Original, and then press [Combine 2 Side] for Copy.

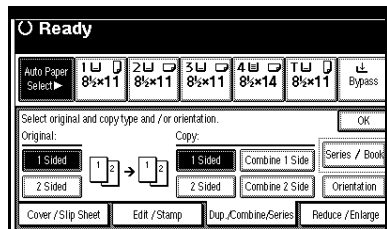

**Reference**

p.47 "Originals and copy orientation"

- 3** Select the number of originals to combine, and then press [OK].
- 4** Select the paper size.
- 5** Press [OK].
- 6** Place your originals, and then press the [Start] key.

### Series Copies

Separately copies the front and back of a two-sided original or the two facing pages of a bound original onto two sheets.

**Limitation**

- You cannot use the Series Copies function from the ADF.

**Book→1 Sided**

You can make one-sided copies from two facing pages of a bound original (book).

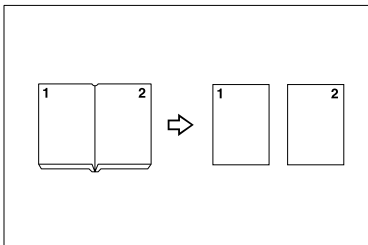

**Book→2 Sided**

Copies a two-page spread original onto one sheet with one page per side.

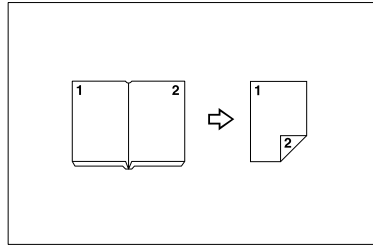

**Front&Back→2 Sided**

Copies each two-page spread original as it is onto both sides of a sheet.

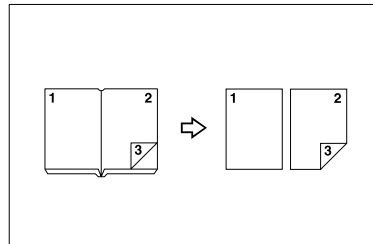

**Note**

- See the following table for original and copy paper sizes when using a 100% ratio.

**Metric version**

Original	Paper for one-sided copy	Paper for two-sided copy
A3	A4 × 2 sheets	A4 × 1 sheet (two-sided)
B4 JIS	B5 JIS × 2 sheets	B5 JIS × 1 sheet (two-sided)
A4	A5 × 2 sheets	A5 × 1 sheet (two-sided)

❖ Inch version

Original	Paper for one-sided copy	Paper for two-sided copy
11" × 17"	8 1/2" × 11"  × 2 sheets	8 1/2" × 11"  × 1 sheet (two-sided)
8 1/2" × 11"	5 1/2" × 8 1/2"  × 2 sheets	5 1/2" × 11"  × 1 sheet (two-sided)

**1** Press [Dup./Combine/Series].

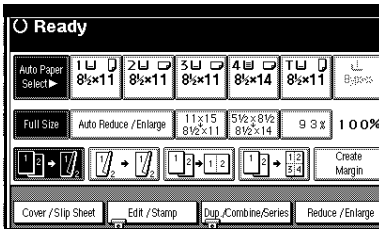

**2** Press [Series/Book].

**3** Press [Series].

**4** Select [Book→1 Sided], [Book→2 Sided], or [Front&Back→2 Sided], and then press [OK].

**5** Press [OK].

**6** Make sure that [Auto Paper Select] is selected.

**7** Place your original on the exposure glass, and then press the [Start] key.

**Note**

- ❑ Press the [#] key after all originals have been scanned.

## Booklet/Magazine

Copies two or more originals in page order.

❖ **1 Sided→Booklet**

Make copies in page order for a folded booklet as shown.

❖ **Open to left**

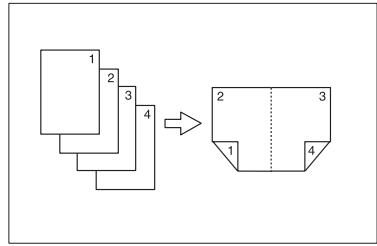

GCBOOK0E

❖ **Open to right**

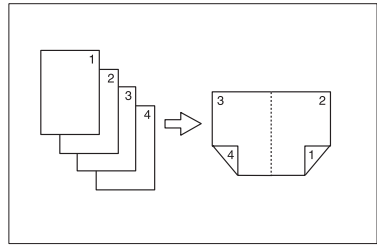

GCBOOK1E

❖ **2 Sided→Booklet**

Make two-sided originals to copies in page order for a folded booklet as shown.

❖ **Open to left**

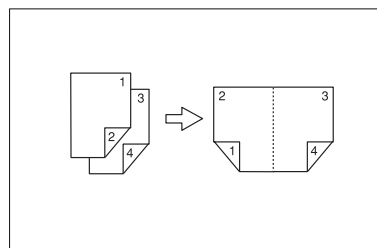

GC4H010E

❖ **Open to right**

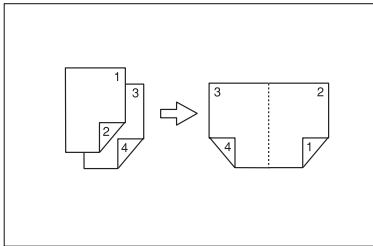

GCAH202E

❖ **Open to left**

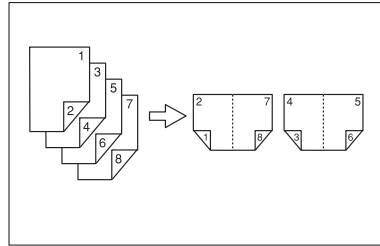

GCAH030E

❖ **1 Sided→Magazine**

Copies two or more originals to make copies in page order when they are folded and stacked.

❖ **Open to left**

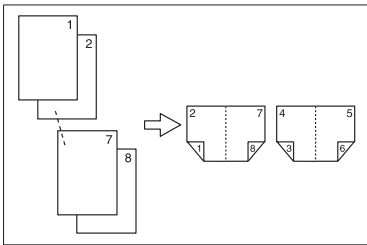

GCBOOK3E

❖ **Open to right**

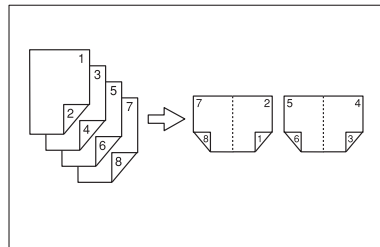

GCAH040E

**How to fold and unfold copies to make a booklet**

❖ **Open to right**

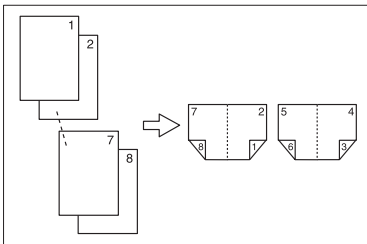

GCBOOK4E

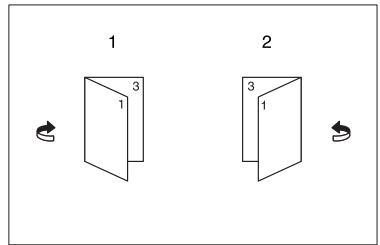

GCBOOK2E

**1. Open to left**

**2. Open to right**

❖ **2 Sided→Magazine**

Copies two or more originals of two-sided to make copies in page order when they are folded and stacked.

### How to fold and unfold copies to make a magazine

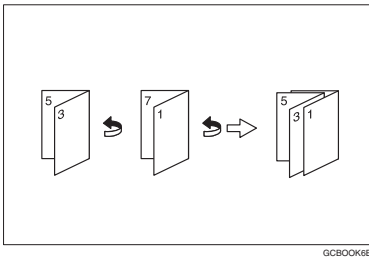
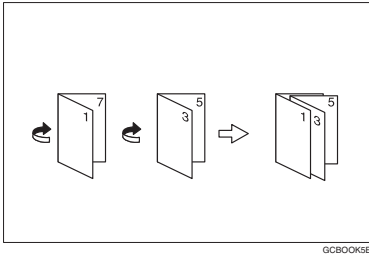

**Note**

- You cannot use the bypass tray with this function.
- The machine sets the reproduction ratio automatically to meet the paper size.

**Reference**

Related initial settings  
p.97 "Erase Original Shadow in Combine"

**1** Select "Open to left" or "Open to right" with User Tools.

**Reference**

p.99 "Orientation: Booklet, Magazine"

**2** Press [Dup./Combine/Series].

**3** Press [Series/Book].

**4** Press [Book].

**5** Select [1 Sided→Booklet], [2 Sided→Booklet], [1 Sided→Magazine] or [2 Sided→Magazine], and then press [OK].

**6** Press [OK].

**7** Select the paper.

**8** Place your originals, and then press the [Start] key.

**Note**

- When placing an original on the exposure glass or in the ADF using Batch mode, press the [#] key after all the originals have been scanned.

### Image Repeat



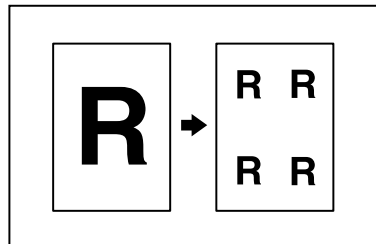

The original image is copied repeatedly.







**Note**

- The number of repeated images depends on the original size, copy paper size, and reproduction ratio. For example, see the following table:

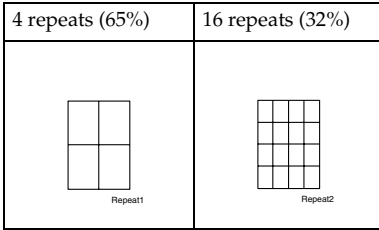

- ❖ Original: 5 1/2" x 8 1/2"  / Copy paper: 8 1/2" x 11"  or Original: 5 1/2" x 8 1/2"  / Copy paper 8 1/2" x 11" 



- ❖ Original: 5 1/2" x 8 1/2"  / Copy paper: 8 1/2" x 11"  or Original: 5 1/2" x 8 1/2"  / Copy paper 8 1/2" x 11" 

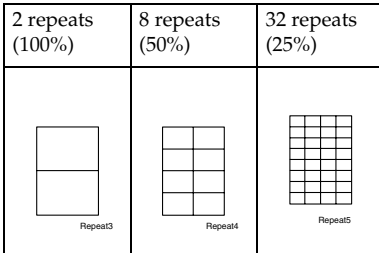

**Reference**

Related initial settings  
p.98 "Image Repeat Separation Line"

- 1** Select the size of the copy paper and the reproduction ratio.

- 2** Press [Edit/Stamp].

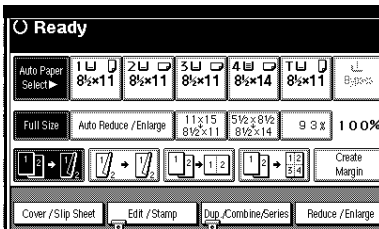

- 3** Press [Edit Image].

- 4** Press [Image Repeat].

- 5** Press [OK].

- 6** Press [OK].

- 7** Place your original, and then press the [Start] key.

**Double Copies**



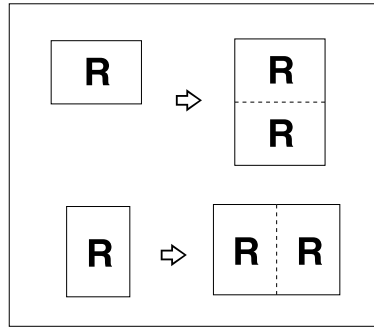







One original image is copied twice on one copy as shown.









**Note**

- ❑ You cannot use the bypass tray with this function.
- ❑ See the following table for original and copy paper sizes when using a 100% ratio:

❖ **Metric version**

Original size and orientation	Copy paper size and orientation
A5 	A4 
B6 JIS 	B5 JIS 
A4 	A3 
A5 	A4 
B6 JIS 	B5 JIS 

❖ **Inch version**

Original size and orientation	Copy paper size and orientation
5 1/2" x 8 1/2" 	8 1/2" x 11" 
5 1/2" x 8 1/2" 	8 1/2" x 11" 
8 1/2" x 11" 	11" x 17" 

- ❑ The originals of size A5, B6 JIS, 5 1/2" x 8 1/2" cannot be detected properly on the exposure glass. Be sure to select the copy paper manually or place the originals in the ADF.

**Reference**

Related initial settings  
p.98 "Double Copies Separation Line"

**1** Press [Edit/Stamp].

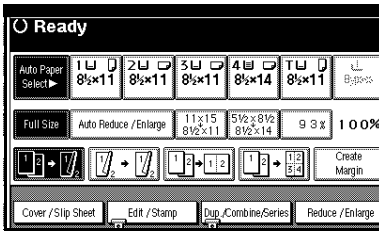

**2** Press [Edit Image].

**3** Press [Double Copies].

**4** Press [OK].

**5** Press [OK].

**6** Select the paper.

**7** Place your originals, and then press the [Start] key.

**Centring**

You can make copies with the image moved to the center.

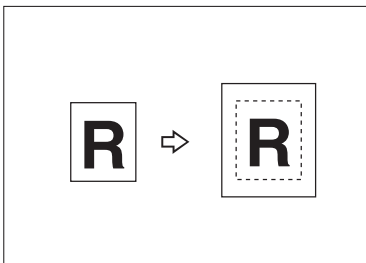

**Note**

- ❑ You cannot use the bypass tray with this function.
- ❑ The original sizes and orientations for centring are listed below.

**Metric version**

Original placed on:	Original size and orientation
Exposure glass	A3, B4 JIS, A4, B5 JIS
ADF	A3, B4 JIS, A4, B5 JIS, A5, B6 JIS, 11" x 17"

**Inch version**

Original placed on:	Original size and orientation
Exposure glass	11" x 17", 8 1/2" x 14", 8 1/2" x 11"
ADF	A3, A4, 11" x 17", 8 1/2" x 14", 8 1/2" x 11", 5 1/2" x 8 1/2"

**1** Select the paper.

**2** Press [Edit/Stamp].

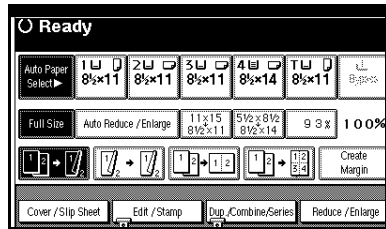

**3** Press [Edit Image].

**4** Press [Centring].

**5** Press [OK].

**6** Press [OK].

**7** Place your originals, and then press the [Start] key.

## Positive/Negative

If your original is black and white, copy images are inverted.

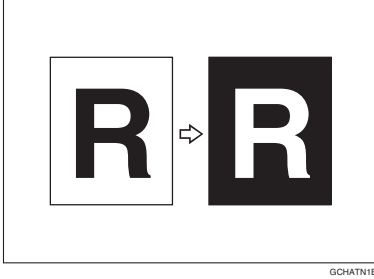

**1** Press [Edit/Stamp].

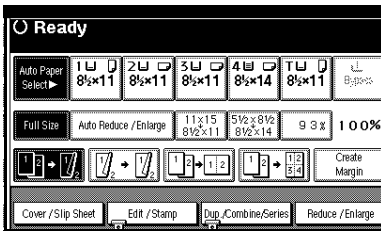

**2** Press [Edit Image].

**3** Press [Positive/Negative].

**4** Press [OK].

**5** Press [OK].

**6** Select the paper.

**7** Place your originals, and then press the [Start] key.

## Erase

This function erases the center and/or all four sides of the original image.

This function has the following three types:

### ❖ Border

This mode erases the edge margin of the original image.

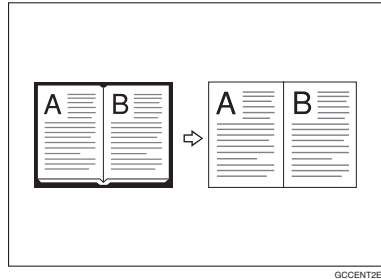

### ❖ Center

This mode erases the center margin of the original image.

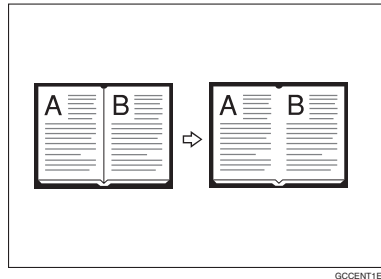

### ❖ Center/Border

This mode erases both the center and edge margins of the original image.

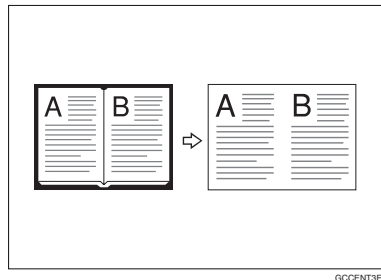

**Reference**

The erase width is set to 10 mm (0.4") as a default. You can change this setting with User Tools.

p.97 "Erase Center Width"

p.97 "Erase Border Width"

2

**Note**

- The relationship between the original orientation and the erased part is as follows:

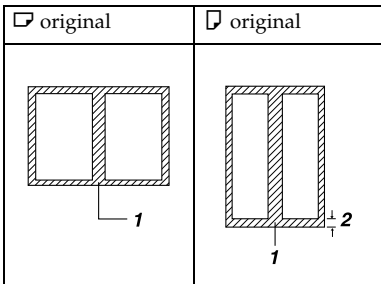

- 1: Erased part
- 2: 2–99 mm (0.1"–3.9")

**Border Erase**

- Press [Edit/Stamp].

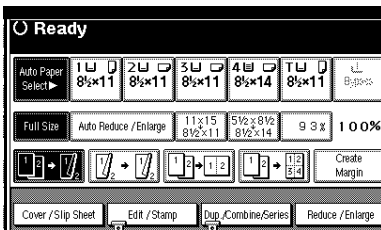

- Press [Erase].

- Set the erase border width.

Selecting [Same Width]

- Press [Same Width].

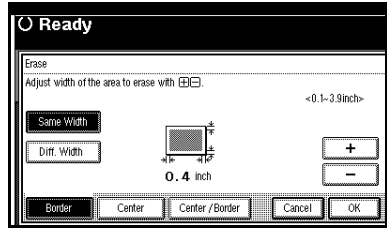

- Set an erase border width with [+] and [-].

**Note**

- To change the value entered, press [+] and [-] to set the new value.

- Press [OK].

Selecting [Diff. Width]

- Press [Diff. Width].

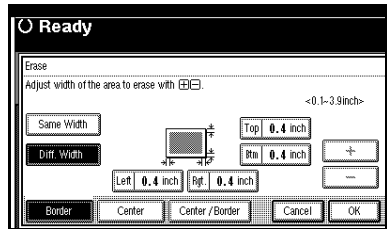

- Press the key for the border you want to change and set an erase border width with [+] and [-].

- Press [OK].

- Press [OK].

- Place your originals, and then press the [Start] key.

### Center erase

**1** Press [Edit/Stamp].

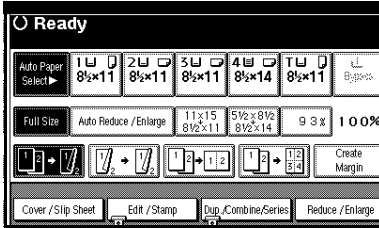

**2** Press [Erase].

**3** Press [Center].

**4** Set the erase center width with [+ ] and [- ], and then press [OK].

**5** Press [OK].

**6** Place your originals, and then press the [Start] key.

### Center/Border erase

**1** Press [Edit/Stamp].

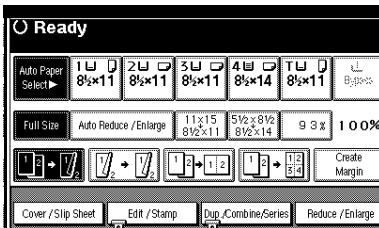

**2** Press [Erase].

**3** Press [Center/Border].

**4** Set the border to be erased.

### Selecting [Same Width]

**1** Press [Same Width].

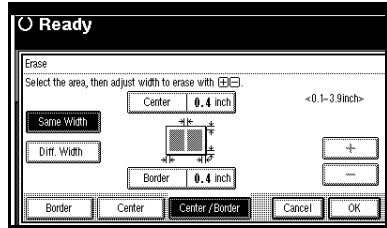

**2** Press [Center], and then set the erase center width with [+ ] and [- ].

**3** Press [Border], and then set the erase border width with [+ ] and [- ].

**4** Press [OK].

### Selecting [Diff. Width]

**1** Press [Diff. Width].

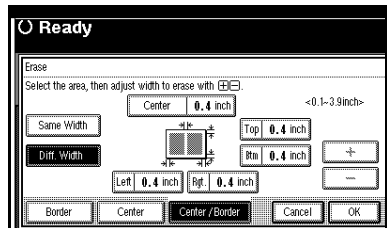

**2** Press the key for the part you want to change, and then set an erase margin width with [+ ] and [- ].

**3** Press [OK].

**5** Press [OK].

**6** Place your originals, and then press the [Start] key.

2

## Margin Adjustment

You can shift the image to the left, right, top, or bottom to make a binding margin.

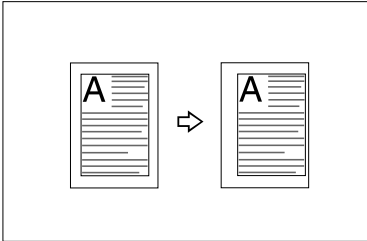

### Reference

Related initial settings

p.97 "Front Margin: Left/Right"

p.97 "Back Margin: Left/Right"

p.97 "Front Margin: Top/Bottom"

p.97 "Back Margin: Top/Bottom"

p.97 "1 Sided→2 Sided Auto Margin: TtoT"

### Note

- You can change the width of the binding margin as follows:

Metric version	0–30 mm (in increments of 1 mm)
Inch version	0"–1.2" (in increments of 0.1")

### 1 Press [Edit/Stamp].

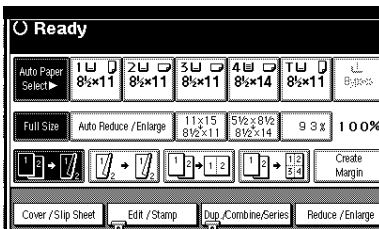

### 2 Press [Margin Adjustment].

- Set a binding margin for a front page. Press [←] and [→] when setting the left and right margins, and [↓] and [↑] when setting the top and bottom margins.

### Note

- To change the value entered, press [←], [→], [↓], [↑] to set the new value.
- If you do not need to specify the margins for the back side pages, press [OK] and proceed to step 5.

- Set a binding margin for the back side pages. Press [←] and [→] when setting the left and right margins, and [↓] and [↑] when setting the top and bottom margins, and then press [OK].

### Note

- Margin on the back side of the page is valid only when [2 Sided] or [Combine 2 Side] is selected.

- Press [OK].

- Press [OK].

- Place your originals, and then press the [Start] key.

## Background Numbering

Use this function to have numbers printed on the background of copies. It can help you to keep track of confidential documents.

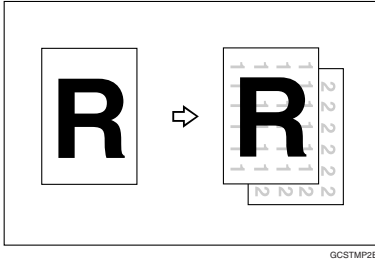

GCSTMP2E

**Note**

- You can enter a number between 1 and 999.

**Reference**

Related initial settings  
 p.99 "Size"  
 p.99 "Density"

**1** Press [Edit/Stamp].

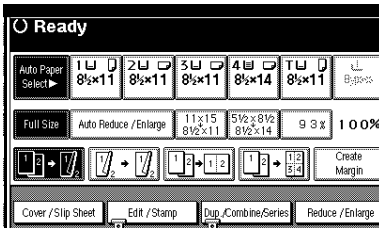

**2** Press [Stamp].

**3** Press [Background Numbering].

**4** Enter the number to start counting from with the number keys, and then press [OK].

**5** Press [OK].

**6** Press [OK].

**7** Place your originals, and then press the [Start] key.

## Preset Stamp

Messages used frequently can be stored in memory and stamped on copies.

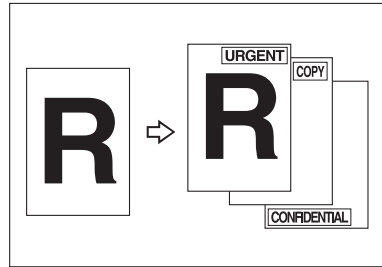

GCSTMP1E

One of the following eight messages can be stamped on copies with a frame around it: "COPY", "URGENT", "PRIORITY", "For Your Info.", "PRELIMINARY", "For Internal Use Only", "CONFIDENTIAL", "DRAFT".

## Stamp position and original orientation

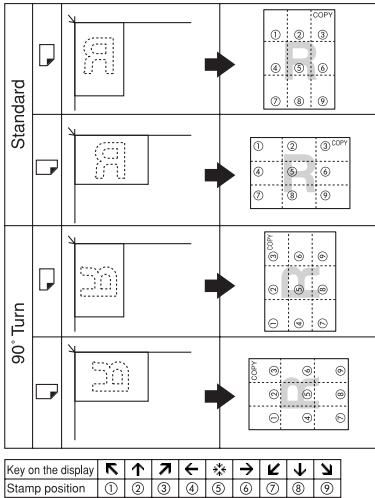

**Note**

- You cannot use the bypass tray with this function.
- Only one message can be stamped each time.

**Reference**

p.100 "Stamp Language"  
 p.100 "Stamp Position"  
 p.100 "Stamp Format"

**1** Press [Edit/Stamp].

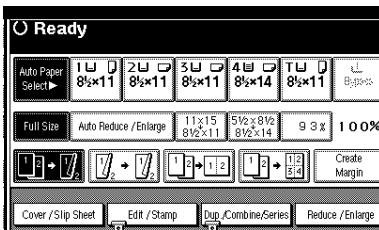

**2** Press [Stamp].

**3** Press [Preset Stamp].

**4** Select the desired message.

**5** Press [All Pages] or [1st Page only] to select the print page.

**Note**

- You can change the position, size, and density of the stamp. See p.62 "Changing the stamp position, size and density".

**6** After you specify all desired settings, press [OK].

**7** Press [OK].

**8** Place your originals, and then press the [Start] key.

### Changing the stamp position, size and density

**1** Press [Change].

**2** Select the position for print, size, and density, and then press [OK].

### User Stamp

Copies with the registered stamp.

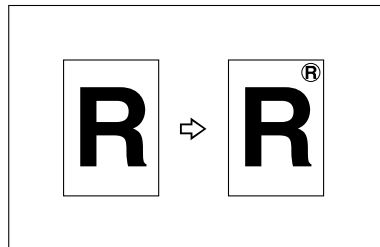

**Preparation**

You have to register a user stamp before using this function. See p.63 "To program the user stamp".



## Stamp position and original orientation

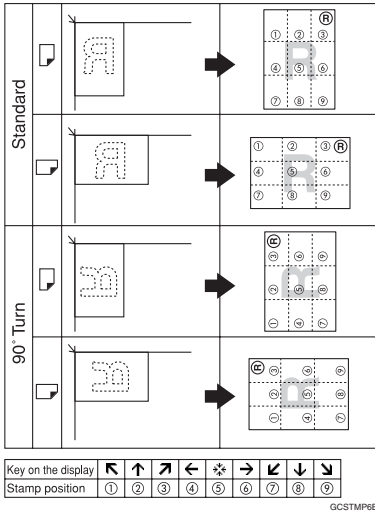

### Note

- You cannot use the bypass tray with this function.
- Only one message can be stamped each time.

### Reference

Related initial settings  
 p.100 "Stamp Position 1 - 4"  
 p.101 "Stamp Format 1 - 4"

**1** Press [Edit/Stamp].

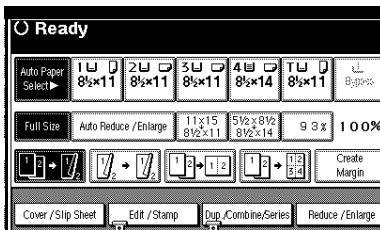

**2** Press [Stamp].

**3** Press [User Stamp].

**4** Select the stamp you require.

**5** Press [All Pages] or [1st Page only] to select the print page.

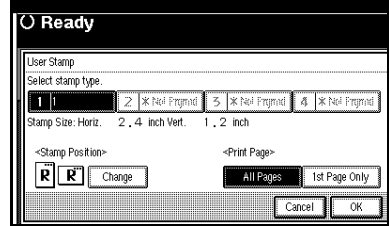

### Note

- You can change the stamp position. See p.63 "To change the stamp position".

**6** After making all settings, press [OK].

**7** Press [OK].

**8** Place your originals, and then press the [Start] key.

## To change the stamp position

**1** Press [Change].

**2** Select the desired position, and then press [OK].

## To program the user stamp

### Note

- The range of stamp images for readability is 10–297 mm high (0.4"–11.7") and 10–432 mm (0.4"–17") wide. However, if the value exceeds the maximum value of the area (5,000 mm<sup>2</sup>, 7.75 inch<sup>2</sup>), it is corrected within the range of the area automatically.
- Up to four images that you use frequently can be stored in the machine's memory.

2

**1** Make sure that the machine is in copier mode.

**2** Press the [User Tools/Counter] key.

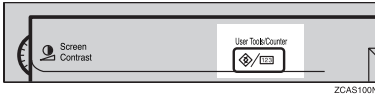

**3** Press [Copier/Document Server Features].

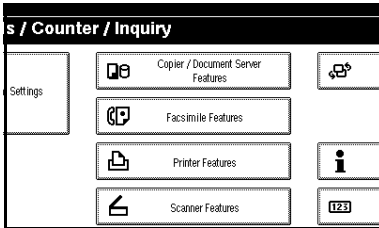

**4** Press [Stamp].

**5** Press [User Stamp].

**6** Press [Program/Delete Stamp].

**7** Press [Program], and then press the stamp number (1–4) you want to program.

**Note**

- Stamp numbers with ↗ already have settings in them.
- If the stamp number is already being used, the machine will ask you if you want to overwrite it . Press [Yes] or [No].

**8** Enter the user stamp name with the letter keys on the display panel. You can register up to 10 characters.

**9** Press [OK].

**Reference**

“Entering Text”, *General Settings Guide*

**10** Enter the horizontal size of the stamp with the number keys, and then press [#].

**11** Press [Vertical], and then enter the vertical size in the same way as step 10.

**12** Place the original for user stamp on the exposure glass, and then press [Start Scanning].

The original will be scanned, and the stamp will be registered.

**Note**

- Originals cannot be scanned from the ADF when programming the user stamp.

**13** Press [Exit].

**14** Press [Exit].

The display returns to the Copier/Document Server Features main menu.

**15** Press [Exit].

Exits settings and gets ready to copy.

**To delete the user stamp**

**Important**

- You cannot restore a deleted stamp.

**1** Make sure that the machine is in copier mode.

**2** Press the [User Tools/Counter] key.

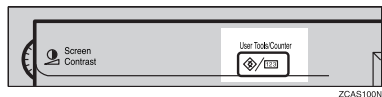

**3** Press [Copier/Document Server Features].

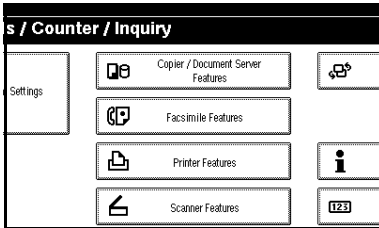

**4** Press [Stamp].

**5** Press [User Stamp].

**6** Press [Program/Delete Stamp].

**7** Press [Delete], and then press the stamp number you want to delete.

**8** Select [Delete], and then press [Exit].

**9** Press [Exit].

The display returns to the Copier/Document Server Features main menu.

**10** Press [Exit].

Exits settings and gets ready to copy.

You can select from the following styles:

- MM/DD/YYYY
- MM.DD.YYYY
- DD/MM/YYYY
- DD.MM.YYYY
- YYYY.MM.DD

### Stamp position and original orientation

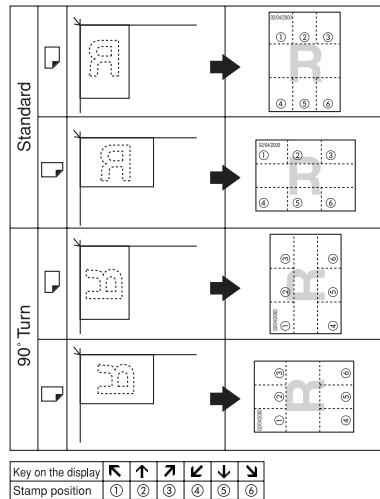

GCSTMP7E

### Date Stamp

Use this function to print dates on your copies.

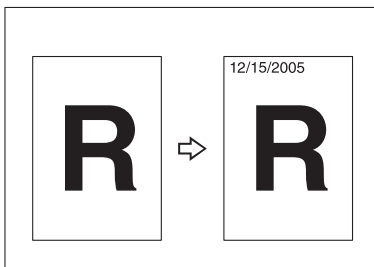

AH0019S

#### Note

- You cannot use the bypass tray with this function.

#### Reference

Related initial settings

p.101 "Font"

p.101 "Size"

p.101 "Superimpose"

p.101 "Stamp Position"

"Timer Settings", *General Settings Guide*

**1** Press [Edit/Stamp].

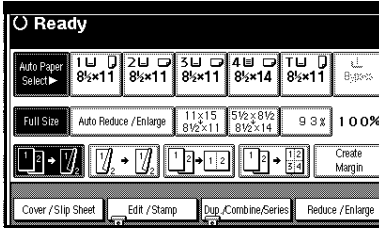

**2** Press [Stamp].

**3** Press [Date Stamp].

**4** Press [All Pages] or [1st Page only] to select the print page.

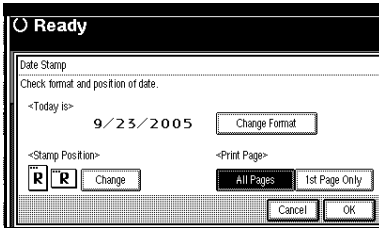

**Note**

- You can change the font and position of the date to be stamped. See p.66 "To change the style of date".

**5** After all settings are complete, press [OK].

**6** Press [OK].

**7** Place your originals, and then press the [Start] key.

**To change the style of date**

**1** Press [Change Format].

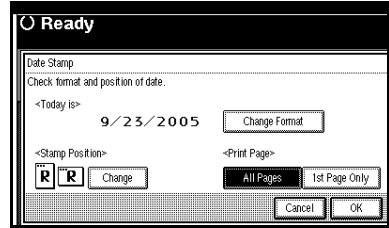

**2** Select the date format, and then press [OK].

**To change the stamp position**

**1** Press [Change].

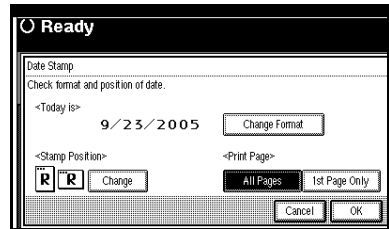

**2** Select the desired date stamp position, and then press [OK].

**Page Numbering**

Use this function to print page numbers on your copies.

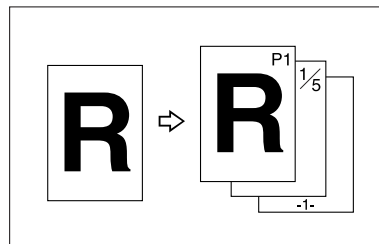

CP2G0100

There are six types of Page Numbering (n is the total number of pages in your original):

- P1, P2,...Pn
- 1/n, 2/n,...n/n
- -1-, -2-,...-n-
- P.1, P.2 ...P.n
- 1, 2...n
- 1-1, 1-2,...1-n

### Stamp position and original orientation

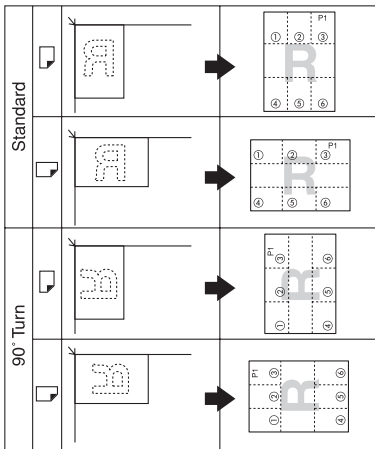

Key on the display	↶	↷	↵	↶	↷	↵
Stamp position	①	②	③	④	⑤	⑥

GCSTMPBE

#### Note

- You cannot use the bypass tray with this function.

#### Reference

- Related initial settings
- p.101 "Font"
- p.101 "Size"
- p.102 "Superimpose"
- p.101 "Stamp Format"
- p.101 "Duplex Back Page Stamping Position"
- p.102 "Stamp Position"

p.102 "Stamp on Designating Slip Sheet"

#### 1 Press [Edit/Stamp].

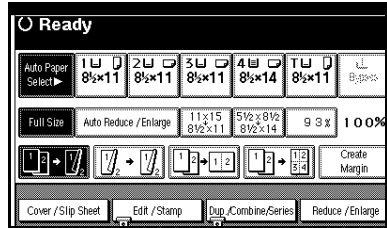

#### 2 Press [Stamp].

#### 3 Press [Page Numbering].

#### 4 Select the format.

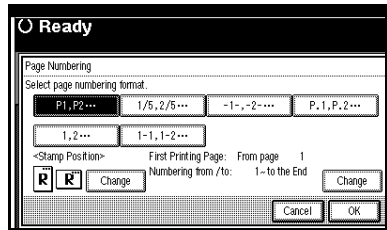

#### Note

- You can specify the stamp position, pages to be stamped, and numbering. See p.67 "Changing the stamp position" and p.68 "Specifying the first printing page and start number".

#### 5 After you specify all desired settings, press [OK].

#### 6 Press [OK].

#### 7 Place the originals, and then press the [Start] key.

### Changing the stamp position

#### 1 Press [Change].

#### 2 Select the desired position, and then press [OK].

2

## Specifying the first printing page and start number

If you selected (P1, P2..., -1,-2-..., P.1, P.2..., 1, 2..., )

2

**Note**

- Below explains the example when (P1, P2...) is selected. The steps are the same for other cases.

**1** Press **[Change]** on the right side.

**2** Press **[First Printing Page]**, enter the original sheet number from which to start printing, and then press the **[#]** key.

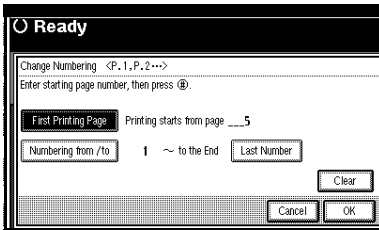

**Note**

- To change the number entered, press **[Clear]** or the **[Clear/Stop]** key, and then enter a new number.

**3** Press **[Numbering from/to]**, enter the number of the page from which to start numbering with the number keys, and then press the **[#]** key.

**Note**

- The example below shows when the first printing page is "2" and the start number is "3".

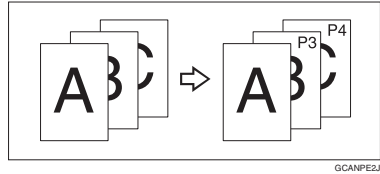

**4** Press **[Last Number]**, enter the number of the page at which to stop numbering with the number keys, and then press the **[#]** key.

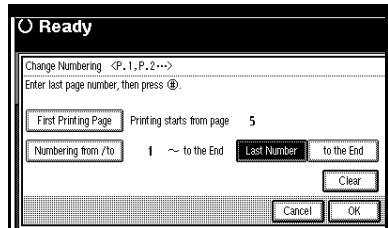

**Note**

- If you want to number all pages to the end, press **[to the end]**.

**5** When page designation is complete, press **[OK]**.

**6** Press **[OK]**.

If you selected (1/5, 2/5...)

- 1 Press **[Change]** on the right side.
- 2 Press **[First Printing Page]**, enter the original sheet number from which to start printing, and then press the **[#]** key.

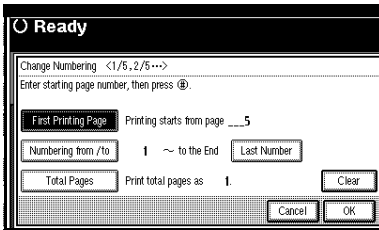

#### Note

- You can enter between 1 and 9999 for the original sheet number from which to start printing.
- To change the number entered, press **[Clear]** or the **[Clear/Stop]** key, and then enter a new number.

- 3 Press **[Numbering from/to]**, enter the number of page from which to start numbering with the number keys, and then press the **[#]** key.

- 4 Press **[Last Number]**, enter the number of page at which to stop numbering with the number keys, and then press the **[#]** key.

Proceed to step 5 when not changing.

#### Note

- If you want to number all pages to the end, press **[to the end]**.

- The last number is the last page number to print. For example, if **[Total Pages]** is ten, if you want to print up to seven pages and do not want to print from page 8 on, enter **[7]** for **[Last Number]**. Normally, you do not need to enter the number.

- 5 Press **[Total Pages]**, enter the total number of original pages with the number keys, and then press the **[#]** key.

- 6 When page designation is complete, press **[OK]**.

#### Note

- To change the settings after pressing **[OK]**, press **[Change]**, and then enter the numbers again.

If you selected (1-1, 1-2,...)

- 1 Press **[Change]** on the right side.
- 2 Press **[First Printing Page]**, enter the original sheet number from which to start printing, and then press the **[#]** key.

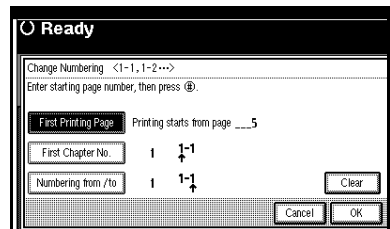

#### Note

- To change the number entered, press **[Clear]** or the **[Clear/Stop]** key, and then enter a new number.

**3** Press **[First Chapter No.]**, enter the chapter number from which to start numbering with the number keys, and then press the **[#]** key.

**Note**

- You can enter between 1 and 9999 for the chapter number from which to start numbering.

**4** Press **[Numbering from/to]**, enter the page number from which to start printing with the number keys, and then press the **[#]** key.

**5** Press **[OK]**.

**6** When page designation is complete, press **[OK]**.

## Covers

Using this function, you can create cover sheets by adding additional pages of different paper or copying existing pages on different paper.

**Preparation**

Before selecting this function, set the tray for the front cover paper. See "Cover Sheet Tray" in "Tray Paper Settings", *General Settings Guide*.

**Note**

- The cover sheet should be the same size and orientation as the copy paper.
- You cannot place the copy paper in the bypass tray.
- When selecting **[Copy]**, select whether the front and back covers are copied one-sided or two-sided. See "Cover Sheet Tray" in "Tray Paper Settings", *General Settings Guide*.

❖ **Front cover**

The first page of your originals is copied on specific paper sheet for covers, or a cover sheet is inserted before the first copy.

- Copy

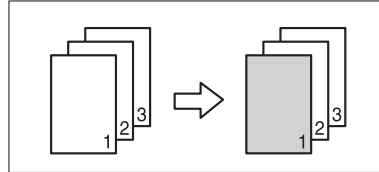

- Blank

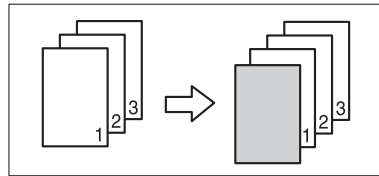

❖ **Front/Back covers**

The first and last pages of your original are copied on specific paper for use as covers.

- Copy

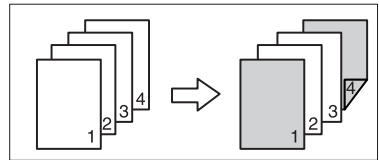

GCCOVED8

- Blank

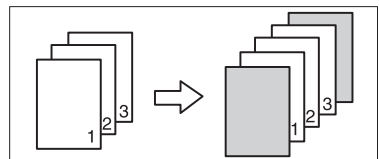

**Reference**

p.99 "Front Cover Copy in Combine"



## 1 Press [Cover/Slip Sheet].

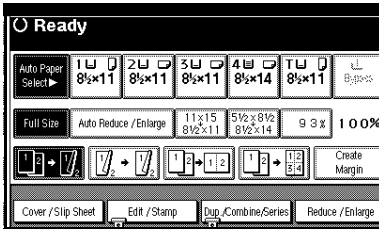

## 2 Press [Front Cover] or [Front/Back Cover].

## 3 Select [Copy] or [Blank] for the cover sheet.

## 4 Select the paper tray that contains the sheet paper to copy the originals, and then press [OK].

## 5 Place your originals in the ADF, and then press the [Start] key.

## Designate

Use this function to have certain pages of your original copied onto slip sheets.

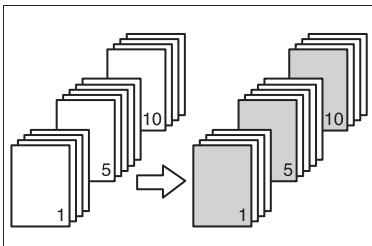

### Preparation

Before using this function, set the special paper tray for slip sheets. See "Cover Sheet Tray" and "Slip Sheet Tray" in "Tray Paper Settings", *General Settings Guide*.

### Note

- The slip sheets should be the same size and orientation as the copy paper.
- You cannot place the copy paper in the bypass tray.
- You can specify the pages up to 20.

## 1 Press [Cover/Slip Sheet].

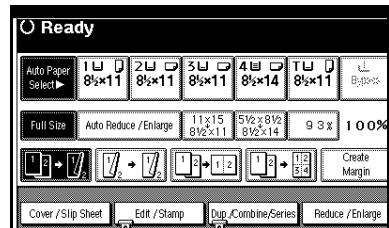

## 2 Press [Desig./Chapter].

## 3 Press the key to select the chapter number.

## 4 Enter the page number of the original's location you want to copy onto a slip sheet with the number keys, and then press the [#] key.

## 5 Select the paper tray for slip sheets.

## 6 To specify another page location, repeat steps 3 to 5.

### Note

- To select chapters 11 to 20, press the [▼11~20] key.

## 7 When page designation is complete, press [OK].

## 8 Press [OK].

## 9 Select the paper tray that contains the sheet paper to copy the originals.

## 10 Place your originals in the ADF, and then press the [Start] key.

## Chapter

The page locations you specify with this function will appear on the front of copy sheets.

### Preparation

Before selecting this function, press **[Dup./Combine/Series]** and select Duplex (1 Sided→2 Sided) mode or Combine mode.

### Note

- This function can be used only when you use the Duplex (1 Sided→2 Sided) or Combine function.
- You can specify the pages up to 20.

### 1 Press **[Cover/Slip Sheet]**.

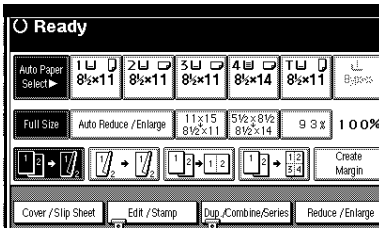

### 2 Press **[Desig./Chapter]**.

### 3 Press **[Chapter]**.

### 4 Press the key to select the chapter number.

### 5 Enter the page location of the first page of the first chapter with the number keys, and then press the **[#]** key.

### 6 To specify another page location, repeat steps 4 to 5.

### Note

- To select chapters 11 to 20, press the **[▼11-20]** key.

### 7 When page designation is complete, press **[OK]**.

### 8 Place your originals, and then press the **[Start]** key.

## Slip Sheets

Using this function, you can insert a slip sheet between OHP transparencies or stacks. You can also print on the inserted slip sheet.

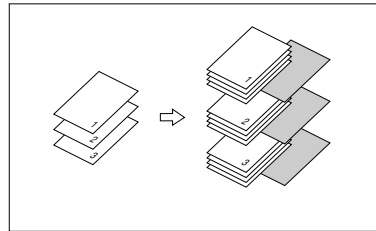

### Preparation

Before selecting this function, specify the paper tray for slip sheets. See "Slip Sheet Tray" in "Tray Paper Settings", *General Settings Guide*.

### Note

- Load the slip sheets in the same size and orientation as the copy paper or the OHP transparency.

❖ When using OHP transparencies placed in the bypass tray

- Copy

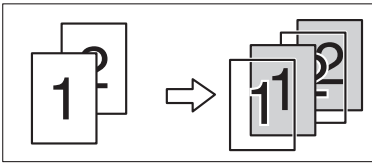

- Blank

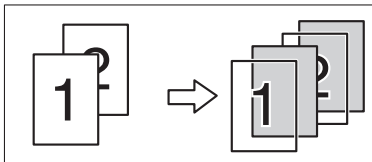

**Note**

- ❑ Press the [#] key and select [OHP Sheet] in Special paper. See p.22 “When copying onto special paper”.

**1** Press [Cover/Slip Sheet].

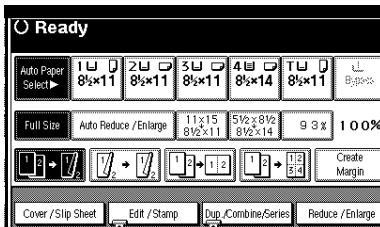

**2** Press [Slip Sheet].

**3** Select [Copy] or [Blank], and then press [OK].

**4** Select the paper tray containing the sheet paper to copy the originals.

**5** Place the originals, and then press the [Start] key.

# Storing Data in the Document Server

The Document Server enables you to store documents in the memory and print them as you want.

## Important

- ❑ Data stored in the machine might be lost if some kind of failure occurs. The manufacturer shall not be responsible for any damage that might result from the loss of data.

## Note

- ❑ Data stored in the Document Server is set to be deleted after three days by the factory default. You can specify the period after which the stored data is deleted automatically. For more information about settings, see “Auto Delete File” in “Key Operator Tools”, *General Settings Guide*.

### 1 Press [Store File].

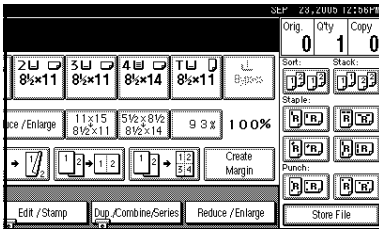

### 2 Enter a file name, user name, or password if necessary.

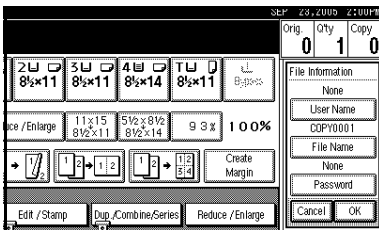

## Reference

For details about how to register the file name, user name or password, see *General Settings Guide*.

### 3 Press [OK].

### 4 Place the originals.

## Reference

For more information about the types of originals that can be placed and how to place them, see p.12 “Placing Originals”.

### 5 Make the scanning settings for the original.

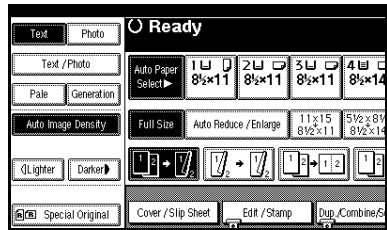

### 6 Press the [Start] key.

Originals are scanned and stored in memory.

## Note

- ❑ To stop scanning, press the [Clear/Stop] key. To resume a paused scanning job, press [Continue] in the confirmation display. To delete scanned images and cancel the job, press [Stop]. The originals placed in the ADF are delivered.
- ❑ When placing an original on the exposure glass, press the [#] key after all the originals have been scanned.
- ❑ To check if the document has been stored, press the [Document Server] key.

# Programs

You can store frequently used copy job settings in the machine memory and recall them for future use.

## Storing a Program

**Note**

- ❑ You can store up to 10 programs.
- ❑ You can select the standard mode or program No. 10 as the mode to be set when modes are cleared or reset, or immediately after the operation switch is turned on. See p.94 “Change Initial Mode”.
- ❑ Paper settings are stored based on paper size. So if you place more than one paper tray of the same size, the paper tray prioritized with User Tools (System Settings) will be selected first. See “Paper Tray Priority” in “Tray Paper Settings”, *General Settings Guide*.
- ❑ Programs are not deleted by turning the power off or by pressing the **[Clear Modes]** key. They are canceled only when you delete or overwrite them with another program.

**1** Edit the copy settings so all functions you want to store in this program are selected.

**2** Press the **[Program]** key.

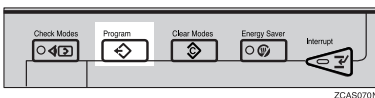

**3** Press **[Register]**.

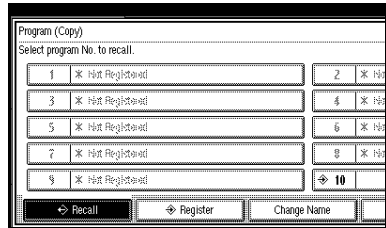

**4** Press the program number you want to store.

**Note**

- ❑ Program numbers with **↔** against them already have settings in them.

**Reference**

p.76 “Changing a Stored Program”

**5** Enter the program name with the letter keys on the display panel.

You can enter up to 40 characters.

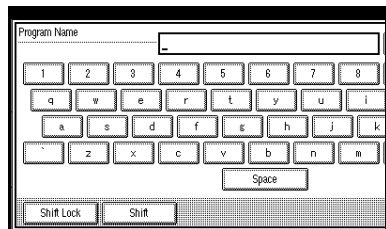

**Reference**

For details about entering characters, see “Entering Text”, *General Settings Guide*.

**Note**

- ❑ If you do not want to enter the program name, proceed to step **6**.

**6** Press [OK].

When the settings are successfully stored, ⇨ appears on the left side and the program name appears on the right side of the registered program number. The display returns to the initial copy display for a while.

### Changing a Stored Program

**1** Check the program settings.

**Note**

- When you want to check the contents of a program, recall the program. See p.76 “Recalling a Program”.

**2** Repeat steps **1** to **4** of “Storing a Program”.

**3** Press [Register].

Repeat steps **1**, **2** of “Storing a Program”.

**Note**

- When it is overwritten, the previous program is deleted.

### Deleting a Program

**1** Press the [Program] key.

**2** Press [Delete].

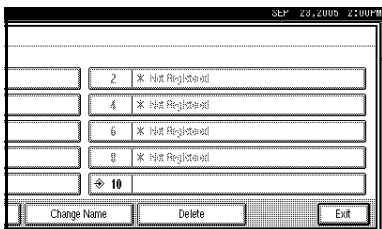

**3** Press the program number you want to delete.

**4** Press [Yes].

The program is deleted, and the display returns to the initial copy display.

### Recalling a Program

**1** Press the [Program] key.

**2** Press [Recall].

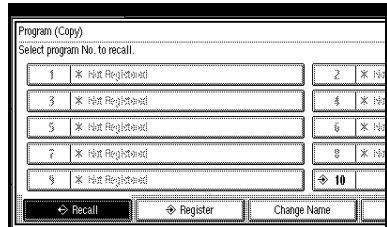

**3** Press the program number you want to recall.

The stored settings are displayed.

**Note**

- Program numbers with ⇨ against them already have settings in them.

**4** Place the originals, and then press the [Start] key.

# 3. Troubleshooting











## If Your Machine Does Not Operate As You Want

### When a Message Is Displayed

The following chart contains explanations for the common messages. If other messages appear, follow the instructions as they are displayed.

#### Note

For messages that are not listed here, see *General Settings Guide*.



Message	Causes	Solutions
Cannot detect original size.	Improper original is placed. See p.11 "Sizes difficult to detect".	Select paper manually, not in Auto Paper Select mode, and do not use Auto Reduce/Enlarge function. Place the original on the exposure glass. See p.13 "Placing Originals on the Exposure Glass".
	Original is not placed.	Place your originals.
Check original orientation.	Original is not placed in a proper orientation.	Change the orientation of the original.
Check paper size.	Improper paper size is set.	If you press the <b>[Start]</b> key, copy will start onto the selected paper.
Rotate Sort is not available with this image size.	A size of paper for which Rotate Sort is not available is selected.	Select the proper paper size. See p.33 "Sort".
Cannot punch paper of this size.	The Punch function cannot be used with paper size selected.	The following paper sizes are available for Punch mode: A3  , B4 JIS  , A4  , B5 JIS  , A5  , 11"×17"  , 8 1/2"×14"  and 5 1/2"×8 1/2"  . Select one of these sizes.
It is over stapling capacity.	The number of sheets per set is over the staple capacity.	Check the stapler capacity. See p.110 "Staple".
Cannot staple paper of this size.	The Staple function cannot be used with paper size selected.	Select a paper size that can be used in Staple mode. See p.110 "Staple".
Duplex is not available with this paper size.	A paper size not available in Duplex mode has been selected.	The following paper sizes are available for Duplex mode: 11" × 17"  , 8 1/2" × 14"  , 8 1/2" × 11"  . Select one of these sizes.

3

Message	Causes	Solutions
Maximum number of sets is *.	The number of copies exceeds the maximum copy quantity.	You can change the maximum copy quantity. See p.94 "Max. Copy Quantity".
Original is being scanned by another function.	The Document Server function is in use.	To cancel the job in process, press <b>[Exit]</b> , and then press the <b>[Document Server]</b> key. Next, press the <b>[Clear/Stop]</b> key. When the message "[Stop] key was pressed. Stop storing?" appears, press <b>[Stop]</b> .
You do not have the privileges to use this function.	The use of this function is restricted to authenticated users only.	Contact the administrator.
Authentication has failed.	The entered login user name or login password is not correct.	Inquire the user administrator for the correct login user name and login password.
	The machine cannot perform authentication.	Contact the administrator.
The selected file(s) which you do not have access privileges to could not be deleted.	You have tried to delete files without the authority to do so.	Files can be deleted by the person who created the file. To delete a file which you are not authorized to delete, contact the person who created the file.
"Updating the destination list...Please wait. Specified destination(s) or sender's name has been cleared." appears, and operations are not possible.	The destination list is being updated from the network using SmartDeviceMonitor for Admin. Depending on the number of destinations to be updated, there may be some delay before you can resume operation. Operations are not possible while this message is displayed.	Wait until the message disappears. Do not switch off the power while this message is displayed.





# If You Cannot Make Clear Copies

Problem	Causes	Solutions
Copies appear dirty.	Image density is too dark.	Adjust the image density. See p.23 "Adjusting Image Density".
	Auto Image Density is not selected.	Adjust the auto density. See p.23 "Adjusting Image Density".
The reverse side of an original image is copied.	Image density is too dark.	Adjust the image density. See p.23 "Adjusting Image Density".
	Auto Image Density is not selected.	Adjust the auto density. See p.23 "Adjusting Image Density".
A shadow appears on copies if you use pasted originals.	Image density is too dark.	Adjust the image density. See p.23 "Adjusting Image Density". Change the orientation of the original. Put mending tape on the pasted part.
The same copy area is dirty whenever making copies.	The exposure glass or ADF is dirty.	Clean them. See <i>General Settings Guide</i> .
Copies are too light.	Image density is too light.	Adjust the image density. See p.23 "Adjusting Image Density".
	The paper size is not appropriate.	Use the recommended paper.  <b>Note</b> <input type="checkbox"/> A light copy may result when you use damp or rough grain paper.
	Toner bottle is almost empty.	Add toner. See <i>General Settings Guide</i> .
Parts of the image are not copied.	The original is not set correctly.	Set originals correctly. See p.12 "Placing Originals".
	An improper paper size is selected.	Select the proper paper size.
Copies are blank.	The original is not set correctly.	When using the exposure glass, face the originals down. When using the ADF, face them up. See p.12 "Placing Originals".
A moiré pattern is produced on copies. 	Your original has a dot pattern image or many lines.	Place the original on the exposure glass at a slight angle.

# If You Cannot Make Copies As You Want

This section explains causes and remedies when copy results are not as expected.

❖ **Basic**

Problem	Causes	Solutions
Copies are not stapled.	There are jammed staples in the stapler.	Remove jammed staples. See <i>General Settings Guide</i> .   <b>Note</b> <input type="checkbox"/> After removing jammed staples, staples might not be ejected the first few times you try to use the stapler.
	The number of copies exceeds the capacity of the stapler.	Check the stapler capacity. See p.110 "Staple".
	Copy paper is curled.	Turn the copy paper over in the tray.
Staples are wrongly positioned.	Originals are not set correctly.	Check the correct position to place the originals. See p.37 "Staple".
You cannot combine several functions.	Selected functions cannot be used together.	Check the combination of functions and make the settings again.   <b>Reference</b> p.105 "Combination Chart"
When sorting, the pages are divided into two blocks.	The memory became full in the middle of sorting and the pages were delivered in two blocks.	You can interrupt copying when the memory becomes full. See p.103 "Memory Full Auto Scan Restart".
Paper does not output during printing with stapling.	When you stop printing while using the staple function, papers not stapled during printing may be left in the staple unit.	Press the <b>[Reset]</b> key and cancel copy settings, including stapling.

## ❖ Edit

Problem	Causes	Solutions
In Double Copies mode, parts of the original image are not copied.	Combination of original and copy paper is not correct.	Select 8 <sup>1</sup> / <sub>2</sub> " × 11" for 5 <sup>1</sup> / <sub>2</sub> " × 8 <sup>1</sup> / <sub>2</sub> " originals and 11" × 17" for 8 <sup>1</sup> / <sub>2</sub> " × 11" originals.
In Border, Center, or Center/Border mode, parts of the original image are not copied.	You set a wide erased margin.	Make the margin width narrower. You can adjust it between 2–99 mm (0.1"–3.9"). See p.97 "Erase Border Width" and p.97 "Erase Center Width".
	Originals are not scanned correctly.	Place the originals correctly.
In Margin Adjustment mode, parts of the original image are not copied.	You set a wide erased margin.	Set a narrower margin with User Tools. You can set the width between 0–30 mm (0"–1.2"). See p.97 "Front Margin: Left/Right", p.97 "Front Margin: Top/Bottom", p.97 "Back Margin: Left/Right", and p.97 "Back Margin: Top/Bottom".
	There is a lack of margin space on the opposite side of the binding position.	
In Image Repeat mode, the original image is not copied repeatedly.	You selected copy paper the same size as the originals, or you did not select the proper reproduction ratio.	Select copy paper larger than the originals.
		Select the proper reproduction ratio.

## ❖ Stamp

Problem	Causes	Solutions
The stamp position is wrong.	The paper orientation is wrong.	Check the paper orientation and stamp position.

❖ **Combine**

Problem	Causes	Solutions
You cannot make a book from Booklet or Magazine mode by folding copies.	You selected a setting (“Open to left” or “Open to right”) that does not match the orientation of originals.	Change the setting.
When using Combine, parts of the image are not copied.	You specified a reproduction ratio that does not match the sizes of your originals and copy paper.	When you specify a reproduction ratio using Manual Paper Select mode, make sure that the ratio matches your originals and the copy paper.   <b>Note</b> <input type="checkbox"/> Select the correct reproduction ratio before using Combine mode.
Copies are not in correct order.	You placed the originals in the incorrect order.	When placing a stack of originals in the ADF, the last page should be on the bottom.
		If you place an original on the exposure glass, start with the first page to be copied.

❖ **Duplex**

Problem	Causes	Solutions
When using Duplex, copy is made Top/Bottom even though Left/Right is selected.	You placed the originals in the wrong orientation.	Place the originals in the correct orientation. See p.12 “Original Orientation” .
Copies are not in correct order.	You placed the originals in the incorrect order.	When placing a stack of originals in the ADF, the last page should be on the bottom.
		If you place an original on the exposure glass, start with the first page to be copied.

## When Memory Is Full

### Note

- If you set **[Memory Full Auto Scan Restart]** in User Tools (see p.103 “Memory Full Auto Scan Restart” ) to **[Yes]**, even if the memory becomes full, the memory overflow message will not be displayed. The machine will make copies of the scanned originals first, then automatically proceed scanning and copying the remaining originals. In this case, the resulting sorted pages will not be sequential.

Messages	Causes	Solutions
<p>Memory is full.* originals have been scanned.</p> <p>Press [Print] to copy scanned originals. Do not remove remaining originals.</p> <p> <b>Note</b></p> <p><input type="checkbox"/> Copying will stop and this message will be displayed when the memory is full.</p>	<p>The scanned original exceeds the number of pages that can be stored in memory.</p>	<p>Press <b>[Print]</b> to copy scanned originals and cancel the scanning data. Press <b>[Clear]</b> to cancel the scanning data and not copy.</p>
<p>Press [Resume] to scan and copy remaining originals.</p> <p><b>[Stop] [Resume]</b></p>	<p>The machine checks if the remaining originals should be copied, after the scanned original has been printed.</p>	<p>To continue copying, remove all copies, and then press <b>[Resume]</b>. To stop copying, press <b>[Stop]</b>.</p>



# 4. User Tools (Copier/Document Server Features)

## User Tools Menu (Copier/Document Server Features)

User Tools Item Names	Default
General Features P.1/4 (See p.92 "General Features P.1/4".)	
Auto Paper Select Priority	<i>On</i>
Auto Tray Switching	<i>With Image Rotation</i>
Paper Display	<i>Display</i>
Original Type Priority	<i>Text</i>
Original Type Display	<i>Display</i>
Auto Image Density Priority	Text: <i>On</i> Text/Photo: <i>On</i> Photo: <i>Off</i> Pale: <i>On</i> Generation Copy: <i>On</i>
Copy Quality	Text: <i>Normal</i> Text/Photo: <i>Normal</i> Photo: <i>Print Photo</i> Pale: <i>Normal</i> Generation Copy: <i>Normal</i>
Image Density	Text: <i>Normal</i> Text/Photo: <i>Normal</i> Photo: <i>Normal</i> Pale: <i>Normal</i> Generation Copy: <i>Normal</i>
General Features P.2/4 (See p.94 "General Features P.2/4".)	
Duplex Mode Priority	<i>1 Sided → 1 Sided (metric)</i> <i>1 Sided → 2 Sided (inch)</i>
Copy Orientation in Duplex Mode	<i>Top to Top</i>
Original Orientation in Duplex Mode	<i>Top to Top</i>
Change Initial Mode	<i>Standard</i>
Max. Copy Quantity	<i>999 Sheets</i>
Tone: Original remains	<i>On</i>
Job End Call	<i>On</i>

User Tools Item Names	Default
General Features P.3/4 (See p.94 "General Features P. <sup>3</sup> / <sub>4</sub> ".)	
Copy Function Key: F1–F5	<ul style="list-style-type: none"> <li>• F1: 1 Sided → 2 Sided: T to T</li> <li>• F2: 2 Sided: T to T → 2 Sided: T to T</li> <li>• F3: 1 Sided → 1 Sided Combine</li> <li>• F4: 1 Sided → 1 Sided Combine: 4 originals</li> <li>• F5: Create Margin</li> </ul>
General Features P.4/4 (See p.95 "General Features P. <sup>4</sup> / <sub>4</sub> ".)	
Document Server Storage Key: F1–F5	<ul style="list-style-type: none"> <li>• F1: 2 Sided Original Top to Top</li> <li>• F2: 1 Sided → 1 Sided Combine</li> <li>• F3: 1 Sided → 1 Sided Combine: 4 originals</li> <li>• F4: 1 Sided → 1 Sided Combine: 8 originals</li> <li>• F5: Create Margin</li> </ul>
Reproduction Ratio P.1/2 (See p.95 "Reproduction Ratio P. <sup>1</sup> / <sub>2</sub> ".)	
Shortcut R/E	<p>Metric version</p> <ul style="list-style-type: none"> <li>• Shortcut R/E 1: 71%</li> <li>• Shortcut R/E 2: 141%</li> <li>• Shortcut R/E 3: 93%</li> </ul> <p>Inch version</p> <ul style="list-style-type: none"> <li>• Shortcut R/E 1: 73%</li> <li>• Shortcut R/E 2: 155%</li> <li>• Shortcut R/E 3: 93%</li> </ul>
Enlarge 1–5	<p>Metric version</p> <ul style="list-style-type: none"> <li>• Enlarge 1: 115%</li> <li>• Enlarge 2: 122%</li> <li>• Enlarge 3: 141%</li> <li>• Enlarge 4: 200%</li> <li>• Enlarge 5: 400%</li> </ul> <p>Inch version</p> <ul style="list-style-type: none"> <li>• Enlarge 1: 121%</li> <li>• Enlarge 2: 129%</li> <li>• Enlarge 3: 155%</li> <li>• Enlarge 4: 200%</li> <li>• Enlarge 5: 400%</li> </ul>
Priority Setting: Enlarge	<p>Metric version: 141%</p> <p>Inch version: 155%</p>



User Tools Item Names	Default
Reproduction Ratio P.2/2 (See p.96 "Reproduction Ratio P. <sup>2</sup> /2".)	
Reduce 1-6	Metric version <ul style="list-style-type: none"> <li>•Reduce 1: 25%</li> <li>•Reduce 2: 50%</li> <li>•Reduce 3: 65%</li> <li>•Reduce 4: 71%</li> <li>•Reduce 5: 75%</li> <li>•Reduce 6: 82%</li> </ul> Inch version <ul style="list-style-type: none"> <li>•Reduce 1: 25%</li> <li>•Reduce 2: 50%</li> <li>•Reduce 3: 65%</li> <li>•Reduce 4: 73%</li> <li>•Reduce 5: 78%</li> <li>•Reduce 6: 85%</li> </ul>
Priority Setting: Reduce	Metric version: 71% Inch version: 73%
Ratio for Create Margin	93%
R/E Priority	<i>Reduce</i>
Edit P.1/2 (See p.96 "Edit P. <sup>1</sup> /2".)	
Front Margin: Left/Right	Metric version: <i>Left 5 mm</i> Inch version: <i>Left 0.2"</i>
Back Margin: Left/Right	Metric version: <i>Right 5 mm</i> Inch version: <i>Right 0.2"</i>
Front Margin: Top/Bottom	Metric version: <i>T/B 0 mm</i> Inch version: <i>T/B 0"</i>
Back Margin: Top/Bottom	Metric version: <i>T/B 0 mm</i> Inch version: <i>T/B 0"</i>
1 Sided→2 Sided Auto Margin: TtoT	Metric version: <i>Right 5 mm</i> Inch version: <i>Right 0.2"</i>
1 Sided→2 Sided Auto Margin: TtoB	Metric version: <i>T/B 0 mm</i> Inch version: <i>T/B 0"</i>
Erase Border Width	Metric version: <i>10 mm</i> Inch version: <i>0.4"</i>
Erase Original Shadow in Combine	<i>Yes</i>
Erase Center Width	Metric version: <i>10 mm</i> Inch version: <i>0.4"</i>

User Tools Item Names		Default
Edit P.2/2 (See p.98 "Edit P. <sup>2</sup> / <sub>2</sub> ".)		
Image Repeat Separation Line		None
Double Copies Separation Line		None
Separation Line in Combine		None
Copy on Designating Paper		Yes
Front Cover Copy in Combine		Combine
Copy on Designating Page in Combine		Combine
Orientation: Booklet, Magazine		Open to Left
Copy Order in Combine		From Left to Right
Stamp (See p.99 "Stamp".)		
Background Numbering	Size	Normal
	Density	Normal
Preset Stamp	Stamp Priority	Copy
	Stamp Language	English
	Stamp Position	Metric version <ul style="list-style-type: none"> <li>• Position: Top Right</li> <li>• Top Margin: 24 mm</li> <li>• Right Margin: 24 mm</li> </ul> Inch version <ul style="list-style-type: none"> <li>• Position: Top Right</li> <li>• Top Margin: 1.0"</li> <li>• Right Margin: 1.0"</li> </ul>
	Stamp Format	Size: 1×
Density: Normal		
Page to Stamp: All Pages		
User Stamp	Program/Delete Stamp	
	Stamp Position: 1-4	Metric version <ul style="list-style-type: none"> <li>• Position: Top Right</li> <li>• Top Margin: 24 mm</li> <li>• Right Margin: 24 mm</li> </ul> Inch version <ul style="list-style-type: none"> <li>• Position: Top Right</li> <li>• Top Margin: 1.0"</li> <li>• Right Margin: 1.0"</li> </ul>
	Stamp Format: 1-4	All Pages

User Tools Item Names		Default
Date Stamp	Format	Metric version: <i>DD/MM/YYYY</i> Inch version: <i>MM/DD/YYYY</i>
	Font	<i>Font 1</i>
	Stamp Position	Metric version <ul style="list-style-type: none"> <li>• Position: <i>Top Left</i></li> <li>• Top Margin: <i>8 mm</i></li> <li>• Left Margin: <i>32 mm</i></li> </ul> Inch version <ul style="list-style-type: none"> <li>• Position: <i>Top Left</i></li> <li>• Top Margin: <i>0.3"</i></li> <li>• Left Margin: <i>0.8"</i></li> </ul>
	Stamp Setting	<i>All Pages</i>
	Size	<i>Auto</i>
	Superimpose	<i>No</i>

User Tools Item Names		Default
Page Numbering	Stamp Format	<i>P1, P2...</i>
	Font	<i>Font 1</i>
	Size	<i>Auto</i>
	Duplex Back Page Stamping Position	<i>Opposite Position</i>
	Page Numbering in Combine	<i>Per Original</i>
	Stamp on Designating Slip Sheet	<i>No</i>
	Stamp Position	Metric version <ul style="list-style-type: none"> <li>• Position P1, 1/5, P.1, 1: <i>Top Right</i> -1-, 1-1: <i>Bottom Center</i></li> <li>• Top/Bottom Margin P1, 1/5, P.1, 1: <i>12 mm</i> -1-, 1-1: <i>8 mm</i></li> <li>• Left/Right Margin P1, 1/5, P.1, 1: <i>12 mm</i> -1-, 1-1: <i>0 mm</i></li> </ul> Inch version <ul style="list-style-type: none"> <li>• Position P1, 1/5, P.1, 1: <i>Top Right</i> -1-, 1-1: <i>Bottom Center</i></li> <li>• Top/Bottom Margin P1, 1/5, P.1, 1: <i>0.5"</i> -1-, 1-1: <i>0.3"</i></li> <li>• Left/Right Margin P1, 1/5, P.1, 1: <i>0.5"</i> -1-, 1-1: <i>0.0"</i></li> </ul>
	Superimpose	<i>No</i>
Page Numbering Initial Letter	<i>P1, P2.../P.1, P.2...</i>	
Input/Output (See p.102 "Input/Output".)		
Switch to Batch	<i>Batch</i>	
SADF Auto Reset	<i>5 seconds</i>	
Rotate Sort: Auto Paper Continue	<i>No</i>	
Auto Sort	<i>No</i>	
Memory Full Auto Scan Restart	<i>No</i>	
Select Stack Function	<i>Stack</i>	
Select Stapling Position	<i>Top 2</i>	
Select Punch Type	<i>3 holes</i>	
Letterhead Setting	<i>No</i>	
Administrator Tools (See p.103 "Administrator Tools")		
Menu Protect	<i>Level 2</i>	

# Accessing User Tools (Copier/Document Server Features)

This section is for key operators in charge of this machine. You can change or set defaults.

## Note

- ❑ Be sure to quit User Tools and return to the initial copy display after all the settings are finished. This section describes system settings that you can set for the copier.
- ❑ The selected key is highlighted.
- ❑ Any changes you make with User Tools remain in effect even if the main power switch or operation switch is turned off, or the **[Clear Modes]** key is pressed.

## Reference

For details, see "User Tools (System Settings)", *General Settings Guide*.

## Changing Default Settings

- 1** Press the **[User Tools/Counter]** key.

The User Tools main menu appears.

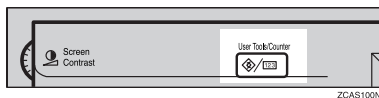

## Note

- ❑ When Basic Authentication, Windows Authentication, LDAP Authentication, or Integration Server Authentication is set, the authentication screen will be displayed. Enter your login name and login password, and then press **[Login]**.

- 2** Press **[Copier/Document Server Features]**.

The Copier/Document Server Features menu appears.

- 3** Select the menu you want to set.

The setting display for each menu will appear.

## Reference

p.85 "User Tools Menu (Copier/Document Server Features)"

- 4** Change settings by following the instructions on the display panel, and then press **[OK]**.

## Exiting User Tools

- 1** After changing User Tools settings, press **[Exit]** on the User Tools main menu.

Changes to User Tools are complete, and the machine is ready to copy.



## Note

- ❑ You can also quit User Tools by pressing the **[User Tools/Counter]** key.

## General Features P.1/4

### ❖ Auto Paper Select Priority

As a default, Auto Paper Select is selected. You can cancel this setting. See p.25 "Selecting Copy Paper".

#### Note

- Default: *Yes*

### ❖ Auto Tray Switching

If you load paper of the same size in two or more trays, the machine automatically shifts to the other tray when the first tray in use runs out of paper (when Auto Paper Select is selected.) This function is called "Auto Tray Switching". This setting specifies whether to use Auto Tray Switching or not.

#### Note

- Default: *With Image Rotation*
- [With image rotation]** Use this to copy with Auto Tray Switching.
- [Without image rotation]** Only copies with Auto Tray Switching if you load paper of the same size and in the same direction in two or more trays. If the paper is not the same size or in the same orientation, copying is interrupted and "Load paper." appears.
- [OFF]** When a paper tray runs out of paper, copying is interrupted and "Load paper." appears.

### ❖ Paper Display

You can choose to have the available paper trays and sizes shown on the initial display.

#### Note

- Default: *Display*
- If you select **[Hide]**, the display is shown as below. Press **[Auto Paper Select]** to display paper sizes.

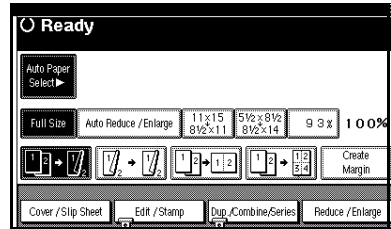

### ❖ Original Type Priority

You can select the type of originals to be effective when the power is turned on, reset or modes are cleared. See p.24 "Selecting Original Type Setting".

#### Note

- Default: *Text*

### ❖ Original Type Display

You can choose to have the original types shown on the initial display.

#### Note

- Default: *Display*
- If you select **[Hide]**, the display is shown as below.

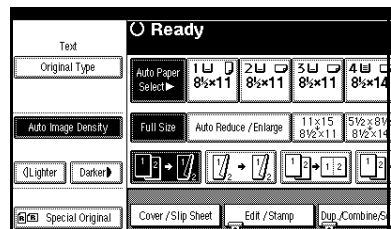

❖ **Auto Image Density Priority**

Set this function to use Auto Image Density when the power is turned on, reset or modes are cleared.

 **Note**

- Default: *Text: On, Text/Photo: On, Photo: Off, Pale: On, Generation Copy: On*

❖ **Copy Quality**

You can adjust the quality level of copies for each of the original types (Text, Text/Photo, Photo, Pale, Generation Copy).

- Text  
Adjust the sharpness of text.

 **Note**

- Default: *Normal*
- [Custom Setting]** is the value set during service setup.
- Choosing **[Sharp]** or **[Soft]** affects the outline sharpness of text.

- Text/Photo  
When there are photo(s) and text on the original, determine whether the photo or text takes priority.

 **Note**

- Default: *Normal*
- [Custom Setting]** is the value set during service setup.
- [Normal]** achieves a good balance between text and photos.

- Photo  
For a photo original, adjust the finish quality level to match the type of photo original.

 **Note**

- Default: *Print Photo*
- [Custom Setting]** is the value set during service setup.

- Select **[Print Photo]** for printed photo originals, and **[Glossy Photo]** for printed photo originals with fine dots.

- Select **[Normal]** for printed photo and text originals.

- Pale  
Adjust the quality level for the finish of a pale original with normal density.

 **Note**

- Default: *Normal*
- [Custom Setting]** is the value set during service setup.

- Generation Copy  
Adjust the quality level so as not to thicken the lines of the finish image.

 **Note**

- Default: *Normal*
- [Custom Setting]** is the value set during service setup.

❖ **Image Density**

You can select one of seven original image density levels for each of the original types (Text, Text/Photo, Photo, Pale, Generation Copy).

 **Note**

- Default: *Text: Normal, Text/Photo: Normal, Photo: Normal, Pale: Normal, Generation Copy: Normal*

## General Features P.<sup>2</sup>/<sub>4</sub>

### ❖ Duplex Mode Priority

You can select the type of Duplex function effective when the machine is turned on, reset, or modes are cleared.

#### Note

- Default: *Text: Normal, Text/Photo: Normal, Photo: Normal, Pale: Normal, Generation Copy: Normal*

### ❖ Copy Orientation in Duplex Mode

You can set the copy orientation when making two-sided copies.

#### Note

- Default: *Top to Top*

### ❖ Original Orientation in Duplex Mode

You can set the original orientation when making two-sided copies.

#### Note

- Default: *Top to Top*

### ❖ Change Initial Mode

You can select initial mode or Program No.10 as the mode effective when the machine is turned on, reset, or modes are cleared.

#### Note

- Default: *Standard*

### ❖ Max. Copy Quantity

The maximum copy quantity can be set between 1 and 999.

#### Note

- Default: *999 Sheets.*

### ❖ Tone: Original remains

The beeper (key tone) sounds if you forget to remove originals after copying.

#### Note

- Default: *On*
- If Panel Tone of User Tools (System Settings) is **[Off]**, the beeper does not sound irrespective of the Tone: Original remains setting. See "Panel Tone" in "General Features", *General Settings Guide*.

### ❖ Job End Call

You can choose whether or not the beeper sounds when copying is complete.

#### Note

- Default: *On*
- If Panel Tone of User Tools (System Settings) settings is **[On]**, the machine beeps to notify you that it did not complete a job for reasons such as copying was interrupted, the paper tray ran out of paper, or a paper jam occurred.

## General Features P.<sup>3</sup>/<sub>4</sub>

### ❖ Copy Function Key: F1-F5

You can assign frequently used functions to function keys F1 to F5.

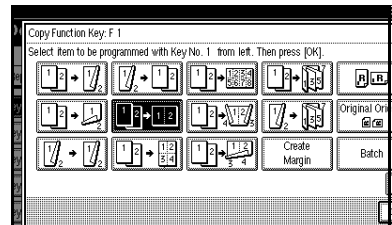



**Note**

- Default:
  - Copy Function Key: F1: 1 Sided → 2 Sided: T to T
  - Copy Function Key: F2: 2 Sided: T to T → 2 Sided: T to T
  - Copy Function Key: F3: 1 Sided → 1 Sided Combine
  - Copy Function Key: F4: 1 Sided → 1 Sided Combine: 4 originals
  - Copy Function Key: F5: Create Margin

## General Features P.4/4

- ❖ **Document Server Storage Key: F1–F5**  
 You can assign frequently used functions to function keys F1 to F5. You can also change the assigned functions.

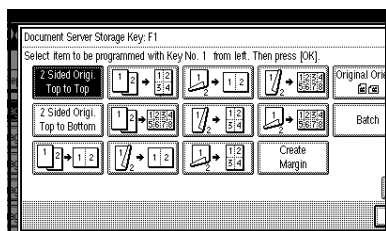

**Note**

- Default:
  - Document Server Storage Key: F1: 2 Sided Original Top to Top
  - Document Server Storage Key: F2: 1 Sided → 1 Sided Combine
  - Document Server Storage Key: F3: 1 Sided → 1 Sided Combine: 4 originals
  - Document Server Storage Key: F4: 1 Sided → 1 Sided Combine: 8 originals
  - Document Server Storage Key: F5: Create Margin

## Reproduction Ratio P.1/2

- ❖ **Shortcut R/E**

You can register up to three frequently used Reduce/Enlarge ratios other than the fixed Reduce/Enlarge ratio and have them shown on the initial display. You can also change registered Reduce/Enlarge ratios.

If no Reduce/Enlarge ratio has been set when selecting [**Shortcut R/E 1**], [**Shortcut R/E 2**], or [**Shortcut R/E 3**], enter the desired Reduce/Enlarge ratio using the number keys.

- ❖ **Enlarge 1-5**

You can customize available enlargement ratios by pressing [**Reduce/Enlarge**] followed by [**Enlarge**].

115%	129%	155%	200%	400%
8 1/2 x 11	5 1/2 x 8 1/2	5 1/2 x 8 1/2	5 1/2 x 8 1/2	
11 x 17	8 1/2 x 14	11 x 17		
Enlarge1	Enlarge2	Enlarge3	Enlarge4	Enlarge5

**Note**

- Default:
  - Metric version:
    - Enlarge 1: 115%
    - Enlarge 2: 122%
    - Enlarge 3: 141%
    - Enlarge 4: 200%
    - Enlarge 5: 400%
  - Inch version:
    - Enlarge 1: 121%
    - Enlarge 2: 129%
    - Enlarge 3: 155%
    - Enlarge 4: 200%
    - Enlarge 5: 400%
- When selecting [**User Enlrg. Ratio**], enter a ratio using the number keys (from 101 to 400%).

❖ **Priority Setting: Enlarge**

You can set the ratio with priority when **[Reduce/Enlarge]** is pressed, followed by **[Enlarge]**.

 **Note**

- Default:
  - Metric version: 141%
  - Inch version: 155%

❖ **Priority Setting: Reduce**

You can set the ratio with priority when **[Reduce/Enlarge]** is pressed, followed by **[Reduce]**.

 **Note**

- Default:
  - Metric version: 71%
  - Inch version: 73%

---

## Reproduction Ratio P.<sup>2</sup>/<sub>2</sub>

---

❖ **Reduce 1-6**

You can customize available reduction ratios by pressing **[Reduce/Enlarge]** followed by **[Reduce]**.

<b>25%</b> 11x17	<b>50%</b> 5 1/2 x 8 1/2	<b>65%</b> 11x17	<b>75%</b> 11x15	<b>78%</b> 8 1/2 x 14	<b>85%</b> F
Reduce1	Reduce2	Reduce3	Reduce4	Reduce5	Reduce6

 **Note**

- Default:
  - Metric version:
    - Reduce 1: 25%
    - Reduce 2: 50%
    - Reduce 3: 65%
    - Reduce 4: 71%
    - Reduce 5: 75%
    - Reduce 6: 82%
  - Inch version:
    - Reduce 1: 25%
    - Reduce 2: 50%
    - Reduce 3: 65%
    - Reduce 4: 73%
    - Reduce 5: 78%
    - Reduce 6: 85%
- When selecting **[User Redc.Ratio]**, enter a ratio using the number keys (from 25 to 99%).

❖ **Ratio for Create Margin**

You can set a Reduce/Enlarge ratio when registering Create Margin in a shortcut key.

 **Note**

- Default: 93%

❖ **R/E Priority**

Specifies which tab is given priority on the display panel when **[Reduce/Enlarge]** is pressed.

 **Note**

- Default: *Reduce*

---

## Edit P.<sup>1</sup>/<sub>2</sub>

---

 **Note**

- Enter the width of the binding margin with the number keys as follows:
  - Metric version: 0–30 mm (in increments of 1 mm)
  - Inch version: 0"–1.2" (in increments of 0.1 inch)
- Enter the width of the erased margin with the number keys as follows:
  - Metric version: 2–99 mm (in increments of 1 mm)
  - Inch version: 0.1"–3.9" (in increments of 0.1 inch)

❖ **Front Margin: Left/Right**

You can specify left and right margins on the front side of copies in Margin Adjustment mode.

🔧 **Note**

- Default:
  - Metric version: *Left 5 mm*
  - Inch version: *Left 0.2"*

❖ **Back Margin: Left/Right**

You can specify left and right margins on the back side of copies in Margin Adjustment mode.

🔧 **Note**

- Default:
  - Metric version: *Right 5 mm*
  - Inch version: *Right 0.2"*

❖ **Front Margin: Top/Bottom**

You can specify top and bottom margins on the front side of copies in Margin Adjustment mode.

🔧 **Note**

- Default:
  - Metric version: *Top/Bottom 0 mm*
  - Inch version: *Top/Bottom 0.0"*

❖ **Back Margin: Top/Bottom**

You can specify top and bottom margins on the back side of copies in Margin Adjustment mode.

🔧 **Note**

- Default:
  - Metric version: *Top/Bottom 0 mm*
  - Inch version: *Top/Bottom 0.0"*

❖ **1 Sided→2 Sided Auto Margin: TtoT**

In 1 sided → 2 sided Duplex mode, you can specify the margins on the back side. The margin is set to the same value of "Back Margin: Left/Right".

🔧 **Note**

- Default:
  - Metric version: *Right 5 mm*
  - Inch version: *Right 0.2"*

❖ **1 Sided→2 Sided Auto Margin: TtoB**

In 1 sided → 2 sided Duplex mode, you can specify the margins on the back side. The value set for "Back Margin: Top/Bottom" is used.

🔧 **Note**

- Default:
  - Metric version: *Top/Bottom 0 mm*
  - Inch version: *Top/Bottom 0.0"*

❖ **Erase Border Width**

You can specify the width of the erased border margins with this function.

🔧 **Note**

- Default:
  - Metric version: *10 mm*
  - Inch version: *0.4"*

❖ **Erase Original Shadow in Combine**

In Combine mode, you can specify whether to erase a 3 mm, 0.1" boundary margin around all four edges of each original.

🔧 **Note**

- Default: *Yes*

❖ **Erase Center Width**

You can specify the width of the erased center margins with this function.

🔧 **Note**

- Default:
  - Metric version: *10 mm*
  - Inch version: *0.4"*

## Edit P.<sup>2</sup>/<sub>2</sub>

### Note

- The image area of approximately 1.5 mm (0.06") wide on the separation line may not be copied, when specifying solid or broken lines.

### ❖ Image Repeat Separation Line

You can select a separation line in Image Repeat mode from None, Solid, Broken A, Broken B, or Crop Marks.

- None



- Solid



- Broken A



- Broken B



- Crop Marks



### Note

- Default: *None*

### ❖ Double Copies Separation Line

You can select a separation line in Double Copies mode from None, Solid, Broken A, Broken B, or Crop Marks.

- None



- Solid



- Broken A



- Broken B



- Crop Marks



### Note

- Default: *None*

### ❖ Separation Line in Combine

You can select a separation line in Combine mode from None, Solid, Broken A, Broken B, or Crop Marks. See p.48 "One-Sided Combine" and p.49 "Two-Sided Combine".

- None



- Solid



- Broken A



- Broken B



- Crop Marks



**Note**

Default: *None*

❖ **Copy on Designating Paper**

You can specify whether to copy on the designating paper.

**Note**

Default: *Yes*

❖ **Front Cover Copy in Combine**

You can make a combined copy on the front cover sheet when you select Front Cover mode.

Combine				Not Combined			
1	2	5	6	1	2	3	6
3	4	7	8	4	5	8	7

GCST019E

**Note**

Default: *Combine*

❖ **Copy on Designating Page in Combine**

You can specify whether to make a combined copy on the inserted slip sheets in Desig./Chapter mode.

**Note**

Default: *Combine*

❖ **Orientation: Booklet, Magazine**

You can select the orientation of copies to open when using Booklet or Magazine mode.

**Note**

Default: *Open to Left*

**Reference**

p.53 "How to fold and unfold copies to make a booklet"

p.54 "How to fold and unfold copies to make a magazine"

❖ **Copy Order in Combine**

You can set the copy order in Combine mode to Left to Right or Top to Bottom.

From Left to Right	From Top to Bottom																
<table border="1"> <tr><td>1</td><td>2</td></tr> <tr><td>3</td><td>4</td></tr> </table>	1	2	3	4	<table border="1"> <tr><td>1</td><td>3</td></tr> <tr><td>2</td><td>4</td></tr> </table>	1	3	2	4								
1	2																
3	4																
1	3																
2	4																
<table border="1"> <tr><td>1</td><td>2</td><td>3</td><td>4</td></tr> <tr><td>5</td><td>6</td><td>7</td><td>8</td></tr> </table>	1	2	3	4	5	6	7	8	<table border="1"> <tr><td>1</td><td>3</td><td>5</td><td>7</td></tr> <tr><td>2</td><td>4</td><td>6</td><td>8</td></tr> </table>	1	3	5	7	2	4	6	8
1	2	3	4														
5	6	7	8														
1	3	5	7														
2	4	6	8														

GCAH090E

**Note**

Default: *From Left to Right*

**Stamp**

**Background Numbering**

❖ **Size**

You can set the size of the numbers.

**Note**

Default: *Normal*

❖ **Density**

You can set the density of the numbers.

**Note**

Default: *Normal*

**Preset Stamp P.1/4-4/4**

❖ **Stamp Priority**

You can select the stamp type given priority when [Preset Stamp] is pressed. See p.61 "Preset Stamp".

**Note**

Default: *Copy*

❖ **Stamp Language**

You can select the language of the message printed in Stamp mode.

 **Note**

Default: *English*

❖ **Stamp Position**

You can set the position at which the stamp is printed.

Press the arrow keys to adjust the position.

 **Note**

Default:

- Metric Version:
  - Position: *Top right*
  - Top Margin: *24 mm*
  - Right Margin: *24 mm*
- Inch Version:
  - Position: *Top right*
  - Top Margin: *1.0"*
  - Right Margin: *1.0"*

❖ **Stamp Format**

You can adjust the size, density, and print page for the stamp.

- Size  
You can set the size of the stamp.

 **Note**

Default: *1X*

- Density  
You can set the pattern used to print the stamp.

 **Note**

Default: *Normal*

Normal: The stamp is printed on the image. You cannot check which parts will overlap.

Lighter : The image can be seen through the stamp.

Lightest : You can see the image even clearer than in the Lighter setting.

- Page to Stamp  
You can have the stamp printed on the first page or all pages.

 **Note**

Default: *All Pages*

---

**User Stamp P. 1/2-2/2**

---

❖ **Program/Delete Stamp**

You can register, change, or delete these designs as user stamps.

 **Note**

You can register up to four custom stamps with your favorite designs. See p.63 "To program the user stamp".

 **Reference**

For how to delete the user stamp, see p.64 "To delete the user stamp".

❖ **Stamp Position 1 - 4**

You can set the position at which the stamp is printed.

Press the arrow keys to adjust the position.

 **Note**

Default:

- Metric version:
  - Position: *Top Right*
  - Top Margin: *24 mm*
  - Right Margin: *24 mm*
- Inch version:
  - Position: *Top Right*
  - Top Margin: *1.0"*
  - Right Margin: *1.0"*

❖ **Stamp Format 1 - 4**

You can adjust the print page for User Stamps 1 to 4 already registered.

- Page to Stamp  
Sets whether to print the stamp on all pages or only on the first page.

 **Note**

- Default: *All Pages*

---

**Date Stamp**

---

❖ **Format**

You can select the date format for Date Stamp mode.

 **Note**

- Default:
  - Metric version: *DD/MM/YYYY*
  - Inch version: *MM/DD/YYYY*

❖ **Font**

You can select the Date Stamp font.

 **Note**

- Default: *Font 1*
- This setting is linked with Page Numbering.

❖ **Stamp Position**

You can set the position at which the stamp is printed.  
Press the arrow keys to adjust the position.

 **Note**

- Default:
  - Metric version:
    - Position: *Top Left*
    - Top Margin: *8 mm*
    - Left Margin: *32 mm*
  - Inch version:
    - Position: *Top Left*
    - Top Margin: *0.3"*
    - Left Margin: *0.8"*

❖ **Stamp Setting**

You can have the date printed on the first page or all pages.

 **Note**

- Default: *All Pages*

❖ **Size**

You can set the Date Stamp size.

 **Note**

- Default: *Auto*

❖ **Superimpose**

You can have the Date Stamp printed in white when it overlaps black parts of the image.

 **Note**

- Default: *No*

---

**Page Numbering P.<sup>1</sup>/<sub>2</sub>-<sup>2</sup>/<sub>2</sub>**

---

❖ **Stamp Format**

You can select the page number format given priority when [**Page Numbering**] is pressed.

 **Note**

- Default: *P1, P2*

❖ **Font**

You can select the page number printed in Page Numbering mode.

 **Note**

- Default: *Font 1*

❖ **Size**

You can set the size of the stamp printed in Page Numbering mode.

 **Note**

- Default: *Auto*

❖ **Duplex Back Page Stamping Position**

You can set the position of the duplex back page number printed in Duplex mode.

 **Note** Default: *Opposite Position***❖ Page Numbering in Combine**

You can set page numbering when using the Combine function and the Page Numbering function together.

 **Note** Default: *Per original***❖ Stamp on Designating Slip Sheet**

You can select to print the page number onto slip sheets when using the Designate function set to **[Copy]** and the Page Numbering function together.

 **Note** Default: *No***❖ Stamp Position**

P1, P2... Stamp Position: 1/5, 2/5...  
Stamp Position: -1-, -2-... Stamp Position: P.1, P.2...  
Stamp Position: 1, 2... Stamp Position: 1-1, 1-2...  
You can set the position at which the stamp is printed.

Press the arrow keys to adjust the position.

**❖ Superimpose**

You can have page numbers printed in white when they overlap black parts of the image.

 **Note** Default: *No***❖ Page Numbering Initial Letter**

You can select the page numbering initial letter between "P.1, P.2.../P.1, P.2..." and "S1, S2.../S.1, S.2...".

 **Note** Default: *P.1, P.2.../P.1, P.2...*

---

## Input/Output

---

**❖ Switch to Batch (SADF)**

You can select to have Batch mode or SADF mode displayed when you press the **[Special Original]** key. See p.14 "Batch mode".

 **Note** Default: *Batch***❖ SADF Auto Reset**

In SADF mode, an original must be set within a specified time after the previous original has been fed. You can adjust this time from 3 to 99 seconds in increments of 1 second.

 **Note** Default: *5 seconds***❖ Rotate Sort: Auto Paper Continue**

You can specify to continue copying when paper of the required orientation has run out during rotate-sorting. See p.33 "Rotate Sort".

 **Note** If you select **[No]** :

- When paper of the required orientation runs out, the machine stops copying and prompts you to supply copy paper. After you have loaded paper, the machine will continue copying.

 If you select **[Yes]** :

- Copying continues using copy paper of a different orientation. The copy job will finish even if you have left the machine.

 Default: *No*



❖ **Auto Sort**

You can specify whether Sort mode is selected when the machine is turned on or the mode is cleared.

 **Note**

- Default: *No*

❖ **Memory Full Auto Scan Restart**

When memory becomes full while scanning originals, the machine can make copies of scanned originals first, and then automatically proceed scanning remaining originals.

You can enable or disable this function.

 **Note**

- If you select **[No]** :
  - When memory becomes full, the machine stops operation allowing you to remove the copy pages delivered on the output tray.
- If you select **[Yes]** :
  - You can leave the machine unattended to make copies, but sorted pages will not be sequential.
- Default: *No*

❖ **Select Stack Function**

Specify whether Stack or Rotate Sort has priority to be shown on the initial display.

 **Note**

- Default: *Stack*
- An optional finisher is required to use this function.

❖ **Select Stapling Position**

Specify which Top 2 staples or Bottom shown on the initial display with priority.

 **Note**

- Default: *Top 2*
- The optional 2 Tray finisher or booklet finisher is required to use this function.

❖ **Select Punch Type**

Specify which punch type (2 holes or 3 holes) has priority to be shown on the initial display.

 **Note**

- Default: *3 holes*
- The optional 2 Tray finisher equipped with the punch function is required.

❖ **Letterhead Setting**

If you select **[Yes]** in this function, the machine rotates the image correctly.

 **Note**

- Default: *No*
- Orientation-fixed (top to bottom) or two-sided paper might not be printed correctly depending on how the originals and paper are placed.

 **Reference**

When using letterhead paper, be careful of the paper orientation. See "Orientation-Fixed Paper or Two-Sided Paper" in "Loading Paper", *General Settings Guide*.

---

## Administrator Tools

---

❖ **Menu Protect**

You can prevent unauthenticated users from changing User Tools settings. For details, consult the administrator.



# 5. Specifications

## Combination Chart

The combination chart given below shows which modes can be used together. When you read the chart, see the following table:

○	These modes can be used together.
●	These modes cannot be used together. The second mode selected will be the mode you are working in.
×	These modes cannot be used together. The first mode selected will be the mode you are working in.

The following shows the combinations of functions.

Function selected first	Function selected after																																			
	Mixed Sizes	Custom Size Originals	Original Orientation(Standard Orientation)	Auto Image Density	Manual Image Density	Auto Paper Select	Manual Paper Select	Copying from the Bypass Tray	Auto Reduce/Enlarge	Reduce/Enlarge	Create Margin Mode	Book	1 Sided → 2 Sided / 2 Sided → 2 Sided / 2 Sided → 1 Sided	Combine	Book → 2 Sided / Front & Back → 2 Sided	Booklet	Magazine	Double Copies	Image Repeat	Margin Adjustment	Positive/Negative	Centering	Center Erase	Border Erase	Background Numbering	Preset Stamp	Page Numbering	Cover / Designate	Slip Sheet	Sort	Stack	Staple	Punch	Store File		
Mixed Sizes	○	×																																		
Custom Size Originals	×	○																																		
Original Orientation(Standard Orientation)			○																																	
Auto Image Density				○																																
Manual Image Density					○																															
Auto Paper Select						○																														
Manual Paper Select							○																													
Copying from the Bypass Tray								○																												
Auto Reduce/Enlarge									○																											
Reduce/Enlarge										○																										
Create Margin Mode											○																									
Book												○																								
1 Sided → 2 Sided / 2 Sided → 2 Sided / 2 Sided → 1 Sided													○																							
Combine														○																						
Book → 2 Sided / Front & Back → 2 Sided															○																					
Booklet																○																				
Magazine																	○																			
Double Copies																		○																		
Image Repeat																			○																	
Margin Adjustment																				○																
Positive/Negative																					○															
Centering																						○														
Center Erase																							○													
Border Erase																								○												
Background Numbering																									○											
Preset Stamp																										○										
Page Numbering																											○									
Cover / Designate																												○								
Slip Sheet																													○							
Sort																														○						
Stack																															○					
Staple																																○				
Punch																																	○			
Store File																																		○		

- \*1 You cannot combine if you select 2 sided to copy.
- \*2 You cannot combine with Rotate Sort.
- \*3 You cannot combine Cover with 2 Sided → 1 Sided.
- \*4 You cannot combine Designate with Magazine.
- \*5 You cannot combine Staple Top 2 with Standard Punch position.  
You cannot combine Staple Top , Top Slant, and Bottom with 90° turn Punch position.
- \*6 Available with the optional 2 Tray Finisher.

# Supplementary Informations

## ❖ Mixed Size mode

- Since small originals may not be correctly aligned with the original guide, the copy image may be slanted.
- Copying speed and scanning speed will be reduced.
- You can place originals of two different sizes at a time.

## ❖ Bypass Tray Copy

- The following paper sizes can be selected as the standard sizes: A3☐, A4☐☐, A5☐☐☐, A6☐, B4 JIS☐, B5 JIS☐☐, B6 JIS☐, Postcard☐, 11"×17"☐, 8<sup>1</sup>/<sub>2</sub>"×14"☐, 8<sup>1</sup>/<sub>2</sub>"×11"☐☐, 5<sup>1</sup>/<sub>2</sub>"×8<sup>1</sup>/<sub>2</sub>"☐, 7<sup>1</sup>/<sub>4</sub>"×10<sup>1</sup>/<sub>2</sub>"☐☐, 8"×13"☐, 8<sup>1</sup>/<sub>2</sub>"×13"☐, 8<sup>1</sup>/<sub>4</sub>"×13"☐, 11"×14"☐, 11"×15"☐, 10"×14"☐, 10"×15"☐, 8<sup>1</sup>/<sub>4</sub>"×14"☐, 8"×10<sup>1</sup>/<sub>2</sub>"☐☐, 8"×10"☐☐
- When the beeper is turned off, it will not sound if you insert paper into the bypass tray. See *General Settings Guide*.

## ❖ Preset Enlarge/Reduce

- You can select one of 12 preset ratios (5 enlargement ratios, 7 reduction ratios).
- You can select a ratio regardless of the size of an original or copy paper. With some ratios, parts of the image might not be copied or margins will appear on copies.
- Copies can be reduced or enlarged as follows:

### ❖ Metric version

Ratio (%)	Original → Copy paper size
400 (enlarge area by 16)	--
200 (enlarge area by 4)	A5→A3
141 (enlarge area by 2)	A4→A3, A5→A4
122	F→A3, A4→B4 JIS
115	B4 JIS→A3
93	--
82	F→A4, B4 JIS→A4
75	B4 JIS→F4, B4 JIS→F
71 (reduce area by 1/2)	A3→A4, A4→A5
65	A3→F
50 (reduce area by 1/4)	A3→A5, F→A5
25	--

❖ **Inch version**

Ratio (%)	Original → Copy paper size
400 (enlarge area by 16)	--
200 (enlarge area by 4)	$5\frac{1}{2}'' \times 8\frac{1}{2}'' \rightarrow 11'' \times 17''$
155 (enlarge area by 2)	$5\frac{1}{2}'' \times 8\frac{1}{2}'' \rightarrow 8\frac{1}{2}'' \times 14''$
129	$8\frac{1}{2}'' \times 11'' \rightarrow 11'' \times 17''$
121	$8\frac{1}{2}'' \times 14'' \rightarrow 11'' \times 17''$
93	--
85	F → $8\frac{1}{2}'' \times 11''$
78	$8\frac{1}{2}'' \times 14'' \rightarrow 8\frac{1}{2}'' \times 11''$
73	$11'' \times 15'' \rightarrow 8\frac{1}{2}'' \times 11''$
65	$11'' \times 17'' \rightarrow 8\frac{1}{2}'' \times 11''$
50 (reduce area by $\frac{1}{4}$ )	$11'' \times 17'' \rightarrow 5\frac{1}{2}'' \times 8\frac{1}{2}''$
25	--

❖ **Zoom**

- The reproduction ratios you can specify are 25–400%.
- You can select a ratio regardless of the size of an original or copy paper. With some ratios, parts of the image might not be copied or margins will appear on copies.

❖ **Size Magnification**

- If the calculated ratio is over the maximum or under the minimum ratio, it is automatically adjusted to within available range. However, with some ratios, parts of the image might not be copied or margins will appear on copies.
- The reproduction ratios you can specify are 25–400%.

❖ **Directional Size Magnification**

- The reproduction ratio you can specify are 25–400%.
- When entering a percentage ratio, you can specify any value in the permitted range, regardless of original or copy paper size. However, depending on settings and other conditions, part of the image may not be copied, or margins will appear on copies.
- When entering a size in mm, if the calculated ratio is over the maximum or under the minimum ratio, it is automatically adjusted to within available range. However, with some ratios, parts of the image might not be copied or margins will appear on copies.

❖ **Sort, Rotate Sort, Stack**

















































- Paper sizes and orientations that can be used in the Shift Sort and Stack functions are as follows:

	1000-Sheet finisher	2 Tray finisher	Booklet finisher
Paper size and orientation	A3☐, B4 JIS☐, A4☐☐, B5 JIS☐☐, A5☐☐, 5 <sup>1</sup> / <sub>2</sub> " × 8 <sup>1</sup> / <sub>2</sub> "☐☐, 11" × 17"☐, 8 <sup>1</sup> / <sub>2</sub> " × 14"☐, 8 <sup>1</sup> / <sub>4</sub> " × 13"☐, 8" × 13"☐, 8 <sup>1</sup> / <sub>2</sub> " × 11"☐☐, 7 <sup>1</sup> / <sub>4</sub> " × 10 <sup>1</sup> / <sub>2</sub> "☐☐	A3☐, B4 JIS☐, A4☐☐, B5 JIS☐☐, A5☐☐, 11" × 17"☐, 8 <sup>1</sup> / <sub>2</sub> " × 14"☐, 8 <sup>1</sup> / <sub>2</sub> " × 11"☐☐, 5 <sup>1</sup> / <sub>2</sub> " × 8 <sup>1</sup> / <sub>2</sub> "☐☐	A3☐, B4 JIS☐, A4☐☐, B5 JIS☐☐, 11" × 17"☐, 8 <sup>1</sup> / <sub>2</sub> " × 14"☐, 8 <sup>1</sup> / <sub>2</sub> " × 11"☐☐

- Paper sizes and orientations that can be used in the Rotate Sort function are A4☐☐, B5 JIS☐☐ and 8<sup>1</sup>/<sub>2</sub>" × 11"☐☐.
- The number of copies that can be placed on the tray is as follows. When the number of copies exceeds capacity, remove copies from the tray.

5

	Paper size and orientation	Paper capacity and weight
Internal tray	<ul style="list-style-type: none"> <li>• A4☐ or smaller</li> <li>• 8<sup>1</sup>/<sub>2</sub>" × 11"☐ or smaller</li> </ul>	500 sheets *1 (80 g/m <sup>2</sup> ) (20 lb.)
	<ul style="list-style-type: none"> <li>• B4 JIS☐ or larger</li> <li>• 8<sup>1</sup>/<sub>2</sub>" × 14"☐ or larger</li> </ul>	250 sheets *2 (80 g/m <sup>2</sup> ) (20 lb.)
Internal tray 2 (1 bin tray)	A3☐, B4 JIS☐, A4☐☐, B5 JIS☐☐, A5☐☐, B6 JIS☐☐, A6☐, 11" × 17"☐, 8 <sup>1</sup> / <sub>2</sub> " × 14"☐, 8 <sup>1</sup> / <sub>2</sub> " × 11"☐☐, 7 <sup>1</sup> / <sub>4</sub> " × 10 <sup>1</sup> / <sub>2</sub> "☐☐, 5 <sup>1</sup> / <sub>2</sub> " × 8 <sup>1</sup> / <sub>2</sub> "☐☐, 8" × 13"☐, 8 <sup>1</sup> / <sub>2</sub> " × 13"☐, 8 <sup>1</sup> / <sub>4</sub> " × 13"☐	125 sheets (80 g/m <sup>2</sup> ) (20 lb.)
1000-Sheet finisher	Finisher upper tray	
	<ul style="list-style-type: none"> <li>• A4 or smaller</li> <li>• 8<sup>1</sup>/<sub>2</sub>" × 11" or smaller</li> </ul>	250 sheets (80 g/m <sup>2</sup> ) (20 lb.)
	<ul style="list-style-type: none"> <li>• B4 JIS☐ or larger</li> <li>• 8<sup>1</sup>/<sub>2</sub>" × 14"☐ or larger</li> </ul>	50 sheets (80 g/m <sup>2</sup> ) (20 lb.)
	Finisher shift tray	
	<ul style="list-style-type: none"> <li>• A4 or smaller</li> <li>• 8<sup>1</sup>/<sub>2</sub>" × 11" or smaller</li> </ul>	1000 sheets (80 g/m <sup>2</sup> ) (20 lb.)
	<ul style="list-style-type: none"> <li>• B4 JIS☐ or larger</li> <li>• 8<sup>1</sup>/<sub>2</sub>" × 14"☐ or larger</li> </ul>	500 sheets (80 g/m <sup>2</sup> ) (20 lb.)

	Paper size and orientation	Paper capacity and weight
2 Tray finisher	Finisher shift tray 1	
	A4  , 8 1/2" × 11"  , A5  , B5 JIS 	500 sheets (80 g/m <sup>2</sup> ) (20 lb.)
	A3  , B4 JIS  , 11" × 17"  , 8 1/2" × 14" 	250 sheets (80 g/m <sup>2</sup> ) (20 lb.)
	A5  , 5 1/2" × 8 1/2" 	100 sheets (80 g/m <sup>2</sup> ) (20 lb.)
	Finisher shift tray 2	
	A4  , 8 1/2" × 11" 	2000 sheets <sup>*3</sup> (80 g/m <sup>2</sup> ) (20 lb.)
	A3  , B4 JIS  , A4  , B5 JIS  , A5  , 11" × 17"  , 8 1/2" × 14"  , 8 1/2" × 11" 	750 sheets (80 g/m <sup>2</sup> ) (20 lb.)
	A5 	500 sheets (80 g/m <sup>2</sup> ) (20 lb.)
	A5  , 5 1/2" × 8 1/2" 	100 sheets (80 g/m <sup>2</sup> ) (20 lb.)
	Booklet finisher	Finisher upper tray
A3  , B4 JIS  , A4  , B5 JIS  , A5  , B6 JIS  , A6  , 11" × 17"  , 11" × 15"  , 8 1/2" × 14"  , 8 1/2" × 11"  , 5 1/2" × 8 1/2" 		150 sheets (80 g/m <sup>2</sup> ) (20 lb.)
Finisher shift tray		
A4  , B5 JIS  , A5  , 8 1/2" × 11" 		1000 sheets (80 g/m <sup>2</sup> ) (20 lb.)
A3  , B4 JIS  , A4  , 11" × 17"  , 8 1/2" × 11" 		500 sheets (80 g/m <sup>2</sup> ) (20 lb.)
Finisher booklet tray		
A3  , B4 JIS  , A4  , 11" × 17"  , 8 1/2" × 11" 		(80 g/m <sup>2</sup> ) (20 lb.) <ul style="list-style-type: none"> <li>• 2–5 sheets: 25 sets</li> <li>• 6–10 sheets: 15 sets</li> <li>• 11–15 sheets: 10 sets</li> </ul>

\*1 250 sheets when the optional bridge unit is installed.

\*2 125 sheets when the optional bridge unit is installed.

\*3 1,500 sheets when stapled.

#### Note







































- When using the Rotate Sort or Staple functions, the capacity may be reduced.

❖ **Staple**

- The following type of paper cannot be stapled:
  - Translucent paper
  - OHP transparencies
  - Label paper (adhesive labels)
  - Thick paper
  - Curled paper
  - Paper of low stiffness
  - Paper of mixed sizes
- In the following cases, copies will be delivered to the shift tray without stapling:
  - When the number of sheets for one set is over stapler capacity.
  - When memory reaches 0% during copying.
- When using Double Copies, or **[1 Sided→1 Sided]**, **[1 Sided→2 Sided]**, **[2 Sided→1 Sided]**, or **[2 Sided→2 Sided]** in Combine mode, select  paper for  original and  paper for  original.
- When using Double Copies, or **[1 Sided 2 Pages→ 1 Sided Combine]** and **[1 Sided 4 Pages→ 2 Sided Combine]** in Combine mode, select  paper for  original and  paper for  original.
- When using **[Left 2]** or **[Top 2]** with Double Copies, or **[1 Sided→1 Sided]**, **[1 Sided→2 Sided]**, **[2 Sided→1 Sided]**, or **[2 Sided→2 Sided]** in Combine mode, select  paper for  original and  paper for  original.
- When the booklet finisher is installed, even if you place different size originals in the ADF, appropriate size of copy paper can be automatically selected and stapled using the Mixed Size mode and Auto Paper Select function. Load the paper you want to use in the paper trays beforehand. Paper sizes that can be stapled when using the Mixed Size mode are as follows:
  - A3 and A4
  - B4 JIS and B5 JIS
  - 11" × 17" and 8<sup>1</sup>/<sub>2</sub>" × 11"



- Paper sizes and orientation that can be used in the Staple function and the stapler capacity are as follows:

	Paper size	Stapler capacity
1000-Sheet finisher	A4  , B5 JIS  , 8 <sup>1</sup> / <sub>2</sub> " × 11"  , 7 <sup>1</sup> / <sub>4</sub> " × 10 <sup>1</sup> / <sub>2</sub> " 	50 sheets (80 g/m <sup>2</sup> ) (20 lb.)
	A3  , B4 JIS  , 12" × 18"  , 11" × 17"  , 8 <sup>1</sup> / <sub>2</sub> " × 14"  , 8 <sup>1</sup> / <sub>2</sub> " × 13"  , 8 <sup>1</sup> / <sub>4</sub> " × 13"  , 8" × 13" 	30 sheets ) (80 g/m <sup>2</sup> ) (20 lb.)
2 Tray finisher	A4  , B5 JIS  , 8 <sup>1</sup> / <sub>2</sub> " × 11"  , 7 <sup>1</sup> / <sub>4</sub> " × 10 <sup>1</sup> / <sub>2</sub> " 	50 sheets (80 g/m <sup>2</sup> ) (20 lb.)
	A3  , B4 JIS  , 11" × 17"  , 8 <sup>1</sup> / <sub>2</sub> " × 14"  , 8 <sup>1</sup> / <sub>2</sub> " × 13"  , 8 <sup>1</sup> / <sub>4</sub> " × 13"  , 8" × 13" 	30 sheets (80 g/m <sup>2</sup> ) (20 lb.)
Booklet finisher	A4  , B5 JIS  , 8 <sup>1</sup> / <sub>2</sub> " × 11"  , 7 <sup>1</sup> / <sub>4</sub> " × 10 <sup>1</sup> / <sub>2</sub> " 	50 sheets (80 g/m <sup>2</sup> ) (20 lb.)
	A3  , B4 JIS  , A4  , 11" × 17"  , 8 <sup>1</sup> / <sub>2</sub> " × 14"  , 8 <sup>1</sup> / <sub>2</sub> " × 13"  , 8 <sup>1</sup> / <sub>2</sub> " × 11" 	30 sheets (80 g/m <sup>2</sup> ) (20 lb.)
	When Saddle Stitch function is selected: A3  , B4 JIS  , A4  , 11" × 17"  , 8 <sup>1</sup> / <sub>2</sub> " × 11" 	15 sheets (80 g/m <sup>2</sup> ) (20 lb.)

 **Note**

- When the number of copies exceeds tray capacity, copying stops. If this happens, remove the copies from the shift tray, and then resume copying.

- The tray capacity for the stapled sheets is as follows: (paper weight: 80 g/m<sup>2</sup>, 20 lb.)

	Paper size and orientation	Tray capacity
1000-Sheet finisher	A4 ☐, 8 <sup>1</sup> / <sub>2</sub> " × 11" ☐	<ul style="list-style-type: none"> <li>• 10–50 sheets: 100–20 sets</li> <li>• 2–9 sheets: 100 sets</li> </ul>
	A4 ☐, B5 JIS ☐ ☐, 8 <sup>1</sup> / <sub>2</sub> " × 11" ☐ ☐	<ul style="list-style-type: none"> <li>• 10–50 sheets: 50–10 sets</li> <li>• 2–9 sheets: 100 sets</li> </ul>
	A3 ☐, B4 JIS ☐ ☐, 11" × 17" ☐, 8 <sup>1</sup> / <sub>2</sub> " × 14" ☐ ☐, 12" × 18" ☐	<ul style="list-style-type: none"> <li>• 10–30 sheets: 50–10 sets</li> <li>• 2–9 sheets: 50 sets</li> </ul>
2 Tray finisher	Finisher shift tray 1	
	A4 ☐ ☐, B5 JIS ☐ ☐, 8 <sup>1</sup> / <sub>2</sub> " × 11" ☐ ☐	<ul style="list-style-type: none"> <li>• 10–50 sheets: 50–10 sets</li> <li>• 2–9 sheets: 50 sets</li> </ul>
	A3 ☐, B4 JIS ☐ ☐, 11" × 17" ☐, 8 <sup>1</sup> / <sub>2</sub> " × 14" ☐ ☐, 12" × 18" ☐	<ul style="list-style-type: none"> <li>• 10–30 sheets: 25–8 sets</li> <li>• 2–9 sheets: 25 sets</li> </ul>
	mixed size	<ul style="list-style-type: none"> <li>• 2–30 sheets: 8 sets</li> </ul>
	Finisher shift tray 2	
	A4 ☐, 8 <sup>1</sup> / <sub>2</sub> " × 11" ☐	<ul style="list-style-type: none"> <li>• 15–50 sheets: 100–30 sets</li> <li>• 2–14 sheets: 100 sets</li> </ul>
	A4 ☐, B5 JIS ☐ ☐, 8 <sup>1</sup> / <sub>2</sub> " × 11" ☐ ☐, 12" × 18" ☐	<ul style="list-style-type: none"> <li>• 15–50 sheets: 50–15 sets</li> <li>• 2–14 sheets: 50 sets</li> </ul>
	A3 ☐, B4 JIS ☐ ☐, 11" × 17" ☐, 8 <sup>1</sup> / <sub>2</sub> " × 14" ☐ ☐, 12" × 18" ☐	<ul style="list-style-type: none"> <li>• 15–30 sheets: 50–25 sets</li> <li>• 2–14 sheets: 50 sets</li> </ul>
	mixed size	<ul style="list-style-type: none"> <li>• 2–30 sheets: 25 sets</li> </ul>
Booklet finisher	Finisher tray	
	A4 ☐, B5 JIS ☐ ☐ ☐, A5 ☐, 8 <sup>1</sup> / <sub>2</sub> " × 11" ☐	750 sheets or 30 sets
	A3 ☐, B4 JIS ☐ ☐, A4 ☐, 11" × 17" ☐, 8 <sup>1</sup> / <sub>2</sub> " × 14" ☐, 8 <sup>1</sup> / <sub>2</sub> " × 11" ☐	500 sheets or 30 sets
	Finisher booklet tray	
	A3 ☐, B4 JIS ☐ ☐, A4 ☐, 11" × 17" ☐, 8 <sup>1</sup> / <sub>2</sub> " × 11" ☐	<ul style="list-style-type: none"> <li>• 2–5 sheets: 25 sets</li> <li>• 6–10 sheets: 15 sets</li> <li>• 11–15 sheets: 10 sets</li> </ul>











- You cannot change stapling positions during copying.
- When the original image is rotated, the staple orientation changes by 90°.
- The maximum original image size that can be rotated is as follows:

Metric version	A4
Inch version	8 <sup>1</sup> / <sub>2</sub> " × 11"

- When using **[Top Slant]**, **[Left 2]** or **[Top 2]** with Combine, Double copies or Auto Reduce/Enlarge function, "Blank part will appear. Check orientation." message may appear depending on the orientation of originals and paper you placed. In this case, change the paper orientation.
- When **[Left 2]** or **[Top 2]** is selected, the following settings are useful to rotate images appropriately:
  - Auto Reduce/Enlarge or Auto Paper Select
  - With image rotation in Auto Tray Switching of User Tools
- If you select Saddle Stitch function with the optional booklet finisher, the machine staples and folds the paper in the center, then delivers the paper folded.
- If you select Saddle Stitch function in Magazine mode, the machine staples the paper, and folds it like a book, then delivers the paper folded.

#### ❖ Punch

- When using Punch and Combine, Double Copies, or Auto Reduce/Enlarge, the message "Blank part will appear. Check orientation." may appear because of the orientation of the original and the copy paper. If this occurs, change the orientation of the copy paper.
- Since punch holes are made in each copy, the punch hole positions vary slightly.
- Punchable paper sizes are as follows:

With 2 Tray finisher			
Punch kit type			
2 & 4 holes type	2 holes		A3-A5, 11" × 17"-5 <sup>1</sup> / <sub>2</sub> " × 8 <sup>1</sup> / <sub>2</sub> "
			A4-A5, 8 <sup>1</sup> / <sub>2</sub> " × 11"-5 <sup>1</sup> / <sub>2</sub> " × 8 <sup>1</sup> / <sub>2</sub> "
	4 holes		A3, B4 JIS, 11" × 17"
			A4, B5 JIS, 8 <sup>1</sup> / <sub>2</sub> " × 11"
4 holes type	4 holes		A3-A5, 11" × 17"-5 <sup>1</sup> / <sub>2</sub> " × 8 <sup>1</sup> / <sub>2</sub> "
			A4-A5, 8 <sup>1</sup> / <sub>2</sub> " × 11"-5 <sup>1</sup> / <sub>2</sub> " × 8 <sup>1</sup> / <sub>2</sub> "
2 & 3 holes type	2 holes		A3-A5, 11" × 17"-5 <sup>1</sup> / <sub>2</sub> " × 8 <sup>1</sup> / <sub>2</sub> "
			A4-A5, 8 <sup>1</sup> / <sub>2</sub> " × 11"-5 <sup>1</sup> / <sub>2</sub> " × 8 <sup>1</sup> / <sub>2</sub> "
	3 holes		A3, B4 JIS, 11" × 17"
			A4, B5 JIS, 8 <sup>1</sup> / <sub>2</sub> " × 11"

- The punch hole positions change according to the orientation of the paper selected.

### ❖ Duplex

- You cannot use the following copy paper with this function:
  - Paper smaller than A5  $\square$ ,  $5\frac{1}{2}'' \times 8\frac{1}{2}''$   $\square$  (possible on A5  $\square$ ,  $5\frac{1}{2}'' \times 8\frac{1}{2}''$   $\square$ )
  - Paper thicker than 105 g/m<sup>2</sup>, 28 lb.
  - Paper thinner than 64 g/m<sup>2</sup>, 17 lb.
  - Translucent paper
  - OHP transparencies
  - Label paper (adhesive labels)
  - Postcards
- When an odd number of originals is placed in the ADF, the back of the last page of copied paper is blank.
- During copying, the image is shifted to allow for the binding margin.
- The following paper sizes can be duplexed: A3  $\square$ , B4 JIS  $\square$ , A4  $\square$   $\square$ , B5 JIS  $\square$   $\square$ , A5  $\square$ , 11"  $\times$  17"  $\square$ , 8 $\frac{1}{2}$ "  $\times$  14"  $\square$ , 8 $\frac{1}{2}$ "  $\times$  11"  $\square$   $\square$

### ❖ Combine

- In this mode, the machine selects the reproduction ratio automatically. This reproduction ratio depends on copy paper sizes and the number of originals.
- The reproduction ratios you can specify are 25–400%.
- If the calculated ratio is under the minimum ratio, it is automatically adjusted to within available range. However, with some ratios, parts of the image might not be copied.
- You cannot use custom size paper.
- If the orientation of originals is different from that of the copy paper, the machine will automatically rotate the image by 90° to make copies properly.
- If the number of originals placed is less than the number specified for combining, the last page segment is left blank as shown.

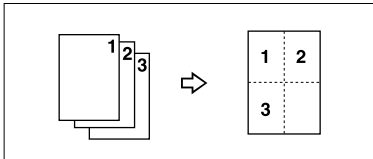

### ❖ Booklet/Magazine

- The machine sets the reproduction ratio automatically to meet the paper size and copies the originals together onto the paper.
- The reproduction ratios you can specify are 25–400%.
- If the calculated ratio is under the minimum ratio, it is automatically adjusted to within available range. However, with some ratios, parts of the image might not be copied.
- If the orientation of originals is different from that of the copy paper, the machine will automatically rotate the image by 90° to make copies properly.
- You cannot copy with originals different in size and orientation.
- If the number of originals scanned is less than a multiple of 4, the last page is copied blank.
- In Magazine mode, the copying may take some time after scanning originals.
- When the optional booklet finisher is installed, if you select Saddle Stitch function in Magazine mode, the machine staples and folds the paper in the center, then delivers the paper folded.

### ❖ Image Repeat

Depending on the paper size, ratio, and orientation, parts of repeated images may not be copied.

### ❖ Centring

Though the original is set to a different orientation from the paper loaded, the machine will not rotate the image by 90° (Rotate copy).

### ❖ Erase

The width of the erased margin varies depending on the reproduction ratio. If the size of the original is different from sizes listed in the following chart, the erased margin might be shifted:

- Metric version

Where original is placed	Paper size and orientation
Exposure glass	A3☐, B4 JIS☐, A4☐☐, B5 JIS☐☐, A5☐☐, 8 <sup>1</sup> / <sub>2</sub> " × 13"☐
ADF	A3☐, B4 JIS☐, A4☐☐, B5 JIS☐☐, A5☐☐, 8 <sup>1</sup> / <sub>2</sub> " × 13"☐

- Inch version

Where original is placed	Paper size and orientation
Exposure glass	11" × 17"☐, 8 <sup>1</sup> / <sub>2</sub> " × 14"☐, 8 <sup>1</sup> / <sub>2</sub> " × 11"☐☐
ADF	11" × 17"☐, 8 <sup>1</sup> / <sub>2</sub> " × 14"☐, 8 <sup>1</sup> / <sub>2</sub> " × 11"☐☐, 10" × 14"☐, 5 <sup>1</sup> / <sub>2</sub> " × 8 <sup>1</sup> / <sub>2</sub> "☐

❖ **Margin Adjustment**

- If you set a binding margin that is too wide, part of the image may not be copied.
- When making copies in Combine mode, the binding margin is added to the copies after the combination is finished.

❖ **Background Numbering**

The numbers appear to overlap the copied image in some cases.

❖ **Preset Stamp**

- You can change the size and density of the stamp with User Tools. Depending on the setting, density may change.
- Depending on paper size, if you change the stamp size, parts of the stamp might not be printed.

❖ **Date Stamp**

When using Combine mode, the date stamp is printed as follows:

- With the Combine function

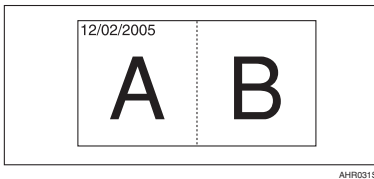

- With the Magazine or Booklet function

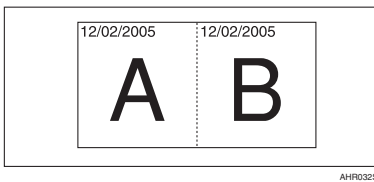

## ❖ Page Numbering

When page numbering is used with Combine mode, page numbers are printed as follows:

- Page Numbering per original:  
Combined with 1 Sided / 2 Sided in the Combine function

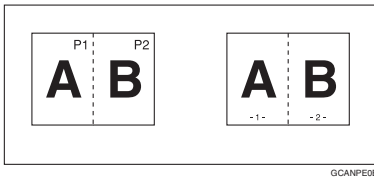

Combined with the Magazine or Booklet function

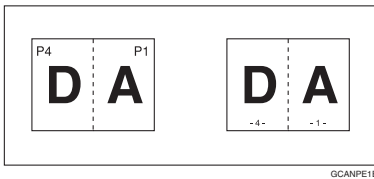

- Page Numbering per copy:  
Combined with 1 Sided / 2 Sided in the Combine function

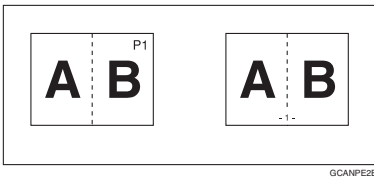

If you combine this function with the Duplex (Top to Top) function and select **[P1, P2]** or **[1/n, 2/n]**, page numbers on the back are printed as follows:

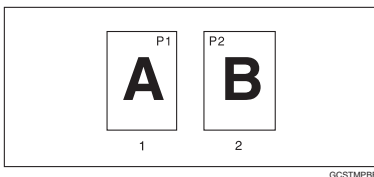

**1. Front**

**2. Back**

❖ **Front Cover, Front/Back Cover**

- If Blank mode is selected, the cover will not be counted as a copy.
- Front and back covers are two-sided copied depending on the settings made in Display Time in Cover Sheet Tray of User Tools (System Settings).
  - If Display Time is selected to the At Mode Selected, settings made in Cover Sheet Tray has the priority.
  - If Display Time is selected to Full Time, settings made in Paper Type has the priority.  
See “Paper Type” and “Cover Sheet Tray” in “Tray Paper Settings”, *General Settings Guide*.

❖ **Designate**

When Combine mode (“1 Sided→2 Sided”) has been selected, the page numbers you designate will always be copied onto the front of copies in the same way as Chapter mode.

❖ **Slip Sheets**

If you do not copy onto slip sheets, they are excluded from the number of copies counted.



# INDEX

- 
- 1 sided → 2 sided, 46
  - 2 sided → 1 sided, 46
  - 2 sided → 2 sided, 46
  - 90° turn, 13

## A

---

- Accessing user tools
  - copy/Document Server features*, 91
- Adjusting
  - copy image density*, 23
- Administrator Tools, 103
- Auto
  - image density*, 23
  - paper select*, 25
  - paper select priority*, 85
  - reduce/enlarge*, 30
  - tray switching*, 92
- Auto paper select, 26

## B

---

- Background numbering, 99
- Basic procedure, 17
- Batch mode, 14
- Border erase, 58

## C

---

- Center/border erase, 59
- Center erase, 59
- Change
  - stamp position*, 63, 66
  - style of date*, 66
- Changing
  - number of sets*, 35
  - stamp density*, 62
  - stamp position*, 67
  - stamp position, size and density*, 62
  - stamp size*, 62
  - stored program*, 76
- Changing Default Settings, 91
- Check Modes key, 5
- Clear Modes key, 5
- Clear/Stop key, 6
- Combination chart, 105
- Combined auto and manual image density, 23

- Control panel, 5
- Copier/document server features, 85
- Copy functions, 23
  - adjusting copy image density*, 23
  - auto reduce/enlarge*, 30
  - background numbering*, 61
  - booklet/magazine*, 52
  - centring*, 56
  - chapter*, 72
  - covers*, 70
  - date stamp*, 65
  - designate*, 71
  - directional magnification (%)*, 31
  - directional size magnification (mm)*, 32
  - double copies*, 55
  - duplex*, 46
  - image repeat*, 54
  - margin adjustment*, 60
  - one-sided combine*, 48
  - page numbering*, 66
  - positive/negative*, 57
  - preset reduce/enlarge*, 28
  - preset stamp*, 61
  - selecting copy paper*, 25
  - selecting original type setting*, 24
  - series copies*, 51
  - size magnification*, 30
  - slip sheets*, 72
  - sort*, 33
  - stack*, 36
  - staple*, 37
  - two-sided combine*, 49
  - user stamp*, 62
  - zoom*, 29
- Copying, 17
  - interrupt copy*, 18
  - job preset*, 19
  - original beeper*, 18
- Copying from bypass tray
  - onto custom size paper*, 20, 21
  - onto special paper*, 22
  - onto standard size paper*, 21
- Covers
  - Front*, 70
  - front/back*, 70
- Create margin mode, 28

## D

---

- Date stamp, 101
  - change position*, 66
  - change style*, 66
  - font*, 101
  - Page Numbering Initial Letter*, 102
  - position*, 102
  - position and original orientation*, 65
  - size*, 101
  - stamp format*, 101
  - superimpose*, 102
- Deleting
  - program*, 76
  - user stamp*, 64
- Display panel, 5
- Document Server, 74

## E

---

- Edit, 87, 96, 98
  - 1 sided→2 sided auto margin –T to B*, 97
  - 1 sided→2 sided auto margin –T to T*, 97
  - back margin –left/right*, 97
  - back margin –top/bottom*, 97
  - copy order in combine*, 99
  - double copies separation line*, 98
  - erase border width*, 97
  - erase center width*, 97
  - erase original shadow in combine*, 97
  - front cover copy in combine*, 99
  - front margin –left/right*, 97
  - front margin –top/bottom*, 97
  - image repeat separation line*, 98
  - separation line in combine*, 98
- Energy Saver key, 5
- Erase, 57
  - border*, 57
  - border width*, 97
  - center*, 57
  - center/border*, 57
  - center width*, 97
  - original shadow in combine*, 97
- Exiting User Tools, 91

## F

---

- Font, 101
- Format, 101
- Function status indicator, 6

## G

---

- General Features, 85, 86, 92, 94, 95
  - auto image density priority*, 93
  - auto paper select priority*, 92
  - auto tray switching*, 92
  - change initial mode*, 94
  - copy function key*, 94
  - copy orientation in duplex mode*, 94
  - copy quality*, 93
  - Document Server storage key*, 95
  - duplex mode priority*, 94
  - job end call*, 94
  - max. copy quantity*, 94
  - original orientation in duplex mode*, 94
  - original type display*, 92
  - original type priority*, 92
  - paper display*, 92
  - tone – original remains*, 94
- Generation copy, 24

## I

---

- Indicators, 5
- Input/Output, 90, 102
  - auto sort*, 103
  - letterhead setting*, 103
  - memory full auto scan restart*, 103
  - rotate sort – auto paper continue*, 102
  - SADF auto reset*, 102
  - select punch type*, 103
  - select stack function*, 103
  - select stapling position*, 103
  - switch to batch (SADF)*, 102
- Interrupt key, 5

## K

---

- Key
  - check modes*, 5
  - clear modes*, 5
  - clear/stop*, 6
  - energy saver*, 5
  - interrupt*, 5
  - program*, 5
  - sample copy*, 6
  - # (sharp)*, 6
  - start*, 6
  - user tools/counter*, 5

## M

---

Main power indicator, 5  
Manual image density, 23  
Manual paper select, 26  
Messages, 77  
Missing image area, 11  
Mixed size mode, 15

## N

---

Non-compatible originals for  
Auto Document Feeder, 9  
Number keys, 6

## O

---

OHP transparencies, 73  
One-sided combine  
    1 sided 2 pages → combine 1 side, 48  
    1 sided 4 pages → combine 1 side, 48  
    1 sided 8 pages → combine 1 side, 48  
    2 sided 1 page → combine 1 side, 48  
    2 sided 2 pages → combine 1 side, 48  
    2 sided 4 pages → combine 1 side, 48  
Operation switch, 5  
Original  
    beeper, 18  
    combine, 48  
    copy orientation, 47  
    orientation, 12  
    orientation and completed copies, 46  
    orientation in duplex mode, 94  
    type display, 92  
    type priority, 92  
Originals, 9

## P

---

Page Numbering, 101  
Page numbering  
    duplex back page stamping position, 101  
    first printing page, 68  
    font, 101  
    page numbering in combine, 102  
    Page Numbering Initial Letter, 102  
    position, 67  
    position and original orientation, 63  
    size, 101  
    stamp format, 101  
    stamp on designating slip sheet, 102  
    stamp position, 102  
    start number, 68  
    superimpose, 102  
Pale, 24

Photo, 24  
Placing  
    *custom size originals*, 16  
    *originals*, 9, 12, 13, 14, 16  
    *originals in Auto Document Feeder*, 14  
    *originals on exposure glass*, 13  
Preset stamp, 99  
    *changing density*, 62  
    *changing position*, 62  
    *changing size*, 62  
    *format*, 100  
    *language*, 100  
    *position*, 100  
    *position and original orientation*, 62  
    *priority*, 99  
Program key, 5  
Programs, 75  
Punching copies, 43

## R

---

Recalling a program, 76  
Reproduction Ratio, 86, 87  
Reproduction ratio, 95  
    *enlarge*, 95  
    *priority setting – enlarge*, 96  
    *priority setting – reduce*, 96  
    *ratio for create margin*, 96  
    *reduce*, 96  
    *R/E priority*, 96  
    *shortcut R/E*, 95  
Rotated copy, 27

## S

---

SADF mode, 15  
Sample copy, 35  
Sample copy key, 6  
Screen contrast knob, 5  
Selecting  
    *copy paper*, 25  
    *original type setting*, 24  
Series copies  
    *book → 1 sided*, 51  
    *book → 2 sided*, 51  
    *front & back → 2 sided*, 51  
# (sharp) key, 6  
Size, 101  
Sizes  
    *detectable by auto paper select*, 10  
    *difficult to detect*, 11  
    *of recommended originals*, 9  
Sort, 33  
    *rotate sort*, 33  
    *shift sort*, 34

Specifications, 105  
Stack, 36  
Stamp, 99

- background numbering*, 61
- date stamp*, 65
- format*, 100, 101
- language*, 100
- page numbering*, 66
- position*, 100, 101
- position and original orientation*, 63, 65, 67
- preset stamp*, 61
- priority*, 99
- setting*, 101
- user stamp*, 62

Standard orientation, 13  
Stapling position and original setting, 37  
Start key, 6  
Storing

- data*, 74
- program*, 75

Superimpose, 101  
Supplementary informations, 106

- background numbering*, 116
- booklet/magazine*, 115
- bypass tray copy*, 106
- centring*, 115
- combine*, 114
- date stamp*, 116
- designate*, 118
- directional size magnification*, 107
- duplex*, 114
- erase*, 115
- front/back cover*, 118
- front cover*, 118
- image repeat*, 115
- margin adjustment*, 116
- mixed size mode*, 106
- page numbering*, 117
- preset enlarge/reduce*, 106
- preset stamp*, 116
- punch*, 113
- rotate sort*, 108
- size magnification*, 107
- slip sheets*, 118
- sort*, 108
- stack*, 108
- staple*, 110
- zoom*, 107

## T

---

Text, 24  
Text/Photo, 24  
Tone – original remains, 94  
Troubleshooting, 77

- memory is full*, 83
- you cannot make clear copies*, 79
- you cannot make copies as you want*, 80
- your machine does not operate as you want*, 77

Two-sided combine

- 1 sided 16 pages → combine 2 side*, 50
- 1 sided 4 Pages → combine 2 side*, 49
- 1 sided 8 pages → combine 2 side*, 49
- 2 sided 16 pages → combine 2 side*, 50
- 2 sided 4 pages → combine 2 side*, 50
- 2 sided 8 pages → combine 2 side*, 50

Types of duplex copies, iii

## U

---

User stamp, 100

- changing position*, 63
- delete*, 64
- format*, 101
- position*, 100
- position and original orientation*, 63
- program*, 63
- program/delete*, 100

User Tools, 85  
User Tools/Counter key, 5

## W

---

Weights of recommended originals, 9  
What you can do with this machine, iii

MEMO

MEMO

In accordance with IEC 60417, this machine uses the following symbols for the main power switch:

**I** means **POWER ON.**

**⏻** means **STAND BY.**

### **Trademark**

Acrobat® is a registered trademark of Adobe Systems Incorporated.

Other product names used herein are for identification purposes only and might be trademarks of their respective companies. We disclaim any and all rights to those marks.

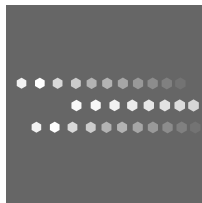

Type for 8035/DSm735/LD235/Aficio3035

Type for 8045/DSm745/LD245/Aficio3045

Printed in China

EN (USA) B198-6607



B1986607



## Free Manuals Download Website

<http://myh66.com>

<http://usermanuals.us>

<http://www.somanuals.com>

<http://www.4manuals.cc>

<http://www.manual-lib.com>

<http://www.404manual.com>

<http://www.luxmanual.com>

<http://aubethermostatmanual.com>

Golf course search by state

<http://golfingnear.com>

Email search by domain

<http://emailbydomain.com>

Auto manuals search

<http://auto.somanuals.com>

TV manuals search

<http://tv.somanuals.com>