

Aficio ColorTM 4506

**Operating Instructions
Copy Reference**

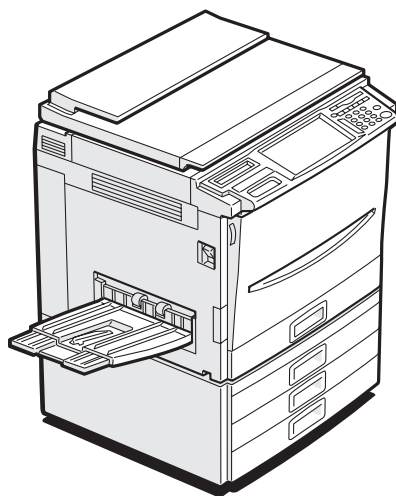

Read this manual carefully before you use this product and keep it handy for future reference.

For safety, please follow the instructions in this manual.



RICOH COMPANY, LTD.

15-5, Minami Aoyama 1-chome,
Minato-ku, Tokyo 107-8544, Japan
Phone: +81-(0)3-3479-3111

Overseas Affiliates

U.S.A.

RICOH CORPORATION
5 Dedrick Place
West Caldwell, New Jersey 07006
Phone: +1-973-882-2000

The Netherlands

RICOH EUROPE B.V.
Groenelaan 3, 1186 AA, Amstelveen
Phone: +31-(0)20-5474111

United Kingdom

RICOH UK LTD.
Ricoh House,
1 Plane Tree Crescent, Feltham,
Middlesex, TW13 7HG
Phone: +44-(0)20-8261-4000

Germany

RICOH DEUTSCHLAND GmbH
Mergenthalerallee 38-40,
65760 Eschborn
Phone: +49-(0)6196-9060

France

RICOH FRANCE S.A.
383, Avenue du Général de Gaulle
BP 307-92143 Clamart Cedex
Phone: +33-(0)1-40-94-38-38

Spain

RICOH ESPAÑA S.A.
Avda. Litoral Mar, 12-14,
08005 Barcelona
Phone: +34-(0)93-295-7600

Italy

RICOH ITALIA SpA
Via della Metallurgia 12,
37139 Verona
Phone: +39-045-8181500

Hong Kong

RICOH HONG KONG LTD.
21/F., Tai Yau Building,
181, Johnston Road,
Wan Chai, Hong Kong
Phone: +852-2862-2888

Singapore

RICOH ASIA PACIFIC PTE.LTD.
260 Orchard Road,
#15-01/02 The Heeren,
Singapore 238855
Phone: +65-830-5888

Introduction

This manual contains detailed instructions on the operation and maintenance of this machine. To get maximum versatility from this machine all operators should carefully read and follow the instructions in this manual. Please keep this manual in a handy place near the machine.

Please read the Safety Information before using this machine. It contains important information related to USER SAFETY and PREVENTING EQUIPMENT PROBLEMS.

Notes:

Some illustrations might be slightly different from your machine.

Certain options might not be available in some countries. For details, please contact your local dealer.

Operator Safety:

This machine is considered a class I laser device, safe for office/ EDP use. The machine contains a 5-milliwatt, 760 - 800 nanometer wavelength, GaAlAs laser diode. Direct (or indirect reflected) eye contact with the laser beam might cause serious eye damage. Safety precautions and interlock mechanisms have been designed to prevent any possible laser beam exposure to the operator.

The following label is attached on the back side of the machine.

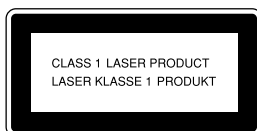

Laser Safety:

The optical housing unit can only be repaired in a factory or at a location with the requisite equipment. The laser subsystem is replaceable in the field by a qualified Customer Engineer. The laser chassis is not repairable in the field. Customer engineers are therefore directed to return all chassis and laser subsystems to the factory or service depot when replacement of the optical subsystem is required.

Warning:

Use of controls or adjustment or performance of procedures other than those specified in this manual might result in hazardous radiation exposure.

Two kinds of size notation are employed in this manual. With this machine refer to the metric version.

For good copy quality, Ricoh recommends that you use genuine Ricoh toner.

Ricoh shall not be responsible for any damage or expense that might result from the use of parts other than genuine Ricoh parts in your Ricoh office product.

Power Source:

220-240V, 50/60Hz, 6A or more

Please be sure to connect the power cord to a power source as above. For details about power source, ⇒ P.189 "Power Connection".

In accordance with IEC 60417, this machine uses the following symbols for the main power switch:

I means **POWER ON**.

⏻ means **STAND BY**.

Notice

Do not make copies of any item for which copying is prohibited by law.

Copying the following items is normally prohibited by local law:

Bank bills, revenue stamps, bonds, stock certificates, bank drafts, checks, passports, driver's licenses.

The color copy samples in this book may differ slightly from the actual copies due to printing effects.

The color on each Color key may differ slightly from that of the actual copy.

This machine is equipped with a function that prevents making counterfeit bank bills. Due to this function the original images similar to bank bills may not be copied properly.

Safety Information

When using your equipment, the following safety precautions should always be followed.

Safety During Operation

In this manual, the following important symbols are used:

⚠ WARNING:
Indicates a potentially hazardous situation which, if instructions are not followed, could result in death or serious injury.

⚠ CAUTION:
Indicates a potentially hazardous situation which, if instructions are not followed, may result in minor or moderate injury or damage to property.

⚠ WARNING:

- **Connect the power cord directly into a wall outlet and never use an extension cord.**
- **Disconnect the power plug (by pulling the plug, not the cable) if the power cable or plug becomes frayed or otherwise damaged.**
- **To avoid hazardous electric shock or laser radiation exposure, do not remove any covers or screws other than those specified in this manual.**
- **Turn off the power and disconnect the power plug (by pulling the plug, not the cable) if any of the following conditions exists:**
 - **You spill something into the equipment.**
 - **You suspect that your equipment needs service or repair.**
 - **Your equipment's cover has been damaged.**
- **Do not incinerate spilled toner or used toner. Toner dust might ignite when exposed to an open flame.**
- **Disposal can take place at our authorized dealer or at appropriate collection sites.**
- **Dispose of the used toner cartridge in accordance with the local regulation.**

⚠ CAUTION:

- *Protect the equipment from dampness or wet weather, such as rain, snow, and so on.*
- *Unplug the power cord from the wall outlet before you move the equipment. While moving the equipment, you should take care that the power cord will not be damaged under the equipment.*
- *When you disconnect the power plug from the wall outlet, always pull the plug (not the cable).*
- *Do not allow paper clips, staples, or other small metallic objects to fall inside the equipment.*
- *Keep toner (used or unused) and toner cartridge out of the reach of children.*
- *For environmental reasons, do not dispose of the equipment or expended supply waste at household waste collection points. Disposal can take place at an authorized dealer or at appropriate collection sites.*
- *The inside of the machine could be very hot. Do not touch the parts with a label indicating the "hot surface". Otherwise it could cause a personal burn.*
- *Our products are engineered to meet high standards of quality and functionality, and we recommend that you only use the expendable supplies available at an authorized dealer.*

How to Read This Manual

Symbols

In this manual, the following symbols are used:

WARNING:

This symbol indicates a potentially hazardous situation that might result in death or serious injury when you misuse the machine without following the instructions under this symbol. Be sure to read the instructions, all of which are described in the Safety Information section.

CAUTION:

This symbol indicates a potentially hazardous situation that might result in minor or moderate injury or property damage that does not involve personal injury when you misuse the machine without following the instructions under this symbol. Be sure to read the instructions, all of which are described in the Safety Information section.

WARNINGS and CAUTIONS are notes for your safety.

Important

If this instruction is not followed, paper might be misfed, originals might be damaged, or data might be lost. Be sure to read this.

Preparation

This symbol indicates the prior knowledge or preparations required before operating.

Note

This symbol indicates precautions for operation or actions to take after misoperation.

Limitation

This symbol indicates numerical limits, functions that cannot be used together, or conditions in which a particular function cannot be used.

Reference

This symbol indicates a reference.

[]

Keys that appear on the machine's panel display.

[]

Keys built into the machine's operation panel.

TABLE OF CONTENTS

What You Can Do with This Machine	2
Guide To Components	4
Options	6
Operation Panel	7
Using the Touch Panel Display	8
Selecting Functions	8
Entering Numbers	9
Color Sample Chart	10

1. Basics

Turning On the Power	11
Turning on the Main Power	11
Starting the Machine	12
Originals	14
Standard Size Originals	14
Recommended Originals	14
Non-recommended Originals for the Document Feeder	14
Setting Originals on the Exposure Glass	16
Setting a Stack of Originals in the Document Feeder	17
Setting one Original at a Time in the Document Feeder	19
Setting Originals of Different Sizes in the Document Feeder	21
Setting Custom Sized Originals	22
Removing the Platen Cover to Copy a Large Original	24

2. Copying

Basic Procedure	25
Adjusting Copy Image Density	26
Selecting a Color Mode	28
Twin color mode	31
Selecting the Original Image Type	33
Selecting the Copy Paper Size	36
Copying from the Bypass Tray	37
Auto Reduce/Enlarge	48
Energy Saver Mode	49
Auto Off Mode	49
Interrupt copying	50
Auto Start	51
Program	51
Check Modes	53
Counter	54
Preset R/E	54

Zoom	57
Directional Magnification (%)	59
Directional Size Magnification (mm).....	60
Duplex—Making 2 Sided Copies.....	63
1 Sided → 2 Sided	63
2 Sided → 2 Sided	66
Book → 2 Sided	67
Multi → 2 Sided	68
Series Copies.....	70
Book → 1 Sided	70
2 Sided → 1 Sided	72
Combine	73
Combine 2 Originals.....	73
Combine 4 Originals.....	75
Shifting the Image	76
Shift	76
Margin Adjustment	77
Cover Sheet.....	79
Front Cover	79
Front and Back Cover	80
Color Creation.....	83
Color Conversion	83
Color Erase	85
Color Background	86
Image Creation.....	88
Mirror	88
Positive/Negative	89
Finishing.....	90
Sort.....	90
Stack	92
Staple	93
Combination Chart	97





3. Adjustment and Color Memory

Color Balance	103
Color Balance Adjustment.....	103
Color Balance Program	104
Color Adjustment	106
Image Adjustment	108
Soft/Sharp, Contrast, Background Density, and Pastel	109
U.C.R. Adjustment, A.C.S. Sensitivity and Auto Text/Photo Sensitivity	110
Program User Color	111
Adjusting Colors Based on the Selected Color	111
Mixing Colors Manually with the Number Keys	113
Sampling the User Color (Option)	115

4. Area Editing (Option)

What is Area Editing?	117
How to Edit Areas	118
Designating Areas	119
Designate Area Display.....	120
Designate Area Tools.....	121
Area Shapes	122
Frame/Line	125
Notes for Designating Areas	128
Selecting Modes for Designated Areas	130
Area Editing.....	131
Delete Area	132
Save Area	133
Frame/Line	134
Selecting Modes for Outside Designated Areas	135
Area Shapes	136
Changing Basic Settings for the Entire Image	138
Checking and Changing Areas	140
Change Modes.....	140
Adding Areas.....	141
Erasing an Area	142
Erasing a Group.....	143
Exiting Area Editing	145
Combination Chart for Area Editing	146

5. What to Do if Something Goes Wrong

If Your Machine Does not Operate as You Want	149
If You Cannot Make Copies as You Want	151
 Loading Paper	154
Non-recommended Paper for Paper Trays	154
Loading Paper in the Paper Tray	155
 Adding Toner	156
Pulling Out the Toner Cartridge	156
Setting the New Toner Cartridge.....	159
 Clearing Misfeeds	161
Check the Misfeed Location Display	161
Clearing Paper Misfeeds.....	162
 Adding Staples	164
 Removing Jammed Staples	166

6. Changing the Machine's Settings

Changing Paper Size	169
Changing Paper Size with the User Tools	171
User Tools	173
Accessing the User Tools	173
Exiting from the User Tools.....	174
Setting You can Change with the User Tools (System Settings).....	175
Settings You can Change with the User Tools (Copier Features)	179

7. Others



Do's and Don'ts	187
Where to Put Your Machine	188
Machine Environment	188
Power Connection.....	189
Access to Machine	190
Maintaining Your Machine	191
Exposure Glass.....	191
Platen Cover	191
Document Feeder	192
Remarks	193
Copier.....	193
Use and Storage of Supplies	194
Copy Paper	194
Paper Storage	195
Toner Storage	195

8. Specification

Mainframe	197
Document Feeder (Option)	201
20-bin Sorter Stapler (Option)	202
10-bin Sorter Stapler (Option)	203
3-bin Sorter (Option)	204
1000-sheet Tray Unit (Option)	205
1500-sheet Tray Unit (Option)	206
Multi-access	207
INDEX	209

What You Can Do with This Machine

- Color Mode ⇒ Page 28

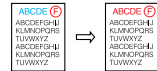

- Full Color Copy
 
- Black & White Copy
 
- Single Color Copy
 
- Twin Color Copy

Color



Red & Black

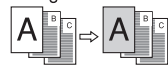

- Shift ⇒ Page 76
 
- Margin Adjustment ⇒ Page 77
 
- Cover Sheet ⇒ Page 79 *2
 

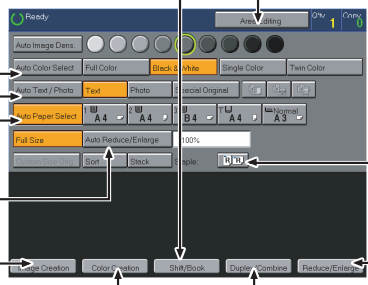

Text ⇒ Page 34



Auto Paper Select ⇒ Page 36

Auto Reduce/Enlarge ⇒ Page 48

Color Conversion ⇒ Page 83

Color Erase ⇒ Page 85







Color Background ⇒ Page 86



- Mirror Image ⇒ Page 88
 
- Positive / Negative ⇒ Page 89
 



*1 Optional 20-bin sorter stapler, 10-bin sorter stapler or 3-bin sorter required.
 *2 Optional 20-bin sorter stapler or 10-bin sorter stapler required.
 *3 Optional document feeder required.



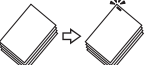

TLX391E

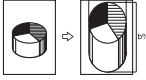
• Area Editing ⇒ Page 117

<p>• Color Conversion ⇒ Page 130</p> 	<p>• Color Background ⇒ Page 130</p> 	<p>• Delete Area ⇒ Page 132</p> 
<p>• Color Erase ⇒ Page 130</p> 	<p>• Paint ⇒ Page 130</p> 	<p>• Save Area ⇒ Page 133</p> 

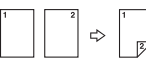
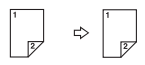
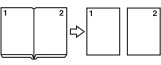
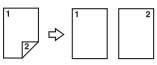
<p>• Sort ⇒ Page 90</p>  <p style="text-align: right;">*1</p>
<p>• Stack ⇒ Page 92</p>  <p style="text-align: right;">*1</p>
<p>• Staple ⇒ Page 93</p>  <p style="text-align: right;">*2</p>

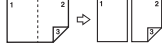
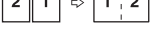
<p>• Preset R / E ⇒ Page 54</p> 	<p>• Directional Magnification(%) ⇒ Page 59</p> 
<p>• Zoom ⇒ Page 57</p> 	<p>• Directional Size Magnification(mm) ⇒ Page 60</p> 

<p>• 1 Sided → 2 Sided ⇒ Page 63</p> 	<p>• 2 Sided → 2 Sided ⇒ Page 66</p> 	<p>• Book → 1 Sided ⇒ Page 70</p> 	<p>• 2 Sided → 1 Sided ⇒ Page 72</p> 
<p>• Book → 2 Sided ⇒ Page 67</p> 	<p>• Multi → 2 Sided ⇒ Page 68</p> 	<p>• Combine 2 Originals ⇒ Page 73 *3</p> 	<p>• Combine 4 Originals ⇒ Page 75 *3</p> 

TL0K310E

Guide To Components

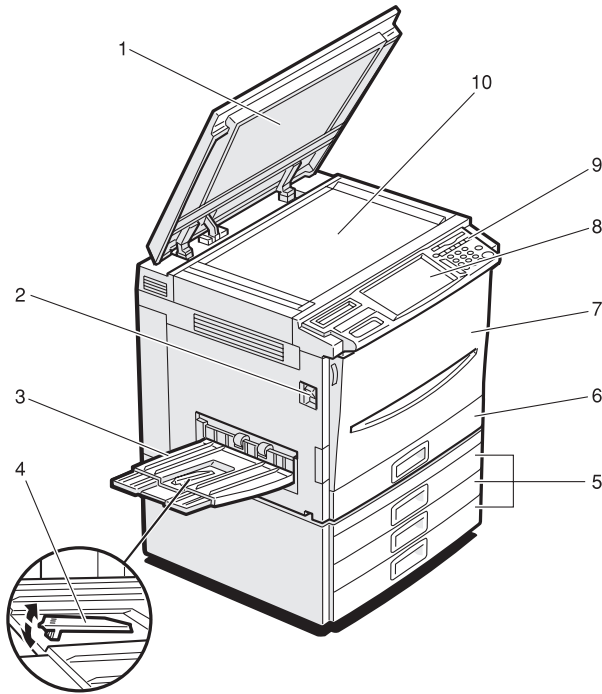

ZCMH010E

1. Platen cover (option)

Lower this cover over originals placed on the exposure glass for copying.

2. Main power switch

To start the machine, turn on this switch.

Note

- If the machine does not operate after turning on the operation switch, check if the main power switch is turned on. If it is off, turn it on.

3. Copy tray

Completed copies are delivered here.

4. Stopper

When you copy onto thin paper, raise this to prevent curling.

5. Paper tray

Set paper here. ⇒ P.154 “ Loading Paper”.

6. Auto duplex tray

Use to make two-sided copies.

7. Front cover

Open to access the inside of the machine.

8. Operation panel

⇒ P.7 “Operation Panel”.

9. Operation switch

Press this switch to turn the power (on the **On** indicator goes on). To turn off the power off, press this switch again (the **On** indicator goes off).

10. Exposure glass

Position originals here face down for copying.

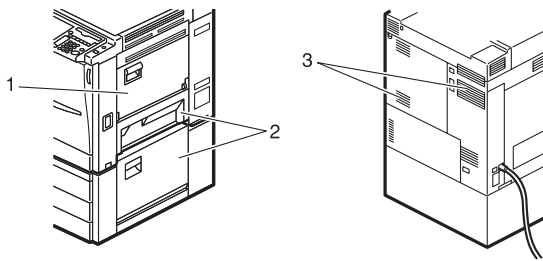

1. Bypass tray

Use to copy onto OHP transparencies, adhesive labels, translucent paper, post cards, and custom size paper, ⇒ P.37 *"Copying from the Bypass Tray"*.

2. Right side cover/Lower right cover

Open this cover to remove jammed paper.

3. Ventilation holes

Prevent overheating. Do not obstruct the ventilation holes by placing or leaning an object near them. If the machine overheats, a fault might occur.

Options

This machine can be provided with the following options:

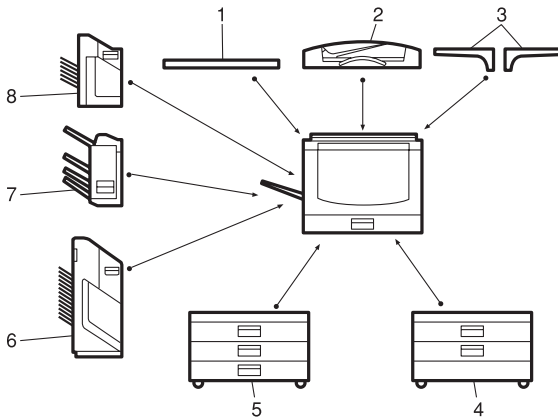

ZCMP010E

1. Platen cover

Lower this cover over originals placed on the exposure glass for copying.

2. Document feeder (ADF)

Insert a stack of originals here. They will be fed automatically.

3. Original tray

Put your originals.

4. 1000-sheet tray unit (two 500-sheet trays)

Consists of two paper trays.

Other Options:

- Controller Interface Unit
- Printer Controller

5. 1500-sheet tray unit (three 500-sheet trays)

Consists of three paper trays.

6. 20-bin sorter stapler

Sorts, stacks, and staples copies.

7. 3-bin sorter

Sorts and stacks copies.

8. 10-bin sorter stapler

Sorts, stacks, and staples copies.

Operation Panel

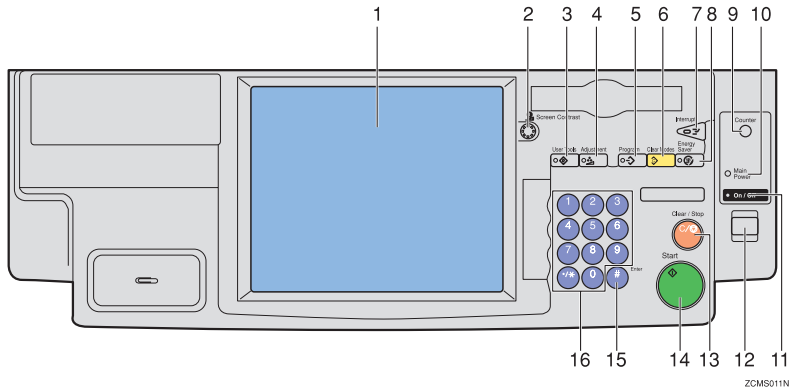

1. Touch panel display

You can see the operation status and messages here.

2. Screen Contrast knob

You can change the brightness of the display.

3. [User Tools] key

Press to change the default setting. ⇒ P.173 "User Tools".

4. [Adjustment] key

Press to adjust the image or color balance, or to make user colors. ⇒ P.103 "Adjustment and Color Memory".

5. [Program] key

Press to select the program mode. ⇒ P.51 "Program".

6. [Clear Modes] key

Press to clear the previously entered settings.

7. [Interrupt] key

Press to make interrupt copies. ⇒ P.50 "Interrupt copying".

8. [Energy Saver] key

Press to enter/exit the Energy Saver mode. ⇒ P.49 "Energy Saver Mode".

9. [Counter] key

Press to display the total number of copies made.

10. Main Power indicator

This indicator goes on when the main power switch is turned on, and goes off when the switch is turned off.

11. On indicator

This indicator goes on when the operation switch is turned on, and goes off when the switch is turned off.

12. Operation switch

Press this switch to turn the power on (the On indicator goes on). To turn the power off, press this switch again (the On indicator goes off).

13. [Clear/Stop] key

Press to cancel the copy number entered. While copying, press to stop copying. This key is also used to clear data.

14. [Start] key

Press to start copying.

15. [#] key

Press to enter data in selected modes.

16. Number keys

Use to enter the desired number of copies. They are also used to enter data.

Using the Touch Panel Display

Selecting Functions

On the touch panel display, you can find keys, instructions and messages. By pressing keys on the display, you can select or deselect functions, and enter data for the selected modes. If you make a mistake and wish to clear the current settings, press the **[Clear Modes]** key.

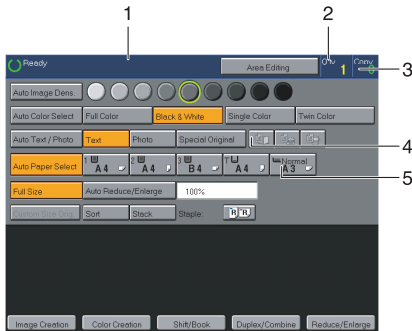

ZCMP022E

1. Messages and instructions appear here.

2. Total number of copies to make

3. COPY COUNTER

Counts number of copies made so far.

Note

- You can select whether the copy counter counts up (counter up) or counts down (counter down). If you want to change the setting, ⇒ P.175 "System settings".

Keys that do not have the option of being selected are fainter.

In this manual, keys on the display are indicated as follows:

Example:

- Key on the display: 
- In the manual: **[Auto Paper Select]** key

Note

- Do not press the touch panel display with any hard or sharp object.

This machine's features are accessed by simply pressing the name of the feature and following the instructions that come up on the display.

4. Keys that have been selected.

5. Keys that have the option of being selected.

Entering Numbers

When the display prompts you to enter a number, type in the number with the number keys and press the [#] key on the display to accept it.

Should you make a mistake:

- If you have not pressed the [#] key yet, press the **[Clear]** key and then re-enter it. If there is not the **[Clear]** key on the display, press the **[Clear/Stop]** key.
- If you have already pressed the [#] key, press the item you wish to change on the display and re-enter the number with the number keys. Press the [#] key on the display to accept it.

Checking the Functions You Have Selected

When you set one or more copy settings, the last item you selected will remain on the screen.



ZCMP040E

1. **[Check Modes]** key

To check all the settings you have set so far, press the **[Check Modes]** key.

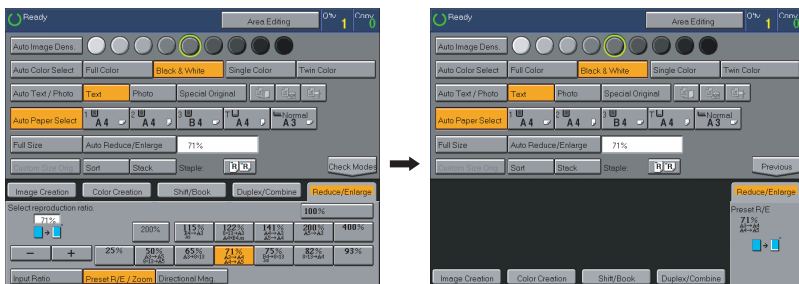

ZCMP050E

Color Sample Chart

This is the User Color sample. You can mix the basic colors to make your own colors (User Color).

 **Note**

- The color sample might differ somewhat from actual copies due to printing effects.

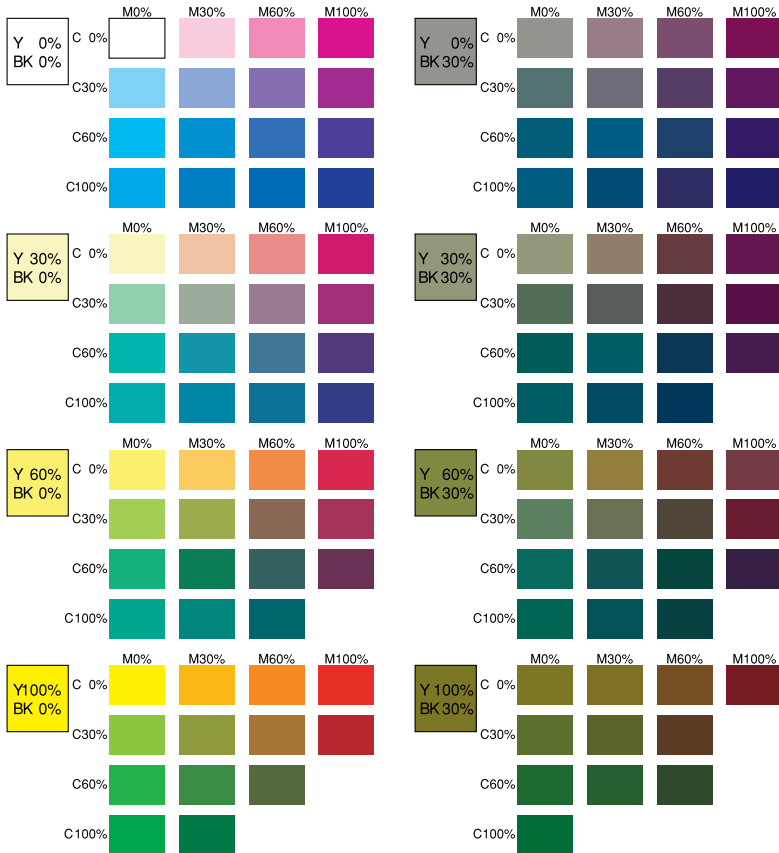

GCCLCT1E

Turning On the Power

To start the machine, press the operation switch to turn the power on.

Note

- ❑ This machine automatically enters Energy Saver mode or turns itself off if you do not use the machine for a while. For details, ⇒ P.49 "Energy Saver Mode". For details Auto Timer, ⇒ P.175 "System settings".



Power Switches

This machine has the operation switch and main power switch.

◆ Operation switch (right side of the operation panel)

Press this switch to activate the machine. When the machine has warmed up, you can make copies.

◆ Main power switch (left side of the machine)

When the machine is not to be used for an extended period of time, turn off the main power switch.

Turning on the Main Power

- 1** Make sure that the power cord is firmly plugged into the wall outlet.
- 2** Turn on the main power switch.

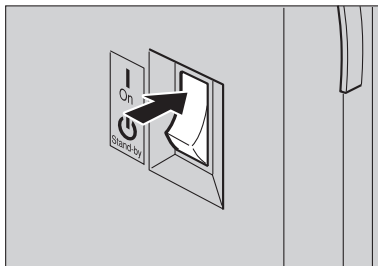

Starting the Machine

- 1 Press the operation switch to make the On indicator go on.

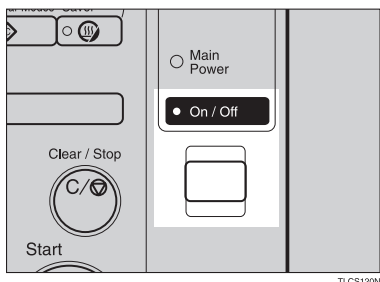

Note

- ❑ If the power is not turned on when the operation switch is pressed, check if the main power switch is on. If off, turn it on.
- ❑ During the warm-up period (Less than 270 seconds), you can use the Auto Start function. ⇒ P.51 "Auto Start".

When the machine is set for user codes

- 1 Enter your user code using the number keys. Then press the [#] key.

Note

- ❑ To prevent others from making copies with your user code, press the [Clear Modes] key and the [Clear/Stop] key simultaneously after copying.

Reference

For more about user codes, ⇒ P.179 "General Features".

When the Energy Saver indicator is lit

The machine is in Energy Saver mode.

- 1 Press any key.

The machine will return to the ready condition.

Note

- ❑ The machine will also return to the ready condition when an original is set in the document feeder, or when the platen cover or the document feeder is opened.

Shutting down the machine

- 1** Press the operation switch to make the On indicator go off.

Turning off the main power

- 1** Turn off the main power switch.

The main power indicator of the control panel goes off.

Originals

1

Standard Size Originals

The machine will detect originals of the following sizes and directions as standard size originals:

◆ When you set originals on the exposure glass

Metric version	A3☐, B4☐, A4☐☐, B5☐☐, 8 ¹ / ₂ "×13"☐ ^{*1} , 8 ¹ / ₄ "×13"☐ ^{*1} , 8"×13"☐ ^{*1}
Inch version	11"×17"☐, 10"×14"☐, 8 ¹ / ₂ "×14"☐, 8 ¹ / ₂ "×11"☐☐

◆ When you set originals in the document feeder

Metric version	A3☐, B4☐, A4☐☐, B5☐☐, A5☐☐, B6☐☐, 11"×17"☐, 8 ¹ / ₂ "×11"☐☐, 8 ¹ / ₂ "×13"☐ ^{*1} , 8 ¹ / ₄ "×13"☐ ^{*1} , 8"×13"☐ ^{*1}
Inch version	A4☐☐, 11"×17"☐, 11"×15"☐, 10"×14"☐, 8 ¹ / ₂ "×14"☐, 8 ¹ / ₂ "×13"☐, 8 ¹ / ₂ "×11"☐☐, 8 ¹ / ₄ "×13"☐, 8"×13"☐, 8"×10"☐, 5 ¹ / ₂ "×8 ¹ / ₂ "☐☐

^{*1} 8¹/₂"×13", 8¹/₄"×13" or 8"×13" can be set by your service representative.

Recommended Originals

🔍 Reference

For originals that the document feeder can handle, ⇒ P.201 "Document Feeder (Option)".

Non-recommended Originals for the Document Feeder

📝 Note

- ☐ The following types of originals are not recommended for use with the document feeder. Place them directly on the exposure glass.
 - Originals thicker than 128g/m², 34 lb
 - Originals thinner than 40g/m², 11 lb
 - For originals between 40 and 52g/m², 11 and 14 lb, the document feeder must be set to ADF Thin paper mode with the user tools.
 - Originals larger than A3, 11"×17"
 - Originals smaller than B6☐☐, 5¹/₂" × 8¹/₂"☐☐
 - Folded, curled, creased, or damaged originals
 - Mailing labels, or perforated originals
 - Bound, stapled, or clipped originals

- OHP transparencies
- Translucent paper
- Pasted originals
- Damp originals
- Sticky originals
- Wavy originals
- Originals that are not made from paper
- Originals written in pencil on both sides, or two-sided carbon originals
- Thermal fax paper, CRO (camera ready originals) or aluminum foil
- Books, pamphlets, and booklets

Setting Originals on the Exposure Glass

1

- 1** Lift the platen cover or the document feeder.
- 2** Set the original face down on the exposure glass. The original should be aligned to the rear left corner.

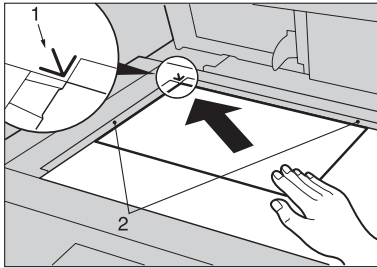

TFRS010E

- 1. Reference mark**
- 2. Scale**

 **Note**

- Start with the first page to be copied.

- 3** Lower the platen cover or the document feeder.

Setting a Stack of Originals in the Document Feeder

You can insert a stack of originals into the document feeder. These originals are individually fed onto and removed from the exposure glass.

Note

- Some originals are unsuitable for the document feeder. ⇒ P.14 “*Non-recommended Originals for the Document Feeder*”.
- Do not press down or hold originals after inserting them.
- While originals are fed from the original table to the exposure glass, do not pull them out.
- Do not lift the document feeder until the original has been completely fed out.

1 Correct any curl, fold, or crease in the originals before setting them.

2 Make sure the Insert Original indicator is lit and the exposure glass is clear of originals.

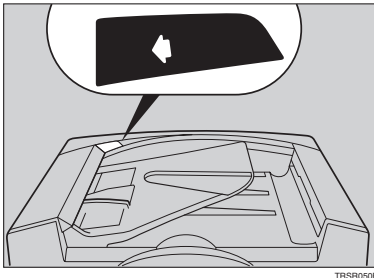

3 Adjust the guide to the original size.

- 4** Set the originals face up into the document feeder until the Insert Original indicator goes off.

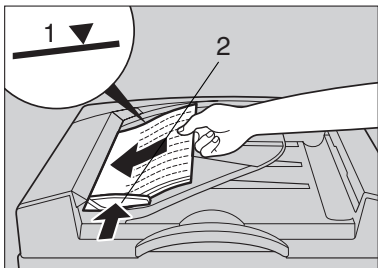

1. Limit mark

2. Original guide

Note

- The last page should be on the bottom.
- The original guide must touch the front side of the originals.
- Do not stack originals above the limit mark.

Setting one Original at a Time in the Document Feeder

If you set one original at a time in the document feeder, the second and subsequent originals can be fed and copied automatically without pressing the **[Start]** key.

Note

- Do not press down or hold originals after inserting them.
- While originals are fed from the original table to the exposure glass, do not pull them out.
- Do not lift the document feeder until the original has been completely fed out.

1 Correct any curl, fold, or crease in the originals before setting them.

2 Make sure the Insert Original indicator is lit and the exposure glass is clear of originals.

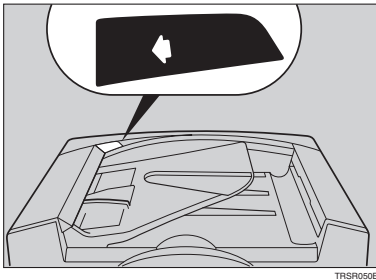

3 Adjust the guide to the original size.

4 Set the original face up into the document feeder until the Insert Original indicator goes off.

Note

- If you are copying a stack of originals one sheet at a time and you want to keep them in order, start with the last page of the originals.
- The original guide must touch the front side of the original.

5 Press the **[Start]** key.

- 6** While the Auto Feed indicator is lit after an original is fed, set the next original. The original is automatically fed and copied.



TCAR070E

 **Note**

- You can adjust the time the machine waits before being ready for the next original with the user tools.

Setting Originals of Different Sizes in the Document Feeder

Preparation

To use this function, you have to select ADF Mixed Sizes mode with the user tools. ⇒ P.184 "Duplex/ADF/Sorter".

You can insert a stack of originals of different standard sizes (e.g. A4, B5 etc.) into the document feeder. These originals are individually fed onto and removed from the exposure glass.

Limitation

- The weight of originals that can be set with this function is 52 - 81g/m², 14 - 20 lb.
- Smaller size originals might be skewed a little.

Note

- If your stack of originals contains pages of different sizes, make sure that:
 - Longer originals are at the bottom of the stack, and shorter originals are at the top.
 - All originals are flush with the back fence of the document feeder.

1 Align the rear and left edges of the originals as shown in the illustration.

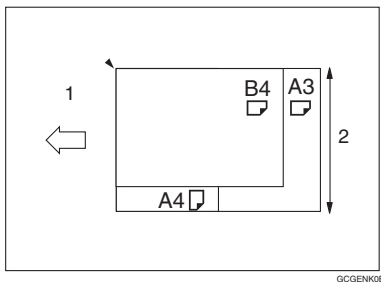

1. Document feeder feed direction.

2. Vertical size

2 Adjust the guide to the widest original size.

3 Set the aligned originals face up into the document feeder.

Setting Custom Sized Originals

When copying from custom sized originals, specify the size of the originals so that copies are well aligned.

⚠ Limitation

- You must set your custom size originals on the exposure glass.

🔍 Reference

For the standard sizes the machine can detect, ⇒ P.14 “Standard Size Originals”.

📝 Note

- The dimensions you can enter must be within the following ranges:

Vertical size	50 - 297mm (in 1mm steps), 2.0" - 11.7" (in 0.1" steps)
Horizontal size	50 - 432mm (in 1mm steps), 2.0" - 17" (in 0.1" steps)

1 Select the copy paper size.

2 Press the [Custom Size Orig.] key.

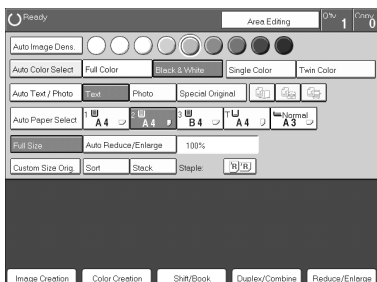

3 Make sure that the [Orig. Horiz.] key is selected. Enter the horizontal size with the number keys, then press the [#] key.

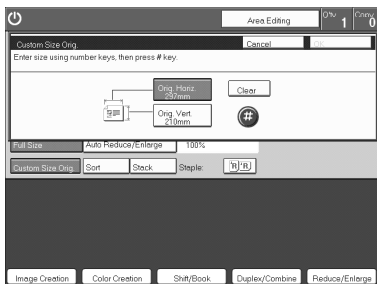

📝 Note

- To change the value entered, press the [Clear] key and enter a new value.

- 4** Press the [Orig. Vert.] key and enter the vertical size with the number keys, then press the [#] key.
- 5** Press the [OK] key.
- 6** Set your original on the exposure glass, then press the [Start] key.

Removing the Platen Cover to Copy a Large Original

1

You can remove the platen cover to copy a large (more than A3, 11" × 17") original.

Note

You cannot remove the document feeder.

To remove the platen cover, lift it out.

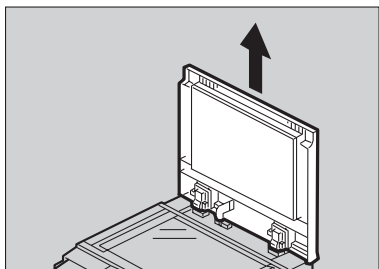

Note

Lift the platen cover with both hands. Place the removed cover on a flat surface, such as a desk, and where it will not be damaged.

To reset the platen cover, align the pins of the platen cover and the holes of the copier. Then push the platen cover onto the copier.

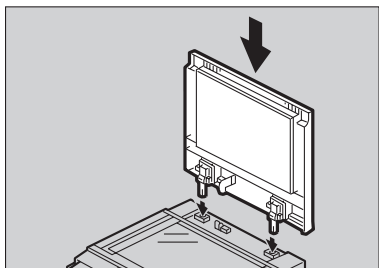

2. Copying

Basic Procedure

- 1 Set your original on the exposure glass or in the document feeder.
- 2 Make sure that the [Black & White], [Text], [Auto Paper Select], [Full Size] keys are selected.

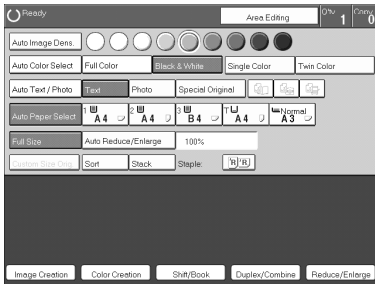

Note

- ❑ Full Color copy mode. ⇒ P.28 "Full color copy mode".
- ❑ Auto Text/Photo. ⇒ P.33 "Auto Text/Photo mode".
- ❑ Auto Paper Select. ⇒ P.36 "Auto paper select".

- 3 Enter the number of copies required using the number keys.

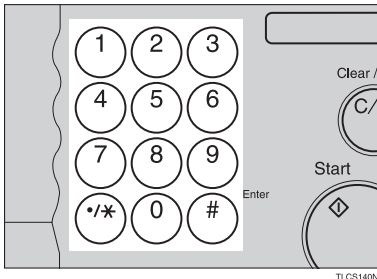

Note

- ❑ To change the number entered, press the [Clear/Stop] key, then enter the new number.

4 Press the **[Start]** key.

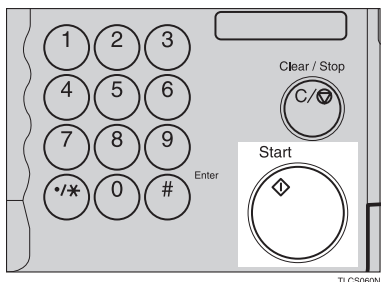

Note

- To stop the machine during a multi-copy run, press the **[Clear/Stop]** key.
- If you want to change the settings, press the **[Clear/Stop]** key. If you want to resume the copy run, press the **[Start]** key.
- To return the machine to the initial condition after copying, press the **[Clear Modes]** key.

Adjusting Copy Image Density

Image density affects the contrast of copies. With these functions you can control the image density so that copies match originals. Make the selection you require then set your originals and press the **[Start]** key.

Auto image density

The machine automatically controls the image density.

1 If Auto Color Select mode is selected, select other color modes to cancel it.
⇒ P.28 "Selecting a Color Mode".

2 Press the **[Auto Image Density]** key.

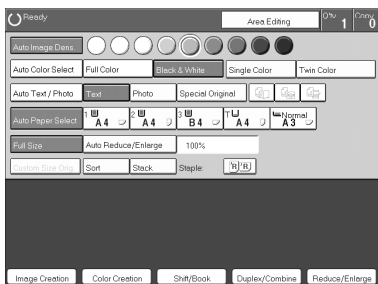

Manual image density

If you require darker or lighter copies, adjust the image density yourself.

- 1** If [Auto Image Density] key is selected, press it to cancel it.
- 2** Press the desired color density level.

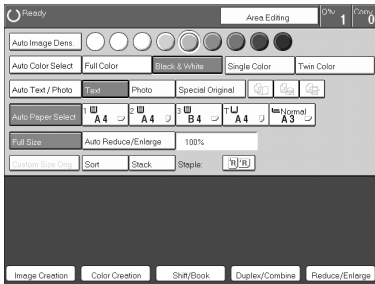

Combined auto and manual image density

Use when copying originals with a dirty background (such as newspapers). You can adjust the foreground density while masking out the dark background.

- 1** If Auto Color Select mode is selected, select other color modes to cancel it.
⇒ P.28 "Selecting a Color Mode".
- 2** Press the [Auto Image Density] key.

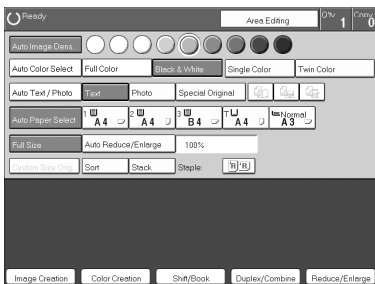

- 3** Press the desired color density level.

Selecting a Color Mode

Select a color mode that best suits your originals and copying requirements.

Auto color select mode

2

The machine automatically detects whether the original has color parts or not. Originals with only black images will be copied in Black & White mode. Originals with some color areas will be copied in Full Color mode.

Note

- If you make one copy set of a black original using the document feeder, it is recommended to select Black & White mode. If you choose Auto Color Select mode, the machine will reset the color selection for every original page, taking a long time to complete the job.

1 Press the [Auto Color Select] key.

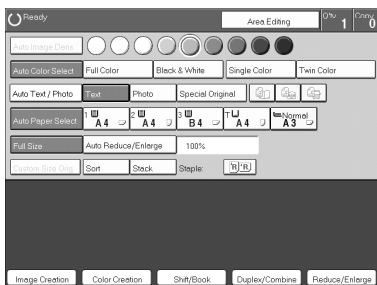

2 Set your originals, then press the [Start] key.

Full color copy mode

This function makes copies in full color.

Note

- You can adjust the overall color tone of copies. ⇒ P.103 “Color Balance”.

1 Make sure that the [Full Color] key is selected.

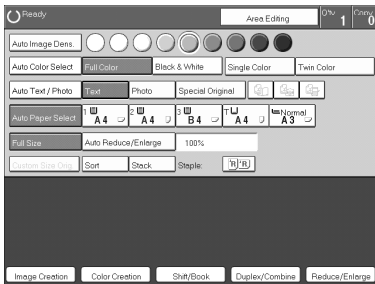

2 Set your originals, then press the [Start] key.

Black & White copy mode

This function makes copies in black.

1 Press the [Black & White] key.

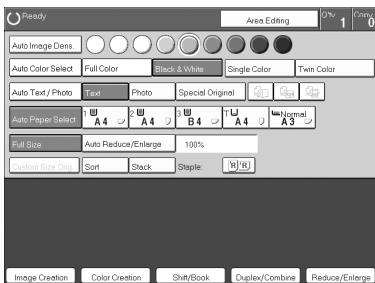

2 Set your originals, then press the [Start] key.

Single color mode

This function makes copies in single colors.

Note

- 12 basic colors: Yellow, Orange, Red, Magenta, Green, Cyan, Blue, Yellow Green, Beige, Marine Blue, Pink, Purple
- 15 user colors: Up to 15 colors can be manually mixed and stored in memory.
⇒ P.113 "Mixing Colors Manually with the Number Keys".

Basic color

1 Press the [Single Color] key.

2 Select the color.

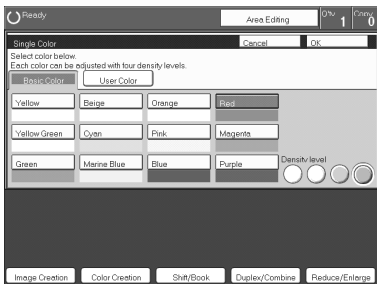

Note

You can select the color density level.

3 Press the [OK] key.

4 Set your originals, then press the [Start] key.

User colors

Note

When Single Color copying, user colors might come out lighter.

Reference

Program User Color, ⇒ P.111 "Program User Color".

1 Press the [Single Color] key.

2 Press the [User Color 10] key.

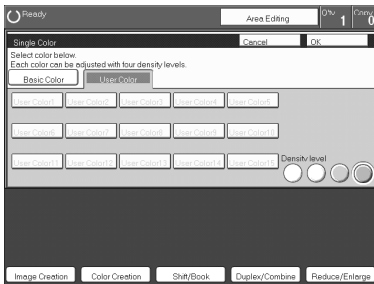

3 Select the color.**Note**

- You can select the color density level.

4 Press the [OK] key.**5** Set your originals, then press the [Start] key.

Twin color mode

Two methods are available

❖ **Color Copy**

Reproduces black areas of the original in one selected color and areas in other colors using the second selected color.

Note

- You can have colored areas copied in one of the following colors: Red, Green, Blue, Yellow, Cyan, Magenta, Yellow Green, Orange, Marine Blue, Beige, Pink, Purple and User Colors
- You can have black parts copied in one of the following colors: Red, Green, Blue, Yellow, Cyan, Magenta, Yellow Green, Orange, Marine Blue, Beige, Pink, Purple, and User Colors

❖ **Red & Black**

Reproduces red areas of the original in red, and areas in other colors using black.

Note

- You cannot change the color.

Twin Color (Color Copy)

- 1** Press the [Twin Color] key.
- 2** Select the color you want to copy the color parts of the original in.

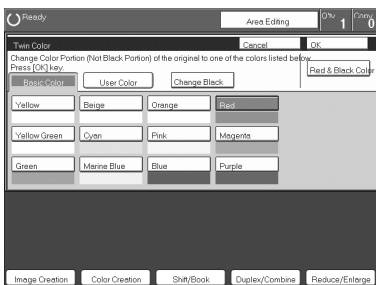

- 3** If you wish to copy black parts using a different color, press the [Change Black] key.

Note

- If you don't want to do this, go to step 5.

- 4** Select the color you want to copy the black parts of the original in. Then press the [OK] key.

- 5** Press the [OK] key.

- 6** Set your originals, then press the [Start] key.

Twin Color (Red & Black Copy)

Note

- If Color Sensitivity is set to wide, the machine recognizes orange or purple as red. This adjustment affect Color Erase or Color Conversion. ⇒ P.183 "Image Adjustment"

- 1** Press the [Twin Color] key.

- 2** Press the [Red & Black Color] key, then press the [OK] key.

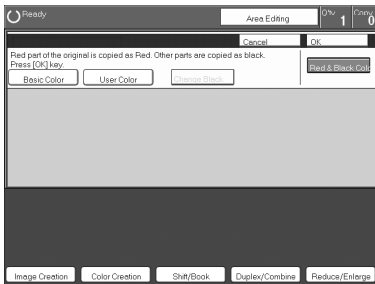

- 3** Set your originals, then press the [Start] key.

Selecting the Original Image Type

To optimize the likeness between copies and originals, select an image type that matches your originals.



Note

- You can adjust the readability of black lettering in colored areas, ⇒ P.106 "Color Adjustment".

Auto Text/Photo mode

This mode automatically detects the areas of your original containing text or photographs. The text areas are copied using Text mode, and the photographs are copied with Photo mode.

Note

- There are 3 types of Photo mode:
 -  **[Press Print]:**
Use when copying photographs or pictures that are printed on paper (e.g. magazines).
 -  **[Glossy Photo]:**
Use when copying developed photographs.
 -  **[2nd Generation]:**
Use when copying copies or originals generated by printers.

1 Make sure that the [Auto Text / Photo] key is selected.

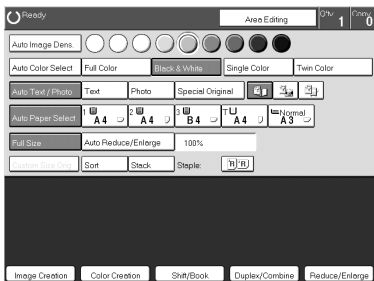

2 Select the photo mode.

3 Set your originals, then press the [Start] key.

Text mode

This modes is suitable for copying originals consisting of characters, line diagrams, and letter, but not photographic images.

1 Press the [Text] key.

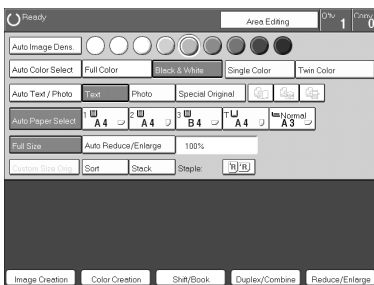



2 Set your originals, then press the [Start] key.

Photo mode

This mode is suitable for copying originals consisting of pictures, photographs, and screened letters/areas, but not solid letters.

Note

□ There are 3 types of Photo mode:

-  **[Press Print]:**
Use when copying photographs or pictures that are printed on paper (e.g. magazines).
-  **[Glossy Photo]:**
Use when copying developed photographs.
-  **[2nd Generation]:**
Use when copying copies or originals generated by printers.

1 Press the **[Photo]** key.

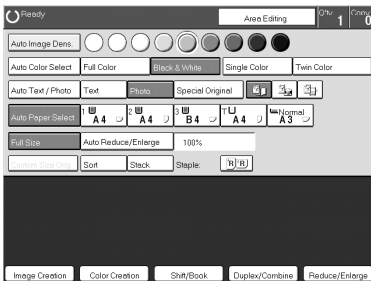

2 Select the photo mode.

3 Set your originals, then press the **[Start]** key.

Special original mode

Use this function for originals written in highlight pen, originals printed from inkjet printers, or maps.

1 Press the **[Special Original]** key.

2 Select the original type from the **[Highlight Pen]**, **[Inkjet Output]**, and **[Map]** key.

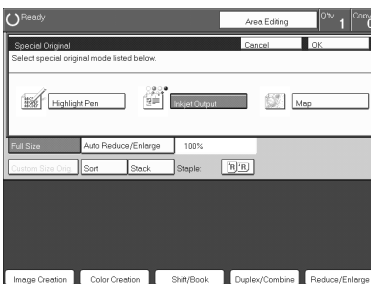

3 Set your originals, then press the **[Start]** key.

Selecting the Copy Paper Size

Select a suitable size of copy paper based on the original size and the reproduction ratio.

Auto paper select

2

The machine automatically selects a suitable size of copy paper based on the original size and the reproduction ratio.

Reference

Regarding functions that cannot be used together with this function, ⇒ P.97 “Combination Chart”.

Note

- Sizes of certain originals might not be detected depending on the originals size and type. In this case, select the size manually.

1 Make sure that the [Auto Paper Select] key is selected.

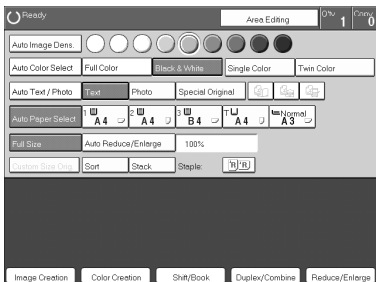

Manual paper select

You can select the copy paper manually.

1 Select the copy paper.

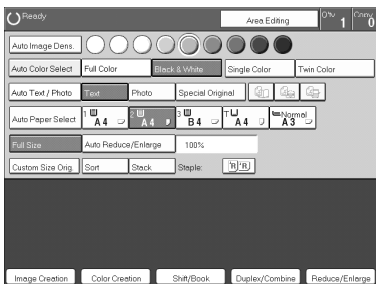

 **Image Rotation**

If the direction in which your original is set (landscape or portrait) is different from the paper you are copying onto, this function rotates the original image by 90° and fits it on the copy paper. This function works when Auto Select or Auto Reduce/Enlarge are selected. ⇒ P.179 “General Features”

 **Note**

- Image Rotation does not work with the following functions:
 - Area Editing
 - Series Copies (2-sided → 1-sided)
 - Duplex Copies (1-sided → 2-sided, 2-sided → 2-sided)
 - OHP Slip Sheet

Copying from the Bypass Tray

Use the bypass tray to copy onto thick paper, adhesive labels, OHP transparencies, or custom size paper. Also use the bypass tray to copy onto the reverse side of paper that has already been copied onto.

 **Note**

- The following limitations apply:

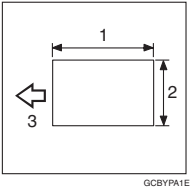
Acceptable paper types	Normal paper (52 - 105g/m ² , 14 - 28 lb) Thick paper (105 - 160g/m ² , 28 - 43 lb) Post cards OHP transparencies Adhesive labels Translucent paper	
	Standard size	Metric version: □: A3, B4, A4, B5, A5, B6, A6, 11" × 17", 12" × 18" □: A4, B5, A5, 8 ¹ / ₂ " × 11" Inch version: □: 12" × 18", 11" × 17", 8 ¹ / ₂ " × 11", 5 ¹ / ₂ " × 8 ¹ / ₂ " □: 8 ¹ / ₂ " × 11", 5 ¹ / ₂ " × 8 ¹ / ₂ "
	Custom size  1: Horizontal 2: Vertical 3: Feed direction	Metric version: Vertical: 100 - 305mm (in 1mm steps) Horizontal: 140 - 457mm (in 1mm steps) Inch version: Vertical: 3.9" - 12.0" (in 0.1" steps) Horizontal: 5.5" - 18.0" (in 0.1" steps)
Number of sheets that can be set at one time	Normal paper: 50 sheets Thick paper, OHP transparencies: 30 sheets (Smaller than 8" × 13"), 15 sheets (8" × 13" or large) Adhesive labels: 30 sheets Translucent paper: 50 sheets Post cards: 25 sheets	

- ☐ Select one of the following settings or keys:
 - **[Normal]**: normal paper
 - **[Thick]**: thick paper, post cards, adhesive labels, translucent paper
 - **[OHP]**: OHP transparencies
 - **[Duplex Back]**: Copying onto the reverse side of paper that has been already copied onto. ⇒ P.46 "Copying onto the reverse side of paper".
 - **[Custom Size]**: Select this after the paper type for custom sized paper. ⇒ P.41 "Copying onto custom size paper with the bypass tray".

- ❑ When you copy onto OHP transparencies, you can select whether a blank slip sheet is inserted between OHP transparencies.

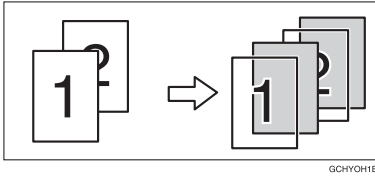

- ❑ When you set several sheets at a time, fan them to get air between them before loading.
- ❑ If the copy paper is curled, gently roll it to remove the curl.
- ❑ When you copy onto OHP transparencies, insert them with the copy side up.
- ❑ Do not stack copy paper above the limit mark.
- ❑ If the copy paper is bent, correct it before setting paper in the bypass tray. If the bend is not corrected, a paper misfeed might occur.
- ❑ When the optional sorter stapler is installed, copies made onto thick or OHP transparencies are not delivered in the proof tray but in the first bin instead.
- ❑ When setting custom size paper, be sure to set the size after pressing the **[Custom Size]** key.

Copying onto standard size paper with the bypass tray

Note

- ❑ When you copy onto the reverse side of paper that has been already copied onto, ⇒ P.46 "Copying onto the reverse side of paper".

1 Open the bypass tray.

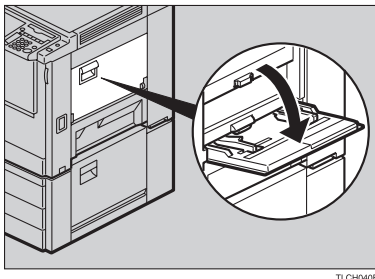

2 Press the [Normal], [Thick] or [OHP] key.

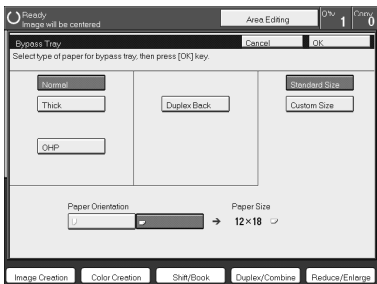

Note

- Make sure that the [Standard Size] key is selected.
- When you copy onto OHP transparencies, you can select whether a blank slip sheet is inserted between OHP transparencies.

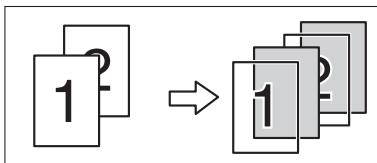

GCHYQH1E

3 Press the [Portrait/Landscape] key to select the paper orientation.

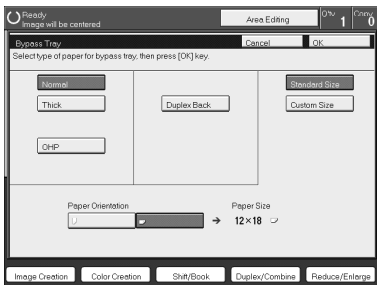

4 Press the [OK] key.

5 Adjust the paper guides to the paper size.

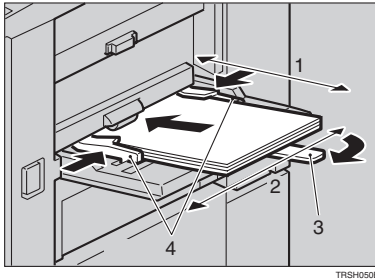

1. Horizontal size
2. Vertical size
3. Extender
4. Paper guides

Note

- Make sure the paper size and direction in the bypass tray is displayed on the operation panel.
- Make sure that the paper guides matches to the paper size. If the paper guides are not adjusted to the paper size properly, paper might be skewed or a paper misfeed might occur.
- With large copy paper (more than A4 \square , $8\frac{1}{2}'' \times 11'' \square$), swing out the extender.

6 With the side you wish to copy onto face up, insert the paper into the bypass tray until it stops.

7 Set your originals, then press the **[Start]** key.

Copying onto custom size paper with the bypass tray

Preparation

You can register custom paper sizes you use often in keys **[Custom 1]**, **[Custom 2]**, and **[Custom 3]** with the user tools. \Rightarrow P.175 "System settings".

Note

- Be sure to set the paper size or a paper misfeed might occur.

1 Open the bypass tray.

2 Press the **[Normal]**, **[Thick]** or **[OHP]** key.

3 Press the **[\square / \square]** key to select paper orientation.

4 Press the [Custom Size] key.

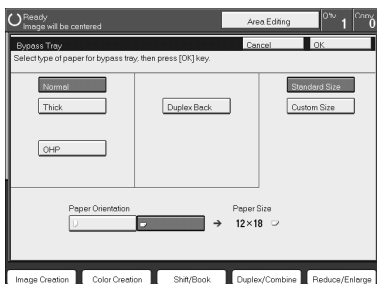

5 Select [Custom 1], [Custom 2], [Custom 3] or [Enter Size] keys.

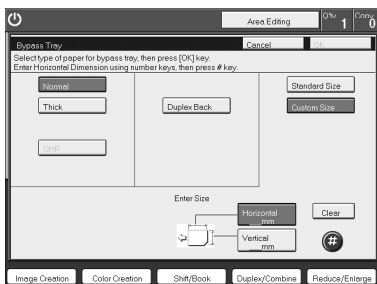

Note

❑ If you selected [Custom 1], [Custom 2] or [Custom 3], go to step 3.

6 If you selected [Enter Size] in step 5, enter the horizontal paper size with the number keys, then press the [#] key.

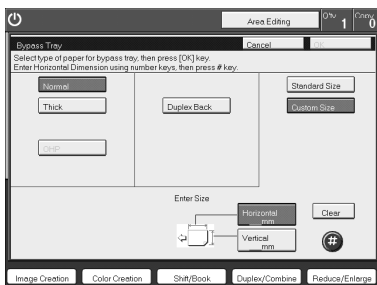

Note

❑ To change the value entered, press the [Clear] key and enter a new value.

- 7 Enter the vertical paper size with the number keys, then press the [#] key.

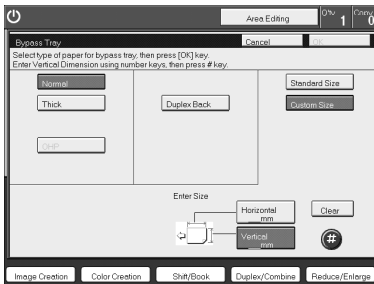

- 8 Press the [OK] key.
- 9 Adjust the paper guides to the paper size.

 **Note**

- Make sure that the paper guides match the paper size. If the paper guides are not adjusted to the paper size properly, paper might be skewed or a paper misfeed might occur.

- 10 Insert the paper into the bypass tray.
- 11 Set your originals, then press the [Start] key.

Making A3, 11" × 17" full bleed copies

By sliding the paper guides of the bypass tray to greater than A3 (11") size, A3 11" × 17", full bleed copying mode is automatically selected.

In this mode, you can make A3, 11" × 17" full bleed copies with 12" × 18" paper. This is useful to make for making A3, 11" × 17" size copies with a colored background (e.g. catalogues).

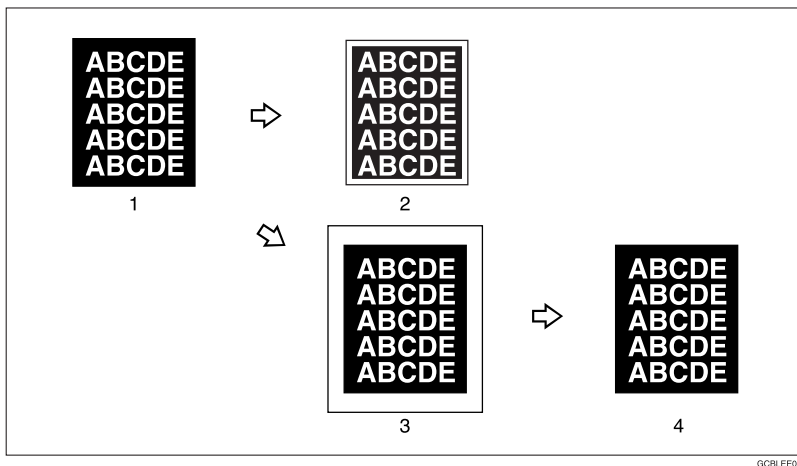

1. A3, 11" × 17" size Original

2. In standard copy mode, margins appear on copies

3. 12" × 18" Full Bleed Copy

4. Cut around the margins to produce a full image

By sliding the paper guides of the bypass tray, the machine enters A3, 11" × 17", full bleed copying mode automatically.

Note

- This function can be used with 12" × 18" paper.
- When A3, 11" × 17" full bleed copying mode is selected, the paper direction is automatically changed to widthwise .
- When A3, 11" × 17" full bleed copying is made, the original image is copied onto the center.

By sliding the paper guides of the bypass tray, the machine enters A3, 11" × 17" full bleed copying mode automatically.

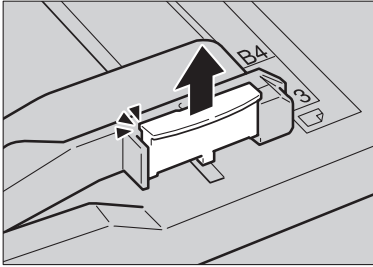
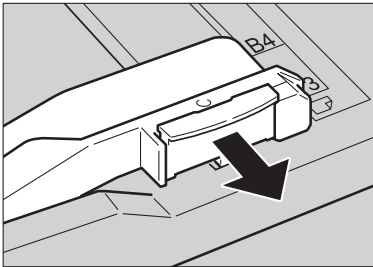
1 Pull up the tab.**2** Leaving the tab up, slide the paper guides until they stop.**Note**











- Make sure that the paper guides match the paper size.
- Be sure to return the tab to its original position before you close the bypass tray. If you do not return it correctly, the bypass tray might not close properly.

Copying onto the reverse side of paper

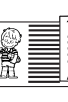
You can copy onto the reverse side of paper that has been already copied onto.

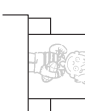
Note

- If you wish to copy 2 sided onto normal paper, use the Duplex feature. ⇒ P.63 “Duplex—Making 2 Sided Copies”.
- Make sure that you set your original and the copy paper in the correct direction to achieve the results you require.

Original set on the exposure glass	Copy paper set on the bypass tray	Copies
		
<small>GCMRYO2E</small>		
		
<small>GCMRYO4E</small>		
		
<small>GCMRYO1E</small>		
		
<small>GCMRYO3E</small>		

- If Duplex copying cannot be done because of paper problems, set paper on the bypass tray to copy on the front side, and once again copy on the backside.

2

- You cannot use this function for OHP transparencies, translucent paper, adhesive labels and postcards.
- Do not use copy paper that has been already copied onto by other machines.
- If the copy paper is bent, correct it before setting paper in the bypass tray. If the bend is not corrected, a paper misfeed might occur.



1 Open the bypass tray.

2 Insert the paper into the bypass tray.

 **Note**

- Make sure the front side (the side that has been copied onto) faces down.

3 Press the [Normal] or [Thick] key.

4 Press the [ / ] key to select paper orientation.

5 Press the [Duplex Back] key.

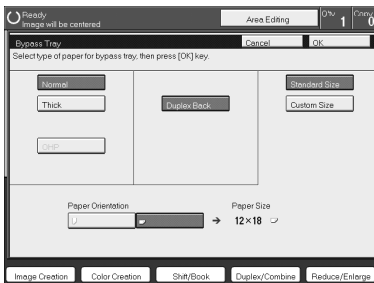

 **Note**

- To copy onto custom size paper, press the [Custom Size] key and select or enter the size. For details, ⇒ P.41 “Copying onto custom size paper with the bypass tray”.

6 Press the [OK] key.

7 Adjust the paper guides to the paper size.

 **Note**

- Make sure that the paper guides match the paper size. If the paper guides are not adjusted to the paper size properly, paper might be skewed or a paper misfeed might occur.

8 Set your originals, then press the [Start] key.

2

Auto Reduce/Enlarge

The machine can select the proper reproduction ratio based on the selected paper size and the original size.

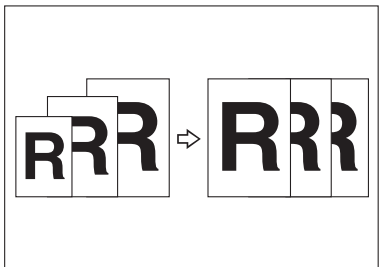

GCYHENT1E

Note

- ☐ Regarding functions that cannot be used together with this function, ⇒ P.97 "Combination Chart".

Example:

- Metric version: original: A3☐, copy paper: A4☐
- Inch version: original: 11" × 17"☐, copy paper: 8¹/₂" × 11"☐

1 Press the [Auto Reduce/Enlarge] key.

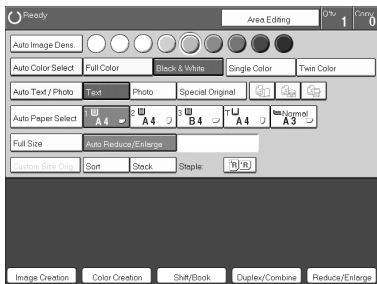

2 Set your original on the exposure glass or in the document feeder.

3 Choose your copy paper size (e.g. A4☐, 8¹/₂" × 11"☐).

4 Press the [Start] key. The original image is enlarged or reduced to fit the selected copy paper.

Energy Saver Mode

If you do not operate the machine for a certain period after copying or press the **[Energy Saver]** key, the display goes out and the machine enters Energy Saver mode. When you press the **[Energy Saver]** key again, set originals in the document feeder or open the platen cover or document feeder, the machine returns to the ready condition. In Energy Saver mode, the machine uses less electricity.

1 Press the **[Energy Saver]** key to enter Energy Saver mode.

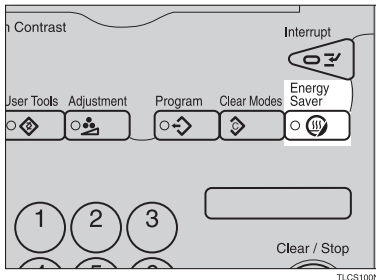

Note

- To exit this mode, press the **[Energy Saver]** key again.

Auto Off Mode

This machine automatically turns itself off 60 minutes after the last copy or print job has finished. If you wish to make copies when the machine is in Auto Off mode, press the operation switch.

Reference

For how to change the default interval that the machine waits before entering Auto Off mode, see "Auto Timer" ⇒ P.175 "System settings"

Interrupt copying

Use the **[Interrupt]** key to interrupt a copy run and make urgently needed copies.

Reference

Regarding functions that cannot be used together with this function, ⇒ P.175 "System settings".

- 1** Press the **[Interrupt]** key. The machine will stop the copy run and store the present settings in memory before returning to ready condition.

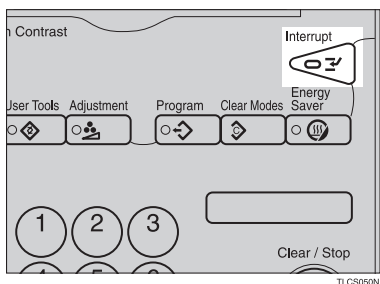

- 2** Remove the previous originals. Set your original for interrupt copying on the exposure glass or in the document feeder.
- 3** Make your copies.
- 4** After interrupt copying is completed, press the **[Interrupt]** key again. The machine will recall the previous copy settings.
- 5** Reset the previous originals and press the **[Start]** key to resume the previous run.

Auto Start

If you press the **[Start]** key during the warm-up period, the **[Start]** key will blink and the machine will start copying after the warm-up period.

- 1** Set your copy settings during the warm-up period.
- 2** Press the **[Start]** key.

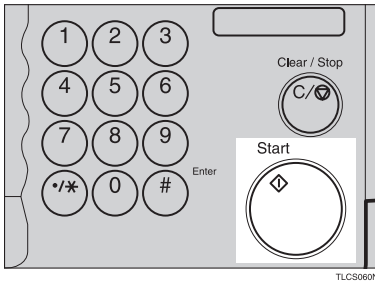

Note

- To cancel Auto Start, press the **[Clear/Stop]** key.

Program

You can store up to five frequently used copy job settings in machine memory and recall them for future use.

Note

- If you want to change the stored programs, store another program again.

Storing your settings

- 1** Set the copy settings you want to put into memory.
- 2** Press the **[Program]** key.

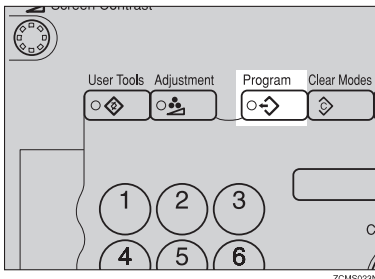

3 Press the [Program] key.



4 Select the program number you want to store the settings in.

Note

- If this program number is already being used, the machine asks whether you wish to overwrite it or not. Press the [Yes] or [No] key.

Recalling your settings

1 Press the [Program] key.

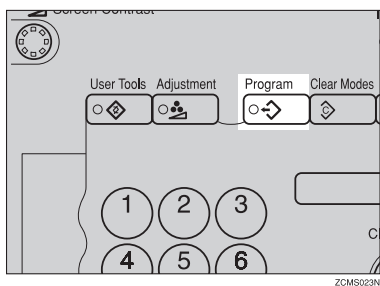

Note

- If you want to recall Area Edit settings stored in a program, press the [Area Editing] key then press the [Program] key.
- After you recall the Area Edit settings stored in a program, you can change them. However, you can not add or delete the Area/Group.

2 Press the [Recall] key.



3 Select the program number you want to recall. The stored settings are displayed.

Note

- Only programs with contain a program.

4 Set your originals, then press the [Start] key.

Check Modes

By pressing the [Check Modes] key, you can see at a glance the modes you have selected.

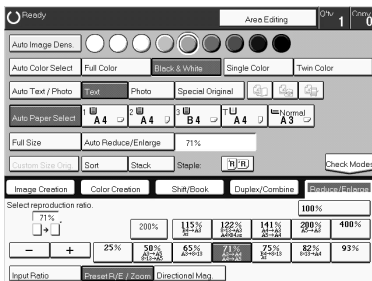

Counter

By pressing the **[Counter]** key, you can check the total number of copies made.

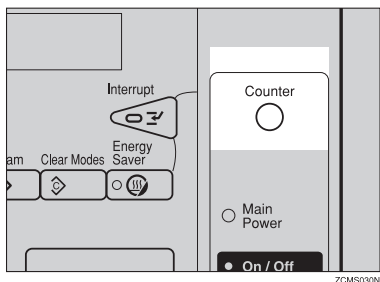

Preset R/E

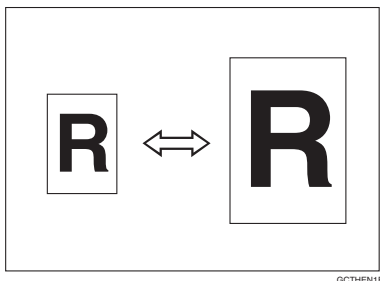

Reference

Regarding functions that cannot be used together with this function, ⇒ P.97 "Combination Chart".

Note

- You can add up to two preset ratios with the user tools. ⇒ P.179 "General Features".
- You can select a ratio regardless of the size of an original or copy paper. With some ratios, parts of the image might not be copied or margins will appear on copies.
- To return to 100%, press the **[100%]** key.

Reducing

- 1** Press the [Reduce/Enlarge] key.
- 2** Make sure that the [Preset R/E / Zoom] key is selected.

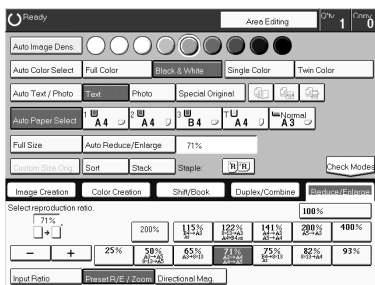

- 3** Select the ratio you require.

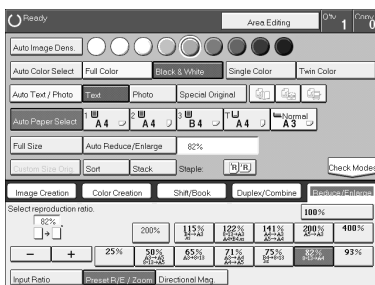

- 4** Set your originals, then press the [Start] key.

2

Enlarging

- 1** Press the [Reduce/Enlarge] key.
- 2** Make sure that the [Preset R/E / Zoom] key is selected.

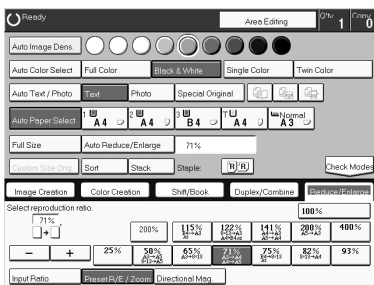

- 3** Select the ratio you require.

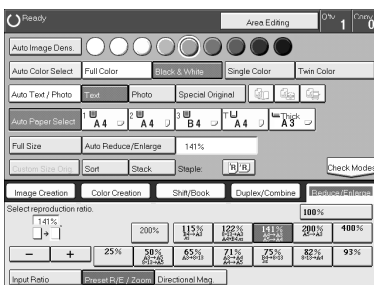

- 4** Set your originals, then press the [Start] key.

Zoom



You can change the reproduction ratio from 25% to 400% in 1% steps.

Note

- You can select a ratio regardless of the size of an original or copy paper. With some ratios, parts of the image might not be copied or blank margins will appear on copies.
- To return to 100%, press the **[100%]** key.
- You can select a preset ratio which is near the desired ratio, then press the **[Zoom]** key and adjust the ratio with the **[+]** or **[-]** key.
- There are two ways to set the ratios.

Using the [-] and [+] keys

1 Press the **[Reduce/Enlarge]** key.

2 Make sure that the **[Preset R/E / Zoom]** key is selected.

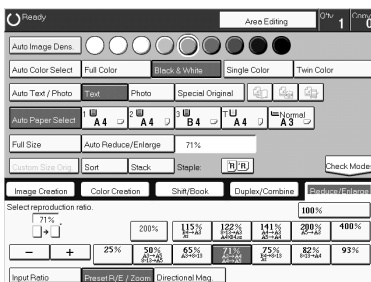

3 Adjust the reproduction ratio with the [+] or [-] key.

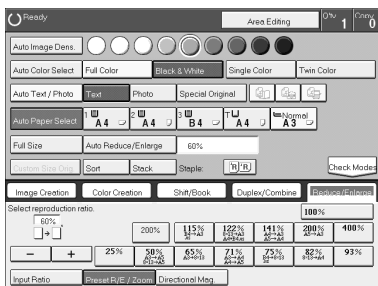

4 Set your originals, then press the [Start] key.

Using the number keys

1 Press the [Reduce/Enlarge] key.

2 Press the [Input Ratio] keys.

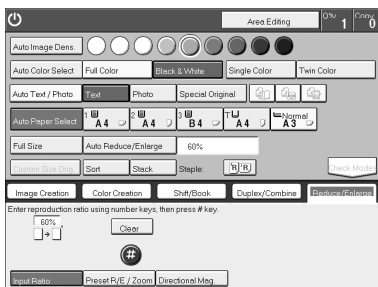

3 Enter the reproduction ratio with the number keys.

Note

To change the ratio entered, press the [Clear] key and enter a new ratio.

4 Press the [#] key.

5 Set your originals, then press the [Start] key.

Directional Magnification (%)

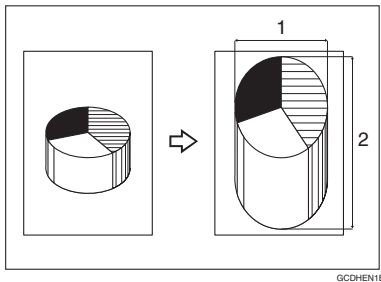

1. Horizontal %

2. Vertical %

Copies can be reduced or enlarged at different reproduction ratios horizontally and vertically.

Note

- You can select a ratio from between 25% to 400%.
- You can select a ratio regardless of the size of an original or copy paper. With some ratio, parts of the image might not be copied or blank margins might appear on copies.

1 Press the [Reduce/Enlarge] key.

2 Press the [Directional Mag.] key.

3 Make sure that the [Direct. Mag.(%)] key is selected.

4 Enter the horizontal ratio with the number keys, then press the [#] key.

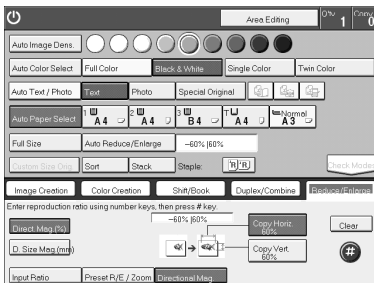

Note

- To change the ratio entered, press the [Clear] key and enter a new ratio.

5 Enter the vertical ratio with the number keys, then press the [#] key.

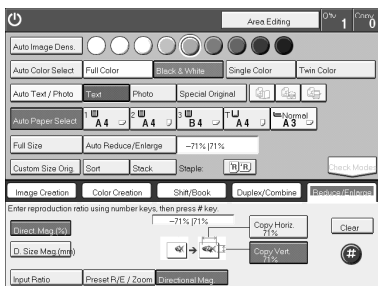

6 Set your originals, then press the [Start] key.

Directional Size Magnification (mm)

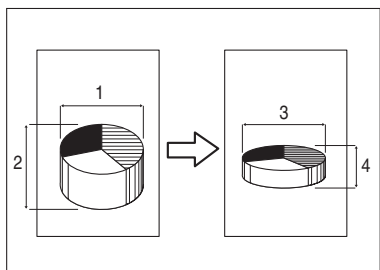

GCDHENGE

1. Horizontal original size
2. Vertical original size
3. Horizontal copy size
4. Vertical copy size

The suitable reproduction ratios will be automatically selected when you enter the horizontal and vertical lengths of the original and copy image you require.

Note

- You can enter sizes within the following ranges:

Metric Version	1 - 999mm (in 1mm steps)
Inch Version	0.1" - 99.9" (in 0.1" steps)

- If the calculated ratio is over the maximum or under the minimum ratio, it is corrected within the range of the ratio automatically. However, with some ratios, parts of the image might not be copied or blank margins might appear on copies.

- 1** Press the [Reduce/Enlarge] key.
- 2** Press the [Directional Mag.] key.
- 3** Press the [D. Size Mag.(mm)] key.
- 4** Enter the horizontal original size with the number keys, then press the [#] key.

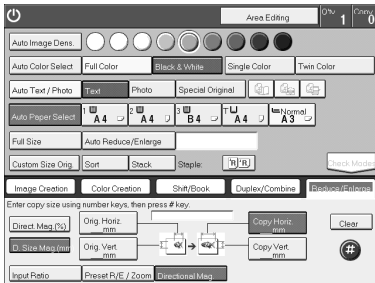

Note

- To change the value entered:
 - If you have not pressed the [#] key yet, press the [Clear] key and enter a new value.
 - If you have already pressed the [#] key, select the specified key and enter the a value.

- 5** Enter the horizontal copy paper size with the number keys, then press the [#] key.

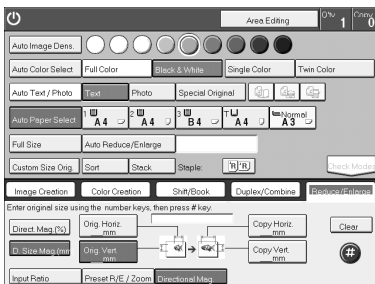

6 Enter the vertical original size with the number keys, then press the [#] key.

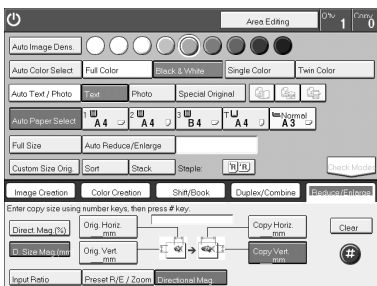

7 Enter the vertical copy paper size with the number keys, then press the [#] key.

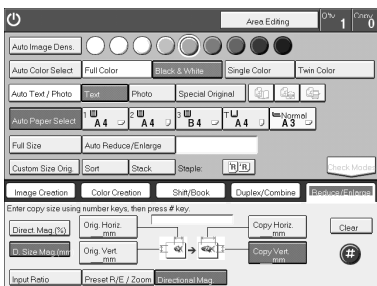

8 Set your originals, then press the [Start] key.

Duplex—Making 2 Sided Copies

1 Sided → 2 Sided

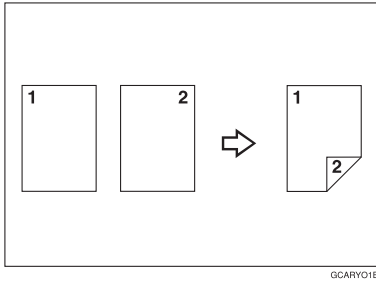

This function makes double sided copies from single sided originals.

⚠ Limitation

You cannot use the following kinds of copy paper with this function:

- Paper smaller than A5, $5\frac{1}{2}'' \times 8\frac{1}{2}''$
- Translucent paper
- Adhesive labels
- OHP transparencies
- Post Cards

📝 Note

The following paper limitations apply:

- Metric version

	Single color	Full color
Paper weight	64 - 105g/m ²	
maximum copy quantity	B4 or smaller: 50 sheets	A3 - A5: 20 sheets
	A3: 30 sheets	

- Inch version

	Single color	Full color
Paper weight	17 - 28 lb	
maximum copy quantity	$8\frac{1}{2}'' \times 14''$ or smaller: 50 sheets	$11'' \times 17'' - 5\frac{1}{2}'' \times 8\frac{1}{2}''$: 20 sheets
	$11'' \times 17''$: 30 sheets	

Note

- The image on the backside of copies is shifted by just the binding margin.
- You can change the width and position of the binding margin.
- You can change the default binding margin.

Reference

Regarding functions that cannot be used together with this function, ⇒ P.97 "Combination Chart".

❖ The resulting copy image will differ according to the direction in which you set your original (lengthwise or widthwise .

Originals	Orientation	Result*1

GCTVY1E

*1 The illustrations show the directions of copied images on the front and back, not the directions of delivery.

1 Press the [Duplex/Combine] key.

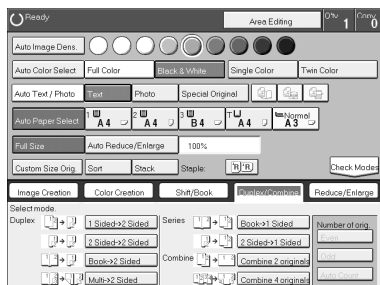

2 Press the [1 Sided→2 Sided] key.

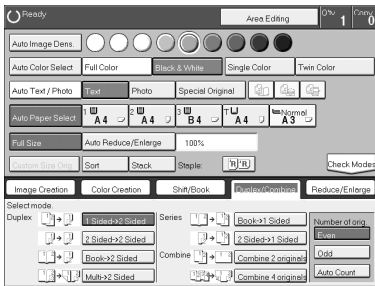

3 Press the [Even] key or the [Odd] key according to the number of your originals.

Note

- When you set an odd number originals, the back side of the last page is left blank.
- If you don't know the total number of originals, press the [Auto Count] key, then press the [Start Count] key.

The optional document feeder is required to use Auto Count function.

4 Press the [OK] key.

5 Set your originals in the document feeder, then press the [Start] key.

2 Sided → 2 Sided

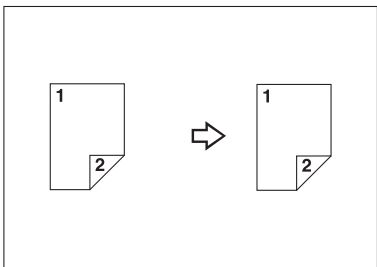

GCARYOZE

This function makes double sided copies from double sided originals.

1 Press the [Duplex/Combine] key.

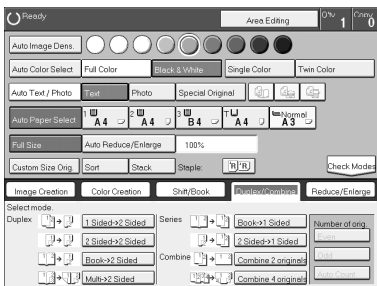

2 Press the [2 Sided→2 Sided] key.

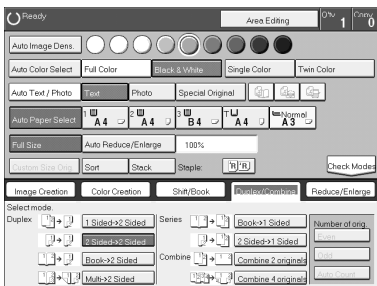

3 Set your originals in the document feeder, then press the [Start] key.

Book → 2 Sided

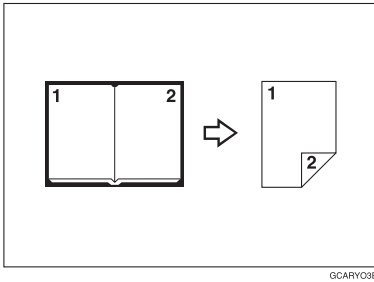







Use this feature to copy facing pages of a book or magazine onto both sides of the copy paper.





Note

- Select the lengthwise  copy paper.
- The following table summarizes the relationship between the size of originals and copy paper size for full-size copying.

- Metric version

Original	Copy Paper
A3 	A4  (2-sided)
B4 	B5  (2-sided)
A4 	A5  (2-sided)

- Inch version

Original	Copy Paper
11" × 17" 	8½" × 11"  (2-sided)
8½" × 11" 	5½" × 8½"  (2-sided)

1 Press the [Duplex/Combine] key.

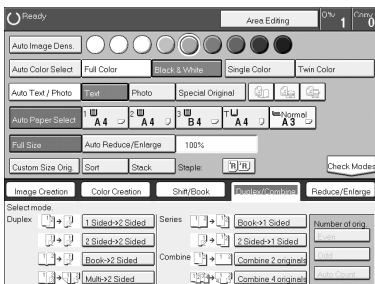

2 Select the lengthwise  copy paper.

3 Press the [Book→2 Sided] key.

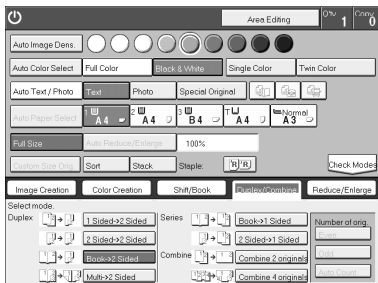

4 Set your original on the exposure glass, then press the [Start] key.

Multi → 2 Sided

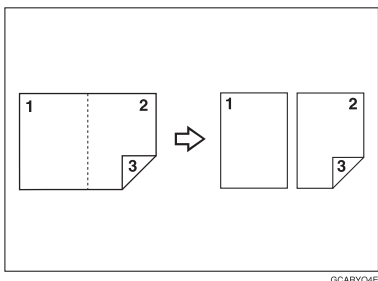







This function makes one single sided and one double sided copy from a three page pamphlet.





Note

The following table summarizes the relationship between the size of originals and copy paper size for full-size copying (100%).

- Metric version

Original	Copy Paper
A3 	A4  (2-sided)
B4 	B5  (2-sided)
A4 	A5  (2-sided)

- Inch version

Original	Copy Paper
11" × 17" 	8 ¹ / ₂ " × 11"  (2-sided)
8 ¹ / ₂ " × 11" 	5 ¹ / ₂ " × 8 ¹ / ₂ "  (2-sided)

- 1 Press the [Duplex/Combine] key.

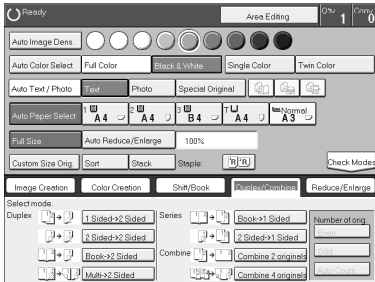

- 2 Select lengthwise  copy paper.

- 3 Press the [Multi→2 Sided] key.

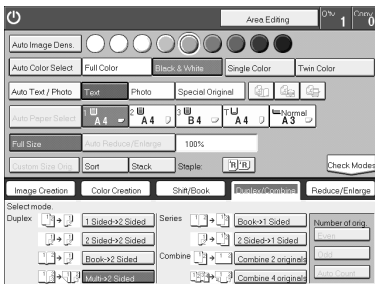

- 4 Set your originals in the document feeder, then press the [Start] key.

Series Copies

Book → 1 Sided

2

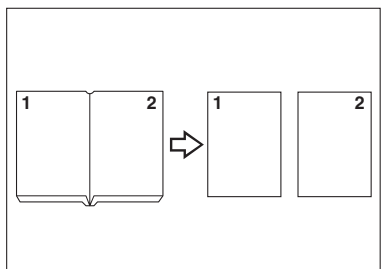

GCSEPR1E

This function makes one-sided copies from two facing pages of bound (book) originals.

Reference

Regarding functions that cannot be used together with this function, ⇒ P.97 "Combination Chart".

Note

The following table summarizes the relationship between the size of originals and copy paper size for full-size copying (100%).

- Metric version

Original	Copy Paper
A3 ☐	A4 ☐ × 2 sheets
B4 ☐	B5 ☐ × 2 sheets
A4 ☐	A5 ☐ × 2 sheets

- Inch version

Original	Copy Paper
11" × 17" ☐	8 ¹ / ₂ " × 11" ☐ × 2 sheets
8 ¹ / ₂ " × 11" ☐	5 ¹ / ₂ " × 8 ¹ / ₂ " ☐ × 2 sheets

1 Press the [Duplex/Combine] key.

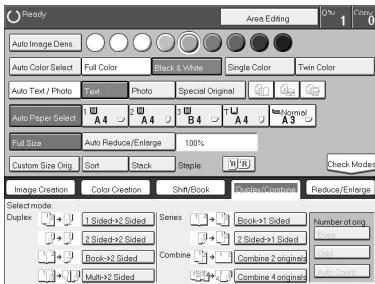

2 Select lengthwise  copy paper.

3 Press the [Book→1 Sided] key.

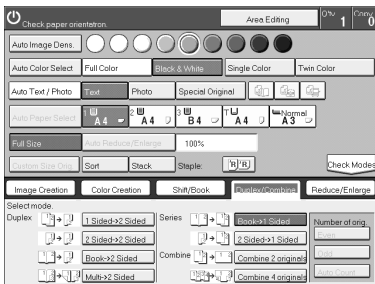

4 Set your originals, then press the [Start] key.

2

2 Sided → 1 Sided

The optional document feeder is required to use this function.

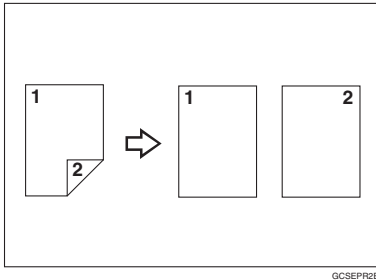

GCSEPRZE

Reference

Regarding functions that cannot be used together with this function, ⇒ P.97 "Combination Chart".

1 Press the [Duplex/Combine] key.

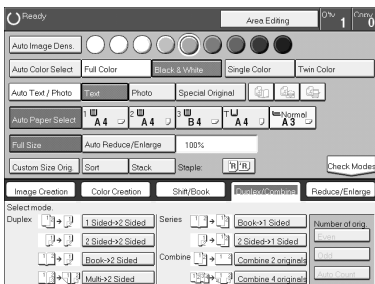

2 Select lengthwise copy paper.

3 Press the [2 Sided→1 Sided] key.

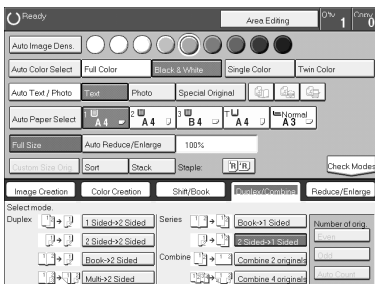

4 Set your originals in the document feeder, then press the [Start] key.

Combine

Combine 2 Originals

The optional document feeder is required to use this function.

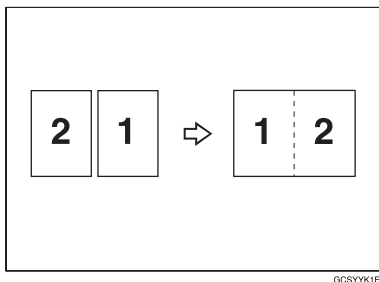

This function automatically combines two single sided originals onto one copy.

Note

- If the original size and direction is set differently, you cannot use the combine function.
- When you use the combine function, Auto Reduce/Enlarge is selected automatically.

Reference

Regarding functions that cannot be used together with this function, ⇒ P.97 “Combination Chart”.

Setting originals (Originals set in the document feeder)

- Originals reading from left to right

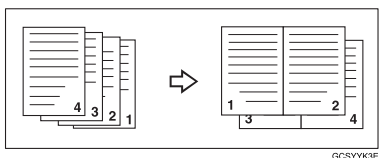

- Originals reading from top to bottom

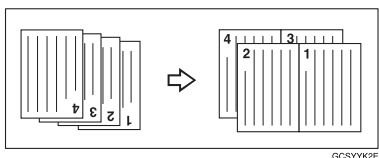

1 Press the [Duplex/Combine] key.

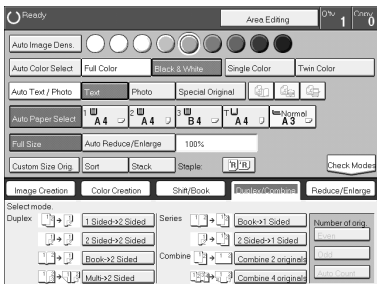

2 Select widthwise copy paper.

3 Press the [Combine 2 originals] key.

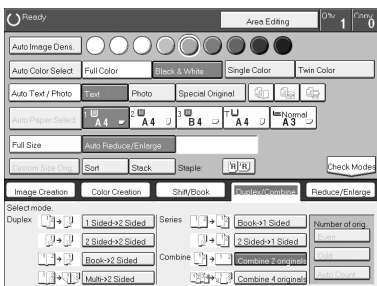

4 Set your originals in the document feeder, then press the [Start] key.

Combine 4 Originals

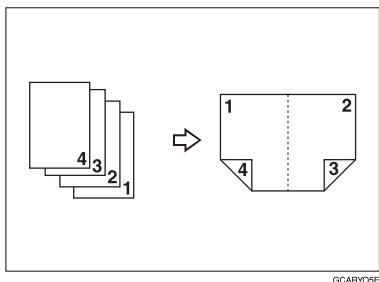

GCARV05E

Reference

Regarding functions that cannot be used together with this function, ⇒ P.97 "Combination Chart".

1 Press the [Duplex/Combine] key.

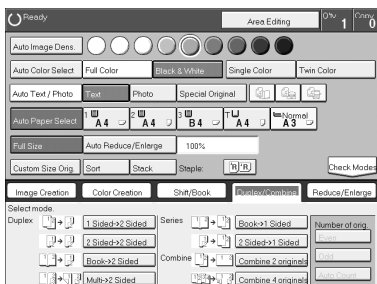

2 Select widthwise copy paper.

3 Press the [Combine 4 originals] key.

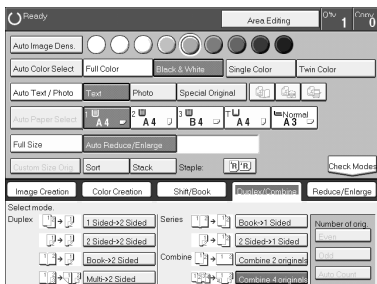

4 Set your originals in the document feeder, then press the [Start] key.

Shifting the Image

Shift

2

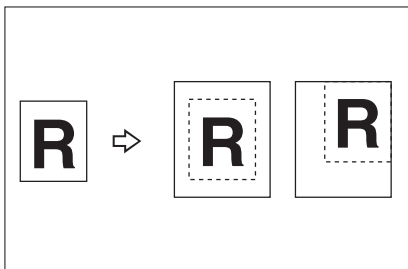

GCIB043E

You can move the image to a corner or edge as well as center it. This function is useful when the copy paper is larger than the original.

Note

- You cannot use 12" × 18" size copy paper for this function.

1 Press the [Shift/Book] key.

2 Press the [Shift] key.

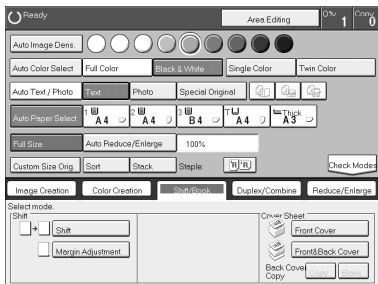

3 Select the direction in which you want to shift the image.

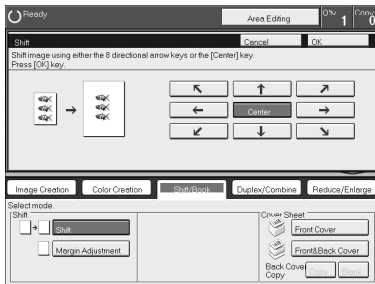

Note

- When you want to center the image, press the **[Center]** key.

4 Press the **[OK]** key.

5 Select the copy paper size.

6 Set your originals, then press the **[Start]** key.

Margin Adjustment

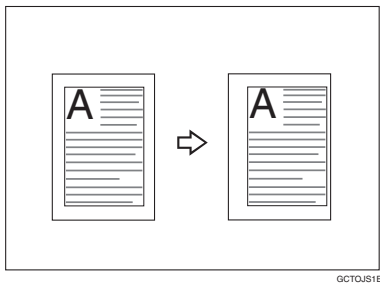

GCTQJSTE

You can make a margin by shifting the image to the left or right. This function is useful when you want to bind copies.

Note

- You can change the width of the binding margin as follows:

Metric Version	0 - 20mm (in 1mm steps)
Inch Version	0" - 0.8" (in 0.1" steps)

- ❑ The margin width default is as follows. You can change this default setting with the user tools. ⇒ P.179 “General Features”.

Metric Version	<ul style="list-style-type: none"> • Front: 0mm Left • Back: 0mm Right
Inch Version	<ul style="list-style-type: none"> • Front: 0" Left • Back: 0" Right

2

- ❑ If you set too wide a margin, areas you do not want to delete might be erased.

🔍 Reference

Regarding functions that cannot be used together with this function, ⇒ P.97 “Combination Chart”.

1 Press the [Shift/Book] key.

2 Press the [Margin Adjustment] key.

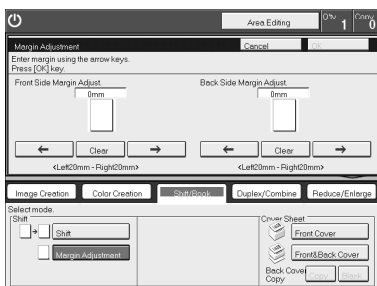

3 Enter the margins for the front side and back side of the copy paper.

📎 Note

- ❑ To change the value entered, press the [Clear] key and enter a new value.
- ❑ To make a left margin, press the [→] key until the number displayed reaches the required setting.
- ❑ To make a right margin, press the [←] key until the number displayed reaches the required setting.

4 Press the [OK] key.

5 Set your originals, then press the [Start] key.

Cover Sheet

Front Cover

The optional document feeder is required to use this function.

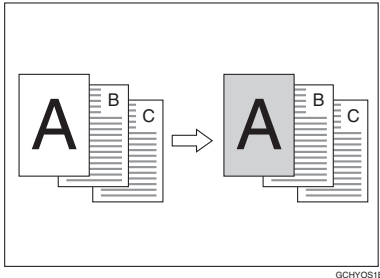

GCHYOS1E

Note

- The cover sheets should be identical in size and direction with the copy paper.
- The cover sheets should be fed from the bypass tray.
- The covers are copied in Thick mode.

Reference

Regarding functions that cannot be used together with this function, ⇒ P.97 "Combination Chart".

When you use front cover mode with 1 Sided → 1 Sided mode

1 Press the [Shift/Book] key.

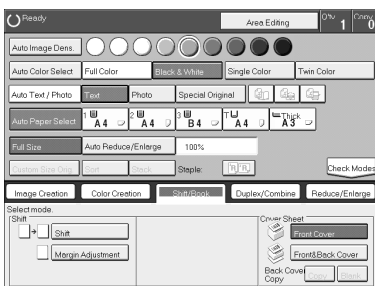

2 Press the [Front Cover] key.

3 Set your originals in the document feeder, then press the [Start] key.

When you use Front Cover mode with 2 Sided → 1 Sided or 2 Sided → 2 Sided mode

- 1** Enter 2 Sided→1 Sided or 2 Sided→2 Sided mode. ⇒ P.72 “2 Sided →1 Sided” or ⇒ P.66 “2 Sided →2 Sided”.
- 2** Follow steps **1** to **2** on ⇒ P.79 “When you use front cover mode with 1 Sided →1 Sided mode”.
- 3** Select [Image] or [Blank] key depending on the reverse side of first original has an image or not.

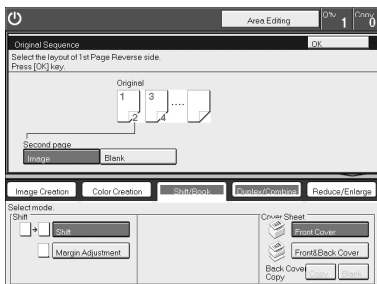

- 4** Press the [OK] key.
- 5** Set your originals in the document feeder, then press the [Start] key.

Front and Back Cover

The optional document feeder is required to use this function.

◆ Back Cover: Copy

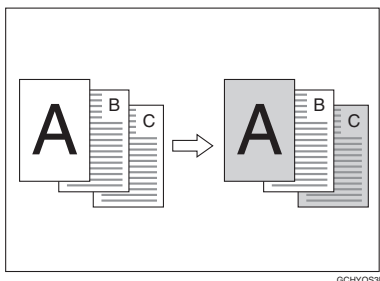

GCHY033E

◆ Back Cover: Blank

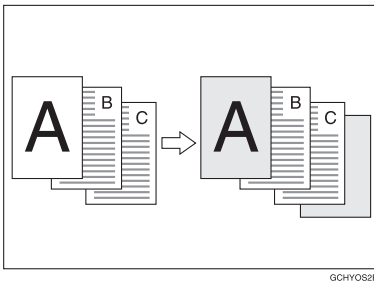

GCHYOSZE

Note

- You can specify whether to copy onto the back cover sheet. If you select **[Copy]**, the last pages will be copied onto the back cover sheet. If you select **[Blank]**, a cover sheet will just be inserted after the last copy.
- The cover sheets should be identical in size and direction to the copy paper.
- The cover sheets should be fed from the bypass tray.
- The covers are copied in Thick mode.
- If Blank Cover mode is selected, the back cover will not be counted as a copy.

Reference

Regarding functions that cannot be used together with this function, ⇒ P.97 "Combination Chart".

When you use Front & Back covers mode with 1 Sided → 1 Sided mode

1 Press the **[Shift/Book]** key.

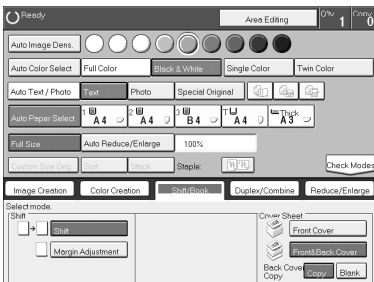

2 Press the **[Front&Back Cover]** key.

3 Press the **[Copy]** or **[Blank]** key to choose whether to copy onto the back cover.

4 Set your originals in the document feeder.

5 Press the **[Start]** key.

When you use Front & Back Covers mode with 2 Sided → 1 Sided or 2 Sided → 2 Sided mode

1 Enter 2 Sided→1 Sided or 2 Sided→2 Sided mode. ⇒ P.72 “2 Sided → 1 Sided” or ⇒ P.66 “2 Sided → 2 Sided”.

2 Follow steps **1** to **3** in the previous procedure.

3 Press the [Image] or [Blank] key depending on whether the reverse side of the first original has an image or not.

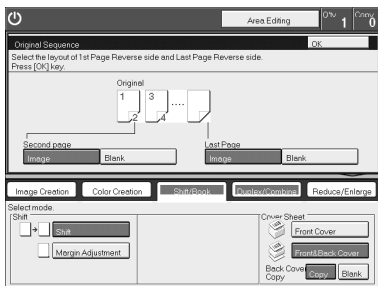

4 Press the [Image] or [Blank] key depending on whether the reverse side of last original has an image or not.

5 Press the [OK] key.

6 Follow steps **4** and **5** in the previous procedure.

Color Creation

Color Conversion

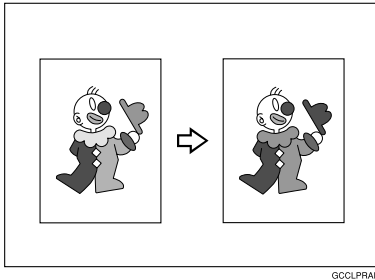

This function converts selected colors of an original into different colors on the copy.

Note

- Up to 4 colors can be converted at one time.
- Colors you can convert: Yellow, Red, Magenta, Green, Cyan, Blue, Black, White.
- Colors that can be converted to: Yellow, Orange, Red, Magenta, Green, Cyan, Blue, Yellow Green, Black, White, Beige, Pink, Marine Blue, Purple and User colors.
- This function can be made more or less sensitive to the color to be converted. It can be adjusted within five levels from "Narrow" to "Wide". ⇒ P.108 "Image Adjustment". For example, if red is selected as the color to be converted, "Narrow" will result in only red being converted, and "Wide" will result in other colors close to red being converted.
- This function can be used in Full Color mode.

1 Press the [Color Creation] key.

2 Press the [Color Conversion] key.

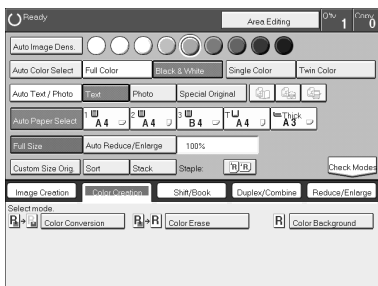

3 Select the original color (color to be converted).

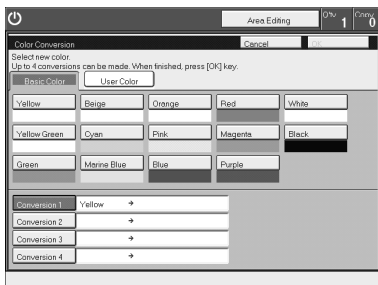

4 Select the new color (color to convert to).

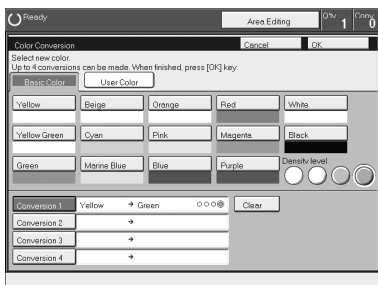

5 If you want to convert more than one color, repeat steps **3** and **4**.

Note

❑ If you pick the wrong color, press the [Clear] key.

6 Press the [OK] key.

7 Set your originals, then press the [Start] key.

Color Erase

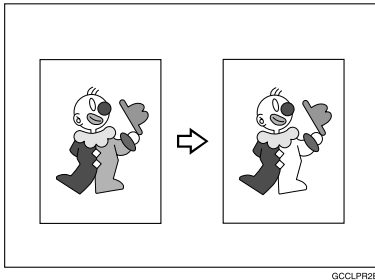

This function erases selected colors from the original image.

Note

- Up to 4 colors can be erased at one time.
- Colors that can be erased: Yellow, Red, Magenta, Green, Cyan, Blue and Black.
- This function can be made more or less sensitive to the color to be erased. It can be adjusted within five levels from "Narrow" to "Wide". ⇒ P.108 "Image Adjustment". For example, if red is selected as the color to be erased, "Narrow" will result in only red being erased, and "Wide" will result in other colors close to red being erased.

1 Press the [Color Creation] key.

2 Press the [Color Erase] key.

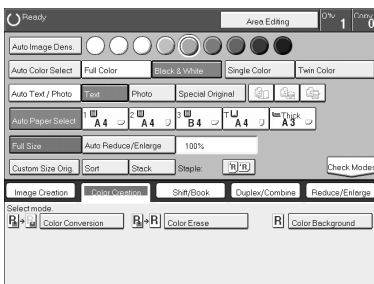

3 Select the color to be erased.

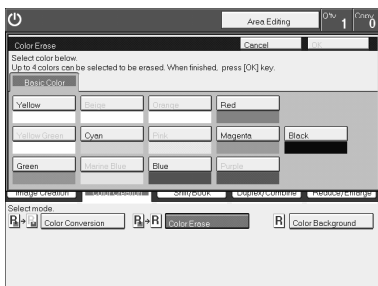

4 Press the [OK] key

5 Set your originals, then press the [Start] key.

Color Background

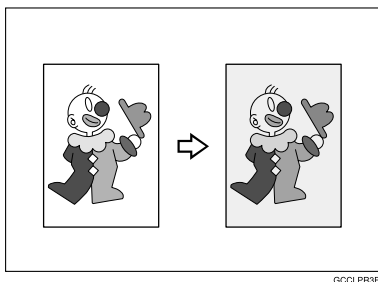

This function makes copies with the selected color background.

Note

- Colors that can be selected as a background color: Yellow, Orange, Red, Magenta, Green, Cyan, Blue, Yellow Green, Black, Beige, Pink, Marine Blue, Purple and User Colors.
- In this mode, color tones of photos or pictures might be changed depending on the color on the background.

1 Press the [Color Creation] key.

2 Press the [Color Background] key.

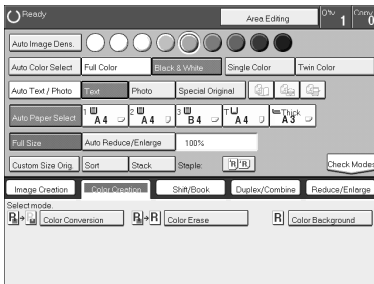

3 Select the color for the background.

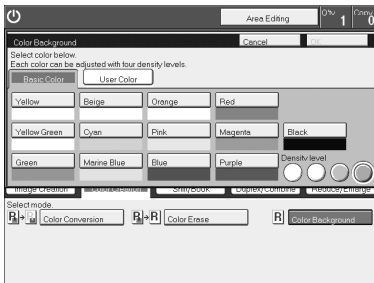

Note

- You can select the color density level.

4 Press the [OK] key

5 Set your originals, then press the [Start] key.

2

Image Creation

Mirror

2

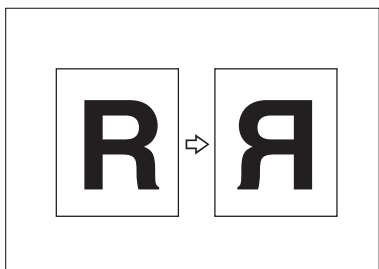

GCM111E

This function makes a mirror image copy of the original.

 **Note**

- If set the original as below when setting on the exposure glass.

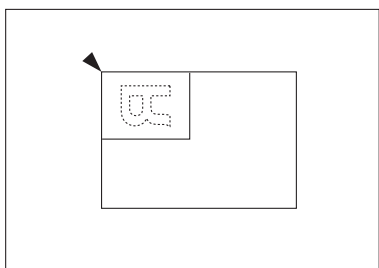

GCM112E

1 Press the [Image Creation] key.

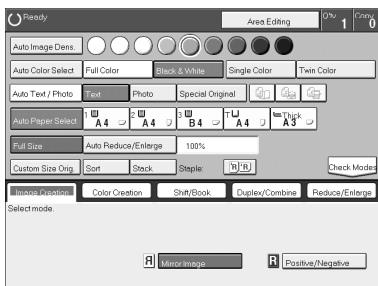

2 Press the [Mirror Image] key.

3 Set your originals, then press the [Start] key.

Positive/Negative

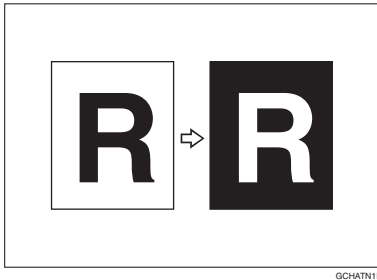

This function copies the original image in complementary colors. If you use a black and white original, black and white areas of the original are reversed.

- 1** Press the [Image Creation] key.
- 2** Press the [Positive/Negative] key.

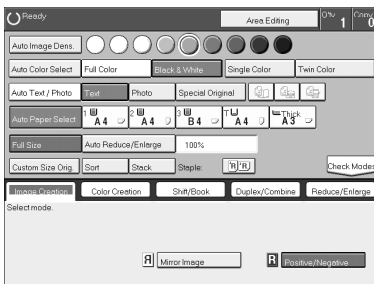

- 3** Set your originals, then press the [Start] key.

Finishing

Note

- To avoid problems caused by curled copies, try turning over the paper stack in the paper tray. If there is no improvement, change to copy paper with less curl.

Reference

Regarding functions that cannot be used together with this function, ⇒ P.97 "Combination Chart".

Sort

The optional 20-bin sorter stapler, 10-bin sorter stapler or 3-bin sotrer is required to use this function.

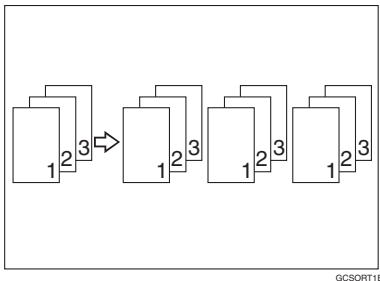

One copy of each original is delivered to each bin and copies are collated into sets.

Note

- ❑ It is recommended to set originals in the document feeder with this function.
- ❑ For sorting, the following limitations apply:

	20-bin sorter stapler		10-bin sorter stapler	3-bin sorter stapler	
	Normal paper mode	Thick mode		1 st bin	2 nd or 3 rd bin
Maximum paper size	☞: A3, 12" × 18" ☞: A4, 8 ¹ / ₂ " × 11"	☞: A3, 12" × 18" ☞: A4, 8 ¹ / ₂ " × 11"	☞: A3, 11" × 17" ☞: A4, 8 ¹ / ₂ " × 11"	☞: A3, 12" × 18" ☞: A4, 8 ¹ / ₂ " × 11"	☞: A3, 12" × 18" ☞: A4, 8 ¹ / ₂ " × 11"
Minimum paper size	☞: B5, 8" × 11" ☞: B5, 8 ¹ / ₂ " × 11"	☞: B5, 8" × 11" ☞: B5, 8 ¹ / ₂ " × 11"	☞: B5, 8" × 11" ☞: B5, 8 ¹ / ₂ " × 11"	☞: A6, 5 ¹ / ₂ " × 8 ¹ / ₂ " ☞: A5, 8 ¹ / ₂ " × 11"	☞: A6, 5 ¹ / ₂ " × 8 ¹ / ₂ " ☞: A5, 8 ¹ / ₂ " × 11"
Maximum paper capacity of bins (80g/m ² , 20 lb)	A4, 8 ¹ / ₂ " × 11" or smaller: 30 sheets B4, 8" × 13" or larger: 25 sheets	A4, 8 ¹ / ₂ " × 11" or smaller: 15 sheets B4, 8" × 13" or larger: 12 sheets	A4, 8 ¹ / ₂ " × 11" or smaller: 30 sheets B4, 8" × 13" or larger: 25 sheets	A4, 8 ¹ / ₂ " × 11" or smaller: 500 sheets B4, 8" × 13" or larger: 250 sheets	A4, 8 ¹ / ₂ " × 11" or smaller: 250 sheets B4, 8" × 13" or larger: 125 sheets

- ❑ When you have the 3-bin sorter or 10-bin sorter stapler, you cannot use thick paper fed from the bypass tray in Sort mode.
- ❑ When you have the 10-bin sorter stapler, 12" × 18" size paper cannot be used.
- ❑ You cannot use OHP transparencies or custom size paper in Sort mode.
- ❑ You can make the machine select Sort mode automatically when you insert two or more originals in the document feeder and make two or more copies from each original. ⇒ P.184 "Duplex/ADF/Sorter".

1 Press the [Sort] key.

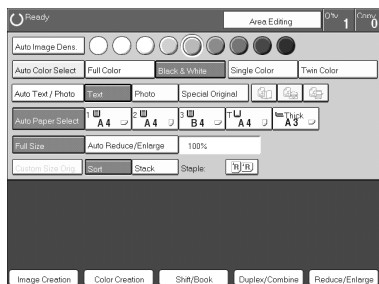

2 Set your originals in the document feeder.

3 Press the [Start] key.

Stack

The optional 20-bin sorter stapler, 10-bin sorter or 3-bin sorter is required to use this function.

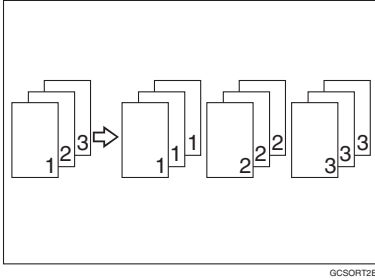

All copies of each original are delivered to the same bin.

Note

- For stacking, the following limitations apply:

	20-bin sorter stapler		10-bin sorter stapler	3-bin sorter stapler	
	Normal paper mode	Thick mode		1 st bin	2 nd or 3 rd bin
Maximum paper size	☐: A3, 12" × 18" ☐: A4, 8 ¹ / ₂ " × 11"	☐: A3, 12" × 18" ☐: A4, 8 ¹ / ₂ " × 11"	☐: A3, 11" × 17" ☐: A4, 8 ¹ / ₂ " × 11"	☐: A3, 12" × 18" ☐: A4, 8 ¹ / ₂ " × 11"	☐: A3, 12" × 18" ☐: A4, 8 ¹ / ₂ " × 11"
Minimum paper size	☐: B5, 8" × 11" ☐: B5, 8 ¹ / ₂ " × 11"	☐: B5, 8" × 11" ☐: B5, 8 ¹ / ₂ " × 11"	☐: B5, 8" × 11" ☐: B5, 8 ¹ / ₂ " × 11"	☐: A6, 5 ¹ / ₂ " × 8 ¹ / ₂ " ☐: A5, 8 ¹ / ₂ " × 11"	☐: A6, 5 ¹ / ₂ " × 8 ¹ / ₂ " ☐: A5, 8 ¹ / ₂ " × 11"
Maximum paper capacity of bins (80g/m ² , 20 lb)	A4, 8 ¹ / ₂ " × 11" or smaller: 25 sheets B4, 8" × 13" or larger: 20 sheets	A4, 8 ¹ / ₂ " × 11" or smaller: 12 sheets B4, 8" × 13" or larger: 10 sheets	A4, 8 ¹ / ₂ " × 11" or smaller: 25 sheets B4, 8" × 13" or larger: 20 sheets	A4, 8 ¹ / ₂ " × 11" or smaller: 500 sheets B4, 8" × 13" or larger: 250 sheets	A4, 8 ¹ / ₂ " × 11" or smaller: 250 sheets B4, 8" × 13" or larger: 125 sheets

- When you have the 3-bin sorter or 10-bin sorter stapler, you cannot use thick paper fed from the bypass tray in Stack mode.
- When you have the 10-bin sorter stapler, 12" × 18" size paper cannot be used.
- You cannot use OHP transparencies or custom size paper in Stack mode.

1 Press the [Stack] key.

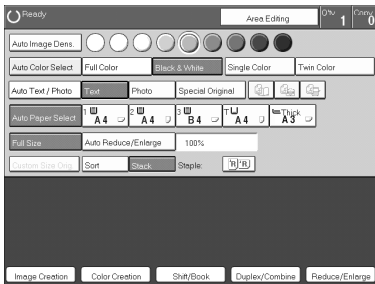

2 Set your originals in the document feeder.

3 Press the [Start] key.

Staple

The optional 20-bin sorter, 10-bin sorter stapler is required to use this function.

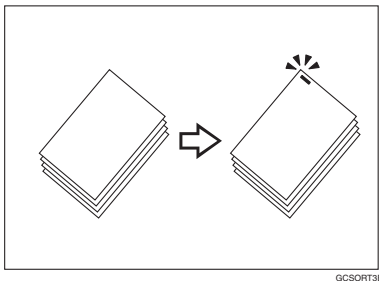

GCSORTSE

Each copy set can be stapled together.

Note

- Since the image is rotated, if the direction of the original and paper direction differ, the staples might not be in the desired position.
- When you select Staple mode, Sort mode is automatically selected.
- You cannot use Staple mode with Stack mode.
- When you have the 10-bin sorter stapler, you cannot use thick paper fed from the bypass tray in Staple mode.
- You cannot use OHP transparencies or custom size paper in Staple mode.
- You cannot staple different widths of paper.

2

- The relationship between the orientation in which the original is set and the stapling position is shown below.

Orientation of original		Stapling position		
	Exposure glass	Document feeder	20-bin sorter stapler	10-bin sorter stapler
□				
□				

- For stapling, the following limitations apply:

	20-bin sorter stapler		10-bin sorter stapler
	Normal paper mode	Thick paper mode	
Maximum paper size	□: A3, 11" × 17" □: A4, 8 ¹ / ₂ " × 11"	□: A3, 11" × 17" □: A4, 8 ¹ / ₂ " × 11"	□: A3, 11" × 17" □: A4, 8 ¹ / ₂ " × 11"
Minimum paper size	□: B5, 8 ¹ / ₂ " × 11" □: B5, 8 ¹ / ₂ " × 11"	□: B5, 8 ¹ / ₂ " × 11" □: B5, 8 ¹ / ₂ " × 11"	□: B5, 8 ¹ / ₂ " × 11" □: B5, 8 ¹ / ₂ " × 11"
Stapler capacity (80g/m ² , 20 lb)	20 sheets	10 sheets	20 sheets

Reference

If you want to add staples, ⇒ P.164 “ Adding Staples”.

When the stapler is jammed, ⇒ P.166 “ Removing Jammed Staples”.

Changing the staple position

If your machine is equipped with the 20-bin sorter stapler, you can select one of two stapling positions by changing the position of the stapler. Open the front cover of the sorter stapler and perform the actions illustrated below.

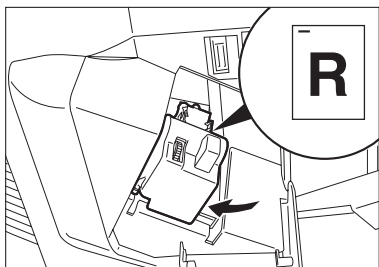
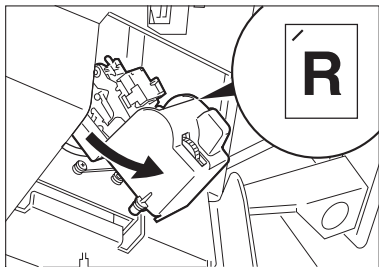

Note

- After changing the position of the stapler should be clicked in position.

Having copies stapled automatically after copying

The optional document feeder is required to use this function.

- 1** Press the  key.
- 2** Set your originals in the document feeder.

3 Press the **[Start]** key.

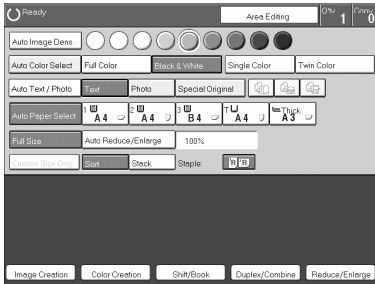

2

Stapling copies manually after copying

1 After Sort mode copying is completed, press the **[R|R]** key.

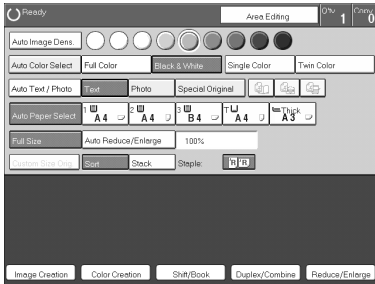

Combination Chart

- ☆ Those modes can be used together.
- ★ Those modes can be used together with some limitations.
- The original mode is overridden and the newly selected mode is active.
- × These modes cannot be used together.
- *1 20-bin sorter stapler. ☆
10-bin sorter stapler. ×
- *2 20-bin sorter stapler. →
10-bin sorter stapler. ×

2

Newly Selected Mode		Original Mode	
Image Density	Auto Image Density	☆	↓ ☆
	Manual Image Density	↓ ☆	☆
Color Mode	Auto Color Select	×	↓ ☆
	Full Color	↓ ☆	↓ ☆
	Black & White	↓ ☆	↓ ☆
	Single Color	↓ ☆	↓ ☆
	Twin Color	↓ ☆	↓ ☆
	Auto Text/Photo	↓ ☆	↓ ☆
	Text	↓ ☆	↓ ☆
	Photo	↓ ☆	↓ ☆
	Special Original	↓ ☆	↓ ☆
	Photo Type Selection	×	×
Bypass Feed Copying	Auto Paper Select	×	×
	Copying from Paper Trays	☆	☆
	Standard size paper	☆	☆
	Custom size paper	☆	☆
	Normal paper	☆	☆
	Thick paper	☆	☆
	OHP	☆	☆
	OHP Slip Sheet	☆	☆
	A3 Fullbleed Copying	☆	☆
	Duplex Back	☆	☆
	Auto Reduce/Enlarge	☆	☆
	Custom Size Original	☆	☆
	Sort	☆	★
	Stack	☆	★
	Auto Staple	☆	★
Manual Staple	☆	☆	

		Newly Selected Mode			
Shift/Book	Centering/Cornering	☆	☆		
	Cover Sheet	☆	☆		
Reduce/Enlarge	Margin Adjustment	☆	☆		
	Directional Magnification (mm)	☆	☆		
	Directional Magnification (%)	☆	☆		
Image Creation	Zoom	☆	☆		
	Preset Reduce/Enlarge	☆	☆		
Color Creation	Mirror Image	☆	☆		
	Color Background	☆	☆		
	Color Erase	☆	☆		
Finishing	Color Conversion	☆	☆		
	Staple	☆	☆		
	Stack	☆	☆		
Paper Selection	Sort	☆	☆		
	Auto Reduce/Enlarge	☆	☆		
	Duplex Back	☆	☆		
Bypass Feed Copying	Custom size paper	☆	☆		
	Standard size paper	☆	☆		
	A3 Fullbleed Copying	Normal	☆	☆	
		Thick	☆	☆	
		OHP	☆	☆	
		OHP Slip Sheet	☆	☆	
	Original Mode	Auto Paper Select	☆	☆	
		Copying from Paper Trays	Normal	☆	☆
			Thick	☆	☆
			OHP	☆	☆
OHP Slip Sheet			☆	☆	
Bypass Feed Copying		Auto Image Density	☆	☆	
		Manual Image Density	☆	☆	
		Auto Color Select	☆	☆	
		Full Color	☆	☆	
		Black & White	☆	☆	
	Single Color	☆	☆		
	Twin Color	☆	☆		
	Auto Text/Photo	☆	☆		
	Text	☆	☆		
	Photo	☆	☆		
Special Original	☆	☆			
Photo Type Selection	☆	☆			
Auto Paper Select	☆	☆			
Copying from Paper Trays	☆	☆			
Standard size paper	☆	☆			
Custom size paper	☆	☆			
Normal paper	☆	☆			
Thick paper	☆	☆			
OHP	☆	☆			
OHP Slip Sheet	☆	☆			
A3 Fullbleed Copying	☆	☆			
Duplex Back	☆	☆			
Auto Reduce/Enlarge	☆	☆			
Custom Size Original	☆	☆			
Sort	☆	☆			
Stack	☆	☆			
Auto Staple	☆	☆			
Manual Staple	☆	☆			

		Newly Selected Mode										
Image Density	Auto Image Density	☆	☆	☆	☆	☆	☆	☆	☆	☆	☆	
	Manual Image Density	☆	☆	☆	☆	☆	☆	☆	☆	☆	☆	
Color Mode	Auto Color Select	★	★	×	×	×	×	×	×	×	×	
	Full Color	☆	☆	☆	☆	☆	☆	☆	☆	☆	☆	
	Black & White	★	☆	☆	☆	☆	☆	☆	☆	☆	☆	
	Single Color	★	☆	☆	☆	☆	☆	☆	☆	☆	☆	
	Twin Color	★	×	☆	☆	☆	☆	☆	☆	☆	☆	
Original Image Type	Auto Text/Photo	☆	☆	☆	☆	☆	☆	☆	☆	☆	☆	
	Text	☆	☆	☆	☆	☆	☆	☆	☆	☆	☆	
	Photo	☆	☆	☆	☆	☆	☆	☆	☆	☆	☆	
	Special Originals	☆	☆	☆	☆	☆	☆	☆	☆	☆	☆	
Paper Selection	Auto Paper Select	☆	☆	☆	☆	☆	☆	☆	☆	☆	☆	
	Copying from Paper Trays	Normal	☆	☆	☆	☆	☆	☆	☆	☆	☆	☆
		Thick	☆	☆	☆	☆	☆	☆	☆	☆	☆	☆
		OHP	☆	☆	☆	☆	☆	☆	☆	☆	☆	☆
		OHP Slip Sheet	☆	☆	☆	☆	☆	☆	☆	☆	☆	☆
		Standard size paper	☆	☆	☆	☆	☆	☆	☆	☆	☆	☆
	Bypass Feed Copying	Normal	☆	☆	☆	☆	☆	☆	☆	☆	☆	☆
		Thick	☆	☆	☆	☆	☆	☆	☆	☆	☆	☆
	A3 Fullbleed Copying	☆	☆	☆	☆	☆	☆	☆	☆	☆	☆	
	Duplex Back	☆	☆	☆	☆	☆	☆	☆	☆	☆	☆	
Auto Reduce/Enlarge	☆	☆	☆	☆	☆	☆	☆	☆	☆	☆		
Custom Size Original	☆	☆	☆	☆	☆	☆	☆	☆	☆	☆		
Finishing	Sort	☆	☆	☆	☆	☆	☆	☆	☆	☆	☆	
	Stack	☆	☆	☆	☆	☆	☆	☆	☆	☆	☆	
	Staple	☆	☆	☆	☆	☆	☆	☆	☆	☆	☆	
Original Mode	Color Conversion	☆	☆	☆	☆	☆	☆	☆	☆	☆	☆	
	Color Erase	☆	☆	☆	☆	☆	☆	☆	☆	☆	☆	
	Color Background	☆	☆	☆	☆	☆	☆	☆	☆	☆	☆	
	Mirror Image	☆	☆	☆	☆	☆	☆	☆	☆	☆	☆	
	Positive/Negative	★	☆	☆	☆	☆	☆	☆	☆	☆	☆	
	Preset Reduce/Enlarge	☆	☆	☆	☆	☆	☆	☆	☆	☆	☆	
	Zoom	☆	☆	☆	☆	☆	☆	☆	☆	☆	☆	
	Directional Magnification (%)	☆	☆	☆	☆	☆	☆	☆	☆	☆	☆	
	Directional Size Magnification (mm)	☆	☆	☆	☆	☆	☆	☆	☆	☆	☆	
	Margin Adjustment	☆	☆	☆	☆	☆	☆	☆	☆	☆	☆	
	Centering/Comering	☆	☆	☆	☆	☆	☆	☆	☆	☆	☆	
	Cover Sheet	☆	☆	☆	☆	☆	☆	☆	☆	☆	☆	
	Book → 1 Sided	☆	☆	☆	☆	☆	☆	☆	☆	☆	☆	
	2 Sided → 1 Sided	☆	☆	☆	☆	☆	☆	☆	☆	☆	☆	
	Combine 2 originals	☆	☆	☆	☆	☆	☆	☆	☆	☆	☆	
	Combine 4 originals	☆	☆	☆	☆	☆	☆	☆	☆	☆	☆	
	1 Sided → 2 Sided	☆	☆	☆	☆	☆	☆	☆	☆	☆	☆	
2 Sided → 2 Sided	☆	☆	☆	☆	☆	☆	☆	☆	☆	☆		
Book → 2 Sided	☆	☆	☆	☆	☆	☆	☆	☆	☆	☆		
Multi → 2 Sided	☆	☆	☆	☆	☆	☆	☆	☆	☆	☆		
Program User Color	☆	☆	☆	☆	☆	☆	☆	☆	☆	☆		
Image Adjustment	☆	☆	☆	☆	☆	☆	☆	☆	☆	☆		
Color Adjustment	☆	☆	☆	☆	☆	☆	☆	☆	☆	☆		
Color Balance Adjustment	☆	☆	☆	☆	☆	☆	☆	☆	☆	☆		
Program	☆	☆	☆	☆	☆	☆	☆	☆	☆	☆		
Interrupt Copying	☆	☆	☆	☆	☆	☆	☆	☆	☆	☆		

Newly Selected Mode		Original Mode	
Program	After recalling your settings	☆	☆
	Color Balance Adjustment	☆	☆
Color Adjustment	Color Adjustment	☆	☆
	Image Adjustment	☆	☆
Image A Adjustment	Auto Text/Photo Sensitivity	☆	☆
	A.C.S Sensitivity	☆	☆
U.C.R. Adjustment	U.C.R. Adjustment	☆	☆
	Pastel	☆	☆
Background Density	Background Density	☆	☆
	Contrast	☆	☆
Soft/Sharp	Soft/Sharp	☆	☆
	Program User Color	☆	☆
Multi → 2 Sided	Multi → 2 Sided	☆	☆
	Book → 2 Sided	☆	☆
Duplex	Book → 2 Sided	☆	☆
	2 Sided → 2 Sided	☆	☆
Combine	Combine 4 originals	☆	☆
	Combine 2 originals	☆	☆
Series	2 Side → 1 Sided	☆	☆
	Book → 1 Sided	☆	☆
Shift/Book	Cover Sheet	☆	☆
	Centering/Cornering	☆	☆
Margin Adjustment	Margin Adjustment	☆	☆
	Directional Size Magnification (mm)	☆	☆
Reduce/Enlarge	Directional Magnification (%)	☆	☆
	Zoom	☆	☆
Image Creation	Presets Reduce/Enlarge	☆	☆
	Mirror Image	☆	☆
Image Creation	Mirror Image	☆	☆
	Positive/Negative	☆	☆
Color Creation	Color Background	☆	☆
	Color Erase	☆	☆
Color Creation	Color Conversion	☆	☆
	Color Conversion	☆	☆
Interrupt Copying	Interrupt Copying	☆	☆
	Program	☆	☆

3. Adjustment and Color Memory

Color Balance

This function allows you to control the overall color tone of copies by adjusting the Yellow, Magenta, Cyan and Black color balance. Nine levels of tone are available.

Note

- The color balance will return to the default when:
 - The machine is automatically reset.
 - The **[Clear Modes]** key is pressed.
 - The operation switch is turned off.
 - The main power switch is turned off.
- You can store and adjustments you make in memory and recall them later.

Color Balance Adjustment

1 Press the **[Adjustment]** key.

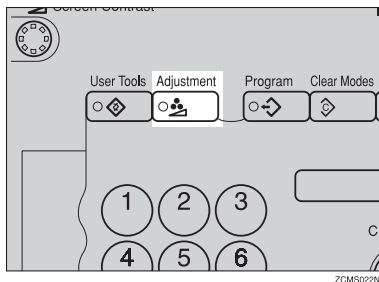

2 Make sure that the **[Color Balance]** key is selected.

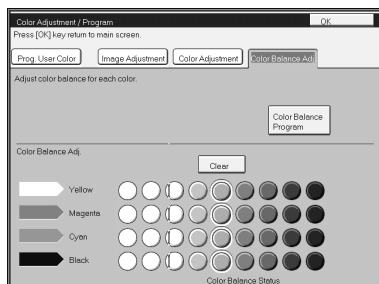

3 Adjust the color balance, then press the **[OK]** key.

Color Balance Program

You can store the color balance setting in memory and recall it when you want to use it.

 **Note**

- You can store up to three color balances.

Storing the adjusted color balance

- 1** Change the color balance (⇒ P.103 “Color Balance Adjustment”), but don't press the [OK] key.
- 2** Press the [Color Balance Program] key.

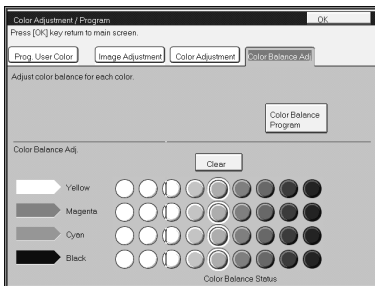

- 3** Press the [Program] key.

- 4** Select a number for this setting.

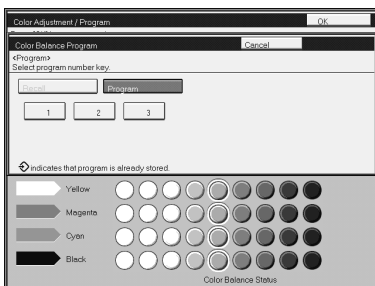

Recalling the color balance

- 1 Press the **[Adjustment]** key.

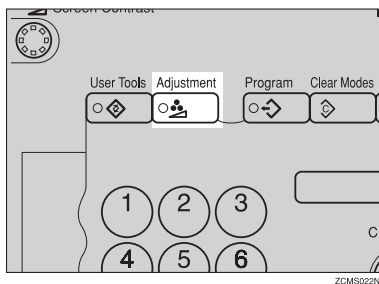

- 2 Make sure that the **[Color Balance]** key is selected.

- 3 Press the **[Color Balance Program]** key.

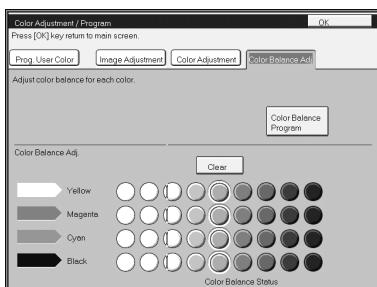

- 4 Make sure that the **[Recall]** key is selected.

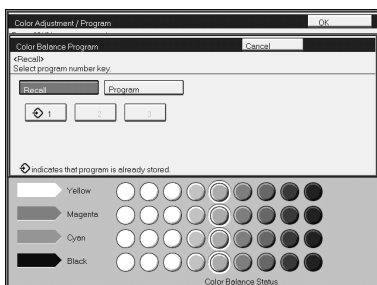

- 5 Select the setting you want to recall.

Note

- Only color balance programs marked with  contain a color balance.

Color Adjustment

This function lets you alter up to three single colors by mixing them with adjacent colors in the color circle. For example, yellow can be shifted towards red to make orange, or towards green to make a yellow green. Note that only areas of the image containing this color will be modified.

Note

- This function is only available in Full Color mode or Auto Color Select mode.
- The single color adjustment will return to the default when:
 - The machine is automatically reset.
 - The **[Clear Modes]** key is pressed.
 - The operation switch is turned off.
 - The main power switch is turned off.

1 Press the **[Adjustment]** key.

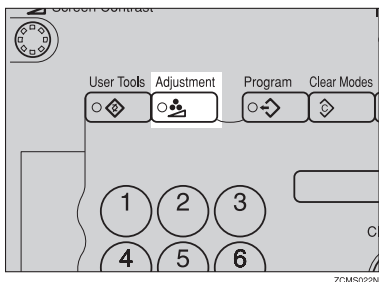

2 Press the **[Color Adjustment]** key.

3 Select the color key that you want to adjust from the color circle.

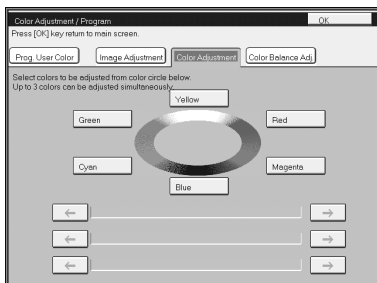

4 Adjust the color with the keys.

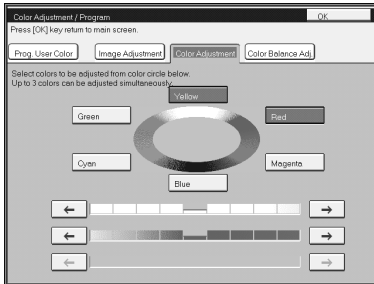







Note

- For example, if you wish to make yellow appear more red, press the [→] key.
- If you wish to make yellow appear more green, press the [←] key.

5 Press the [OK] key.

Image Adjustment

You can change the following default settings for image adjustment:

Soft/Sharp	<p>You can adjust the edges of the image to make the image sharper or softer.</p> <p> Note</p> <p><input type="checkbox"/> Default: <i>level 4</i></p>
Contrast	<p>You can adjust the contrast between light parts and dark parts of the image.</p> <p> Note</p> <p><input type="checkbox"/> Default: <i>level 5</i></p>
Background Density	<p>You can adjust the background density control.</p> <p> Note</p> <p><input type="checkbox"/> Default: <i>level 5</i></p> <p><input type="checkbox"/> If copying a newspaper or an original with a dark background, adjust the background density to a lighter setting.</p> <p><input type="checkbox"/> If part of the original is marked with a highlighting pen, adjust the background density to a darker setting. However, because the color of a highlighting pen is difficult to duplicate, it might be copied in different colors or some colors might not be copied.</p>
Pastel	<p>You can make copies in pastel tones.</p> <p> Note</p> <p><input type="checkbox"/> Default: <i>level 9 which yields a normal color copy</i></p>
U.C.R. Adjustment	<p>You can adjust the black toner density to make the black parts clearer in Full Color mode.</p> <p> Note</p> <p><input type="checkbox"/> Default: <i>level 5</i></p> <p><input type="checkbox"/> Adjust this setting to a darker setting when you want to copy letter parts clearly in black.</p> <p><input type="checkbox"/> Adjust this setting to a lighter setting when the original image is dark.</p>
A.C.S. (Auto Color Selection) Sensitivity	<p>You can adjust the sensitivity when detecting whether the original has color areas in Auto Color Select mode. When set to "B&W" values, the machine will be more likely to detect originals as black originals. "Full Color" values will cause the machine to be more likely to detect originals as color originals.</p> <p> Note</p> <p><input type="checkbox"/> Default: <i>level 3</i></p>
Auto Text/Photo Sensitivity	<p>You can adjust the sensitivity when detecting letter and photo parts of an original in Auto Text/Photo mode. If letter parts photo parts of an original are not differentiated correctly, adjust this setting.</p> <p> Note</p> <p><input type="checkbox"/> Default: <i>level 5</i></p>

Soft/Sharp, Contrast, Background Density, and Pastel

Note

- ❑ Any settings you make with the Sharp/Soft, Contrast, Background Density and Pastel functions will be canceled under the following conditions:
 - The machine is automatically reset.
 - The **[Clear Modes]** key is pressed.
 - The operation switch is turned off.
 - The main power switch is turned off.

1 Press the **[Adjustment]** key.

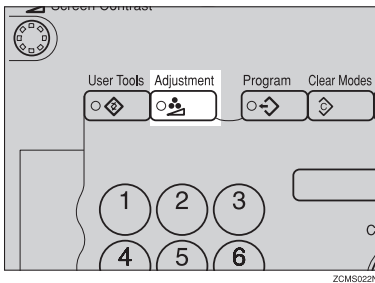

2 Press the **[Image Adjustment]** key.

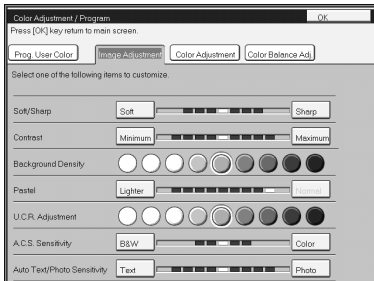

3 Adjust the settings.

Reference

For details, ⇒ P.108 "Image Adjustment".

4 Press the **[OK]** key.

Note

- ❑ If you do not press the **[OK]** key, you can still make copies, but the Image Adjustment settings you have just entered will not be used. However, any settings or features you chose before pressing the **[Adjustment]** key will still apply.

U.C.R. Adjustment, A.C.S. Sensitivity and Auto Text/Photo Sensitivity

Note

- Any settings you make with the U.C.R. Adjustment, A.C.S. Sensitivity, and Auto Text/Photo Sensitivity functions are not cleared by turning the power off or by pressing the **[Clear Modes]** key. They are canceled only when you overwrite them with new settings.

3

1 Press the **[Adjustment]** key.

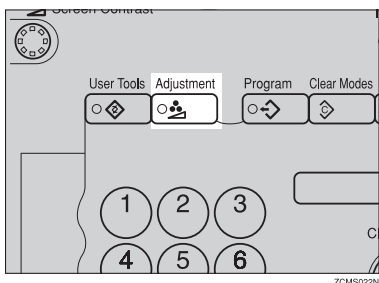

2 Press the **[Image Adjustment]** key.

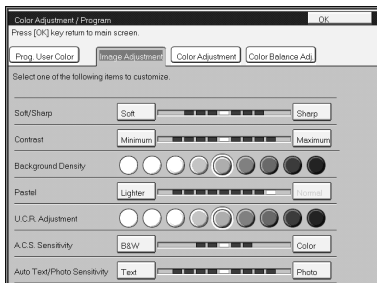

3 Adjust the settings.

Reference

For details, ⇒ P.108 "Image Adjustment".

4 Press the **[OK]** key.

Note

- If you do not press the **[OK]** key, you can still make copies, but the Image Adjustment settings you have just entered will not be used. However, any settings or features you choose before pressing the **[Adjustment]** key will still apply.

Program User Color

In addition to the base colors, you can store up to 15 customized colors into memory (User Color).

Reference

For color samples ⇒ P.10 “Color Sample Chart”.

If your machine has an option, you can sample the user color. ⇒ P.115 “Sampling the User Color (Option)”.

Note

- There are two ways to make user colors as follows:
 - Adjusting a selected base color
 - Mixing colors manually with number keys
- Up to 15 colors can be stored.
- The total percentages of the mixed colors must be 255% or less.
- If the total percentage of the mixed color is over 255%, the copier cannot create the color properly and the results will appear different.
- If the total percentage of the mixed colors is too low, toner may not bond to the paper properly resulting in a change in image density.
- The appearance of user colors might vary slightly according to the image type you have selected (Photo, Text, etc.).

Adjusting Colors Based on the Selected Color

1 Press the **[Adjustment]** key.

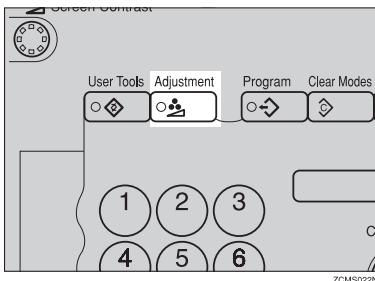

2 Press the **[Prog. User Color]** key.

3 Select the key you wish to store the color in.

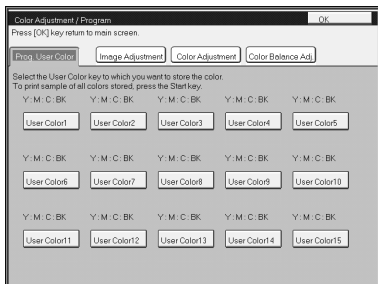

4 Select the base color.

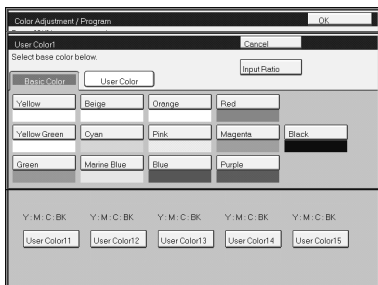

5 You can change the color density in two ways— press the **[+ - keys]** key.

Note

- ❑ Increase or decrease in steps with the **[+]** or **[-]** key. Press the **[+ - keys]** key.

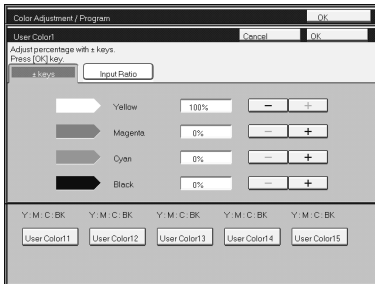

- ❑ Enter the percentage with the number keys.—Press the **[Input Ratio]** key.

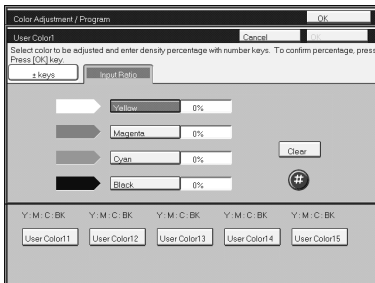

6 Repeat step **5** for each color, then press the **[OK]** key.

7 Press the **[Input Ratio]** key.

Mixing Colors Manually with the Number Keys

1 Press the **[Adjustment]** key.

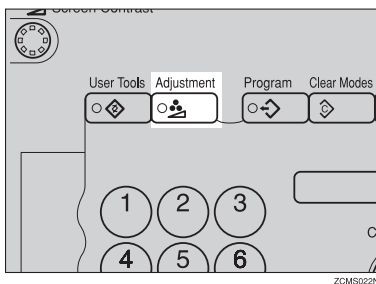

2 Press the [Prog. User Color] key.

3 Select the number that you want to store the user color in.

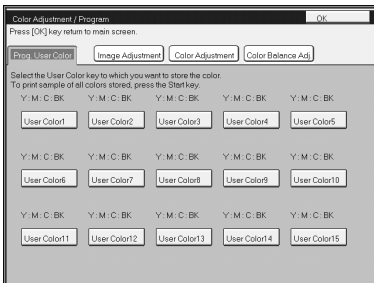

4 Press the key.

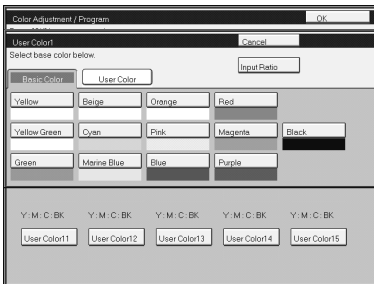

5 Select the color that you want to adjust.

6 Enter the density with the number keys, then press the [#] key.

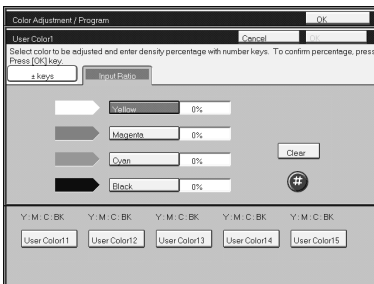

Note

To change the number, press the [Clear] key.

7 Repeat steps **5** and **6** for each color then press the [OK] key.

8 Press the [OK] key.

Sampling the User Color (Option)

You can print out a sample of User Colors to check the colors you have made.

Note

- The sample will be copied on a A4 $8\frac{1}{2} \times 11$ sheet or a A3 11×17 sheet.

1 Press the [Adjustment] key.

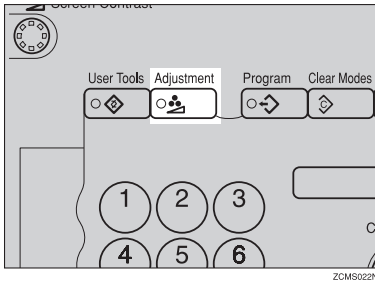

2 Press the [Prog. User Color] key.

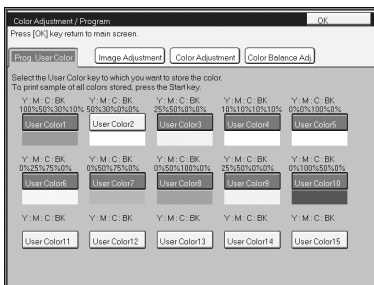

3 Press the [Start] key.

3

4. Area Editing (Option)

What is Area Editing?

If your machine has an Area Editing (Option), you can select areas of an image to be treated differently or have effects applied to them. An example is shown below.

Example:

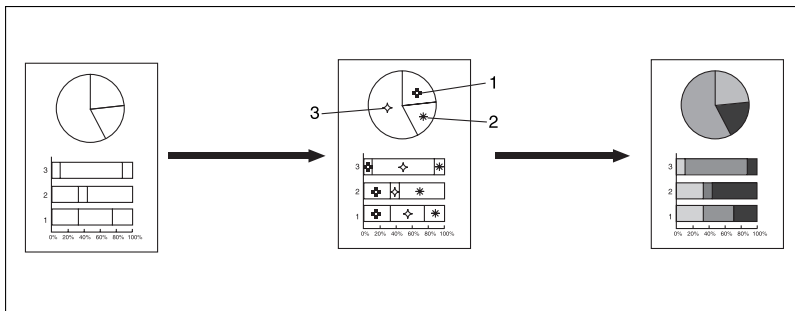

GCARE41E

Note

- In this chapter, multiple areas of the image that you wish to apply the same effects to are referred to as a "Group".

How to Edit Areas

Editing an image involves scanning it in to memory, choosing areas to edit and how those areas will be re-produced.

The basic steps are summarized below. Details are given in the rest of this section.

- ① Enter Area Editing mode.
Press the **[Area Editing]** key.
- ② Designate areas.
⇒ P.119 "*Designating Areas*".
- ③ Select modes.
⇒ P.130 "*Selecting Modes for Designated Areas*".
- ④ Specify more areas to be treated differently (optional).
Repeat ③ and ④.
- ⑤ Copy image.
Press the **[Start]** key.

Designating Areas

Several tools are provided for designating areas of an image.

Area Shapes

- **Rectangle:** Specify two points defining the opposite diagonals of a rectangle.
- **Right Angle Polygon/Polygon:** Specify a sequence of points defining a polygon.
- **Closed Loop:** If your image contains a shape outlined in black and that outline forms a closed loop, specify a point inside the shape to designate it.
- **Multi-Closed Loop:** If your image contains a closed loop and that outline forms another closed loop, specify points inside of the closed loop to designate it.

Frame/Line

- **Rectangle frame:** Specify areas defined by a rectangular frame.
- **Right Angle Polygon/Polygon frame:** Specify areas defined by a polygon or right-angled polygon.
- **Line:** Specify a series of points linked together by straight lines.

Note

- You can designate many areas and apply the same changes to them all by placing them in the same Group.
- Different areas may be treated differently by placing them in different Groups.

Designate Area Display

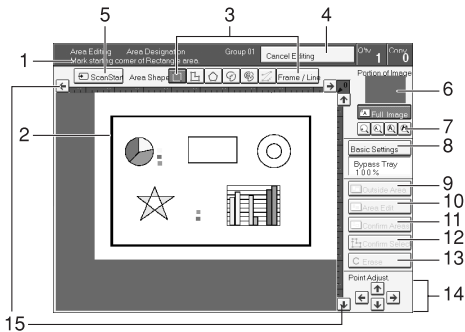

ZCMP030E

1. Message Area

Messages and instructions appear here.

2. Display Area

The image is displayed.

3. Area Shape/Frame/Line

Select the area shape or frame shape and line.

4. Cancel Editing

Exit area editing.

5. Scan Start

Scan in the original again.

6. Portion of Image

Shows the portion of the original that is currently being viewed or is enlarged.

7. Enlarge

Enlarge 4

Enlarge by about 528%

Enlarge 3

Enlarge by about 394%

Enlarge 2

Enlarge by about 264%

Enlarge 1

Enlarge by about 200%

Full Image

Note

- After pressing the [Enlarge] key, mark a point in the displayed image to zoom in on.

8. Basic Settings

Change the job settings for the entire image.

9. Outside Area

Set modes for outside areas.

10. Area Edit

Edit inside the area.

11. Confirm Areas

Show selected areas, modes, and groups.

12. Confirm Selection

Complete a designated area.

13. Erase

Cancel last point selected.

14. Arrow keys

Move cursor in small steps.

15. Scroll key

Move the portion of the original.

Note

- Do not press the touch panel display with any hard or sharp object.

Designate Area Tools

Note

- There are nine tools to designate areas.

Area Editing	Area Shape	Rectangle (⇒ P.122 “Rectangle”.)
		Right Angle Polygon (⇒ P.123 “Right Angle Polygon and Polygon”.)
		Polygon (⇒ P.123 “Right Angle Polygon and Polygon”.)
		Closed Loop (⇒ P.124 “Closed Loop”.)
		Multi Closed Loop (⇒ P.124 “Multi-Closed Loop”.)
Frame/Line	Frame/Line	Rectangle frame (⇒ P.125 “Rectangle frame”.)
		Right Angle Polygon frame (⇒ P.126 “Right Angle Polygon frame and Polygon frame”.)
		Polygon frame (⇒ P.126 “Right Angle Polygon frame and Polygon frame”.)
		Line (⇒ P.127 “Line”.)

Note

- You cannot use the optional document feeder with this function.
- The relationships between the position of the original and the orientation of the scanned image on the display are as follows:

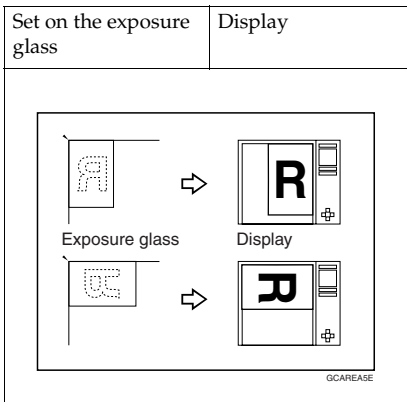

Area Shapes

Rectangle

- 1 Set your original on the exposure glass.
- 2 Press the [Area Editing] key.

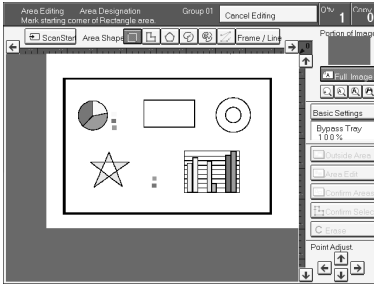

4

 **Note**

-  [Rectangle] key is selected by default.

- 3 Mark the first point.
- 4 Mark the diagonally opposite corner of the area you wish to select.

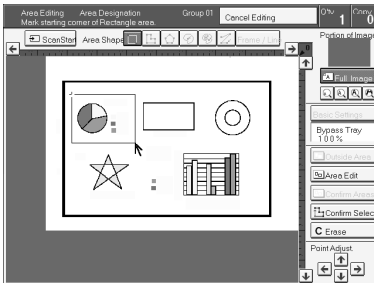

 **Note**

- When you make a mistake, press the [Erase] key.
- Repeat 4 and 5 to add more rectangles.
- When you continue to add areas, you can select other shapes (except Closed Loop Multi-Closed Loop, Line, Frame).

- 5 Press the [Confirm Selection] key.

6 Press the [Area Edit] key, specify your settings, then press the [OK] key.

 **Reference**

For details, ⇒ P.130 "Selecting Modes for Designated Areas".

7 Press the [Start] key.

Right Angle Polygon and Polygon

1 Set your original on the exposure glass.

2 Press the [Area Editing] key.

3 Press the  [R.A. Polygon] or  [Polygon] key.

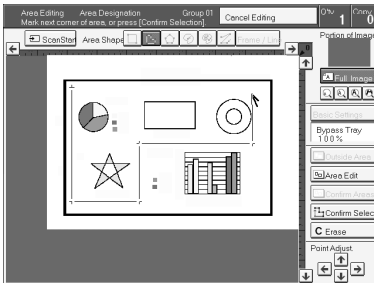

4 Mark the first point.

5 Mark the next points.

 **Note**

- When you use Right Angle Polygon mode, mark points that make right angles.

6 After making the last point, press the [Confirm Selection] key.

7 Press the [Area Edit] key, specify your settings, then press the [OK] key.

 **Reference**

For details, ⇒ P.130 "Selecting Modes for Designated Areas".

8 Press the [Start] key.

Closed Loop

⚠ Limitation

- ❑ If you specify an area with Closed Loop, you cannot specify any additional areas with other selection tools.

🖋 Note

- ❑ When you color areas with the Closed Loop, the area boundary may shift depending on the image.

1 Set your original on the exposure glass.

2 Press the [Area Editing] key.

3 Press the  (Closed Loop) key.

4 Touch on a point inside a closed loop.

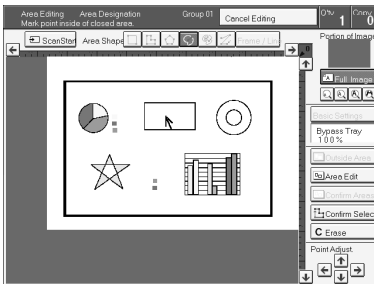

5 Press the [Confirm Selection] key.

6 Press the [Area Edit] key, specify your settings, then press the [OK] key.

🔍 Reference

For details, ⇒ P.130 "Selecting Modes for Designated Areas".

7 Press the [Start] key.

Multi-Closed Loop

⚠ Limitation

- ❑ If you specify an area with Multi-Closed Loop, you cannot specify any additional areas with other selection tools.

1 Set your original on the exposure glass.

2 Press the [Area Editing] key.

3 Press the  (Multi-Closed loop) key.

- 4** Press on a point inside the exterior area you wish to specify.

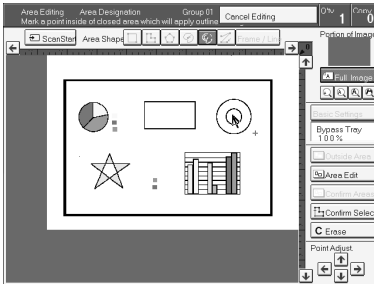

- 5** Press on a point inside the interior area you wish to treat differently.

Note

- Be sure to select a point inside of the exterior area you wish to define.

- 6** Press the [Confirm Selection] key.

- 7** Press the [Area Edit] key, specify your settings, then press the [OK] key.

Reference

For details, ⇒ P.130 "Selecting Modes for Designated Areas".

- 8** Press the [Start] key.

Frame/Line

Rectangle frame

- 1** Set your original on the exposure glass.

- 2** Press the [Area Editing] key.

- 3** Press the [Frame / Line] key.

- 4** Press the (Rectangle) key.

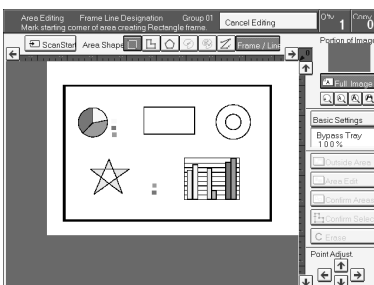

- 5** Mark the first point.
- 6** Mark the diagonally opposite corner of the area you wish to select.
- 7** Press the [Confirm Selection] key.
- 8** Press the [Area Edit] key, specify your settings, then press the [OK] key.



 **Reference**

For details, ⇒ P.130 "Selecting Modes for Designated Areas".

- 9** Press the [Start] key.

Right Angle Polygon frame and Polygon frame

4

- 1** Set your original on the exposure glass.
- 2** Press the [Area Editing] key.
- 3** Press the [Frame / Line] key.
- 4** Press the  (Right Angle Polygon) key or the  (Polygon) key.

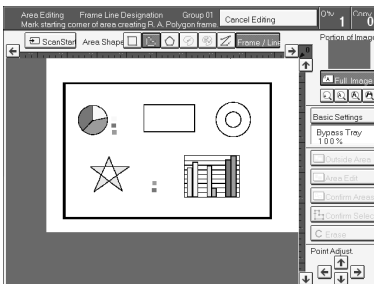

- 5** Mark the first point.
- 6** Mark the next points.
- 7** After making the last point, press the [Confirm Selection] key.
- 8** Press the [Area Edit] key, specify your settings, then press the [OK] key.

 **Reference**

For details, ⇒ P.130 "Selecting Modes for Designated Areas".

- 9** Press the [Start] key.

Line

- 1** Set your original on the exposure glass.
- 2** Press the [Area Editing] key.
- 3** Press the [Frame / Line] key.
- 4** Press the  (Line) key.

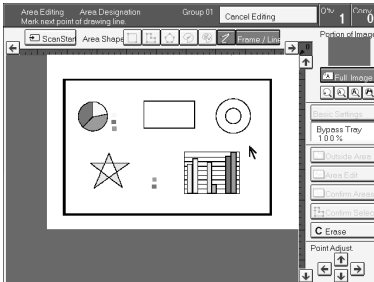

- 5** Mark the first point.
- 6** Mark the next points.
- 7** After marking the last point, press the [Confirm Selection] key.

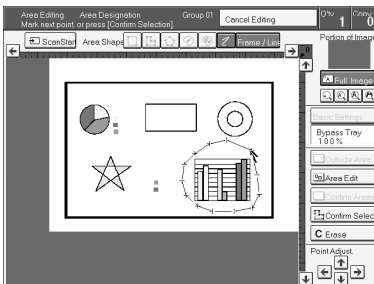

- 8** Press the [Area Edit] key, specify your settings, then press the [OK] key.

 **Reference**

For details, ⇒ P.130 "Selecting Modes for Designated Areas".



- 9** Press the [Start] key.

Notes for Designating Areas

The number of the points, areas, and groups that can be designated

 **Note**

- Maximum number of points: 500
- In Right Angle Polygon mode, Polygon mode, or Line mode, the maximum number of points for one area is 30.
- The number of areas that can be designated is as follows:
 - Rectangle mode: maximum 250 areas
 - Right Angle Polygon mode, Polygon mode, Line mode: 500 points maximum. For example, if 10 points are designated for each area, the maximum number of areas that can be designated is 50.
 - Closed Loop mode, Multi-Closed Loop mode: maximum 500 areas
- Maximum number of groups: 20 ("Group" means a set of areas that you want to do same editions.)
- If you want to designate area shape like an acute angle by using Polygon mode or Line mode, see the following instructions.
 - Use two separate lines to create angle(A).
 - The first designated point(1) and the next designate point(3) should have distance of more than 4mm(0.2")(B).

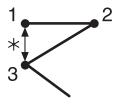
	Area you want to designate	How to designate area
A		
B		

GCAREANE

*:4mm(0.2")

 **Note**

- Do not designate an area or line which overlaps part of another area or line. If an area overlaps another one, the job settings specified last will be applied to the overlapped portion or those areas might not be copied.

- ❑ However, areas containing areas (see below) are permitted. Designate starting with the outermost area.

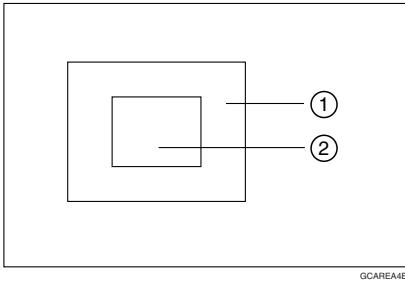

- ❑ These operations are available, however, under the following conditions:
 - When designating areas with Closed Loop mode, Multi-closed Loop or Frame/Line mode.
- ❑ If you mark a line and it overlaps another line you have previously marked, the last point you marked will be canceled automatically.
- ❑ If you designate an area in Right Angle Polygon mode, make sure to mark points that make right angles. If you mark a point which does not match, the editor will automatically correct it to make a right angle.
- ❑ If you want to designate a triangular area, use Polygon mode.
- ❑ In Closed Loop mode or Multi-Closed Loop mode, the machine might not detect a closed loop area or multi-closed loop area completely under the following conditions:
 - The outline is not completely closed, it is too light to detect, or the thickness is uneven.
 - The outline is thinner than 0.3mm.
 - The outline is not black.
 - The space between two closed loop outlines is less than 1mm.
 - The closed loop can be up to 2 meters long.
 - The area enclosed by the outline is not white.
- ❑ The more areas you designate, the more time copying will take.
- ❑ If you erase an area, group, or job setting, it is cleared from the display. However, the points are still stored in memory and are not cleared until you exit Area Editing. This affects the maximum number of areas you can designate.
- ❑ Closed Loop mode Multi-Closed Loop mode and Frame/Line mode cannot be used with Rectangle mode, Right Angle Polygon mode, and Polygon mode for one group at a time.
- ❑ If you need to align areas precisely, you can have a grid shown on the enlarged display. The grid spacing matches the scale of the display.

Selecting Modes for Designated Areas

Reference

The available modes for area editing depend on the area shape. ⇒ P.146 *"Combination Chart for Area Editing"*.

Regarding functions that cannot be used together in area editing, ⇒ P.146 *"Combination Chart for Area Editing"*.

More than one mode can be set for designated area, however, there are some limitations, ⇒ P.146 *"Combination Chart for Area Editing"*. And up to 7 patterns of modes can be set together.

Note

- 4**
- Up to 20 groups of multiple areas can be edited. All the areas should belong to groups 1 ~ 20. You can select up to seven job patterns for at most 20 groups. After you have set seven patterns, the copier will only allow you to choose the pattern of a previous group. If you change the settings for one group, it will change the settings for all other groups with the same job pattern. However, if you have set a Paint, Color Background, or Frame/ Line, changing the color in one group will not affect other groups. (Up to 15 colors can be selected.)
 - The modes that can be set for inside areas as follows:
 - Color/Image Adjustment: Image Density, Color Mode, Original Type, Image Adjustment, Color Adjustment, Color Balance Adjustment
 - Color Creation: Color Conversion, Color Erase, Color Background, Paint, Type Mask

Note

- The editing functions available when specifying area with Frame/Line mode are Width and Color.
- Color/Image Adjustment's default setting:
 - Image Density - Manual Image Density
 - Color Mode - Black & White
 - Original Type - Text
- You can change the default settings. ⇒ P.173 *"User Tools"*.
- Depending on the shapes of the areas, coloring or deleting near the outlines of the areas might not do well, or the outlines might become uneven.
- The way to set modes is basically the same as for the entire image. For details, refer to each page.
 - To fill an area with a selected color, select the Paint.
 - Image Density (⇒ P.26 *"Adjusting Copy Image Density"*.)
 - Original Type (⇒ P.33 *"Selecting the Original Image Type"*.)
 - Color Adjustment (⇒ P.106 *"Color Adjustment"*.)
 - Color Conversion (⇒ P.83 *"Color Conversion"*.)

- Color Background (⇒ P.86 “Color Background”).)
- Color Mode (⇒ P.28 “Selecting a Color Mode”).)
- Image Adjustment (⇒ P.108 “Image Adjustment”).)
- Color Balance Adjustment (⇒ P.103 “Color Balance Adjustment”).)
- Color Erase (⇒ P.85 “Color Erase”).)
- Save Area (⇒ P.133 “Save Area”).)
- Changing Basic Settings for the Entire Image (⇒ P.138 “Changing Basic Settings for the Entire Image”).)
- Change Modes (⇒ P.140 “Change Modes”).)
- Adding Areas (⇒ P.141 “Adding Areas”).)
- Erasing a Group (⇒ P.143 “Erasing a Group”).)

Area Editing

Basic modes

1 Designate the areas you wish to modify.

Note

- For how to designate areas, ⇒ P.119 “Designating Areas”.

2 Press the [Area Edit] key.

3 Press the [Col. /Image Adjust.], [Color Creation] key.

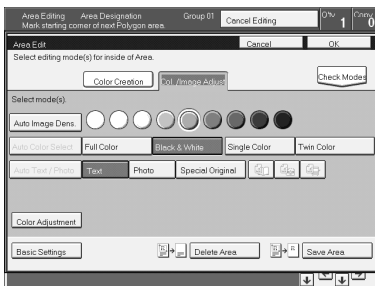

4 Select the effects you wish to apply.

Note

- Image Density, ⇒ P.26 “Adjusting Copy Image Density”.
- Color Mode, ⇒ P.28 “Selecting a Color Mode”.
- Original Type, ⇒ P.33 “Selecting the Original Image Type”.
- Color Adjustment, ⇒ P.106 “Color Adjustment”.
- Color Creation, ⇒ P.83 “Color Creation”.

5 Press the [OK] key.

6 Press the [Start] key.

Delete Area

This function blanks out designated areas.

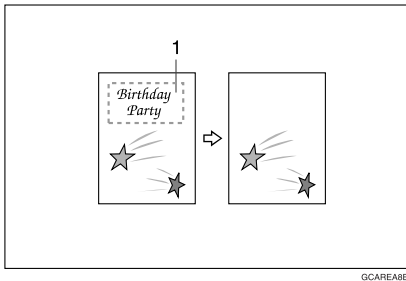

4

1. Designated area

Note

When you select Delete Area mode, previously selected modes are canceled.

1 Designate the areas you wish to modify.

2 Press the [Area Edit] key.

Note

For how to designate areas, ⇒ P.119 "Designating Areas".

3 Press the [Delete Area] key.

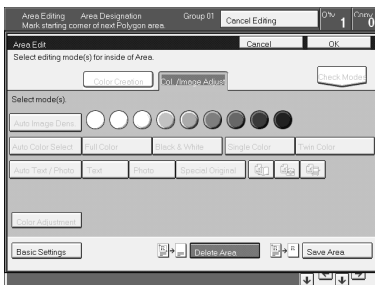

4 Press the [OK] key.

5 Press the [Start] key.

Save Area

This function blanks out all areas except those designated.

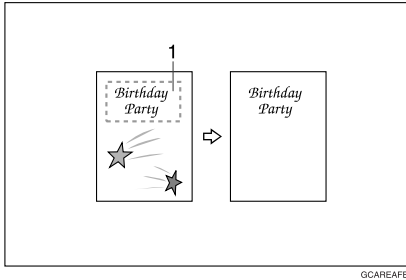

GCAREAFE

4

1. Designated area

Note

- When you select Save Area mode, previously selected modes are canceled.

1 Designate the areas you wish to modify.

Note

- For how to designate areas, ⇒ P.119 “Designating Areas”.

2 Press the [Area Edit] key.

3 Press the [Save Area] key.

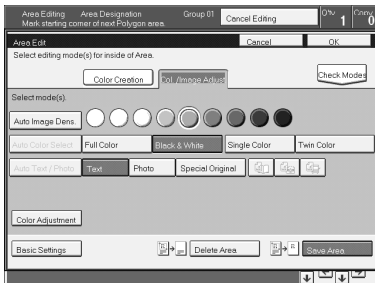

4 Press the [OK] key.

5 Press the [Start] key.

Frame/Line

Editing color and widths

 **Note**

- When specifying the Area for the Frame/Line mode, only the line color and width are features that can be selected.
- Frame/Line widths:
 - Metric version: 0.25 - 2.0mm (in 0.25mm steps)
 - Inch version: 0.01" - 0.08" (in 0.01" steps)
- The frame and line width might be uneven depending on the angle of the line.

1 Designate the areas you wish to modify.

 **Note**

- For how to designate areas, ⇒ P.119 "Designating Areas".

2 Press the [Area Edit] key.

3 Select the color and widths.

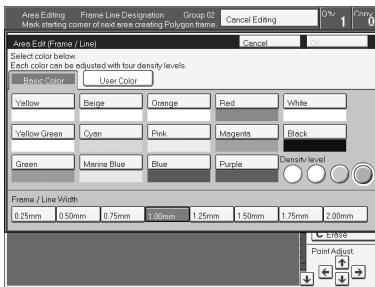

4 Press the [OK] key.

Selecting Modes for Outside Designated Areas

Reference

The available modes for area editing depend on the area shape. ⇒ P.146 *"Combination Chart for Area Editing"*.

Regarding functions that cannot be used together in area editing, ⇒ P.146 *"Combination Chart for Area Editing"*.

More than one mode can be set. However, there are some limitations, ⇒ P.146 *"Combination Chart for Area Editing"*.

The modes that can be set for outside areas as follows:

- Color/Image Adjustment: Copy Image Density, Color Mode, Original Type, Image Adjustment, Color Adjustment, Color Balance Adjustment
- Color Creation: Color Conversion, Color Erase, Color Background, Paint

Note

Color/Image Adjustment default settings:

- Image Density - Manual Image Density
- Color Mode - Black & White
- Original Type - Auto Text/Photo

You can change the default settings. ⇒ P.173 *"User Tools"*.

The way to set modes is basically the same as for the entire image. For details, refer to each page.

- To fill an area with a selected color, select Paint.
- Image Density (⇒ P.26 *"Adjusting Copy Image Density"*.)
- Original Type (⇒ P.33 *"Selecting the Original Image Type"*.)
- Color Adjustment (⇒ P.106 *"Color Adjustment"*.)
- Color Conversion (⇒ P.83 *"Color Conversion"*.)
- Color Background (⇒ P.86 *"Color Background"*.)
- Color Mode (⇒ P.28 *"Selecting a Color Mode"*.)
- Image Adjustment (⇒ P.108 *"Image Adjustment"*.)
- Color Balance Adjustment (⇒ P.103 *"Color Balance Adjustment"*.)
- Color Erase (⇒ P.85 *"Color Erase"*.)
- Save Area (⇒ P.133 *"Save Area"*.)

Area Shapes

Basic modes

1 Designate the areas you wish to modify.

 **Note**

For how to designate areas, ⇒ P.119 “Designating Areas”.

2 Press the [Outside Area] key.

3 Press the [Col. /Image Adjust.] or [Color Creation] key.

4

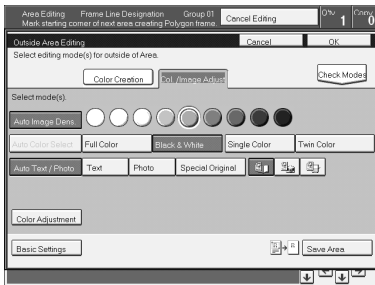

4 Select the effects you wish to apply.

 **Note**

Color Creation, ⇒ P.83 “Color Creation”.

Basic Settings, ⇒ P.138 “Changing Basic Settings for the Entire Image”.

5 Press the [OK] key.

6 Press the [Start] key.

Save Area

1 Designate the areas you wish to modify.

 **Note**

For how to designate areas, ⇒ P.119 “Designating Areas”.

2 Press the [Area Edit] or [Outside Area] key.

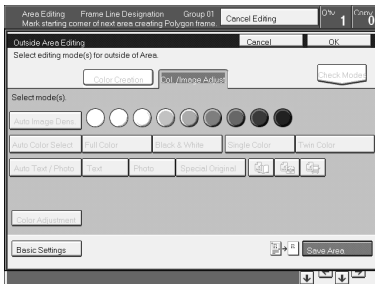
3 Press the [Save Area] key.**4** Select the effects you wish to apply [OK] key.**5** Press the [Start] key.

4

Changing Basic Settings for the Entire Image

You can change job settings for the entire image during area editing.

The job settings that can be changed are as follows:

- Paper Select, ⇒ P.36 "Selecting the Copy Paper Size".
- Reduce/Enlarge (Preset R/E, Zoom, Size Magnification, Directional Magnification), ⇒ P.54 "Preset R/E".
- Shift, ⇒ P.76 "Shifting the Image".
- Margin Adjustment, ⇒ P.77 "Margin Adjustment".
- Sort/Stack/Staple (Option), ⇒ P.90 "Finishing".

Note

- Regarding functions that cannot be used together in area editing, ⇒ P.146 "Combination Chart for Area Editing".
- When you set Shift and Save Area together and designate more than one area in this mode, the minimum size rectangle that includes all the designated areas is shifted as follows:

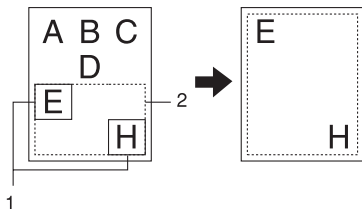

1. Designated Area

2. Area that will be shifted

1 Press the [Basic Settings] key.

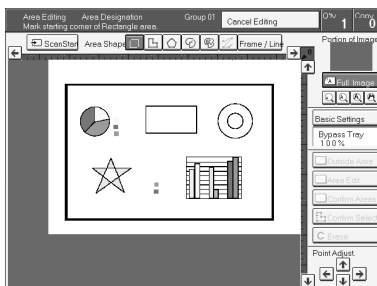

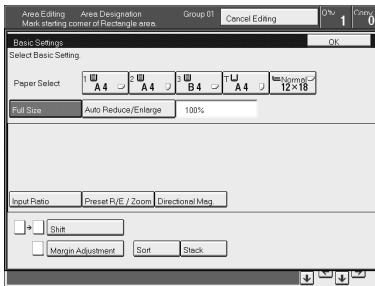
2 Change the job settings.**3** Press the [OK] key.

Checking and Changing Areas

Use this function to check the areas you have selected and the modes you have chosen for each area.

You can:

- Change the modes for an area/group
- Add an area to a group
- Erase an area
- Erase a group

Note

- Note that even if you erase a job setting, a group, or an area, they still consume memory until you exit Area Editing.

Change Modes

1 Press the [Confirm Areas] key.

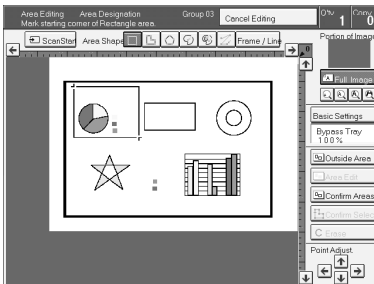

Note

- All designated areas are displayed.

2 Select an area or a group.

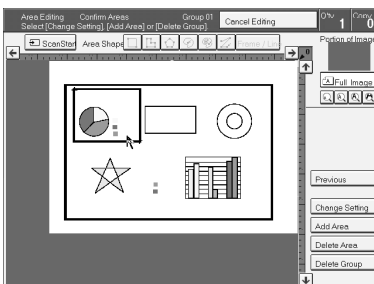

Note

- Areas in this group are highlighted.

3 Press the [Change Setting] key.

4 Change the modes, then press the [OK] key.

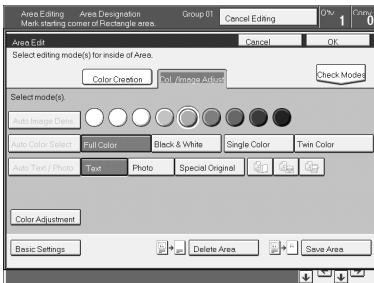

Note

- Color Creation, ⇒ P.83 “Color Creation”.
- Color Adjustment, ⇒ P.106 “Color Adjustment”.
- Basic Settings, ⇒ P.138 “Changing Basic Settings for the Entire Image”.
- Delete Area, ⇒ P.132 “Delete Area”.
- Save Area, ⇒ P.133 “Save Area”.

5 Press the [Previous] key.

Adding Areas

1 Press the [Confirm Areas] key.

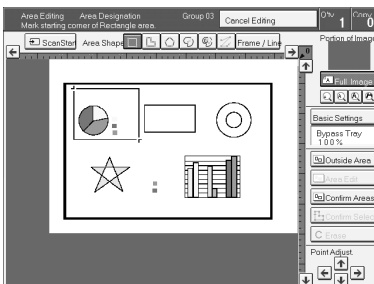

Note

- All designated areas are displayed.

2 Select an area or a group.

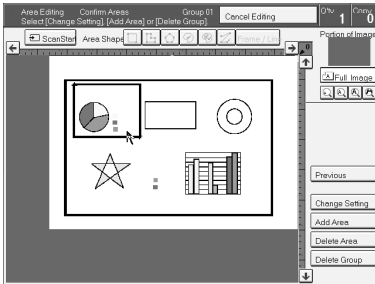

Note

- Areas in this group are highlighted.

3 Press the [Add Area] key.

4 Select the area shape.

5 Designate areas, then press the [Confirm Areas] key.

Note

- For how to designate areas, ⇒ P.119 “Designating Areas”.

6 Press the [Previous] key.

Erasing an Area

1 Press the [Confirm Areas] key.

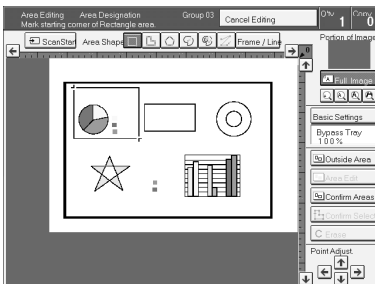

Note

- All designated areas are displayed.

2 Select an area that you want to cancel.

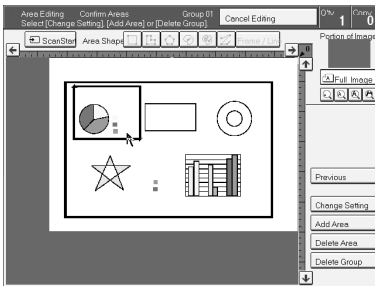

3 Press the [Delete Area] key.

4 Press the [Yes] key.

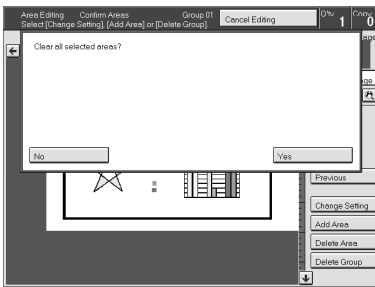

5 Press the [Previous] key.

Erasing a Group

1 Press the [Confirm Areas] key.

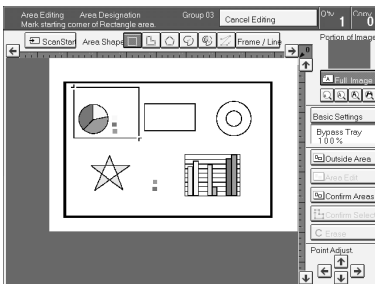

Note

- All designated areas are displayed.

2 Select a group that you want to cancel.

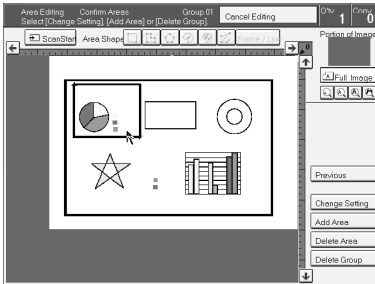

Note

Areas in this group are highlighted.

3 Press the [Delete Group] key.

4 Press the [Yes] key.

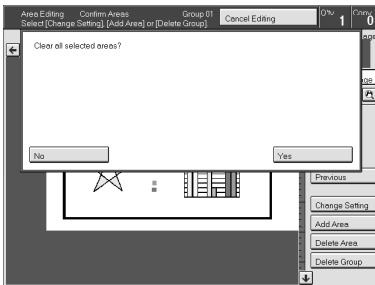

5 Press the [Previous] key.

Exiting Area Editing

1 Press the [Cancel Editing] key.

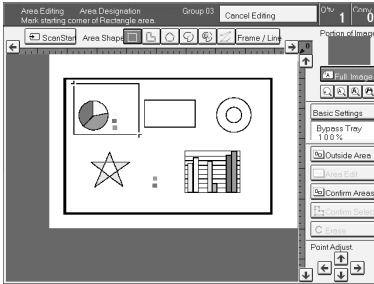

2 Press the [Yes] key.

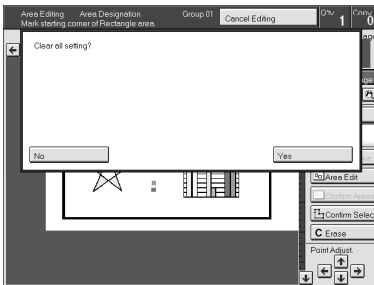

Combination Chart for Area Editing

- ① Functions available for designated areas.
- ② Functions available for areas outside designated areas.
- ③ Functions that can be selected together in an area.
- ④ Functions available with each shape.
- ⑤ Functions available for the entire image.
- ☆ Those modes can be used together.
- ★ Those modes can be used together with some limitations.
- The original mode is overridden and the newly selected mode is active.
- × These modes cannot be used together.

4

		①	②	③											
		Newly selected mode													
		Color Mode				Density	Original Type				Color Creation				
		Full Color	Black & White	Single Color	Twin Color	Manual Image Density	Auto Image Density	Auto Text Photo	Text	Photo	Special Original	Color conversion	Color Erase	Paint	Color Background
Color Mode	Full Color	★	→	→	→	×	→	→	→	→	→	→	→	→	
	Black & White	★	→	→	→	×	→	→	→	→	×	→	→	→	
	Single Color	★	→	→	→	×	→	→	→	→	×	→	→	→	
	Twin Color	★	→	→	→	×	→	→	→	→	×	→	→	→	
Image Density	Manual Image Density	☆	☆	☆	☆	→	→	→	→	→	→	→	→	→	
	Auto Image Density	★	★	☆	☆	→	→	→	→	→	→	→	→	→	
Original Type	Auto Text/Photo	×	☆	☆	☆	☆	☆	→	→	→	→	→	→	→	
	Text	★	☆	☆	☆	☆	☆	→	→	→	→	→	→	→	
	Photo	★	☆	☆	☆	☆	☆	→	→	→	→	→	→	→	
	Special Original	★	☆	☆	☆	☆	☆	→	→	→	→	→	→	→	
Color Creation	Color Conversion	★	☆	×	×	×	☆	☆	☆	☆	☆	→	→	→	
	Color Erase	★	☆	☆	☆	☆	☆	☆	☆	☆	☆	→	→	→	
	Paint	★	☆	×	×	×	×	×	×	×	×	→	→	→	
	Color Background	★	☆	☆	☆	☆	☆	☆	☆	☆	☆	→	→	→	
Image Adjustment	Soft/Sharp	★	☆	☆	☆	☆	☆	☆	☆	☆	☆	☆	☆	→	
	Contrast	★	☆	☆	☆	☆	☆	☆	☆	☆	☆	☆	☆	→	
	Background Density	★	☆	☆	☆	☆	☆	☆	☆	☆	☆	☆	☆	→	
	Pastel	★	☆	☆	☆	☆	☆	☆	☆	☆	☆	☆	☆	→	
	U.C.R. Adjustment	★	☆	☆	☆	☆	☆	☆	☆	☆	☆	☆	☆	→	
Color Adjustment	★	☆	☆	→	→	→	→	→	→	→	→	→	→		
Color Balance Adjustment	★	☆	☆	☆	☆	☆	☆	☆	☆	☆	☆	☆	☆		
Save Area	☆	☆	☆	☆	☆	☆	☆	☆	☆	☆	☆	☆	☆		
Delete Area	☆	×	×	×	×	×	×	×	×	×	×	×	×		













		①	②	③												
		Newly selected mode														
		Color Mode				Density	Original Type			Color Creation						
		Full Color	Black & White	Single Color	Twin Color	Manual Image Density	Auto Image Density	Auto Text Photo	Text	Photo	Special Original	Color conversion	Color Erase	Paint	Color Background	
Paper Select	Auto Paper Select	x	x													
	Copying from Paper Trays	x	x													
	Bypass Feed Copying	x	x													
Reduce/Enlarge	Preset Reduce/Enlarge	x	x													
	Zoom	x	x													
	Directional Magnification (%)	x	x													
	Directional Size Magnification (mm)	x	x													
Auto Reduce/Enlarge					x	x										
Shift/Book	Centering/Cornering, Margin Adjustment	x	x													
Duplex/Combine	Series	Book → 1 Sided	x	x												
		2 Sided → 1 Sided	x	x												
	Duplex	1 Sided → 2 Sided	x	x												
		2 Sided → 2 Sided	x	x												
		Book → 2 Sided	x	x												
		Multi → 2 Sided	x	x												
	Combine	Combine 2 originals	x	x												
Combine 4 originals		x	x													
Finishing	Sort/Stack/Staple	x	x													
Program		x	x													
Interrupt Copying		x	x													

		③								④								⑤			
		Newly selected mode																			
		Image Adjustment																			
		Soft/Sharp	Contrast	Background Density		Pastel	U.C.R. Adjustment	Color Adjustment	Color Balance Adjustment	Save Area	Delete Area	Rectangle	Right Rectangle	Polygon	Closed Loop	Multi Closed Loop	Line	Frame Line & Rectangle	Frame Line & Right Polygon	Frame Line & Polygon	
Color Mode	Full Color	☆	☆	☆	☆	☆	☆	☆	☆	☆	→	☆	☆	☆	☆	☆	☆	☆	☆	☆	
	Black & White	☆	☆	☆	☆	☆	☆	×	☆	☆	→	☆	☆	☆	☆	☆	☆	☆	☆	☆	
	Single Color	☆	☆	☆	☆	☆	×	☆	☆	☆	→	☆	☆	☆	☆	☆	☆	☆	☆	☆	
	Twin Color	☆	☆	☆	☆	☆	×	☆	☆	☆	→	☆	☆	☆	☆	☆	☆	☆	☆	☆	
Image Density	Manual Image Density	☆	☆	☆	☆	☆	☆	☆	☆	☆	→	☆	☆	☆	☆	☆	☆	☆	☆	☆	
	Auto Image Density	☆	☆	☆	☆	☆	☆	☆	☆	☆	→	☆	☆	☆	☆	☆	☆	☆	☆	☆	
Original Type	Auto Text/Photo	☆	☆	☆	☆	☆	☆	☆	☆	☆	→	☆	☆	☆	☆	☆	☆	☆	☆	☆	
	Text	☆	☆	☆	☆	☆	☆	☆	☆	☆	→	☆	☆	☆	☆	☆	☆	☆	☆	☆	
	Photo	☆	☆	☆	☆	☆	☆	☆	☆	☆	→	☆	☆	☆	☆	☆	☆	☆	☆	☆	
	Special Original	☆	☆	☆	☆	☆	☆	☆	☆	☆	→	☆	☆	☆	☆	☆	☆	☆	☆	☆	
Color Creation	Color Conversion	☆	☆	☆	☆	☆	☆	☆	☆	☆	→	☆	☆	☆	×	×	—	—	—	—	
	Color Erase	☆	☆	☆	☆	☆	☆	☆	☆	☆	→	☆	☆	☆	×	×	—	—	—	—	
	Paint	×	☆	×	☆	☆	×	☆	☆	☆	→	☆	☆	☆	☆	☆	☆	☆	☆	☆	
	Color Background	☆	☆	☆	☆	☆	☆	☆	☆	☆	→	☆	☆	☆	☆	☆	☆	☆	☆	☆	
Image Adjustment	Soft/Sharp	—	☆	☆	☆	☆	☆	☆	☆	☆	→	☆	☆	☆	☆	☆	☆	☆	☆	☆	
	Contrast	☆	—	☆	☆	☆	☆	☆	☆	☆	→	☆	☆	☆	☆	☆	☆	☆	☆	☆	
	Background Density	☆	☆	—	☆	☆	☆	☆	☆	☆	→	☆	☆	☆	☆	☆	☆	☆	☆	☆	
	Pastel	☆	☆	☆	—	☆	☆	☆	☆	☆	→	☆	☆	☆	☆	☆	☆	☆	☆	☆	
	U.C.R. Adjustment	☆	☆	☆	☆	—	☆	☆	☆	☆	→	☆	☆	☆	☆	☆	☆	☆	☆	☆	
Color Adjustment		☆	☆	☆	☆	☆	—	☆	☆	☆	→	☆	☆	☆	☆	☆	☆	☆	☆	☆	
Color Balance		☆	☆	☆	☆	☆	☆	—	☆	☆	→	☆	☆	☆	☆	☆	☆	☆	☆	☆	
Save Area		☆	☆	☆	☆	☆	☆	☆	☆	—	☆	×	×	×	×	×	—	—	—	—	
Delete Area		×	×	×	×	×	×	×	×	—	☆	☆	☆	☆	☆	☆	—	—	—	—	
Paper Select	Auto Paper Select																			×	
	Copying from Paper Trays																			☆	
	Bypass Feed Copying																			☆	
																				☆	
Reduce/Enlarge	Preset Reduce/Enlarge																			☆	
	Zoom																			☆	
	Directional Magnification (%)																			☆	
	Directional Size Magnification (mm)																			☆	
Auto Reduce/Enlarge																				☆	
Shift/Book	Centering/Cornering, Margin Adjustment																				☆
	Duplex/Combine	Series	Book → 1 Sided																		
2 Sided → 1 Sided																					×
Duplex		1 Sided → 2 Sided																			×
		2 Sided → 2 Sided																			×
		Book → 2 Sided																			×
Combine		Multi → 2 Sided																			×
		Combine 2 originals																			×
Combine 4 originals																			×		
Finishing Program	Sort/Stack/Staple																				☆
Interrupt Copying																				×	

5. What to Do if Something Goes Wrong

If Your Machine Does not Operate as You Want

Check the following:

Condition	Action
Nothing happens when the operation switch is turned on.	Is the main power switch turned on? → Turn on the main power switch.
 Paper tray is empty.	Load paper. ⇒ P.154 "  Loading Paper".
 Toner container is almost empty. Or toner container is empty.	Add toner. ⇒ P.156 "  Changing The Toner Cartridge".
 Doors/covers are open.	Close the doors/covers.
 Misfeed occurs.	Remove misfed paper. ⇒ P.161 "  Clearing Misfeeds".
 The machine instructs you to add staples.	Add staples. ⇒ P.164 "  Adding Staples".
The machine instructs you to enter your user code.	The machine is set for user code mode. Enter your user code. ⇒ P.179 "General Features".
The Energy Saver indicator is on.	Your machine is in Energy Saver mode. → Press the [Energy Saver] key. ⇒ P.49 "Energy Saver Mode".
Misfeeds occur frequently.	Is the right kind of paper in the paper tray? → Paper size and weight must be within the specifications for this machine.
	Is folded, wrinkled, damp, or curled paper in the paper tray? → Always use dry, undamaged paper.
	Is the paper properly set in the paper tray? → Always load paper correctly.
	Are there any pieces of misfed paper or other foreign objects in the machine? → Make sure that the paper path is completely clear of paper and other material after a misfeed.
Staples do not come out at all.	There are jammed staples in the stapler. → Remove the jammed staples. ⇒ P.166 "  Removing Jammed Staples".
	After loading a new staple cartridge, staples might not be ejected the first few times you try to use the stapler.
 or  or  is lit	Contact your service representative.

Condition	Action
The machine cannot detect the original size.	Set custom size original on the exposure glass.
	Input the both horizontal and vertical sizes of the custom original. ⇒ P.41 "Copying onto custom size paper with the bypass tray".
	Select paper manually, not in Auto Paper Select mode.
	Do not use Auto Reduce/Enlarge mode.
	Set your originals.
The machine instructs you to check the original direction.	Set the original in the same direction as the copy paper.
The machine instructs you to check paper size.	Select the proper paper size.
The machine cannot sort this size paper.	Select the proper paper size that can be used in Sort mode. ⇒ P.90 "Sort".
The machine cannot stack this size paper.	Select the proper paper size that can be used in Stack mode. ⇒ P.92 "Stack".
You cannot enter the desired copy set number.	You can change the maximum copy quantity that you can make at a time. ⇒ P.179 "General Features".
The machine instructs you to set the duplex tray.	Reset the duplex tray correctly. ⇒ P.4 "Guide To Components".
The machine instructs you to wait.	Wait for the machine to warm-up.
The panel display is off.	Press the [Energy Saver] key to cancel Energy Saver mode.
	Turn on the operation switch.
	Adjust the Screen Contrast. ⇒ P.7 "Operation Panel".

If you cannot correct the problem by taking the above actions, please contact your service representative.

If You Cannot Make Copies as You Want

Problem	Cause	Action
Copies appear dirty.	The image density is too dark.	Adjust the image density. ⇒ P.26 "Adjusting Copy Image Density". Adjust the background density. ⇒ P.108 "Image Adjustment".
	The exposure glass or document feeder belt is dirty.	Clean them. ⇒ P.191 "Maintaining Your Machine"
The reverse side of an original image is copied.	The image density is too dark.	Adjust the image density. ⇒ P.26 "Adjusting Copy Image Density".
		If you select Black & White Copy mode or Single Color mode, place a black paper in the backside of the original and select Auto Image Density mode.
		Lighten the background density. ⇒ P.108 "Image Adjustment".
A shadow is copied when copying a pasted original.	The image density is too dark.	Adjust the image density. ⇒ P.26 "Adjusting Copy Image Density".
		Adjust the background density. ⇒ P.108 "Image Adjustment".
		Set the original in a different direction.
		Put mending tape on the bound part.
Copies are too light.	The original has a low contrast image.	Adjust the image density. ⇒ P.26 "Adjusting Copy Image Density".
	The image density is too light.	
	Damp or rough grain paper is used	Use dry paper without rough grain.
Copy image is not clear.	The original image type (Auto Text/Photo) is not selected properly.	Select the proper original image type. ⇒ P.26 "Adjusting Copy Image Density".
		Adjust the sharpness of the image with the Soft/Sharp function. ⇒ P.108 "Image Adjustment".

Problem	Cause	Action
The same copy area is dirty whenever making copies.	The exposure glass or document feeder belt is dirty.	Clean them. ⇒ P.191 <i>"Maintaining Your Machine"</i> .
Copies are blank or parts of the image are not copied.	The original is not set correctly.	Set the originals correctly. ⇒ P.16 <i>"Setting Originals on the Exposure Glass"</i> .
	An improper paper size is selected.	Select the proper paper size.
	The selected reproduction ratio does not match the paper size.	Select the proper reproduction ratio.
A moire pattern is produced on copies as shown in the illustration. 	Text mode is selected.	Select Auto Text/Photo mode or Photo mode. ⇒ P.33 <i>"Selecting the Original Image Type"</i> .
	The line images of the original might be overlapped each other.	Place the original on the exposure glass at a slight angle. Adjust the sharpness of the image. ⇒ P.108 <i>"Image Adjustment"</i> .
Color tone of copies is different from that of originals.	The color balance is not set properly.	Adjust the Color Balance. ⇒ P.103 <i>"Color Balance Adjustment"</i> .
		Perform the Auto Color Calibration. ⇒ P.108 <i>"Image Adjustment"</i> .
Color tone of copies is completely different from that of originals.	Unsuitable color setting.	Perform Auto Color Calibration (A.C.C.). ⇒ P.108 <i>"Image Adjustment"</i> . If you cannot correct the problem by performing Auto Color Calibration, contact your service representative.
Letter parts and photo parts of an original are not separated correctly.	An original has screen letters or low density letters.	Adjust the Auto Text/Photo Sensitivity to a "Text" level. ⇒ P.108 <i>"Image Adjustment"</i> .
	An original has a high contrast photo.	Adjust the Auto Text/Photo Sensitivity to a "Photo" level. ⇒ P.108 <i>"Image Adjustment"</i> .
	An original has a photo having sequence thin lines with regular thin spaces.	
Color parts of an original are copied in black in Auto Color Select mode.	The original image contains small or thin color parts.	Adjust the A.C.S. Sensitivity to a "Full color" level. ⇒ P.108 <i>"Image Adjustment"</i> .

Problem	Cause	Action
Non-color parts of an original are copied in color in Auto Color Select mode.	The machine might detect some black and white screen images (such as from newspaper) as a full color original.	Select Black & White Copy mode. ⇒ P.29 " <i>Black & White copy mode</i> ".
		Adjust the A.C.S. Sensitivity to a "B&W" level. ⇒ P.108 " <i>Image Adjustment</i> ".
A copy image is blurred.	The image density is too light.	Adjust the image density. ⇒ P.26 " <i>Adjusting Copy Image Density</i> ".
	An improper kind of paper is set.	Set the right kind of paper in the paper tray.  Note <input type="checkbox"/> Copies might be blurred if you copy onto rough grain, coated, or damp paper.
	Toner is running out.	Add toner. ⇒ P.156 " <i>Changing The Toner Cartridge</i> ".
In Margin Adjustment mode, parts of the original image are not copied.	The margin is set too wide.	Set the narrow margin with the user tools. ⇒ P.179 " <i>General Features</i> ".

If you cannot correct the problem by taking the above actions, please contact your service representative.

Loading Paper

Reference

Regarding paper sizes that can be set, ⇒ P.197 “Mainframe”.

Note

If you want to change the paper size, ⇒ P.169 “Changing Paper Size”.

Non-recommended Paper for Paper Trays

- Folded, curled, creased, or damaged paper
- Torn paper
- Perforated paper
- Paper with conductive or low electrical resistance coating such as carbon or silver coating
- Thermal paper, art paper
- Thin paper that has low stiffness
- Damp paper
- Wavy paper
- Stapled paper
- Translucent paper
- OHP transparencies

Note

- Load paper with the side you wish to copy onto face-down in the paper trays. If copies are curled, try turning the copy paper over in the tray. If there is no improvement, change to copy paper with less curl.
- Correct curls in copy paper before loading.
- Fan copy paper to get air between the sheets before loading.
- When making 2-sided copies, do not load paper in the paper tray to copy on the reverse side. Use the bypass tray. ⇒ P.46 “Copying onto the reverse side of paper”.

Loading Paper in the Paper Tray

1 Pull out the paper tray until it stops.

2 Remove the back fence.

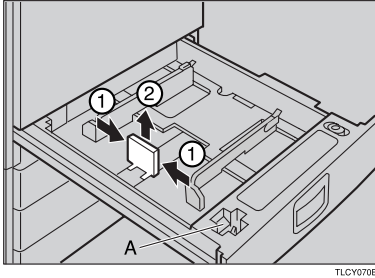

Note

- For 11" × 17" paper, put the back fence inside A.

3 Square the paper and set it in the tray.

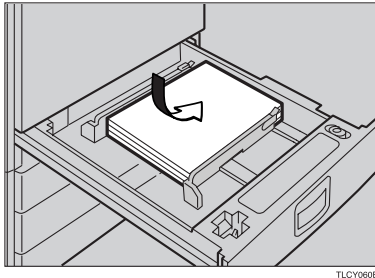

Note

- Do not stack paper over the limit mark.
- Make sure that the leading corners of the paper are under the corners.

4 Reinstall the side fences.

5 Push the paper tray in until it stops.

📉 Changing The Toner Cartridge

There are four kinds of toner (Cyan, Magenta, Yellow, and Black). When 📉 is lit, it is time to add toner.

⚠️ **WARNING:**

- ***Do not incinerate used toner or toner containers. Toner dust might ignite when exposed to an open flame. Dispose of used toner containers in accordance with local regulations for plastics.***

⚠️ **CAUTION:**

- *Keep toner (used or unused) and toner containers out of reach of children.*

⚠️ **CAUTION:**

- *Our products are engineered to meet high standards of quality and functionality, and we recommend that you only use the expendable supplies available at an authorized dealer.*

5

📖 **Note**

- If you use toner other than that recommended, a fault might occur.
- When adding toner, do not turn off the operation switch. If you do, your settings are cleared.
- Always add toner after the machine instructs you to add toner.
- Do not use used toner. This will damage the machine.
- Be sure to add the correct color toner.
- You can still make about 20 copies after 📉 appears. This is a good time to get a new toner cartridge ready.

Pulling Out the Toner Cartridge

- 1 Open the front cover of the machine.

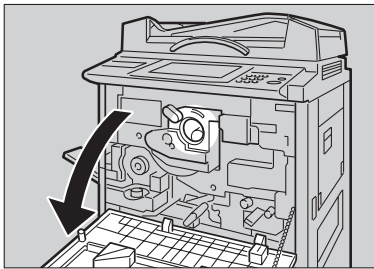

ZCMH031E

2 Pull the knob out to unlock it.

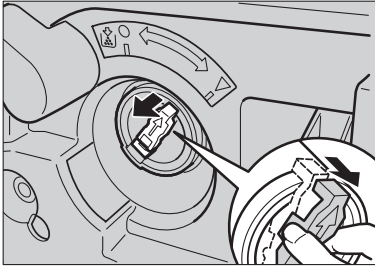

3 Turn it counterclockwise to the ● mark.

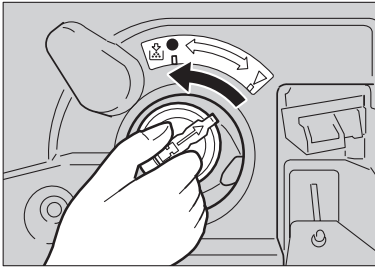

4 While holding the knob, then gently pull out the toner cartridge.

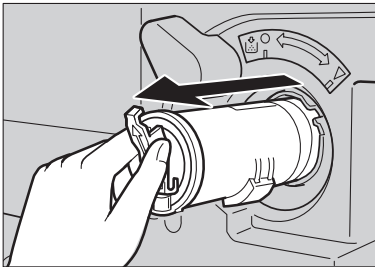

When you use the Cartridge Replacement Tool

Note

The cartridge replacement tool helps you to turn the knob.

1 Detach the cartridge replacement tool from the hook.

2 Set it onto the knob.

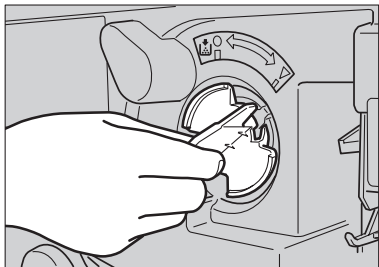

CZMT090E

3 Turn it counterclockwise to the  mark.

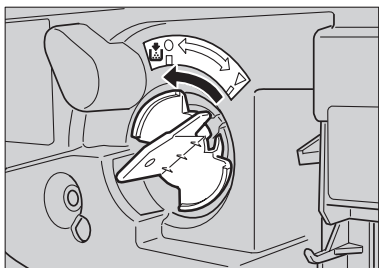

CZMT100E

4 Turn it clockwise a little, then pull it out from the knob.

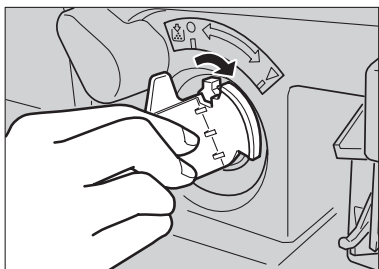

CZMT110E

Note

Hang the cartridge replacement tool on the hook for future use.

Setting the New Toner Cartridge

- 1** Hold the new toner cartridge horizontally and shake 5 or 6 times.

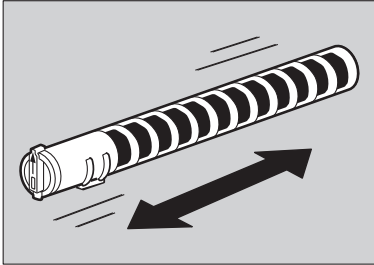

CZMT030E

- 2** Remove the seal.

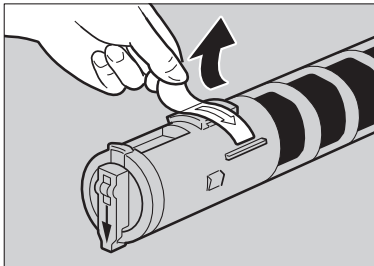

CZMT040E

- 3** Insert the toner cartridge with the ↑ mark at the top.

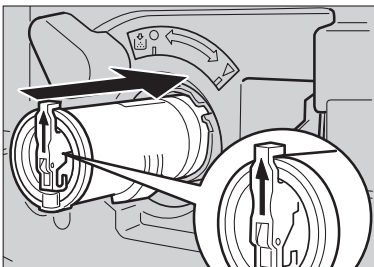

CZMT050E

4 Turn the knob clockwise to the ▼ mark until it clicks.

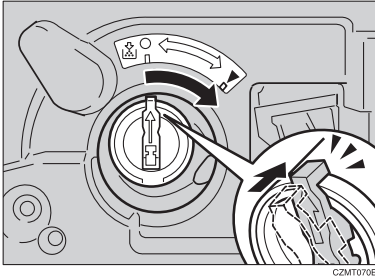

Note

- Hang the cartridge replacement tool on the hook for future use.

When you use the Cartridge Replacement Tool

5

Note

- The cartridge replacement tool helps you to turn the knob.

1 Set it onto the knob.

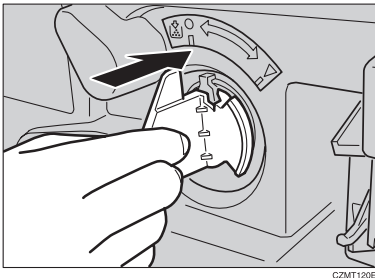

2 Turn it clockwise to the ▼ mark.

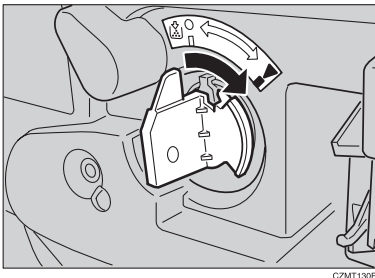

3 Detach the cartridge replacement tool from the knob.

Note

- Hang the cartridge replacement tool on the hook for future use.

160 **5** Close the front cover.

Clearing Misfeeds

⚠ CAUTION:

- *The fusing section of this equipment might be very hot. You should be very careful that you don't touch this section when removing the misfed paper.*

📝 Note

- When clearing misfeeds, do not turn off the operation switch. If you do, your copy settings are cleared.
- To prevent misfeeds, do not leave any torn scraps of paper within the machine.
- If paper misfeeds occur repeatedly, contact your service representative.
- When clearing misfeeds, make sure that all units and levers are returned to their original position and all covers are closed.
- Do not touch originals in the document feeder when a paper misfeed occurs in the machine. If you do the machine cannot determine which originals have been copied and which haven't.

5

Check the Misfeed Location Display

The display shows the location of misfed paper.

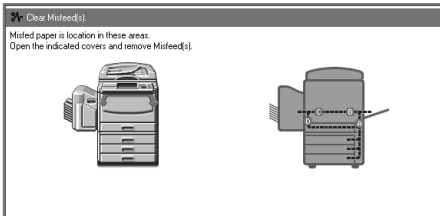

Clearing Paper Misfeeds

When A, B, C, D, Y or Z is Displayed:

- 1** Open the front cover of the machine.
- 2** You can find the sticker (with  at the top) explaining how to remove misfed paper inside the front cover as shown in the illustration.

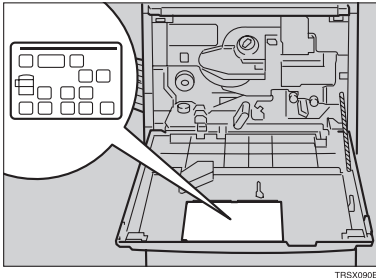

- 3** Remove misfed paper following the instructions on the sticker.

When P is Displayed:

 **Note**

- This indicator is displayed only when your machine is equipped with the document feeder.

- 1** You can find a sticker (with  at the top), explaining how to remove the misfed paper, on the document feeder as shown in the illustration.

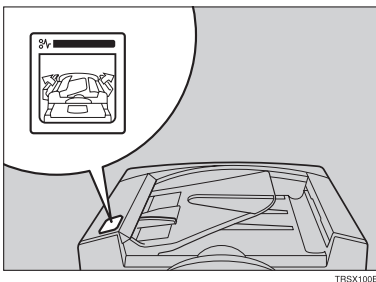

- 2** Remove the misfed paper following the instructions on the sticker.

When R is Displayed: (If your machine is equipped with the 20-bin sorter stapler.)

- 1 You can find a sticker (with  at the top) explaining how to remove the misfed paper, on the color of the sorter stapler as shown in the illustration.

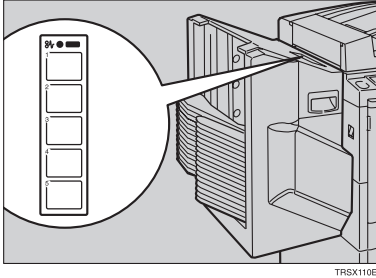

- 2 Remove the misfed paper following the instructions on the sticker.

5

When P is Displayed: (If your machine is equipped with the 10-bin sorter stapler.)

- 1 You can find the sticker (with  at the top), explaining how to remove the misfed paper on the cover of the sorter stapler as shown in the illustration.

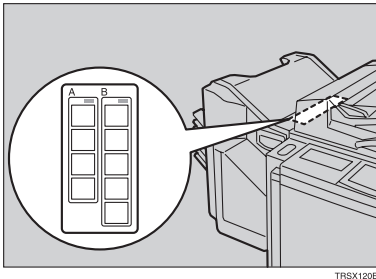

- 2 Remove the misfed paper following the instructions on the sticker.

📄 Adding Staples

⚠️ CAUTION:

- *Our products are engineered to meet high standards of quality and functionality, and we recommend that you only use the expendable supplies available at an authorized dealer.*

🔧 Note

- ❑ If you use a staple cartridge other than that recommended, staple failure or staple jams might occur.

If the staple is coming out, press it to the proper position.

1 Open the front cover of the sorter stapler.

2 Raise the staple unit towards you.

5

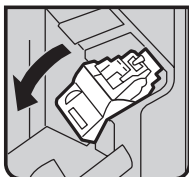

TRSP030E

3 Remove the cartridge.

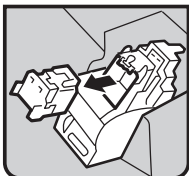

TRSP031E

4 Hold the new cartridge as shown in the illustration, then pull out the stopper.

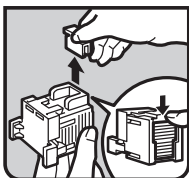

TRSP032E

🔧 Note

- ❑ If the staple is coming out, press it to the proper position.

5 Reinstall the cartridge until it clicks.

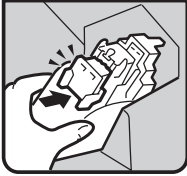

TRSP033E

6 Push the staple unit to the original position.



TRSP034E

7 Close the front cover of the sorter stapler.

Removing Jammed Staples

Note

- Staples might be jammed because of curled copies. In this case, try turning the copy paper over in the tray. If there is no improvement, change the copy paper with less curl.
- After removing jammed staples, staples might not be ejected the first few times you try to use the stapler.

1 Open the front cover of the sorter stapler.

2 Raise the staple unit towards you.

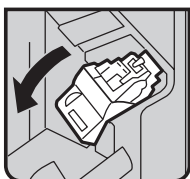

3 Remove the cartridge.

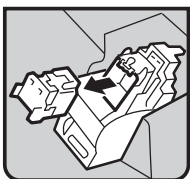

4 While pushing the lock, pull the top cover.

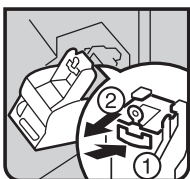

5 Remove the jammed staple.



6 Push the top cover until it clicks.



TRSP042E

Note

- If the staple is coming out, press it to the proper position.

7 Reinstall the cartridge until it clicks.

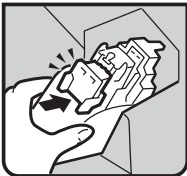

TRSP039E

8 Push the staple unit to the original position.

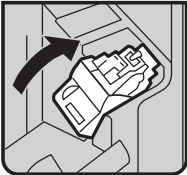

TRSP034E

9 Close the front cover of the sorter stapler.

6. Changing the Machine's Settings

Changing Paper Size

Note

- Be sure select the paper size with the user tools or misfeeds might occur.

Reference

For the paper sizes, weight, and capacity that can be set in each tray. ⇒ P.197 "Mainframe".

1 Make sure that the paper tray is not being used.

2 Pull out the paper tray until it stops.

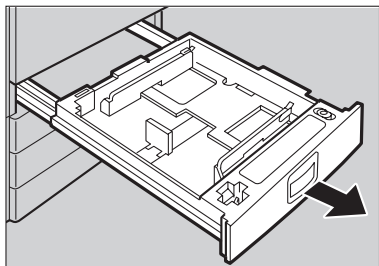

TLCV050E

Note

- Remove any remaining copy paper.

3 Remove the screws fastening the side fences using the screwdriver.

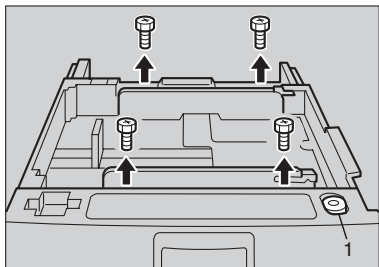

TRSY010E

1. Screwdriver

Note

- A screwdriver is contained in the front area of the tray.

4 Re-position the side fence to the paper size you want to use.

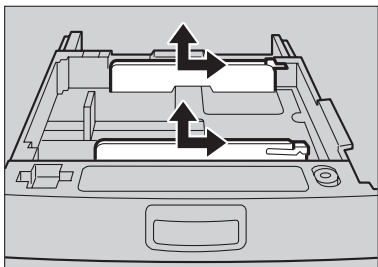

TRSY030E

5 Fasten the fences with screws.

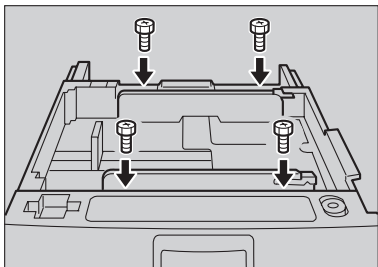

TRSY040E

6 Adjust the back fence to the new paper size.

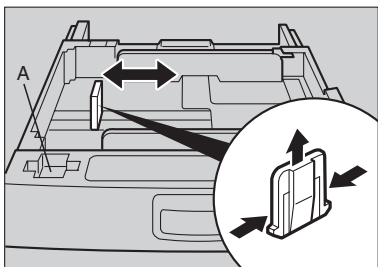

TRSY020E

Note

□ For 11" × 17" paper, put the back fence inside A.

7 Square the paper and set it in the tray.

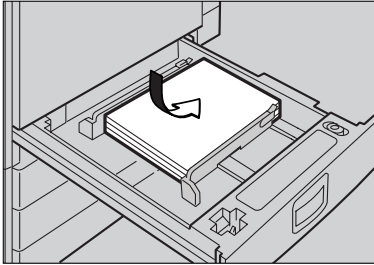

TRSY060E

Note

- Shuffle the paper before setting it in the tray.
- Do not stack paper over the limit mark.
- Make sure the leading corners of the paper are under the corners.

8 Push the paper tray in until it stops.

9 Select the paper size with the user tools.

6

Changing Paper Size with the User Tools

1 Follow the steps 1 to 8 on ⇒ P.169 “Changing Paper Size”.

2 Press the [User Tools] key.

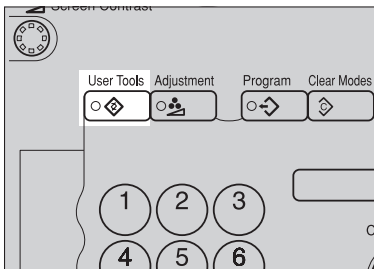

ZCMS021N

3 Press the [System Settings] key.



4 Press the [Next] key until Tray Paper Size is displayed.

5 Press the [Change] key to select the tray.

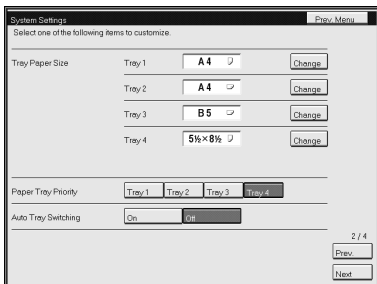

6 Select the paper size, then press the [OK] key.

7 Press the [User Tools] key to exit from the user tools.

User Tools

Accessing the User Tools

This section is for the key operators in charge of this machine. You can change or set the machine's default settings.

Note

- Do not forget to exit the user tools menu after accessing it.

1 Press the **[User Tools]** key.

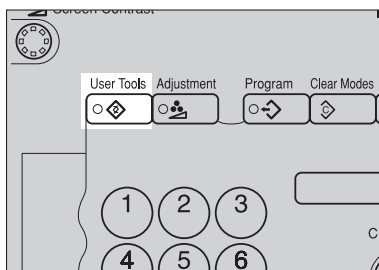

2 Press the **[System Settings]** or **[Copier Features]** key.



3 Select the desired user tools menu.

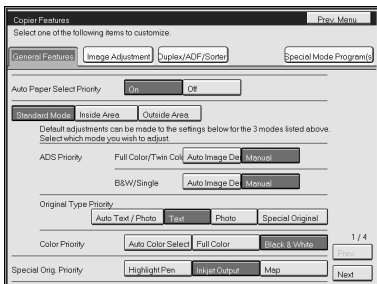

Note

- [Next]: Press to go to the next page.
- [Prev.]: Press to go back to the previous page.

4 Change the settings by following the instructions on the panel display.

Note

- [Prev. Menu] key: Press to return to the previous menu.
- [Cancel] key: Press to return to the previous menu without changing any data.

6

Exiting from the User Tools

1 After changing the user tools settings, press the [User Tools] key.

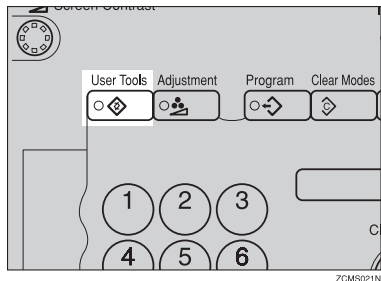

Note





- The settings are not canceled even if the operation switch is turned off or the [Clear Modes] key is pressed.







Setting You can Change with the User Tools (System Settings)



Reference





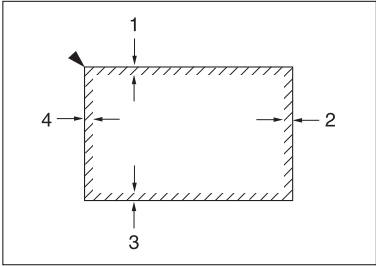

For how to access the user tools, ⇒ P.173 “Accessing the User Tools”.

System settings

Menu	Description
Function Priority	<p>You can specify the mode to be displayed immediately after the operation switch is turned on or System Reset mode is turned on.</p> <p> Note</p> <p><input type="checkbox"/> Default: <i>Copier</i></p>
Panel Tone	<p>The key tone sounds when a key is pressed. This beeper can be turned on or off.</p> <p> Note</p> <p><input type="checkbox"/> Default: <i>On</i></p>
Ready / Tone	<p>Choose whether the machine beeps when it becomes ready for a copy run after power up.</p> <p> Note</p> <p><input type="checkbox"/> Default: <i>On</i></p> <p><input type="checkbox"/> When the “Panel Tone” is set to Off, the beeper does not sound even if the “Ready/Tone” is set to On.</p>
Auto Timer	<p>The machine turns itself off automatically to conserve energy after your job is finished, after the selected time. This function called “Auto Off”. The time can be set from 1 to 240 minutes.</p> <p> Note</p> <p><input type="checkbox"/> Default: <i>60 minutes</i></p>
Control Panel Off Timer	<p>The machine enters Energy Saver mode automatically after your job is finished, after the selected time. The time can be set from 10 to 990 seconds (in 10 seconds steps), or off. In Energy Saver mode, the panel display turns off.</p> <p> Note</p> <p><input type="checkbox"/> Default: <i>On (60 seconds)</i></p>

Menu	Description
Control Panel Off Level	<p>The machine enters Energy Saver Mode automatically after your job is finished.</p> <p>Three Energy Saver levels are available.</p> <ul style="list-style-type: none"> • Level 1 The back light of the panel display goes off. Warm-up time: 0 seconds • Level 2 Power consumption approximately A 25% decrease compared to stand-by. Warm-up time: Approximately 80 seconds • Level 3 Power consumption: Approximately A 50% decrease compared to stand-by. Warm-up time: Approximately 140 seconds <p> Note <input type="checkbox"/> Default: <i>Level 1</i></p>
System Reset Timer (Printer Option Required)	<p>The machine returns to its prioritized mode automatically a certain time after your job is finished, after the selected time. The time can be set from 10 to 990 seconds (in 10 seconds steps), or off.</p> <p> Note <input type="checkbox"/> Default: <i>On (60 seconds)</i></p>
Function Reset Timer (Printer Option Required)	<p>When Interleave Print is turned on and a print job comes along while the machine is busy printing another job, this delay specifies how long the machine will wait before switching to the priority print job.</p> <p>The time can be set from 10 to 990 seconds.</p> <p> Note <input type="checkbox"/> Default: <i>On (60 seconds)</i> <input type="checkbox"/> The optional printer is required to use this function.</p>
Tray Paper Size	<p>Select the size of the copy paper set in the paper tray.</p> <p> Note <input type="checkbox"/> If the specified paper size differs from the size of paper actually set in the paper tray, a paper misfeed might occur because the paper size is not detected correctly.</p> <p> Reference For details, => P.197 "Mainframe".</p>
Paper Tray Priority	<p>You can select the paper tray which will be selected as a default in the following conditions:</p> <ul style="list-style-type: none"> • When the main power switch or operation switch is turned on. • When System Reset or Auto Reset mode is turned on. • When the [Clear Modes] key is pressed. • When the Auto Paper Select mode is not selected. <p> Note <input type="checkbox"/> Default: <i>Tray 1</i></p>

Menu	Description
Auto Tray Switching	<p>If you load paper of the same size in two or more trays, the machine automatically shifts another tray when the tray in use runs out of paper. You can set or cancel this setting.</p> <p> Note</p> <ul style="list-style-type: none"> <input type="checkbox"/> Default: <i>Off</i> <input type="checkbox"/> This function is not available in Area Editing Mode.
3 Side Full Bleed	<p>When this mode is off, narrow margins on all 4 sides of the original are not copied.</p> <div style="text-align: center;">  <p style="text-align: right; font-size: small;">GCGENK&E</p> </div> <p>1: $2\pm 2\text{mm}/0.08''\pm 0.08''$ 2: $2\pm 2\text{mm}/-1.5\text{mm}, 0.08'' + 0.08''/-0.06$ 3: $2\pm 2\text{mm}, 0.08''\pm 0.08''$ 4: $4\pm 2\text{mm}, 0.2''\pm 0.08''$</p> <p>When you turn it on, margins 1, 2 and 3 are copied.</p> <p> Note</p> <ul style="list-style-type: none"> <input type="checkbox"/> Default: <i>Off</i> <input type="checkbox"/> You cannot cancel the leading edge margin (margin 4).
Bypass Tray Custom Size	<p>You can register non-standard size paper when you make copies with the bypass tray.</p> <ol style="list-style-type: none"> ① Press the [Change] key. ② Enter the horizontal size with the number keys, then press the [#] key. ③ Enter the vertical size with the number keys, then press the [#] key. ④ Press the [OK] key. <p> Note</p> <ul style="list-style-type: none"> <input type="checkbox"/> Adjustment value: <ul style="list-style-type: none"> • Metric version: <ul style="list-style-type: none"> Vertical: 100 - 305mm Horizontal: 140 - 457mm • Inch version: <ul style="list-style-type: none"> Vertical: 3.9" - 12.0" Horizontal: 5.5" - 18.0" <input type="checkbox"/> Default: <i>Custm 1</i>







Menu	Description
Interleave Print	<p>Turn this feature on to give print jobs priority. If a print job comes along while another job is in progress, the current job will be temporarily suspended while the print job is printed.</p> <p> Note</p> <p><input type="checkbox"/> If you select “On”, various documents output to the same tray. To avoid mixing copies, you can select “Off” or specify the output bin for each function.</p> <p><input type="checkbox"/> Default: <i>On</i></p>
Interleave Priority	<p>Which function has priority when interleaving delivery of prints, copies and faxes.</p> <ul style="list-style-type: none"> • Copier • Printer • Fax <p> Note</p> <p><input type="checkbox"/> Default: <i>Copier</i></p>
Copy Count Display	<p>The copy counter can be set to show the number of copies made (Count Up), or the number of copies remaining to be made (Count Down).</p> <p> Note</p> <p><input type="checkbox"/> Default: <i>Up</i></p>
Display Color Setting	<p>You can change the color of the display editor.</p> <p> Note</p> <p><input type="checkbox"/> Default: <i>Blue</i></p>
Key Operator Tools	<p>If you select “On”, only operators who know the key operator code can access the “Key Operator Tools” in the System Settings and Copier Features.</p> <p> Note</p> <p><input type="checkbox"/> Default: <i>Off</i></p> <p><input type="checkbox"/> If you select “On”, you should register the key operator code.</p>
AOF(Keep It On.)	<p> Note</p> <p><input type="checkbox"/> For details about this function, contact your service representative.</p>
Output Tray (For 3-bin sorter only)	<p>You can specify a bin to which documents are delivered for each feature (Copy, printer and fax).</p> <p> Note</p> <p><input type="checkbox"/> Default:</p> <ul style="list-style-type: none"> • Copier: <i>First Bin</i> • Printer: <i>Second Bin</i> • Fax: <i>Third Bin</i>







Settings You can Change with the User Tools (Copier Features)













Reference





For how to access the user tools, ⇒ P.173 “Accessing the User Tools”.

General Features

Menu	Description
Auto Paper Select Priority	By default, Auto Paper Select is selected just after the machine is turned on or when modes are cleared. You can cancel this setting.  Note <input type="checkbox"/> Default: <i>On</i>
ADS Priority (FC/Twin)	By default, Manual Image Density is selected in Full Color mode just after the machine is turned on or when modes are cleared. You can cancel this setting so that the Auto Image Density is selected.  Note <input type="checkbox"/> Default: <i>Manual</i>
ADS Priority (B&W/SC)	As a default setting, Manual Image Density is selected in Black & White, Single Color, and Twin Color mode just after the machine is turned on or when modes are cleared. You can cancel this setting.  Note <input type="checkbox"/> Default: <i>Manual</i>
Original Type Priority	You can select the original image type (Auto Text/Photo mode, Text mode, Photo mode, or Special Original mode) that is selected automatically just after the machine is turned on or when modes are cleared.  Note <input type="checkbox"/> Default: <i>Auto Text/Photo mode</i>
Color Priority	You can select the color mode (Auto Color Select mode, Full Color mode, or Black & White mode) that is selected automatically just after the machine is turned on or when modes are cleared.  Note <input type="checkbox"/> Default: <i>Auto Color Select mode</i>
Special Orig. Priority	You can select the special original type (Highlight Pen, Inkjet Output, or Map) that is selected automatically just after the machine is turned on or when modes are cleared.  Note <input type="checkbox"/> Default: <i>Highlight Pen</i>
Photo Type(Auto Text/Photo) (Auto Text/Photo)	You can select the photo type (Press Print, Glossy Photo, or 2nd Generation) in Auto Text/Photo mode that is selected automatically just after the machine is turned on or when modes are cleared.  Note <input type="checkbox"/> Default: <i>Press Print</i>

Menu	Description
Photo Type(Auto Text/Photo) (Photo)	<p>You can select the photo type (Press Print, Glossy Photo, or 2nd Generation) in Photo mode that is selected automatically just after the machine is turned on or when modes are cleared.</p> <p> Note <input type="checkbox"/> Default: <i>Press Print</i></p>
Copy Reset Timer	<p>The machine returns to its initial condition automatically after your job is finished. The time can be set from 10 to 990 seconds, or this function can be turned off.</p> <p>① Select [On] or [Off] keys. ② When you select [On], enter the time with the number keys. Then, press the [#] key.</p> <p> Note <input type="checkbox"/> Default: <i>On (60 seconds)</i></p>
Maximum Copy Quantity	<p>The maximum copy quantity can be set from 1 to 100.</p> <p> Note <input type="checkbox"/> Default: <i>Off</i></p>
Tone: Original on Platen	<p>The key tone sounds when you forgot to remove originals after copying.</p> <p> Note <input type="checkbox"/> Default: <i>Off</i> <input type="checkbox"/> When the "Panel Tone" is set to Off, the beeper does not sound even if the "Original Tone" is set to On.</p>
Front Side Margin Adjust.	<p>You can adjust the front side margin direction and width that is selected as a default in "Front Side Margin Adjust" mode. You can change this setting.</p> <ul style="list-style-type: none"> • Metric Version: left/20mm - right/20mm in 1mm steps. • Inch Version: left/0.8" - right/0.8" in 0.1" steps. <p> Note <input type="checkbox"/> Default:</p> <ul style="list-style-type: none"> • Metric version: <i>left/right 0mm</i> • Inch version: <i>left/right 0"</i>
Back Side Margin Adjust.	<p>You can adjust the back side margin direction and width that is selected as a default in Back Side Margin Adjust. You can change this setting.</p> <ul style="list-style-type: none"> • Metric Version: left/20mm - right/20mm in 1mm steps. • Inch Version: left/0.8" - right/0.8" in 0.1" steps. <p> Note <input type="checkbox"/> Default:</p> <ul style="list-style-type: none"> • Metric version: <i>left/right 0mm</i> • Inch version: <i>left/right 0"</i>



Menu	Description
1→2 Duplex Auto Margin Adjust.	<p>When you use 1 Sided → 2 Sided mode, the machine sets the back side margin automatically.</p> <p> Note</p> <p><input type="checkbox"/> Default: <i>Off</i></p>
Magnification Setting	<p>Up to 2 reproduction ratios which you frequently use can be registered.</p> <p>① Press the [Setting] key.</p> <p>② Select the [User Ratio 1] or [User Ratio 2] key.</p> <p>③ Enter your desired ratio with the number keys. Then press the [#] key.</p> <p>④ Press the [OK] key.</p>
Initial Mode Setting	<p>You can set the machine to recall program setting when the machine is turned on or when modes are cleared.</p> <p> Note</p> <p><input type="checkbox"/> Default: <i>Normal</i></p>
Show Editor Grid (Option)	<p>You can turn the grid snap on or off in the display editor. The grids may help you to mark a right angle shape.</p> <p> Note</p> <p><input type="checkbox"/> Default: <i>Off</i></p>
Area Shape Priority (Option)	<p>When you designate areas, you can select the first designated shape.</p> <p>① Select the  (Rectangle),  (R.A.Polygon),  (Polygon),  (Closed Loop), or  (Multi. Closed Loop) key.</p> <p> Note</p> <p><input type="checkbox"/> Default:  (<i>Rectangle</i>) key</p>
B&W Copy Default: Text	<p>When you select Black & White copy mode, you can select text mode regardless of the Original Type Priority setting.</p> <p> Note</p> <p><input type="checkbox"/> Default: <i>Off</i></p>
Image Rotation	<p>When copying onto copy paper of the same size but different orientation in Auto Paper Select or Auto Reduce/Enlarge mode, rotate the image by 90 degrees.</p> <p> Note</p> <p><input type="checkbox"/> Default: <i>On</i></p>
Priority Tray for FC	<p>When copying in Full Color mode, the paper in the selected paper tray can be used.</p> <p> Note</p> <p><input type="checkbox"/> Default: <i>Off</i></p> <p><input type="checkbox"/> When you select Black copy mode, you can select Text mode regardless of the Orig. Mode Priority setting.</p>

Menu	Description
Key Operator Tools	<p>Use these tools to manage use of the machine.</p> <p> Note</p> <p><input type="checkbox"/> Enter a previously registered key operator code with the number keys.</p> <p> Reference</p> <p>For details about the key operator code, ⇒ P.175 "System settings".</p>
Accessible Modes Setting	<p>You can assign user codes to each color mode. Operators must input their user codes before using each color mode (Full color, Black & White, Single, Twin Color).</p> <p>The machine keeps count of the number of copies made under each user code.</p> <p>① Select your desired color mode.</p>
User Codes Setting	<p>❖ Program</p> <p>You can register the user codes.</p> <p>① Press the [Program] key.</p> <p>② Enter the user code with the number keys. Then press the [#] key.</p> <p>③ Select the color mode from [Full Color], [Black & White], [Single], or [Twin Color] key.</p> <p> Note</p> <p><input type="checkbox"/> You can up to 50 user codes.</p> <hr/> <p>❖ Change</p> <p>You can change the user codes.</p> <p>① Press the [Change] key.</p> <p>② Select the user code.</p> <p>③ Enter the user code with the number keys. Then press the [#] key.</p> <p>④ Select the color mode from [Full Color], [Black & White], [Single], or [Twin Color] key.</p> <hr/> <p>❖ Clear</p> <p>You can clear the user codes.</p> <p>① Press the [Clear] key.</p> <p>② Select the user code that you want to clear.</p> <p>③ If you want to clear the all user codes of the page, press the [Select All] key.</p> <p> Note</p> <p><input type="checkbox"/> If you want to change the [Select All], press the [Clr All Select] key.</p> <p>④ Press the [OK] key.</p> <p>⑤ Press the [Yes] key.</p> <hr/> <p>❖ Delete All</p> <p>You can delete the all registered user codes.</p> <p>① Press the [Delete All] key.</p> <p>② Press the [Yes] key.</p>

Menu	Description
Counter Manager	<p>❖ Counter List Print</p> <p>You can print data for all user codes.</p> <ol style="list-style-type: none"> ① Press the [Counter List Print] key. ② Press the [Print Start] key.
	<p>❖ Reset Counters</p> <p>You can check the number of copies made using each user code, and clear each code's counter.</p> <ol style="list-style-type: none"> ① Press the [Reset Counters] key. ② Input the user code you want to check the number of copies made under the number keys. ③ Press the [OK] key. ④ Press the [Yes] key.
	<p>❖ Delete All</p> <p>You can reset the counter for all user codes.</p> <ol style="list-style-type: none"> ① Press the [Delete All] key. ② Press the [Yes] key.





Image Adjustment



6

Menu	Description
Background Dens. of A.D.S. (FC/Twin)	<p>The Auto Image Density levels in Full Color mode can be made lighter or darker (5 levels).</p> <p> Note</p> <p><input type="checkbox"/> Default: <i>level 3</i></p>
A.C.S. Priority	<p>You can select whether color images or black & white images are priority detected in Auto Color Select mode.</p> <p> Note</p> <p><input type="checkbox"/> Default: <i>Full Color</i></p>
Color Sensitivity	<p>When in Color Erase, Color Conversion or Twin Color (Red & Black) mode, the function can be made more or less sensitive to the color to be erased or converted. It can be adjusted within 5 levels ("Narrow" to "Wide").</p> <p>For example, if red is selected as the color to be erased or converted, "Narrow" will result in only red being erased or converted, and "Wide" will result in other colors close to red being erased or converted.</p> <p> Note</p> <p><input type="checkbox"/> Default: <i>level 3</i></p>

Menu	Description
Inkjet Output Mode Setting	<p>Specifies the type of image adjustment for Inkjet Output mode.</p> <ul style="list-style-type: none"> • 1 – emphasize yellow • 2 – emphasize red and yellow • 3 – emphasize red and blue <p>If you want to emphasis yellow, select 1. If you want to emphasis red and yellow, select 2. If you want to emphasis red and blue, select 3.</p> <p> Note</p> <p><input type="checkbox"/> Default: 1</p>

Duplex/ADF/Sorter



Menu	Description
Duplex Tray Auto Clear	<p>When making two-sided copies from one-sided originals, if the last original is an odd page, the last copy will be automatically delivered with the reverse side blank. You can cancel this setting.</p> <p> Note</p> <p><input type="checkbox"/> Default: <i>On</i></p>
SADF Auto Reset Timer	<p>When you set one original at a time in the document feeder, the Auto Feed indicator lights for a selected time after an original is fed to show that the document feeder is ready for another original. The time can be set from 1 second to 99 seconds.</p> <p> Note</p> <p><input type="checkbox"/> Default: <i>5 seconds</i></p>
ADF Thin paper	<p>Use when changing the type of originals to be fed. Select this function to avoid damaging thin originals (40 - 52g/m², 11-14 lb) set in the document feeder.</p> <p> Note</p> <p><input type="checkbox"/> Default: <i>Off</i></p>
ADF Mixed Sizes	<p>By default, you cannot set originals of different sizes at one time in the document feeder. You can cancel this setting.</p> <p> Note</p> <ul style="list-style-type: none"> <input type="checkbox"/> Default: <i>Off</i> <input type="checkbox"/> If you select [On], the copying speed will be reduced. <input type="checkbox"/> When setting different length originals, all originals must be flush with the back fence of the document feeder. <input type="checkbox"/> Smaller originals might be skewed a little.
ADF Auto Paper Select	<p>By default, Auto Paper Select is selected when you set originals in the document feeder. You can cancel this setting.</p> <p> Note</p> <p><input type="checkbox"/> Default: <i>On</i></p>

Menu	Description
Full Color Copy Sorting	<p>You can disable sorting, stacking, or stapling in Full Color mode to maximize quality of full color copies.</p> <p> Note</p> <p><input type="checkbox"/> Default: <i>On</i></p>
Auto Sort Mode	<p>You can have the machine select Sort mode automatically when you insert two or more originals in the document feeder and make two or more copies from each original.</p> <p> Note</p> <p><input type="checkbox"/> Default: <i>On</i></p>

Special Mode Program(s)

Special Mode	Use to recall the special modes set by your service representative.
--------------	---

Auto Color Calibration

Copy Mode/Printer Mode	<p>When the tone of a specific color is strong or the color tone of copies is different from that of originals, perform the procedure below to adjust the balance of the 4 basic colors.</p> <ol style="list-style-type: none"> ① Press the [Auto Color Calibration] key. ② If your machine has the printer option installed, select Copy Mode or Printer Mode. Then press the [Start] key. ③ Press the [Print Start] key. <p> Note</p> <p><input type="checkbox"/> The test pattern is delivered to the copy tray.</p> <ol style="list-style-type: none"> ④ Set the test pattern on the exposure glass. Then press the [Scan Start] key. <p> Limitation</p> <p><input type="checkbox"/> You cannot set the test pattern in the document feeder.</p> <p> Note</p> <p><input type="checkbox"/> To return to the previous setting, press the [Prev. Setting] key.</p>
------------------------	--

Do's and Don'ts

CAUTION:

- *Unplug the power cord from the wall outlet before you move the equipment. While moving the equipment, you should take care that the power cord will not be damaged under the equipment.*
- When you use this equipment for a long time in a confined space without good ventilation, you may detect an odd smell. To keep the workplace comfortable, we recommend you keep it well ventilated.
- Do not press areas on or around the fusing unit. These areas get hot.
- After making copies continuously, the exposure glass may feel warm this is not a malfunction.
- You might feel warm around the ventilation hole. This is caused by exhaust air, and not a malfunction.
- Do not turn off the operation switch while copying or printing. Make sure that all copying or printing has finished.
- The machine might fail to produce good copy images if there should occur condensation inside caused by temperature change.
- Do not open the covers of machine while copying or printing. If you do, mis-feeds might occur.
- Do not move the machine while copying or printing.
- If you operate the machine improperly or a failure occurs on the machine, your machine settings might be lost. Be sure to take a note of your machine settings.
- Supplier shall not be liable for any loss or damages resulting from a failure on the machine, loss of machine settings, and use of the machine.

Where to Put Your Machine

Machine Environment

Your machine's location should be carefully chosen because environmental conditions greatly affect its performance.

Optimum environmental conditions

⚠ CAUTION:

- *Keep the equipment away from humidity and dust. Otherwise a fire or an electric shock might occur.*
- *Do not place the equipment on an unstable or tilted surface. If it topples over, it could cause injury.*

⚠ CAUTION:

- *If you use the equipment in a confined space, make sure there is a continuous air turnover.*

- Temperature: 10-32°C, (50-89.6°F)(humidity to be 54% at 32°C, 89.6°F)
- Humidity: 15-80% (temperature to be 27°C, 80.6°F at 80%)
- A strong and level base.
- The machine must be level within 5mm, 0.2" both front to rear and left to right.
- To avoid possible built-up ozone, make sure to locate this machine in a large well ventilated room that an air turnover of more than 30m³/hr/person.

Environments to avoid

- Locations exposed to direct sunlight or strong light (more than 2,000 lux).
- Locations directly exposed to cool air from an air conditioner or heated air from a heater. (Sudden temperature changes might cause condensation within the machine.)
- Please where the machine might be subjected to frequent strong vibration.
- Dusty areas.
- Areas with corrosive gases.

Power Connection

⚠ WARNING:

- ***Only connect the machine to the power source described on the inside front cover of this manual. Connect the power cord directly into a wall outlet and do not use an extension cord.***
- ***Do not damage, break or make any modifications to the power cord. Do not place heavy objects on it. Do not pull it hard nor bend it more than necessary. These actions could cause an electric shock or fire.***

⚠ CAUTION:

- *Unplug the power cord from the wall outlet before you move the equipment. While moving the equipment, you should take care that the power cord will not be damaged under the equipment.*

⚠ CAUTION:

- *When you disconnect the power plug from the wall outlet, always pull the plug (not the cable).*
- When the main power switch is in the Stand-by position, the optional anti-condensation heaters are on. In case of emergency, unplug the machine's power cord.
- When you unplug the power cord, the anti-condensation heaters turn off.
- Make sure the plug is firmly inserted in the outlet.
- Voltage must not fluctuate than 10%
- The socket-outlet shall be installed near the equipment and shall be easily accessible.

Access to Machine

Place the machine near the power source, providing clearance as shown.

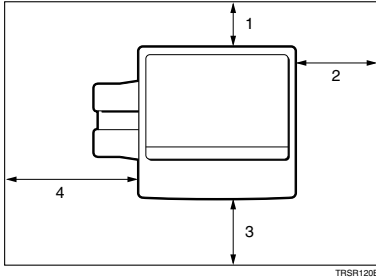

1. Rear: more than 10cm, 4.0"

2. Right: more than 37cm, 14.6"

3. Front: more than 70cm, 27.6"

4. Left: more than 40cm, 15.8"

 **Note**

- For the required space when options are installed, please contact your service representative.

Maintaining Your Machine

If the exposure glass, platen cover or document feeder belt is dirty, you might not be able to make copies as you want. Clean them if you find them dirty

Note

- Do not use chemical cleaner or organic solvent, such as thinner or benzene. If they get into the machine or melt plastic parts, a failure might occur.
- Do not clean parts other than those specified in this manual. Such parts should be cleaned by your service representative.
- Wipe the machine with a soft, damp cloth. Then wipe it with a dry cloth to remove the water.

Exposure Glass

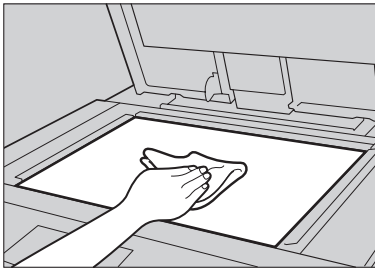

7

Platen Cover

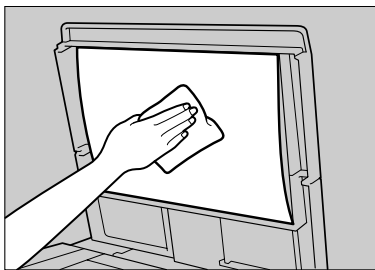

Document Feeder

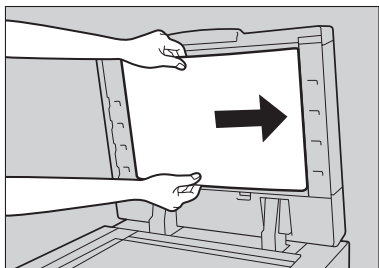

TASR150E

Remarks

Copier

- Be careful not to move the original during the scanning process.
- To avoid problems caused by curled copies, try turning over the paper stack in the paper tray. If there is no improvement, change to copy paper with less curl.
- Load paper with the copy side down in the paper trays. If copies are curled, try turning the copy paper over in the tray. If there is no improvement, change to copy paper with less curl.
- As a default setting, narrow margins on all four sides will not be copied as shown in the illustration.

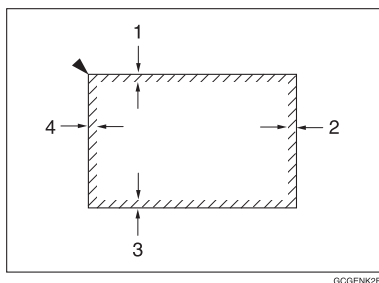





1. $2\pm 2\text{mm}, 0.08''\pm 0.08''$
2. $2+2/-1.5\text{mm}, 0.08''+0.08''/-0.06''$
3. $2\pm 2\text{mm}, 0.08''\pm 0.08''$
4. $5\pm 2\text{mm}, 0.2''\pm 0.08''$

Use and Storage of Supplies

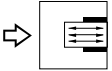
Copy Paper

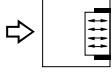
- Copy paper of the types or in the conditions listed below are not recommended for this copier.
 - Folded, curled, creased, or damaged paper
 - Torn paper
 - Perforated paper
 - Paper with conductive or low electrical resistance coating such as carbon or silver coating
 - Thermal paper, art paper
 - Thin paper that has low stiffness
 - Damp paper
 - Wavy paper
 - Stapled paper
 - Translucent paper
- Never use ink-jet printer paper to prevent failure.
- Use a proper type OHP transparency and set it in correct direction to prevent failure.
- Fan copy paper and OHP transparencies to get air between the sheets before loading.
- Do not touch copy paper if your fingers are wet or oily; finger prints may appear on the copy.
- Load paper with the copy side down in the paper trays. If copies are curled, try turning the copy paper over in the tray. If there is no improvement, change to copy paper with less curl.
- When copying on rough surface paper, the copy image may be light.
- When setting paper thinner than $64\text{g}/\text{m}^2$, 17 lb or translucent paper in the paper trays or bypass trays, set it as shown in the figure below. The paper is divided into the vertical and horizontal types depending on the texture flow direction. If you set thin paper or translucent paper in the reverse direction, a paper jam might occur. Since A3, B4, $11" \times 17"$, and $8\frac{1}{2}" \times 14"$ sizes of thin paper are set in the lengthwise direction in this machine, they must be of the vertical type.

	Texture flow	Setting paper in the paper trays	Setting paper in the bypass tray
Vertical type			 GCYOS1E
Horizontal type			 GCYOS2E

Paper Storage

Paper should always be stored properly. Improperly stored paper might result in poor image reproduction, creased copies, and paper misfeeds. Generally, avoid curling and absorption of moisture.

- Avoid storing paper in humid areas. Under high temperature and high humidity, or low temperature and low humidity conditions, store paper in a vinyl bag.
- Do not store paper where it will be exposed to heat.
- Store on a flat surface.
- Use older stock first.
- Do not lay heavy objects on paper.
- Keep open reams of paper in the package, and store as you would unopened paper.

Toner Storage

- Store in a cool, dark place.
- Never store toner where it will be exposed to heat.
- Do not lay heavy objects on toner container.

Mainframe

❖ **Configuration:**

Desktop

❖ **Process:**

Dry electrostatic transfer system

❖ **Resolution:**

600 dpi

❖ **Gradations:**

256 gradations

❖ **Originals:**

Sheet, book, objects

❖ **Original size:**

Maximum: A3, 11" × 17"

❖ **Copy paper size:**

- Trays:
A3, B4, A4, B5, A5, 11" × 17", 8¹/₂" × 14", 8¹/₂" × 13", 8¹/₂" × 11", 8" × 13", 5¹/₂" × 8¹/₂"
- Bypass Tray:
⇒ P.37 "Copying from the Bypass Tray".

❖ **Copy paper weight:**





- Trays:
64 - 105g/m², 17 - 28 lb
- Bypass tray:
52 - 160g/m², 14 - 43 lb
- Auto Duplex Tray:
64 - 105g/m², 17 - 28 lb (When you use paper heavier than 104.7g/m², 28 lb, use the bypass feed table and select Thick mode.)

❖ **Copy paper capacity:**





- Tray:
500 sheet
- Bypass Tray:
50 sheets

❖ **Copying speed (full size):**





❖ **Full color (4 colors)**

	Standard mode	OHP/Thick mode
A4  , 8 ¹ / ₂ " × 11" 	6 copies/minute	3 copies/minute
A3  , 11" × 17" 	3 copies/minute	1.5 copies/minute





❖ **Black, Yellow, Magenta, Cyan:**

	Standard mode	OHP/Thick mode
A4  , 8 ¹ / ₂ " × 11" 	31 copies/minute	5 copies/minute
A3  , 11" × 17" 	15 copies/minute	2.5 copies/minute





❖ **Blue (Magenta + Cyan), Green (Yellow + Cyan):**

	Standard mode	OHP/Thick mode
A4  , 8 ¹ / ₂ " × 11" 	9 copies/minute	4 copies/minute
A3  , 11" × 17" 	4.5 copies/minute	2 copies/minute

❖ **Red (Yellow + Magenta):**

	Standard mode	OHP/Thick mode
A4  , 8 ¹ / ₂ " × 11" 	7 copies/minute	3.5 copies/minute
A3  , 11" × 17" 	3.5 copies/minute	1.5 copies/minute

❖ **Black + Yellow, Black + Magenta, Black + Cyan:**

	Standard mode	OHP/Thick mode
A4  , 8 ¹ / ₂ " × 11" 	7 copies/minute	3.5 copies/minute
A3  , 11" × 17" 	3.5 copies/minute	1.5 copies/minute

❖ **First copy time:**

	Standard mode	OHP/Thick mode
Full colors (4 colors)	22.4 seconds	35 seconds
Black, Yellow, Magenta, Cyan	8 seconds	23 seconds
Blue (Magenta + Cyan), Green (Yellow + Cyan)	16 seconds	27 seconds
Red (Yellow + Magenta)	16 seconds	27 seconds
Black + Yellow, Black + Magenta, Black + Cyan	16 seconds	27 seconds

❖ **Non-reproduction area:**

- Leading edge:
5±2mm, 0.2"±0.08"
- Trailing edge:
2+2/-1.5mm, 0.08"+0.08"/-0.06"
- Side:
2±2mm, 0.08"±0.08" (Total 4mm, 0.16" or less)

❖ **Toner replenishment:**

Cartridge (220g/cartridge)

❖ **Warm-up time:**

Less than 270 seconds (20°C, 68°F)

❖ **Reproduction ratios:**

5 enlargement and 7 reduction

	Metric version	Inch version
Enlargement	400%	400%
	200%	200%
	141%	155%
	122%	129%
	115%	121%
Full size	100%	100%
Reduction	93%	93%
	82%	85%
	75%	78%
	71%	73%
	65%	65%
	50%	50%
	25%	25%

❖ **Power consumption:**

	Copier only	Full system ^{*1}
Warm up	1.3kW	1.3kW
Stand-by	0.4kW	0.4kW
During printing	1.1kW	1.3kW
Maximum	less than 1.5kW	less than 1.5kW

^{*1} Full system: Mainframe with the document feeder, 3-bin sorter stapler and 1500 sheet tray unit. Optional printer installed.

❖ **Noise Emission *1**

❖ **Sound power level**

	Mainframe only	Complete System *3
Stand-by	less than 49 dB (A)	less than 50 dB (A)
During printing	less than 66 dB (A)	less than 66 dB (A)

❖ **Sound pressure level *2**

	Mainframe only
Stand-by	less than 49 dB (A)
During printing	less than 66 dB (A)

*1 The above measurements made in accordance with ISO 7779 are actual value.

*2 It is measured at the position of the operator.

*3 The Complete System consists of mainframe and Sorter Stapler.

❖ **Dimensions (W × D × H up to the exposure glass):**

620 × 744 × 620mm, 24.5" × 29.3" × 24.5"

❖ **Weight:**

Approximately 112kg, 244.7 lb

 **Note**









- Specifications are subject to change without notice.

Document Feeder (Option)

❖ Original Feed:

Automatic reverse document feed - ARDF mode
Automatic document feed - ADF mode
Semi-automatic document feed - SADF mode

❖ Original size:

A3  - B6   (B6   cannot be used in ARDF mode)
11" × 17" , 8¹/₂" × 13" , 8¹/₂" × 5¹/₂"  

❖ Original weight:

- SADF mode, ADF mode:
40 - 128g/m², 14 - 34 lb

- ARDF mode:

52 - 105g/m², 14 - 28 lb
(For 40 - 52g/m², 11 - 14 lb originals, use ADF Thin Paper mode. B6  cannot be used in ARDF Thin Paper mode)

❖ Maximum number of originals to be set:

50 sheets (80g/m², 20 lb)

❖ Original set:

Face up, First sheet on top

❖ Original transport:

One flat belt

❖ Maximum power consumption:

45W (Power is supplied from the main frame.)

❖ Weight:

Less than 10.5kg, 23.2 lb

❖ Dimensions (W × D × H):

610 × 507 × 130mm, 24.1" × 20.0" × 5.2"

Note

Specifications are subject to change without notice.













20-bin Sorter Stapler (Option)

◆ Number of bins:













20 bins + proof tray

◆ Paper size for bins (Normal paper mode):

• Sort/Stack:

A3 , B4 , A4  , B5  , 11" × 17" , 10" × 14" , 8 1/2" × 14" , 8 1/2" × 13" , 8 1/2" × 11"  , 12" × 18" 

• Staple:

A3 , B4 , A4  , B5  , 11" × 17" , 10" × 14" , 8 1/2" × 14" , 8 1/2" × 13" , 8 1/2" × 11"  

◆ Paper weight for bins:

52g/m² - 160g/m², 14 - 42 lb

◆ Bin capacity (Normal paper mode):

• Sort:

A4, 8 1/2" × 11" or smaller: 30 sheets (80g/m², 20 lb)

A4, 8 1/2" × 13" or larger: 25 sheets (80g/m², 20 lb)

• Stack:

A4, 8 1/2" × 11" or smaller: 25 sheets (80g/m², 20 lb)

A4, 8 1/2" × 13" or larger: 20 sheets (80g/m², 20 lb)

◆ Stapler capacity (Normal paper mode):

2-30 sheets (80g/m², 20 lb)

◆ Proof tray capacity:

100 sheets (80g/m², 20 lb)

◆ Maximum power consumption:

35W (Power is supplied from the main frame.)

◆ Weight:

20.5kg, 45.2 lb

◆ Dimensions (W × D × H):

430 × 570 × 680mm, 17.0" × 22.5" × 26.8"

Note

Specifications are subject to change without notice.













10-bin Sorter Stapler (Option)

◆ Number of bins:











10 bins + proof tray

◆ Paper size for bins:

• Sort/Stack:

A3 , B4 , A4  , B5  , 11" × 17" , 10" × 14" , 8 1/2" × 14" , 8 1/2" × 13" , 8 1/2" × 11"  

• Staple:

A3 , B4 , A4  , B5 , 11" × 17" , 10" × 14" , 8 1/2" × 14" , 8 1/2" × 13" , 8 1/2" × 11"  

◆ Paper weight for bins:

52g/m² - 160g/m², 14 - 42 lb

◆ Bin capacity:

• Sort:

A4, 8 1/2" × 11" or smaller: 30 sheets (80g/m², 20 lb)

B4, 8 1/2" × 13" or larger: 25 sheets (80g/m², 20 lb)

• Stack:

A4, 8 1/2" × 11" or smaller: 25 sheets (80g/m², 20 lb)

B4, 8 1/2" × 13" or larger: 20 sheets (80g/m², 20 lb)

◆ Stapler capacity:

2-20 sheets (80g/m², 20 lb)

◆ Proof tray capacity:

100 sheets (80g/m², 20 lb)

◆ Maximum power consumption:

33W (Power is supplied from the main frame.)

◆ Weight:

12.4kg, 27.4 lb

◆ Dimensions (W × D × H):

381 × 548 × 443mm, 15.0" × 21.6" × 17.5"

Note

Specifications are subject to change without notice.

3-bin Sorter (Option)

◆ Number of bins:

3 bins

◆ Paper size for bins:

A3, B4, A4, B5, A5, B6, A6, 11" × 17", 10" × 14", 8¹/₂" × 14", 8¹/₂" × 13", 8¹/₄" × 13", 8¹/₂" × 11", 5¹/₂" × 8¹/₂", 12" × 18"

◆ Paper weight for bins:

- Face-up:
1st bin: 52 - 160g/m², 14 - 42 lb
2nd and 3rd bins: 52 - 105g/m², 14 - 28 lb
- Face-down:
64 - 105g/m², 17 - 28 lb

◆ Bin capacity (Normal paper mode):

- 1st bin:
A4, 8¹/₂" × 11" or smaller: 500 sheets (80g/m², 20 lb)
B4, 8¹/₂" × 13" or larger: 250 sheets (80g/m², 20 lb)
- 2nd and 3rd bins:
A4, 8¹/₂" × 11" or smaller: 250 sheets (80g/m², 20 lb)
B4, 8¹/₂" × 13" or larger: 125 sheets (80g/m², 20 lb)

◆ Maximum power consumption:

30W (Power is supplied from the main frame.)

◆ Weight:

Less than 14kg, 30.9 lb

◆ Dimensions (W × D × H):

361 × 483 × 427mm, 14.3" × 19.1" × 16.9"

📖 Note

- ☐ Specifications are subject to change without notice.

1000-sheet Tray Unit (Option)

❖ **Copy paper weight:**

64 - 105g/m², 17 - 28 lb

❖ **Available paper size:**

A3☐, B4☐, A4☐☐, B5☐☐, A5☐, 11"×17"☐, 8¹/₂"×14"☐, 8¹/₂"×11"☐☐,
8"×13"☐, 8¹/₂"×13"☐, 5¹/₂"×8¹/₂"☐

❖ **Maximum power consumption:**

50W (Power is supplied from the main frame.)

❖ **Paper capacity:**

500 sheets × 2 trays

❖ **Dimensions (W × D × H):**

620 × 680 × 390mm, 24.5" × 26.8" × 15.4"

❖ **Weight:**

Approx. 32kg, 70.6 lb

 **Note**

☐ Specifications are subject to change without notice.

1500-sheet Tray Unit (Option)

❖ **Copy paper weight:**

- 64 - 105g/m², 17 - 28 lb

❖ **Available paper size:**

A3☐, B4☐, A4☐☐, B5☐☐, A5☐, 11"×17"☐, 8¹/₂"×14"☐, 8¹/₂"×11"☐☐,
8"×13"☐, 5¹/₂"×8¹/₂"☐

❖ **Maximum power consumption:**

50W (Power is supplied from the main frame.)

❖ **Paper capacity:**

500 sheets × 3 trays

❖ **Dimensions (W × D × H):**

620 × 680 × 390mm, 24.5" × 26.8" × 15.4"

❖ **Weight:**

Approx. 37kg, 81.6 lb

 **Note**

- ☐ Specifications are subject to change without notice.

Multi-access

You can carry out another job using a different function while the current job is being performed.

This allows you to handle your jobs efficiently regardless of how the machine is being used. For example:

- While making copies, the machine can send a fax message that has been stored in memory.
- The machine can receive print data in any mode.

Performing multiple functions simultaneously like this is called Multi-access.

Note

- You can choose which mode has highest priority for print jobs. The default is "Copy". See "Interleave Print" in ⇒ P.175 "System settings".
- If your machine is equipped with the optional 3-bin sorter, you can specify the tray used for each mode so that output can be delivered separately. If you require the optional 3-bin sorter, contact your local dealer or service representative. See "Output tray" ⇒ P.175 "System settings".

Sample operations

This chart is based on the following conditions:

- "16. Print Priority" is set to "Interleave" (See "16. Print Priority" in ⇒ P.175 "System settings").
- For details on operations under other conditions, contact your service representative.

		Mode after you select				Copy				Facsimile				Printer				
		Copying	Sort *1	Copying *2	Stapling *1	Transmission Operation/ Manual Reception Operation	Scanning an original for Memory Transmission	Memory Transmission	Immediate Transmission	Memory Reception	Printing Received Data	Data Reception	Printing	Sort Print	Stapling			
Copy	Copying	○	×	×	×	→	×	☆	×	☆	☆	*5	☆	*3	*5	*3		
	Sort *1	○	×	—	×	→	×	☆	×	☆	*4	☆	*4	*3	—	*3		
	Sort *2	○	—	×	—	→	×	☆	×	☆	*5	☆	*5	—	*5	—		
	Stapling *1	○	×	—	×	→	×	☆	×	☆	*4	☆	*4	*3	—	*3		
Facsimile	Transmission Operation/ Manual Reception Operation	○	→	→	→	×	×	☆	×	☆	☆	☆	☆	☆	☆	☆		
	Transmission	Scanning an original for memory transmission	×	×	×	×	×	×	☆	×	☆	☆	☆	☆	☆	☆	☆	
		Memory transmission	☆	☆	☆	☆	☆	☆	→	×	→	☆	☆	☆	☆	☆	☆	
		Immediate transmission	×	×	×	×	×	×	→	×	→	☆	☆	☆	☆	☆	☆	
	Reception	Memory Reception☆	☆	☆	☆	☆	☆	☆	→	×	→	☆	☆	☆	☆	☆	☆	
Printing Received Data		*5	×	*5	×	☆	☆	☆	×	☆	→	☆	*5	*3	*5	*3		
Printer	Data Reception	☆	☆	☆	☆	☆	☆	☆	☆	☆	→	→	→	→	→	→		
	Print	Printing	*5	×	*5	×	☆	☆	☆	☆	☆	*5	☆	→	*3	→	*3	
		Sort	*1	×	×	—	×	☆	☆	☆	☆	☆	→	☆	→	*3	—	*3
			*2	*5	—	*5	—	☆	☆	☆	☆	☆	*5	☆	→	—	→	—
Stapling *1	×	×	—	×	☆	☆	☆	☆	☆	→	☆	→	*3	—	*3			

☆...means that these functions can be used together.

○...means that you can interrupt the current job with Function keys or the **[Interrupt]** key to proceed to a subsequent job.

→...means that another job will automatically start after the current job is finished.

×...means that you must manually start another job after the current job is finished (i.e. these functions cannot be used together).

*1 When the optional 20-bin sorter stapler or 10-bin sorter stapler is installed.

*2 When the optional 3-bin sorter is installed.

*3 When papers is left in the optional sorter stapler, remove it or the subsequent operation cannot output papers.

*4 Copies are output if you press the **[Clear Modes]** key. However, the subsequent operation will start automatically after a System Reset occurs.

*5 Both operations are performed concurrently and output is interleaved.



INDEX

-
- 1 Sided → 2 Sided, 63
 - 2 Sided → 1 Sided, 72
 - 2 Sided → 2 Sided, 66

A

- Access to Machine, 190
- Adding Areas, 141
- Adding Staples, 164
- Adjusting Colors Based on the Selected Color, 111
- Adjusting Copy Image Density, 26
- Area Editing, 131
- Area Shapes, 122, 136
- Auto color select mode, 28
- Auto image density, 26
- Auto Off Mode, 49
- Auto paper select, 36
- Auto Reduce/Enlarge, 48
- Auto Start, 51

B

- Book → 1 Sided, 70
- Book → 2 Sided, 67

C

- Change Modes, 140
- Changing Basic Settings for the Entire Image, 138
- Changing Paper Size, 169
- Clearing Misfeeds, 161
- Checking and Changing Areas, 140
- Check Modes, 53
- Changing The Toner Cartridge, 156
- Color Adjustment, 106
- Color Background, 86
- Color Balance, 103
- Color Balance Adjustment, 103
- Color Balance Program, 104
- Color Conversion, 83
- Color Creation, 83
- Color Erase, 85
- Color Sample Chart, 10
- Combination Chart, 97
- Combination Chart for Area Editing, 146
- Combine, 73

- Combine 2 Originals, 73
- Combine 4 Originals, 75
- Combined auto and manual image density, 27
- Copying from the Bypass Tray, 37
- Counter, 54
- Cover Sheet, 79

D

- Delete Area, 132
- Designate Area Display, 120
- Designate Area Tools, 121
- Designating Areas, 119
- Directional Magnification (%), 59
- Directional Size Magnification (mm), 60
- Do's and Don'ts, 187
- Duplex—Making 2 Sided Copies, 63

E

- Energy Saver Mode, 49
- Erasing a Group, 143
- Erasing an Area, 142
- Exiting Area Editing, 145

F

- Finishing, 90
- Frame/Line, 125, 134
- Front and Back Cover, 80
- Front Cover, 79
- Full color copy mode, 28

H

- How to Edit Areas, 118

I

- Image Adjustment, 108
- Image Creation, 88
- Interrupt copying, 50

L

- Loading Paper, 154

M

- Machine Environment, 188
- Maintaining Your Machine, 191

Manual image density, 27
Manual paper select, 36
Margin Adjustment, 77
Mirror, 88
Mixing Colors Manually with the
Number Keys, 113
Multi → 2 Sided, 68

N

Notes for Designating Areas, 128

O

Operation Panel, 7
Options, 6
Originals, 14

P

Paper Storage, 195
Photo mode, 34
Positive/Negative, 89
Power Connection, 189
Preset R/E, 54
Program, 51
Program User Color, 111

R

Removing Jammed Staples, 166

S

Safety Information, ii
Sampling the User Color (Option), 115
Save Area, 133
Selecting a Color Mode, 28
Selecting Modes for Designated Areas, 130
Selecting Modes for Outside Designated
Areas, 135
Selecting the Copy Paper Size, 36
Selecting the Original Image Type, 33
Series Copies, 70
Setting a Stack of Originals in the
Document Feeder, 17
Setting Custom Sized Originals, 22
Setting one Original at a Time in the
Document Feeder, 19
Setting Originals of Different Sizes in the
Document Feeder, 21
Setting Originals on the Exposure Glass, 16
Shift, 76
Shifting the Image, 76

Soft/Sharp, Contrast, Background
Density, and Pastel, 109
Sort, 90
Special original mode, 35
Specification, 197
Stack, 92
Staple, 93
Starting the Machine, 12

T

Text mode, 34
Toner Storage, 195
Twin color mode, 31

U

U.C.R. Adjustment, A.C.S. Sensitivity and
Auto Text/Photo Sensitivity, 110
User Tools, 173

W

What is Area Editing?, 117
Where to Put Your Machine, 188

Z

Zoom, 57

Free Manuals Download Website

<http://myh66.com>

<http://usermanuals.us>

<http://www.somanuals.com>

<http://www.4manuals.cc>

<http://www.manual-lib.com>

<http://www.404manual.com>

<http://www.luxmanual.com>

<http://aubethermostatmanual.com>

Golf course search by state

<http://golfingnear.com>

Email search by domain

<http://emailbydomain.com>

Auto manuals search

<http://auto.somanuals.com>

TV manuals search

<http://tv.somanuals.com>