

---

DSm651 / DSm660 / DSm675  
*LDI51 / LDI60 / LDI75*  
**Aficio™ 2051 / 2060 / 2075**

**Operating Instructions**  
**General Settings Guide**

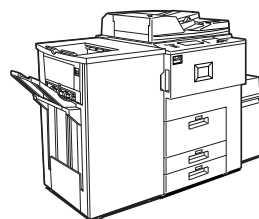

- 
- 1** Getting Started
  - 2** Combined Function Operations
  - 3** Document Server
  - 4** User Tools (System Settings)
  - 5** Troubleshooting
  - 6** Remarks
  - 7** Entering Text
  - 8** Specifications

Read this manual carefully before you use this product and keep it handy for future reference. For safe and correct use, please be sure to read the Safety Information in this manual before using the machine.

## Introduction

This manual describes detailed instructions on the operation and notes about the use of this machine. To get maximum versatility from this machine, all operators are requested to read this manual carefully and follow the instructions. Please keep this manual in a handy place near the machine.



### Notes:

Some illustrations in this manual might be slightly different from the machine.

Certain options might not be available in some countries. For details, please contact your local dealer.



### Operator Safety:

This machine is considered a class 1 laser device, safe for office/EDP use. The machine contains four AlGaInp laser diodes, 10-milliwatt, 770-810 nanometer wavelength for each emitter. Direct (or indirect reflected ) eye contact with the laser beam might cause serious eye damage. Safety precautions and interlock mechanisms have been designed to prevent any possible laser beam exposure to the operator.

### Laser Safety:

The optical housing unit can only be repaired in a factory or at a location with the requisite equipment. The laser subsystem is replaceable in the field by a qualified customer engineer. The laser chassis is not repairable in the field. Customer engineers are therefore directed to return all chassis and laser subsystems to the factory or service depot when replacement of the optical subsystem is required.

### Caution:

Use of controls or adjustments or performance of procedures other than those specified in this manual might result in hazardous radiation exposure.

### Notes:

The model names of the machines do not appear in the following pages. Check the type of your machine before reading this manual. (For details, see P.15 "*Machine Types*".)

- Type 1: DSm651/LD151/Aficio 2051
- Type 2: DSm660/LD160/Aficio 2060
- Type 3: DSm675/LD175/Aficio 2075

Certain types might not be available in some countries. For details, please contact your local dealer.

Two kinds of size notation are employed in this manual. With this machine refer to the metric version.

For good copy quality, the supplier recommends that you use genuine toner from the supplier.

The supplier shall not be responsible for any damage or expense that might result from the use of parts other than genuine parts from the supplier with your office products.

### Power Source

220V, 50/60Hz, 10A or more

Please be sure to connect the power cord to a power source as above. For details about power source, see P.128 "*Power Connection*".

# Manuals for This Machine

The following manuals describe the operational procedures of this machine. For particular functions, see the relevant parts of the manual.

## **Note**

- Manuals provided are specific to machine type.
- Adobe Acrobat Reader is necessary to view the manuals as a PDF file.
- Two CD-ROMs are provided:
  - CD-ROM 1 “Operating Instructions for Printer/Scanner”
  - CD-ROM 2 “Scanner Driver & Document Management Utilities”

## ❖ **General Settings Guide (this manual)**

Provides an overview of the machine and describes System Settings (such as Tray Paper Settings), Document Server functions, and troubleshooting.

## ❖ **Security Reference**

This manual is for administrators of this machine. It describes security functions that the administrators can use to protect data from being tampered, or prevent the machine from unauthorized use.

Also refer to this manual for the procedures for registering administrators, as well as setting user and administrator authentication.

## ❖ **Network Guide (PDF file - CD-ROM1)**

Provides information about configuring and operating the printer in a network environment or using software.

This manual covers all models, and therefore contains functions and settings that may not be available for your model. Images, illustrations, functions, and supported operating systems may differ from those of your model.

## ❖ **Copy Reference**

Describes operations, functions, and troubleshooting for the machine's copier function.

## ❖ **Printer Reference**

Describes operations, functions, system settings and troubleshooting for the machine's printer function.

## ❖ **Scanner Reference (PDF file - CD-ROM1)**

Describes operations, functions, and troubleshooting for the machine's scanner function.

## ❖ Manuals for DeskTopBinder Lite

DeskTopBinder Lite is a utility included on the CD-ROM labeled “Scanner Driver & Document Management Utilities”.

- DeskTopBinder Lite Setup Guide (PDF file - CD-ROM2)  
Describes installation of, and the operating environment for DeskTopBinder Lite in detail. This guide can be displayed from the **[Setup]** display when DeskTopBinder Lite is installed.
- DeskTopBinder Introduction Guide (PDF file - CD-ROM2)  
Describes operations of DeskTopBinder Lite and provides an overview of its functions. This guide is added to the **[Start]** menu when DeskTopBinder Lite is installed.
- Auto Document Link Guide (PDF file - CD-ROM2)  
Describes operations and functions of Auto Document Link installed with DeskTopBinder Lite. This guide is added to the **[Start]** menu when DeskTopBinder Lite is installed.

# What You Can Do with This Machine

The following introduces the functions of this machine, and the relevant manuals containing detailed information about them.

Products marked with \* are optional. For details about optional products, see p.141 "Options", or contact your local dealer.

---

## Copier, Printer, and Scanner Functions

---

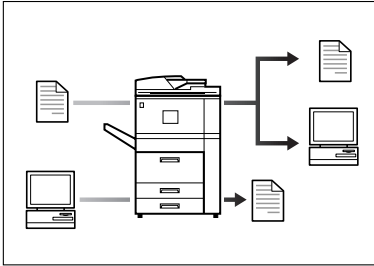

This machine provides copier, printer\* and scanner\* functions.

- You can make copies of originals. With a finisher\*, you can sort and staple copies. See *Copy Reference*.
- You can print documents created using applications. See *Printer Reference*.
- You can scan originals and send the scan file to a computer. See *Scanner Reference*.

---

## Utilizing Stored Documents

---

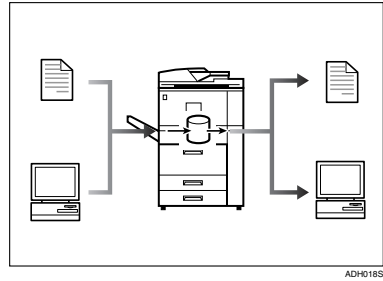

- You can store files of originals scanned by this machine, or files sent from other computers, onto the hard disk of the machine. You can print the stored print documents, as well as change print settings, and print multiple documents (Document Server). See p.36 "Using the Document Server".
- With DeskTopBinder Professional\*/Lite, you can search, check, print, and delete stored documents using your computer. You can also retrieve stored documents scanned in scanner mode. With File Format Converter\*, you can even download documents stored in copy and printer functions to your computer. See *Network Guide*.

---

## Connecting Two Machines for Copying

---

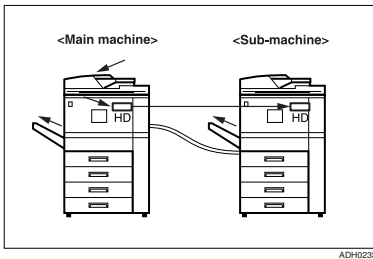

You can connect two machines together. When you set up a copy job on one machine (the main machine), data is transferred to the other (the sub-machine) so that copies can be made on both machines simultaneously (Connect Copy).

- You can complete large volume copy runs in shorter time. See *Copy Reference*.
- Even if one machine runs out of paper, or stops because of a paper jam, the other machine can still continue to finish the job. See *Copy Reference*.

---

## Using the Scanner in a Network Environment

---

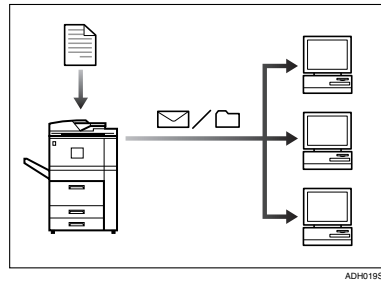

- You can send scanned documents to other network computers using e-mail (Sending stored scan file by e-mail). See *Scanner Reference*.
- With the ScanRouter delivery software, you can store scanned documents in specified destinations on network computers (File storage). See *Scanner Reference*.
- You can send scanned documents to other network folders (Scan to Folder). See *Scanner Reference*.

---

## Administrating the Machine/ Protecting Documents (Security Functions)

---

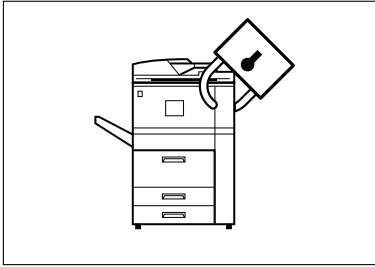

- You can protect documents from unauthorized access and stop them from being copied without permission. See *Security Reference*.
- You can control the use of the machine, as well as prevent machine settings from being changed without authorization. See *Security Reference*.
- By setting passwords, you can prevent unauthorized access via the network. See *Security Reference*.
- You can erase the data on the hard disk to prevent the information from leaking out. See the manual for the DataOverWriteSecurity unit\*.

---

## Monitoring the Machine Via Computer

---

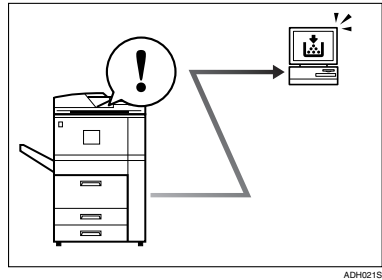

You can monitor machine status and change settings using a computer.

- Using SmartDeviceMonitor for Admin, SmartDeviceMonitor for Client, or a Web browser, you can use a computer to view the machine's status, such as checking on paper quantities or misfeeds. See *Network Guide*.
- You can use a Web browser to make network settings. See *Network Guide*.
- You can also use a Web browser to register and manage items such as user codes, e-mail addresses, and folders in the Address Book. See the Web browser's Help.

# TABLE OF CONTENTS

<b>Manuals for This Machine</b> .....	<b>i</b>
<b>What You Can Do with This Machine</b> .....	<b>iii</b>
Copier, Printer, and Scanner Functions .....	iii
Utilizing Stored Documents .....	iii
Connecting Two Machines for Copying .....	iv
Using the Scanner in a Network Environment .....	iv
Administrating the Machine/ Protecting Documents (Security Functions) .....	v
Monitoring the Machine Via Computer .....	v
<b>Copyrights and Trademarks</b> .....	<b>1</b>
Trademarks .....	1
Information about Installed Software .....	2
<b>How to Read This Manual</b> .....	<b>7</b>
<b>Safety Information</b> .....	<b>8</b>
Safety During Operation .....	8
<b>Positions of Labels and Hallmarks for ⚠WARNING and ⚠CAUTION</b> .....	<b>11</b>
<b>ENERGY STAR Program</b> .....	<b>13</b>
<b>Machine Types</b> .....	<b>15</b>

## 1. Getting Started

---

<b>Guide To Components</b> .....	<b>17</b>
External Options .....	19
Internal Options .....	20
<b>Control Panel</b> .....	<b>21</b>
Display Panel .....	22
When the Authentication Screen is displayed .....	23
<b>Turning On the Power</b> .....	<b>25</b>
Turning On the Main Power .....	25
Turning On the Power .....	25
Turning Off the Power .....	26
Turning Off the Main Power .....	26
Saving Energy .....	26

## 2. Combined Function Operations

---

<b>Changing Modes</b> .....	<b>29</b>
Job List .....	30
<b>Multi-Access</b> .....	<b>32</b>



### 3. Document Server

<b>Relationship between Document Server and Other Functions .....</b>	<b>35</b>
Document Server Display .....	35
<b>Using the Document Server .....</b>	<b>36</b>
Storing Data .....	36
Changing a Stored Document's File Name, User Name, or Password.....	39
Selecting a Document.....	39
Searching for Stored Documents .....	40
Printing Stored Documents .....	41
Deleting Stored Documents .....	43
Viewing Stored Documents Using a Web Browser .....	44
Downloading Stored Documents.....	44
<b>Settings for the Document Server.....</b>	<b>46</b>







### 4. User Tools (System Settings)

<b>User Tools Menu (System Settings).....</b>	<b>47</b>
<b>Accessing User Tools (System Settings) .....</b>	<b>50</b>
Changing Default Settings .....	50
Exiting from User Tools.....	50
<b>Settings You Can Change with User Tools .....</b>	<b>51</b>
General Features .....	51
Tray Paper Settings .....	55
Timer Settings.....	58
Administrator Tools .....	60
<b>Address Book.....</b>	<b>66</b>
<b>Registering Names .....</b>	<b>69</b>
Registering a Name .....	69
Changing a Registered Name.....	70
Deleting a Registered Name .....	70
<b>Authentication Information .....</b>	<b>71</b>
Registering a New User Code.....	71
Changing a User Code.....	72
Deleting a User Code .....	72
Displaying the Counter for Each User Code .....	73
Printing the Counter for Each User Code.....	73
Clearing the Number of Prints.....	74
<b>E-mail Destination.....</b>	<b>75</b>
Registering an E-mail Destination.....	75
Changing a Registered E-mail Destination .....	76
Deleting a Registered E-mail Destination .....	77
<b>Registering Folders .....</b>	<b>78</b>
Using SMB to Connect.....	78
Using FTP to Connect.....	81
<b>Registering Names to a Group .....</b>	<b>85</b>
Registering a New Group.....	85
Registering Names to a Group.....	86
Removing a Name from a Group .....	86
Displaying Names Registered in Groups .....	87
Changing a Group Name .....	87
Deleting a Group .....	87
Adding a Group to Another Group .....	88

<b>Registering a Protection Code .....</b>	<b>89</b>
Registering a Protection Code for a Name in the Address Book .....	89
Registering a Protection Code for a Group .....	90
<b>Registering LDAP Authentication .....</b>	<b>91</b>
Registering LDAP Authentication .....	91
Changing LDAP Authentication .....	91

## 5. Troubleshooting

---

<b>If Your Machine Does Not Operate as You Want .....</b>	<b>93</b>
General .....	93
Document Server .....	95
<b> Loading Paper .....</b>	<b>96</b>
Loading Paper in Tray 1 (Tandem Tray) .....	96
Loading Paper in Tray 2 and 3 .....	97
Loading Paper in the Large Capacity Tray (LCT) .....	97
Loading Paper in the Interposer .....	98
<b>Suspend Copy when using Finisher 3000B (100-Sheet Staples) .....</b>	<b>99</b>
<b> Adding Toner .....</b>	<b>100</b>
<b>Replacing Toner .....</b>	<b>102</b>
<b> Clearing Misfeeds .....</b>	<b>103</b>
<b>Changing the Paper Size .....</b>	<b>113</b>
Changing the Paper Size in Tray 2 or 3 .....	113
<b> Adding Staples .....</b>	<b>115</b>
Finisher 3000M (50-Sheet Staples), Booklet Finisher .....	115
Booklet Finisher (Saddle Stitch) .....	116
Finisher 3000B (100-Sheet Staples) .....	117
<b> Removing Jammed Staples .....</b>	<b>118</b>
Finisher 3000M (50-Sheet Staples), Booklet Finisher .....	118
Booklet Finisher (Saddle Stitch) .....	119
Finisher 3000B (100-Sheet Staples) .....	120
<b> Removing Punch Waste .....</b>	<b>121</b>
Finisher 3000M (50-Sheet Staples), Booklet Finisher .....	121
Finisher 3000B (100-Sheet Staples) .....	122

## 6. Remarks

---

<b>Dos And Don'ts .....</b>	<b>125</b>
<b>Toner .....</b>	<b>126</b>
Handling Toner .....	126
Toner Storage .....	126
Used Toner .....	126
<b>Where to Put Your Machine .....</b>	<b>127</b>
Machine Environment .....	127
Moving .....	127
Power Connection .....	128
Access to the Machine .....	128
<b>Maintaining Your Machine .....</b>	<b>129</b>
Cleaning the Exposure Glass .....	129
Cleaning the Auto Document Feeder .....	129

<b>Other Functions .....</b>	<b>130</b>
Inquiry .....	130
Changing the Display Language .....	130
<b>Counter .....</b>	<b>131</b>
Displaying the Total Counter .....	131

## **7. Entering Text**

<b>Entering Text .....</b>	<b>133</b>
Available Characters .....	133
Keys .....	133
Entering Text .....	134

## **8. Specifications**

<b>Main Unit.....</b>	<b>135</b>
Document Server .....	139
Auto Document Feeder .....	140
<b>Options .....</b>	<b>141</b>
Mailbox .....	141
Booklet Finisher .....	141
Finisher 3000M (50-Sheet Staples) .....	145
Finisher 3000B (100-Sheet Staples) .....	146
Punch Unit (Booklet Finisher, Finisher 3000M).....	148
Punch Unit (Finisher 3000B) .....	148
Z-folding Unit.....	149
Copy Tray.....	150
Large Capacity Tray (LCT) .....	150
Interposer .....	150
<b>Others .....</b>	<b>152</b>
<b>Copy Paper .....</b>	<b>153</b>
Recommended Paper Sizes and Types.....	153
Non-recommended Paper.....	155
Paper Storage .....	156
<b>INDEX.....</b>	<b>157</b>



# Copyrights and Trademarks

---

## Trademarks

---

Microsoft®, Windows® and Windows NT® are registered trademarks of Microsoft Corporation in the United States and/or other countries.

Acrobat® is a registered trademark of Adobe Systems Incorporated.

Bluetooth™ is a trademark of the Bluetooth SIG, Inc. (Special Interest Group) and is used by RICOH Company Limited under license.

Copyright ©2001 Bluetooth SIG, Inc.

The Bluetooth Trademarks are owned by Bluetooth SIG, Inc. USA

Other product names used herein are for identification purposes only and might be trademarks of their respective companies. We disclaim any and all rights to those marks.

The proper names of the Windows operating systems are as follows:

- The product name of Windows® 95 is Microsoft® Windows® 95
- The product name of Windows® 98 is Microsoft® Windows® 98
- The product name of Windows® Me is Microsoft® Windows® Millennium Edition (Windows Me)
- The product names of Windows® 2000 are as follows:  
Microsoft® Windows® 2000 Advanced Server  
Microsoft® Windows® 2000 Server  
Microsoft® Windows® 2000 Professional
- The product names of Windows® XP are as follows:  
Microsoft® Windows® XP Professional  
Microsoft® Windows® XP Home Edition
- The product names of Windows Server™ 2003 are as follows:  
Microsoft® Windows Server™ 2003 Standard Edition  
Microsoft® Windows Server™ 2003 Enterprise Edition  
Microsoft® Windows Server™ 2003 Web Edition
- The product names of Windows® NT are as follows:  
Microsoft® Windows NT® Server 4.0  
Microsoft® Windows NT® Workstation 4.0

---

## Information about Installed Software

---

---

### expat

---

- The software including controller, etc. (hereinafter "software") installed on this product uses the expat Version 1.95.2 (hereinafter "expat") under the conditions mentioned below.
- The product manufacturer provides warranty and support to the software of the product including the expat, and the product manufacturer makes the initial developer and copyright holder of the expat, free from these obligations.
- Information relating to the expat is available at:  
<http://expat.sourceforge.net/>

Copyright © 1998, 1999, 2000 Thai Open Source Software Centre, Ltd. and Clark Cooper.

Permission is hereby granted, free of charge, to any person obtaining a copy of this software and associated documentation files (the "Software"), to deal in the Software without restriction, including without limitation the rights to use, copy, modify, merge, publish, distribute, sublicense, and/or sell copies of the Software, and to permit persons to whom the Software is furnished to do so, subject to the following conditions:

The above copyright notice and this permission notice shall be included in all copies or substantial portions of the Software.

THE SOFTWARE IS PROVIDED "AS IS", WITHOUT WARRANTY OF ANY KIND, EXPRESS OR IMPLIED, INCLUDING BUT NOT LIMITED TO THE WARRANTIES OF MERCHANTABILITY, FITNESS FOR A PARTICULAR PURPOSE AND NONINFRINGEMENT. IN NO EVENT SHALL THE AUTHORS OR COPYRIGHT HOLDERS BE LIABLE FOR ANY CLAIM, DAMAGES OR OTHER LIABILITY, WHETHER IN AN ACTION OF CONTRACT, TORT OR OTHERWISE, ARISING FROM, OUT OF OR IN CONNECTION WITH THE SOFTWARE OR THE USE OR OTHER DEALINGS IN THE SOFTWARE.

---

### NetBSD

---

#### 1. Copyright Notice of NetBSD

For all users to use this product:

This product contains NetBSD operating system:

For the most part, the software constituting the NetBSD operating system is not in the public domain; its authors retain their copyright.

The following text shows the copyright notice used for many of the NetBSD source code. For exact copyright notice applicable for each of the files/binaries, the source code tree must be consulted.

A full source code can be found at <http://www.netbsd.org/>.

Copyright © 1999, 2000 The NetBSD Foundation, Inc.

All rights reserved.

Redistribution and use in source and binary forms, with or without modification, are permitted provided that the following conditions are met:

- ① Redistributions of source code must retain the above copyright notice, this list of conditions and the following disclaimer.
- ② Redistributions in binary form must reproduce the above copyright notice, this list of conditions and the following disclaimer in the documentation and/or other materials provided with the distribution.
- ③ All advertising materials mentioning features or use of this software must display the following acknowledgment:  
This product includes software developed by The NetBSD Foundation, Inc. and its contributors.
- ④ Neither the name of The NetBSD Foundation nor the names of its contributors may be used to endorse or promote products derived from this software without specific prior written permission.

THIS SOFTWARE IS PROVIDED BY THE NETBSD FOUNDATION, INC. AND CONTRIBUTORS "AS IS" AND ANY EXPRESS OR IMPLIED WARRANTIES, INCLUDING, BUT NOT LIMITED TO, THE IMPLIED WARRANTIES OF MERCHANTABILITY AND FITNESS FOR A PARTICULAR PURPOSE ARE DISCLAIMED. IN NO EVENT SHALL THE FOUNDATION OR CONTRIBUTORS BE LIABLE FOR ANY DIRECT, INDIRECT, INCIDENTAL, SPECIAL, EXEMPLARY, OR CONSEQUENTIAL DAMAGES (INCLUDING, BUT NOT LIMITED TO, PROCUREMENT OF SUBSTITUTE GOODS OR SERVICES; LOSS OF USE, DATA, OR PROFITS; OR BUSINESS INTERRUPTION) HOWEVER CAUSED AND ON ANY THEORY OF LIABILITY, WHETHER IN CONTRACT, STRICT LIABILITY, OR TORT (INCLUDING NEGLIGENCE OR OTHERWISE) ARISING IN ANY WAY OUT OF THE USE OF THIS SOFTWARE, EVEN IF ADVISED OF THE POSSIBILITY OF SUCH DAMAGE.

## 2. Authors Name List

All product names mentioned herein are trademarks of their respective owners. The following notices are required to satisfy the license terms of the software that we have mentioned in this document:

- This product includes software developed by the University of California, Berkeley and its contributors.
- This product includes software developed by Jonathan R. Stone for the NetBSD Project.
- This product includes software developed by the NetBSD Foundation, Inc. and its contributors.
- This product includes software developed by Manuel Bouyer.
- This product includes software developed by Charles Hannum.
- This product includes software developed by Charles M. Hannum.
- This product includes software developed by Christopher G. Demetriou.
- This product includes software developed by Tools GmbH.
- This product includes software developed by Terrence R. Lambert.
- This product includes software developed by Adam Glass and Charles Hannum.
- This product includes software developed by Theo de Raadt.

- This product includes software developed by Jonathan Stone and Jason R. Thorpe for the NetBSD Project.
- This product includes software developed by the University of California, Lawrence Berkeley Laboratory and its contributors.
- This product includes software developed by Christos Zoulas.
- This product includes software developed by Christopher G. Demetriou for the NetBSD Project.
- This product includes software developed by Paul Kranenburg.
- This product includes software developed by Adam Glass.
- This product includes software developed by Jonathan Stone.
- This product includes software developed by Jonathan Stone for the NetBSD Project.
- This product includes software developed by Winning Strategies, Inc.
- This product includes software developed by Frank van der Linden for the NetBSD Project.
- This product includes software developed for the NetBSD Project by Frank van der Linden
- This product includes software developed for the NetBSD Project by Jason R. Thorpe.
- The software was developed by the University of California, Berkeley.
- This product includes software developed by Chris Provenzano, the University of California, Berkeley, and contributors.

---

## **Sablotron**

---

Sablotron (Version 0.82) Copyright © 2000 Ginger Alliance Ltd. All Rights Reserved

a) The application software installed on this product includes the Sablotron software Version 0.82 (hereinafter, "Sablotron 0.82"), with modifications made by the product manufacturer. The original code of the Sablotron 0.82 is provided by Ginger Alliance Ltd., the initial developer, and the modified code of the Sablotron 0.82 has been derived from such original code provided by Ginger Alliance Ltd.

b) The product manufacturer provides warranty and support to the application software of this product including the Sablotron 0.82 as modified, and the product manufacturer makes Ginger Alliance Ltd., the initial developer of the Sablotron 0.82, free from these obligations.

c) The Sablotron 0.82 and the modifications thereof are made available under the terms of Mozilla Public License Version 1.1 (hereinafter, "MPL 1.1"), and the application software of this product constitutes the "Larger Work" as defined in MPL 1.1. The application software of this product except for the Sablotron 0.82 as modified is licensed by the product manufacturer under separate agreement(s).

d) The source code of the modified code of the Sablotron 0.82 is available at: <http://support-download.com/services/device/sablot/notice082.html>



e) The source code of the Sablotron software is available at: <http://www.ginger-all.com>

f) MPL 1.1 is available at: <http://www.mozilla.org/MPL/MPL-1.1.html>

---

## SASL

---

CMU libsasl

Tim Martin

Rob Earhart

Rob Siemborski

Copyright © 2001 Carnegie Mellon University. All rights reserved.

Redistribution and use in source and binary forms, with or without modification, are permitted provided that the following conditions are met:

- ① Redistributions of source code must retain the above copyright notice, this list of conditions and the following disclaimer.
- ② Redistributions in binary form must reproduce the above copyright notice, this list of conditions and the following disclaimer in the documentation and/or other materials provided with the distribution.
- ③ The name "Carnegie Mellon University" must not be used to endorse or promote products derived from this software without prior written permission. For permission or any other legal details, please contact:

Office of Technology Transfer  
Carnegie Mellon University  
5000 Forbes Avenue  
Pittsburgh, PA 15213-3890  
(412) 268-4387, fax: (412) 268-7395  
[tech-transfer@andrew.cmu.edu](mailto:tech-transfer@andrew.cmu.edu)

- ④ Redistributions of any form whatsoever must retain the following acknowledgment:

"This product includes software developed by Computing Services at Carnegie Mellon University (<http://www.cmu.edu/computing/>)."

CARNEGIE MELLON UNIVERSITY DISCLAIMS ALL WARRANTIES WITH REGARD TO THIS SOFTWARE, INCLUDING ALL IMPLIED WARRANTIES OF MERCHANTABILITY AND FITNESS, IN NO EVENT SHALL CARNEGIE MELLON UNIVERSITY BE LIABLE FOR ANY SPECIAL, INDIRECT OR CONSEQUENTIAL DAMAGES OR ANY DAMAGES WHATSOEVER RESULTING FROM LOSS OF USE, DATA OR PROFITS, WHETHER IN AN ACTION OF CONTRACT, NEGLIGENCE OR OTHER TORTIOUS ACTION, ARISING OUT OF OR IN CONNECTION WITH THE USE OR PERFORMANCE OF THIS SOFTWARE.

---

## MD4

---

Copyright © 1990-2, RSA Data Security, Inc. All rights reserved.

License to copy and use this software is granted provided that it is identified as the "RSA Data Security, Inc. MD4 Message-Digest Algorithm" in all material mentioning or referencing this software or this function.

License is also granted to make and use derivative works provided that such works are identified as "derived from the RSA Data Security, Inc. MD4 Message-Digest Algorithm" in all material mentioning or referencing the derived work.

RSA Data Security, Inc. makes no representations concerning either the merchantability of this software or the suitability of this software for any particular purpose. It is provided "as is" without express or implied warranty of any kind.

These notices must be retained in any copies of any part of this documentation and/or software.

---

## MD5

---

Copyright © 1991-2, RSA Data Security, Inc. Created 1991. All rights reserved.

License to copy and use this software is granted provided that it is identified as the "RSA Data Security, Inc. MD5 Message-Digest Algorithm" in all material mentioning or referencing this software or this function.

License is also granted to make and use derivative works provided that such works are identified as "derived from the RSA Data Security, Inc. MD5 Message-Digest Algorithm" in all material mentioning or referencing the derived work.

RSA Data Security, Inc. makes no representations concerning either the merchantability of this software or the suitability of this software for any particular purpose. It is provided "as is" without express or implied warranty of any kind.

These notices must be retained in any copies of any part of this documentation and/or software.

# How to Read This Manual

---

## Symbols

---

This manual uses the following symbols:

### **WARNING:**

This symbol indicates a potentially hazardous situation that might result in death or serious injury if you misuse the machine by not following the instructions under this symbol. Be sure to read the instructions, all of which are included in the Safety Information section in the *General Settings Guide*.

### **CAUTION:**

This symbol indicates a potentially hazardous situation that might result in minor or moderate injury or property damage not involving bodily injury, if you misuse the machine by not following these instructions under this symbol. Be sure to read the instructions, all of which are included in the Safety Information section in the *General Settings Guide*.

\* WARNINGS and CAUTIONS are notes for your safety.

### **Important**

If these instructions are not followed, paper might be misfed, originals damaged, or data lost. Be sure to read these instructions.

### **Preparation**

This symbol indicates the prior knowledge or preparation required before operation.

### **Note**

This symbol indicates precautions for operation, or actions to be taken following user error.

### **Limitation**

This symbol indicates numerical limits, functions that cannot be used together, or conditions under which a particular function cannot be used.

### **Reference**

This symbol indicates where further relevant information can be found.

[   ]

Keys that appear on the machine's display panel.

[   ]

Keys built into the machine's control panel.

# Safety Information

When using this machine, the following safety precautions should always be followed.

---

## Safety During Operation

---

In this manual, the following important symbols are used:

**⚠ WARNING:**  
*Indicates a potentially hazardous situation which, if instructions are not followed, could result in death or serious injury.*

**⚠ CAUTION:**  
*Indicates a potentially hazardous situation which, if instructions are not followed, may result in minor or moderate injury or damage to property.*

---

### **⚠ WARNING:**

---

- **Connect the power cord directly into a wall outlet and never use an extension cord.**
- **Disconnect the power plug (by pulling the plug, not the cable) if the power cable or plug becomes frayed or otherwise damaged.**
- **To avoid hazardous electric shock or laser radiation exposure, do not remove any covers or screws other than those specified in this manual.**
- **Turn off the power and disconnect the power plug (by pulling the plug, not the cable) if any of the following occurs:**
  - **You spill something into the machine.**
  - **You suspect that your machine needs service or repair.**
  - **The external housing of your machine has been damaged.**
- **Do not incinerate spilled toner or used toner. Toner dust might ignite when exposed to an open flame.**
- **Disposal can take place at our authorized dealer.**
- **Dispose of the used toner bottle in accordance with the local regulations.**
- **Keep the machine away from flammable liquids, gases, and aerosols. A fire or an electric shock might occur.**

---

**⚠ CAUTION:**

---

- *Protect the machine from dampness or wet weather, such as rain and snow.*
- *Keep the machine away from humidity and dust. Otherwise a fire or an electric shock might occur.*
- *Do not place the machine on an unstable or tilted surface. If it topples over, an injury might occur.*
- *If you use the machine in a confined space, make sure there is a continuous air turnover.*
- *Unplug the power cord from the wall outlet before you move the machine. While moving the machine, you should take care that the power cord will not be damaged under the machine.*
- *When you disconnect the power plug from the wall outlet, always pull the plug (not the cable).*
- *Do not allow paper clips, staples, or other small metallic objects to fall inside the machine.*
- *Keep toner (used or unused) and toner bottle out of the reach of children.*
- *If toner or used toner is inhaled, gargle with plenty of water and move into a fresh air environment. Consult a doctor if necessary.*
- *If toner or used toner gets into your eyes, flush immediately with large amounts of water. Consult a doctor if necessary.*
- *If toner or used toner is swallowed, dilute by drinking a large amount of water. Consult a doctor if necessary.*
- *Avoid getting toner on your clothes or skin when removing a paper jam or replacing toner. If your skin comes into contact with toner, wash the affected area thoroughly with soap and water.*
- *If toner gets on your clothing, wash with cold water. Hot water will set the toner into the fabric and may make removing the stain impossible.*
- *If your skin comes into contact with toner or used toner, wash the affected area thoroughly with soap and water.*
- *For environmental reasons, do not dispose of the machine or expended supply waste at household waste collection points. Disposal can take place at an authorized dealer.*
- *The inside of the machine could be very hot. Do not touch the parts with a label indicating "hot surface". Otherwise, an injury might occur.*
- *The fusing section of this machine might be very hot. Caution should be taken when removing misfed paper.*
- *The fusing unit becomes very hot. When installing a new fuser oil unit, turn off the machine and wait about an hour. After that, install the new fuser oil unit. Not waiting for the unit to cool could result in a burn.*
- *Keep the fuser oil unit away from flames. There is a risk of fire or burns.*
- *Keep the waste oil bottle away from flames. There is a risk of fire or burns.*

---

**⚠ CAUTION:**

---

- *Do not use aluminum foil, carbon paper, or similar conductive paper to avoid a fire or machine failure.*

# Positions of Labels and Hallmarks for ⚠WARNING and ⚠CAUTION

This machine has labels for ⚠WARNING and ⚠CAUTION at the positions shown below. For safety, please follow the instructions and handle the machine as indicated.

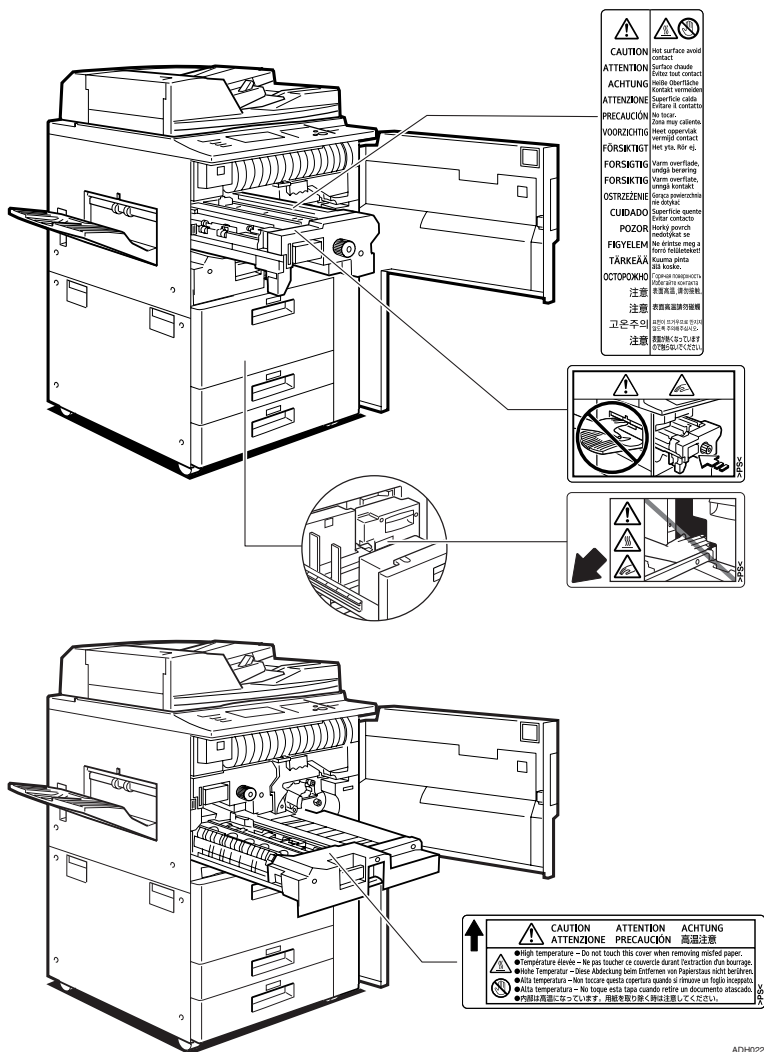

ADH022D

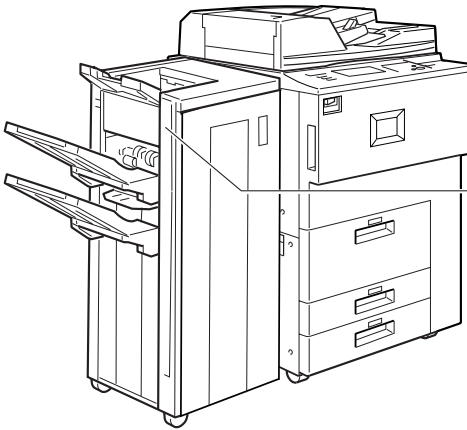
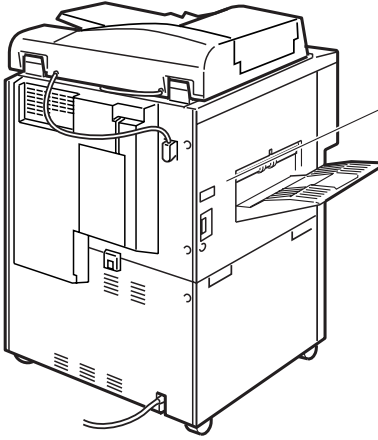

Do not touch the paper exit section of the finisher. It could cause injury.

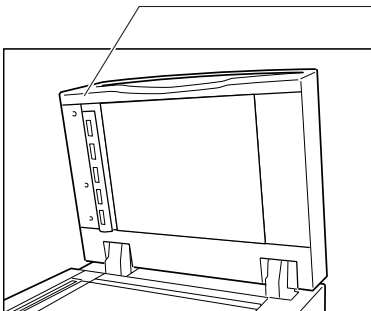

ZGVH462E

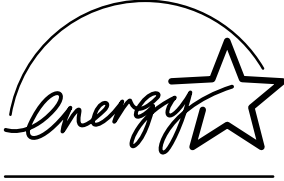

# ENERGY STAR Program

<p>ENERGY STAR®</p> 	<p>As an ENERGY STAR Partner, we have determined that this machine model meets the ENERGY STAR Guidelines for energy efficiency.</p>
-------------------------------------------------------------------------------------------------------	--------------------------------------------------------------------------------------------------------------------------------------

The ENERGY STAR Guidelines intend to establish an international energy-saving system for developing and introducing energy-efficient office equipment to deal with environmental issues, such as global warming.

When a product meets the ENERGY STAR Guidelines for energy efficiency, the Partner shall place the ENERGY STAR logo onto the machine model.

This product was designed to reduce the environmental impact associated with office equipment by means of energy-saving features, such as Low-power mode.

## ❖ Low Power Mode

This product automatically lowers its power consumption 1 minute after the last copy or print job has finished. Printing is still possible in Low Power Mode, but if you wish to make copies first press the **[Energy Saver]** key.

### 🔍 Reference

For details about how to change the default interval, see p.58 “Energy Saver Timer”.

## ❖ Off Mode (Copier only)

To conserve energy, this product automatically turns off 1 minute after the last copying or printing job has been completed. Printing is still possible in Off Mode, but if you wish to make copies first press the operation switch.

### 🔍 Reference

For details about how to change the default interval, see p.58 “Auto Off Timer”.

## ❖ Sleep Mode (Printer, Scanner installed)

If the printer and scanner are installed, this product automatically lowers further its power consumption 1 minute after it has shifted to Low Power Mode. Printing is still possible in Sleep Mode, but if you wish to make copies first press the operation switch.

### 🔍 Reference

For details about how to change the default interval, see p.58 “Auto Off Timer”.

### ❖ Duplex Priority

The ENERGY STAR Program recommends the duplex function. By conserving paper resources this function reduces a burden to the environment. For applicable machines, duplex function (one-sided originals→two-sided copies) can be selected preferentially when the operation switch or the main power switch is turned on, the **[Energy Saver]** key is pressed, or the machine resets automatically.

### 🔍 Reference

To change the settings of the Duplex Priority mode, see “Duplex Mode Priority” in “General Features P.2/5”, *Copy Reference*.

---

## Specifications

---

		Copier only		
		Type 1	Type 2	Type 3
Low Power Mode <sup>*1</sup>	Power consumption	275W or less	275W or less	290W or less
	Default interval	60 seconds		
	Recovery Time	10 seconds or less		
Off Mode	Power consumption	9W or less	9W or less	9W or less
	Default interval	60 seconds		
	Recovery Time	30 seconds or less		
Sleep Mode	Power consumption	--		
	Default interval	--		
	Recovery Time	--		

\*1 When Auto Off Timer and Energy Saver Timer settings are at their defaults, the machine will shift to Off Mode instead.

Duplex Priority	1 Sided → 1 Sided
-----------------	-------------------

### ❖ Recycled Paper

In accordance with the ENERGY STAR Program, we recommend use of recycled paper which is environmentally friendly. Please contact your sales representative for recommended paper.

# Machine Types

This machine comes in three models which vary in copy speed. To ascertain which model you have, see the inside front cover.

	Type 1	Type 2	Type 3
Copy speed	51 copies/minute (A4 $\square$ , 8 <sup>1</sup> / <sub>2</sub> " $\times$ 11" $\square$ )	60 copies/minute (A4 $\square$ , 8 <sup>1</sup> / <sub>2</sub> " $\times$ 11" $\square$ )	75 copies/minute (A4 $\square$ , 8 <sup>1</sup> / <sub>2</sub> " $\times$ 11" $\square$ )



# 1. Getting Started

## Guide To Components

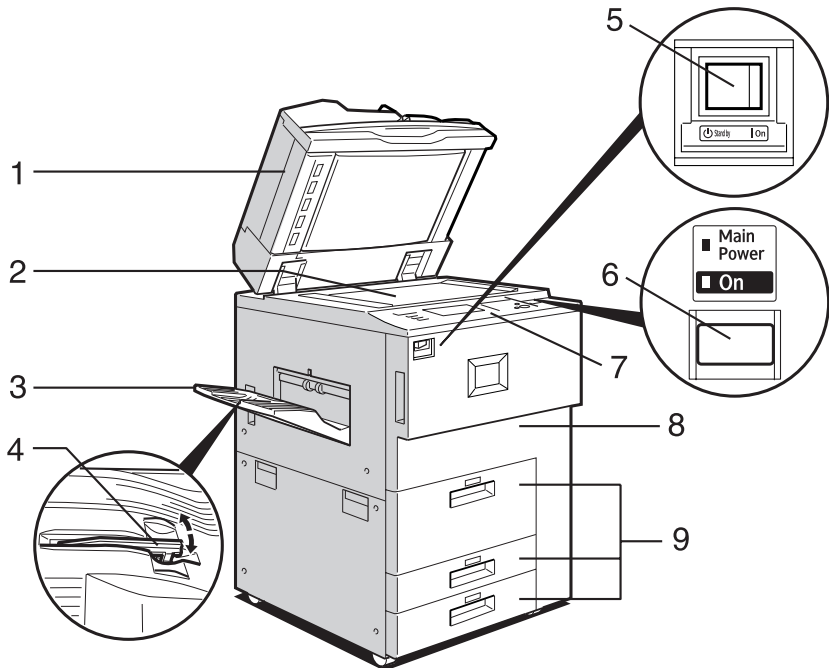

### 1. Auto document feeder (ADF)

Load a stack of originals here. They will be fed automatically one by one.

The front and back side of 2-sided originals are scanned simultaneously.

### 2. Exposure glass

Place originals face down here.

### 3. Copy tray (optional)

Copied or printed paper is delivered here.

### 4. Copy tray guide

When copying onto OHP transparencies and translucent paper, raise the guide to prevent copies from curling when delivered.

### 5. Main power switch

If the machine does not operate after turning on the operation switch, check if the main power switch is turned on.

### 6. Operation switch

Press this switch to turn the power on (the **On** indicator lights up). To turn the power off, press this switch again (the **On** indicator goes off).

ZGVH310N

## 7. Control panel

See p.21 "Control Panel".

## 8. Front cover

Open to access the inside of the machine.

## 9. Paper tray (tray 1-3)

Load paper here.

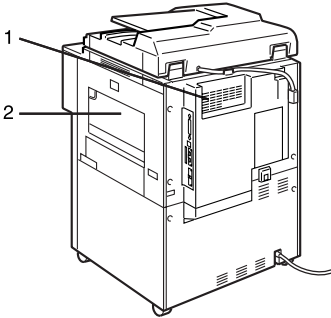

ADH0025

## 1. Ventilation holes

Prevent overheating. Do not obstruct the ventilation holes by placing an object near it or leaning things against it. If the machine overheats, a fault might occur.

## 2. Bypass tray

Use to print on OHP transparencies, label paper (adhesive labels), translucent paper, postcards and custom size paper.

## External Options

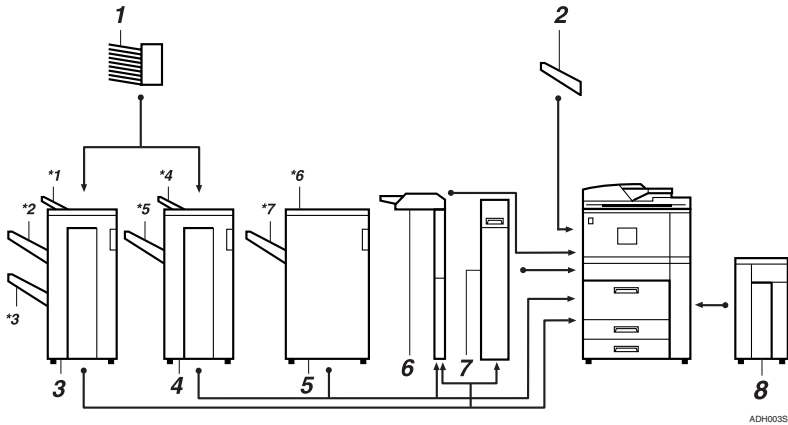

### 1. Mailbox

Sorts printed papers.

\*Mailbox trays 1-9

### 2. Copy tray

Copies are delivered here.

### 3. Booklet Finisher

Sorts, stacks, staples and punches copies. The saddle stitch function can staple the copies in the centre and fold them into booklets.

\*1: Finisher upper tray

\*2: Finisher shift tray 1

\*3: Finisher shift tray 2

### 4. Finisher 3000M(50-Sheet Staples)

Sorts, stacks, staples and punches copies.

\*4: Finisher upper tray

\*5: Finisher shift tray

### 5. Finisher 3000B(100-Sheet Staples)

Sorts, stacks, staples and punches copies.

\*6: Finisher upper tray

\*7: Finisher shift tray

### 6. Interposer

Inserts cover or slip sheets into the copies.

### 7. Z-folding unit

Makes two parallel folds on the copied paper, one of which faces in and the other facing out.

### 8. Large Capacity Tray (LCT)

Holds 4000 sheets of paper.

---

## Internal Options

---

1

- ① Printer/Scanner unit  
Allows you to use the printer and scanner functions.
- ② IEEE 1394 interface board \*<sup>1</sup>  
Connects to an IEEE 1394 cable.
- ③ Bluetooth \*<sup>1</sup>  
Allows you to expand the interface.
- ④ File Format Converter  
Allows you to download documents from the Document Server stored by copier and printer functions. See p.44 "Downloading Stored Documents".
- ⑤ IEEE 802.1b Wireless LAN Board \*<sup>1</sup>  
You can install a wireless LAN interface.
- ⑥ USB 2.0 Interface Board \*<sup>1</sup>  
Allows you to connect a variety of external devices.
- ⑦ DataOverwriteSecurity Unit  
Allows you to erase data on the hard disk.

\*<sup>1</sup> You cannot install two or more of the options below:  
IEEE 1394 interface board, IEEE 802.1b Wireless LAN Board, USB 2.0 Interface Board, Bluetooth



# Control Panel

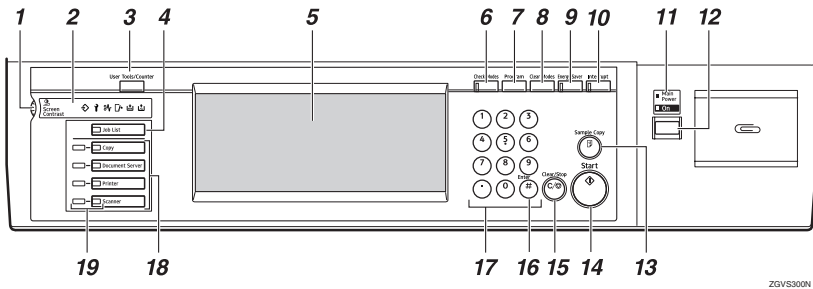

## 1. Screen contrast knob

Adjusts the brightness of the display panel.

## 2. Indicators

Display the status of the machine and indicate errors.

↔: Data In indicator. See p.32 “Multi-Access”.

🔔: Service Call indicator

⚠️: Misfeed indicator. See p.103 “⚠️ Clearing Misfeeds”.

🔧: Open Cover indicator

📎: Add Staple indicator. See p.115 “📎 Adding Staples”.

🖨️: Add Toner indicator. See p.100 “🖨️ Adding Toner”.

## 3. [User Tools/Counter] key

- User Tools  
Press to change the default settings and conditions to meet your requirements. See p.50 “Accessing User Tools (System Settings)”.
- Counter  
Press to check or print the total number of copies made. See p.131 “Counter”.
- Inquiry  
Press to check where to contact for machine repairs and ordering toner. See p.130 “Inquiry”.

## 4. [Job List] key

Shows the job list.

## 5. Display panel

Shows the operation status, error messages, and function menus.

## 6. [Check Modes] key

Press this key to check settings.

## 7. [Program] key (Copier mode)

Press to register frequently used settings, or to recall registered settings.

## 8. [Clear Modes] key

Press to clear previously entered copy job settings.

## 9. [Energy Saver] key

Press to shift to and from Low Power mode.

## 10. [Interrupt] key (Copy mode)

Press to make interrupt copies during a copy run.

## 11. Main power indicator and On indicator

The main power indicator lights up when the main power switch is turned on.

The **On** indicator lights up when the power is turned on.

## ⚠️ Important

- ❑ Do not turn off the power while the **On** indicator is blinking. Doing so may damage the hard disk.

ZGV5300N

### 12. Operation switch

Press this switch to turn the power on (the **On** indicator lights up). To turn the power off, press this switch again (the **On** indicator goes off).

### 13. [Sample Copy] key

Press to make a single set of copies or prints to check for print quality before making multiple sets.

### 14. [Start] key

Press to start copying, or to scan or print documents stored on the Document Server.

### 15. [Clear/Stop] key

- Clear  
Press to delete a number entered.
- Stop  
Press to stop a job in progress.

### 16. [#] key





Press to enter a numerical value.

### 17. Number keys

Use to enter the desired number of copies, or data for a selected function.

### 18. Function keys

Press to select the following functions:

- Copy: 
- Document Server: 
- Printer: 
- Scanner: 

### 19. Function Status indicator



These show the status of the above functions:

- Yellow: the function is selected.
- Green: the function is active.
- Red: the function has been interrupted.

## Display Panel

The display panel shows machine status, error messages and function menus.

The function items displayed serve as selector keys. You can select or specify an item by lightly pressing them.

When you select or specify an item on the display panel, it is highlighted like . Keys appearing as  cannot be used.

### Important

A force or impact of more than 30 N (about 3 kgf) will damage the display panel.

By default the copying screen is displayed when you turn the power on.

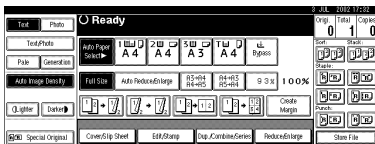

## Common Key Operations

The following keys are common to all screens.

### ◆ Key list

[OK]	Acknowledges a selected function or entered values, and then returns to the previous display
[Cancel]	Deletes a selected function or entered values, and then returns to the previous display
[▲Prev.], [▼Next]	Moves to the previous page or the next page when all functions cannot be displayed on one page.
[OK] [Yes]	Closes displayed messages.
[Clear]	Clears entered values and does not change the settings.
[Exit]	Returns to the previous display.

## When the Authentication Screen is displayed

When Basic Authentication, Windows Authentication, or LDAP Authentication is set, the authentication screen is displayed. Unless a valid user name and password are entered, operations are not possible with the machine.

### ✎ Note

- Consult the User Administrator about your login user name and login password. For details of the various types of user authentication, consult the respective administrators.
- When User Code Authentication is set, the screen for entering a user code is displayed instead.

### 1 Press [Enter] for Login User Name.

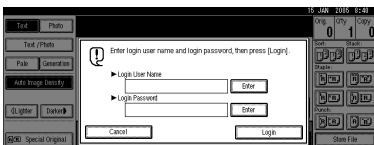

### 2 Enter a login user name, and then press [OK].

### 3 Press [Enter] for Login Password.

### 4 Enter a login password, and then press [OK].

### 5 Press [Login].

When the user is authenticated, the screen for the function you are using appears.

---

## Log Off

---

### Important

- To prevent unauthorized users from using the machine, always log off when you have finished using the machine.

**1** Press **[User Tools /Counter]**.

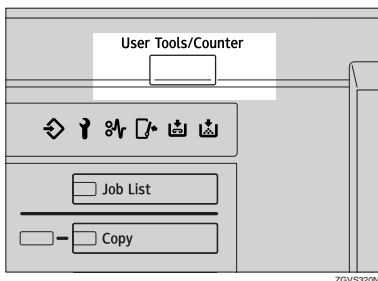

**2** Press **[Logout]**.



**3** Press **[Yes]**.

**4** Press **[User Tools /Counter]**.

# Turning On the Power

This machine has two power switches.

## ❖ Operation switch (right side of the control panel)

Press to activate the machine. When the machine has finished warming up, you can make copies.

## ❖ Main power switch (left side of the machine)

Turning off this switch will completely turn off power to the machine.

### Note

- This machine automatically enters Energy Saver mode or turns itself off if you do not use it for a certain period. See p.58 "Auto Off Timer", p.58 "Energy Saver Timer".

## Turning On the Main Power

**1** Make sure that the power cord is firmly plugged into the wall outlet.

**2** Open the switch cover and turn on the main power switch.

The main power indicator turns on.

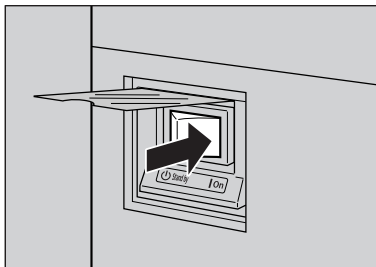

ZGVH391N

### Important

- Do not turn off the main power immediately after it has been turned on. Otherwise it may result in damage to the hard disk or memory, leading to the malfunctioning of the machine.

## Turning On the Power

**1** Press the operation switch.

The **On** indicator lights up

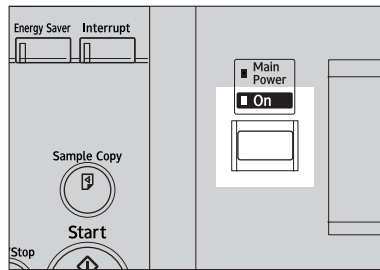

ZGV5310N

### Note

- If the power is not turned on when the operation switch is pressed, check if the main power switch is on. If not, turn it on.

## Turning Off the Power

- 1** Press the operation switch.  
The **On** indicator goes off.

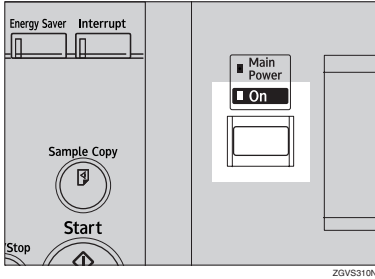

**Note**

- In the following cases, the indicator will not go off but will instead blink when you press the operation switch:
  - During communication with external equipment.
  - When the hard disk is active.

## Turning Off the Main Power

**Important**

- Do not turn off the main power switch when the **On** indicator is on or blinking. Failure to observe this may result in damage to the hard disk or memory, leading to malfunction.
- Be sure to pull out the power cord only after you have turned off the main power switch. Not doing this may result in damage to the hard disk or memory.

- 1** Make sure the **On** indicator is off.

- 2** Open the switch cover, and turn off the main power switch.

The main power indicator goes off.

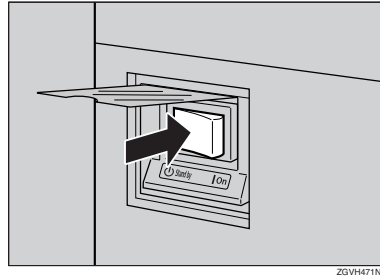

## Saving Energy

**Energy Saver Mode**

If you do not operate the machine for a certain period of time, or when you press the **[Energy Saver]** key, the display disappears and the machine goes into Energy Saver mode. When you press the **[Energy Saver]** key again, the machine returns to the ready condition. The machine uses less electricity in Energy Saver mode.

**Note**

- You can change the amount of time the machine waits before switching to Energy Saver mode after copying has finished or the last operation is performed. See p.58 "Energy Saver Timer".

  
 **Auto Off**

The machine automatically turns itself off when the job is finished, after a certain period of time has elapsed. This function is called "Auto Off".

 **Note**

- You can change the Auto Off time. See p.58 "Auto Off Timer".
  - The Auto Off Timer function will not operate in the following cases:
    - When a warning message appears
    - When the service call message appears
    - When paper is jammed
    - When the cover is open
    - When the "Add Toner" message appears
    - When toner is being replenished
    - When the User Tools/Counter screen is displayed
    - When fixed warm-up is in progress
    - When the printer or other functions are active
    - When operation was suspended during printing
    - When the **Data In** indicator is on or blinking
    - When the sample print or locked print screen is displayed
- 





# 2. Combined Function Operations

## Changing Modes

### Note

- ❑ You cannot switch modes in any of the following situations:
  - When accessing User Tools
  - During interrupt copying
- ❑ The default setting is to display the screen for copying when you turn the power on. You can change the setting. For details about settings, see p.51 "Function Priority".

The diagram illustrates the process of switching between different modes on a multifunction copier. On the left, the 'User Tools/Counter' screen is shown with a 'Screen Contrast' slider and a menu containing 'Job List', 'Copy', 'Document Server', 'Printer', and 'Scanner'. Four arrows point from this menu to the corresponding mode screens on the right:

- Copier:** Shows a 'Ready' screen with various paper size options (A4, A3, A4, A4) and a '100%' magnification setting.
- Document Server:** Shows a 'File List' screen with a table of files to print.
- Printer:** Shows a 'Ready' screen with paper tray status indicators and a 'Sample Print/Locked Print' option.
- Scanner:** Shows a 'Ready' screen with a 'Scanned File List' and various scan settings.

User Name	File Name	Size	Page
DOP1008	Sakly	21	1/2
DOP1015	Sakly	51	1/2
DOP1014	Sakly	61	1/2
DOP1003	Sakly	11	1/2
DOP1002	Sakly	11	1/2

From	To	CC	Bcc	Registration No.	Manual Input	Memory
000002	000002					0
159	159					

## System Reset

The machine returns automatically to its initial condition when a certain period of time has elapsed after the job is finished . This function is called "System Reset". See p.51 "Function Priority".

### Note

- ❑ You can change the System Reset time. See p.59 "System Auto Reset Timer".

## Job List

You can check the contents of jobs in printing as well as those waiting in order , and also delete them.

### Note

- ❑ In the Job List, jobs reserved using Copy mode and Document Server mode are displayed. When **[Print Priority]** in the System Settings is set to **[Job Order]**, jobs reserved using Copy mode, Printer mode, Document Server mode or Netfile mode are displayed.
- ❑ For details on printing in the Netfile mode, see the manuals for DeskTopBinder Professional/Lite.

### Checking the Job List

**1** Press the **[Job List]** key.

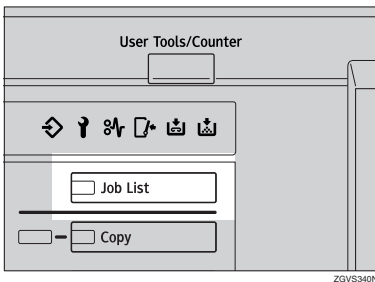



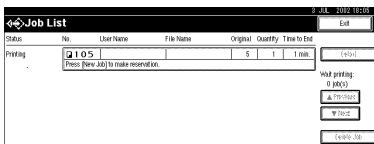

**2** Select the job number of the list you want to check.



The job list is displayed.

The icons below show the operation mode of stored documents.

			
Job printed using Copier mode.	Job printed using Printer mode.	Job printed using Document Server mode.	Job printed using Netfile mode.

 **Note**

- If more than six jobs are registered, press the [**▲Prev.**] or [**▼Next**] to scroll down the screen.

**3** Press [**Detail**].

**4** Check the contents of the list.

**5** Press [**OK**].

The display returns to the job list menu.

---

## Deleting Jobs

---

 **Note**

- If you are unable to delete the job, contact the administrator.

**1** Press the [**Job List**] key.

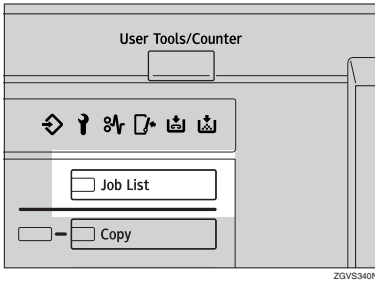

**2** Select the job number to be deleted.

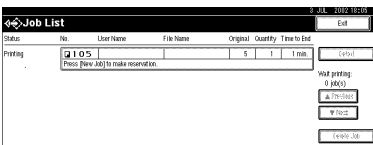

**3** Press [**Delete Job**].

**4** Press [**Yes**].

The display returns to the job list menu.

# Multi-Access

You can carry out another job using a different function while the current job is being performed. Performing multiple functions simultaneously in this manner is called "Multi-Access".

This allows you to handle your jobs efficiently, regardless of how the machine is being used. For example:

- While making copies, you can scan documents to store in the Document Server.
- While printing documents stored in the Document Server, the machine can receive print data.
- While executing print jobs, you can make operations for copying.

 **Note**

- See p.52 "Print Priority" to set function priority. By default, the **[Display Mode]** is set to first priority.
- When the optional Booklet Finisher, or Finisher 3000B(100-Sheet Staples) is installed on the machine, you can specify the output tray to which documents are to be delivered. For more information about how to specify the output tray for each function, see the following descriptions:
  - p.53 "Output: Copier"
  - p.53 "Output: Document Server"
  - p.54 "Output: Printer"

 **Function Compatibility**

The chart below shows sample operations when "Print Priority" is set to "Interleave". See p.52 "Print Priority".

△: Simultaneous operations are possible.

●: Operation is enabled when the relevant function key is pressed and remote switching (of the scanner) is done.

○: Operation is enabled when the **[Interrupt]** key is pressed to interrupt the preceding operation.

→: Operation is performed automatically once the preceding operation ends.

×: The operation must be started once the preceding operation ends. (Simultaneous operations are not available.)

		Mode after you select			Mode before you select			Printer						
		Copy			Interrupt Copying			Print						
		Operations for Copying			Operations for Copying			Data Reception						
		Stapling			Copying			Printing						
		Sort			Data Reception			Stapling						
		Operations for Copying			Operations for Copying			Operations for Scanning						
		Copying			Scanning			Operations for Document Server						
		Data Reception			Scanning a Document to Store in Document Server			Printing from Document Server						
		Printing			Printing from Document Server			Printing from Document Server						
		Stapling			Printing from Document Server			Printing from Document Server						
		Operations for Scanning			Printing from Document Server			Printing from Document Server						
		Scanning			Printing from Document Server			Printing from Document Server						
		Operations for Document Server			Printing from Document Server			Printing from Document Server						
		Scanning a Document to Store in Document Server			Printing from Document Server			Printing from Document Server						
		Printing from Document Server			Printing from Document Server			Printing from Document Server						
		Printing from Document Server			Printing from Document Server			Printing from Document Server						
Copy	Operations for Copying	×	×	×	○	○	△	△	△	●	●	●	△	△
	Stapling	△	→	→	○	○	△	△	△	→	●	●	●	△
	Sort	△	→	→	○	○	△	△	△	●	●	●	△	△
Interrupt Copying	Operations for Copying	○	○	○	×	×	△	△	△	×	×	×	×	△
	Copying	○	○	○	×	×	△	→	→	×	×	×	×	→
Printer Print	Data Reception	△	△	△	△	△	→	→	→	△	△	△	△	△
	Sort Print	△	△	△	○	○	△	→	→	△	△	△	△	△
	Stapling	△	→	△	○	○	△	→	→	△	△	△	△	△
Scanner	Operations for Scanning	●	●	●	○	○	△	△	△	×	×	●	●	△
	Scanning	×	×	×	×	×	△	△	△	×	×	×	×	△
Document Server	Operations for Document Server	●	●	●	○	○	△	△	△	●	●	×	×	△
	Scanning a Document to Store in Document Server	●	×	×	○	○	△	△	△	●	×	×	×	△
	Printing from Document Server	●	△	△	○	○	△	△	△	△	△	△	△	△
DesktopBinder Professional/Lite	Printing from Document Server	△	△	△	△	△	△	△	△	△	△	△	△	×

- \*1 Simultaneous operations are only available after the preceding job documents are all scanned and **[New Job]** appears.
- \*2 You can scan a document after the preceding job documents are all scanned.
- \*3 When stapling, printing automatically starts after the current job.
- \*4 Stapling is not available.
- \*5 Simultaneous operations are possible once you press **[New Job]**.

 **Limitation**

- Stapling cannot be used at the same time for multiple functions.

 **Note**

- While printing is in progress, scanning a document using another function may take more time.



# 3. Document Server

## Relationship between Document Server and Other Functions

The following table describes the relationship between the Document Server and other machine functions.

Function name	Where to store documents	Displaying a list	Printing documents
Copy	Copy/Document Server	Available	Enabled
Printer	Personal computer	Available	Enabled
Scanner	Scanner	Not available	Disabled

## Document Server Display

### ◆ Document Server Main Display

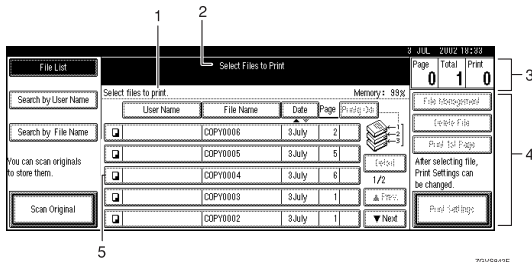

1. Operating status and messages are displayed.

2. The title of the currently selected screen is displayed.

3. The numbers of originals, copies, and printed pages are displayed.

4. The operation keys are displayed.

5. The stored operation mode is displayed.

The icons below show the operation mode when documents have been stored in the Document Server.

Function	Copier	Printer	Scanner
Icon			--

### Note

- Depending on the settings of security functions, not all the stored documents may be displayed.

# Using the Document Server

## Storing Data

### ❖ File Name

Stored documents will automatically be named as "COPY0001", "COPY0002". You can change assigned file names.

### ❖ User Name

You can register a user name to distinguish the user or user group that stored the documents. To register, you can either enter a name or use the one assigned to the user code.

#### 🔍 Reference

For more information about the user name, see p.69 "Registering Names".

### ❖ Password

You can set a password for stored documents, and use it to prevent others printing them. When a password is set for the documents,  mark appears next to the documents.

#### 🔍 Reference

To store documents in a mode other than Document Server, see the manuals for the respective modes.

### ⚠ Important

- ❑ Data stored in the machine might be lost if some kind of failure occurs. The supplier shall not be responsible for any damage that might result from the loss of data.
- ❑ Be careful not to let anyone know your password, especially when entering a password or recording it. Keep any record of your password in a secure place.

- ❑ Avoid using a single number or consecutive numbers for a password such as "0000" or "1234", since the numbers like this are easy to guess, so using them will not provide a worthwhile level of security.
- ❑ A document accessed with a correct password remains selected even after operations are complete, and it can be accessed by other users. To stop this, be sure to press the **[Clear Modes]** key to cancel the document selection.
- ❑ The user name used when adding a document to the Document Server is to identify the document creator and type. It is not to protect confidential documents from others.

#### 📝 Note

- ❑ By default, data stored in the Document Server is deleted after three days (72 hours). You can specify the time taken for the stored data to be deleted automatically. See p.64 "Auto Delete File".
- ❑ Before scanning documents using the scanner function, make sure all other operations have finished.

**1** Press the **[Document Server]** key.

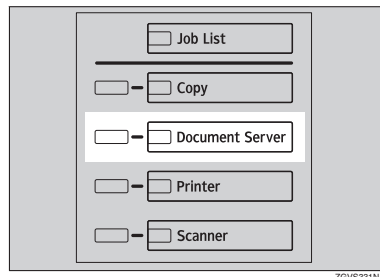

ZGV3331N



## 2 Press [Scan Original].

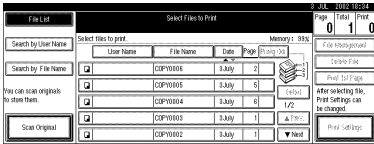

## 3 Enter a file name, user name, or password if necessary.

### Note

- If you do not enter a file name, one will be automatically assigned.

### Reference

See p.37 "To register or change a user name".

See p.38 "To change a file name".

See p.38 "To set or change a password".

## 4 Place your originals.

### Reference

For information on the types of originals and how to place them, see "Placing Originals", *Copy Reference*.

## 5 Make settings as desired.

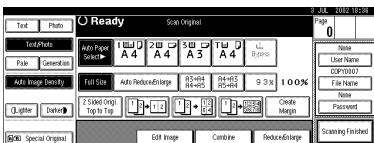

### Reference

For details, see *Copy Reference*.

## 6 Press the [Start] key.

The document is stored in the Document Server.

### Note

- To stop scanning, press the **[Clear/Stop]** key. To resume a paused scanning job, press **[Continue]** in the confirmation dialog box. To delete stored images and cancel the job, press **[Stop]**.
- When a password has been set, **!** mark appears on the left side of the file name.
- The Select Files to Print display appears when all the originals have been scanned. If it is not displayed, press **[Scanning Finished]**.

## To register or change a user name

### 1 Press [Scan Original].

The Scan Original display appears.

### 2 Press [User Name].

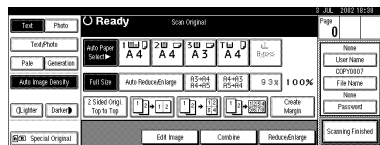

If user names have already been registered, the Change User Name display appears. To use an unregistered user name, press **[Non-programmed Name]**.

If no names are registered in the Address Book, the User Name entry display appears.

### Reference

See p.69 "Registering Names".

3

When using a name registered in the Address Book

- 1 Select a name from the list, and then press [OK].

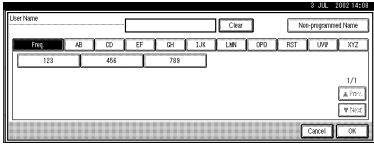

To change to an unregistered user name, proceed to the next step.

**Reference**

See p.71 "Registering a New User Code".

When using an unregistered user name

- 1 Press [Non-programmed Name].
- 2 Enter a new user name, and then press [OK].

**Reference**

See p.133 "Entering Text".

When no names are registered in the Address Book

- 1 Enter a new user name, and then press [OK].

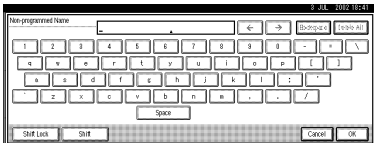

**Reference**

See p.133 "Entering Text".

To change a file name

- 1 Press [Scan Original].  
The Scan Original display appears.
- 2 Press [File Name].

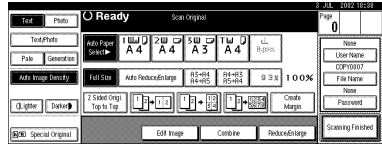

The Change File Name display appears.

- 3 Press [Delete All] to delete the old file name.

**Note**

- You can also use [Backspace] to delete unwanted characters.

- 4 Enter a new file name, and then press [OK].

**Note**

- Up to 20 characters can be entered as a file name, but only 16 characters of each file name will be displayed in the document list.

**Reference**

See p.133 "Entering Text".

To set or change a password

- 1 Press [Scan Original].  
The Scan Original display appears.
- 2 Press [Password].

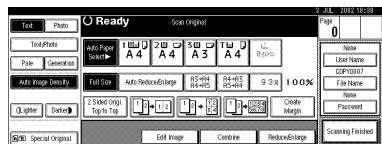

- 3** Enter a password using the number keys ( four digits), and then press [OK] or the [#] key.

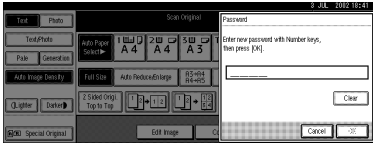

## Changing a Stored Document's File Name, User Name, or Password

- 1 Press the [Document Server] key.
- 2 Select the document with the user name, file name, or password you want to change.

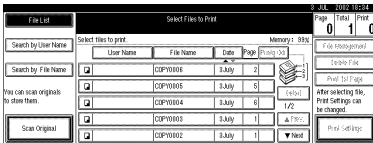

### Note

- If a password has been set for the document, enter the password and press [OK].

- 3 Press [File Management].
- 4 Press [Change File Name], [Change User Name], or [Change Password].

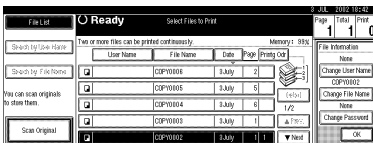

- 5 Enter the new file name, user name, or password, and then press [OK].

### Reference

See p.37 "To register or change a user name".

See p.38 "To change a file name".

See p.38 "To set or change a password".

- 6 Press [OK].

## Selecting a Document

- 1 Press the [Document Server] key.
- 2 Select the document to be printed.

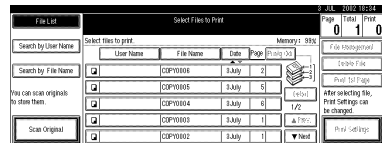

### Note

- If a password has been set for the document, enter the password and press [OK].
- You can search for a document using [Search by User Name] or [Search by File Name]. See p.40 "Searching for Stored Documents".
- You can sort document names in the list by user name, file name or date. To sort documents, press [User Name], [File Name] or [Date].
- If you cannot determine the contents of a document by its file name, you can print only the first page of the document for checking purposes. See p.43 "Printing the First Page".
- To cancel a selection, press the highlighted document again.

- 3 To print multiple documents, repeat step 2 in the order that you want to print.

3

**Note**

- You can select up to 30 documents.
- If sizes or resolutions of selected documents are not the same, the documents may not be printed.
- If you wish to change the order for printing, cancel the selection, and reselect in the desired order.
- If you press the **[Clear Modes]** key, selection of all documents will be canceled.
- If you press **[Printg Odr]**, the documents will be displayed in the order of printing.

- Press **[OK]**. The Select Files to Print display appears.

## Searching for Stored Documents

You can use either **[Search by File Name]** or **[Search by User Name]** to search for documents stored in the Document Server. You can also list stored documents in your order of preference.

**Note**

- If you install DeskTopBinder Professional or DeskTopBinder Lite on your computer, you can search and rearrange the documents from your computer.

**Reference**

For more details refer to the manuals for DeskTopBinder Professional/Lite.

## To Check Details of Stored Documents

**1** Select the document.

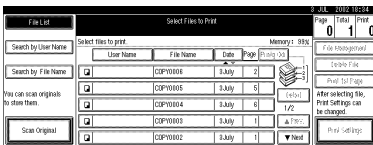

**Note**

- If a password has been set for the document, enter the password, and then press **[OK]**.

**2** Press **[Detail]**.



Detailed information about the document is displayed.

**Note**

- If you have selected several documents, use **[▲]** and **[▼]** to view the details of each.

## To Search by File Name

- 1** Press the **[Document Server]** key.
- 2** Press **[Search by File Name]**.

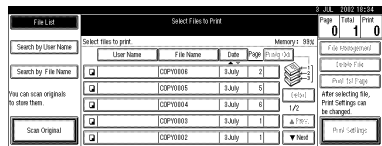

- 3** Enter the file name, and then press **[OK]**.

Files beginning with the name entered appear in the Select Files to Print display.

**Reference**

See p.133 "Entering Text".

**Note**

- To display all files stored in the Document Server, press **[File List]**.

**To Search by User Name**

- Press the **[Document Server]** key.
- Press **[Search by User Name]**.

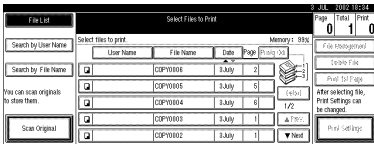

- To specify a registered user name, select the user name from the displayed list, and then press **[OK]**.

**Note**

- To specify an unregistered user name, go to the next step.

- To specify an unregistered user name, press **[Non-programmed Name]**. Enter the name, and then press **[OK]**.

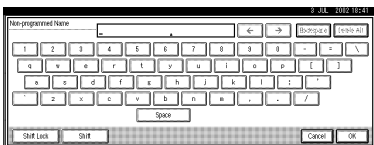
**Reference**

See p.133 "Entering Text".

- Press **[OK]**.

Files beginning with the name entered appear in the Select Files to Print display.

**Note**

- To display all files stored in the Document Server, press **[File List]**.

**Printing Stored Documents**

- Select the document to be printed.

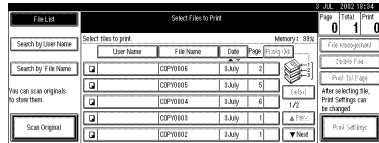
**Note**

- If a password has been set for the document, enter the password and then press **[OK]**.
- You can print multiple documents. See p.39 "Selecting a Document".

- If you need to change the print settings, press **[Print Settings]**.

The Print Settings display appears, and user names, file names and printing order of the documents are shown.

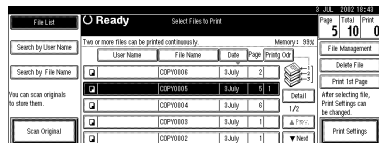
**Note**

- The print settings made for printing in copier or printer mode remain effective after printing and are applied to the next job.
- When multiple documents are selected, print settings made for the first document will be effective for only that document, and not the subsequent ones.
- Print setting items are listed below. For details about the print results, see *Copy Reference*.

3

◆ **Binding format**

- 2 Sided Copy Top to Top
- 2 Sided Copy Top to Bottom
- Booklet
- Magazine

◆ **Cover handling**

- Cover/Slip Sheet
- Edit/Stamp

◆ **Finish**

- Sort
- Stack
- Staple
- Punch

- If you print more than one set using the Sort function, you can check the print result by printing out only the first set. See p.42 “Sample Copy”.
- When multiple documents are printed at the same time, print settings made for the first document will apply to all the subsequent ones.
- If you select multiple files, you can confirm file names or print order you selected in step 1 by scrolling through the list with [▼] and [▲].
- Press [Select File] to return to the Select Files to Print display.

**3** Enter the required number of copies using the number keys.

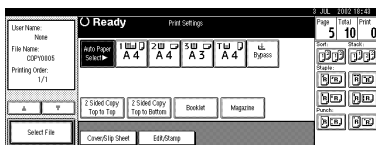

**Note**

- Up to 999 can be entered.

**4** Press the [Start] key.

The machine starts printing.

To stop printing

- 1 Press the [Clear/Stop] key.
- 2 Press [Stop].

To change the number of copies during printing

**Limitation**

- The number of copies can only be changed when the Sort function is selected in print settings.

- 1 Press the [Clear/Stop] key.
  - 2 Press [Change Quantity].
  - 3 Use the number keys to enter a new number of copies.
  - 4 Press the [#] key.
  - 5 Press [Continue].
- Printing restarts.

**Sample Copy**

If you are printing multiple sets, you can check if the print settings or sorting order is correct by first printing out a sample set.

**Limitation**

- This function can be used only when the Sort function is selected.

**1** Select the document to be printed.

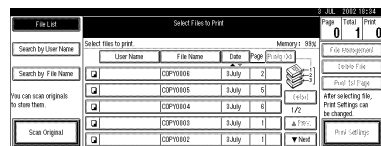

**Note**

- If a password has been set for the document, enter the password and then press [OK].

- You can search for a document using **[Search by User Name]** or **[Search by File Name]**. See p.40 “Searching for Stored Documents”.
- You can sort document names in the list by user name, file name, or date. To do so, press **[User Name]**, **[File Name]** or **[Date]**.
- To cancel a selection, press the highlighted document again.

## 2 Press the **[Sample Copy]** key.

The first set is printed.

## 3 To print the remaining sets, press **[Print]**.

### Note

- To change the settings, press **[Suspend]** to return to the Print Settings menu.

## Printing the First Page

You can print the first page of a document selected in the Select Files to Print display to check its contents.

If more than one document is selected, the first page of each is printed.

## 1 Select the document.

### Note

- If a password has been set for the document, enter the password and then press **[OK]**.

### Note

- You can search for a document using **[Search by User Name]** or **[Search by File Name]**. See p.40 “Searching for Stored Documents”.
- You can sort document names in the list by user name, file name, or date. To do so, press **[User Name]**, **[File Name]**, or **[Date]**.

- To cancel a selection, press the highlighted document again.

## 2 Press **[Print 1st Page]**.

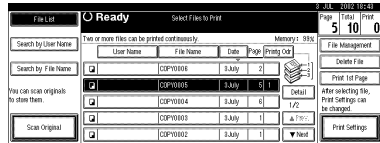

## 3 Press the **[Start]** key.

## Deleting Stored Documents

### Important

- You can store up to 3,000 documents in the Document Server. No more documents can be stored when the limit is reached, and you should delete unnecessary documents.

### Note

- You can delete all stored documents at once with the User Tools. See p.65 “Delete All Files”.
- You can also delete documents via a Web browser from a computer in the network. For details on how to start the Web browser, see *Network Guide*.

## 1 Press the **[Document Server]** key.

## 2 Select the document.

### Note

- If a password has been set for the document, enter the password and then press **[OK]**.

### Note

- You can delete multiple documents at once.
- You can search for a document using **[Search by User Name]** or **[Search by File Name]**. See p.40 “Searching for Stored Documents”.

- You can sort document names in the list by user name, file name, or date. To do so, press **[User Name]**, **[File Name]** or **[Date]**.
- If you cannot determine the document by its name, you can print the first page to check its contents. See p.43 “Printing the First Page”.
- To cancel a selection, press the highlighted document again.

**3** Press **[Delete File]**.

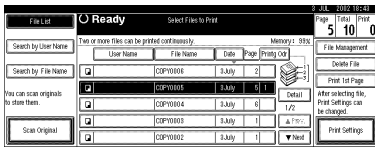

**4** Press **[Delete]** to delete the document.

## Viewing Stored Documents Using a Web Browser

**Reference**

The Web browser's Help

- 1** Start a Web browser.
- 2** Enter “http:// (IP address of this machine) /” in the **[Address]** box.  
The top page appears on the Web browser.
- 3** Click **[Document Server]**.

The **[Document Server File List]** appears.

**Note**

- To switch the display format, click **[Details]**, **[Thumbnails]** or **[Icons]** from the **[Display method]** list.

**4** Click the properties button of the document you want to check.

Information about that document appears.

**5** Check the contents of the document.

**Note**

- To enlarge the document preview, click **[Enlarge Image]**.

## Downloading Stored Documents

**Note**

- File Format Converter is required when downloading documents stored in copier or printer mode.

- 1** Start a Web browser.
- 2** Enter “http:// (IP address of this machine) /” in the **[Address]** box.  
The top page appears on the Web browser.
- 3** Click **[Document Server]**.  
The **[Document Server File List]** appears.
- Note**
  - To switch the display format, click **[Details]**, **[Thumbnails]** or **[Icons]** from the **[Display method]** list.
- 4** Click the properties button of the document you want to download.
- 5** Select **[PDF]**, **[JPEG]**, or **[Multi-page TIFF]** in the **[File format]** list.

**Note**

- [JPEG]** can only be selected for documents stored in scanner mode.



- [Multi-page TIFF]** is available when file format converter is installed.
- [Multi-page TIFF]** cannot be selected for documents stored in copier or printer mode.

**6** Click **[Download]**.

**7** Click **[OK]**.

# Settings for the Document Server

## ❖ Copier/Document Server Features (See “General Features P.<sup>4</sup> /<sub>5</sub>”, and “General Features P.<sup>5</sup> /<sub>5</sub>”, *Copy Reference*.)

	Items	Default settings
General Features P. <sup>4</sup> / <sub>5</sub>	Document Server Storage Key: F1	<i>2 Sided Original Top to top</i>
	Document Server Storage Key: F2	<i>1 Sided → 1 Sided Combine</i>
	Document Server Storage Key: F3	<i>1 Sided → 1 Sided Combine: 4 originals</i>
	Document Server Storage Key: F4	<i>1 Sided → 1 Sided Combine: 8 originals</i>
	Document Server Storage Key: F5	<i>Create Margin</i>
General Features P. <sup>5</sup> / <sub>5</sub>	Document Server Print Key:F1	<i>2 Sided Top to top</i>
	Document Server Print Key:F2	<i>2 Sided Top to bottom</i>
	Document Server Print Key:F3	<i>Booklet</i>
	Document Server Print Key:F4	<i>Magazine</i>
	Document Server Print Key:F5	<i>Off</i>

## ❖ System Settings (See p.51 “General Features”, p.55 “Tray Paper Settings”, p.58 “Timer Settings”, p.60 “Administrator Tools”.)

	Items	Default settings
General Features	Warm Up Notice	<i>On</i>
	Copy Count Display	<i>Up</i>
	Output: Document Server	<i>Copy Tray</i>
Tray Paper Settings	Paper Tray Priority: Document Server	<i>Tray 1</i>
	Cover Sheet Tray	<i>Off</i>
	Slip Sheet Tray	<i>Off</i>
Timer Settings	Copier / Document Server Auto Reset Timer	<i>60 seconds</i>
Administrator Tools	Auto Delete File	<i>After 3 day(s)</i>
	Delete All Files	<i>--</i>

# 4. User Tools (System Settings)

## User Tools Menu (System Settings)

### ◆ General Features (See p.51 “General Features”.)

	Default
Panel Tone	On
Warm Up Notice	On
Copy Count Display	Up
Function Priority	Copier
Print Priority	Display Mode
Function Reset Timer	3 seconds
Interleave Print	10 sheet(s)
Output Tray Setting	According to Function Setting
Output: Copier	Copy Tray <sup>*1</sup>
Output: Document Server	Copy Tray <sup>*1</sup>
Output: Printer	Copy Tray <sup>*1 *2</sup>
ADF Original Table Elevation	When Original is Set
Job List Display Time	15 seconds
Z-fold Position	Metric Version: <ul style="list-style-type: none"><li>• A3: 2mm</li><li>• B4 JIS (Japanese Industrial Standard): 2mm</li><li>• A4: 2mm</li><li>• 11"×17": 2mm</li><li>• 8<sup>1</sup>/<sub>2</sub>"×14": 2mm</li></ul> Inch Version: <ul style="list-style-type: none"><li>• A3: 0.1"</li><li>• B4 JIS: 0.1"</li><li>• A4: 0.1"</li><li>• 11"×17": 0.1"</li><li>• 8<sup>1</sup>/<sub>2</sub>"×14": 0.1"</li></ul>

<sup>\*1</sup> The default tray switches to *Finisher Upper Tray* when the optional finisher is installed.

<sup>\*2</sup> The default tray switches to *Mailbox Tray* when the optional mailbox is installed.

◆ **Tray Paper Settings (See p.55 “Tray Paper Settings”.)**

	<b>Default</b>
Paper Tray Priority: Copier	<i>Tray 1</i> *1
Paper Tray Priority: Printer	<i>Tray 1</i> *1
Tray Paper Size: Tray 2	A4 <input type="checkbox"/>
Tray Paper Size: Tray 3	A4 <input type="checkbox"/>
Paper Type: Bypass Tray	<i>No Display</i>
Paper Type: Tray 1	<i>No Display/2 Sided Copy/Auto Paper Select On</i>
Paper Type: Tray 2	<i>No Display/2 Sided Copy/Auto Paper Select On</i>
Paper Type: Tray 3	<i>No Display/2 Sided Copy/Auto Paper Select On</i>
Paper Type: LCT	<i>No Display/2 Sided Copy/Auto Paper Select On</i>
Cover Sheet Tray	<i>Off</i>
Slip Sheet Tray	<i>Off</i>
Designation Sheet 1 Tray	<i>Off</i>
Designation Sheet 2 Tray	<i>Off</i>
Printer Bypass Paper Size	A4 <input type="checkbox"/>

\*1 The default switches to *LCT* when the optional Large Capacity Tray (LCT) is installed.

◆ **Timer Settings (See p.58 “Timer Settings”.)**

	<b>Default</b>
Auto Off Timer	<i>1 minute(s)</i>
Energy Saver Timer	<i>1 minute(s)</i>
Panel Off Timer	<i>1 minute(s)</i>
System Auto Reset Timer	<i>60 seconds</i>
Copier/Document Server Auto Reset Timer	<i>60 seconds</i>
Printer Auto Reset Timer	<i>60 seconds</i>
Scanner Auto Reset Timer	<i>60 seconds</i>
Set Date	--
Set Time	--
Weekly Timer Code	<i>Off</i>
Auto Logout Timer	<i>60 seconds</i>
Weekly Timer: Monday – Sunday	--

◆ **Interface Settings**

- For details about network settings, see *Network Guide*.
- For details about parallel interface, see *Printer Reference*.

### ◆ File Transfer

- For details about network settings, see *Network Guide*.

### ◆ Administrator Tools(See p.60 “Administrator Tools”).

	Default
User Authentication Management	<i>Off</i>
Administrator Authentication Management	<i>Off</i>
Program/Change Administrator	--
Extended Security	--
External Charge Unit Management	--
Enhanced External Charge Unit Management	--
Display/Print Counter	--
Display/Clear/Print Counter per User	--
Address Book Management	--
Address Book: Program/Change/Delete Group	--
Address Book: Change Order	--
Print Address Book: Destination List	--
Address Book: Edit Title	--
Address Book: Select Title	<i>Title 1</i>
Auto Delete File	<i>After 3 day(s)</i>
Delete All Files	--
Program/ Change/ Delete LDAP Server	--
Use LDAP Server	<i>Off</i>
AOF (Always ON)	<i>On</i>
Firmware Version	--
Auto Erase Memory Setting	<i>Off</i>
Erase All Memory	--

# Accessing User Tools (System Settings)

User Tools allow you to change or set defaults.

**Note**

- ❑ Operations for system settings are different from normal operations. Always quit User Tools when you have finished. See p.50 “Exiting from User Tools”.
- ❑ Any changes you make with User Tools remain in effect even if the main power switch or operation switch is turned off, or the **[Energy Saver]** or **[Clear Modes]** key is pressed.

4

## Changing Default Settings

**1** Press the **[User Tools/Counter]** key.

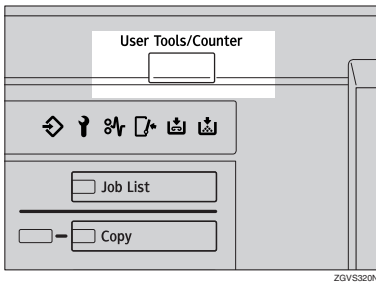

ZGV5320N

**2** Press **[System Settings]**.

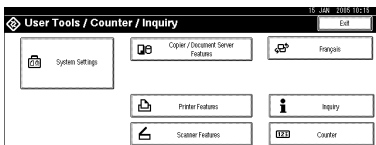

**3** Select the desired menu, and then press the desired key.

**Reference**

p.47 “User Tools Menu (System Settings)”

**4** Change settings by following instructions on the display panel, and then press **[OK]**.

**Note**

- ❑ To cancel changes made to settings and return to the normal function display, press the **[User Tools/Counter]** key.

## Exiting from User Tools

**1** Press the **[User Tools/Counter]** key.

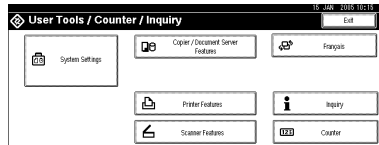

**Note**

- ❑ You can also exit from User Tools by pressing **[Exit]**.

# Settings You Can Change with User Tools

## Reference

To access User Tools, see p.50 “Changing Default Settings”.

---

## General Features

---

### ❖ Panel Tone

The beeper (key tone) sounds when a key is pressed.

#### Note

Default: *On*

### ❖ Warm Up Notice (Copier/Document Server)

You can set the beeper to sound when the machine becomes ready for copying after reviving from Energy Saver mode, or when the power is turned on.

#### Note

Default: *On*

If the Panel Tone setting is “Off”, the beeper will not sound, regardless of the Warm Up Notice setting.

### ❖ Copy Count Display (Copier/Document Server)

The copy counter can be set to show the number of copies made (count up) or the number of copies yet to be made (count down).

#### Note

Default: *Up (count up)*

### ❖ Function Priority

You can specify the mode to be displayed immediately after the operation switch or System Reset mode is turned on.

#### Note

Default: *Copier*

### ◆ Print Priority

Print priority is given to the mode selected.

#### Reference

See p.32 “Multi-Access”.

#### Note

- Default: *Display Mode*
- When the optional finisher is installed, you can specify an output tray to which documents are delivered.
  - p.53 “Output: Copier”
  - p.53 “Output: Document Server”
  - p.54 “Output: Printer”

### ◆ Function Reset Timer

When using the multi-access function (See p.32 “Multi-Access”), you can set the length of time the machine waits before changing modes. This is useful if when you are making many copies and need to change the settings for each copy. By setting a longer reset time, you can prevent being interrupted by other functions.

#### Note

- Default: *3 seconds*
- The Function Reset Timer setting will not be effective if Print Priority is given to Interleave Print. See p.52 “Print Priority”.

### ◆ Interleave Print

You can set the timing for changing modes when [**Print Priority**] has been set to [**Interleave**].

#### Note

- Default: *10 sheet(s)*
- Values set may change depending on the timing of printing.

### ◆ Output Tray Setting

You can set the way or timing for switching the output tray.

- Output Tray  
You can set the way in which the output tray is switched.

#### Note

- Default: *According to Function Setting*
- You can select Auto Change when Print Priority is set to Job Order. See p.52 “Print Priority”.
- Change Output Tray  
You can set the timing for switching the output tray.

#### Note

- Default: *When Tray is Full*



### ◆ Output: Copier

You can specify a tray to which copies are delivered.

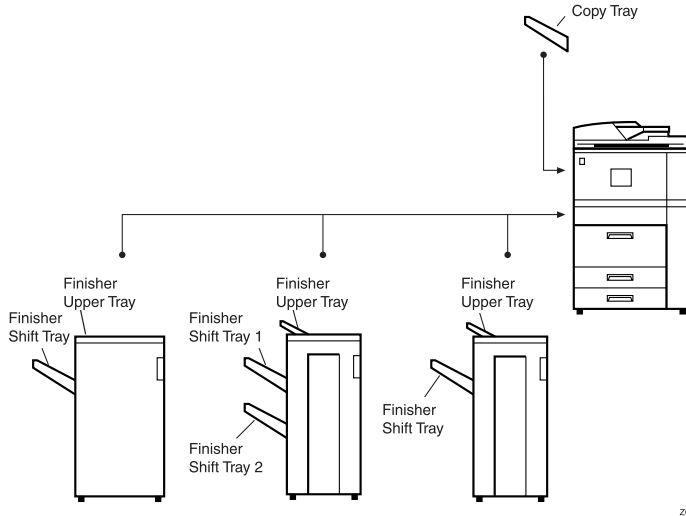

#### Note

- Default: *Copy Tray, Finisher Upper Tray*
- The default settings may vary depending on the finisher installed.

### ◆ Output: Document Server

You can specify a tray to which documents are delivered.

#### Note

- Default: *Copy Tray, Finisher Upper Tray*
- For details about output trays, see p.53 "Output: Copier".
- The default settings may vary depending on the finisher installed.

❖ **Output: Printer**

You can specify a tray to which prints are delivered.

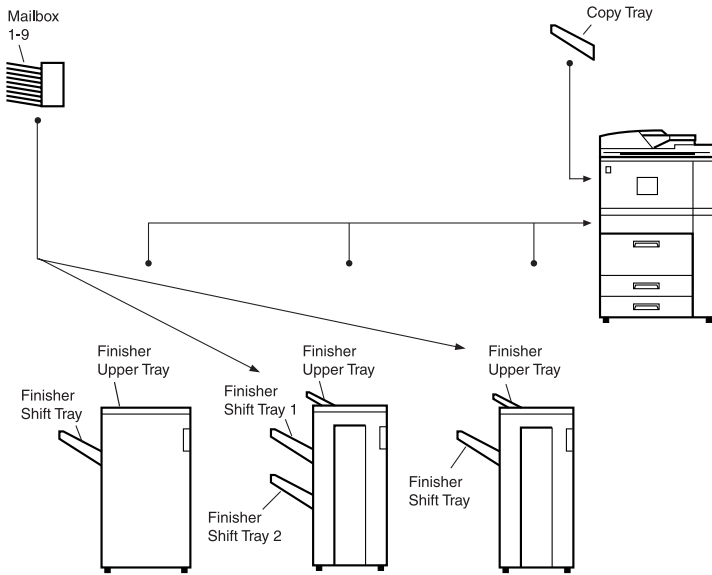

**Note**

- Default: *Copy Tray, Finisher Upper Tray*
- The output trays set on the printer driver have priority over the output tray specified above.
- The default settings may vary depending on the finisher installed.

❖ **ADF Original Table Elevation**

You can set the timing for elevating the auto document feeder (ADF) original table.

**Note**

- Default: *When Original is Set*

❖ **Job List Display Time**

You can set the length of time that the job list display is shown before the display reverts back to the default screen.

**Note**

- Default: *15 seconds*

### ◆ Z-fold Position

You can change the Z-fold position according to the paper size.

#### Note

- Default:
  - Metric version
    - A3: 2mm
    - B4 JIS: 2mm
    - A4: 2mm
    - 11"×17": 2mm
    - 8<sub>1</sub>/<sub>2</sub>"×14": 2mm
  - Inch version:
    - A3: 0.1"
    - B4 JIS: 0.1"
    - A4: 0.1"
    - 11"×17": 0.1"
    - 8<sub>1</sub>/<sub>2</sub>"×14": 0.1"

---

## Output tray settings

---

### Limitation

- You cannot interrupt the current stapling job even when a stapling job is specified with a different function.
- When the optional finisher is installed and stapling or shift-sorting is specified, the job will be delivered to the finisher shift tray regardless of the output tray specified.

---

## Tray Paper Settings

---

### ◆ Paper Tray Priority: Copier (Copier/Document Server)

You can specify the paper tray from which paper is to be supplied.

#### Note

- Default: *Tray 1*

### ◆ Paper Tray Priority: Printer (Printer)

You can specify the paper tray from which paper is to be supplied.

#### Note

- Default: *Tray 1, LCT*
- The default tray switches to LCT if the optional large capacity tray (LCT) is installed.

### ❖ Tray Paper Size: (Tray 2,3)

You can select the size of the copy paper loaded in the paper tray.

- The paper sizes you can load for trays, when the paper size selector knob is set to the ✖ mark, are as follows:
  - A3☐, B4 JIS☐, A4☐, A4☐, B5 JIS☐, B5 JIS☐, A5☐, A5☐, 210 × 340 mm☐, 210 × 182 mm☐, 210 × 170 mm☐
  - 11"×17"☐, 8<sup>1</sup>/<sub>2</sub>"×14"☐, 8<sup>1</sup>/<sub>2</sub>"×13"☐, 8<sup>1</sup>/<sub>2</sub>"×11"☐, 8<sup>1</sup>/<sub>2</sub>"×11"☐, 8<sup>1</sup>/<sub>4</sub>"×13"☐, 8"×13"☐, 7<sup>1</sup>/<sub>4</sub>"×10<sup>1</sup>/<sub>2</sub>"☐, 5<sup>1</sup>/<sub>2</sub>"×8<sup>1</sup>/<sub>2</sub>"☐, 5<sup>1</sup>/<sub>2</sub>"×8<sup>1</sup>/<sub>2</sub>"☐, 11"×15"☐, 11"×14"☐, 10"×15"☐, 8<sup>1</sup>/<sub>4</sub>"×14"☐, 8"×10<sup>1</sup>/<sub>2</sub>"☐, custom size (139.7-297 mm(5.5"-11.7") wide × 139.7-431.8 mm(5.5"-17") long)
  - 8K(267 × 390 mm)☐, 16K(195 × 267 mm)☐, 16K(195 × 267 mm)☐

### 🚨 Important

- ☐ If the specified paper size differs from the size of paper actually set in the paper tray, a paper misfeed might occur because the paper size cannot be detected accurately.

### 📝 Note

- ☐ Default: A4☐
- ☐ The tray fence for the optional large capacity tray (LCT) is fixed. If you need to change the paper size, contact your service representative.
- ☐ The optional tab sheet holder is required when using tab stock in tray 2 or 3.

### 🔍 Reference

See p.113 "Changing the Paper Size".

### ❖ Paper Type: Bypass tray

You can set the display to show the type of paper loaded in the bypass tray.

- The paper types you can set for the bypass tray are as follows:
  - Plain paper (No Display), Recycled Paper, Special Paper, Colour Paper 1, Colour Paper 2, Translucent Paper, Letterhead, Thick Paper, Label Paper, OHP, Cardstock, Bond Paper, Prepunched Paper, Preprinted Paper

### 📝 Note

- ☐ Default: *No display*

### ❖ Paper Type: (Tray1-3, LCT)

You can set the display to show the type of paper loaded in each of the trays. This information is used by the print function to automatically select the paper tray.

- The paper types you can set for trays are as follows:
  - Plain paper (No Display), Recycled Paper, Special Paper, Translucent Paper, Letterhead, Thick Paper, Colour Paper 1, Colour Paper 2, Tab Stock (2-3 tray), Bond Paper, Prepunched Paper, Preprinted Paper

 **Note** Default:

- Paper Type: *No display*
- Copying Method: *2 Sided Copy*
- Apply Auto Paper Select: *Yes*

- A  mark is displayed next to the paper tray if “No” is selected.
- The optional tab sheet holder is required when using tab stock in tray 2 or 3.
- The number of tab stock shifts can be set in millimeters, when **[Tab Stock]** has been selected.
- The number of tab stock shift can be set in 1 millimeter (1 inch) units, within a range of 0 to 15 mm(0" to 0.6"). The default is 13 mm(0.5").
- “Thick Paper” and “Tab Stock” can be set simultaneously.

 **Limitation**

- [Auto Paper Select]** can only be selected for the copier function if **[No Display]** and **[Recycled Paper]** are selected. If **[No]** is selected, Auto Paper Select is not valid.

**❖ Cover Sheet Tray**

You can specify and display the paper tray that is used to set cover sheets. After selecting the paper tray, you can also specify the display timing and copy method for two-sided copying.

 **Note** Default:

- Tray to Program: *Off*
- Functions using the Cover Sheet Tray setting are front cover function and front/back cover function.
- When **[At Mode Selected]** is selected, the cover sheet tray settings are only displayed when the cover function or slip sheet function is selected.
- You can set Copying Method in Duplex setting only when **[At Mode Selected]** is selected.

 **Reference**

“Covers”, *Copy Reference*

**❖ Slip Sheet Tray, Designation Sheet Tray 1/2**

You can specify and display the paper tray that is used for setting slip sheets. You can also specify the display timing and copy method for two-sided copying.

 **Note** Default:

- Tray to Program: *Off*

- When **[At Mode Selected]** is selected, the slip sheet settings are only displayed when the cover function or slip sheet function is selected.
- When **[Interposer Tray]** has been selected in the Slip Sheet 2 tray settings, "Copying Method in Duplex" will not be displayed.
- OHP slip sheets cannot be copied when using the interposer.

#### Reference

"Slip Sheets", *Copy Reference*

#### ◆ Printer Bypass Paper Size

You can specify the size of the paper in the bypass tray when printing data from the computer.

#### Note

- Default: A4 

4

---

## Timer Settings

---

#### ◆ Auto Off Timer

The machine turns off automatically to conserve energy after a specified time has elapsed following job completion. This function is called "Auto Off". The machine status after Auto Off operation is referred to as "Off mode" or "Sleep mode". For the Auto Off Timer, specify the time to elapse before Auto Off.

#### Note

- Default: 1 minute(s)
- When in "Off mode" or "Sleep mode", the machine is ready for use within 30 seconds.
- The time can be set from 1 to 240 minutes using the number keys.

#### ◆ Energy Saver Timer

You can set the time that the machine waits before switching to lower power mode after copying has finished or the last operation is performed. The time can be set from 1 minute to 240 minutes using the number keys.

#### Note

- Default: 15 minute(s)

#### ◆ Panel Off Timer

You can set the time that the machine waits before switching the panel off after copying has finished or the last operation is performed.

#### Note

- Default: 1 minute(s)
- The warm up time for making a copy from standby mode is 0 seconds.
- The interval time can be set from 10 to 240 minutes using the number keys.

### ❖ System Auto Reset Timer

The System Reset setting automatically switches to the screen of the function set in Function Priority when no operations are in progress, or when an interrupted job is cleared. This setting determines the system reset interval. See p.51 "Function Priority".

#### Note

- Default: *60 seconds*
- The time can be set from 10 to 999 seconds, in one second increments, using the number keys.

### ❖ Copier/Document Server Auto Reset Timer (Copier/Document Server)

You can specify the time to elapse before copier and Document Server functions are reset.

#### Note

- Default: *60 seconds*
- If [**Off**] is selected, the machine will not automatically switch to the user code entry screen.
- The time can be set from 10 to 999 seconds, in one second increments, using the number keys.

### ❖ Scanner Auto Reset Timer (Scanner)

You can specify the time to elapse before the scanner function is reset.

#### Note

- Default: *60 seconds*
- If [**Off**] is selected, the machine will not automatically switch to the user code entry screen.
- The time can be set from 10 to 999 seconds, in one second increments, using the number keys.

### ❖ Set Date

You can set the date for the copier's internal clock using the number keys.

#### Note

- To change between year, month and day, press [**←**] and [**→**].

### ❖ Set Time

You can set the time for the copier's internal clock using the number keys.

#### Note

- To change between hours, minutes and seconds, press [**←**] and [**→**].

◆ **Weekly Timer Code**

You can set an 8-digit code needed to turn on the power when it is off because of the Weekly Timer settings.

 **Note**

- Default: *Off*
- If **[On]** is selected, enter the weekly timer code.
- If **[On]** is selected without entering the timer code, the machine cannot be used even if the power is turned on. If **[Off]** is selected, the machine can be used without the need for a timer code.

◆ **Auto Logout Timer**

You can specify whether or not to automatically log out a user when the user does not operate the machine for a specified period of time after logging in.

 **Note**

- Default: *On, 60 seconds*
- When **[On]** is selected, the time can be set from 10 to 999 seconds, in one second increments, using the number keys.

◆ **Weekly Timer: Monday – Sunday**

You can specify the times at which the power is turned on and off on each day of the week.

 **Note**

- Enter the time in the 24-hour format.

---

## Administrator Tools

---

The following User Tools should be set by the administrator.

◆ **User Authentication Management**

*See Security Reference.*

◆ **Administrator Authentication Management**

*See Security Reference.*

◆ **Program/ Change Administrator**

*See Security Reference.*

◆ **Key Counter Management**

You can specify that functions that you want to manage with the key counter.

◆ **External Charge Unit Management**

You can specify that functions that you want to manage with the external charge unit.

◆ **Enhanced External Charge Unit Management**

You can specify that extended features that you want to manage with the external charge unit.



## ◆ Extended Security

See *Security Reference*.

## ◆ Display/Print Counter

Allows you to view and print the various counters.

- Display/Print Counter  
Displays counters for each functions (Total, Copier, Printer, A3/DLT, Duplex, Staple).
- Print Counter List  
Prints out a list of counters for each functions.
- To print the counter list
  - ① Press the **[User Tools/Counter]** key.
  - ② Press **[System Settings]**.
  - ③ Press **[Administrator Tools]**.
  - ④ Press **[Display/Print Counter]**.
  - ⑤ Press **[Print Counter List]**.

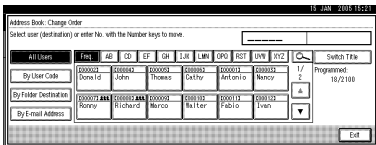

- ⑥ Press the **[Start]** key.
- ⑦ Press **[Exit]**.

## ◆ Display/Clear/Print Counter per User

Allows you to view and print the various counters accessed with users and to set the values to 0.

### Note

- Press **[▲Prev.]** and **[▼Next]** to show all counters.
  - Print Counter for All Users  
Prints the counter values for all the users.
  - Clear Counter for All Users  
Sets the counter value for all the users.
  - Print Counter per User  
Prints the counter values for each user.
  - Clear Counter per User  
Sets the counter value for each user.

### Note

- To print a list for each user, see p.73 "Printing the Counter for Each User Code".

## ◆ Address Book Management

You can add, change or delete information registered in the Address Book. For details, see p.66 “Address Book”.

- **[Program/Change]**

You can register and change names as well as user codes.

- Names

You can register a name, key display, registration number, and title selection.

- Auth. Info

You can register a user code, and specify the functions available to each user code. You can also register user names and passwords to be used when sending e-mail, sending files to folders, or accessing an LDAP server.

- Protection

You can register a protection code.

- E-mail

You can register an e-mail address.

- Folder

you can register the protocol, path, user name, password, port number, and server name.

- Add to Group

You can put names registered in the Address Book into a group.

- **[Delete]**

You can delete a name from the Address Book.

### Note

- You can register up to 2,000 names.
- You can register up to 500 user codes.
- You can also register user codes from SmartDeviceMonitor for Admin.

## ◆ Address Book: Program/Change/Delete Group

Names registered in the Address Book can be added into a group.

You can then easily manage the names registered in each group. For details, see p.85 “Registering Names to a Group”.

- **[Program/Change]**

You can register new groups, or changes a group name, key display, title selection or registration number.

- **[Delete]**

You can delete a group.

### Note

- You can register up to 100 groups.
- You can also group users using a Web browser. For more information, see the Web Browser help.

## ◆ Address Book: Change Order

You can change the order of the names in the Address Book.

### Note

You can rearrange the order of items that are on the same page, but you cannot move the items to another page. For example, you cannot move an item from “PLANNING” ([OPQ]) to “DAILY” ([CD]).

- ① Press the **[User Tools/Counter]** key.
- ② Press **[System Settings]**.
- ③ Press **[Administrator Tools]**, and then press **[▼ Next]**.
- ④ Press **[Address Book: Change Order]**.
- ⑤ Press the name key to be moved.

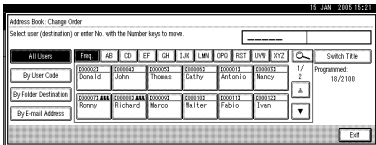

### Note

You can also select a name using the number keys.

- ⑥ Press the name key in the place that you want to move to.

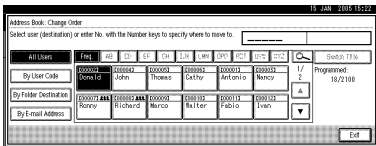

The name selected in step ⑤ moves to the place selected in step ⑥, and the keys for other names will be shifted accordingly.

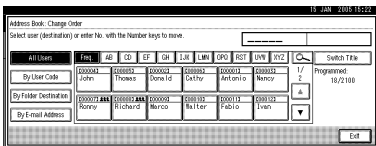

### Note

You can also select a name using the number keys.

## ◆ Print Address Book: Destination List

You can print the list of names registered in the Address Book.

- **Print in Title 1 Order**  
Prints a list of the names according to the order in Title 1.
- **Print in Title 2 Order**  
Prints a list of the names according to the order in Title 2.
- **Print in Title 3 Order**  
Prints a list of the names according to the order in Title 3.

- Print Group Dial List  
Prints a list of the groups registered.
  - ① Select the print format.
  - ② To print on two-sided pages, select **[Print on 2 Sides]**.
  - ③ Press the **[Start]** key.  
The list is printed.

❖ **Address Book: Edit Title**

You can edit the title to locate the desired user easily.

- ① Press the **[User Tools/Counter]** key.
- ② Press **[System Settings]**.
- ③ Press **[Administrator Tools]**, and then press **[▼ Next]**.
- ④ Press **[Address Book: Edit Title]**.
- ⑤ Press the title key to be changed.

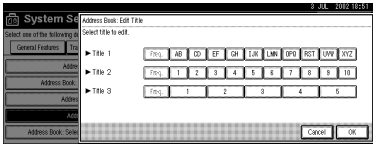

- ⑥ Enter the new name, and then press **[OK]**.
- ⑦ Press **[OK]**.

❖ **Address Book: Select Title**

You can specify the title to select a name.

 **Note**

- Default: *Title 1*

❖ **Auto Delete File**

You can specify whether documents stored in the Document Server will or will not be deleted after a specified period of time.

 **Note**

- Default: *Yes After 3 day(s)*
- If you select **[Yes]**, documents stored subsequently will be deleted.
- If you select **[No]**, documents will not be deleted automatically.
- If you select **[Yes]**, enter a number of days in the range of 1 - 180.
- The default setting is three days, which means documents will be deleted three days (72 hours) after they have been stored.

### ❖ Delete All Files

All documents stored in Document Server will be deleted.

#### Note

- Even if a password has been set, all documents will be deleted.
- A confirmation dialog box will appear. To delete all documents, select [Yes].

### ❖ Program/ Change LDAP Server

See *Network Guide*.

### ❖ Use LDAP Server

You can specify whether or not to use the LDAP server.

#### Note

- Default: *Off*
- When Use LDAP Server is set to Off, [Search LDAP] will not appear on the searching display.

### ❖ AOF (Always On)

Specify whether or not to use Auto Off function.

#### Note

- Default: *On*
- For details about this function, contact your service representative.

### ❖ Firmware Version

You can check the version of the softwares installed in this machine.

### ❖ Auto Erase Memory Setting

When the optional DataOverwriteSecurity Unit is installed, you can specify if data is to be automatically deleted after a job is completed.

#### Note

- Default: *Off*
- You can also specify the method of overwriting.

#### Reference

See the manual for DataOverwriteSecurity Unit.

### ❖ Erase All Memory

When the optional DataOverwriteSecurity Unit is installed, you can erase all the data stored in the hard disk drive of the machine.

#### Reference

See the manual for DataOverwriteSecurity Unit.

# Address Book

Registering information such as the names of users and their e-mail addresses in the Address Book allows you to manage them easily.

## Important

- ❑ Address Book data is stored on the hard disk. It can be lost if there is some kind of hard disk failure. The manufacturer shall not be responsible for any damages resulting data loss.

## Note

- ❑ You can also use a Web browser to register names in the Address Book. With the SmartDeviceMonitor for Admin, you can register multiple names at the same time.
- ❑ You can backup Address Book data using [Address Management Tool] in SmartDeviceMonitor for Admin. Backing up of the data is recommended.

## Reference

For details about using a Web browser, see the Web browser Help.

For details about SmartDeviceMonitor for Admin and how to install it, see *Printer Reference*.

For operating instructions, see SmartDeviceMonitor for Admin Help.

You can register and manage the following items in the Address Book:

## Names

You can register the name of the user and the key display. This is the basic information required for managing users of the machine.

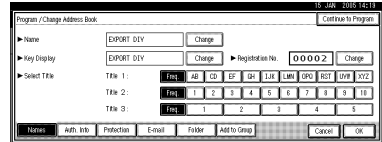

## Authentication Information

You can register user codes in order to restrict particular functions to certain users, and to check their use of each function. You can also register login user names and login passwords to be used when sending e-mail, sending to folders, or accessing an LDAP server.

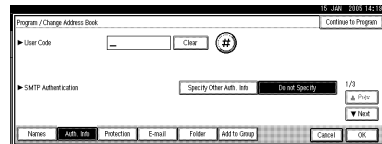

## Protection

You can set protection codes to stop sender's names from being used or folders from being accessed without authorization.

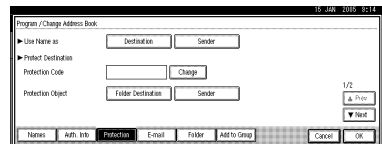

### ❖ E-mail

You can register e-mail destinations in the Address Book.



### ❖ Folder

You can register the protocol, path name and server name.

- SMB

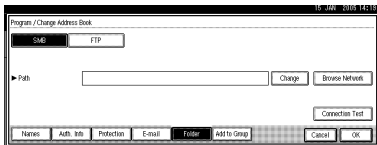

- FTP

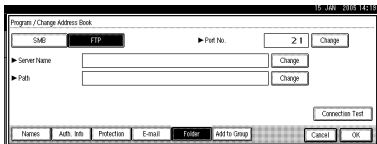

### ❖ Add to Group

You can put registered e-mail and folder destinations into a group for easier management.

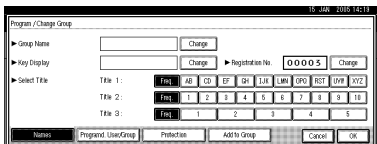

## Managing names in the Address Book

By registering a name and key display beforehand, you can specify e-mail and folder destinations simply by selecting the name key.

See p.69 “Registering Names”.

## Sending e-mail by Quick Dial

By registering e-mail addresses in the Address Book, you can specify e-mail destinations simply by selecting them from the initial scanner display when sending a document using the scanner function.

A registered e-mail address can be used as the sender's address, and the sender's address are automatically entered in the “From” field of an e-mail header.

See p.75 “E-mail Destination”.

## Sending scanned files to a shared folder directly

After registering the path name, user name and password, you can connect to a shared folder simply by selecting the destination shown on the initial scanner display whenever sending files using the scanner function to a shared folder.

To share the folder using Windows, select the SMB protocol.

To register the folder to the FTP server, select the FTP protocol.

See p.78 “Registering Folders”.

## Preventing unauthorized user access to shared folders from the machine

After registering a protection code, you can specify the object of protection to prevent an e-mail destination from being used without permission.

You can also prevent unauthorized access to registered folders. See p.89 “Registering a Protection Code”.

---

### **Managing users and machine usage**

---

You can assign user codes to limit registered users and check their use of the Copier, Document Server, Printer and Scanner functions.

See p.71 “Authentication Information”.



# Registering Names

Registering names in the Address Book is useful for selecting e-mail destinations when you send e-mail. You can also use the name as a folder destination.

## Registering a Name

**1** Press the **[User Tools/Counter]** key.

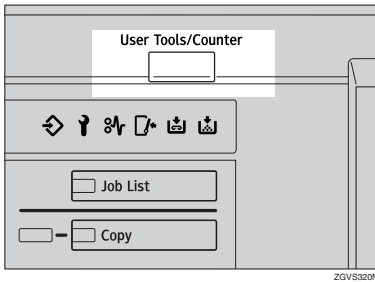

ZGVSS20N

**2** Press **[System Settings]**.

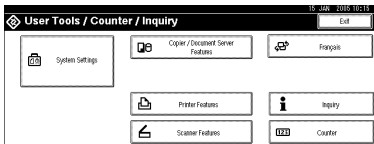

**3** Press **[Administrator Tools]**, and then press **[▼Next]**.

**4** Press **[Address Book Management]**.

**5** Press **[New Program]**.

**6** Press **[Change]** on the right of Name. The name entry display appears.

### Reference

p.133 "Entering Text"

**7** Enter the name, and then press **[OK]**.

### Note

- The name registered here can also be used for documents in the Document Server. For details, see p.36 "Using the Document Server".

To select the title

**1** Press the key for the classification you want to use under **Select Title**.

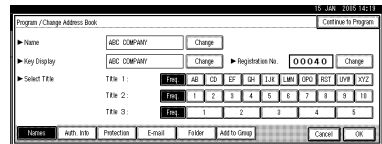

### Note

- The keys you can select are as follows:

- [Freq.]**... Added to the page that is displayed first.
- [AB], [CD], [EF], [GH], [IJK], [LMN], [OPQ], [RST], [UVW], [XYZ]**... Added to the alphabetical group selected.
- [1] to [10]**...Added to the category number selected.

- You can select **[Freq.]** and one more page for each title.

**8** To continue registering names, press **[Continue to Program]**, and then repeat the procedure from step **6**.

**9** Press **[OK]**.

**10** Press **[Exit]**.

**11** Press the **[User Tools/Counter]** key.

---

## Changing a Registered Name

---

- 1** Press the **[User Tools/Counter]** key.
- 2** Press **[System Settings]**.
- 3** Press **[Administrator Tools]**, and then press **[▼Next]**.
- 4** Press **[Address Book Management]**.
- 5** Select the name you want to change.

Press the name key, or enter the registered number using the number keys.

 **Note**

- If you press , you can search by the registered name, user code, folder name or e-mail address.

---

To change the name or key display

---

- 1** Press **[Change]** on the right of the name or key display.
- 2** Enter the new name or key display, and then press **[OK]**.

 **Reference**

p.133 "Entering Text"

---

To change the title

---

- 1** Press the key for the classification you want to use from **Select Title**.
- 6** Press **[OK]**.
- 7** Press **[Exit]**.
- 8** Press the **[User Tools/Counter]** key.

---

## Deleting a Registered Name

---

- 1** Press the **[User Tools/Counter]** key.
- 2** Press **[System Settings]**.
- 3** Press **[Administrator Tools]**, and then press **[▼Next]**.
- 4** Press **[Address Book Management]**.
- 5** Press **[Delete]**.
- 6** Select the name you want to delete.  
Press the name key, or enter the registered number using the number keys.
- 7** Press **[Yes]**.
- 8** Press **[Exit]**.
- 9** Press the **[User Tools/Counter]** key.

# Authentication Information

You can assign user codes to limit registered users to the following functions and check their use of each functions:

- Copier
- Document Server
- Scanner
- Printer

## Note

- The number of copies scanned using the scanner function is counted for each user code. This allows you to check each user's usage.

## Important

- The functions associated with each user code are the same. If you change or delete user codes, management data and limits associated with that code become invalid.

## Registering a New User Code

- 1 Press the **[User Tools/Counter]** key.

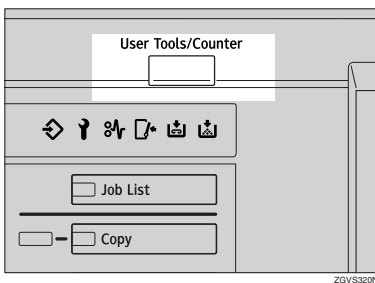

ZGVSS20N

- 2 Press **[System Settings]**.

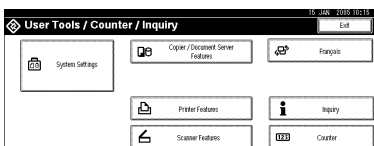

- 3 Press **[Administrator Tools]**, and then press **[▼Next]**.

- 4 Press **[Address Book Management]**.

- 5 Press the name to which an user code is to be assigned, or enter the registered number using the number key.

## Note

- To register a name in the Address Book, see p.69 "Registering a Name".

- 6 Press **[Auth. Info]**.

- 7 Enter the user code using the number keys, and then press **[#]**.

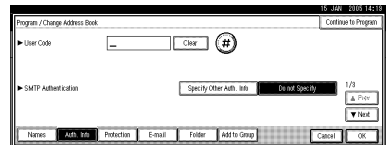

## Note

- If you make a mistake, press **[Clear]** or the **[Clear/Stop]** key, and then enter the code again.

- 8 Press **[▼ Next]** twice.

- 9 Select the functions to be used with the user code from Available Functions.

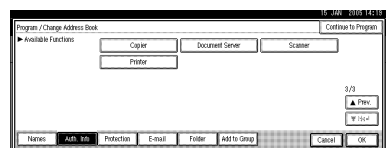

- 10 Press **[OK]**.

## Note

- To continue registering user codes, repeat the procedure from step 3.

- 11** Press [Exit].
- 12** Press the [User Tools/Counter] key.

## Changing a User Code

 **Note**

- Even if you change a user code, the counter value will not be cleared.

- 1** Press the [User Tools/Counter] key.
- 2** Press [System Settings].
- 3** Press [Administrator Tools], and then press [▼Next].

- 4** Press [Address Book Management].

- 5** Select the registered user code you want to change.

Press the name key, or enter the registered number using the number keys.

 **Note**

- If you press , you can search by the registered name, user code, folder name or e-mail address.
- To change the registered name, key display and title, see p.70 "Changing a Registered Name".

- 6** Press [Auth. Info].
- 7** Press [Change], and then enter the new user code using the number keys.

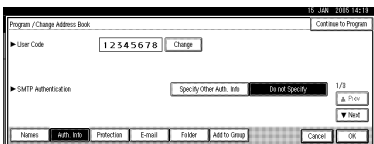

- 8** Press [#].

To change the available functions

- 1** Press [▼Next] twice.
- 2** Press the keys for each function.

 **Note**

- Press the key to highlight it, and then the function is enabled. To cancel a selection, press the highlighted key.

- 9** Press [OK].

- 10** Press [Exit].

- 11** Press the [User Tools/Counter] key.

## Deleting a User Code

 **Note**

- After clearing the user code, the counter is automatically cleared.
- To delete a name from the Address Book entirely, see p.70 "Deleting a Registered Name".

- 1** Press the [User Tools/Counter] key.

- 2** Press [System Settings].

- 3** Press [Administrator Tools], and then press [▼Next].

- 4** Press [Address Book Management].

- 5** Select the name whose code is to be deleted.

Press the name key, or enter the registered number using the number keys.

- 6** Press [Auth. Info].

- Press **[Change]** to delete the user code, and then press **[#]**.

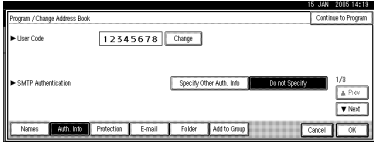

- Press **[OK]**.
- Press **[Exit]**.
- Press the **[User Tools/Counter]** key.

## Displaying the Counter for Each User Code

- Press the **[User Tools/Counter]** key.
- Press **[System Settings]**.
- Press **[Administrator Tools]**.
- Press **[Display/Clear/Print Counter per User]**.
- Select **[Print Counter]**, or **[Scanner Counter]**.

Counters for individual function usage under each user code appear.

## Printing the Counter for Each User Code

- Press the **[User Tools/Counter]** key.
- Press **[System Settings]**.
- Press **[Administrator Tools]**.
- Press **[Display/Clear/Print Counter per User]**.
- Select a user code from the left side of the display.

### Note

- Press **[Select All on the Page]** to select all user codes on the page.

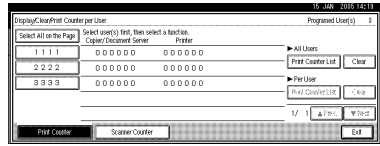

- Press **[Print Counter List]** under **Per User**.

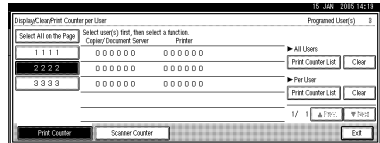

### Note

- Enter the user code, and then press **[#]** if the user code is registered.
- Select the function usage you want to print from **[Print Counter]** or **[Scanner Counter]**.
  - Press **[Print]**.

To print the number of prints for all user codes

- Press the **[User Tools/Counter]** key.
- Press **[System Settings]**.
- Press **[Administrator Tools]**.
- Press **[Display/Clear/Print Counter per User]**.
- Press **[Print Counter List]** under **All Users**.

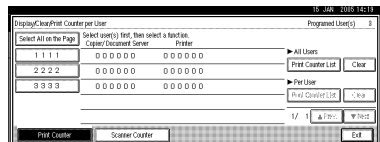

 **Note**

- Enter the user code, and then press [#] if the user code is registered.

**6** Select the function usage you want to print from [Print Counter] or [Scanner Counter].

**7** Press [Print].

---

## Clearing the Number of Prints

---

**1** Press the [User Tools/Counter] key.

**2** Press [System Settings].

**3** Press [Administrator Tools].

**4** Press [Display/Clear/Print Counter per User].

**5** Select the user code to clear.

---

To clear the number of prints made under a user code

---

**1** Select the user code from the left side of the display.

 **Note**

- Press [Select All on the Page] to select all user codes on the page.

**2** Press [Clear] under Per User.

**3** Select the function usage you want to clear from [Print Counter] or [Scanner Counter].

**4** Press [OK].

---

To clear the number of prints for all user codes

---

**1** Press [Clear] under All Users.

**2** Select the function usage you want to clear from [Print Counter] or [Scanner Counter].

**3** Press [OK].

**6** Press [Exit].

**7** Press the [User Tools/Counter] key.

# E-mail Destination

You can register e-mail destinations so that there is no need to enter one every time that you send by e-mail files scanned in scanner mode.

- Registering “Name” and “Key Display” at the same time will make it even easier to select an e-mail destination.
- You can register e-mail destinations as a group.
- You can use the e-mail address as the sender's address when sending scan files in scanner mode. If you want to do so set a protection code on the sender address to prevent unauthorized access. See p.89 “Registering a Protection Code”.

## Note

- You can select an e-mail address from an LDAP server, and then register it in the Address Book. For details, see *Scanner Reference*.

## Registering an E-mail Destination

- 1 Press the **[User Tools/Counter]** key.

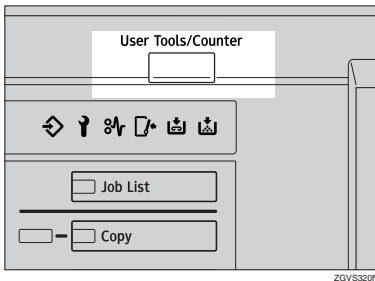

- 2 Press **[System Settings]**.

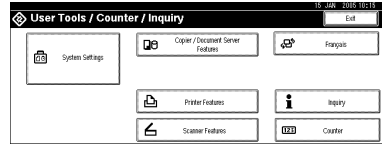

- 3 Press **[Administrator Tools]**, and then press **[▼Next]**.

- 4 Press **[Address Book Management]**.

- 5 Press the name you want to register, or enter the registered number using the number keys.

## Note

- To register a name in the Address Book, see p.69 “Registering a Name”.

- 6 Press **[E-mail]**.

- 7 Press **[Change]** under E-mail Address.

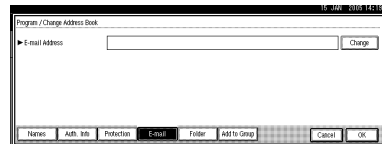

- 8 Enter the e-mail address, and then press **[OK]**.

## Using the e-mail address as the sender

When an e-mail address has been registered, you can use it as the sender's address.

- 1 Press **[Protection]**.

- 2 Press **[Sender]** on the right side of Use Name as.

- 3 Press **[OK]**.

- 4 Press **[Auth. Info]**.
- 5 Press **[Specify Other Auth. Info]** on the right side of SMTP Authentication.

 **Note**

When **[Do not Specify]** is selected, the user name and password that you have specified in SMTP Authentication of File Transfer settings applies. For details, see *Network Guide*.

- 6 Press **[Change]** under Login User Name.
- 7 Enter the login user name, and then press **[OK]**.

 **Reference**

p.133 "Entering Text"

- 8 Press **[Change]** under Login Password.
- 9 Enter the login password, and then press **[OK]**.

 **Note**

You can enter up to 64 characters for the password.

- 10 Press **[OK]**.

- 9 Press **[OK]**.

 **Note**

When a group is registered, other e-mail destinations can be added to the group. See p.85 "Registering Names to a Group".

- 10 Press **[Exit]**.

- 11 Press the **[User Tools/Counter]** key.

## Changing a Registered E-mail Destination

- 1 Press the **[User Tools/Counter]** key.
- 2 Press **[System Settings]**.
- 3 Press **[Administrator Tools]**, and then press **[▼Next]**.
- 4 Press **[Address Book Management]**.
- 5 Select the name whose e-mail address you want to change.

Press the name key, or enter the registered number using the number keys.

 **Note**

- If you press , you can search by the registered name, user code, folder name or e-mail address.
- To change the name, key display, and title, see p.70 "Changing a Registered Name".

- 6 Press **[E-mail]**.
- 7 Press **[Change]** under E-mail Address.



- 8 Enter the e-mail address, and then press **[OK]**.

 **Reference**

p.133 "Entering Text"

- 9 Press **[OK]**.
- 10 Press **[Exit]**.
- 11 Press the **[User Tools/Counter]** key.



---

## Deleting a Registered E-mail Destination

---

 **Note**

- To delete a name from the Address Book entirely, see p.70 "Deleting a Registered Name".

**1** Press the **[User Tools/Counter]** key.

**2** Press **[System Settings]**.

**3** Press **[Administrator Tools]**, and then press **[▼Next]**.

**4** Press **[Address Book Management]**.

**5** Select the name whose e-mail address you want to delete.

Press the name key, or enter the registered number using the number keys.

**6** Press **[E-mail]**.

**7** Press **[Change]** under E-mail Address.

**8** Press **[Delete All]**, and then press **[OK]**.

**9** Press **[OK]**.

**10** Press **[Exit]**.

**11** Press the **[User Tools/Counter]** key.

# Registering Folders

By registering a shared folder, you can send scan files to it directly.

There are two types of protocol you can use:

- SMB  
For sending files to shared Windows folders
- FTP  
Use when sending files to an FTP server.

4

**Note**

- ❑ For details about protocols, server names, and folder levels, consult your network administrator.
- ❑ You can prevent unauthorized users from accessing folders from the machine. See p.89 “Registering a Protection Code”.
- ❑ You can only select either SMB or FTP. If you change protocol after finishing your settings, all previous entries are cleared.
- ❑ You can register up to 50 folders per group. Files cannot be sent to a group with over 50 folders registered.

**Reference**

For details about network settings, see *Network Guide*.

For details about Scan to Folder, see *Scanner Reference*.

## Using SMB to Connect

**Note**

- ❑ To register a folder in an FTP server, see p.81 “Using FTP to Connect”.

### To register an SMB folder

**1** Press the **[User Tools/Counter]** key.

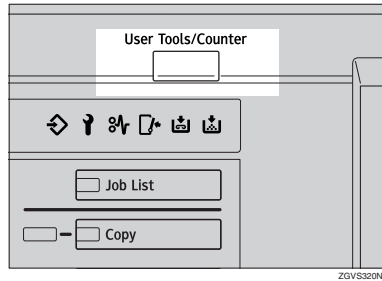

**2** Press **[System Settings]**.

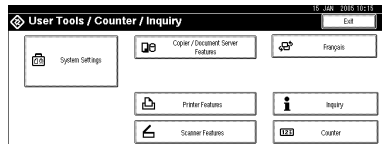

**3** Press **[Administrator Tools]**, and then press **[▼Next]**.

**4** Press **[Address Book Management]**.

**5** Press the name you want to register or enter the registered number using the number keys.

**Note**

- ❑ To register a name in the Address Book, see p.69 “Registering a Name”.

**6** Press **[Auth. Info]**, and then press **[▼Next]**.

**7** Press **[Specify Other Auth. Info]** on the right side of **Folder Authentication**.

 **Note**

- When **[Do not Specify]** is selected, the SMB User Name and SMB Password that you have specified in Default User Name/Password (Send) of File Transfer settings applies. For details, see *Network Guide*.

**8** Press **[Change]** under **Login User Name**.

**9** Enter the login user name, and then press **[OK]**.

 **Reference**

p.133 "Entering Text"

**10** Press **[Change]** under **Login Password**.

**11** Enter the password, and then press **[OK]**.

 **Note**

- You can enter up to 128 characters for the password.

**12** Press **[OK]**.

**13** Press **[Folder]**.

**14** Confirm that **[SMB]** is selected.



 **Note**

- To specify a folder, you can either enter the path manually or locate the folder by browsing the network.

 **Reference**

p.79 "To locate the folder manually"

p.79 "Using Browse Network to locate the folder"

---

### To locate the folder manually

---

**1** Press **[Change]** under **Path**.

**2** Enter the path where the folder is located.

 **Note**

- Enter the path using this format: "\\ServerName\ShareName\PathName".
- You can also enter an IP address.
- You can enter a path using up to 128 characters.

**3** Press **[OK]**.

 **Note**

- If the format of the entered path is not correct, a message appears. Press **[Exit]**, and then enter the path again.

---

### Using Browse Network to locate the folder

---

**1** Press **[Browse Network]**.

The client computers sharing the same network as the machine appear.

 **Note**

- If you have already specified your user name and password in steps **6** to **12**, the Browse Network display only lists client computers you are authorized to access.

**2** Select a client computer.

Shared folders under it appear.

 **Note**

- You can press **[Up One Level]** to switch between levels.

**3** Select the folder you want to register.

The Logon display appears.

 **Note**

- If you have logged in with an authenticated user name and password, the Logon display will not appear. Proceed to step **6**.

**4** Enter the user name.

 **Note**

- This is the user name that is authorized to access the folder.

**5** Enter the user password, and then press **[OK]**.

The Browse Network display reappears.

 **Note**

- If the user name or password entered is not correct, a message appears. Press **[Exit]**, and then enter again.

**6** Press **[OK]**.

**15** Press **[Connection Test]** to check the path is set correctly.

**16** Press **[Exit]**.

 **Note**

- If the connection test fails, check the settings, and then try again.

**17** Press **[OK]**.

**18** Press **[Exit]**.

**19** Press the **[User Tools/Counter]** key.

---

### Changing a registered folder

---

**1** Press the **[User Tools/Counter]** key.

**2** Press **[System Settings]**.

**3** Press **[Administrator Tools]**, and then press **[▼Next]**.

**4** Press **[Address Book Management]**.

**5** Select the name whose folder you want to change.

Press the name key, or enter the registered number using the number keys.

 **Note**

- If you press , you can search by the registered name, user code, folder name or e-mail address.
- To change the name, key display, and title, see p.70 "Changing a Registered Name".

**6** Press **[Folder]**.

**7** Select the items you want to change.

---

#### To change the protocol

---

**1** Press **[FTP]**.

**2** A confirmation message appears. Press **[Yes]**.

 **Note**

- Changing the protocol will clear all settings made under the previous protocol.

**3** Enter each item again.

 **Reference**

p.81 "To register an FTP folder".

---

## Changing items under SMB

---

- 1** Press **[Change]** under Path.
- 2** Enter the new path where the folder is located, and then press **[OK]**.

 **Note**

- You can also use Browse Network to specify a new folder. For details, see p.79 "Using Browse Network to locate the folder".

- 8** Press **[Connection Test]** to check the path is set correctly.

- 9** Press **[Exit]**.

 **Note**

- If the connection test fails, check the settings, and then try again.

- 10** Press **[OK]**.

- 11** Press **[Exit]**.

- 12** Press the **[User Tools/Counter]** key.

---

## Deleting a registered folder

---

 **Note**

- To delete a name from the Address Book entirely, see p.70 "Deleting a Registered Name".

- 1** Press the **[User Tools/Counter]** key.

- 2** Press **[System Settings]**.

- 3** Press **[Administrator Tools]**, and then press **[▼Next]**.

- 4** Press **[Address Book Management]**.

- 5** Select the name whose folder you want to delete.

Press the name key, or enter the registered number using the number keys.

- 6** Press **[Folder]**.

- 7** Press the protocol which is not currently selected.

A confirmation message appears.

- 8** Press **[Yes]**.

- 9** Press **[OK]**.

- 10** Press **[Exit]**.

- 11** Press the **[User Tools/Counter]** key.

---

## Using FTP to Connect

---

 **Note**

- To register a shared folder configured in Windows, see p.78 "Using SMB to Connect".

---

## To register an FTP folder

---

- 1** Press the **[User Tools/Counter]** key.

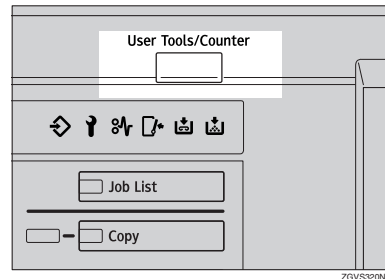

- 2** Press **[System Settings]**.

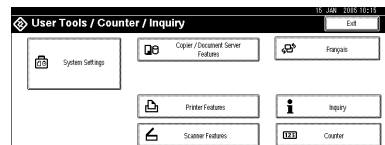

- 3** Press **[Administrator Tools]**, and then press **[▼Next]**.

- 4** Press **[Address Book Management]**.

**5** Press the name you want to register, or enter the registered number using the number keys.

**Note**

- To register a name in the Address Book, see p.69 “Registering a Name”.

**6** Press [Auth. Info], and then press [▼ Next].

**7** Press [Specify Other Auth. Info] on the right side of Authentication.

**Note**

- When [Do not Specify] is selected, the SMB User Name and SMB Password that you have specified in Default User Name/Password (Send) of File Transfer settings applies. For details, see *Network Guide*.

**8** Press [Change] under Login User Name.

**9** Enter the login user name, and then press [OK].

**Reference**

p.133 “Entering Text”

**10** Press [Change] under Login Password.

**11** Enter the password, and then press [OK].

**Note**

- You can enter up to 128 characters for the password.

**12** Press [OK].

**13** Press [Folder].

**14** Press [FTP].

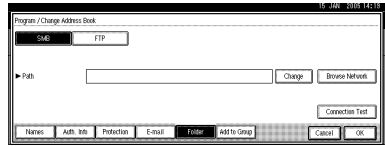

**Reference**

p.79 “To locate the folder manually”

p.79 “Using Browse Network to locate the folder”

**15** Press [Change] under Server Name.

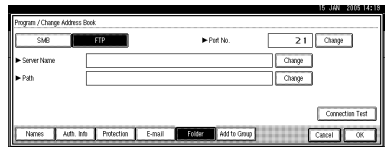

**16** Enter the server name, and then press [OK].

**Note**

- You can enter a server name using up to 64 characters.

**17** Press [Change] under Path.

**18** Enter the path.

**Note**

- You can enter an absolute path, using this format: “/user/home/username”; or a relative path, using this format: “directory/sub-directory”.

- If you leave the path blank, the login directory is assumed to be the current working directory.

- You can also enter an IP address.

- You can enter a path using up to 128 characters.

**19** Press [OK].

**Note**

- To change the port number, press **[Change]** under Port No.. Enter the port number using the number keys, and then press **[#]**.
- You can enter 1 to 65535.

**20** Press **[Change]** under Port Number.

**21** Press **[Connection Test]** to check the path is set correctly.

**22** Press **[Exit]**.

**Note**

- If the connection test fails, check the settings, and then try again.

**23** Press **[OK]**.

**24** Press **[Exit]**.

**25** Press the **[User Tools/Counter]** key.

### Changing a registered folder

**1** Press the **[User Tools/Counter]** key.

**2** Press **[System Settings]**.

**3** Press **[Administrator Tools]**, and then press **[▼Next]**.

**4** Press **[Address Book Management]**.

**5** Select the user of the registered folder you want to change.

Press the name key, or enter the registered number using the number keys.

**Note**

- If you press , you can search by the registered name, user code, folder name or e-mail address.
- To change the name, key display, and title, see p.70 "Changing a Registered Name".

**6** Press **[Folder]**.

**7** Select the items you want to change.

### To change the protocol

**1** Press **[SMB]**.

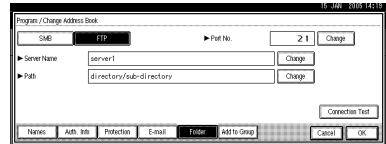

**2** A confirmation message appears. Press **[Yes]**.

**Note**

- Changing the protocol will clear all settings made under the previous protocol.

**3** Enter each item again.

**Reference**

p.78 "To register an SMB folder".

### Changing items under FTP

**1** Press **[Change]** under Port No.

**2** Enter the new port number, and then press **[#]**.

**3** Press **[Change]** under Server Name.

**4** Enter the new server name, and then press **[OK]**.

**5** Press **[Change]** under Path.

**6** Enter the new path, and then press **[OK]**.

**7** Press **[Change]** under User Name.

**8** Enter the new user name, and then press **[OK]**.

This is a user name which is authorized to access the folder.

**9** Press **[Change]** under Password.

**10** Enter the new password, and then press **[OK]**.

**8** Press **[Connection Test]** to check the path is set correctly.

**9** Press **[Exit]**.

 **Note**

- If the connection test fails, check the settings, and then try again.

**10** Press **[OK]**.

**11** Press **[Exit]**.

**12** Press the **[User Tools/Counter]** key.

4

---

### Deleting a registered folder

---

 **Note**

- To delete a user entirely, see p.70 "Deleting a Registered Name".

**1** Press the **[User Tools/Counter]** key.

**2** Press **[System Settings]**.

**3** Press **[Administrator Tools]**, and then press **[▼Next]**.

**4** Press **[Address Book Management]**.

**5** Select the user of the folder you want to delete.

Press the name key, or enter the registered number using the number keys.

**6** Press **[Folder]**.

**7** Press the protocol which is not currently selected.

A confirmation message appears.

**8** Press **[Yes]**.

**9** Press **[OK]**.

**10** Press **[Exit]**.

**11** Press the **[User Tools/Counter]** key.



# Registering Names to a Group

You can register names to a group to enable easy management of e-mail addresses and folders for each group. To add names to a group, the groups must be registered beforehand.

**Note**

- You can register up to 500 groups.
- When using Scan to Folder function, you cannot send scan files to a group with over 50 folders registered.
- You can set a protection code to prevent unauthorized access to the folders registered in a group. For details, see p.89 "Registering a Protection Code".

**5** Press **[New Program]**.

**6** Press **[Change]** under **Group Name**.

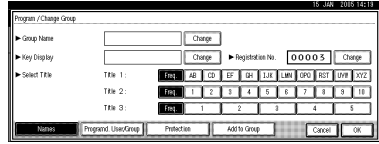

**7** Enter the group name, and then press **[OK]**.

The Key Display name is set automatically.

**Reference**

p.133 "Entering Text"

**8** Press the title key under **Select Title**, if necessary.

**Note**

The keys you can select are as follows:

- **[Freq.]...** Added to the page that is displayed first.
- **[AB], [CD], [EF], [GH], [IJK], [LMN], [OPQ], [RST], [UVW], [XYZ]...** Added to the list of items in the alphabetical group selected.
- **[1] to [10]...** Added to the category number selected.

You can select **[Freq.]** and one more page for each title.

**9** When you want to change the key display, press **[Change]** under **Key Display**. Enter the key display, and then press **[OK]**.

**10** Press **[OK]**.

**11** Press **[Exit]**.

**12** Press the **[User Tools/Counter]** key.

## Registering a New Group

**1** Press the **[User Tools/Counter]** key.

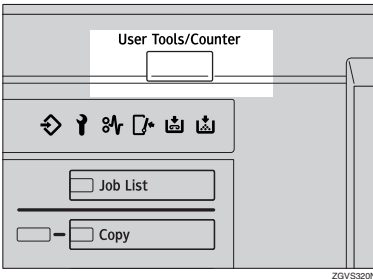

**2** Press **[System Settings]**.

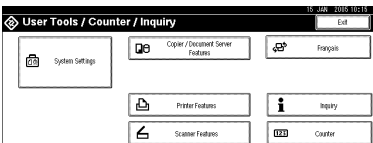

**3** Press **[Administrator Tools]**, and then press **[▼Next]**.

**4** Press **[Address Book: Program/Change/Delete Group]**.

## Registering Names to a Group

You can put names that have been registered in the Address Book into a group.

When registering new names, you can also register groups at the same time.

- 1** Press the **[User Tools/Counter]** key.
- 2** Press **[System Settings]**.
- 3** Press **[Administrator Tools]**, and then press **[▼Next]**.
- 4** Press **[Address Book Management]**.
- 5** Select the name to register in a group.

Press the name key, or enter the registered number using the number keys.

 **Note**

- If you press , you can search by the registered name, user code, folder name or e-mail address.

- 6** Press **[Add to Group]**.
- 7** Select a group to which you want to add the name to.

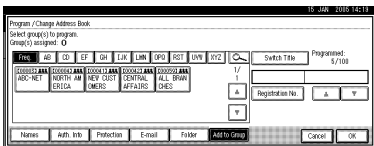

 **Note**

- If you press , you can search for a group by entering the group name.

- 8** Press **[OK]**.
- 9** Press **[Exit]**.
- 10** Press the **[User Tools/Counter]** key.

## Removing a Name from a Group

- 1** Press the **[User Tools/Counter]** key.
- 2** Press **[System Settings]**.
- 3** Press **[Administrator Tools]**, and then press **[▼Next]**.
- 4** Press **[Address Book Management]**.
- 5** Select the name to remove from a group.  
Press the name key, or enter the registered number using the number keys.
- 6** Press **[Add to Group]**.
- 7** Select the group from which you want to remove the name.

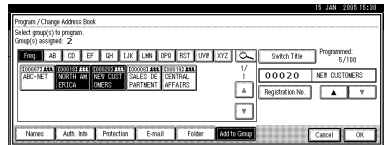

 **Note**

- Highlighted keys indicate groups in which the name has been registered.

The name is removed from the group.

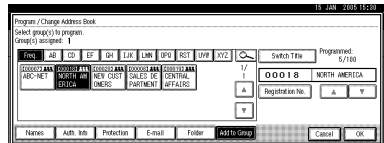

- 8** Press **[OK]**.
- 9** Press **[Exit]**.
- 10** Press the **[User Tools/Counter]** key.

## Displaying Names Registered in Groups

You can check the names registered in each group.

- 1** Press the [User Tools/Counter] key.
- 2** Press [System Settings].
- 3** Press [Administrator Tools], and then press [▼Next].
- 4** Press [Address Book: Program/Change/Delete Group].
- 5** Select the group where the data you want to check is registered.
- 6** Press [Programd. User/Group].

All the names registered will be displayed.

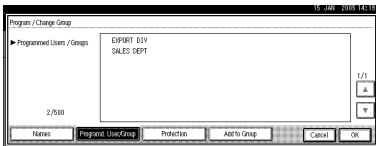

- 7** Press [OK].
- 8** Press [Exit].
- 9** Press the [User Tools/Counter] key.

## Changing a Group Name

- 1** Press the [User Tools/Counter] key.
- 2** Press [System Settings].
- 3** Press [Administrator Tools], and then press [▼Next].
- 4** Press [Address Book: Program/Change/Delete Group].
- 5** Press the group key you want to change.

- 6** Enter the items.

To change the group name and key display

- 1** Press [Change] under Group Name or Key Display.

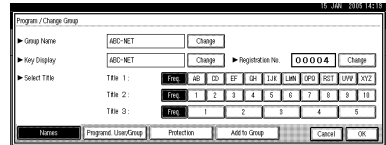

- 2** Enter the new group name or key display, and then press [OK].

To change the title

- 1** Press the title key under Select Title.

To change the registration number

- 1** Press [Change] under Registration No..
- 2** Enter the new registration number using the number keys.
- 3** Press [#].
- 7** Press [OK].
- 8** Press [Exit].
- 9** Press the [User Tools/Counter] key.

## Deleting a Group

- 1** Press the [User Tools/Counter] key.
- 2** Press [System Settings].
- 3** Press [Administrator Tools], and then press [▼Next].

- 4** Press [Address Book: Program/Change/Delete Group].
- 5** Press [Delete].
- 6** Press a group key you want to delete.
- 7** Press [Yes].
- 8** Press [Exit].
- 9** Press the [User Tools/Counter] key.

- 7** Select the group which you want to add to.

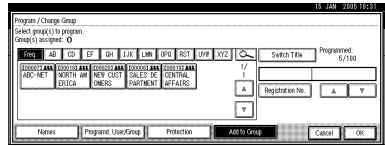

The group key that you have selected becomes highlighted, and the group is added to it.

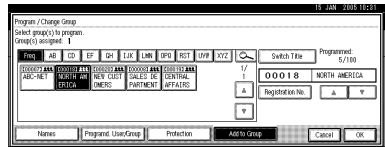

- 8** Press [OK].
- 9** Press [Exit].
- 10** Press the [User Tools/Counter] key.

**4**

## Adding a Group to Another Group

You can add a group to another group.

- 1** Press the [User Tools/Counter] key.
- 2** Press [System Settings].
- 3** Press [Administrator Tools], and then press [▼Next].
- 4** Press [Address Book: Program/Change/Delete Group].
- 5** Select the group that you want to put into another group.  
Press the group key, or enter the registered number using the number keys.
- 6** Press [Add to Group].

# Registering a Protection Code

You can stop sender's names or folders being accessed by setting a protection code.

You can use this function to protect the following:

- Folders  
You can prevent unauthorized access to folders.
- Sender's names (when sending e-mail)  
You can prevent misuse of sender's names.

## Registering a Protection Code for a Name in the Address Book

**1** Press the **[User Tools/Counter]** key.

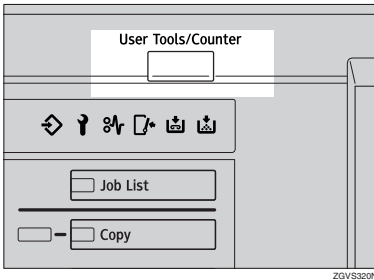

**2** Press **[System Settings]**.

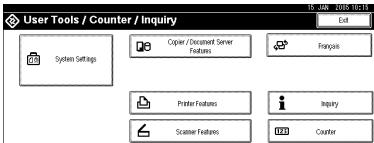

**3** Press **[Administrator Tools]**, and then press **[▼Next]**.

**4** Press **[Address Book Management]**.

**5** Press the name you want to register or enter the registered number using the number keys.

**6** Press **[Protection]**.

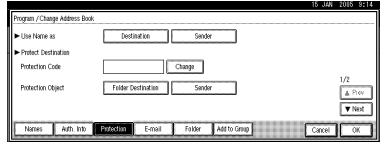

To use the registered name as the destination or sender

**1** Press **[Destination]** or **[Sender]** under Use Name as.

**Note**

- Both **[Destination]** and **[Sender]** can be selected at the same time.

To set the protection code

**1** Press **[Change]** under Protection Code.

**2** Enter a protection code using the number keys, and then press **[#]**.

**Note**

- You can enter up to eight digits.

To specify the object of protection

**1** Press **[Folder Destination]** or **[Sender]** under Protection Object.

**Note**

- Both **[Folder Destination]** and **[Sender]** can be selected at the same time.

- 7** Press [OK].
- 8** Press [Exit].
- 9** Press the [User Tools/Counter] key.

---

## Registering a Protection Code for a Group

---

- 1** Press the [User Tools/Counter] key.
- 2** Press [System Settings].
- 3** Press [Administrator Tools], and then press [▼Next].
- 4** Press [Address Book: Program/Change/Delete Group].
- 5** Press the group key you want to protect or enter the registered number using the number keys.
- 6** Press [Protection].

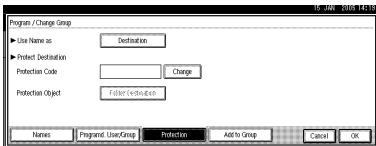

- 7** Press [Destination] under Use Name As.
- 8** Press [Change] under Protection Code.
- 9** Enter a protection code using the number keys, and then press [#].

 **Note**

- You can enter up to eight digits.

- 10** Press [Folder Destination] under Protection Object.
- 11** Press [OK].
- 12** Press [Exit].
- 13** Press the [User Tools/Counter] key.

# Registering LDAP Authentication

For each user registered in the Address Book, you can register a login user name and login password to be used when accessing an LDAP server.

## Reference

To use an LDAP server, you need to program it beforehand. For details, see *Network Guide*.

## Note

- When **[Do not Specify]** is selected for LDAP Authentication, the User Name and Password that you have specified in Program/Change LDAP Server of Administrator Tools settings applies. For details, see *Network Guide*.

---

## Registering LDAP Authentication

---

- 1** Press **[Administrator Tools]**, and then press **[▼Next]**.
- 2** Press **[Address Book Management]**.
- 3** Press the name you want to register or enter the registered number using the number keys.
  -  **Note**
    - To register a name in the Address Book, see p.69 "Registering a Name".
- 4** Press **[Auth. Info]**, and then press **[▼Next]**.
- 5** Press **[Specify Other Auth. Info]** on the right side of LDAP Authentication.
- 6** Press **[Change]** under Login User Name.

- 7** Enter the login user name, and then press **[OK]**.

## Reference

p.133 "Entering Text"

- 8** Press **[Change]** under Login Password.

- 9** Enter the password, and then press **[OK]**.

## Note

- You can enter up to 128 characters for the password.

- 10** Press **[OK]**.

---

## Changing LDAP Authentication

---

- 1** Press **[Administrator Tools]**, and then press **[▼Next]**.

- 2** Press **[Address Book Management]**.

- 3** Press the name you want to change or enter the registered number using the number keys.

## Note

- To register a name in the Address Book, see p.69 "Registering a Name".

- 4** Press **[Auth. Info]**, and then press **[▼Next]**.

- 5** Press **[Specify Other Auth. Info]** on the right side of LDAP Authentication.

- 6** Press **[Change]** under Login User Name.

- 7** Enter the new login user name, and then press **[OK]**.

 **Note**

- If you press , you can search by the registered name, user code, folder name or e-mail address.

**8** Press **[Change]** under **Login Password**.

**9** Enter the new password, and then press **[OK]**.

 **Note**

- You can enter up to 128 characters for the password.

**10** Press **[OK]**.



# 5. Troubleshooting

## If Your Machine Does Not Operate as You Want

### General

Machine Status	Problem/Cause	Action
"Please wait." is displayed.	This message appears when you turn on the operation switch or change the toner bottle.	Wait until the machine is ready.
The display panel is off.	The screen contrast knob is turned to the dark position.	Set the screen contrast knob to the light position so that the display panel can be seen properly.
	The machine is in Energy Saver mode.	Press the <b>[Energy Saver]</b> key to cancel Low Power mode.
	The operation switch is turned off.	Turn on the operation switch.
Nothing happens when the operation switch is turned on.	The main power switch is turned off.	Turn on the main power switch.
Memory is full.	The number of scanned pages exceeds the capacity of the hard disk.	Press <b>[Delete File]</b> to delete unnecessary documents.
The function status indicator is red.	The function associated with the red indicator has been interrupted.	Press the function key corresponding to the indicator. Follow the instructions displayed in the display panel.
The main power indicator continues blinking and does not turn off when pressed.	This occurs in the following cases: <ul style="list-style-type: none"><li>• The machine is in communication with external equipment.</li><li>• The hard disk is in operation.</li></ul>	Check that the computer does not control the machine when you turn off the main power switch.
The original images are printed on the reverse side of the paper.	You may have loaded the paper incorrectly.	Load paper into the large capacity tray (LCT) and a bypass tray with the print side up, or into a paper tray with the print side down. See p.96 "  Loading Paper".

Machine Status	Problem/Cause	Action
Misfeeds occur frequently.	The side guides of the paper tray may not be locked.	Check the side guides are locked. See p.113 "Changing the Paper Size".
	The end guide of the paper tray may not be locked.	Check that the end guide is locked. See p.113 "Changing the Paper Size".
	You may have loaded paper whose size cannot be detected automatically.	When you use paper of a size that cannot be detected automatically, set the paper size. See p.56 "Tray Paper Size: (Tray 2,3)", p.153 "Copy Paper".
	The saddle stitching staple cartridge for the Booklet Finisher has been removed.	Reset the saddle stitching staple cartridge. See p.115 "Adding Staples".
An error message remains, even after the misfed paper is removed.	When a misfeed message appears, it remains until you open and close the cover, as required.	Clear misfed paper and open and close the front cover. ⇒ p.103 "Clearing Misfeeds"
Cannot duplex print	You cannot use the paper in the bypass tray for duplex printing.	For duplex printing, select Tray 1-3 in Copier mode or with the printer driver.
	The setting for the Paper Type: Tray 1-3 is "1 Side Copy".	Select "2 Sided Copy" for Paper Type: Tray 1-3. See p.56 "Paper Type: (Tray1-3, LCT)".
During saddle stitching, paper comes out open and not neatly stacked.	Depending on the type of paper, the paper may spring open after it is folded.	Select a paper type that does not spring back easily .
The user code entry display appears.	Users are restricted by user codes.	Enter the user code (up to 8-digits), and then press <b>[#]</b> .
The Authentication screen appears.	Basic Authentication, Windows Authentication, or LDAP Authentication is set.	Enter your login user name and user password. See p.23 "When the Authentication Screen is displayed".
"You do not have the privileges to use the following function(s)." is displayed.	The use of the function is restricted to authenticated users only.	Contact the administrator.
"You do not have the privileges to use the following function(s)." continues to be displayed even though you have entered a valid user code.	This user code is not allowed to use the function selected.	Press the <b>[Energy Saver]</b> key. Confirm that the display goes off, and then press the <b>[Energy Saver]</b> key again. The display will return to the user code entry display.

## Document Server

Problem	Action
“Exceeded max. number of pages per file.Do you want to store the scanned pages as 1 file?” appears.	<p>The number of scanned pages exceeds the capacity per file of the Document Server.</p> <p>If you want to store scanned originals as a file, press <b>[Yes]</b>. The originals are stored as a file in the Document Server.</p> <p>If you don't want scanned originals to be stored, press <b>[No]</b>. The scanning data will be cleared.</p>
You cannot find out what is stored in a file.	<p>Check the date or time column in the Document Server: Files display.</p> <p>Check the contents of the document by printing the first page of it. Press the desired document in the Document Server: Files display, and press <b>[Print 1st Page]</b> followed by the <b>[Start]</b> key.</p>
Memory becomes full frequently.	Press <b>[Delete File]</b> to delete selected documents, thereby increasing available memory.
You want to check print quality before making a large print run.	First print out one set using the <b>[Sample Copy]</b> key.
You want to store a document so it will not be deleted automatically.	<p>Select <b>[No]</b> for Auto Delete File, and then store the document in the Document Server. See p.64 “Auto Delete File”.</p> <p>If you later switch your selection to <b>[Yes]</b>, the change will apply only to documents stored after the change.</p>
“Cannot copy. Original is being scanned by other functions.” appears.	<p>The Copy function is in use. To cancel the job in process, first press <b>[Exit]</b>, and then press the <b>[Copy]</b> key. Next press the <b>[Clear/Stop]</b> key.</p> <p>When the message “[Stop] key was pressed.Stop printing?” appears, press <b>[Yes]</b>.</p>

# 📄 Loading Paper

**Note**

- ❑ You can change the paper size in tray 2 and 3. See p.113 “Changing the Paper Size”.

**Reference**

For details about paper types and sizes, see p.153 “Copy Paper”.

**Important**

- ❑ Do not stack paper higher than the limit mark inside the tray.

**Note**

- ❑ Shuffle the paper before loading.
- ❑ Straighten curled or warped paper before loading.

5

## Loading Paper in Tray 1 (Tandem Tray)

**Important**

- ❑ When paper on the right side in tray 1 runs out, paper on the left will automatically be shifted to the right. While the paper is being moved, a message will be displayed instructing you to wait. Do not pull out the tray.

**Note**

- ❑ You can load paper even while making copies from tray 1. During copying, you can pull out the left half of the tray.

- 1** Pull out the paper tray until it stops.

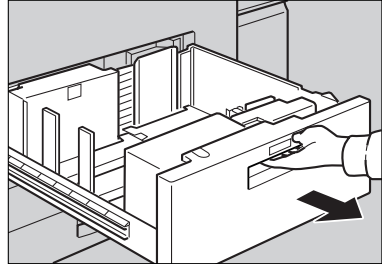

ZGVY301E

- 2** Square the paper, and then load it in the tray.

When the whole tray is pulled out

- 1** Load the paper.

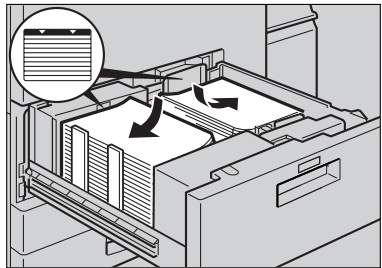

ZGVY311E

**Important**

- ❑ For the stack on the right, align the right edge of the copy paper to the right edge of the tray. For the stack on the left, align the left edge of the copy paper to the left edge of the tray.

When the left half of the tray is pulled out

- 1 Load the paper in the left tray.

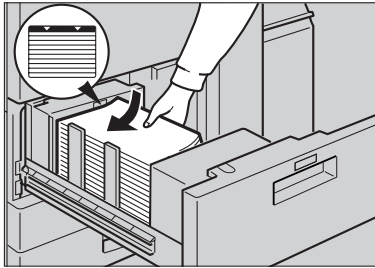

ZGVY321E

- 3 Gently push the paper tray in until it stops.

### Loading Paper in Tray 2 and 3

- 1 Pull out the paper tray until it stops.

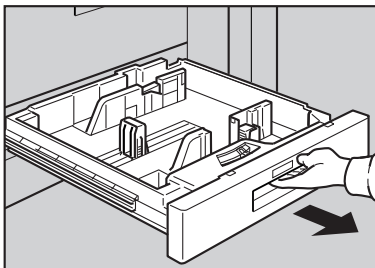

ZGVY331E

- 2 Square the paper, and then load it in the tray.

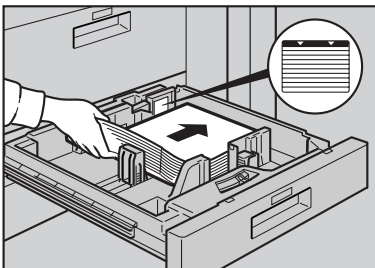

ZGVY341E

- 3 Gently push the paper tray in until it stops.

### Loading Paper in the Large Capacity Tray (LCT)

- 1 Open the top cover of the large capacity tray (LCT).

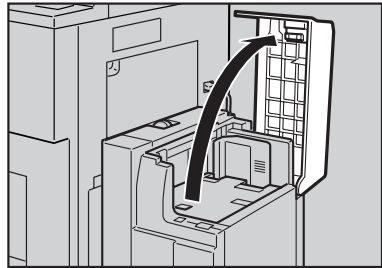

ZGVY371E

- 2 Load the paper in the tray along the edge on the left.

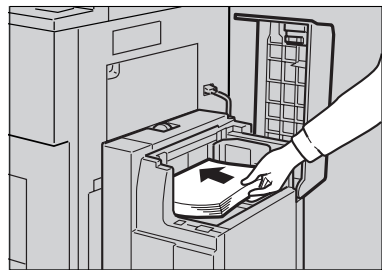

ZGVY382E

- 3 Press the [Down] key.

The key blinks while the bottom plate is moving down.

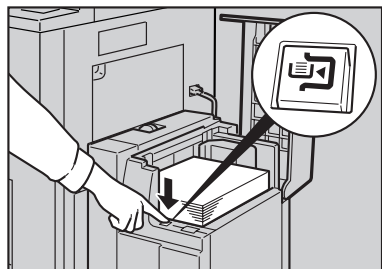

ZGVY391E

**4** Load paper by repeating steps **2** and **3**.

 **Note**

- The tray can hold up to 4,000 sheets.

**5** Close the top cover of the large capacity tray (LCT).

---

## Loading Paper in the Interposer

---

 **Important**

- Load paper on the side already printed (the side you want as front).
- Load paper in the interposer in the same orientation as paper in the paper tray.
- The staple or punching location will be on the left side of the paper, when you are facing the machine.
- Do not place anything on top of or leave documents on the sensor. This may lead to the paper size not being correctly scanned or paper jams.
- When using the Z-fold function, the paper in the interposer must be of the same size as the prints after they have been Z-folded. If the paper in the interposer is larger than the Z-folded sheets, a misfeed might occur.

**1** Load the paper.

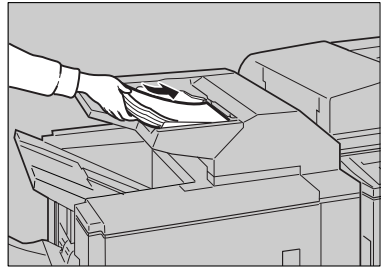

**2** Adjust the paper guides to the paper size.

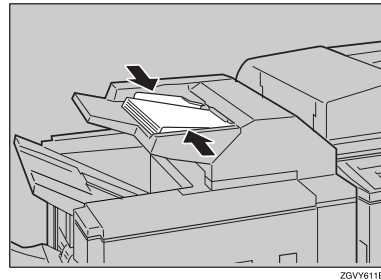

# Suspend Copy when using Finisher 3000B (100-Sheet Staples)

You can suspend a large volume of copies when using Finisher 3000B (100-Sheet Staples).

 **Note**

- You can suspend copy only when the output tray is specified as the finisher shift tray. See p.53 "Output: Copier".

**1** Press the **[Suspend/Resume]** key.

The key lights up.

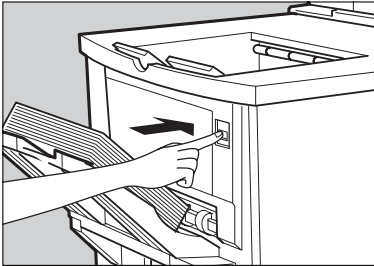

ZGVH670E

**2** Remove the stack of paper from the finisher shift tray.

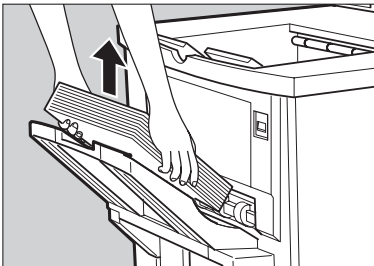

ZGVH680E

**3** Press the **[Start]** key.

The key turns off, and then copying restarts.

## Adding Toner

When  is displayed, it is time to add toner.

**⚠ WARNING:**

- ***Do not incinerate used toner or toner containers. Toner dust might ignite when exposed to an open flame. Dispose of used toner containers in accordance with local regulations.***

**⚠ CAUTION:**

- *Keep toner (used or unused) and toner containers out of reach of children.*

**⚠ CAUTION:**

- *If toner or used toner is inhaled, gargle with plenty of water and move into a fresh air environment. Consult a doctor if necessary.*

**⚠ CAUTION:**

- *If toner or used toner gets into your eyes, flush immediately with large amounts of water. Consult a doctor if necessary.*

**⚠ CAUTION:**

- *If toner or used toner is swallowed, dilute by drinking a large amount of water. Consult a doctor if necessary.*

**⚠ CAUTION:**

- *Avoid getting toner on your clothes or skin when removing a paper jam or replacing toner. If your skin comes into contact with toner, wash the affected area thoroughly with soap and water.*
- *If toner gets on your clothing, wash with cold water. Hot water will set the toner into the fabric and may make removing the stain impossible.*

**⚠ CAUTION:**



- *Our products are engineered to meet high standards of quality and functionality, and we recommend that you use only the expendable supplies available at an authorized dealer.*

** Important**

- If you use toner other than that recommended, an error might occur.
- When adding toner, do not turn off the operation switch. If you do, your settings will be cleared and  will appear again because the machine will not recognize that toner has been added.
- Always add toner after the machine instructs you.



 **Note**

- You can still make about 1000 copies after the messages “Toner is almost empty.” and “Replace Toner Bottle.” appear cyclically, but replace toner early to prevent poor copy quality.
- When the toner runs out, “ Add Toner” will be displayed on the screen and printing will be disabled.

 **Reference**

For details about toner storage, see p.126 “Toner Storage”.

# Replacing Toner

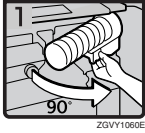

- Open the front cover of the machine.
- Pull out the lever under the toner bottle toward you 90°.

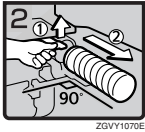

- Raise the green lever, and then gently pull out the toner bottle.



- Hold the new bottle horizontally, and then shake it five or six times without removing the outer cap.

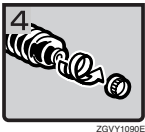

- Remove the outer cap.

 **Note**

- Do not remove the inner cap.

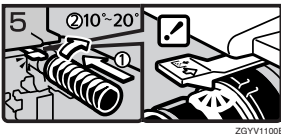

- Place the toner bottle in position, then push it in until the green lever clicks.

 **Note**

- If you cannot get it to click in, pull out the toner bottle a little, slightly rotate it to the right by 10 – 20°, then try again.

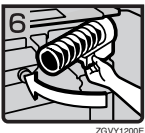

- Return the lever under the toner bottle to its original position.
- Close the front cover of the machine.

# Clearing Misfeeds

## CAUTION:

- *The fusing section of this machine might be very hot. Caution should be taken when removing misfed paper.*

## Important

- When clearing misfeeds, do not turn off the operation switch. If you do, your copy settings are cleared.
- To prevent misfeeds, do not leave any torn scraps of paper within the machine.
- If misfeeds occur repeatedly, contact your service representative.

## Note

- More than one misfeed location may be indicated. In such a case, check every applicable area. See the following charts:
  - A, B, C, D, E, F ⇒ p.104
  - P, Q, R(Finisher 3000M), U ⇒ p.106
  - R(Booklet Finisher), W ⇒ p.108
  - R(Finisher 3000B) ⇒ p.110
  - N(Z-folding unit) ⇒ p.111
- You can find a sticker explaining how to remove misfed paper inside the front cover or finisher.

**When D is lit**

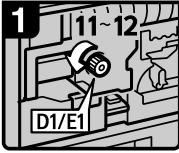

- Open the front cover.
- Turn fuser unit knob D1/E1 11-12 times counterclockwise to eject the paper.

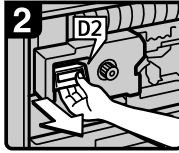

- Pull handle D2 and pull out the fuser unit.

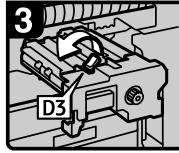

- Raise lever D3.

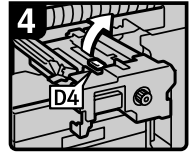

- Raise lever D4.

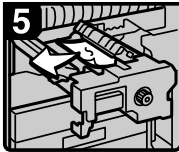

- Remove the paper being careful not to touch the area around lever D4.

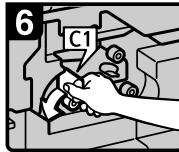

- Turn lever C1 to the left.

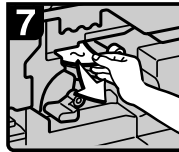

- Remove misfed paper.
- Return lever C1 to its original position.
- Close the front cover.

5

**When E is lit**

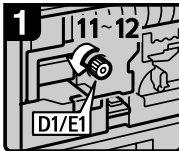

- Open the front cover.
- Turn fuser unit knob D1/E1 11-12 times counterclockwise to eject the paper.



- Pull handle E2 and fully pull out the duplex unit.

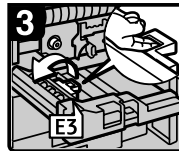

- Raise lever E3.

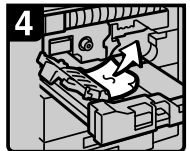

- Remove the paper being careful not to touch the area around lever E3.

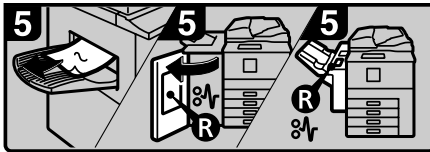

- Remove the paper from the output tray if it is visible. (When the finisher is installed, open the finisher front cover and remove misfed paper.)
- Close the front cover.

**When C is lit**

- Open the front cover.
  - Turn lever C1 to the left.
- Turn lever C2 counter-clockwise and remove misfed paper.
  - Close the front cover.

**When B is lit**

- Open the front cover.
  - Turn knob B1 counter-clockwise and remove misfed paper.
- Return lever B2 to its original position.
  - Close the front cover.

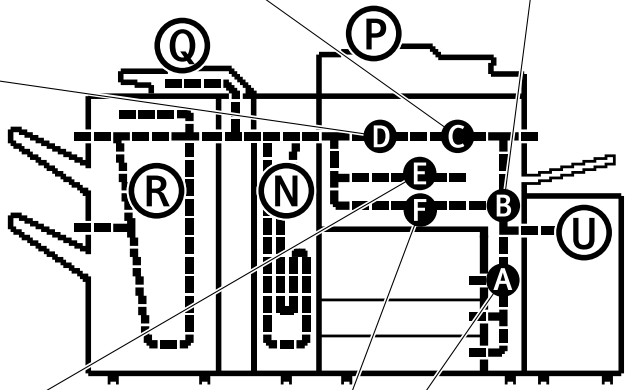

**When A is lit**

- Open the front cover.
  - Push button A and open the guide plate.
- Remove misfed paper.
  - Close the front cover.

**When F is lit**

- Open the front cover.
  - Pull handle E2 and fully pull out the duplex unit.
- Lower lever F while pressing it.
- Remove misfed paper.
  - Return lever F to its original position.
  - Close the front cover.

ADH0065

**When Q is lit**

**Interposer**

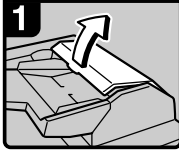

- Open the interposer upper cover.

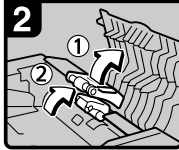

- Raise the feed roller.

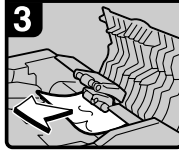

- Remove misfed paper.
- Close the interposer upper cover.

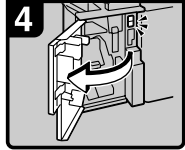

- Open the finisher front cover.

**When R is lit**

**Finisher 3000M (50-Sheet Staples)**

When R1, R2 or R3 is lit

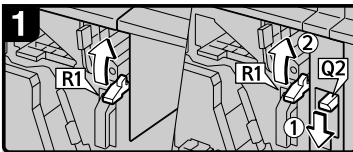

- Open the front cover.
  - Raise lever R1.
- When the optional interposer is installed, lower lever Q2, and then raise lever R1.

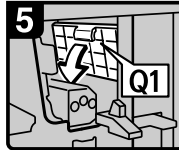

- Lower lever Q1.



- Remove misfed paper.
- Close the finisher front cover.

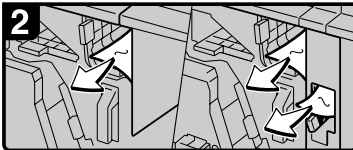

- Remove misfed paper.

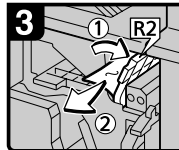

- If you cannot remove misfed paper, raise lever R2 and remove it.

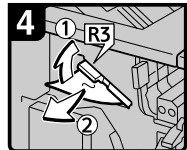

- Raise lever R3 and remove misfed paper.
- Close the front cover.

When R4, R5, R6 or R7 is lit

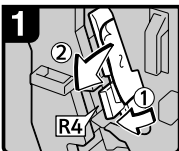

- Open the front cover.
- Lower lever R4 and remove misfed paper.

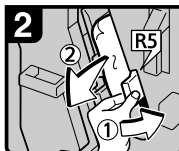

- If you cannot remove misfed paper, lower lever R5 and remove it.

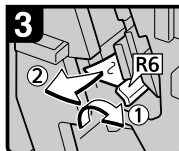

- If you cannot remove misfed paper, raise lever R6 and remove it.

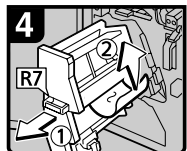

- Pull handle R7 and pull out the staple unit, then remove misfed paper.
- Close the front cover.

**When P<sub>1</sub> is lit**

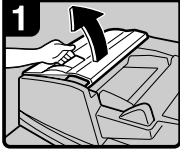

- Open the document feeder cover.



- Raise the feed roller.

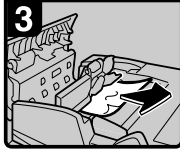

- Remove misfed originals.
- Close the document feeder cover.

**When P<sub>2</sub> is lit**

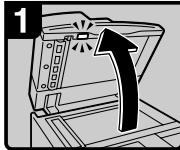

- Lift the document feeder.

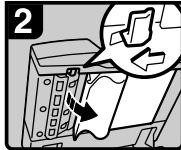

- Slide the lever and open the cover.

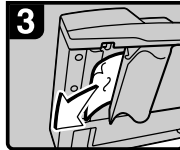

- Remove misfed originals.
- Close the cover.

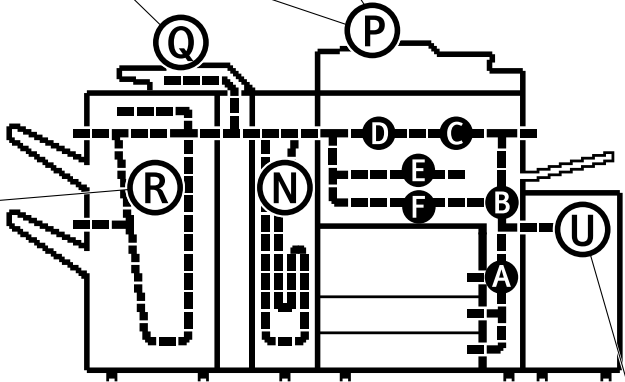

**When U is lit**



- Open the top cover and remove misfed paper.
- Close the top cover.

ADH007S

**When R is lit**

**Booklet Finisher**

When R1, R2 or R3 is lit

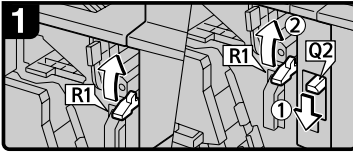

- Open the front cover.
  - Raise lever R1.
- When the optional interposer is installed, lower lever Q2, and then raise lever R1.

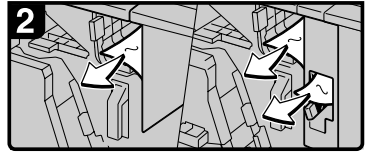

- Remove misfed paper.

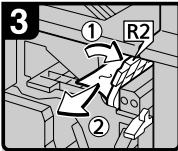

- If you cannot remove misfed paper, raise lever R2 and remove it.

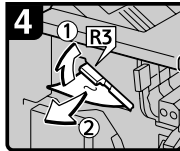

- Raise lever R3 and remove misfed paper.
- Close the front cover.

When R4, R5 or R6 is lit

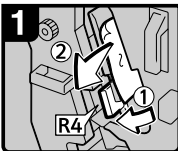

- Open the front cover.
- Lower lever R4 and remove misfed paper.

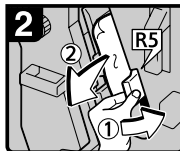

- If you cannot remove misfed paper, lower lever R5 and remove it.

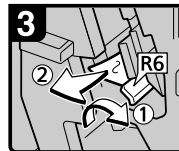

- If you cannot remove misfed paper, raise lever R6 and remove it.

When R7, R8 or R9 is lit

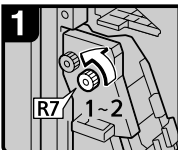

- Turn knob R7 counter-clockwise.

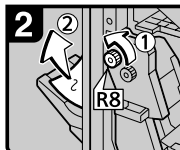

- Turn knob R8 counter-clockwise and remove misfed papers.

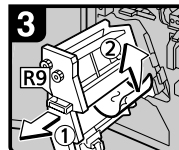

- Pull handle R9 and pull out the staple unit, then remove misfed paper.
- Close the front cover.



**When W is lit**

**Mailbox**

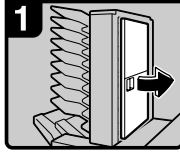

- Open the mailbox right cover.



- Remove misfed paper.

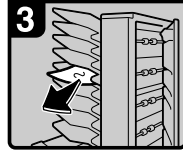

- Remove misfed paper.
- Close the mailbox right cover.

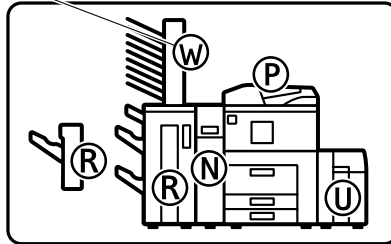

5

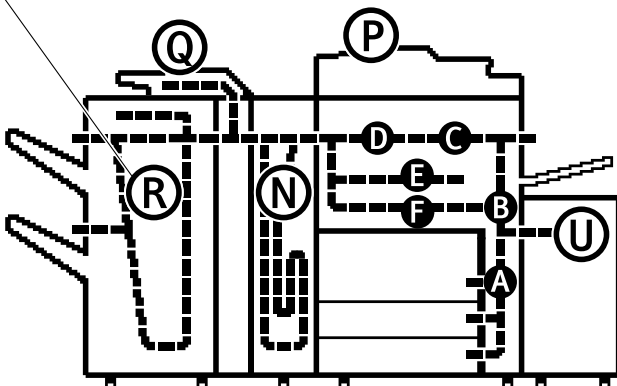

ADH0085

### When R is lit

#### Finisher 3000B (100-Sheet Staples)

When R1, R2 or R3 is lit

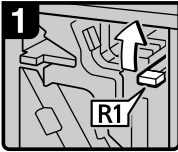

- Open the front cover.
- Raise lever R1.

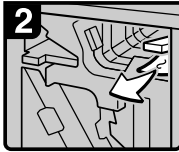

- Remove misfed paper.

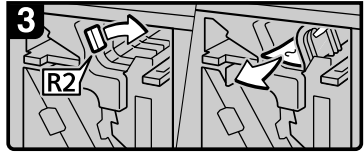

- If you cannot remove misfed paper, turn lever R2 to the right and remove it.

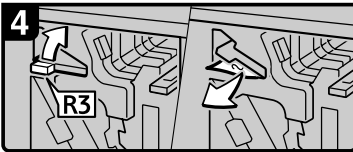

- If you cannot remove misfed paper, raise lever R3 and remove it.

When R4 or R5 is lit



- Open the front cover.
- Pull lever R4 and remove misfed paper.



- If you cannot remove misfed paper, pull lever R5 and remove it.

When R6 or R7 is lit

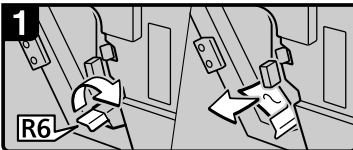

- If you cannot remove misfed paper, raise lever R6 and remove it.

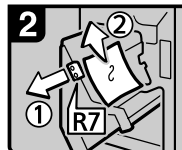

- Pull handle R7 and pull out the staple unit, then remove misfed paper.
- Close the front cover.

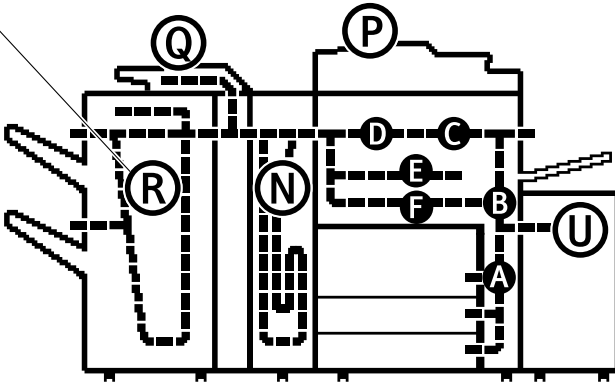

ADH0095

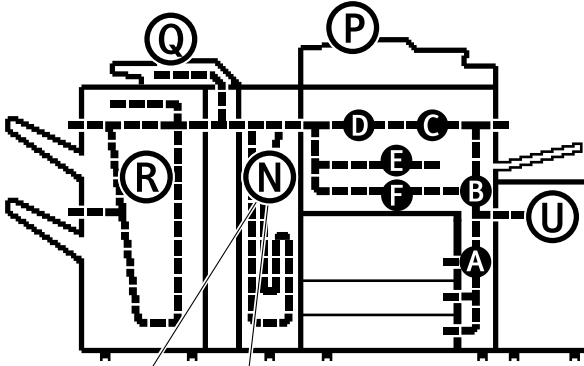

**When N1 is lit**

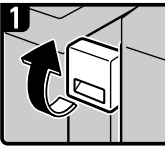

1. Open the front cover.

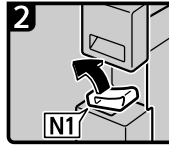

2. Lift the N1 lever.

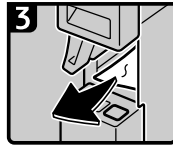

3. Remove misfed paper.  
4. Lower the N1 lever.  
5. Close the front cover.

**When N2 or N3 is lit**

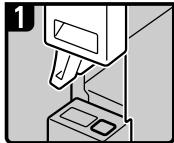

1. Open the front cover.  
Lift the N1 lever.

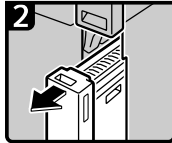

2. Pull out the Z-folding unit.

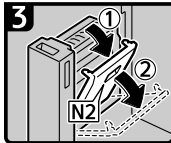

3. Open the N2 cover.

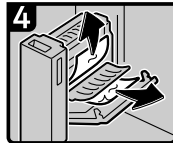

4. Remove misfed paper.  
Close the N2 cover.

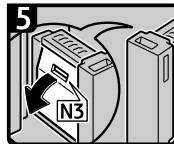

5. If you cannot remove the misfed paper, open the N3 cover.

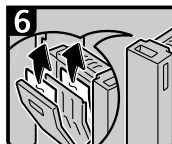

6. Remove misfed paper.  
Close the N3 cover.

7. Return the Z-folding unit to its original position.  
8. Lower the N1 lever.  
9. Close the front cover.

ADH0105

# Changing the Paper Size

## Preparation

Always select the paper size with User Tools. Otherwise, misfeeds might occur.

## Reference

For details about paper sizes, and types see p.153 "Copy Paper".

## Important

- If you wish to change the paper size set in the paper tray 1 or the optional large capacity tray (LCT), contact your service representative.
- Do not stack paper higher than the limit mark inside the tray.

## Note

- Shuffle the paper before loading.
- Straighten curled or warped paper before loading.

## Changing the Paper Size in Tray 2 or 3

- 1** Make sure the paper tray is not being used. Then fully pull out the paper tray.

Remove the paper in the tray.

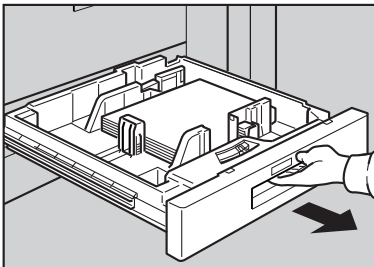

ZGVY401E

- 2** Press the lock button. Adjust the side fences and back fence to the new paper size while pushing the release lever.

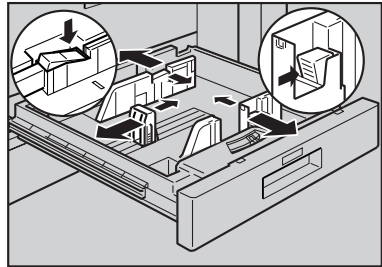

ZGVY411E

- 3** Square the paper and load it in the paper tray. Press the lock button.

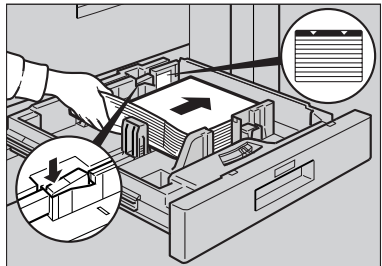

ZGVY421E

- 4** Set the paper size selector knob inside the tray to the new size.

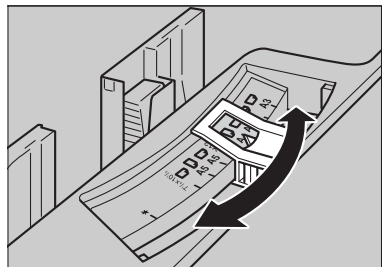

ZGVY431E

**❗ Important**

- ❑ If the size of the paper set does not match the paper size selector, misfeeds might occur, or parts of the image might not be copied.

---

To adjust the paper size to one not available on the paper size selector

---

- ❶ Set the paper size selector knob to the **✖** mark on the left.
- ❷ Press the **【User Tools/Counter】** key.
- ❸ Press **[System Settings]**.
- ❹ Press **[Tray Paper Settings]**.
- ❺ Press **[Tray Paper Size: ]**.
- ❻ Select the size, and then press **[OK]**.
- ❼ Press **[Exit]** or press the **【User Tools/Counter】** key to exit the User Tools.

**🔍 Reference**

For details, see p.55 “Tray Paper Settings”.

- ❺ Gently push the paper tray until it stops.
- ❻ Check the paper size displayed on the display panel.

# Adding Staples

## Note

- When removing jammed staples, staples might not be ejected the first few times you try to use the stapler.

## Important

- If you use a staple cartridge other than that recommended, staple failure or staple jams might occur.
- A paper jam will occur if the machine staples using the Booklet Finisher without the saddle stitch stapler cartridge. Make sure the cartridge is set.

## Reference

For details about the type of finisher, see p.19 “External Options”.

## Finisher 3000M (50-Sheet Staples), Booklet Finisher

5

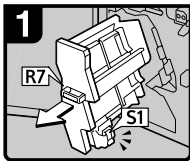

1. Open the finisher front cover.
2. Pull out the staple unit.

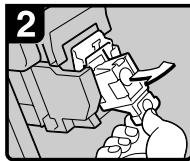

3. Pull out the cartridge gently.

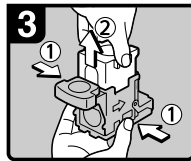

4. Holding both sides of the cartridge, pull up the upper unit.

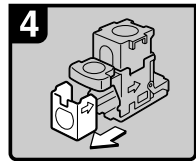

5. Remove the empty refill in the direction of the arrow.

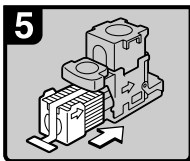

6. Push the new refill into the cartridge until it clicks.

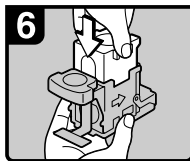

7. Push the upper unit gently into the cartridge.

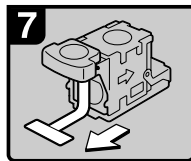

8. Pull out the ribbon.

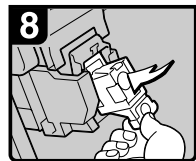

9. Push the cartridge down until it clicks.

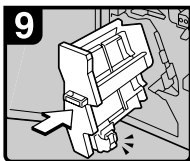

10. Return the staple unit to its original position.
11. Close the finisher front cover.

## Booklet Finisher (Saddle Stitch)

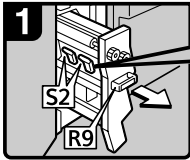

1. Open the finisher front cover.
2. Pull out the staple unit.

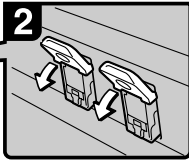

3. Pull lever S2.

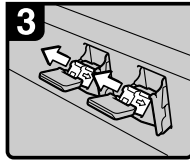

4. Pull out the cartridge gently.

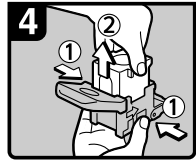

5. Holding both sides of the cartridge, pull up the upper unit.

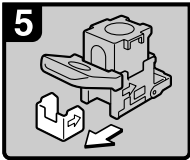

6. Remove the empty refill in the direction of the arrow.

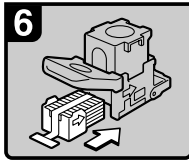

7. Push the new refill into the cartridge until it clicks.

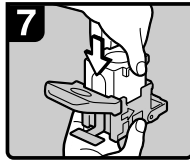

8. Push the upper unit gently into the cartridge.

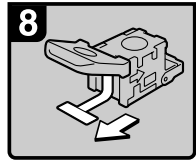

9. Pull out the ribbon.

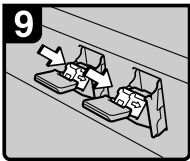

10. Push the cartridge down until it clicks.

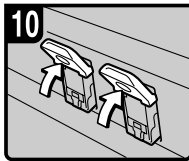

11. Return lever S2 to its original position.

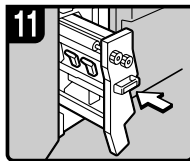

12. Return the staple unit to its original position.
13. Close the finisher front cover.

ADH012S



## Finisher 3000B (100-Sheet Staples)

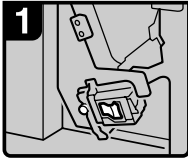

1. Open the finisher front cover.

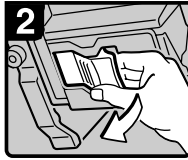

2. Pull out the cartridge lever.

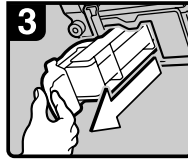

3. Pull out the cartridge gently.

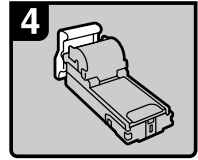

4. Put the cartridge down on a level surface.

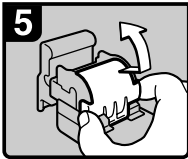

5. Raise the cover up.

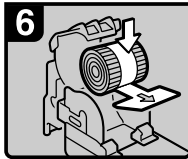

6. Set the new refill.

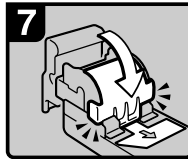

7. Lower the cover until it clicks.

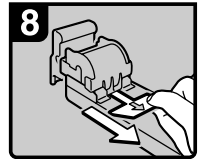

8. Pull out the ribbon.

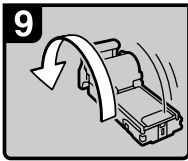

9. Turn the cartridge around.

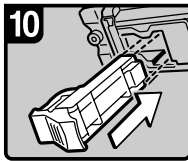

10. Re-set the cartridge.

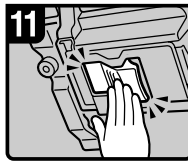

11. Push the cartridge in until it clicks.



12. Close the finisher front cover.

5

ADH013S

# 🔧 Removing Jammed Staples

## 🚨 Important

- ❑ A paper jam will occur if the machine staples using the Booklet Finisher without the saddle stitch stapler cartridge. Make sure the cartridge is set.

## 📝 Note

- ❑ Staples might jam due to curled copy paper. In this case, try turning the paper over in the tray. If there is no improvement, change to paper with less curl.
- ❑ When removing jammed staples, staples might not be ejected the first few times you try to use the stapler.

## 🔍 Reference

For details about the type of finisher, see p.19 “External Options”.

5

## Finisher 3000M (50-Sheet Staples), Booklet Finisher

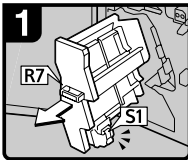

1. Open the finisher front cover.
2. Pull out the staple unit.

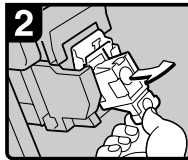

3. Pull out the cartridge gently.

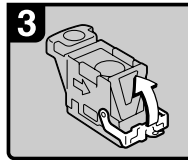

4. Open the face plate.

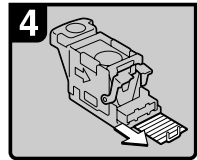

5. Remove the jammed staples.

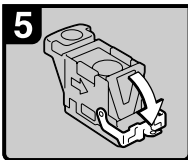

6. Pull down the face plate until it clicks.

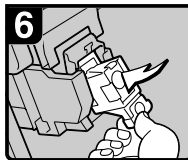

7. Pull down the cartridge until it clicks.

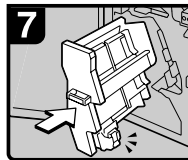

8. Return the staple unit to its original position.
9. Close the finisher front cover.

ADH014S

## Booklet Finisher (Saddle Stitch)

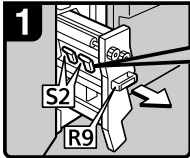

1. Open the finisher front cover.
2. Pull out the staple unit.

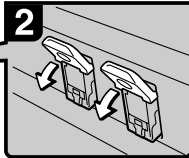

3. Pull lever S2.

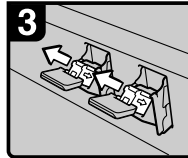

4. Pull out the cartridge gently.

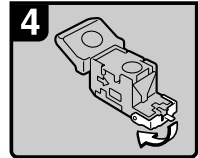

5. Open the face plate of the cartridge.

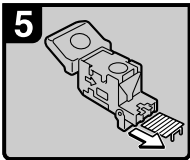

6. Remove the jammed staples.

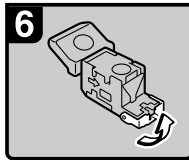

7. Pull the face plate down until it clicks.

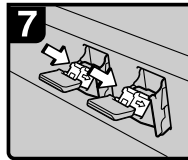

8. Push the cartridge down until it clicks.

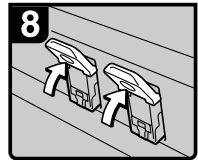

9. Return lever S2 to its original position.

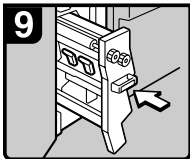

10. Return the staple unit to its original position.
11. Close the finisher front cover.

## Finisher 3000B (100-Sheet Staples)

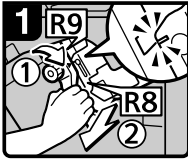

1. Open the finisher front cover.  
Turn knob R9 until the marks are aligned.  
2. Pull lever R8 and remove the staple unit.

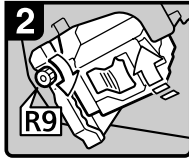

2. Turn knob R9 to rotate the staple unit.

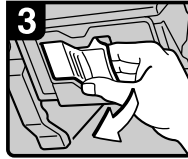

3. Pull the cartridge lever.

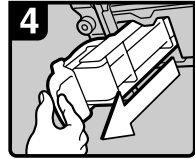

4. Pull out the cartridge.

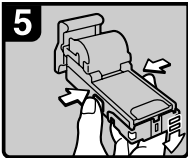

5. Push the buttons on both sides of the cartridge and open the face plate.

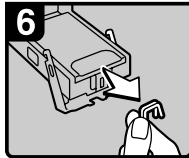

6. Remove the jammed staples.

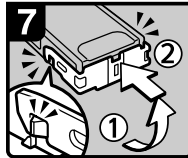

7. Pull the face plate down until it clicks.

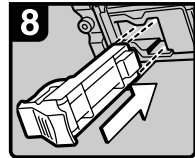

8. Re-set the cartridge.

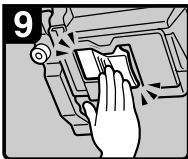

9. Push the cartridge down until it clicks.

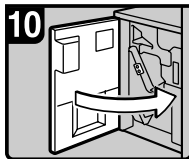

10. Close the finisher front cover.

5

ADH016S

# Removing Punch Waste

**Note**

- When "Hole Punch Receptacle is full." is displayed, you cannot use the Punch function.

## Finisher 3000M (50-Sheet Staples), Booklet Finisher

- 1 Open the finisher front cover.

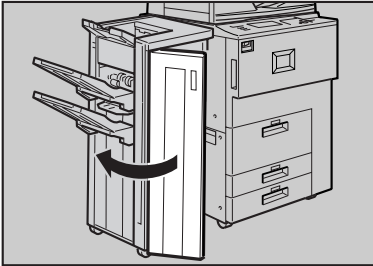

ZGVH400E

- 2 Pull out the punch waste box, and then remove punch waste.

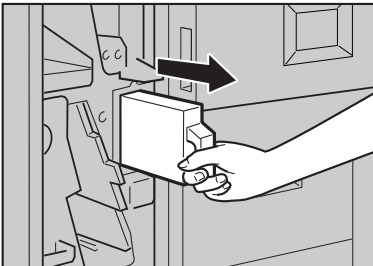

ZGVH410E

- 3 Reinstall the punch waste box.

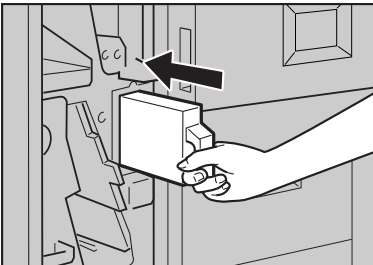

ZGVH420E

 **Note**

If you do not, "Hole Punch Receptacle is full." is still displayed.

**4** Close the front cover of the finisher.

"Hole Punch Receptacle is full." disappears.

 **Note**

If the message is still displayed, reinstall the punch waste box.

---

## Finisher 3000B (100-Sheet Staples)

---

**1** Open the finisher front cover.

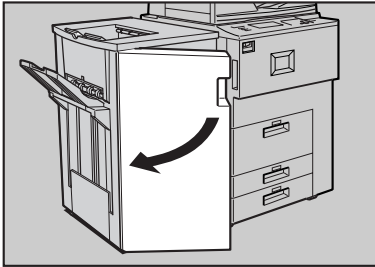

ZGVH600E

**2** Pull out the punch waste box, and then remove punch waste.

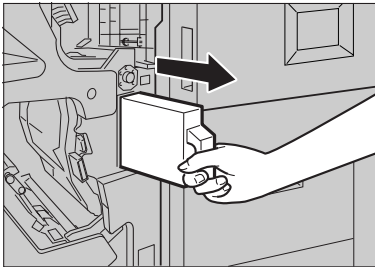

ZGVH610E

**3** Reinstall the punch waste box.

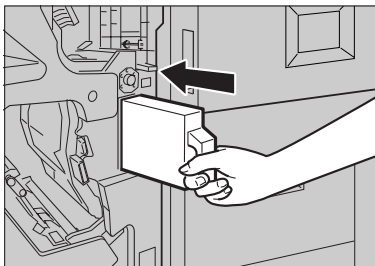

ZGVH620E

 **Note**

If you do not, "Hole Punch Receptacle is full." is still displayed.

**4** **Close the front cover of the finisher.**

"Hole Punch Receptacle is full." disappears.

 **Note**

If the message is still displayed, reinstall the punch waste box.





## Dos And Don'ts

### **WARNING:**

- **Keep the machine away from flammable liquids, gases, and aerosols. A fire or an electric shock might occur.**

### **CAUTION:**

- *Unplug the power cord from the wall outlet before you move the machine. While moving the machine, you should take care that the power cord will not be damaged under the machine.*

- Do not turn off the main power switch while the **On** indicator is lit or blinking. This may cause damage to the hard disk or memory.
  - Do not touch areas on or around the fusing unit. These areas get hot.
  - After scanning originals continuously, the exposure glass may become warm—this is not a malfunction.
  - When you use this machine for a long time in a confined space without good ventilation, you may detect an odd smell. To keep the workplace comfortable, we recommend that you keep it well ventilated.
  - The area around the ventilation hole may become warm. This is caused by exhaust air and is not a malfunction.
  - Do not turn off the power when the machine is in operation.
  - The machine might fail to produce good copy images if condensation forms inside due to rapid temperature change.
- Do not open the covers of the machine when it is in operation. If you do, misfeeds might occur.
  - Do not move the machine when the power is on.
  - If you operate the machine improperly or a failure occurs, settings might be lost. Be sure to make a note of your machine settings.
  - The supplier shall not be liable for any loss or damage resulting from a failure of the machine, loss of settings, or use of the machine.

# Toner

---

## Handling Toner

---

 **WARNING:**

- ***Do not incinerate used toner or toner containers. Toner dust might ignite when exposed to an open flame. Dispose of used toner containers in accordance with local regulations.***

 **CAUTION:**

- *Keep toner (used or unused) and toner containers out of reach of children.*

 **CAUTION:**

- *Our products are engineered to meet high standards of quality and functionality, and we recommend that you use only the expendable supplies available at an authorized dealer.*

 **Important**

- If you use toner other than the recommended type, an error might occur.

 **Reference**

To add toner, see p.100 " Adding Toner".

---

## Toner Storage

---

When storing toner, the following precautions should always be followed:

- Store toner containers in a cool, dry place free from direct sunlight.
- Store on a flat surface.
- Store toner containers laid down.

---

## Used Toner

---

 **Note**

- Toner cannot be re-used.

# Where to Put Your Machine

## Machine Environment

Your machine's location should be carefully chosen because environmental conditions greatly affect its performance.

### Optimum environmental conditions

#### CAUTION:

- *Keep the machine away from humidity and dust. Otherwise a fire or an electric shock might occur.*
- *Do not place the machine on an unstable or tilted surface. If it topples over, an injury might occur.*

#### CAUTION:

- *If you use the machine in a confined space, make sure there is a continuous air turnover.*

- Temperature: 10 – 32°C (50 – 89.6°F) (humidity to be 54% at 32°C, 89.6°F)
- Humidity: 15 – 80% (temperature to be 27°C, 80.6°F at 80%)
- A strong and level base.
- The machine must be level within 5 mm, 0.2" both front to rear and left to right.
- To avoid possible buildup of ozone, be sure to locate this machine in a large well ventilated room that has an air turnover of more than 30 m<sup>3</sup>/hr/person.

## Environments to avoid

- Locations exposed to direct sunlight or strong light (more than 1,500 lux).
- Locations directly exposed to cool air from an air conditioner or heated air from a heater. (Sudden temperature changes might cause condensation within the machine.)
- Locations close to machines generating ammonia such as a diazo copy machine.
- Places where the machine might be subjected to frequent strong vibration.
- Dusty areas.
- Areas with corrosive gases.

6

## Moving

#### CAUTION:

- *Unplug the power cord from the wall outlet before you move the machine. While moving the machine, you should take care that the power cord will not be damaged under the machine.*

#### Important

- When moving the machine, the following precautions should always be followed:
  - Turn off the main power. See p.26 "Turning Off the Main Power".
  - Unplug the power cord from the wall outlet. When you do, grip the plug to avoid damaging the cord and causing fire or electric shock.

- Close all covers and trays including the front cover and bypass tray.

### ⚠ **Limitation**

- Carefully move the machine. If you do not, the machine might be damaged or a stored file might be deleted.
- Avoid any strong shock to the machine. This could damage the hard disk and cause stored files to be deleted. For precautionary reasons, files should be copied to another local computer.

## Power Connection

### ⚠ **WARNING:**

- **Connect the machine only to the power source described on the inside front cover of this manual. Connect the power cord directly into a wall outlet and do not use an extension cord.**
- **Do not damage, break or make any modifications to the power cord. Do not place heavy objects on it. Do not pull it hard nor bend it more than necessary. These actions could cause an electric shock or fire.**

### ⚠ **CAUTION:**

- **Unplug the power cord from the wall outlet before you move the machine. While moving the machine, you should take care that the power cord will not be damaged under the machine.**

### ⚠ **CAUTION:**

- **When you disconnect the power plug from the wall outlet, always pull the plug (not the cable).**

- When the main power switch is in the stand-by position, the optional anti-condensation heaters are on. In case of emergency, unplug the machine's power cord.
- When you unplug the power cord, the anti-condensation heaters turn off.
- Make sure that the plug is firmly inserted in the outlet.
- Voltage must not fluctuate more than 10%.
- The socket-outlet should be installed near the equipment and should be easily accessible.

## Access to the Machine

Place the machine near the power source, providing clearance as shown.

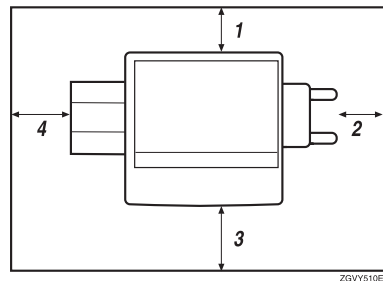

1. **Rear:** more than 5 cm (2")
2. **Right:** more than 4 cm (1.6")
3. **Front:** more than 70 cm (27.5")
4. **Left:** more than 5 cm (2")

### 🔧 **Note**

- For required space when options are installed, contact your service representative.

# Maintaining Your Machine

If the exposure glass or ADF is dirty, you might not be able to make clear copies. Clean these parts when you find them dirty.

## ❖ Cleaning the machine

Wipe the machine with a soft, damp cloth. Then, wipe it with a dry cloth to remove the water.

## ⚠ Important

- ❑ Do not use chemical cleaner or organic solvents, such as thinner or benzene. If they get into the machine or melt plastic parts, a failure might occur.
- ❑ Do not clean parts other than those specified in this manual. Such parts should be cleaned by your service representative.

## Cleaning the Exposure Glass

**1**



ZGUH431J

Clean 1 and 2.

## Cleaning the Auto Document Feeder

**1** Clean the white sheet of the ADF.

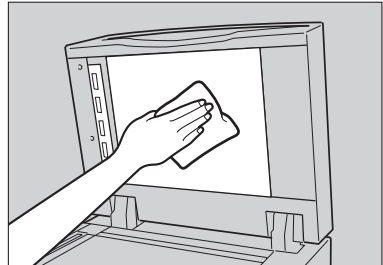

ACC028S

**2** Pull the lever.

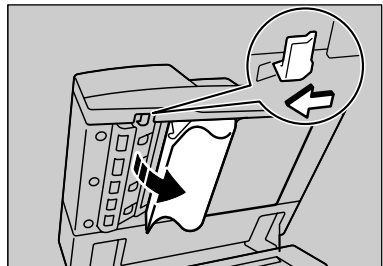

ZGUH700J

**3** Wipe the scanning glass.

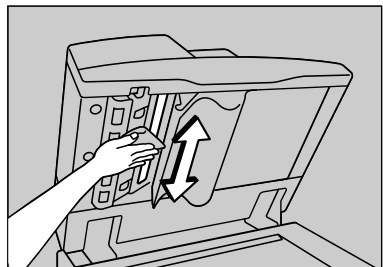

ZGUH710J

6

# Other Functions

## Inquiry

The inquiry functions lets you confirm the telephone numbers to contact for repairs or to order toner. Be sure to contact your service engineer to verify the following:

- ❖ **Machine Maintenance/Repair**
  - Telephone No.
  - Serial No. of Machine
- ❖ **Sales Representative**
  - Telephone No.

**1** Press the **[User Tools/Counter]** key.

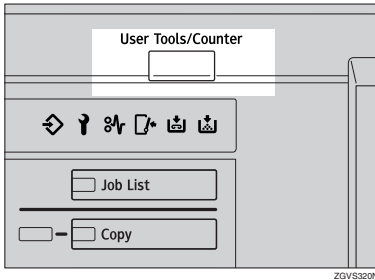

ZGV5320N

**2** Press **[Inquiry]**.

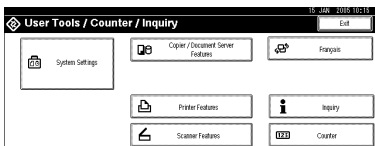

Inquiry information is displayed.

Printing inquiry information

**1** Press **[Print Inquiry List]**.

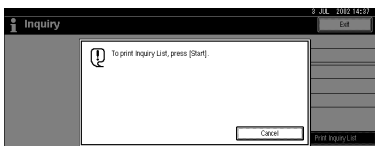

**2** Press the **[Start]** key.

Inquiry information is printed.

**3** Press **[Exit]**.

**4** Press **[Exit]**.

## Changing the Display Language

You can change the language used on the display. English is set as default setting.

**1** Press the **[User Tools/Counter]** key.

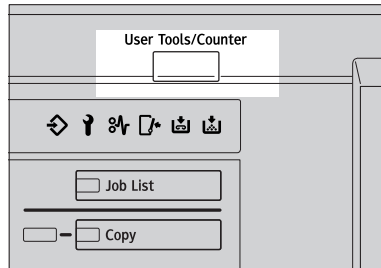

ZGV5320N

**2** Press **[Français]**.

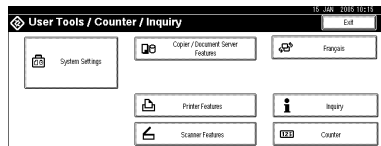

The display language is changed to French.

**3** Press **[Exit]**.

The menu appears in French.

**Note**

- If you want to return the display language to “English”, repeat step **1** and press **[English]**.

# Counter

## Displaying the Total Counter

You can display the total number of sheets used for all functions and the total number of sheets used for copying.

You can also print the counter list.

**1** Press the **[User Tools/Counter]** key.

**2** Press **[Counter]**.

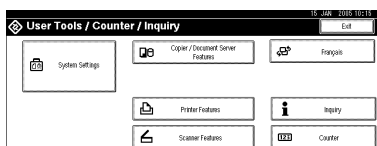

**3** To print a counter list, press **[Print Counter List]**.

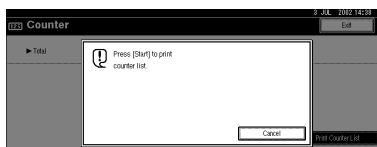

**4** Press the **[Start]** key.

A counter list is printed.





# 7. Entering Text

## Entering Text

This section describes how to enter characters. When you enter a character, it is shown at the position of the cursor. If there is a character at the cursor position, the entered character is shown before that character.

---

### Available Characters

---

- Alphabetic characters  
ABCDEFGHIJKLMNOPQRSTUVWXYZabcdefghijklmnopqrstuvwxyz
- Symbols
- Numerals  
0123456789

---

### Keys

---

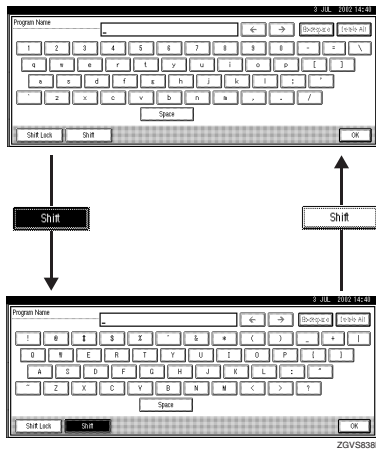

### Note

- When entering uppercase or lowercase letters continuously, use **[Shift Lock]** to lock the case.

---

## Entering Text

---

---

### Entering letters

---

- 1** Press [Shift] to switch between uppercase and lowercase.
  - 2** Press the letters you want to enter.
- 

### Deleting characters

---





















- 1** Press [Backspace] or [Delete All] to delete characters.

# 8. Specifications

## Main Unit

- ❖ **Configuration:**  
Console
- ❖ **Photosensitivity type:**  
OPC drum
- ❖ **Original scanning:**  
CCD-CIS
- ❖ **Copy process:**  
Dry electrostatic transfer system
- ❖ **Development:**  
Dry two-component magnetic brush development system
- ❖ **Fusing:**  
Heating roll pressure system
- ❖ **Resolution:**
  - Scanning originals: 600 dpi
  - Printing: 1200 dpi
- ❖ **Exposure glass:**  
Stationary original exposure type
- ❖ **Original reference position:**  
Rear left corner
- ❖ **Warm-up time:**  
30 seconds or less (23°C, 73°F)
- ❖ **Originals:**  
Sheet/book/objects
- ❖ **Maximum original size:**  
A3☐, 11" × 17"☐, Long length: 1260 mm
- ❖ **Minimum original size:**  
B6 JIS, 5<sup>1</sup>/<sub>2</sub>" × 8<sup>1</sup>/<sub>2</sub>" (when using the ADF)

### ❖ Copy paper size:

- Trays: A3  – A5  , 11" × 17"  – 5<sup>1</sup>/<sub>2</sub>" × 8<sup>1</sup>/<sub>2</sub>"  , 8K (267 × 390 mm) , 16K (195 × 267 mm)  
- Bypass Tray: A3  – A6 , 11" × 17"  – 5<sup>1</sup>/<sub>2</sub>" × 8<sup>1</sup>/<sub>2</sub>"  
- Bypass (custom size):  
Vertical: 100 – 305 mm, 4" – 12"  
Horizontal: 139.7 – 600 mm, 5.5" – 23.6"
- Duplex: A3  – A5  , 11" × 17"  – 5<sup>1</sup>/<sub>2</sub>" × 8<sup>1</sup>/<sub>2</sub>"  



### ❖ Copy paper weight:

- Paper tray: 52.3 – 127.9 g/m<sup>2</sup>, 14 – 34 lb.
- Bypass tray: 52.3 – 105 g/m<sup>2</sup>, 14 – 28 lb.  
105 – 216 g/m<sup>2</sup>, 28 – 57.6 lb. (Thick Paper mode)
- Duplex: 64 – 127.9 g/m<sup>2</sup>, 17 – 34 lb.





### ❖ Non-reproduction area:

- Leading edge: 4 ± 2 mm
- Trailing edge: 1 mm
- Left edge: 2 ± 1.5 mm
- Right edge: 0.5 mm





### ❖ First copy time:

- Types 1, 2: 4.2 seconds or less
- Type 3: 3.5 seconds or less  
(A4 , 8<sup>1</sup>/<sub>2</sub>" × 11" , 100% reproduction, feeding from tray 1, on the exposure glass)





### ❖ Copying speed: (Type 1)

- 30 copies/minute (A3 , 11" × 17" )
- 51 copies/minute (A4 , 8<sup>1</sup>/<sub>2</sub>" × 11" )

### ❖ Copying speed: (Type 2)

- 33 copies/minute (A3 , 11" × 17" )
- 60 copies/minute (A4 , 8<sup>1</sup>/<sub>2</sub>" × 11" )

### ❖ Copying speed: (Type 3)

- 38 copies/minute (A3 , 11" × 17" )
- 75 copies/minute (A4 , 8<sup>1</sup>/<sub>2</sub>" × 11" )

❖ **Reproduction ratio:**

Preset reproduction ratios:

	Metric version	Inch version
Enlargement	400%	400%
	200%	200%
	141%	155%
	122%	129%
	115%	121%
Full Size	100%	100%
Reduction	93%	93%
	82%	85%
	75%	78%
	71%	73%
	65%	65%
	50%	50%
	25%	25%

Zoom: From 25 to 400% in 1% steps.

❖ **Maximum continuous copy run:**

999 sets

❖ **Copy paper capacity:**

- Tray 1 (Tandem tray) : 3,100 sheets (1,550 sheets × 2) (80 g/m<sup>2</sup>, 20 lb.)
- Tray 2 (550-sheet tray) : 550 sheets (80 g/m<sup>2</sup>, 20 lb.)
- Tray 3 (550-sheet tray) : 550 sheets (80 g/m<sup>2</sup>, 20 lb.)
- Bypass tray: 100 sheets (69 g/m<sup>2</sup>, 18 lb.)

❖ **Power consumption:**

- Mainframe only

	Type 1	Type 2	Type 3
Warm-up	about 1.76 kw	about 1.76kw	about 1.76kw
Stand-by	about 0.33kw	about 0.33kw	about 0.33kw
During printing	about 1.30kw	about 1.31 kw	about 1.41kw
Maximum	less than 1.85kw	less than 1.85kw	less than 1.85kw

- Complete system \*1

	Type 1	Type 2	Type 3
Warm-up	about 1.76kw	about 1.76kw	about 1.76kw
Stand-by	about 0.33kw	about 0.33kw	about 0.33kw
During printing	about 1.84kw	about 1.84kw	about 1.84kw
Maximum	about 1.85 kw	about 1.85 kw	about 1.85 kw

\*1 The Complete System consists of the mainframe, finisher, large capacity tray (LCT) and mailbox.

◆ **Dimensions (W × D × H up to exposure glass):**

- Types 1, 2, 3: 690 × 760 × 985(1165 \*1) mm, 27.2" × 29.9" × 38.8"(45.9" \*1)
- \*1 When the ADF is included

◆ **Space for mainframe (W × D):**

- Types 1, 2: 1,175 × 794 mm, 46.3" × 31.3"
- Type 3: 1,175 × 847 mm, 46.3" × 33.3"

◆ **Noise Emission \*1:**

Sound Power Level:

- Mainframe only

	Type 1	Type 2	Type 3
Stand-by	Less than 49 dB (A)	Less than 49 dB (A)	Less than 49 dB (A)
Copying	Less than 70 dB (A)	Less than 70 dB (A)	Less than 71 dB (A)

- Complete system \*3

	Type 1	Type 2	Type 3
Stand-by	Less than 49 dB (A)	Less than 49 dB (A)	Less than 49 dB (A)
Copying	Less than 74 dB (A)	Less than 74 dB (A)	Less than 74 dB (A)

Sound Pressure Level \*2:

- Mainframe only

	Type 1	Type 2	Type 3
Stand-by	Less than 44 dB (A)	Less than 44 dB (A)	Less than 44 dB (A)
Copying	Less than 65 dB (A)	Less than 65 dB (A)	Less than 67 dB (A)

- Complete system \*3

	Type 1	Type 2	Type 3
Stand-by	Less than 44 dB (A)	Less than 44 dB (A)	Less than 44 dB (A)
Copying	Less than 69 dB (A)	Less than 69 dB (A)	Less than 69 dB (A)

\*1 The above measurements made in accordance with ISO 7779 are actual value.

\*2 It is measured at the position of the bystander.

\*3 The Complete System consists of the mainframe, finisher, large capacity tray (LCT) and mailbox.

❖ **Weight:**

- Types 1, 2: Approx. 204 kg, 449.8 lb
- Type 3: Approx. 216 kg, 476.2 lb

---

## Document Server

---

❖ **HDD:**

40 GB

❖ **HDD (Document Server):**

23.45 GB

❖ **Capacity:**

- Copy: Approx. 2,000 pages (ITUT-No.4 chart)
- Batch mode: Approx. 2,000 pages (ITUT-No.4 chart)
- Printer: Approx. 10,000 pages (600 dpi)
- Scanner: Approx. 2,000 pages (200 dpi/Text) (ITUT-No.4 chart) \*<sup>1</sup>

❖ **Maximum number of stored documents:**

3,000 documents

❖ **Maximum pages of stored documents:**

10,000 pages

❖ **Maximum number of pages per document:**

2,000 pages

❖ **Capacity (Memory Sorting):**

4.5 GB (A4/8<sup>1</sup>/<sub>2</sub>" × 11" : Approx. 333 sheets-2000 sheets at maximum) \*<sup>2</sup>

❖ **Capacity (Others):**

6.62 GB

\*<sup>1</sup> Scanning Conditions: ITUT-No. 4 chart/200 dpi/Text/A4/MMR

\*<sup>2</sup> The capacity differs depending on the functions are used.

---

## Auto Document Feeder







---

❖ **Mode:**







Batch (SADF) mode, Mixed Sizes mode, Paper Orientation mode

❖ **Original size:**

Metric version:

- A3  – B6 JIS   (1-sided originals)
- A3  – A5   (2-sided originals)

Inch version:

- 11" × 17"  – 5<sup>1</sup>/<sub>2</sub>" × 8<sup>1</sup>/<sub>2</sub>"   (1-sided originals)
- 11" × 17"  – 5<sup>1</sup>/<sub>2</sub>" × 8<sup>1</sup>/<sub>2</sub>"   (2-sided originals)

❖ **Original weight:**

- 1-sided originals: 40 – 128 g/m<sup>2</sup> (11 – 34 lb.)
- 2-sided originals: 52 – 128 g/m<sup>2</sup> (14 – 34 lb.)

❖ **Number of originals to be set:**

100 sheets (81.4 g/m<sup>2</sup>, 22 lb.) or less than 12 mm, 0.4"

❖ **Maximum power consumption:**

Less than 110W (power is supplied from the main unit)

❖ **Dimensions (W×D×H)**

680 × 560 × 180 mm, 26.8" × 22" × 7.1"

❖ **Weight:**

Approx. 18 kg, 39.7 lb.

 **Note**

- Specifications are subject to change without notice.



# Options

## Note

- ☐ Specifications are subject to change without notice.

---

## Mailbox

---

### ◆ Number of trays:

9 trays

### ◆ Paper size:

A3☐, B4 JIS☐, A4☐☐, B5 JIS☐☐, A5☐☐ \*1, 11" × 17"☐, 8<sup>1</sup>/<sub>2</sub>" × 14"☐, 8<sup>1</sup>/<sub>2</sub>" × 11"☐☐, 5<sup>1</sup>/<sub>2</sub>" × 8<sup>1</sup>/<sub>2</sub>"☐☐ \*1

\*1 These sizes cannot be detected automatically.

### ◆ Paper capacity:

100 sheets (80 g/m<sup>2</sup>, 20 lb.) per tray

### ◆ Paper weight:

52 – 128 g/m<sup>2</sup>, 14 – 34 lb.

### ◆ Power consumption:

Approx. 48W (power is supplied from the main unit)

### ◆ Dimensions (W × D × H):

540 × 600 × 660 mm, 21.3" × 23.6" × 26"

### ◆ Weight:

Approx. 15 kg, 33 lb.

---

## Booklet Finisher

---

Finisher Upper Tray:

### ◆ Paper size:

A3☐, B4 JIS☐, A4☐☐, B5 JIS☐☐, A5☐☐, B6 JIS☐, A6☐, 11" × 17"☐, 8<sup>1</sup>/<sub>2</sub>" × 14"☐, 8<sup>1</sup>/<sub>2</sub>" × 11"☐☐, 5<sup>1</sup>/<sub>2</sub>" × 8<sup>1</sup>/<sub>2</sub>"☐☐, 12" × 18"☐

### ◆ Paper weight:

52 – 163 g/m<sup>2</sup>, 14 – 43 lb.

### ◆ Stack capacity \*1:

Without Z-fold:

- 250 sheets (A4☐☐, B5 JIS☐☐, A5☐☐, B6 JIS☐☐, 8<sup>1</sup>/<sub>2</sub>" × 11"☐☐, 5<sup>1</sup>/<sub>2</sub>" × 8<sup>1</sup>/<sub>2</sub>"☐☐) (80 g/m<sup>2</sup>, 20 lb.)
- 50 sheets (A3☐, B4 JIS☐, 11" × 17"☐, 8<sup>1</sup>/<sub>2</sub>" × 14"☐, 12" × 18"☐) (80 g/m<sup>2</sup>, 20 lb.)

With Z-fold:

- 20 sheets (A4, B5 JIS, A5, B6 JIS, 8 1/2" × 11", 5 1/2" × 8 1/2") (80 g/m<sup>2</sup>, 20 lb.)
- 30 sheets (A3, B4 JIS, 11" × 17", 8 1/2" × 14", 12" × 18") (80 g/m<sup>2</sup>, 20 lb.)

\*1 In terms of stack capacity, one Z-folded sheet is equivalent to approximately 10 unfolded sheets.

Finisher Shift Tray 1: \*1

\*1 Finisher Shift Tray 1 cannot be used for the Z-fold function.

◆ **Paper size:**

A3, B4 JIS, A4, B5 JIS, A5, B6 JIS, A6, 11" × 17", 8 1/2" × 14", 8 1/2" × 11", 5 1/2" × 8 1/2", 12" × 18"

◆ **Paper weight:**

52 – 216 g/m<sup>2</sup>, 14 – 58 lb.

◆ **Stack capacity:**

- 500 sheets (A4, B5 JIS, A5, 8 1/2" × 11") (80 g/m<sup>2</sup>, 20 lb.)
- 250 sheets (A3, B4 JIS, 11" × 17", 8 1/2" × 14", 12" × 18") (80 g/m<sup>2</sup>, 20 lb.)
- 100 sheets (A5, B6 JIS, 5 1/2" × 8 1/2") (80 g/m<sup>2</sup>, 20 lb.)

◆ **Staple paper size:**

A3, B4 JIS, A4, B5 JIS, 11" × 17", 8 1/2" × 14", 8 1/2" × 11"

◆ **Staple paper weight:**

64 – 90 g/m<sup>2</sup>, 17 – 28 lb.

◆ **Staple capacity:**

Without Mixed Size:

- 50 sheets (A4, B5 JIS, 8 1/2" × 11") (80 g/m<sup>2</sup>, 20 lb.)
- 30 sheets (A3, B4 JIS, 11" × 17", 8 1/2" × 14") (80 g/m<sup>2</sup>, 20 lb.)

With Mixed Size:

- 30 sheets (A4 / A3, B5 JIS / B4 JIS, 8 1/2" × 11" / 11" × 17") (80 g/m<sup>2</sup>, 20 lb.)

◆ **Stack capacity after stapling**

Without Mixed Size:

- 50–10 sets (10–50 sheets) (A4, 8 1/2" × 11") (80 g/m<sup>2</sup>, 20 lb.)
- 50 sets (2–9 sheets) (A4, 8 1/2" × 11") (80 g/m<sup>2</sup>, 20 lb.)
- 25–16 sets (10–30 sheets) (other paper size) (80 g/m<sup>2</sup>, 20 lb.)
- 25 sets (2–9 sheets) (other paper size) (80 g/m<sup>2</sup>, 20 lb.)

With Mixed Size:

- 16 sets (2–30 sheets) (A4 / A3, B5 JIS / B4 JIS, 8 1/2" × 11" / 11" × 17") (80 g/m<sup>2</sup>, 20 lb.)

◆ **Staple position:**

4 position (Top, Top Slant, Bottom, 2 Staples)

Finisher Shift Tray 2:

◆ **Paper size:**

A3☐, B4 JIS☐, A4☐☐, B5 JIS☐☐, A5☐☐, B6 JIS☐, A6☐, 11" × 17"☐, 8<sup>1</sup>/<sub>2</sub>" × 14"☐, 8<sup>1</sup>/<sub>2</sub>" × 11"☐☐, 5<sup>1</sup>/<sub>2</sub>" × 8<sup>1</sup>/<sub>2</sub>"☐☐, 12" × 18"☐

◆ **Paper weight:**

52 – 216 g/m<sup>2</sup>, 14 – 58 lb.

◆ **Stack capacity \*1 :**

Without Z-fold:

- 2,500 sheets (A4☐, 8<sup>1</sup>/<sub>2</sub>" × 11"☐) (80 g/m<sup>2</sup>, 20 lb.)
- 1,250 sheets (A3☐, B4 JIS☐, A4☐, B5 JIS☐☐, 11" × 17"☐, 8<sup>1</sup>/<sub>2</sub>" × 14"☐, 8<sup>1</sup>/<sub>2</sub>" × 11"☐, 12" × 18"☐) (80 g/m<sup>2</sup>, 20 lb.)
- 500 sheets (A5☐) (80 g/m<sup>2</sup>, 20 lb.)
- 100 sheets (A5☐, B6 JIS☐ or 5<sup>1</sup>/<sub>2</sub>" × 8<sup>1</sup>/<sub>2</sub>"☐) (80 g/m<sup>2</sup>, 20 lb.)

With Z-fold:

- 20 sheets (A4☐☐, B5 JIS☐☐, A5☐☐, B6 JIS☐☐, 8<sup>1</sup>/<sub>2</sub>" × 11"☐☐, 5<sup>1</sup>/<sub>2</sub>" × 8<sup>1</sup>/<sub>2</sub>"☐☐) (80 g/m<sup>2</sup>, 20 lb.)
- 30 sheets (A3☐, B4 JIS☐, 11" × 17"☐, 8<sup>1</sup>/<sub>2</sub>" × 14"☐, 12" × 18"☐) (80 g/m<sup>2</sup>, 20 lb.)

\*1 In terms of stack capacity, one Z-folded sheet is equivalent to approximately 10 unfolded sheets.

◆ **Staple paper size:**

A3☐, B4 JIS☐, A4☐☐, B5 JIS☐☐, 11" × 17"☐, 8<sup>1</sup>/<sub>2</sub>" × 14"☐, 8<sup>1</sup>/<sub>2</sub>" × 11"☐☐

◆ **Staple paper weight:**

64 – 90 g/m<sup>2</sup>, 17 – 28 lb.

◆ **Staple capacity \*1 :**

Without Mixed Size:

- 50 sheets (A4☐☐, B5 JIS☐☐, 8<sup>1</sup>/<sub>2</sub>" × 11"☐☐) (80 g/m<sup>2</sup>, 20 lb.)
- 30 sheets (A3☐, B4 JIS☐, 11" × 17"☐, 8<sup>1</sup>/<sub>2</sub>" × 14"☐) (80 g/m<sup>2</sup>, 20 lb.)

With Mixed Size:

- 30 sheets (A4☐ / A3☐, B5 JIS☐ / B4 JIS☐, 8<sup>1</sup>/<sub>2</sub>" × 11"☐ / 11" × 17"☐) (80 g/m<sup>2</sup>, 20 lb.)

Without Z-fold:

- 50 sheets (A4☐☐, B5 JIS☐☐, A5☐☐, B6 JIS☐☐, 8<sup>1</sup>/<sub>2</sub>" × 11"☐☐, 5<sup>1</sup>/<sub>2</sub>" × 8<sup>1</sup>/<sub>2</sub>"☐☐) (80 g/m<sup>2</sup>, 20 lb.)
- 30 sheets (A3☐, B4 JIS☐, 11" × 17"☐, 8<sup>1</sup>/<sub>2</sub>" × 14"☐, 12" × 18"☐) (80 g/m<sup>2</sup>, 20 lb.)











With Z-fold:

- 5 sheets (A3☐, B4 JIS☐, 11" × 17") (80 g/m<sup>2</sup>, 20 lb.)







\*1 In terms of stack capacity, one Z-folded sheet is equivalent to approximately 10 unfolded sheets.

❖ **Stack capacity after stapling**

Without Mixed Size mode:

- 250–50 sets (10–50 sheets) (A4 , 8 1/2" × 11" ) (80 g/m<sup>2</sup>, 20 lb.)
- 250 sets (2–9 sheets) (A4 , 8 1/2" × 11" ) (80 g/m<sup>2</sup>, 20 lb.)
- 125–25 sets (10–50 sheets) (A4 , B5 JIS , 8 1/2" × 11" ) (80 g/m<sup>2</sup>, 20 lb.)
- 125 sets (2–9 sheets) (A4 , B5 JIS , 8 1/2" × 11" ) (80 g/m<sup>2</sup>, 20 lb.)
- 125–40 sets (10–30 sheets) (other paper size) (80 g/m<sup>2</sup>, 20 lb.)
- 125 sets (2–9 sheets) (other paper size) (80 g/m<sup>2</sup>, 20 lb.)





With Mixed Size mode:

- 50 sets (2–30 sheets) (A4 , A3 , B5 JIS , B4 JIS , 8 1/2" × 11" , 11" × 17" ) (80 g/m<sup>2</sup>, 20 lb.)

❖ **Staple position:**

4 position (Top, Top Slant, Bottom, 2 Staples)

❖ **Saddle stitch paper size:**

A3 , B4 JIS , A4 , 11" × 17" , 8 1/2" × 11" 







❖ **Saddle stitch paper weight:**

64 – 90 g/m<sup>2</sup>, 17 – 28 lb.

❖ **Saddle stitch capacity:**

1 set (15 sheets)

❖ **Stack capacity after Saddle stitching**

- 25 sets (2–5 sheets) (A4 , 8 1/2" × 11" ) (80 g/m<sup>2</sup>, 20 lb.)
- 15 sets (6–10 sheets) (A4 , 8 1/2" × 11" ) (80 g/m<sup>2</sup>, 20 lb.)
- 10 sets (11–15 sheets) (A4 , 8 1/2" × 11" ) (80 g/m<sup>2</sup>, 20 lb.)
- 30 sets (2–5 sheets) (other paper size) (80 g/m<sup>2</sup>, 20 lb.)
- 20 sets (6–10 sheets) (other paper size) (80 g/m<sup>2</sup>, 20 lb.)
- 10 sets (11–15 sheets) (other paper size) (80 g/m<sup>2</sup>, 20 lb.)

❖ **Saddle stitch position:**

Centre 2 position

❖ **Power consumption:**

Approx. 72W (power supplied from main unit)

❖ **Dimensions (W × D × H):**

700 × 620 × 960 mm, 27.6" × 24.5" × 37.8"

❖ **Weight:**

Approx. 65.3 kg, 144 lb.

## Finisher 3000M (50-Sheet Staples)

### Finisher Upper Tray:

#### ❖ Paper size:

A3, B4 JIS, A4, B5 JIS, A5, B6 JIS, A6, 11" × 17", 8<sup>1</sup>/<sub>2</sub>" × 14", 8<sup>1</sup>/<sub>2</sub>" × 11", 5<sup>1</sup>/<sub>2</sub>" × 8<sup>1</sup>/<sub>2</sub>", 12" × 18"

#### ❖ Paper weight:

52 – 163 g/m<sup>2</sup>, 14 – 43 lb.

#### ❖ Stack capacity:

- 250 sheets (A4, B5 JIS, A5, B6 JIS, 8<sup>1</sup>/<sub>2</sub>" × 11", 5<sup>1</sup>/<sub>2</sub>" × 8<sup>1</sup>/<sub>2</sub>) (80 g/m<sup>2</sup>, 20 lb.)
- 50 sheets (A3, B4 JIS, 11" × 17", 8<sup>1</sup>/<sub>2</sub>" × 14", 12" × 18") (80 g/m<sup>2</sup>, 20 lb.)

### Finisher Shift Tray:

#### ❖ Paper size:

A3, B4 JIS, A4, B5 JIS, A5, B6 JIS, A6, 11" × 17", 8<sup>1</sup>/<sub>2</sub>" × 14", 8<sup>1</sup>/<sub>2</sub>" × 11", 5<sup>1</sup>/<sub>2</sub>" × 8<sup>1</sup>/<sub>2</sub>", 12" × 18"

#### ❖ Paper weight:

52 – 216 g/m<sup>2</sup>, 14 – 58 lb.

#### ❖ Stack capacity:

- 3,000 sheets (A4, 8<sup>1</sup>/<sub>2</sub>" × 11") (80 g/m<sup>2</sup>, 20 lb.)
- 1,500 sheets (A3, B4 JIS, A4, B5 JIS, 11" × 17", 8<sup>1</sup>/<sub>2</sub>" × 14", 8<sup>1</sup>/<sub>2</sub>" × 11", 12" × 18") (80 g/m<sup>2</sup>, 20 lb.)
- 500 sheets (A5) (80 g/m<sup>2</sup>, 20 lb.)
- 100 sheets (A5, B6 JIS, 5<sup>1</sup>/<sub>2</sub>" × 8<sup>1</sup>/<sub>2</sub>") (80 g/m<sup>2</sup>, 20 lb.)

#### ❖ Staple paper size:

A3, B4 JIS, A4, B5 JIS, 11" × 17", 8<sup>1</sup>/<sub>2</sub>" × 14", 8<sup>1</sup>/<sub>2</sub>" × 11"

#### ❖ Staple paper weight:

64 – 90 g/m<sup>2</sup>, 17 – 28 lb.

#### ❖ Staple capacity:

Without Mixed Size mode:

- 50 sheets (A4, B5 JIS, 8<sup>1</sup>/<sub>2</sub>" × 11") (80 g/m<sup>2</sup>, 20 lb.)
- 30 sheets (A3, B4 JIS, 11" × 17", 8<sup>1</sup>/<sub>2</sub>" × 14") (80 g/m<sup>2</sup>, 20 lb.)

With Mixed Size mode:

- 30 sheets (A4 / A3, B5 JIS / B4 JIS, 8<sup>1</sup>/<sub>2</sub>" × 11" / 11" × 17") (80 g/m<sup>2</sup>, 20 lb.)

### ◆ Stack capacity after stapling

Without Mixed Size mode:

- 300–60 sets (10–50 sheets) (A4  $\square$ , 8 $\frac{1}{2}$ "  $\times$  11"  $\square$ )(80 g/m<sup>2</sup>, 20 lb.)
- 300 sets (2–9 sheets) (A4  $\square$ , 8 $\frac{1}{2}$ "  $\times$  11"  $\square$ )(80 g/m<sup>2</sup>, 20 lb.)
- 150–30 sets (10–50 sheets) (A4  $\square$ , B5 JIS  $\square$   $\square$ , 8 $\frac{1}{2}$ "  $\times$  11"  $\square$ )(80 g/m<sup>2</sup>, 20 lb.)
- 150 sets (2–9 sheets) (A4  $\square$ , B5 JIS  $\square$   $\square$ , 8 $\frac{1}{2}$ "  $\times$  11"  $\square$ )(80 g/m<sup>2</sup>, 20 lb.)
- 150–50 sets (10–30 sheets) (other size paper)(80 g/m<sup>2</sup>, 20 lb.)
- 150 sets (2–9 sheets) (other size paper)(80 g/m<sup>2</sup>, 20 lb.)

With Mixed Size mode:

- 50 sets (2–30 sheets) (A4  $\square$  / A3  $\square$ , B5 JIS  $\square$  / B4 JIS  $\square$ , 8 $\frac{1}{2}$ "  $\times$  11"  $\square$  / 11"  $\times$  17"  $\square$ ) (80 g/m<sup>2</sup>, 20 lb.)

### ◆ Staple position:

4 position (Top, Top Slant, Bottom, 2 Staples)

### ◆ Power consumption:

Approx. 72W (power supplied from main unit)

### ◆ Dimensions (W $\times$ D $\times$ H):

700  $\times$  620  $\times$  960 mm, 27.6"  $\times$  24.5"  $\times$  37.8"

### ◆ Weight:

Approx. 51 kg, 112.4 lb.

---

## Finisher 3000B (100-Sheet Staples)

---

Finisher Upper Tray:

### ◆ Paper size:

A3  $\square$ , B4 JIS  $\square$ , A4  $\square$   $\square$ , B5 JIS  $\square$   $\square$ , A5  $\square$   $\square$ , B6 JIS  $\square$ , A6  $\square$ , 11"  $\times$  17"  $\square$ , 8 $\frac{1}{2}$ "  $\times$  14"  $\square$ , 8 $\frac{1}{2}$ "  $\times$  11"  $\square$   $\square$ , 5 $\frac{1}{2}$ "  $\times$  8 $\frac{1}{2}$ "  $\square$   $\square$ , 12"  $\times$  18"  $\square$

### ◆ Paper weight:

52 – 216 g/m<sup>2</sup>, 14 – 58 lb.

### ◆ Stack capacity:

- 500 sheets (A4  $\square$   $\square$ , B5 JIS  $\square$   $\square$ , A5  $\square$   $\square$ , B6 JIS  $\square$ , A6  $\square$ , 8 $\frac{1}{2}$ "  $\times$  11"  $\square$   $\square$ , 5 $\frac{1}{2}$ "  $\times$  8 $\frac{1}{2}$ "  $\square$   $\square$ ) (80 g/m<sup>2</sup>, 20 lb.)
- 250 sheets (A3  $\square$ , B4 JIS  $\square$ , 11"  $\times$  17"  $\square$ , 8 $\frac{1}{2}$ "  $\times$  14"  $\square$ , 12"  $\times$  18"  $\square$ ) (80 g/m<sup>2</sup>, 20 lb.)

Finisher Shift Tray:















### ◆ Paper size:

A3  $\square$ , B4 JIS  $\square$ , A4  $\square$   $\square$ , B5 JIS  $\square$   $\square$ , A5  $\square$   $\square$ , 11"  $\times$  17"  $\square$ , 8 $\frac{1}{2}$ "  $\times$  14"  $\square$ , 8 $\frac{1}{2}$ "  $\times$  11"  $\square$   $\square$ , 5 $\frac{1}{2}$ "  $\times$  8 $\frac{1}{2}$ "  $\square$   $\square$ , 12"  $\times$  18"  $\square$









❖ **Paper weight:**

52 – 216 g/m<sup>2</sup>, 14 – 58 lb.

❖ **Stack capacity:**

- 3,000 sheets (A4 , B5 JIS , 8<sup>1</sup>/<sub>2</sub>" × 11" ) (80 g/m<sup>2</sup>, 20 lb.)
- 1,500 sheets (A3 , B4 JIS , A4 , B5 JIS , 11" × 17" , 8<sup>1</sup>/<sub>2</sub>" × 14" , 8<sup>1</sup>/<sub>2</sub>" × 11" , 12" × 18" ) (80 g/m<sup>2</sup>, 20 lb.)
- 500 sheets (A5 , 5<sup>1</sup>/<sub>2</sub>" × 8<sup>1</sup>/<sub>2</sub>" ) (80 g/m<sup>2</sup>, 20 lb.)
- 100 sheets (A5 , 5<sup>1</sup>/<sub>2</sub>" × 8<sup>1</sup>/<sub>2</sub>" ) (80 g/m<sup>2</sup>, 20 lb.)







❖ **Staple paper size:**

A3 , B4 JIS , A4 , B5 JIS , 11" × 17" , 8<sup>1</sup>/<sub>2</sub>" × 14" , 8<sup>1</sup>/<sub>2</sub>" × 11"  















❖ **Staple paper weight:**

64 – 80 g/m<sup>2</sup>, 17 – 20 lb.

❖ **Staple capacity:**

- 100 sheets (A4 , B5 JIS , 8<sup>1</sup>/<sub>2</sub>" × 11" ) (80 g/m<sup>2</sup>, 20 lb.)
- 50 sheets (A3 , B4 JIS , 11" × 17" , 8<sup>1</sup>/<sub>2</sub>" × 14" ) (80 g/m<sup>2</sup>, 20 lb.)

❖ **Stack capacity after stapling**

- 200–30 sets (10–100 sheets) (A4 , B5 JIS , 8<sup>1</sup>/<sub>2</sub>" × 11" ) (80 g/m<sup>2</sup>, 20 lb.)
- 150 sets (2–9 sheets) (A4 , B5 JIS , 8<sup>1</sup>/<sub>2</sub>" × 11" ) (80 g/m<sup>2</sup>, 20 lb.)
- 150–30 sets (10–50 sheets) (A3 , B4 JIS , 11" × 17" , 8<sup>1</sup>/<sub>2</sub>" × 14" ) (80 g/m<sup>2</sup>, 20 lb.)
- 150 sets (2–9 sheets) (A3 , B4 JIS , 11" × 17" , 8<sup>1</sup>/<sub>2</sub>" × 14" ) (80 g/m<sup>2</sup>, 20 lb.)

❖ **Staple position:**

4 position (Top, Top Slant, Bottom, 2 Staples)

❖ **Power consumption:**

Approx. 100W (power supplied from main unit)

❖ **Dimensions (W × D × H):**











800 × 730 × 980 mm, 31.5" × 28.7" × 38.6"

❖ **Weight:**

Approx. 65 kg, 143.3 lb.

## Punch Unit (Booklet Finisher, Finisher 3000M)

❖ **Paper size:**

Punch unit type			
2 & 4 holes type	2 holes		A3-A5, 11" × 17"-5 <sup>1</sup> / <sub>2</sub> " × 8 <sup>1</sup> / <sub>2</sub> "
			A4-A5, 8 <sup>1</sup> / <sub>2</sub> " × 11", 5 <sup>1</sup> / <sub>2</sub> " × 8 <sup>1</sup> / <sub>2</sub> "
	4 holes		A3, B4 JIS, 11" × 17"
			A4, B5 JIS, 8 <sup>1</sup> / <sub>2</sub> " × 11"
4 holes type	4 holes		A3-A5, 11" × 17"-5 <sup>1</sup> / <sub>2</sub> " × 8 <sup>1</sup> / <sub>2</sub> "
			A4-A5, 8 <sup>1</sup> / <sub>2</sub> " × 11", 5 <sup>1</sup> / <sub>2</sub> " × 8 <sup>1</sup> / <sub>2</sub> "
2 & 3 holes type	2 holes		A3-A5, 11" × 17"-5 <sup>1</sup> / <sub>2</sub> " × 8 <sup>1</sup> / <sub>2</sub> "
			A4-A5, 8 <sup>1</sup> / <sub>2</sub> " × 11", 5 <sup>1</sup> / <sub>2</sub> " × 8 <sup>1</sup> / <sub>2</sub> "
	3 holes		A3, B4 JIS, 11" × 17"
			A4, B5 JIS, 8 <sup>1</sup> / <sub>2</sub> " × 11"

❖ **Paper weight:**

52 – 163 g/m<sup>2</sup>, 14 lb. – 43 lb.

❖ **Power consumption:**

26.4W (power supplied from main unit.)

❖ **Dimensions (W × D × H):**







142 × 456 × 92 mm, 55.9" × 179.5" × 36.2"

❖ **Weight:**





Approx. 2.9 kg, 6.4 lb

## Punch Unit (Finisher 3000B)

❖ **Paper size:**

Punch unit type			
2 & 4 holes type	2 holes		A3-A5, 11" × 17"-5 <sup>1</sup> / <sub>2</sub> " × 8 <sup>1</sup> / <sub>2</sub> "
			A4-A5, 8 <sup>1</sup> / <sub>2</sub> " × 11", 5 <sup>1</sup> / <sub>2</sub> " × 8 <sup>1</sup> / <sub>2</sub> "
	4 holes		A3, 11" × 17"
			A4, 8 <sup>1</sup> / <sub>2</sub> " × 11"
4 holes type	4 holes		A3-B5 JIS, 11" × 17"-8 <sup>1</sup> / <sub>2</sub> " × 11"
			A4-A5, 8 <sup>1</sup> / <sub>2</sub> " × 11", 5 <sup>1</sup> / <sub>2</sub> " × 8 <sup>1</sup> / <sub>2</sub> "



Punch unit type			
2 & 3 holes type	2 holes		A3-A5, 11" × 17"-5 <sup>1</sup> / <sub>2</sub> " × 8 <sup>1</sup> / <sub>2</sub> "
			A4-A5, 8 <sup>1</sup> / <sub>2</sub> " × 11", 5 <sup>1</sup> / <sub>2</sub> " × 8 <sup>1</sup> / <sub>2</sub> "
	3 holes		A3, B4 JIS, 11" × 17"
			A4, B5 JIS, 8 <sup>1</sup> / <sub>2</sub> " × 11"

❖ **Paper weight:**

- 4 holes: 52 – 128 g/m<sup>2</sup>, 14 lb. – 34 lb.
- 2 & 3 holes: 52 – 163 g/m<sup>2</sup>, 14 lb. – 43 lb.

❖ **Power consumption:**

60W (power supplied from main unit)

❖ **Dimensions (W × D × H):**

- 4 holes: 92 × 463 × 100 mm, 3.6" × 18.2" × 3.9"
- 2 & 3 holes, 2 & 4 holes: 105 × 463 × 100 mm, 4.1" × 18.2" × 3.9"

❖ **Weight:**







- 4 holes: Approx. 2.4 kg, 5.3 lb
- 2 & 3 holes, 2 & 4 holes: Approx. 2.6 kg, 5.7 lb

## Z-folding Unit

 **Note**

To use the Z-folding unit, the Booklet Finisher is required.

❖ **Paper size:**

A3 , B4 JIS , A4 , 11" × 17" , 8<sup>1</sup>/<sub>2</sub>" × 14" , 8<sup>1</sup>/<sub>2</sub>" × 11" 

❖ **Paper weight:**

64 – 80 g/m<sup>2</sup>, 17 – 20 lb.

❖ **Power consumption:**

100W (a separate power source is required)

❖ **Dimensions (W × D × H):**

177 × 620 × 960 mm, 6.9" × 24.4" × 37.8"

❖ **Weight:**

Approx. 55 kg, 121.3 lb

---

## Copy Tray

---

❖ **Paper capacity:**

- A3, 11" × 17" : 250 sheets
- B4 JIS, 8<sup>1</sup>/<sub>2</sub>" × 14" : 500 sheets
- A4, 8<sup>1</sup>/<sub>2</sub>" × 11" : 500 sheets
- B5 JIS, 5<sup>1</sup>/<sub>2</sub>" × 8<sup>1</sup>/<sub>2</sub>" : 250 sheets

❖ **Dimensions (W × D × H):**

390 × 330 × 130 mm, 15.4" × 13" × 5.1"

❖ **Weight:**

Approx. 650 g, 1.4 lb

---

## Large Capacity Tray (LCT)

---

❖ **Paper size:**

A4 □, B5 JIS □, 8<sup>1</sup>/<sub>2</sub>" × 11" □

❖ **Paper weight:**

52 – 128 g/m<sup>2</sup>, 14 – 34 lb.

❖ **Paper capacity:**

4,000 sheets (80 g/m<sup>2</sup>, 20 lb.)

❖ **Power consumption**

Maximum. 50 W (power supplied from main unit)

❖ **Dimensions (W × D × H, option unit):**

314 × 458 × 659 mm, 12.4" × 18" × 25.9"

❖ **Weight:**

Approx. 20 kg, 44 lb.

---

## Interposer

---

❖ **Paper size:**

A3 □, B4 JIS □, A4 □ □, B5 JIS □ □, A5 □ □, 11" × 17" □, 8<sup>1</sup>/<sub>2</sub>" × 14" □, 8<sup>1</sup>/<sub>2</sub>" × 11" □ □, 5<sup>1</sup>/<sub>2</sub>" × 8<sup>1</sup>/<sub>2</sub>" □ □

❖ **Paper weight:**

64 – 216 g/m<sup>2</sup>, 20 – 58 lb.

❖ **Paper Capacity:**

200 sheets (80 g/m<sup>2</sup>, 20 lb.)

**❖ Power consumption (Max):**

Approx. 48 W (power supplied from main unit)

**❖ Dimensions (W × D × H):**

500 × 620 × 200 mm, 19.7" × 24.4" × 7.9"

**❖ Weight:**

Approx. 12 kg, 26.5 lb.

## Others

❖ **A3/11" × 17" Tray Unit (option)**

You can load A3 or 11" × 17" paper in the tray 1 using this unit.

❖ **B4 JIS/8<sup>1</sup>/<sub>2</sub>" × 14" Tray Unit (option)**

You can load B4 JIS/A4 or 8<sup>1</sup>/<sub>2</sub>" × 14" paper in the large capacity tray (LCT) using this unit.

❖ **Tab Sheet Holder (option)**

You can use tab sheets with this holder.

❖ **Output Jogger (option)**

You can tidy the printout with Finisher 3000B (100-Sheet Staples).

# Copy Paper

## Recommended Paper Sizes and Types

The following limitations apply to each tray:

Tray Type	Paper Type and Weight	Metric Version	Inch Version	Paper Capacity <sup>*9</sup>
Tray 1 <sup>*1</sup>	52.3-127.9 g/m <sup>2</sup> (14-34 lb.)	A4 □, 8 <sup>1</sup> / <sub>2</sub> " × 11" □		1,550 sheets × 2
Tray 1 <sup>*1</sup> (A3/11" × 17" Tray Unit (option))		A3□, B4 JIS□, A4 □ □, 11" × 17"□, 8 <sup>1</sup> / <sub>2</sub> " × 14"□, 8 <sup>1</sup> / <sub>2</sub> " × 11" □ □		1,000 sheets
Tray 2,3	52.3-127.9 g/m <sup>2</sup> (14-34 lb.)	<sup>*3</sup> A3□, A4 □ □, A5 □ □, 8 <sup>1</sup> / <sub>2</sub> " × 13"□, 8 <sup>1</sup> / <sub>4</sub> " × 13"□	<sup>*3</sup> 11" × 17"□, 8 <sup>1</sup> / <sub>2</sub> " × 14"□, 8 <sup>1</sup> / <sub>2</sub> " × 11" □ □, 8 <sup>1</sup> / <sub>2</sub> " × 5 <sup>1</sup> / <sub>2</sub> " □ □, 8" × 13"□, 7 <sup>1</sup> / <sub>4</sub> " × 10 <sup>1</sup> / <sub>2</sub> "□, 8" × 10 <sup>1</sup> / <sub>2</sub> "□	550 sheets
		<sup>*4</sup> B4 JIS□, B5 JIS □ □, 11" × 17"□, 8 <sup>1</sup> / <sub>2</sub> " × 14"□, 8 <sup>1</sup> / <sub>2</sub> " × 11" □ □, 5 <sup>1</sup> / <sub>2</sub> " × 8 <sup>1</sup> / <sub>2</sub> " □ □, 8" × 13"□, 7 <sup>1</sup> / <sub>4</sub> " × 10 <sup>1</sup> / <sub>2</sub> "□, 11" × 15"□, 10" × 15"□, 8 <sup>1</sup> / <sub>4</sub> " × 14"□, 8" × 10 <sup>1</sup> / <sub>2</sub> , 210 × 340 mm□, 210 × 182 mm □, 210 × 170 mm □, 8K(267 × 390 mm)□, 16K(195 × 267 mm) □ □	<sup>*4</sup> A3□, B4 JIS□, A4 □ □, B5 JIS □ □, A5 □ □, 8 <sup>1</sup> / <sub>2</sub> " × 13"□, 8 <sup>1</sup> / <sub>4</sub> " × 13"□, 11" × 15"□, 10" × 15"□, 8 <sup>1</sup> / <sub>4</sub> " × 14"□, 210 × 340 mm□, 210 × 182 mm □, 210 × 170 mm □, 8K(267 × 390 mm)□, 16K(195 × 267 mm) □ □	
		Custom size Vertical: 139.7-297 mm Horizontal: 139.7-431.8 mm	Custom size Vertical: 5.5"-11.7" Horizontal: 5.5"-17.0"	
Tab sheets	163 g/m <sup>2</sup> , 199 g/m <sup>2</sup> (90 lb. Index, 110 lb. Index) <sup>*2</sup>	A4 □, 8 <sup>1</sup> / <sub>2</sub> " × 11" □, 8 <sup>1</sup> / <sub>2</sub> " × 14"□ (90 lb. Index only)		500 sheets

Tray Type	Paper Type and Weight	Metric Version	Inch Version	Paper Capacity <sup>*9</sup>
Bypass Tray	52.3-216 g/m <sup>2</sup> (14-57.6 lb.)	<sup>*3</sup> A3☐, A4☐, A5☐	<sup>*3</sup> A3☐, 11"×17"☐, 8 <sup>1</sup> / <sub>2</sub> "×14"☐, 5 <sup>1</sup> / <sub>2</sub> "×8 <sup>1</sup> / <sub>2</sub> "☐,	100 sheets (52.3-105 g/m <sup>2</sup> (14-28 lb.))
		<sup>*5</sup> B4 JIS☐, A4☐, B5 JIS☐☐, A5☐☐, B6 JIS☐, A6☐, 11"×17"☐, 8 <sup>1</sup> / <sub>2</sub> "×14"☐, 8 <sup>1</sup> / <sub>2</sub> "×11"☐☐, 5 <sup>1</sup> / <sub>2</sub> "×8 <sup>1</sup> / <sub>2</sub> "☐☐, 8 <sup>1</sup> / <sub>2</sub> "×13"☐, 8 <sup>1</sup> / <sub>4</sub> "×13"☐, 8"×13"☐, 7 <sup>1</sup> / <sub>4</sub> "×10 <sup>1</sup> / <sub>2</sub> "☐☐, 11"×15"☐, 11"×14"☐, 10"×15"☐, 10"×14"☐, 8 <sup>1</sup> / <sub>4</sub> "×14"☐, 8"×10 <sup>1</sup> / <sub>2</sub> "☐☐, 8"×10"☐☐	<sup>*5</sup> B4 JIS☐, A4☐☐, B5 JIS☐☐, A5☐☐☐, B6 JIS☐, A6☐, 8 <sup>1</sup> / <sub>2</sub> "×11"☐☐, 5 <sup>1</sup> / <sub>2</sub> "×8 <sup>1</sup> / <sub>2</sub> "☐☐, 8 <sup>1</sup> / <sub>2</sub> "×13"☐, 8 <sup>1</sup> / <sub>4</sub> "×13"☐, 8"×13"☐, 7 <sup>1</sup> / <sub>4</sub> "×10 <sup>1</sup> / <sub>2</sub> "☐☐, 11"×15"☐, 11"×14"☐, 10"×15"☐, 10"×14"☐, 8 <sup>1</sup> / <sub>4</sub> "×14"☐, 8"×10 <sup>1</sup> / <sub>2</sub> "☐☐, 8"×10"☐☐	30 sheets (105-157 g/m <sup>2</sup> (28-41.7 lb.))
		<sup>*6</sup> Custom size Vertical: 100-305 mm Horizontal: 139.7-600 mm	<sup>*6</sup> Custom size Vertical: 4"-12" Horizontal: 5.5"-23.6"	20 sheets (157-216 g/m <sup>2</sup> (41.7-57.6 lb.))
	Translucent paper <sup>*11</sup>	A3☐, B4 JIS☐, A4☐, B5 JIS☐, A4☐ <sup>*5</sup> , B5 JIS☐ <sup>*5</sup>	50 sheets <sup>*10</sup>	
	OHP transparencies <sup>*7</sup>	A4☐, 8 <sup>1</sup> / <sub>2</sub> "×11"☐, A4☐ <sup>*5</sup> , 8 <sup>1</sup> / <sub>2</sub> "×11"☐ <sup>*5</sup>	50 sheets <sup>*10</sup>	
Postcards <sup>*7</sup>	100×148 mm☐	30 sheets <sup>*10</sup>		
Label paper (adhesive labels)	B4 JIS☐, A4☐, A4☐ <sup>*5</sup>	1 sheet		
Large Capacity Tray (LCT) (option) <sup>*1</sup>	52.3-127.9 g/m <sup>2</sup> (14-34 lb.)	B4 JIS☐ <sup>*8</sup> , A4☐ <sup>*8</sup> , 8 <sup>1</sup> / <sub>2</sub> "×14"☐ <sup>*8</sup> , A4☐, B5 JIS☐, 8 <sup>1</sup> / <sub>2</sub> "×11"☐	4,000 sheets	

<sup>\*1</sup> The paper tray fence is fixed. If you wish to change the size of paper placed in this tray, contact your service representative.

<sup>\*2</sup> The optional tab sheet holder is required.

<sup>\*3</sup> The paper size is detected automatically.

<sup>\*4</sup> Select the paper size in System Settings. See p.56 "Tray Paper Size: (Tray 2,3)".

<sup>\*5</sup> Press [Bypass], and the [#] key, and then select the paper size.

<sup>\*6</sup> Press [Bypass], and the [#] key, and then enter the paper size using the number keys.

<sup>\*7</sup> If you wish to copy onto OHP transparencies or thick paper, select "OHP" or "Thick Paper". ⇒ "When copying onto OHP transparencies or Thick Paper" in the Copy Reference

<sup>\*8</sup> The optional B4 JIS/8<sup>1</sup>/<sub>2</sub>"×14" tray unit is required to load B4 JIS/8<sup>1</sup>/<sub>2</sub>"×14" size paper. (2,500 sheets can be loaded in this tray.)

- \*9 When loading paper, make sure the stack height does not exceed the lower limit mark of the paper tray. The amount of paper that can be set is 10 mm/100 sheets approximately. See p.96 “ Loading Paper”.
- \*10 It is recommended to place one sheet at a time.
- \*11 When loading translucent papers, set the paper direction according to the grain.

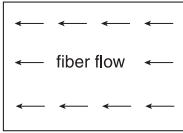



ZGJS870E

### Important

- If you use damp or curled paper, a misfeed may occur.

### Note

- When loading paper in the paper trays 1-3, place the copy side face down.
- When loading paper in the large capacity tray (LCT), place the copy side face down.
- When loading paper in the bypass tray, place the copy side face up.
- When you use the bypass tray, it is recommended to set the copy paper direction to .
- Do not use paper for inkjet printers.
- When you load OHP transparencies, check the front and back of the sheets, and place them correctly, or a misfeed might occur. Set the paper direction to . For details, see *Copy Reference*.
- When you use OHP transparencies, fan them for each use.
- If multiple sheet feeding occurs, load sheets one by one.
- When you load label paper, set the paper direction to .
- If you load paper of the same size in the same direction in two or more trays, the machine automatically shifts to the other tray when the first tray in use runs out of paper. This function is called Auto Tray Switching. (However, if the Paper Type of one tray is recycled or special paper, the settings of the other trays must be the same for the Auto Tray Switching function to work.) This saves interrupting a copy run to replenish paper when making a large number of copies. See p.56 “Tray Paper Size: (Tray 2,3)”, and *Copy Reference*.

## Non-recommended Paper

### CAUTION:

- Do not use aluminum foil, carbon paper, or similar conductive paper to avoid a fire or machine failure.

### Important

- Do not use any of the following kinds of paper or a fault might occur.
  - Paper for inkjet printers

- Thermal fax paper
  - Art paper
  - Aluminum foil
  - Carbon paper
  - Conductive paper
  - Paper with perforated lines
  - Hemmed paper
  - Envelopes
- Do not copy on the side of paper that has been already copied onto or a fault might occur.

 **Note**

- Do not use the following kinds of paper or a misfeed might occur.
- Bent, folded, or creased paper
  - Torn paper
  - Slippery paper
  - Perforated paper
  - Rough paper
  - Thin paper with low stiffness
  - Paper with a dusty surface
- If you copy onto rough grain paper, the image might be blurred.

---

## Paper Storage

---

 **Note**

- When storing paper, the following precautions should always be followed:
- Do not store paper where it will be exposed to direct sunlight.
  - Avoid storing paper in humid areas (humidity: 70% or less).
  - Store on a flat surface.
- Do not store paper vertically.
- In high temperature/high humidity conditions or low temperature/ low humidity conditions, store paper in a vinyl bag.



# INDEX

## A

---

- A3/11" × 17" Tray Unit, 152
- Access to the Machine, 128
- Adding
  - Staples, 115
  - Toner, 100
- Adding a Group to Another Group, 88
- Adding Staples
  - Booklet Finisher (Saddle Stitch), 116
  - Finisher 3000B (100-Sheet Staples), 117
  - Finisher 3000M (50-Sheet Staples), Booklet Finisher, 115
- Address Book
  - Change Order, 63
  - Edit Title, 64
  - Program/Change/Delete Group, 62
  - Select Title, 64
- Address book, 66
- Address Book Management, 62
- ADF Original Table Elevation, 54
- Administrator Authentication Management, 60
- Administrator Tools, 60
- AOF (Always On), 65
- Authentication Information, 71
- Authentication screen, 23
  - log off, 24
  - log on, 23
- Auto Delete File, 64
- Auto document feeder, 17, 140
- Auto Erase Memory Setting, 65
- Auto Logout Timer, 60
- Auto Off, 27
- Auto Off Timer, 58

## B

---

- B4 JIS/81/2" × 14" Tray Unit, 152
- Booklet finisher, 141
- Browse network, 79
- Bypass tray, 18

## C

---

- Changing
  - Display Language, 130
  - File Name, 38, 39
  - Modes, 29
  - Paper Size, 113
  - Password, 39
  - User Name, 39
- Changing a group name, 87
- Changing a registered e-mail destination, 76

- Changing a registered folder, 80, 83
- Changing a registered name, 70
- Changing a user code, 72
- Changing LDAP Authentication, 91
- Changing the Paper Size
  - Tray 2, 113
  - Tray 3, 113
- Checking
  - Job List, 30
- Checking Stored Documents, 40
- [Check Modes]** key, 21
- Cleaning
  - Auto document feeder, 129
  - Exposure glass, 129
- Clearing
  - Misfeeds, 103
- Clearing the number of prints, 74
- [Clear Modes]** key, 21
- [Clear/Stop]** key, 22
- Combined Function Operations, 29
- Common key operations, 23
- Control panel, 18, 21
- Copier/Document Server Auto Reset Timer, 59
- Copy Count Display (Copier/Document Server), 51
- Copy Paper, 153
- Copy tray, 17, 19, 150
- Copy tray guide, 17
- Counter
  - Displaying, 131
- Cover Sheet Tray, 57

## D

---

- Delete All Files, 65
- Deleting
  - Job List, 31
- Deleting a group, 87
- Deleting a registered e-mail destination, 77
- Deleting a registered folder, 81, 84
- Deleting a registered name, 70
- Deleting a user code, 72
- Designation Sheet Tray, 57
- Display/Clear/Print Counter per User, 61
- Displaying
  - Counter, 131
- Displaying names registered in groups, 87
- Displaying the Counter for each user code, 73
- Display Language
  - Changing, 130
- Display panel, 21, 22
- Display/Print Counter, 61

Document Server, 35, 139  
    *Downloading*, 44  
    *Settings*, 46  
    *Using*, 36  
    *Viewing*, 44  
Dos And Don'ts, 125

## E

---

E-mail destination, 75  
[**Energy Saver**] key, 21  
Energy Saver Timer, 58  
ENERGY STAR Program, 13  
Enhanced External Charge Unit  
    Management, 60  
Entering Text, 133  
Erase All Memory, 65  
Exposure glass, 17  
Extended Security, 61  
External Charge Unit Management, 60  
External Options, 19

## F

---

File Name  
    *Changing*, 38, 39  
Finisher  
    *Booklet Finisher*, 19  
    *Finisher 3000B(100-Sheet Staples)*, 19  
    *Finisher 3000M(50-Sheet Staples)*, 19  
Finisher 3000B (100-Sheet Staples), 146  
Finisher 3000M (50-Sheet Staples), 145  
Firmware Version, 65  
Front cover, 18  
FTP, 81  
Function keys, 22  
Function Priority, 51  
Function Reset Timer, 52  
Function Status indicator, 22

## G

---

General Features, 51  
Guide To Components, 17

## I

---

Indicators, 21  
Inquiry, 130  
Interleave Print, 52  
Internal options, 20  
Interposer, 19, 150  
[**Interrupt**] key, 21

## J

---

Jammed Staples  
    *Removing*, 118  
Job List, 30  
    *Checking*, 30  
    *Deleting*, 31  
Job List Display Time, 54  
[**Job List**] key, 21

## K

---

Key Counter Management, 60

## L

---

Large Capacity Tray (LCT), 19, 150  
Loading Paper, 96  
    *Interposer*, 98  
    *Large Capacity Tray (LCT)*, 97  
    *Tray 1 (Tandem Tray)*, 96  
    *Tray 2*, 97  
    *Tray 3*, 97

## M

---

Machine Environment, 127  
Machine Types, 15  
Mailbox, 19, 141  
Main Power  
    *Turning Off*, 26  
    *Turning On*, 25  
Main power indicator, 21  
Main power switch, 17, 25  
Maintaining Your Machine, 129  
Main unit, 135  
Misfeeds  
    *Clearing*, 103  
Moving, 127  
Multi-Access, 32

## N

---

Name, 69  
Non-recommended Paper, 155  
Number keys, 22

## O

---

Operation switch, 17, 22, 25  
Output  
    *Copier*, 53  
    *Document Server*, 53  
    *Printer*, 54  
Output Jogger, 152  
Output Tray Setting, 52

## P

---

- Panel Off Timer, 58
- Panel Tone, 51
- Paper Storage, 156
- Paper tray, 18
- Paper Tray Priority
  - Copier, 55
  - Printer, 55
- Paper Type
  - Bypass tray, 56
  - LCT, 56
  - Tray 1, 56
  - Tray 2, 56
  - Tray 3, 56
- Password
  - Changing, 39
  - Setting or changing, 38
- Power
  - Turning Off, 26
  - Turning On, 25
- Power Connection, 128
- Print Address Book
  - Destination List, 63
- Printer Bypass Paper Size, 58
- Printing the Counter for each user code, 73
- Printing the First Page, 43
- Print Priority, 52
- Program/ Change Administrator, 60
- Program/ Change LDAP Server, 65
- [Program]** key, 21
- Protection
  - code, 89, 90
  - destination, 89
- Punch Unit, 148
- Punch Waste
  - Removing, 121

## R

---

- Recommended Paper Sizes and Types, 153
- Registering a name, 69
- Registering an e-mail address, 75
- Registering a new user code, 71
- Registering a protection code, 89
- Registering a protection code for a group, 90
- Registering a protection code for a name, 89
- Registering Folders, 78
- Registering LDAP Authentication, 91
- Registering names to a group, 85, 86
- Registering or changing
  - User Name, 37
- Remarks, 125

- Removing
  - Jammed Staples, 118
  - Punch Waste, 121
- Removing a name from a group, 86
- Removing Jammed Staples
  - Booklet Finisher (Saddle Stitch), 119
  - Finisher 3000B (100-Sheet Staples), 120
  - Finisher 3000M (50-Sheet Staples), Booklet Finisher, 118
- Removing Punch Waste
  - Finisher 3000B (100-Sheet Staples), 122
  - Finisher 3000M (50-Sheet Staples), Booklet Finisher, 121
- Replacing
  - Toner, 102

## S

---

- Saddle stitch, 141
- Safety information, 8
- Sample Copy, 42
- [Sample Copy]** key, 22
- Saving energy, 26
- Scanner Auto Reset Timer, 59
- Screen contrast knob, 21
- Searching by file name, 40
- Searching by user name, 41
- Selecting a Document, 39
- Set Date, 59
- Set Time, 59
- Setting or changing
  - Password, 38
- Settings
  - Document Server, 46
- Slip Sheet Tray, 57
- SMB, 78
- Specification, 135
  - Auto document feeder, 140
  - Booklet finisher, 141
  - Copy tray, 150
  - Document Server, 139
  - Finisher 3000B (100-Sheet Staples), 146
  - Finisher 3000M (50-Sheet Staples), 145
  - Interposer, 150
  - Large Capacity Tray (LCT), 150
  - Mailbox, 141
  - Punch Unit, 148
  - Z-folding unit, 149
- Specifications
- Main unit, 135
- Staples
  - Adding, 115

**[Start]** key, 22  
Suspend Copy  
    *Finisher 3000B (100-Sheet Staples)*, 99  
System Auto Reset Timer, 59  
System Reset, 30

## T

---

Tab Sheet Holder, 152  
Text  
    *Deleting*, 134  
    *Entering*, 134  
Timer Settings, 58  
Toner, 126  
    *Adding*, 100  
    *Handling*, 126  
    *Replacing*, 102  
    *Storing*, 126  
To register an FTP folder, 81  
To register an SMB folder, 78  
Tray Paper Settings, 55  
Tray Paper Size  
    *Tray 2*, 56  
    *Tray 3*, 56  
Troubleshooting, 93  
Turning Off  
    *Main Power*, 26  
    *Power*, 26  
Turning On  
    *Main Power*, 25  
    *Power*, 25

## U

---

Use LDAP Server, 65  
User Authentication Management, 60  
User Name  
    *Changing*, 39  
    *Registering or changing*, 37  
User Tools  
    *Changing defaults*, 50  
    *Exiting*, 50  
**[User Tools/Counter]** key, 21  
User Tools Menu (System Settings), 47  
User Tools (System Settings), 47  
Using  
    *Document Server*, 36  
Using FTP to Connect, 81  
Using SMB to Connect, 78

## V

---

Ventilation holes, 18

## W

---

Warm Up Notice  
    (Copier/Document Server), 51  
Web browser, 44  
Weekly Timer, 60  
Weekly Timer Code, 60  
Where to Put Your Machine, 127

## Z

---

Z-folding Unit, 149  
Z-folding unit, 19  
Z-fold position, 55

MEMO

MEMO

In accordance with IEC 60417, this machine uses the following symbols for the main power switch:

**I** means **POWER ON.**

**⏻** means **STAND BY.**

Type for DSm651/LD151/Aficio 2051  
Type for DSm660/LD160/Aficio 2060  
Type for DSm675/LD175/Aficio 2075  
Printed in Japan

AE  B141-6708A



B1416708A



## Free Manuals Download Website

<http://myh66.com>

<http://usermanuals.us>

<http://www.somanuals.com>

<http://www.4manuals.cc>

<http://www.manual-lib.com>

<http://www.404manual.com>

<http://www.luxmanual.com>

<http://aubethermostatmanual.com>

Golf course search by state

<http://golfingnear.com>

Email search by domain

<http://emailbydomain.com>

Auto manuals search

<http://auto.somanuals.com>

TV manuals search

<http://tv.somanuals.com>