

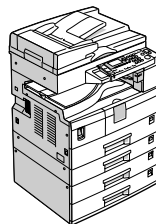

MP 1600L/2000L
MP 1600L/2000L
Aficio™ MP 1600L/2000L
IS 2316L/2320L

Operating Instructions General Settings Guide



-
- 1** Getting Started
 - 2** Combined Function Operations
 - 3** User Tools (System Settings)
 - 4** Troubleshooting
 - 5** Other Functions
 - 6** Security
 - 7** Specifications

Read this manual carefully before you use this machine and keep it handy for future reference. For safe and correct use, be sure to read the Safety Information in the "Copy Reference" before using the machine.

Introduction

This manual contains detailed instructions and notes on the operation and use of this machine. For your safety and benefit, read this manual carefully before using the machine. Keep this manual in a handy place for quick reference.

Important

Contents of this manual are subject to change without prior notice. In no event will the company be liable for direct, indirect, special, incidental, or consequential damages as a result of handling or operating the machine.

Notes:

Some illustrations in this manual might be slightly different from the machine.

Certain options might not be available in some countries. For details, please contact your local dealer.

Laser Safety:

This machine is considered a class 1 laser device, safe for office/EDP use. The machine contains a 5-milliwatt, 760-800 nanometer wavelength, GaAlAs laser diode. Direct (or indirect reflected) eye contact with the laser beam might cause serious eye damage. Safety precautions and interlock mechanisms have been designed to prevent any possible laser beam exposure to the operator.

The following label is attached on the back side of the machine.



Caution:

Use of controls or adjustments or performance of procedures other than those specified in this manual might result in hazardous radiation exposure.

Notes:

The model names of the machines do not appear in the following pages. Check the type of your machine before reading this manual. (For details, see p.ii "Machine Types".)

- Type 1: MP 1600L/MP 1600L/Aficio MP 1600L/IS 2316L
- Type 2: MP 2000L/MP 2000L/Aficio MP 2000L/IS 2320L

Certain types might not be available in some countries. For details, please contact your local dealer.

Two kinds of size notation are employed in this manual. With this machine refer to the metric version.

For good copy quality, the supplier recommends that you use genuine toner from the supplier.

The supplier shall not be responsible for any damage or expense that might result from the use of parts other than genuine parts from the supplier with your office products.

Power Source

220 - 240V, 50/60Hz, 7A or more

Please be sure to connect the power cord to a power source as above. For details about power source, see "Power Connection" in the Copy Reference.

Manuals for This Machine

The following manuals describe the operational procedures of this machine. For particular functions, see the relevant parts of the manual.

 **Note**

- Manuals provided are specific to machine type.
- Adobe Acrobat Reader is necessary to view the manuals as a PDF file.
- Two CD-ROMs are provided:
 - CD-ROM 1 “Operating Instructions for Printer/Scanner”
 - CD-ROM 2 “Scanner Driver & Document Management Utilities”

❖ **General Settings Guide (this manual)**

Provides an overview of the machine and describes System Settings (paper trays, Key Operator Tools, etc.), and troubleshooting.

❖ **Network Guide**

Describes procedures for configuring the machine and computers in a network environment.

❖ **Copy Reference**

Describes operations, functions, and troubleshooting for the machine's copier function.

❖ **Printer/Scanner Reference**

Describes system settings, functions, troubleshooting and operations for the machine's printer and scanner function.

Machine Types

This machine comes in two models which vary by copy speed.

	Type 1	Type 2
Copy speed	16 copies/minute (A4 \square , 8 ¹ / ₂ " × 11" \square)	20 copies/minute (A4 \square , 8 ¹ / ₂ " × 11" \square)
Duplex unit	—	○

○: Can be used with this type

—: Cannot be used with this type

TABLE OF CONTENTS

Manuals for This Machine	i
Machine Types	ii
Copyrights and Trademarks	1
Trademarks	1
Information about Installed Software	2
How to Read This Manual	7
Name of Major Option	7
ENERGY STAR Program	8

1. Getting Started

Guide to Components	11
Options	13
External Options	13
Control Panel	14
Display	15
Reading the Display and Using Keys	16

2. Combined Function Operations

Changing Modes	17
Multi-Access	18

3. User Tools (System Settings)

User Tools Menu (System Settings)	21
Accessing User Tools (System Settings)	23
Changing Default Settings	23
Quitting User Tools	24
Settings You Can Change with User Tools	25
General Features	25
Tray Paper Settings	27
Timer Settings	28
Key Operator Tools	30
User Code	33
Registering a New User Code	33
Changing a User Code	34
Deleting a User Code	34
Displaying the Counter for Each User Code	35
Printing the Counter for Each User Code	36
Clearing the Counter	36

4. Troubleshooting

If Your Machine Does Not Operate As You Want	37
⚠ Clearing Misfeeds	39
Changing the Paper Size	42
Changing the Paper Size of the Paper Tray	42
Changing the Paper Size in the Optional Paper Tray Unit	44

5. Other Functions

Other Functions	47
Displaying the Total Counter	47
Changing the Language	47

6. Security

Security	49
Primary Security Functions	49
Operating Environment and Notes	50
Operating Environment	50
For Administrator	50
For User	50

7. Specifications

Main Unit	51
Options	55
Exposure Glass Cover	55
Auto Document Feeder (ADF)	55
Auto Document Feeder capable of scanning both sides of a sheet (ARDF)	56
Internal Tray 2 (1 bin tray)	56
Paper Tray Unit (1-tray type)	57
Paper Tray Unit (2-tray type)	58
Copy Paper	59
Recommended Paper Sizes and Types	59
Unusable Paper	61
Paper Storage	62
INDEX	63

Copyrights and Trademarks

Trademarks

Microsoft[®], Windows[®] and Windows NT[®] are registered trademarks of Microsoft Corporation in the United States and/or other countries.

Acrobat[®] is a registered trademark of Adobe Systems Incorporated.

Bluetooth[™] is a trademark of the Bluetooth SIG, Inc. (Special Interest Group) and is used by RICOH Company Limited under license.

Copyright ©2001 Bluetooth SIG, Inc.

The Bluetooth Trademarks are owned by Bluetooth SIG, Inc. USA.

Other product names used herein are for identification purposes only and might be trademarks of their respective companies. We disclaim any and all rights to those marks.

The proper names of the Windows operating systems are as follows:

- The product name of Windows[®] 95 is Microsoft[®] Windows[®] 95
- The product name of Windows[®] 98 is Microsoft[®] Windows[®] 98
- The product name of Windows[®] Me is Microsoft[®] Windows[®] Millennium Edition (Windows Me)
- The product names of Windows[®] 2000 are as follows:
 - Microsoft[®] Windows[®] 2000 Professional
 - Microsoft[®] Windows[®] 2000 Server
 - Microsoft[®] Windows[®] 2000 Advanced Server
- The product names of Windows[®] XP are as follows:
 - Microsoft[®] Windows[®] XP Home Edition
 - Microsoft[®] Windows[®] XP Professional
- The product names of Windows Server[™] 2003 are as follows:
 - Microsoft[®] Windows Server[™] 2003 Standard Edition
 - Microsoft[®] Windows Server[™] 2003 Enterprise Edition
 - Microsoft[®] Windows Server[™] 2003 Web Edition
- The product names of Windows NT[®] 4.0 are as follows:
 - Microsoft[®] Windows NT[®] Workstation 4.0
 - Microsoft[®] Windows NT[®] Server 4.0

Information about Installed Software

expat

- The software including controller, etc. (hereinafter “software”) installed on this product uses the expat Version 1.95.2 (hereinafter “expat”) under the conditions mentioned below.
- The product manufacturer provides warranty and support to the software of the product including the expat, and the product manufacturer makes the initial developer and copyright holder of the expat, free from these obligations.
- Information relating to the expat is available at:
<http://expat.sourceforge.net/>

Copyright (c) 1998, 1999, 2000 Thai Open Source Software Centre, Ltd. and Clark Cooper.

Permission is hereby granted, free of charge, to any person obtaining a copy of this software and associated documentation files (the “Software”), to deal in the Software without restriction, including without limitation the rights to use, copy, modify, merge, publish, distribute, sublicense, and/or sell copies of the Software, and to permit persons to whom the Software is furnished to do so, subject to the following conditions:

The above copyright notice and this permission notice shall be included in all copies or substantial portions of the Software.

THE SOFTWARE IS PROVIDED “AS IS”, WITHOUT WARRANTY OF ANY KIND, EXPRESS OR IMPLIED, INCLUDING BUT NOT LIMITED TO THE WARRANTIES OF MERCHANTABILITY, FITNESS FOR A PARTICULAR PURPOSE AND NONINFRINGEMENT. IN NO EVENT SHALL THE AUTHORS OR COPYRIGHT HOLDERS BE LIABLE FOR ANY CLAIM, DAMAGES OR OTHER LIABILITY, WHETHER IN AN ACTION OF CONTRACT, TORT OR OTHERWISE, ARISING FROM, OUT OF OR IN CONNECTION WITH THE SOFTWARE OR THE USE OR OTHER DEALINGS IN THE SOFTWARE.

NetBSD

1. Copyright Notice of NetBSD

For all users to use this product:

This product contains NetBSD operating system:

For the most part, the software constituting the NetBSD operating system is not in the public domain; its authors retain their copyright.

The following text shows the copyright notice used for many of the NetBSD source code. For exact copyright notice applicable for each of the files/binaries, the source code tree must be consulted.

A full source code can be found at <http://www.netbsd.org/>.

Copyright © 1999, 2000 The NetBSD Foundation, Inc.

All rights reserved.

Redistribution and use in source and binary forms, with or without modification, are permitted provided that the following conditions are met:

- ① Redistributions of source code must retain the above copyright notice, this list of conditions and the following disclaimer.
- ② Redistributions in binary form must reproduce the above copyright notice, this list of conditions and the following disclaimer in the documentation and/or other materials provided with the distribution.
- ③ All advertising materials mentioning features or use of this software must display the following acknowledgment:
This product includes software developed by The NetBSD Foundation, Inc. and its contributors.
- ④ Neither the name of The NetBSD Foundation nor the names of its contributors may be used to endorse or promote products derived from this software without specific prior written permission.

THIS SOFTWARE IS PROVIDED BY THE NETBSD FOUNDATION, INC. AND CONTRIBUTORS "AS IS" AND ANY EXPRESS OR IMPLIED WARRANTIES, INCLUDING, BUT NOT LIMITED TO, THE IMPLIED WARRANTIES OF MERCHANTABILITY AND FITNESS FOR A PARTICULAR PURPOSE ARE DISCLAIMED. IN NO EVENT SHALL THE FOUNDATION OR CONTRIBUTORS BE LIABLE FOR ANY DIRECT, INDIRECT, INCIDENTAL, SPECIAL, EXEMPLARY, OR CONSEQUENTIAL DAMAGES (INCLUDING, BUT NOT LIMITED TO, PROCUREMENT OF SUBSTITUTE GOODS OR SERVICES; LOSS OF USE, DATA, OR PROFITS; OR BUSINESS INTERRUPTION) HOWEVER CAUSED AND ON ANY THEORY OF LIABILITY, WHETHER IN CONTRACT, STRICT LIABILITY, OR TORT (INCLUDING NEGLIGENCE OR OTHERWISE) ARISING IN ANY WAY OUT OF THE USE OF THIS SOFTWARE, EVEN IF ADVISED OF THE POSSIBILITY OF SUCH DAMAGE.

2. Authors Name List

All product names mentioned herein are trademarks of their respective owners. The following notices are required to satisfy the license terms of the software that we have mentioned in this document:

- This product includes software developed by the University of California, Berkeley and its contributors.
- This product includes software developed by Jonathan R. Stone for the NetBSD Project.
- This product includes software developed by the NetBSD Foundation, Inc. and its contributors.
- This product includes software developed by Manuel Bouyer.
- This product includes software developed by Charles Hannum.
- This product includes software developed by Charles M. Hannum.
- This product includes software developed by Christopher G. Demetriou.
- This product includes software developed by Tools GmbH.
- This product includes software developed by Terrence R. Lambert.
- This product includes software developed by Adam Glass and Charles Hannum.
- This product includes software developed by Theo de Raadt.

- This product includes software developed by Jonathan Stone and Jason R. Thorpe for the NetBSD Project.
- This product includes software developed by the University of California, Lawrence Berkeley Laboratory and its contributors.
- This product includes software developed by Christos Zoulas.
- This product includes software developed by Christopher G. Demetriou for the NetBSD Project.
- This product includes software developed by Paul Kranenburg.
- This product includes software developed by Adam Glass.
- This product includes software developed by Jonathan Stone.
- This product includes software developed by Jonathan Stone for the NetBSD Project.
- This product includes software developed by Winning Strategies, Inc.
- This product includes software developed by Frank van der Linden for the NetBSD Project.
- This product includes software developed for the NetBSD Project by Frank van der Linden.
- This product includes software developed for the NetBSD Project by Jason R. Thorpe.
- The software was developed by the University of California, Berkeley.
- This product includes software developed by Chris Provenzano, the University of California, Berkeley, and contributors.

Sablotron

Sablotron (Version 0.82) Copyright (c) 2000 Ginger Alliance Ltd. All Rights Reserve

a) The application software installed on this product includes the Sablotron software Version 0.82 (hereinafter, "Sablotron 0.82"), with modifications made by the product manufacturer. The original code of the Sablotron 0.82 is provided by Ginger Alliance Ltd., the initial developer, and the modified code of the Sablotron 0.82 has been derived from such original code provided by Ginger Alliance Ltd.

b) The product manufacturer provides warranty and support to the application software of this product including the Sablotron 0.82 as modified, and the product manufacturer makes Ginger Alliance Ltd., the initial developer of the Sablotron 0.82, free from these obligations.

c) The Sablotron 0.82 and the modifications thereof are made available under the terms of Mozilla Public License Version 1.1 (hereinafter, "MPL 1.1"), and the application software of this product constitutes the "Larger Work" as defined in MPL 1.1. The application software of this product except for the Sablotron 0.82 as modified is licensed by the product manufacturer under separate agreement(s).

d) The source code of the modified code of the Sablotron 0.82 is available at: <http://support-download.com/services/device/sablot/notice082.html>.

e) The source code of the Sablotron software is available at: <http://www.ginger-all.com>.

f) MPL 1.1 is available at: <http://www.mozilla.org/MPL/MPL-1.1.html>.

JPEG LIBRARY

- The software installed on this product is based in part on the work of the Independent JPEG Group.

SASL

CMU libsasl

Tim Martin

Rob Earhart

Rob Siemborski

Copyright (c) 2001 Carnegie Mellon University. All rights reserved.

Redistribution and use in source and binary forms, with or without modification, are permitted provided that the following conditions are met:

- ① Redistributions of source code must retain the above copyright notice, this list of conditions and the following disclaimer.
- ② Redistributions in binary form must reproduce the above copyright notice, this list of conditions and the following disclaimer in the documentation and/or other materials provided with the distribution.
- ③ The name "Carnegie Mellon University" must not be used to endorse or promote products derived from this software without prior written permission. For permission or any other legal details, please contact:

Office of Technology Transfer
Carnegie Mellon University
5000 Forbes Avenue
Pittsburgh, PA 15213-3890
(412) 268-4387, fax: (412) 268-7395
tech-transfer@andrew.cmu.edu

- ④ Redistributions of any form whatsoever must retain the following acknowledgment:
"This product includes software developed by Computing Services at Carnegie Mellon University (<http://www.cmu.edu/computing/>)."

CARNEGIE MELLON UNIVERSITY DISCLAIMS ALL WARRANTIES WITH REGARD TO THIS SOFTWARE, INCLUDING ALL IMPLIED WARRANTIES OF MERCHANTABILITY AND FITNESS, IN NO EVENT SHALL CARNEGIE MELLON UNIVERSITY BE LIABLE FOR ANY SPECIAL, INDIRECT OR CONSEQUENTIAL DAMAGES OR ANY DAMAGES WHATSOEVER RESULTING FROM LOSS OF USE, DATA OR PROFITS, WHETHER IN AN ACTION OF CONTRACT, NEGLIGENCE OR OTHER TORTIOUS ACTION, ARISING OUT OF OR IN CONNECTION WITH THE USE OR PERFORMANCE OF THIS SOFTWARE.

MD4

Copyright (C) 1990-2, RSA Data Security, Inc. All rights reserved.

License to copy and use this software is granted provided that it is identified as the "RSA Data Security, Inc. MD4 Message-Digest Algorithm" in all material mentioning or referencing this software or this function.

License is also granted to make and use derivative works provided that such works are identified as "derived from the RSA Data Security, Inc. MD4 Message-Digest Algorithm" in all material mentioning or referencing the derived work.

RSA Data Security, Inc. makes no representations concerning either the merchantability of this software or the suitability of this software for any particular purpose. It is provided "as is" without express or implied warranty of any kind.

These notices must be retained in any copies of any part of this documentation and/or software.

MD5

Copyright (C) 1991-2, RSA Data Security, Inc. Created 1991. All rights reserved.

License to copy and use this software is granted provided that it is identified as the "RSA Data Security, Inc. MD5 Message-Digest Algorithm" in all material mentioning or referencing this software or this function.

License is also granted to make and use derivative works provided that such works are identified as "derived from the RSA Data Security, Inc. MD5 Message-Digest Algorithm" in all material mentioning or referencing the derived work.

RSA Data Security, Inc. makes no representations concerning either the merchantability of this software or the suitability of this software for any particular purpose. It is provided "as is" without express or implied warranty of any kind.

These notices must be retained in any copies of any part of this documentation and/or software.

How to Read This Manual

Symbols

The following set of symbols is used in this manual.

WARNING:

This symbol indicates a potentially hazardous situation that might result in death or serious injury when you misuse the machine without following the instructions under this symbol. Be sure to read the instructions, all of which are described in the Safety Information section.

CAUTION:

This symbol indicates a potentially hazardous situation that might result in minor or moderate injury or property damage that does not involve personal injury when you misuse the machine without following the instructions under this symbol. Be sure to read the instructions, all of which are described in the Safety Information section.

* The statements above are notes for your safety.

Important

If this instruction is not followed, paper might be misfed, originals might be damaged, or data might be lost. Be sure to read this.

Preparation

This symbol indicates information or preparations required prior to operating.

Note

This symbol indicates precautions for operation, or actions to take after abnormal operation.

Limitation

This symbol indicates numerical limits, functions that cannot be used together, or conditions in which a particular function cannot be used.

Reference

This symbol indicates a reference.

[]

Keys that appear on the machine's display panel.

[]

Keys built into the machine's control panel.

Name of Major Option

Major option of this machine is referred to as follow in this manual:

- Auto Document Feeder → ADF
- Auto Document Feeder capable of scanning both sides of a sheet → ARDF

ENERGY STAR Program

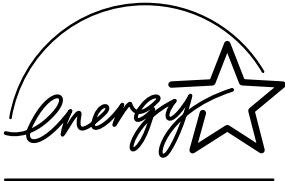
<p>ENERGY STAR®</p> 	<p>As an ENERGY STAR Partner, we have determined that this machine model meets the ENERGY STAR Guidelines for energy efficiency.</p>
---	--

The ENERGY STAR Guidelines intend to establish an international energy-saving system for developing and introducing energy-efficient office equipment to deal with environmental issues, such as global warming.

When a product meets the ENERGY STAR Guidelines for energy efficiency, the Partner shall place the ENERGY STAR logo onto the machine model.

This product was designed to reduce the environmental impact associated with office equipment by means of energy-saving features, such as Low-power mode.

- **Low Power mode**
This product automatically lowers its power consumption 1 minute after finishing the last copy or print job. Printing is still possible in Low Power mode, but to make copies, you have to press the operation switch first. For details about how to change the interval between last job and Low Power mode, see p.29 “Energy Saver Timer”.
 - **Sleep mode**
This product automatically lowers its power consumption even further 1 minute after finishing the last copy or print job. Printing is still possible in Sleep mode, but to make copies, you have to press the operation switch first. For details about how to change the interval between last job and Sleep mode, see p.28 “Auto Off Timer”.
-  **Note**
- If you want to operate this product while it is in either of these modes, do one of the following:
 - Turn on the operation switch.
 - Place originals in the ADF or ARDF.
 - Lift the exposure glass cover, ADF, or ARDF.
 - **Duplex Priority (Type 2 only)**
To conserve paper, the Duplex function (1-Sided → 2-Sided) can be selected preferentially when you turn on the operation switch or the main power switch, press the **[Clear Modes]** key, or the machine resets itself automatically. To change Duplex Priority mode, see *Copy Reference*.

Specifications

Low Power mode	Power consumption	45 W
	Default interval	1 minute
	Recovery time	Less than 10 seconds
Sleep mode	Power consumption	Less than 10 W
	Default interval	1 minute
	Recovery time	Less than 10 seconds
Duplex Priority (Type 2 only)		1 Sided → 1 Sided

Recycled Paper

In accordance with the ENERGY STAR Program, we recommend use of recycled paper which is environmentally friendly. Please contact your sales representative for recommended paper.

1. Getting Started

Guide to Components

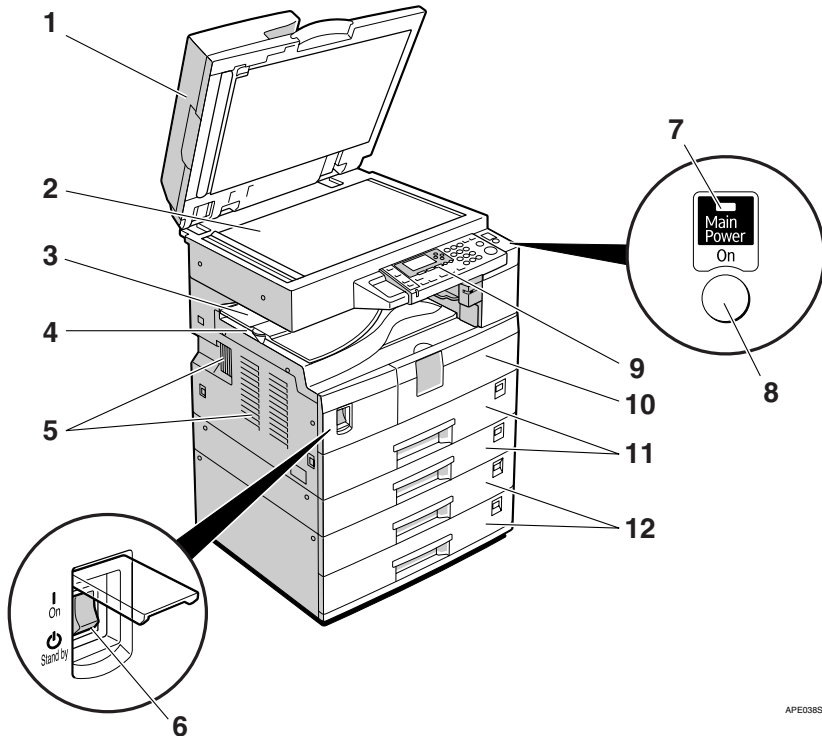

1. Exposure glass cover (optional), ADF (optional), or ARDF (optional).
See p.13 “External Options”
(The illustration shows the ARDF.)

2. Exposure glass
Place originals here face down.

3. Internal tray 2 (1 bin tray) (optional)

The indicator lights when paper is delivered to internal tray 2. If internal tray 2 has not been installed, the indicator does not light. See p.13 “External Options”.

Note

□ When paper larger than A3 is delivered, release the 1 bin tray stand, and then pull out the tray extension.

4. Internal tray

Copied or printed paper is delivered here.

5. Ventilation holes

Prevents overheating. Do not obstruct the ventilation holes by placing objects near them or leaning things against them. If the machine overheats, a fault might occur.

APE0385

6. Main power switch

If the machine does not operate after turning on the operation switch, check the main power switch is turned on. If it is off, turn it on.

7. Main power indicator

Lights when the main power switch is turned on, and goes off when the switch is turned off.

8. Operation switch (On Indicator)

Press to turn the power on (the On indicator lights). To turn the power off, press again (the On indicator goes off).

9. Control panel

See p.14 "Control Panel".

10. Front cover

Open to access the inside of the machine.

11. Paper tray

Load paper here.

12. Paper tray unit (optional)

See p.13 "External Options".

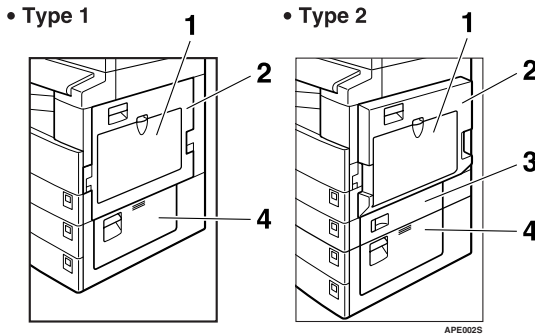

1. Bypass tray

Use to copy onto OHP transparencies, adhesive labels, translucent paper, envelopes, and custom size paper.

2. Right cover

Open this cover to remove jammed paper fed from the paper tray.

3. Lower right cover (Type 2 only)

Open this cover to remove jammed paper fed from the paper tray unit.

4. Lower right cover

Open this cover to remove jammed paper from the optional paper tray unit.

Note

- This tray is for reversing paper when using the duplex function (Type 2 only). Do not pull the paper out from here.

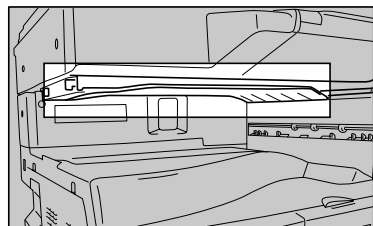

Options

External Options

1

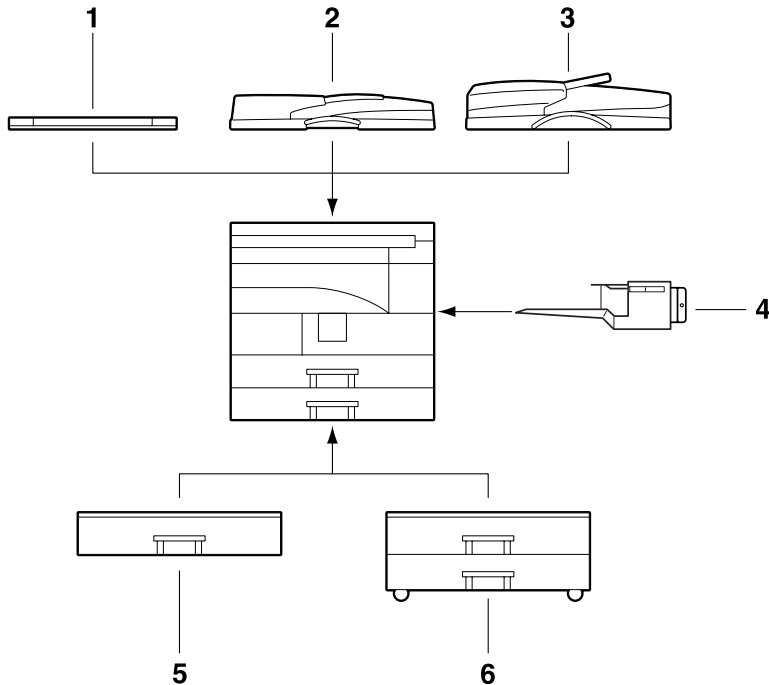

APE009S

1. Exposure glass cover

Lower this cover over originals.

2. ADF

Place stacks of originals here.

They will feed in automatically.

3. ARDF

Place stacks of originals here.

They will feed in automatically. This document feeder can be used for two-sided originals.

4. Internal tray 2 (1 bin tray)

If you select this as the output tray, copied paper is delivered here face down.

Note

- Internal tray 2 can only be installed for Type 2.

5. Paper tray unit (1-tray type)

Holds 500 sheets.

6. Paper tray unit (2-tray type)

Holds up to 1,000 sheets of paper. Each paper tray holds 500 sheets.

Control Panel

This illustration shows the control panel of the machine with options fully installed.

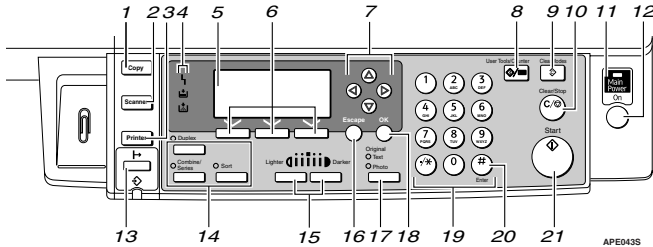

1. [Copy] key

Press to activate the copy function.

2. [Scanner] key



Press to activate the scanner function.

3. [Printer] key

Press to activate the printer function.

4. Indicators

Display errors and machine status.

: Error indicator. See *Network Guide* and see p.39 “ Clearing Misfeeds”.

: Load Paper indicator. See *Copy Reference*.

: Add Toner indicator. See *Copy Reference*.

5. Display

Displays operation status and messages.

6. Selection keys

Correspond to items on the display. Press to select the corresponding item.

7. Scroll keys

Press to select an item.

: scroll upward

: scroll downward

: scroll right

: scroll left

8. [User Tools/Counter] key

• User Tools

Press to change default or operation parameters according to requirement. See p.23 “Accessing User Tools (System Settings)”.

• Counter

Press to check or print the counter value. See p.47 “Other Functions”.

9. [Clear Modes] key

Press to clear the current settings.

10. [Clear/Stop] key

• Clear:

Clears an entered numeric value.

• Stop:

Stops a job in progress, such as scanning or printing.

11. Main power indicator

The main power indicator lights when the main power switch is turned on.

Important

- Do not turn off the main power switch while the On indicator is lit or blinking. Doing so may damage the memory.

12. Operation switch (On Indicator)

Press to turn the power on. The On indicator lights. To turn the power off, press again.

13. [On Line] key**Reference***Printer/Scanner Reference***14. Copier function keys****Reference***Copy Reference***15. [Lighter] and [Darker] keys**

Press to change the image density setting. Select the image density in five increments, Lighter to Darker.

16. [Escape] key

Press to cancel an operation or return to the previous display.

17. [Original Type] key

Press to select the original type registered in [Original Type 1 (Text)] or [Original Type 2 (Photo)]. When the original type is selected, the corresponding indicator lights.

18. [OK] key

Press to set a selected item or an entered numeric value.

19. Number keys

Press to enter numeric values.

20. [#] key

Press to set a selected item or an entered numeric value.

21. [Start] key

Press to start copying, printing, or scanning or sending.

Display

The display panel shows machine status, error messages, and function menus.

Important

A force or impact of more than 30 N (about 3 kgf) will damage the display.

The copy display is set as the default screen when the machine is turned on.

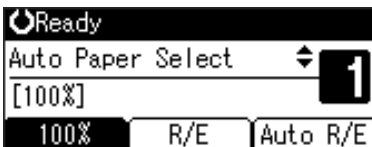

When you select or specify an item on the display, it is highlighted like **Auto R/E**.

Reading the Display and Using Keys

This section explains how to read the display and use the Selection keys.

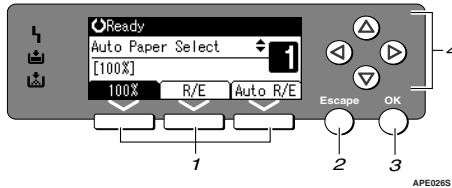

1. Selection keys

Correspond to items at the bottom line on the display.

Example: The Copy display

- When the instruction “press [100%]” appears in this manual, press the left selection key.
- When the instruction “press [R/E]” appears in this manual, press the centre selection key.
- When the instruction “press [Auto R/E]” appears in this manual, press the right selection key.

2. [Escape] key

Press to cancel an operation or return to the previous display.

3. [OK] key

Press to set a selected item or an entered numeric value.

4. Scroll keys

Press to move the cursor in each direction, step by step.

When the [▲], [▼], [◀], or [▶] key appears in this manual, press the scroll key of the same direction.

Common key operations

The following keys are common to all screens:

❖ Key list

[Cancel]	Deletes a selected function or entered values, and then the previous display returns.
[Exit]	The previous display returns.
[Stop]	Stops a job in progress.
[Yes]	Acknowledges a selected function or an entered values.
[Stop]	Cancels a selected function or entered values, and then the previous display returns.

2. Combined Function Operations

Changing Modes

Note

- You cannot switch modes in any of the following situations:
 - During immediate transmission
 - When accessing User Tools
 - While scanning an original
- The copying screen is displayed as default when the power is turned on. You can change this default setting. See p.25 “Function Priority”.

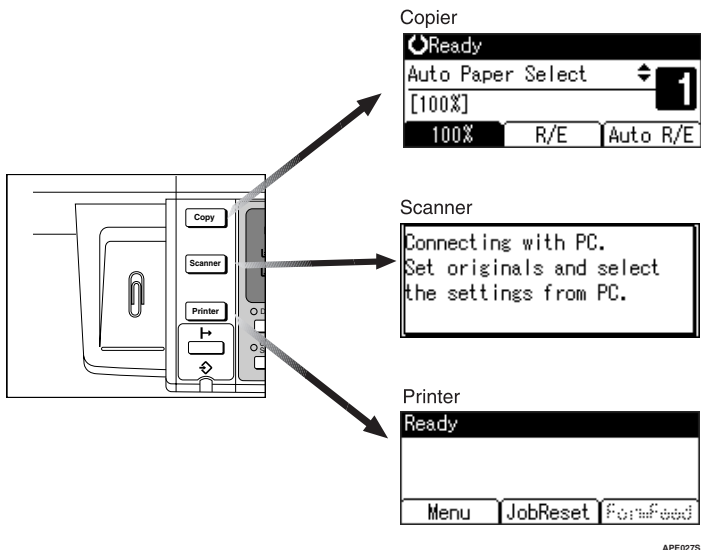

System Reset

The machine returns automatically to its initial condition when the job is finished, after a certain period of time has elapsed. This function is called “System Reset”.

Note

- You can change the System Reset time. See p.29 “System Auto Reset Timer”.

Multi-Access

You can carry out another job using a different function while the current job is being performed. Performing multiple functions simultaneously like this is called “Multi-accessing”.

This allows you to handle jobs efficiently, regardless of how the machine is being used. For example:

- You can make copies while receiving printer data.
- While printing, you can make operations for copying.

Note

- See p.25 “Print Priority” for setting function priority. As default, **[Display mode]** is set to first priority.
- You can specify the output tray where documents are delivered. For details about how to specify the output tray for each function, see the following descriptions:
 - p.26 “Output: Copier (copier)”
 - p.26 “Output: Printer (printer)”

Function compatibility

The chart shows function compatibility when print priority is set to “Interleave”. See p.25 “Print Priority”.

		Mode after you select		Copy		Printer		Scanner	
						Print			
Mode before you select		Using the control panel	Copying	Receive Data	Printing	Using the control panel	Scanning		
Copy	Using the control panel	×	×	○	○	●	●		
	Copying	×	×	○	○	●	●	*1	
Printer	Receive Data	○	○	△	△	○	○		
	Printing	○	○	○	△	○	○		
Scanner	Using the control panel	●	●	○	○	×	×		
	Scanning	●	● *1	○	○	×	×		

○...means that these functions can be used together.

●...means that you can interrupt the current job with Function keys to proceed to a subsequent job.

△...means that another job will automatically start after the current job is finished.

×...means that you must manually start another job after the current job is finished (i.e., these functions cannot be used together).

*1 You can scan a document once the preceding job documents are all scanned.

3. User Tools (System Settings)

User Tools Menu (System Settings)









Reference

For details about parallel interface, see *Printer/Scanner Reference*.

❖ General Features (See p.25 “General Features”.)

	Default
Panel Key Sound	On
Copy Count Display	Up
Function Priority	Copier
Print Priority	Display mode
Output: Copier	Internal tray 1
Output: Printer	Internal tray 2
Display Contrast	Centre
Key Repeat	On
Measurement Unit	Metric version: <i>mm</i>
	Inch version: <i>inch</i>

❖ Tray Paper Settings (See p.27 “Tray Paper Settings”.)

	Default
Tray Paper Size:Tray 1	Metric version: $8\frac{1}{2}'' \times 11''$ 
	Inch version: A4 
Tray Paper Size:Tray 2	Metric version: A5  (Type 1), $8\frac{1}{2}'' \times 11''$  (Type 2)
	Inch version: A5  (Type 1), A4  (Type 2)
Tray Paper Size:Tray 3	A5 
Tray Paper Size:Tray 4 (Type 2 or 3 only)	A5 
Paper Type: Bypass tray	Thick Paper
Ppr Tray Priority: Copier	Tray 1
Ppr Tray Priority: Printer	Tray 1

❖ **Timer Settings (See p.28 “Timer Settings”).**

	Default
Auto Off Timer	<i>1 min.</i>
Energy Saver Timer	<i>1 min.</i>
System Auto Reset Timer	<i>60 sec.</i>
Copier Auto Reset Timer	<i>60 sec.</i>

❖ **Key Operator Tools (See p.30 “Key Operator Tools”).**

	Default	
User Code Man.: Copier	<i>Off</i>	
Key Counter Management	<i>All Off</i>	
Key Operator Code	<i>Off</i>	
Display/Print Counter	—	
Counter per User Code	Display	—
	Print	—
	Clear	—
Program/Change User Code	Program	
	Change	
	Delete	
AOF (Always On)	<i>On</i>	

Accessing User Tools (System Settings)

This section is for key operators in charge of this machine.

User Tools allow you to change or set defaults.

Note

- ❑ Operations for system settings differ from normal operations. Always quit User Tools when you have finished. See p.24 “Quitting User Tools”.
- ❑ Any changes you make with User Tools remain in effect even if the main power switch or operation switch is turned off, or the **[Clear Modes]** key is pressed.

Changing Default Settings

Note

- ❑ If a key operator code is already set, the key operator code entry display appears. Enter the key operator code, and then press the **[OK]** key. See p.30 “Key Operator Code”.

1 Press the **[User Tools/Counter]** key.

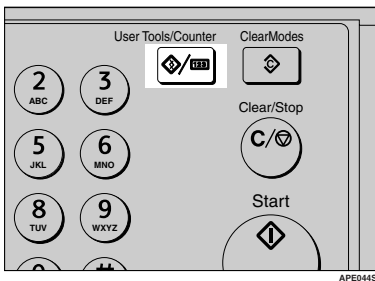

2 Select **[System Settings]** using **[▲]** or **[▼]**, and then press the **[OK]** key.

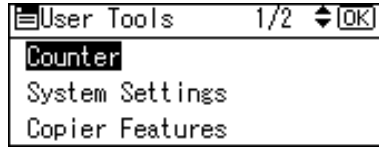

3 Select the menu using **[▲]** or **[▼]**, and then press the **[OK]** key.

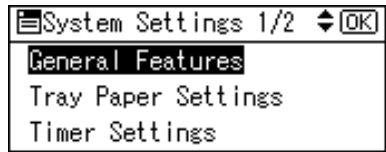

Reference

p.21 “User Tools Menu (System Settings)”.

4 Select the item using **[▲]** or **[▼]**, and then press the **[OK]** key.

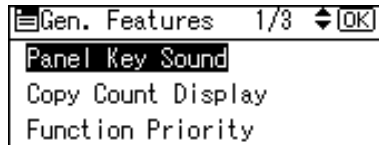

5 Change settings by following instructions on the display, and then press the **[OK]** key.

Note

- ❑ To cancel changes made to settings and return to the initial display, press the **[User Tools/Counter]** key.

Quitting User Tools

1 Press the [User Tools/Counter] key.

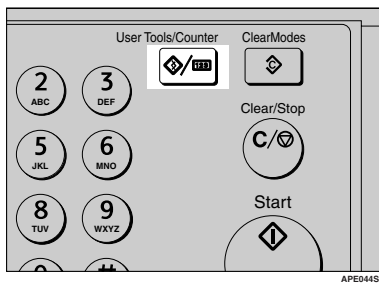

3

Settings You Can Change with User Tools

Reference

To access User Tools, see p.23 “Accessing User Tools (System Settings)”.

General Features

❖ Panel Key Sound

The beeper (key tone) sounds when a key is pressed.

Note

Default: *On*

❖ Copy Count Display

The copy counter can be set to show the number of copies made (count up), or the number of copies yet to be made (count down).

Note

Default: *Up (count up)*

❖ Function Priority

You can specify the mode to be displayed immediately after the operation switch is turned on, or when System Reset mode is turned on.

Note

Default: *Copier*

❖ Print Priority

Set the print priority for each mode.

Reference

p.18 “Multi-Access”

Note

Default: *Display mode*

When **[Interleave]** is selected, the current print job will be interrupted after a maximum of five sheets.

When the optional Internal tray 2 is installed on the machine, you can specify an output tray for document. For details about how to specify an output tray for each function, see the following sections:

- p.26 “Output: Copier (copier)”
- p.26 “Output: Printer (printer)”

❖ **Output: Copier (copier)**

You can specify a tray to which documents are delivered.

 **Note**

Default: *Internal tray 1*

❖ **Output: Printer (printer)**

You can specify a tray to which documents are delivered.

 **Note**

Default: *Internal tray 2*

The output trays set on the printer driver have priority over the output tray specified above.

❖ **Display Contrast**

You can adjust the brightness of the display.

❖ **Key Repeat**

You can select whether or not to use the key repeat function.

 **Note**

Default: *On*

❖ **Measurement Unit**

You can switch the measurement between “mm” and “inch”.

 **Note**

Default:

- Metric version: *mm*
- Inch version: *inch*

Output tray settings

 **Limitation**

You cannot use the Internal tray 2 as the output tray when copying from the bypass tray.

Tray Paper Settings

❖ Tray Paper Size: Tray 1–4

Select the size of the paper loaded in the paper tray.

- Type 1
 - The paper sizes you can set for Tray 1 are as follows:
A3, B4JIS (Japanese Industrial Standard), A4, B5JIS, A5, 11" × 17", 8¹/₂" × 14", 8¹/₂" × 13", 8¹/₄" × 14", 8¹/₄" × 13", 8" × 13", 8¹/₂" × 11", 7¹/₄" × 10¹/₂", 5¹/₂" × 8¹/₂", 8K, 16K
 - The paper sizes you can set for Tray 2, 3 are as follows:
A3, B4JIS, A4, B5JIS, A5, 11" × 17", 8¹/₂" × 14", 8¹/₂" × 13", 8¹/₄" × 14", 8¹/₄" × 13", 8" × 13", 8¹/₂" × 11", 7¹/₄" × 10¹/₂", 5¹/₂" × 8¹/₂", 8K, 16K
- Type 2
 - The paper sizes you can set for Tray 1, 2 are as follows:
A3, B4JIS (Japanese Industrial Standard), A4, B5JIS, A5, 11" × 17", 8¹/₂" × 14", 8¹/₂" × 13", 8¹/₄" × 14", 8¹/₄" × 13", 8" × 13", 8¹/₂" × 11", 7¹/₄" × 10¹/₂", 5¹/₂" × 8¹/₂", 8K, 16K
 - The paper sizes you can set for Tray 3, 4 are as follows:
A3, B4JIS, A4, B5JIS, A5, 11" × 17", 8¹/₂" × 14", 8¹/₂" × 13", 8¹/₄" × 14", 8¹/₄" × 13", 8" × 13", 8¹/₂" × 11", 7¹/₄" × 10¹/₂", 5¹/₂" × 8¹/₂", 8K, 16K

Important

- If the specified paper size differs from the actual size of the paper loaded in the paper tray, a misfeed might occur because the correct paper size was not detected.

Note

- Default:
 - Tray 1
 - Metric version: 8¹/₂" × 11"
 - Inch version: A4
 - Tray 2
 - Metric version: A5 (Type 1), 8¹/₂" × 11" (Type 2)
 - Inch version: A5 (Type 1), A4 (Type 2)
 - Tray 3: A5
 - Tray 4 (Type 2 only): A5
- If the paper size set for the selector in the paper tray is different from the paper size for this setting, the paper size of the selector has priority.

- If you load paper of a size not indicated on the paper size selector in the paper tray, set the selector to “✖”.

 **Reference**

p.42 “Changing the Paper Size”

❖ **Paper Type: Bypass tray**

Set the display so you can see what type of paper is loaded in the bypass tray.

- The paper types you can set for the bypass tray are as follows:
 - recycled paper, special paper, colour paper, letterhead, prepunched paper, label paper, bond paper, thick paper, OHP, cardstock

 **Note**

- Default: *Thick Paper*
- Paper types you can set in the bypass tray for machines with the copy function only are plain paper, thick paper and OHP.

❖ **Paper Tray Priority: Copier (copier)**

You can specify the tray to supply paper for output.

 **Note**

- Default: *Tray 1*

❖ **Paper Tray Priority: Printer (printer)**

You can specify the tray to supply paper for output.

 **Note**

- Default: *Tray 1*

Timer Settings

❖ **Auto Off Timer**

After a specified period has passed, following job completion, the machine automatically turns off, in order to conserve energy. This function is called “Auto Off”.

The machine status after the Auto Off operation is referred to as “Sleep mode”. For the Auto Off Timer, specify the time to elapse before Auto Off.

 **Note**

- Default: *1 min.*
- The time can be set from 1 to 240 minutes, using the number keys.
- From “Sleep mode”, the machine is ready to use within 10 seconds.
- Auto Off may not work when error messages appear.

❖ Energy Saver Timer

The machine automatically enters Low Power mode automatically after a job is finished, and the selected time elapsed.

Note

- Default: *1 min.*
- The time can be set from 1 to 240 minutes, using the number keys.
- Energy Saver may not work when error messages appear.
- The machine automatically prints any fax or printer data received while in Energy Saver mode.

❖ System Auto Reset Timer

The System Reset setting automatically switches the screen to that of the function set in Function Priority when no operations are in progress, or when an interrupted job is cleared. This setting determines the system reset interval. See p.25 "Function Priority".

Note

- Default: *On, 60 sec.*
- The time can be set from 10 to 999 seconds in 1 second increments, using the number keys.
- When the set time has passed, the control panel returns to the menu that was displayed before the **[User Tools/Counter]** key was pressed.

❖ Copier Auto Reset Timer

Specify the time to elapse before copier modes reset.

Note

- If **[Off]** is selected, the machine does not automatically switch to the user code entry screen.
- Default: *On, 60 sec.*
- The time can be set from 10 to 999 seconds, using the number keys.

Key Operator Tools

The key operator must set the following items. For settings or more information, contact the key operator.

It is recommended that the key operator program a key operator code when performing the settings. See p.30 “Key Operator Code”.

❖ User Code Man.: Copier

Allows you to control who uses the machine by setting codes for users. User codes must be registered for user code management.

Note

- Default: *Off*
- By using **[Auto Program]** for the printer, you can keep a print log for each user code entered from the driver.

❖ Key Counter Management

Use the key counter to specify whether users are restricted or not.

Note

- Default: *Off*
- [Key Counter Management]** will only be displayed when the key counter is set.

❖ Key Operator Code

Specify whether or not to use passwords (max. eight digits) to control Key Operator Tools settings for key operator code.

Note

- Default: *Off*
- If you select **[On]**, enter the key operator code (max. eight digits) using the number keys, and then select **[On: Partial]** or **[On: All]** to set the access limit.
 - If you selected **[On: Partial]**
A key operator code is only required for the Timer Settings and Key Operator Tools for System Settings. **[Menu Protect]** can be set for **[Maintenance]** in Printer Features. If you set **[Menu Protect]**, you can set the key operator code for some Printer Features. See “Printer Features Parameters”, *Printer/Scanner Reference*.
 - If you selected **[On: All]**
A key operator code is required to access all items in System Settings, Copier Features, Printer Features, and Scanner Features.
- If you select **[On: All]**, you must enter a key operator code to access the Key Operator Code display.

❖ Display/Print Counter

Allows you to view and print the number of prints.

- Display/Print Counter
Displays the number of prints for each function (Total, Copier, Printer, and A3/DLT, and Duplex).
- Print Counter List
Prints out a list of the number of prints made under each function.
- To print the counter list
 - ① Press the **[User Tools/Counter]** key.

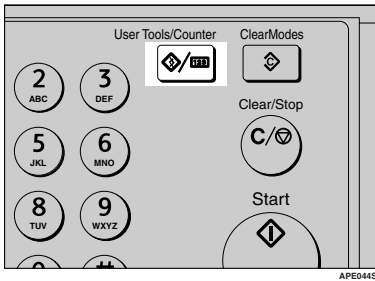

- ② Select **[System Settings]** using **[▲]** or **[▼]**, and then press the **[OK]** key.



- ③ Select **[Key Operator Tools]** using **[▲]** or **[▼]**, and then press the **[OK]** key.

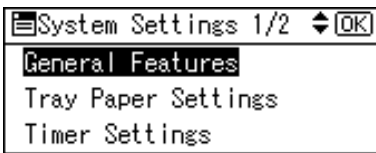

- ④ Select **[Display/Print Counter]** using **[▲]** or **[▼]**, and then press the **[OK]** key.

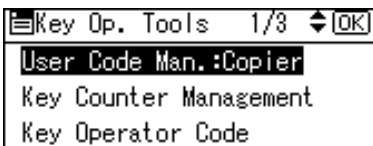

⑤ Press **[Print]**.

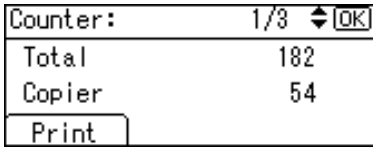

⑥ Press the **[Start]** key.

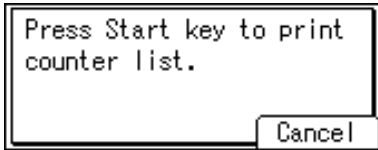

⑦ Press the **[User Tools/Counter]** key.

❖ **Counter per User Code**

Allows you to view and print the numbers of prints accessed with user codes, and to set those values to 0.

Note

- Press **[▲]** and **[▼]** to show all the numbers of prints.
- The number of prints may differ from the counter value shown in Display/Print Counter.
 - Print counter per user code
Prints the number of prints made under each user code.
 - Clear counter per user code
Sets the number of prints made under each user code to 0.
- Print list for each user code, see p.36 "Printing the Counter for Each User Code".
 - Print counter for all user codes
Prints the number of prints made under all user codes.
 - Clear counter for all user codes
Sets the number of prints made under all user codes to 0.

❖ **Program/Change User Code**

You can register, change, and delete user codes. For details about these operations, see p.33 "User Code".

Note

- You can register up to 50 user codes.

❖ **AOF (Always On)**

Specify whether or not to use Auto Off.

Note

- Default: *On*

User Code

Register user codes to restrict copier functions to certain users, and check on their use of copier functions:

Registering a New User Code

- 1 Press the [User Tools/Counter] key.

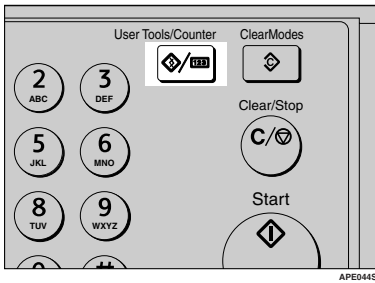

- 2 Select [System Settings] using [▲] or [▼], and then press the [OK] key.

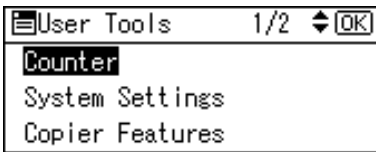

- 3 Select [Key Operator Tools] using [▲] or [▼], and then press the [OK] key.

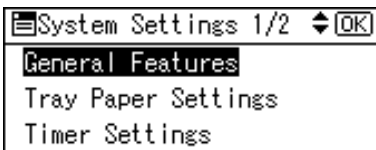

- 4 Select [Program/Change User Code] using [▲] or [▼], and then press the [OK] key.

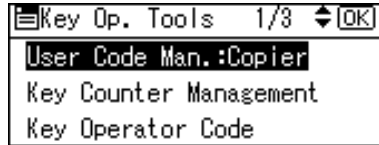

- 5 Select [Program] using [▲] or [▼], and then press the [OK] key.

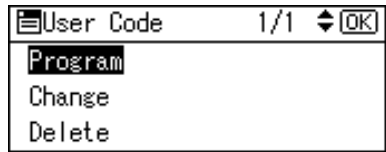

- 6 Enter the user code using the number keys, and then press the [OK] or [#] key.

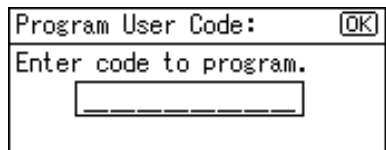

The "Programmed" message appears, and then the "User Code" display returns.

- 7 Press the [User Tools/Counter] key.

Changing a User Code

Note

- ❑ Even if you change a user code, the counter value will not be cleared.

- 1 Press the [User Tools/Counter] key.
- 2 Select [System Settings] using [▲] or [▼], and then press the [OK] key.
- 3 Select [Key Operator Tools] using [▲] or [▼], and then press the [OK] key.
- 4 Select [Program/Change User Code] using [▲] or [▼], and then press the [OK] key.
- 5 Select [Change] using [▲] or [▼], and then press the [OK] key.
- 6 Enter the registered user code you want to change using the number keys, and then press the [OK] or [#] key.

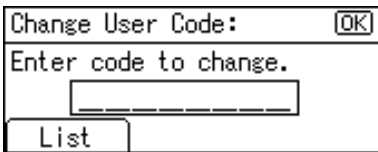

Note

- ❑ When you select the user code from the User Code List, press [List]. Select the user code you want to change using [▲] or [▼], and then press the [OK] key twice.

- 7 Enter the new user code using the number keys, and then press the [OK] or [#] key.

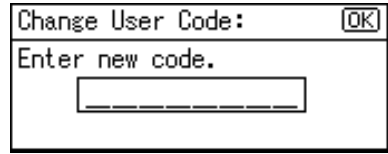

The “Programmed” message appears, and then the “User Code” display returns.

- 8 Press the [User Tools/Counter] key.

Deleting a User Code

Important

- ❑ This operation also deletes user codes registered to multiple functions. User control via the deleted user code is no longer possible.

- 1 Press the [User Tools/Counter] key.
- 2 Select [System Settings] using [▲] or [▼], and then press the [OK] key.
- 3 Select [Key Operator Tools] using [▲] or [▼], and then press the [OK] key.
- 4 Select [Program/Change User Code] using [▲] or [▼], and then press the [OK] key.
- 5 Select [Delete] using [▲] or [▼], and then press the [OK] key.

- 6** Select [Per User Code] or [All User Codes] using [▲] or [▼], and then press the [OK] key.

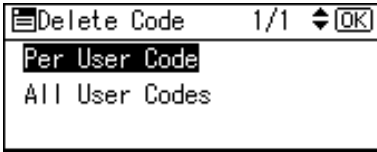

When selecting [All User Codes], a confirmation message appears. Press [Yes], and then proceed to step **9**.

- 7** Enter the registered user code you want to delete using the number keys, and then press the [OK] or [#] key.

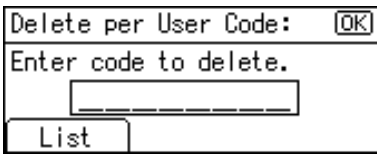

 **Note**

- When you select the user code from the User Code List, press [List]. Select the user codes you want to delete using [▶], and then press the [OK] key.

A confirmation message appears.

- 8** Press [Yes].

The “Deleted.” message appears, and then the “User Code” display returns.

- 9** Press the [User Tools/Counter] key.

Displaying the Counter for Each User Code

You can check the counter for each user code.

- 1** Press the [User Tools/Counter] key.
- 2** Select [System Settings] using [▲] or [▼], and then press the [OK] key.
- 3** Select [Key Operator Tools] using [▲] or [▼], and then press the [OK] key.
- 4** Select [Counter per User Code] using [▲] or [▼], and then press the [OK] key.
- 5** Select [Display] using [▲] or [▼], and then press the [OK] key.

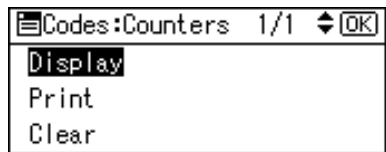

The counter for each user code will be displayed.

- 6** Press the [User Tools/Counter] key.

Printing the Counter for Each User Code

You can print out the counter for each user code.

- 1** Press the [User Tools/Counter] key.
- 2** Select [System Settings] using [▲] or [▼], and then press the [OK] key.
- 3** Select [Key Operator Tools] using [▲] or [▼], and then press the [OK] key.
- 4** Select [Counter per User Code] using [▲] or [▼], and then press the [OK] key.
- 5** Select [Print] using [▲] or [▼] and then press the [OK] key.
The counter list prints out.
- 6** Press the [Start] key.
- 7** Press the [User Tools/Counter] key.

Clearing the Counter

- 1** Press the [User Tools/Counter] key.
- 2** Select [System Settings] using [▲] or [▼], and then press the [OK] key.
- 3** Select [Key Operator Tools] using [▲] or [▼], and then press the [OK] key.
- 4** Select [Counter per User Code] using [▲] or [▼], and then press the [OK] key.
- 5** Select [Clear] using [▲] or [▼], and then press the [OK] key.
A confirmation message appears.
- 6** Press [Yes].
The "Counter has been cleared." message appears, and then the "Codes:Counters" display returns.
- 7** Press the [User Tools/Counter] key.

4. Troubleshooting

If Your Machine Does Not Operate As You Want

The following chart gives explanations of common problems and messages. If other messages appear, follow the instructions displayed.

Note

- For further “Troubleshooting”, refer to the other manuals for this machine. See p.i “Manuals for This Machine”.

Problem	Causes	Solutions
“Please wait.” appears.	This message appears when you turn on the operation switch or change the toner bottle.	Wait for the machine to get ready.
The display is off.	The machine is in Energy Saver mode.	Turn on the operation switch.
	The operation switch is turned off.	
Nothing happens when the operation switch is turned on.	The main power switch is turned off.	Turn on the main power switch.
The user code entry display appears.	Users are restricted by user management.	Enter the user code (up to eight digits), and then press the [OK] or [#] key.
Original images are printed on the reverse side of the paper.	You may have loaded the paper incorrectly.	Load paper correctly. Load paper into Tray 1-4 with the print side up, and bypass tray with the print side down.
The main power indicator continues blinking and does not turn off when pressed.	This occurs in the following case: <ul style="list-style-type: none">• The machine is communicating with external equipment.	Check if the machine is communicating with a computer.
Original images are printed on the reverse side of the paper.	You may have loaded the paper incorrectly.	Load paper correctly. Load paper into Tray 1-4 with the print side up, and bypass tray with the print side down.

Problem	Causes	Solutions
Misfeeds occur frequently.	The tray's side fences may not be locked.	Check the side fences are locked. p.42 "Changing the Paper Size".
	The tray's end fence may not be set properly.	Check the end fence is set properly. See p.42 "Changing the Paper Size".
	You may have loaded paper of a size not shown on the paper size selector.	When using paper of a size that cannot be detected automatically, use Tray Paper Settings to set the paper size. See p.27 "Tray Paper Size:Tray 1-4" and p.59 "Copy Paper".
An error message remains, even if misfed paper is removed.	When a misfeed message appears, it remains until you open and close the cover, as required.	Clear misfed paper, and then open and close the front cover. See p.39 "Clearing Misfeeds".
Cannot print in duplex mode.	You cannot use paper in the bypass tray for duplex printing.	For duplex printing, select Tray 1-4 in copier mode or with the printer driver.
	[Off] is selected for [Duplex] in Printer Features.	Select [On] for [Duplex] in Printer Features. See "Paper Input: Duplex" <i>Printer/Scanner Reference</i> .
You forgot your key operator code.	—	Contact your service representative.

Clearing Misfeeds

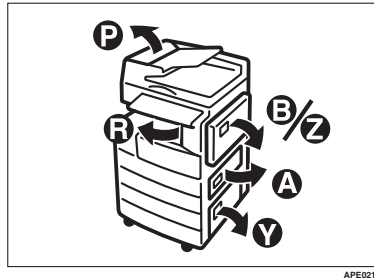

CAUTION:

- *The fusing section of this machine might be very hot. Caution should be taken when removing misfed paper.*

Important

- When clearing misfeeds, do not turn off the power switch. If you do, your copy settings are cleared.
- To prevent misfeeds, do not leave any torn scraps of paper inside the machine.
- If paper misfeeds occur repeatedly, contact your service representative.

Note

- More than one misfeed area may be indicated. If this is the case, check every applicable area. Refer to the following charts: A, B, P, R, Y.
- You can find a sticker explaining how to remove misfed paper inside the right cover.
- When the machine instructs you to reset originals, reset them in the feeding position. The display will show you the number of originals to return.

■ When P is displayed (ADF)

1. Open the ADF cover, and then remove the misfed original.
2. Open the ADF.
3. Pull the green lever in the upper left corner, and then remove the misfed original.

■ When P is displayed (ARDF)

1. Open the ARDF cover, and then remove the misfed original.
2. Lift the lever.
3. Open the cover, and then remove the misfed original.
4. If you cannot remove the misfed original, open the ARDF external cover, and then remove the misfed original.
5. Open the ARDF.
6. Pull the green lever in the upper left corner, and then remove the misfed original.

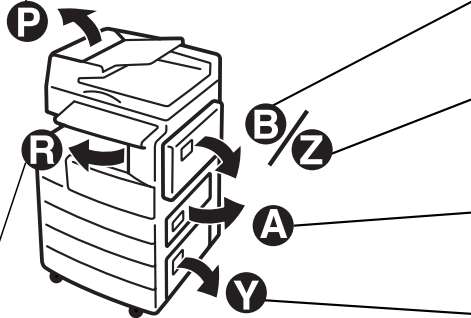

■ When R is displayed

1. Open the right cover of the bridge unit to the left.
2. Remove the misfed paper.
3. Close the right cover.

■ When B is displayed



1. Open the right cover and remove the misfed paper.
2. Close the right cover.

■ When Z is displayed



1. Open the right cover and remove the misfed paper.
2. Remove the misfed paper.
3. Open the Z cover and remove the misfed paper.
4. Close the right cover.

4

■ When A is displayed



1. Open the lower right cover and remove the misfed paper.
2. Close the cover.

■ When Y is displayed



1. Open the lower right cover of the optional paper tray unit and remove the misfed paper.
2. Close the cover.

APE022S

Changing the Paper Size

Preparation

Be sure to select the paper size with User Tools and the paper size selector. If you do not, misfeeds might occur. See p.27 "Tray Paper Size:Tray 1-4".

Reference

For details about paper sizes and types, see p.59 "Copy Paper".

4

Changing the Paper Size of the Paper Tray

1 Make sure the paper tray is not in use.

2 Pull the paper tray out slowly until it stops.

Note

Remove any remaining copy paper.

3 While pressing the release lever, adjust the back fence.

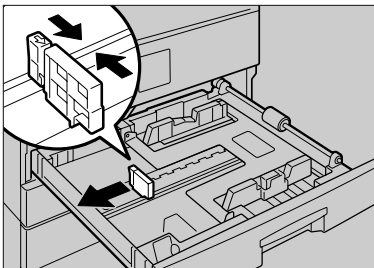

ZENY380E

When using 11"× 17" size paper

1 Pull the back fence off from the tray.

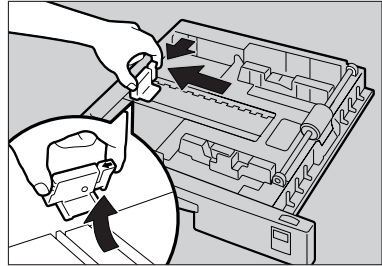

ZENY410E

2 Place it in the corner pocket on the left.

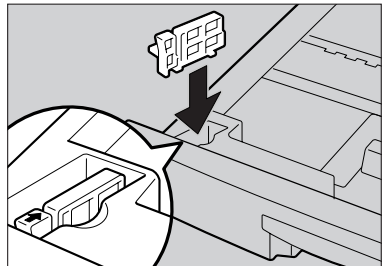

ZENY420E

4 Press down the release button.

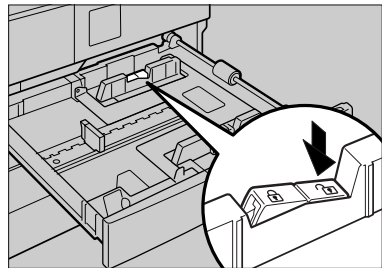

ZENY281E

- 5** While pressing the release lever, adjust the side fences.

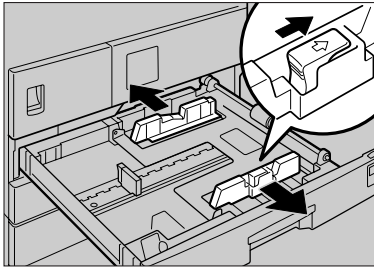

ZENY390E

- 6** Push the metal plate down.

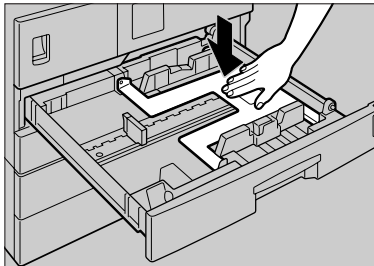

ZENY300E

- 7** Square the paper and set it in the tray.

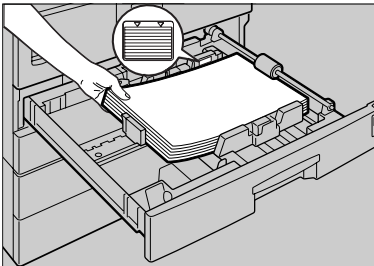

AAI022S

Important

- Be sure to set the paper under the roller.
- Do not stack paper over the limit mark.

- 8** While pressing the release lever, adjust the side and back fences to the new paper size.

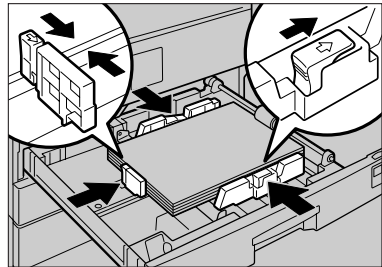

ZENY320E

Important

- When setting small quantities of copy paper, be careful not to squeeze in the side fence too much or paper will not feed in properly.

- 9** Press down the lock button.

- 10** Adjust the tray size to the new paper size using the paper size selector.

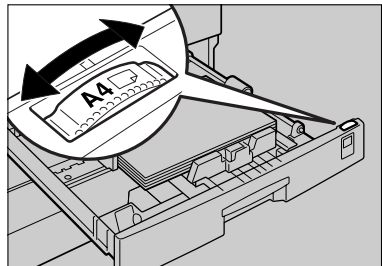

ZENY281E

Note

- Be sure to set the correct size, otherwise a paper jam might occur.

- 11** Push the paper tray in until it stops.

Changing the Paper Size in the Optional Paper Tray Unit

1 Make sure the paper tray is not in use.

2 Pull out the paper tray until it stops.

 **Note**

- Remove any remaining copy paper.

3 While pinching the release lever, adjust the back fence.

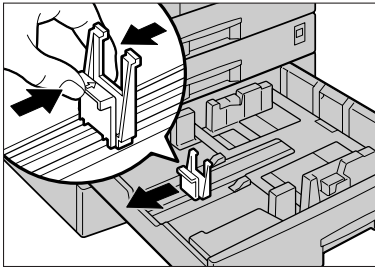

ZENY460E

4 Press down the release button.



ZENY470E

5 While pressing the release lever, adjust the side fences.

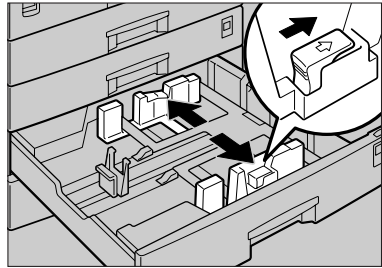

ZENY480E

6 Square the paper and set it in the tray.

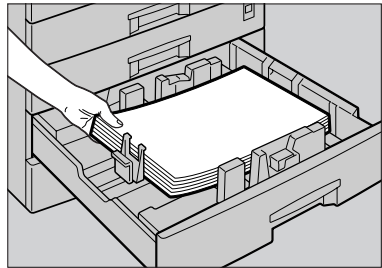

AAI034S

 **Important**

- Do not stack paper over the limit mark.

- 7** While pinching the release lever, adjust the side and back fences to the new paper size.

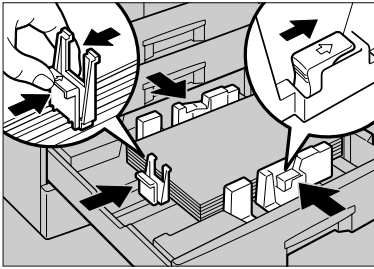

ZENYS00E

- 9** Adjust the tray size to the new paper size using the paper size selector.

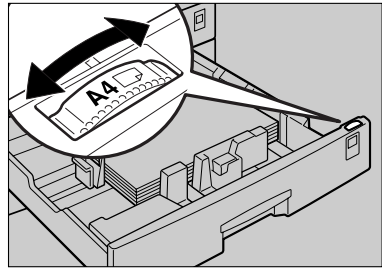

ZENYS10E

Important

- When setting small quantities of copy paper, be careful not to squeeze in the side fence too much or paper will not feed in properly.

- 8** Press down the lock button.

Note

- Be sure to set the correct size, otherwise a paper jam might occur.

- 10** Push the paper tray in until it stops.

5. Other Functions

Other Functions

Displaying the Total Counter

You can display the total counter value used for all functions.

- 1 Press the [User Tools/Counter] key.

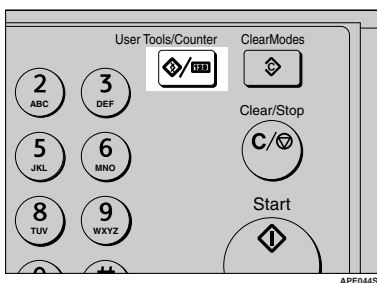

- 2 Select [Counter] using [▲] or [▼], and then press the [OK] key.



- 3 To print the counter list, press [Print].

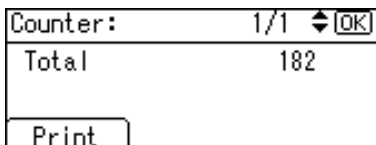

Note

- To print the counter list, set the paper size to larger than A4 or 8¹/₂" × 11".

- 4 Press the [Start] key.

A counter list prints out.

- 5 Press the [User Tools/Counter] key.

Changing the Language

You can change the language used on the display. English is set as default.

- 1 Press the [User Tools/Counter] key.

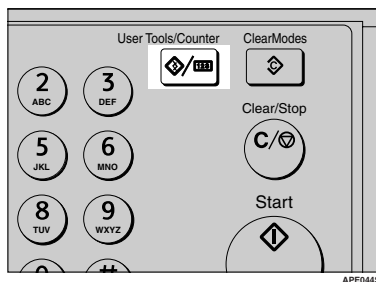

- 2 Select [Language] using [▲] or [▼], and then press the [OK] key.

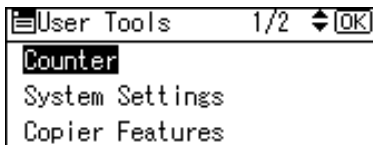

- 3 Select the language using [▲] or [▼], and then press the [OK] key.

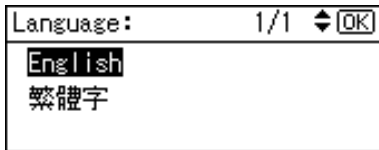

The "Programmed" message appears, and then the "User Tools" display returns.

- 4 Press the [User Tools/Counter] key.

Security

Confidential information is always at risk of being copied without permission or subject to unauthorized access through the network. To protect documents from such intrusion, not only can passwords be set, but also the Extended Security function can be used to strengthen security.

For those who require increased document protection, we recommend the Extended Security function.

Primary Security Functions

❖ **Protecting Image Data Remaining in Memory**

Protects image data remaining in memory. When a copy or print job is completed, or a job is canceled, the data is secure.

❖ **Authenticating Administrator**

Protects essential functions for administrating document security using an access code. See p.30 "Key Operator Code".

Operating Environment and Notes

Security for this machine is assured on the premises that the machine is used under the following conditions:

Operating Environment

- The condition of the machine is normal. (For example, it is not damaged, modified, or lacking components.)
- When the machine is connected to a network, the machine is protected from illegitimate access including unauthorized packet sniffing.
- The machine is managed by an administrator with thorough knowledge of the machine and capable of providing the proper conditions under which users can use the machine safely.

For Administrator

- This machine does not protect against illegitimate actions on the network. To avoid any risks on the network, further security is required.
- Security of this machine cannot be assured if any hardware component is detached or replaced with an inappropriate component. If these things have the possibility of occurring, other security measures are necessary.
- Avoid using a single number or consecutive numbers for a key operator code such as "00000000" or "12345678". Since the numbers like this are easy to guess, using them will not provide the appropriate level of security.
- Remote document management using SmartDeviceMonitor for Admin is not available when the Extended Security function is on.
- User code is a function to help manage the use of the machine. It is not to protect confidential documents from others.







For User

- Before scanning originals using the scanner function, make sure all other operations are complete.

7. Specifications

Main Unit

- ❖ **Configuration:**
Desktop
- ❖ **Photosensitivity type:**
OPC drum
- ❖ **Original scanning:**
One-dimensional solid scanning system through CCD
- ❖ **Copy process:**
Dry electrostatic transfer system
- ❖ **Development:**
Dry two-component magnetic brush development system
- ❖ **Fusing:**
Heating roll pressure system
- ❖ **Resolution:**
600 dpi
- ❖ **Exposure glass:**
Stationary original exposure type
- ❖ **Original reference position:**
Rear left corner
- ❖ **Warm-up time:**
From the main power switch
15 seconds or less (20 °C)
From the operation switch
10 seconds or less (20 °C)
- ❖ **Originals:**
Sheet/book/objects
- ❖ **Maximum original size:**
A3☐, 11" × 17"☐
- ❖ **Copy paper size:**
 - Trays: A3☐ – A5☐, 11" × 17"☐ – 5¹/₂" × 8¹/₂"☐
 - Bypass: A3☐ – A6☐, 11" × 17"☐ – 5¹/₂" × 8¹/₂"☐

- Bypass (custom size):
Vertical: 90 – 297 mm, 3.55" – 11.69"
Horizontal: 148 – 600 mm, 5.83" – 23.62"
- Duplex unit: A3  – A5  , 11" × 17"  – 8 1/2" × 11"  



❖ **Copy paper weight:**

- Paper trays (Standard size): 60 – 90 g/m², 16 – 24 lb
- Bypass tray: 52 – 162 g/m², 14 – 43 lb
- Duplex unit: 64 – 90 g/m², 20 – 24 lb



❖ **Non-reproduction area:**

- Leading edge: 2 ± 1.5 mm (0.08 ± 0.06 inch)
- Trailing edge: more than 0.5 mm (0.02 inch)
- Left edge: 2 ± 1.5 mm (0.08 ± 0.06 inch)
- Right edge: more than 0.5 mm (0.02 inch)



❖ **First copy time:**

6.5 seconds or less
(A4 , 8 1/2" × 11"  100%, feeding from Tray 1)

❖ **Copying speed: (Type 1)**

- 16 copies/minute (A4 , 8 1/2" × 11" )

❖ **Copying speed: (Type 2)**

- 20 copies/minute (A4 , 8 1/2" × 11" )
18 copies/minute (feeding from Optional Paper)

❖ **Reproduction ratio:**

Preset reproduction ratios:

—	Metric version	Inch version
Enlargement	200%	155%
	141%	129%
	122%	121%
Full Size	100%	100%
Reduction	93%	93%
	82%	78%
	71%	65%
	50%	50%

Zoom: From 50% to 200% in 1% steps.

❖ **Continuous copying count:**

1 – 99 copies

❖ **Copy paper capacity:**

Type 1:

- Tray 1: 250 sheets (80 g/m², 20 lb)
- Bypass: 100 sheets (80 g/m², 20 lb)

Type 2:

- Tray 1, 2: 250 sheets (80 g/m², 20 lb)
- Bypass: 100 sheets (80 g/m², 20 lb)

❖ **Power consumption:**

	Complete system ^{*1}
Warm up	Less than 1,280 W
Stand-by	About 130 W
During printing	About 450 W
Maximum	Less than 1,280 W

^{*1} Main unit with the optional ARDF, printer/scanner unit, and paper tray unit.

❖ **Dimensions (W × D × H up to exposure glass):**

Type 1: 550 × 568 × 420 mm, 21.65" × 22.36" × 16.54"

Type 2: 550 × 568 × 558 mm, 21.65" × 22.36" × 21.97"

❖ **Noise Emission ^{*1} :**

- Sound power level

	Complete system ^{*3}
Stand-by	40 dB (A)
During printing	66 dB (A)

- Sound pressure level ^{*2}

	Complete system ^{*3}
Stand-by	26 dB (A)
During printing	55 dB (A)

^{*1} The above measurements made in accordance with ISO 7779 are actual values.

^{*2} Measured at the position of the operator.

^{*3} The Complete system consists of a main unit with full options installed.

❖ **Weight:**

Type 1: 35 kg (78 lb) or less

Type 2: 44 kg (96 lb) or less

📌 **Note**

- ❑ Specifications are subject to change without notice.

❖ **Duplex unit (Type 2 only)**







- Paper size:
A3, B4JIS, A4, B5JIS, A5, 11" × 17", 8¹/₂" × 14", 8¹/₂" × 13", 8¹/₄" × 13", 8" × 13", 8¹/₂" × 11", 7¹/₄" × 10¹/₂", 8K, 16K
- Paper weight:
64 – 90 g/m² (20 – 24 lb)

Options

Exposure Glass Cover

Lower this over originals.

Auto Document Feeder (ADF)







- ❖ **Mode:**
 - ADF mode
- ❖ **Original size:**
 - A3  – A5  
 - 11" × 17"  – 5¹/₂" × 8¹/₂"  
- ❖ **Original weight:**
 - 52 – 105 g/m² (14 – 28 lb)
- ❖ **Number of originals to be set:**
 - 30 sheets (80 g/m², 20 lb)
- ❖ **Maximum power consumption:**
 - less than 25 W (power is supplied from the main unit.)
- ❖ **Dimensions (W × D × H):**
 - 550 × 470 × 90 mm, 21.7" × 18.6" × 3.6"
- ❖ **Weight:**
 - 7 kg (15 lb) or less

 **Note**

- Specifications are subject to change without notice.

Auto Document Feeder capable of scanning both sides of a sheet (ARDF)

❖ **Original size:**

- A3  – A5  
- 11" × 17"  – 5¹/₂" × 8¹/₂"  

❖ **Original weight:**

- One-sided originals: 40 – 128 g/m² (11 – 34 lb)
- Two-sided originals: 64 – 105 g/m² (17 – 28 lb) (Duplex)

❖ **Number of originals to be set:**

- 50 sheets (80 g/m², 20 lb)

❖ **Maximum power consumption:**

- less than 50 W (power is supplied from the main unit.)

❖ **Dimensions (W × D × H):**

- 550 × 470 × 130 mm, 21.7" × 18.6" × 5.2"

❖ **Weight:**

- 10 kg (22 lb) or less

 **Note**

- Specifications are subject to change without notice.

Internal Tray 2 (1 bin tray)

❖ **Number of bins:**

1

❖ **Paper size:**

- A3 - A5
- 11" × 17" - 5¹/₂" × 8¹/₂"

❖ **Paper capacity:**

100 sheets (80 g/m², 20 lb.)

❖ **Paper weight:**

60 - 105 g/m² (20 - 28lb.)

❖ **Maximum power consumption:**

20 W

❖ **Dimension (W × D × H)**

Unit: 222 × 478 × 104 mm













Tray: 335 × 390 × 26 mm

❖ **Weight:**

2 kg (4 lb) or less

 **Note** Specifications are subject to change without notice.

Paper Tray Unit (1-tray type)

❖ **Paper weight:**60 – 105 g/m² (16 – 28 lb.)❖ **Paper size:**A3 , B4 JIS , A4  , B5 JIS  , A5 , 11" × 17" , 8¹/₂" × 14" , 8¹/₂" × 13" , 8¹/₂" × 11"  , 8¹/₄" × 13" , 8" × 13" , 7¹/₄" × 10¹/₂" , 8¹/₄" × 14" , 5¹/₂" × 8¹/₂" , 8K , 16K ❖ **Maximum power consumption:**

23 W (power is supplied from the main frame.)

❖ **Paper capacity:**500 sheets (80 g/m², 20 lb)❖ **Dimensions (W × D × H):**

550 × 520 × 134 mm, 21.7" × 20.5" × 5.36"

❖ **Weight:**

12 kg (26 lb) or less

 **Note** Specifications are subject to change without notice.

Paper Tray Unit (2-tray type)

❖ **Paper weight:**

60 – 105 g/m² (16 – 28 lb.)

❖ **Paper size:**

A3, B4 JIS, A4, B5 JIS, A5, 11" × 17", 8¹/₂" × 14", 8¹/₂" × 13", 8¹/₂" × 11", 8¹/₄" × 13", 8" × 13", 7¹/₄" × 10¹/₂", 8¹/₄" × 14", 5¹/₂" × 8¹/₂", 8K, 16K

❖ **Maximum power consumption:**

28 W (power is supplied from the main frame.)

❖ **Paper capacity:**

500 sheets (80 g/m², 20 lb.) × 2 trays

❖ **Dimensions (W × D × H):**

550 × 520 × 271 mm, 21.7" × 20.5" × 10.7"

❖ **Weight:**

25 kg (55 lb) or less



 **Note**

□ Specifications are subject to change without notice.

Copy Paper

Recommended Paper Sizes and Types

The following limitations apply to each tray:

	Metric version	Inch version	Paper weight	Paper capacity
Paper tray 1 (Type 1) Paper tray 1, 2 (Type 2)	A3, B4JIS, A4, B5JIS, A5, 11" × 17", 8 ¹ / ₂ " × 14", 8 ¹ / ₂ " × 13", 8 ¹ / ₄ " × 14", 8 ¹ / ₄ " × 13", 8" × 13", 8 ¹ / ₂ " × 11", 7 ¹ / ₄ " × 10 ¹ / ₂ ", 5 ¹ / ₂ " × 8 ¹ / ₂ ", 8K ^{*3} , 16K ^{*4}		60–90 g/m ² , 16–24 lb	250 sheets ^{*1}
	<p> Note</p> <p><input type="checkbox"/> You can specify the paper size with the user tools or the paper size selector. See p.42 "Changing the Paper Size".</p>			
Paper tray unit (optional)	A3, B4JIS, A4, B5JIS, A5, 11" × 17", 8 ¹ / ₂ " × 14", 8 ¹ / ₂ " × 13", 8 ¹ / ₄ " × 14", 8 ¹ / ₄ " × 13", 8" × 13", 8 ¹ / ₂ " × 11", 7 ¹ / ₄ " × 10 ¹ / ₂ ", 5 ¹ / ₂ " × 8 ¹ / ₂ ", 8K ^{*3} , 16K ^{*4}		60–105 g/m ² , 16–28 lb	500 sheets ^{*1}
	<p> Note</p> <p><input type="checkbox"/> You can specify the paper size with User Tools or the paper size selector. See p.42 "Changing the Paper Size".</p>			

		Metric version	Inch version	Paper weight	Paper capacity
Bypass tray	Standard Sizes	A3, B4JIS		52 – 162 g/m ² , 14 – 43 lb	10 sheets *1
		A4, B5JIS, A5, B6JIS			100 sheets *1
		11" × 17" *2, 8 1/2" × 14", 8 1/2" × 13"(F4), 8 1/4" × 14", 8 1/4" × 13", 8" × 13"(F), 8 1/2" × 11", 7 1/4" × 10 1/2", 5 1/2" × 8 1/2", 8K *3, 16K *4			
		A3, B4JIS		60 – 157 g/m ² , 16 – 42 lb	10 sheets *1
A4, B5JIS, A5, B6JIS		40 sheets *1			
		11" × 17", 8 1/2" × 14", 8 1/2" × 13", 8 1/4" × 13", 8" × 13", 8 1/2" × 11", 7 1/4" × 10 1/2", 5 1/2" × 8 1/2", 8K *3, 16K *4 Note <input type="checkbox"/> You can specify the paper size. See <i>Copy Reference</i> .			
	Custom sizes *5	Translucent paper (A3, B4JIS), OHP transparencies			10 sheets
		Translucent paper (A4, B5JIS)			40 sheets
		Adhesive labels (B4JIS, A4)			1 sheet
		Envelope (C5, C6, DL, Monarch, Commercial #10)			10 sheets

*1 Paper weight: 80 g/m², 20 lb

*2 When you set custom size paper in the bypass tray, you can specify the size. See *Copy Reference*.

*3 8K(Ba-Kai) = 267 × 390 mm, 10.6" × 15.4"

*4 16K(Shi-Lui-Kai) = 195 × 267 mm, 7.7" × 10.6"

*5 Set one sheet at a time for your needs. See *Copy Reference*.

Important

- If you use damp or curled paper, a misfeed might occur. In such a case, try turning over the paper stack in the paper tray. If there is no improvement, change to copy paper with less curl.

 **Note**

- When using the bypass tray, we recommend you set the copy paper direction to .
- If you load paper of the same size and in the same direction in two or more trays, the machine automatically shifts to another tray when the tray in use runs out of paper. This function is called Auto Tray switching. This saves interrupting a copy run to replenish paper even when making a large number of copies. You can cancel this setting.

 **Reference**

To add paper, see *Copy Reference*.

To change the paper size, see p.42 "Changing the Paper Size".

Unusable Paper

 **CAUTION:**

- Do not use aluminum foil, carbon paper, or similar conductive paper to avoid a fire or machine failure.

 **Important**

- Do not use any of the following kinds of paper or a fault might occur:
 - Art paper
 - Aluminum foil
 - Carbon paper
 - Conductive paper
- Do not use copy paper that has been already copied on. Otherwise, a paper misfeed might occur.

 **Note**

- Do not use any of the following kinds of paper or a misfeed might occur.
 - Bent, folded, or creased paper
 - Torn paper
 - Slippery paper
 - Perforated paper
 - Rough paper
 - Thin paper that has low stiffness
 - Paper with a dusty surface
- If you make copies on rough grain paper, the copy image might come out blurred.
- Do not use paper already copied or printed on.

Paper Storage

 **Note**

- When storing paper, the following precautions should always be followed:
 - Do not store paper where it will be exposed to direct sunlight.
 - Avoid storing paper in humid areas (humidity: 70% or less).
 - Store on a flat surface.
- Keep open reams of papers in the package, and store as you would unopened paper.
- Under conditions of high temperature and high humidity, or low temperature and low humidity conditions, store papers in a plastic bag.

INDEX

A

- Accessing user tools (System Settings), 23
- AOF (Always On), 32
- ARDF, 13, 56
- Auto Document Feeder (ADF), 13, 55
- Auto off timer, 28
- Auto reset timer, 29
 - copier*, 29

B

- Bypass tray, 12

C

- Changing a user code, 34
- Changing default settings, 23
- Changing modes, 17
- Changing the language, 47
- Changing the paper size, 42
- Changing the paper size in the optional paper tray unit, 44
- Changing the paper size of the paper tray, 42
- Clearing misfeeds, 39
- Clearing the counter, 36
- Combined function operations, 17
- Common key operations, 16
- Control panel, 12, 14
- Copy Count Display, 25
- Copy paper, 59
- Counter per User Code, 32

D

- Deleting a user code, 34
- Display, 15
- Display Contrast, 26
- Displaying the counter for each user code, 35
- Displaying the total counter, 47
- Display/Print Counter, 31

E

- Energy Saver Timer, 29
- Exposure glass, 11
- Exposure glass cover, 13, 55
- External options, 13

F

- For administrator, 50
- For user, 50
- Front cover, 12
- Function Priority, 25

G

- General Features, 25
- Guide to components, 11

I

- If your machine does not operate as you want, 37
- Internal tray, 11
- Internal tray 2 (1 bin tray), 56

K

- Key Counter Management, 30
- Key Operator Code, 30
- Key Operator Tools, 30
- Key Repeat, 26

L

- Lower right cover, 12

M

- Main power indicator, 12
- Main power switch, 12
- Main unit, 51
- Measurement Unit, 26
- Multi-access, 18

O

- On Indicator, 12
- Operating environment, 50
- Operation switch, 12
- Options, 13, 55
- Other functions, 47
- Output
 - copier (copier)*, 26
 - printer (printer)*, 26
- Output tray settings, 26

P

- Panel Key Sound, 25
- Paper Storage, 62
- Paper tray, 12
- Paper tray priority
 - copier*, 28
 - printer*, 28
- Paper tray unit, 12
- Paper tray unit (1-tray type), 13, 57
- Paper tray unit (2-tray type), 13, 58
- Paper type
 - Bypass tray*, 28
- Primary security functions, 49
- Printing the counter for each user code, 36
- Print Priority, 25
- Program/Change User Code, 32

Q

- Quitting user tools, 24

R

- Reading the display and using keys, 16
- Recommended paper sizes and types, 59
- Registering a new user code, 33
- Right cover, 12

S

- Security, 49
- Settings you can change with user tools, 25
- Specifications, 51
- System Auto Reset Timer, 29
- System reset, 17

T

- Timer settings, 28
- Tray paper settings, 27
- Tray paper size, 27
- Troubleshooting, 37

U

- Unusable paper, 61
- User code, 33
- User Code Management, 30
- User Tools Menu (System Settings), 21

V

- Ventilation holes, 11

In accordance with IEC 60417, this machine uses the following symbols for the main power switch:

I means **POWER ON**.

⏻ means **STAND BY**.

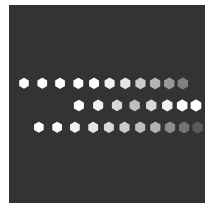

MP 1600L/MP 1600L/Aficio MP 1600L/IS 2316L

MP 2000L/MP 2000L/Aficio MP 2000L/IS 2320L

Printed in China

AE  B277-6508



B2776508

Free Manuals Download Website

<http://myh66.com>

<http://usermanuals.us>

<http://www.somanuals.com>

<http://www.4manuals.cc>

<http://www.manual-lib.com>

<http://www.404manual.com>

<http://www.luxmanual.com>

<http://aubethermostatmanual.com>

Golf course search by state

<http://golfingnear.com>

Email search by domain

<http://emailbydomain.com>

Auto manuals search

<http://auto.somanuals.com>

TV manuals search

<http://tv.somanuals.com>