



## RICOH COMPANY, LTD.

15-5, Minami Aoyama 1-chome,  
Minato-ku, Tokyo 107-8544, Japan  
Phone: +81-(0)3-3479-3111

RICOH

# Aficio™ 1060/1075

## Operating Instructions General Settings Guide

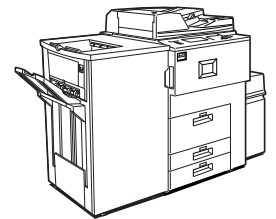

### Aficio™ 1060/1075 Operating Instructions General Settings Guide

### Aficio™ 1060/1075 Operating Instructions General Settings Guide

## Overseas Affiliates

### U.S.A.

RICOH CORPORATION  
5 Dedrick Place  
West Caldwell, New Jersey 07006  
Phone: +1-973-882-2000

### The Netherlands

RICOH EUROPE B.V.  
Groenelaan 3, 1186 AA, Amstelveen  
Phone: +31-(0)20-5474111

### United Kingdom

RICOH UK LTD.  
Ricoh House,  
1 Plane Tree Crescent, Feltham,  
Middlesex, TW13 7HG  
Phone: +44-(0)20-8261-4000

### Germany

RICOH DEUTSCHLAND GmbH  
Mergenthalerallee 38-40,  
65760 Eschborn  
Phone: +49-(0)6196-9060

### France

RICOH FRANCE S.A.  
383, Avenue du Général de Gaulle  
BP 307-92143 Clamart Cedex  
Phone: +33-(0)-821-01-74-26

### Spain

RICOH ESPAÑA S.A.  
Avda. Litoral Mar, 12-14,  
08005 Barcelona  
Phone: +34-(0)93-295-7600

### Italy

RICOH ITALIA SpA  
Via della Metallurgia 12,  
37139 Verona  
Phone: +39-045-8181500

### Hong Kong

RICOH HONG KONG LTD.  
21/F., Tai Yau Building,  
181, Johnston Road,  
Wan Chai, Hong Kong  
Phone: +852-2862-2888

### Singapore

RICOH ASIA PACIFIC PTE.LTD.  
260 Orchard Road,  
#15-01/02 The Heeren,  
Singapore 238855  
Phone: +65-830-5888

- 1 What You Can Do With This Machine
- 2 Basics
- 3 Combined Function Operations
- 4 Document Server
- 5 User Tools (System Settings)
- 6 Troubleshooting
- 7 REMARKS
- 8 Specification

## Introduction

This manual describes detailed instructions on the operation and notes about the use of this machine. To get maximum versatility from this machine all operators are requested to read this manual carefully and follow the instructions. Please keep this manual in a handy place near the machine.

### Notes:

Some illustrations may be slightly different from your machine.  
Certain options may not be available in some countries. For details, please contact your local dealer.

### Laser Safety:

This machine is considered a class 1 laser device, safe for office/EDP use. The machine contains four AlGaInp laser diodes, 10-milliwatt, 770-810 nanometer wavelength for each emitter. Direct (or indirect reflected ) eye contact with the laser beam might cause serious eye damage. Safety precautions and interlock mechanisms have been designed to prevent any possible laser beam exposure to the operator.

The following label is attached on the back side of the machine.



### Warning:

Use of controls or adjustment or performance of procedures other than those specified in this manual might result in hazardous radiation exposure.

### Notes:

The model names of the machines do not appear in the following pages. Check the type of your machine before reading this manual. (For details, see P.15 "*Machine Types*".)

- Type 1: Aficio 1060
- Type 2: Aficio 1075

Certain types might not be available in some countries. For details, please contact your local dealer.

Two kinds of size notation are employed in this manual. With this machine refer to the metric version.

For good copy quality, Ricoh recommends that you use genuine Ricoh toner.

Ricoh shall not be responsible for any damage or expense that might result from the use of parts other than genuine Ricoh parts with your Ricoh office products.

### Power Source

220 - 240V, 50/60Hz, 10A or more

Please be sure to connect the power cord to a power source as above. For details about power source, see P.152 "*Power Connection*".



### Declaration of Conformity

"The Product complies with the requirements of the EMC Directive 89/336/EEC and the Low Voltage Directive 73/23/EEC."

In accordance with IEC 60417, this machine uses the following symbols for the main power switch:

**I** means **POWER ON.**

**⏻** means **STAND BY.**

## Introduction

This manual describes detailed instructions on the operation and notes about the use of this machine. To get maximum versatility from this machine all operators are requested to read this manual carefully and follow the instructions. Please keep this manual in a handy place near the machine.

For safe and correct use of this machine, please be sure to read the Safety Information before you use it.

### Notes:

Some illustrations may be slightly different from your machine.

Certain options may not be available in some countries. For details, please contact your local dealer.

### Laser Safety:

This machine is considered a class 1 laser device, safe for office/EDP use. The machine contains four AlGaInp laser diodes, 10-milliwatt, 770-810 nanometer wavelength for each emitter. Direct (or indirect reflected ) eye contact with the laser beam might cause serious eye damage. Safety precautions and interlock mechanisms have been designed to prevent any possible laser beam exposure to the operator.

The following label is attached on the back side of the machine.

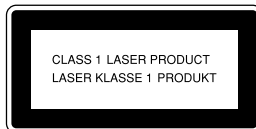

### Warning:

Use of controls or adjustment or performance of procedures other than those specified in this manual might result in hazardous radiation exposure.

### Notes:

The model names of the machines do not appear in the following pages. Check the type of your machine before reading this manual. (For details, see p.15 "Machine Types".)

- Type 1: 6008
- Type 2: 7508

Certain types might not be available in some countries. For details, please contact your local dealer.

Two kinds of size notation are employed in this manual. With this machine refer to the metric version.

For good copy quality, Rex-Rotary recommends that you use genuine Rex-Rotary toner.

Rex-Rotary shall not be responsible for any damage or expense that might result from the use of parts other than genuine Rex-Rotary parts in your Rex-Rotary office product.

### Power Source

220 - 240V, 50/60Hz, 10A or more

Please be sure to connect the power cord to a power source as above. For details about power source, see p.152 "Power Connection".

For safety, please read this manual carefully before you use this product and keep it handy for future reference.



Declaration of Conformity

"The Product complies with the requirements of the EMC Directive 89/336/EEC and the Low Voltage Directive 73/23/EEC."

In accordance with IEC 60417, this machine uses the following symbols for the main power switch:

**I** means **POWER ON.**

**⏻** means **STAND BY.**

## Introduction

This manual describes detailed instructions on the operation and notes about the use of this machine. To get maximum versatility from this machine all operators are requested to read this manual carefully and follow the instructions. Please keep this manual in a handy place near the machine.

For safe and correct use of this machine, please be sure to read the Safety Information before you use it.

### Notes:

Some illustrations may be slightly different from your machine.

Certain options may not be available in some countries. For details, please contact your local dealer.

### Laser Safety:

This machine is considered a class 1 laser device, safe for office/EDP use. The machine contains four AlGaInp laser diodes, 10-milliwatt, 770-810 nanometer wavelength for each emitter. Direct (or indirect reflected ) eye contact with the laser beam might cause serious eye damage. Safety precautions and interlock mechanisms have been designed to prevent any possible laser beam exposure to the operator.

The following label is attached on the back side of the machine.

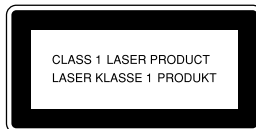

### Warning:

Use of controls or adjustment or performance of procedures other than those specified in this manual might result in hazardous radiation exposure.

### Notes:

The model names of the machines do not appear in the following pages. Check the type of your machine before reading this manual. (For details, see p.15 "Machine Types".)

- Type 1: 6002
- Type 2: 7502

Certain types might not be available in some countries. For details, please contact your local dealer.

Two kinds of size notation are employed in this manual. With this machine refer to the metric version.

For good copy quality, Gestetner recommends that you use genuine Gestetner toner.

Gestetner shall not be responsible for any damage or expense that might result from the use of parts other than genuine Gestetner parts in your Gestetner office product.

### Power Source

220 - 240V, 50/60Hz, 10A or more

Please be sure to connect the power cord to a power source as above. For details about power source, see p.152 "Power Connection".

For safety, please read this manual carefully before you use this product and keep it handy for future reference.



Declaration of Conformity

"The Product complies with the requirements of the EMC Directive 89/336/EEC and the Low Voltage Directive 73/23/EEC."

In accordance with IEC 60417, this machine uses the following symbols for the main power switch:

**I** means **POWER ON.**

**⏻** means **STAND BY.**

## Introduction

This manual describes detailed instructions on the operation and notes about the use of this machine. To get maximum versatility from this machine all operators are requested to read this manual carefully and follow the instructions. Please keep this manual in a handy place near the machine.

For safe and correct use of this machine, please be sure to read the Safety Information before you use it.

### Notes:

Some illustrations may be slightly different from your machine.

Certain options may not be available in some countries. For details, please contact your local dealer.

### Laser Safety:

This machine is considered a class 1 laser device, safe for office/EDP use. The machine contains four AlGaInp laser diodes, 10-milliwatt, 770-810 nanometer wavelength for each emitter. Direct (or indirect reflected ) eye contact with the laser beam might cause serious eye damage. Safety precautions and interlock mechanisms have been designed to prevent any possible laser beam exposure to the operator.

The following label is attached on the back side of the machine.

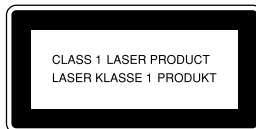

### Warning:

Use of controls or adjustment or performance of procedures other than those specified in this manual might result in hazardous radiation exposure.

### Notes:

The model names of the machines do not appear in the following pages. Check the type of your machine before reading this manual. (For details, see p.15 "Machine Types".)

- Type 1: 6005
- Type 2: 7505

Certain types might not be available in some countries. For details, please contact your local dealer.

Two kinds of size notation are employed in this manual. With this machine refer to the metric version.

For good copy quality, Nashuatec recommends that you use genuine Nashuatec toner.

Nashuatec shall not be responsible for any damage or expense that might result from the use of parts other than genuine Nashuatec parts in your Nashuatec office product.

### Power Source

220 - 240V, 50/60Hz, 10A or more

Please be sure to connect the power cord to a power source as above. For details about power source, see p.152 "Power Connection".

For safety, please read this manual carefully before you use this product and keep it handy for future reference.



Declaration of Conformity

"The Product complies with the requirements of the EMC Directive 89/336/EEC and the Low Voltage Directive 73/23/EEC."

In accordance with IEC 60417, this machine uses the following symbols for the main power switch:

**I** means **POWER ON.**

**⏻** means **STAND BY.**



## Introduction

This manual describes detailed instructions on the operation and notes about the use of this machine. To get maximum versatility from this machine all operators are requested to read this manual carefully and follow the instructions. Please keep this manual in a handy place near the machine.

For safe and correct use of this machine, please be sure to read the Safety Information before you use it.

### Notes:

Some illustrations may be slightly different from your machine.

Certain options may not be available in some countries. For details, please contact your local dealer.

### Laser Safety:

This machine is considered a class 1 laser device, safe for office/EDP use. The machine contains four AlGalnp laser diodes, 10-milliwatt, 770-810 nanometer wavelength for each emitter. Direct (or indirect reflected ) eye contact with the laser beam might cause serious eye damage. Safety precautions and interlock mechanisms have been designed to prevent any possible laser beam exposure to the operator.

The following label is attached on the back side of the machine.



### Warning:

Use of controls or adjustment or performance of procedures other than those specified in this manual might result in hazardous radiation exposure.

### Notes:

The model names of the machines do not appear in the following pages. Check the type of your machine before reading this manual. (For details, see p.15 "Machine Types".)

- Type 1: IS 2060
- Type 2: IS 2075

Certain types might not be available in some countries. For details, please contact your local dealer.

Two kinds of size notation are employed in this manual. With this machine refer to the metric version.

For good copy quality, Infotec recommends that you use genuine Infotec toner.

Infotec shall not be responsible for any damage or expense that might result from the use of parts other than genuine Infotec parts in your Infotec office product.

### Power Source

220 - 240V, 50/60Hz, 10A or more

Please be sure to connect the power cord to a power source as above. For details about power source, see p.152 "Power Connection".

This information is based on our present state of knowledge and is intended to provide general notes on our products and their uses.

It should not therefore be construed as guaranteeing specific properties of the products described or their suitability for particular applications.

Any existing industrial property rights must be observed. The quality of our products is guaranteed under our General Conditions of Sale.

For safety, please read this manual carefully before you use this product and keep it handy for future reference.



Declaration of Conformity

"The Product complies with the requirements of the EMC Directive 89/336/EEC and the Low Voltage Directive 73/23/EEC."

In accordance with IEC 60417, this machine uses the following symbols for the main power switch:

**I** means **POWER ON.**

**⏻** means **STAND BY.**

# TABLE OF CONTENTS

<b>Notice</b> .....	<b>1</b>
<b>Copyrights and Trademarks</b> .....	<b>2</b>
Trademarks .....	2
Information about Installed Software .....	3
<b>How to Read this Manual</b> .....	<b>6</b>
<b>Safety Information</b> .....	<b>8</b>
Safety During Operation.....	8
<b>Positions of Labels and Hallmarks for ⚠WARNING and ⚠CAUTION</b> .....	<b>10</b>
<b>ENERGY STAR Program</b> .....	<b>12</b>
<b>Manuals for this Machine</b> .....	<b>14</b>
<b>Machine Types</b> .....	<b>15</b>

## 1. What You Can Do With This Machine

---

<b>Available Functions</b> .....	<b>17</b>
Copy Mode .....	17
Printer Mode.....	17
Scanner Mode.....	17
Document Server Mode .....	18
User Management.....	20

## 2. Basics

---

<b>Guide To Components</b> .....	<b>21</b>
<b>External Options</b> .....	<b>23</b>
<b>Control Panel</b> .....	<b>24</b>
Display Panel .....	26
<b>Connecting the Machine (Network Connections)</b> .....	<b>27</b>
Requirements.....	28
When the Wireless LAN Board (option) is installed .....	29
Connecting the Network Cable to the Network .....	30
<b>Turning On the Power</b> .....	<b>32</b>
Turning On the Main Power .....	32
Turning On the Power .....	32
Turning Off the Power .....	33
Turning Off the Main Power .....	33
<b>Configuring the Network</b> .....	<b>34</b>
Configuring the Network.....	34
Configuring the Network with the Display Panel .....	36

## 3. Combined Function Operations

---

<b>Changing Modes</b> .....	<b>47</b>
Saving Energy .....	48
Job List.....	49
<b>Multi-Access</b> .....	<b>51</b>

## 4. Document Server

<b>Relationship between Document Server and Other Functions .....</b>	<b>57</b>
Document Server Display .....	57
<b>Using the Document Server .....</b>	<b>58</b>
Scanning and Saving Originals .....	58
Changing a File Name, User Name, or Password .....	61
Selecting a Document .....	61
Searching Saved Documents .....	62
Printing Saved Documents .....	63
Deleting Saved Documents .....	66
<b>Settings for the Document Server .....</b>	<b>67</b>

## 5. User Tools (System Settings)

<b>User Tools Menu (System Settings).....</b>	<b>69</b>
<b>Accessing User Tools (System Settings) .....</b>	<b>74</b>
Changing Settings .....	74
Exiting from User Tools .....	74
<b>Settings You Can Change with User Tools .....</b>	<b>75</b>
General Features .....	75
Tray Paper Settings .....	79
Timer Setting .....	82
Interface Settings/Network .....	84
Interface Settings/Parallel Interface .....	86
Interface Settings/IEEE 1394 (option) .....	87
Interface Settings/IEEE 802.11b (option) .....	88
File Transfer .....	89
Key Operator Tools .....	90
<b>User Codes .....</b>	<b>96</b>
To Register a New User Code .....	97
Changing a User Code .....	98
Clearing a User Code .....	99
Displaying the Counter for Each User Code .....	100
Printing the Counter for Each User Code .....	100
Clearing the Counter .....	101
<b>E-mail Destination.....</b>	<b>102</b>
Registering an E-mail Destination .....	102
Changing a Registered E-mail Destination .....	104
Clearing a Registered E-mail Destination .....	105
<b>Registering E-mail Destinations to a Group.....</b>	<b>106</b>
Registering a New Group .....	106
Registering E-mail Destinations to a Group .....	107
Deleting an E-mail Destination from a Group .....	107
Displaying an E-mail Destination .....	108
Deleting a Group .....	108
Changing a Group Name .....	109
<b>Entering Text.....</b>	<b>110</b>
Available Characters .....	110
Keys .....	110
Entering Text .....	111

## 6. Troubleshooting

---

<b>If Your Machine Does Not Operate as You Want</b> .....	<b>113</b>
General .....	113
Document Server .....	115
<b>📄 Loading Paper</b> .....	<b>116</b>
Loading Paper in Tray 1 (Tandem Tray) .....	116
Loading Paper in Tray 2 and 3 .....	117
Loading Paper in the Large Capacity Tray (LCT) .....	117
Loading Paper in the Interposer .....	118
<b>Suspend Copy when using Finisher 3000B (100-Sheet Staples)</b> .....	<b>119</b>
<b>🖨 Adding Toner</b> .....	<b>120</b>
<b>🔄 Replacing Toner</b> .....	<b>121</b>
<b>🧹 Clearing Misfeeds</b> .....	<b>122</b>
<b>📏 Changing the Paper Size</b> .....	<b>132</b>
Changing the Paper Size in Tray 2 or 3 .....	132
<b>📌 Adding Staples</b> .....	<b>134</b>
Finisher 3000M (50-Sheet Staples), Booklet Finisher .....	134
Booklet Finisher (Saddle Stitch) .....	136
Finisher 3000B (100-Sheet Staples) .....	138
<b>🔧 Removing Jammed Staples</b> .....	<b>140</b>
Finisher 3000M (50-Sheet Staples), Booklet Finisher .....	140
Booklet Finisher (Saddle Stitch) .....	142
Finisher 3000B (100-Sheet Staples) .....	144
<b>🗑 Removing Punch Waste</b> .....	<b>146</b>
Finisher 3000M (50-Sheet Staples), Booklet Finisher .....	146
Finisher 3000B (100-Sheet Staples) .....	147

## 7. REMARKS

---

<b>Do's And Don'ts</b> .....	<b>149</b>
<b>Toner</b> .....	<b>150</b>
Handling Toner .....	150
Toner Storage .....	150
Used Toner .....	150
<b>Where to Put Your Machine</b> .....	<b>151</b>
Machine Environment .....	151
Moving .....	152
Power Connection .....	152
Access to the Machine .....	153
<b>Maintaining Your Machine</b> .....	<b>154</b>
Cleaning the Exposure Glass .....	154
Cleaning the Document Feeder .....	154
<b>Other Functions</b> .....	<b>155</b>
Inquiry .....	155
Changing the Display Language .....	155
Counter .....	156

## 8. Specification

---

<b>Mainframe</b> .....	<b>157</b>
Document Server .....	161
Document Feeder .....	162
<b>Mailbox (option)</b> .....	<b>163</b>
<b>Booklet Finisher (option)</b> .....	<b>164</b>
<b>Finisher 3000M (50-Sheet Staples) (option)</b> .....	<b>167</b>
<b>Finisher 3000B (100-Sheet Staples) (option)</b> .....	<b>169</b>
<b>Copy Tray (option)</b> .....	<b>171</b>
<b>Large Capacity Tray (LCT) (option)</b> .....	<b>172</b>
<b>Interposer (option)</b> .....	<b>173</b>
<b>Punch Unit (option)</b> .....	<b>174</b>
<b>Others</b> .....	<b>176</b>
<b>Copy Paper</b> .....	<b>177</b>
Recommended Paper Sizes and Types.....	177
Non-recommended Paper .....	180
Paper Storage .....	181
<b>INDEX</b> .....	<b>182</b>

# Notice

---

## Important

---

Do not make copies of any item for which copying is prohibited by law.

Copying the following items is normally prohibited by local law:

Bank bills, revenue stamps, bonds, stock certificates, bank drafts, checks, passports, driver's licenses.

This machine is equipped with a function that prevents making counterfeit bank bills. Due to this function the original images similar to bank bills may not be copied properly.

---

## Notice To Wireless LAN Interface (option) Users

---

Notice to Users in EEA Countries

This product complies with the essential requirements and provisions of Directive 1999/5/EC of the European Parliament and of the Council of 9 March 1999 on radio equipment and telecommunications terminal equipment and the mutual recognition of their conformity.

The CE Declaration of Conformity is available on the Internet at URL:

[http://www.rioh.co.jp/fax/ce\\_doc/](http://www.rioh.co.jp/fax/ce_doc/).

This product is only for use in EEA or other authorized countries. Outdoor use of this product in Belgium, France, Germany, Italy, or the Netherlands is prohibited.

# Copyrights and Trademarks

---

## Trademarks

---

Ethernet is a registered trademark of Xerox Corporation.

Microsoft, Windows and Windows NT are registered trademarks of Microsoft Corporation in the United States and/or other countries.

Novell, NetWare and NDS are registered trademarks of Novell, Inc.

PostScript® is a registered trademark of Adobe Systems Incorporated.

Other product names used herein are for identification purposes only and might be trademarks of their respective companies. We disclaim any and all rights in those marks.

The proper names of the Windows operating systems are as follows:

- The product name of Windows® 95 is Microsoft® Windows 95.
- The product name of Windows® 98 is Microsoft® Windows 98.
- The product name of Windows® Me is Microsoft® Windows Millennium Edition (Windows Me).
- The product names of Windows® XP are as follows:  
Microsoft® Windows® XP Professional  
Microsoft® Windows® XP Home Edition
- The product names of Windows® 2000 are as follows:  
Microsoft® Windows® 2000 Advanced Server  
Microsoft® Windows® 2000 Server  
Microsoft® Windows® 2000 Professional
- The product names of Windows NT® 4.0 are as follows:  
Microsoft® Windows NT® Server 4.0
- Microsoft® Windows NT® Workstation 4.0



---

## Information about Installed Software

---

---

### expat

---

- The software including controller, etc. (hereinafter “software”) installed on this product uses the expat Version 1.95.2 (hereinafter “expat”) under the conditions mentioned below.
- The product manufacturer provides warranty and support to the software of the product including the expat, and the product manufacturer makes the initial developer and copyright holder of the expat, free from these obligations.
- Information relating to the expat is available at:  
<http://expat.sourceforge.net/>

Copyright (c) 1998, 1999, 2000 Thai Open Source Software Centre, Ltd. and Clark Cooper.

Permission is hereby granted, free of charge, to any person obtaining a copy of this software and associated documentation files (the “Software”), to deal in the Software without restriction, including without limitation the rights to use, copy, modify, merge, publish, distribute, sublicense, and/or sell copies of the Software, and to permit persons to whom the Software is furnished to do so, subject to the following conditions:

The above copyright notice and this permission notice shall be included in all copies or substantial portions of the Software.

THE SOFTWARE IS PROVIDED “AS IS”, WITHOUT WARRANTY OF ANY KIND, EXPRESS OR IMPLIED, INCLUDING BUT NOT LIMITED TO THE WARRANTIES OF MERCHANTABILITY, FITNESS FOR A PARTICULAR PURPOSE AND NONINFRINGEMENT. IN NO EVENT SHALL THE AUTHORS OR COPYRIGHT HOLDERS BE LIABLE FOR ANY CLAIM, DAMAGES OR OTHER LIABILITY, WHETHER IN AN ACTION OF CONTRACT, TORT OR OTHERWISE, ARISING FROM, OUT OF OR IN CONNECTION WITH THE SOFTWARE OR THE USE OR OTHER DEALINGS IN THE SOFTWARE.

## Copyright Notice of NetBSD

For all users to use this product:

This product contains NetBSD operating system:

For the most part, the software constituting the NetBSD operating system is not in the public domain; its authors retain their copyright.

The following text shows the copyright notice used for many of the NetBSD source code. For exact copyright notice applicable for each of the files/binaries, the source code tree must be consulted.

A full source code can be found at <http://www.netbsd.org/>.

Copyright © 1999, 2000 The NetBSD Foundation, Inc.

All rights reserved.

Redistribution and use in source and binary forms, with or without modification, are permitted provided that the following conditions are met:

- ① Redistributions of source code must retain the above copyright notice, this list of conditions and the following disclaimer.
- ② Redistributions in binary form must reproduce the above copyright notice, this list of conditions and the following disclaimer in the documentation and/or other materials provided with the distribution.
- ③ All advertising materials mentioning features or use of this software must display the following acknowledgment:  
This product includes software developed by the NetBSD Foundation, Inc. and its contributors.
- ④ Neither the name of The NetBSD Foundation nor the names of its contributors may be used to endorse or promote products derived from this software without specific prior written permission.

THIS SOFTWARE IS PROVIDED BY THE NETBSD FOUNDATION, INC. AND CONTRIBUTORS "AS IS" AND ANY EXPRESS OR IMPLIED WARRANTIES, INCLUDING, BUT NOT LIMITED TO, THE IMPLIED WARRANTIES OF MERCHANTABILITY AND FITNESS FOR A PARTICULAR PURPOSE ARE DISCLAIMED. IN NO EVENT SHALL THE FOUNDATION OR CONTRIBUTORS BE LIABLE FOR ANY DIRECT, INDIRECT, INCIDENTAL, SPECIAL, EXEMPLARY, OR CONSEQUENTIAL DAMAGES (INCLUDING, BUT NOT LIMITED TO, PROCUREMENT OF SUBSTITUTE GOODS OR SERVICES; LOSS OF USE, DATA, OR PROFITS; OR BUSINESS INTERRUPTION) HOWEVER CAUSED AND ON ANY THEORY OF LIABILITY, WHETHER IN CONTRACT, STRICT LIABILITY, OR TORT (INCLUDING NEGLIGENCE OR OTHERWISE) ARISING IN ANY WAY OUT OF THE USE OF THIS SOFTWARE, EVEN IF ADVISED OF THE POSSIBILITY OF SUCH DAMAGE.

---

## Authors Name List

---

All product names mentioned herein are trademarks of their respective owners. The following notices are required to satisfy the license terms of the software that we have mentioned in this document:

- This product includes software developed by the University of California, Berkeley and its contributors.
- This product includes software developed by Jonathan R. Stone for the NetBSD Project.
- This product includes software developed by the NetBSD Foundation, Inc. and its contributors.
- This product includes software developed by Manuel Bouyer.
- This product includes software developed by Charles Hannum.
- This product includes software developed by Charles M. Hannum.
- This product includes software developed by Christopher G. Demetriou.
- This product includes software developed by TooLs GmbH.
- This product includes software developed by Terrence R. Lambert.
- This product includes software developed by Adam Glass and Charles Hannum.
- This product includes software developed by Theo de Raadt.
- This product includes software developed by Jonathan Stone and Jason R. Thorpe for the NetBSD Project.
- This product includes software developed by the University of California, Lawrence Berkeley Laboratory and its contributors.
- This product includes software developed by Christos Zoulas.
- This product includes software developed by Christopher G. Demetriou for the NetBSD Project.
- This product includes software developed by Paul Kranenburg.
- This product includes software developed by Adam Glass.
- This product includes software developed by Jonathan Stone.
- This product includes software developed by Jonathan Stone for the NetBSD Project.
- This product includes software developed by Winning Strategies, Inc.
- This product includes software developed by Frank van der Linden for the NetBSD Project.
- This product includes software developed for the NetBSD Project by Frank van der Linden.
- This product includes software developed for the NetBSD Project by Jason R. Thorpe.
- The software was developed by the University of California, Berkeley.
- This product includes software developed by Chris Provenzano, the University of California, Berkeley, and contributors.

# How to Read this Manual

---

## Symbols

---

In this manual, the following symbols are used:

### **WARNING:**

This symbol indicates a potentially hazardous situation that might result in death or serious injury when you misuse the machine without following the instructions under this symbol. Be sure to read the instructions, all of which are included in the Safety Information section .

### **CAUTION:**

This symbol indicates a potentially hazardous situation that might result in minor or moderate injury or property damage that does not involve personal injury when you misuse the machine without following the instructions under this symbol. Be sure to read the instructions, all of which are included in the Safety Information section.

\* The statements above are notes for your safety.

### **Important**

If this instruction is not followed, paper might be misfeed, originals might be damaged, or data might be lost. Be sure to read this.

### **Preparation**

This symbol indicates the prior knowledge or preparations required before operating.

### **Note**

This symbol indicates precautions for operation or actions to take after misoperation.

### **Limitation**

This symbol indicates numerical limits, functions that cannot be used together, or conditions in which a particular function cannot be used.

### **Reference**

This symbol indicates a reference.

[ ]

Keys that appear on the machine's display panel.







[ ]

Keys built into the machine's control panel.

---

## Notice

---

- B4 JIS , B5 JIS , B6 JIS  are referred to as B4 , B5 , B6  in this manual.
- The image of the display panel may be different depending on the installed options.

# Safety Information

When using this machine, the following safety precautions should always be followed.

---

## Safety During Operation

---

In this manual, the following important symbols are used:

**⚠ WARNING:**  
*Indicates a potentially hazardous situation which, if instructions are not followed, could result in death or serious injury.*

**⚠ CAUTION:**  
*Indicates a potentially hazardous situation which, if instructions are not followed, may result in minor or moderate injury or damage to property.*

---

**⚠ WARNING:**

---

- **Connect the power cord directly into a wall outlet and never use an extension cord.**
- **Disconnect the power plug (by pulling the plug, not the cable) if the power cable or plug becomes frayed or otherwise damaged.**
- **To avoid hazardous electric shock or laser radiation exposure, do not remove any covers or screws other than those specified in this manual.**
- **Turn off the power and disconnect the power plug (by pulling the plug, not the cable) if any of the following occurs:**
  - **You spill something into the machine.**
  - **You suspect that your machine needs service or repair.**
  - **The external housing of your machine has been damaged.**
- **Do not incinerate spilled toner or used toner. Toner dust might ignite when exposed to an open flame.**
- **Disposal can take place at our authorized dealer.**
- **Dispose of the used toner bottle in accordance with the local regulations.**
- **Do not remove the toner bottle, fuser unit, duplex unit and paper tray all at once. The machine might fall and cause injury. Make sure to first return each component back to its original position before checking other components.**

---

**⚠ CAUTION:**

---

- *Protect the machine from dampness or wet weather, such as rain and snow.*
- *Unplug the power cord from the wall outlet before you move the machine. While moving the machine, you should take care that the power cord will not be damaged under the machine.*
- *When you disconnect the power plug from the wall outlet, always pull the plug (not the cable).*
- *Do not allow paper clips, staples, or other small metallic objects to fall inside the machine.*
- *Keep toner (used or unused) and toner bottle out of the reach of children.*
- *For environmental reasons, do not dispose of the machine or expended supply waste at household waste collection points. Disposal can take place at an authorized dealer.*
- *The inside of the machine could be very hot. Do not touch the parts with a label indicating the "hot surface". Otherwise, an injury might occur.*
- *Our products are engineered to meet high standards of quality and functionality, and we recommend that you use only the expendable supplies available at an authorized dealer.*

# Positions of Labels and Hallmarks for ⚠WARNING and ⚠CAUTION

This machine has labels and hallmarks for ⚠WARNING, ⚠CAUTION at the positions shown below. For safety, please follow the instructions and handle the machine as indicated.

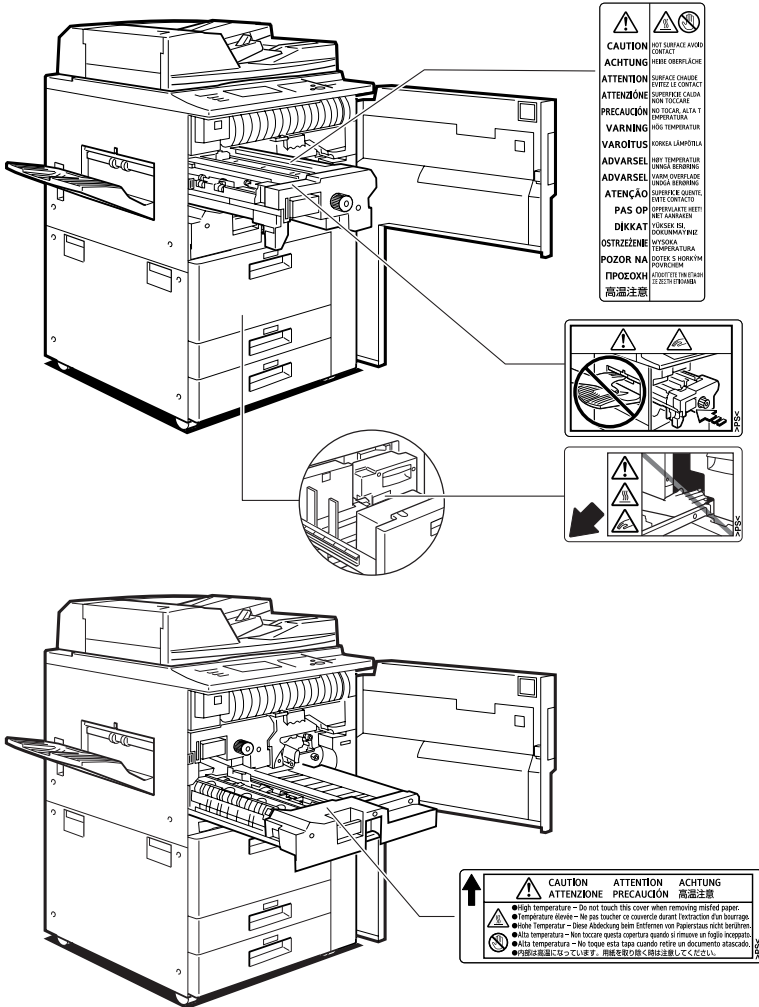



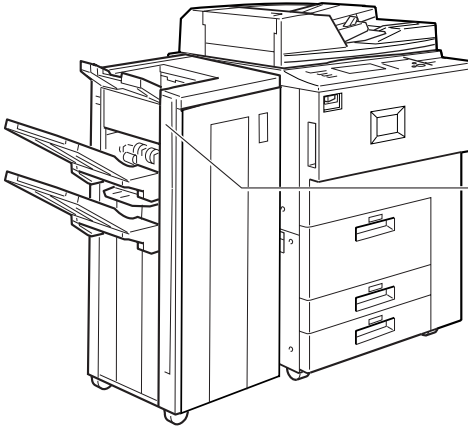
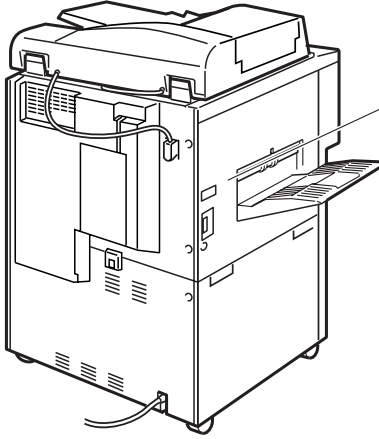

Do not touch the paper exit section of the finisher. It could cause injury.

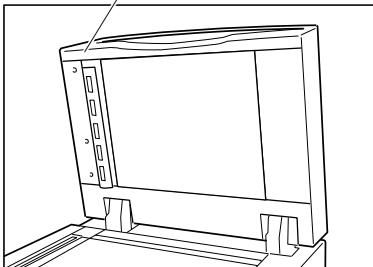

ZGVH462E

# ENERGY STAR Program

ENERGY STAR®



As an ENERGY STAR Partner, we have determined that this machine model meets the ENERGY STAR Guidelines for energy efficiency.

The ENERGY STAR Guidelines intend to establish an international energy-saving system for developing and introducing energy-efficient office equipment to deal with environmental issues, such as global warming.

When a product meets the ENERGY STAR Guidelines for energy efficiency, the Partner shall place the ENERGY STAR logo onto the machine model.

This product was designed to reduce the environmental impact associated with office equipment by means of energy-saving features, such as Low-power mode.

- **Low Power Mode**

This product automatically lowers its power consumption 15 minutes after the last copy or print job has finished. Printing is still possible in Low Power Mode, but if you wish to make copies press the **[Energy Saver]** key first.

 **Reference**

For details about how to change the default interval, see p.82 "Energy Saver Timer".

- **Off Mode (Copier only)**

To conserve energy, this product automatically turns off 90 minutes after the last copying or printing job has been completed. Printing is still possible in Off Mode, but if you wish to make copies press the operation switch first.

 **Reference**

For details about how to change the default interval, see p.82 "Auto Off Timer".

- **Sleep Mode (Printer, Scanner installed)**

If the printer features are installed, this product automatically lowers its power consumption even further 90 minutes after the last copy or print job has finished. Printing is still possible in Sleep Mode, but if you wish to make copies press the operation switch first.

 **Reference**

For details about how to change the default interval, see p.82 "Auto Off Timer".

- **Duplex Priority**  
The ENERGY STAR Program recommends use of the Duplex function. By conserving paper this function helps the environment. For applicable machines, duplex function (one-sided original → two-sided copies) can be selected when the operation switch or the main power switch is turned on, the **[Energy Saver]** key is pressed, or when the machine resets automatically.

 **Reference**

To change the settings of the Duplex Priority mode, see “Duplex Mode Priority” in the Copy Reference.

---

## Specification

---

		Copying function only		Multiple function printer with copying, printing, scanning functions	
		Type 1	Type 2	Type 1	Type 2
Low Power Mode	Power consumption	220 W or less		240 W or less	
	Default interval	15 minutes		15 minutes	
	Recovery Time	30 sec. or less		30 sec. or less	
Off Mode	Power consumption	4 W or less		--	
	Default interval	90 minutes		--	
	Recovery Time	300 sec. or less		--	
Sleep Mode	Power consumption	--		15 W or less	
	Default interval	--		90 minutes	
	Recovery Time	--		300 sec. or less	
Duplex Priority			1 Sided → 1 Sided		

**◆ Recycled Paper**

In accordance with the ENERGY STAR Program, we recommend use of recycled paper which is environmentally friendly. Please contact your sales representative for recommended paper.

# Manuals for this Machine

This is a multi-functional machine combining copier, printer and scanner functions. This manual describes procedures common to these functions. Each function's reference describes the operational procedures for that functions. Please consult the relevant parts of the manual.

## ❖ **General Settings Guide (this manual)**

Provides an overview of the machine. This manual introduces the functions of the machine. It also introduces the options that allow you to use additional functions and describes how to access the system user tools to make the machine easier to use.

## ❖ **Copy Reference**

Describes the procedures and functions for using the machine as a copier.

## ❖ **Printer Kit Type 1075 Printer Reference 1**

Describes system settings, procedures and functions for using the machine as a printer.

## ❖ **Printer Kit Type 1075 Printer Reference 2**

Describes procedures and provides information about using the machine as a printer. This manual is included as a PDF file on the CD-ROM labeled "Operating Instructions".

## ❖ **Network Printing Guide Operating Instructions**

Describes procedures and provides information about setting up and using the machine as a printer in a network environment. We recommend you read this manual first. It is included as a PDF file on the CD-ROM labeled "Operating Instructions".

## ❖ **PostScript 3 Board Type 1075 Operating Instructions Supplement**

Describes menus and features you can set using the PostScript 3 printer driver. This manual is included as a PDF file on the CD-ROM labeled "Operating Instructions".

### **Note**

- Printing with the PostScript 3 printer driver is available when the PostScript 3 board option is installed on your machine.

## ❖ **UNIX Supplement**

Provides information about setting up and using the machine as a printer in a UNIX environment. For UNIX printing information, please visit our web site or consult your authorized dealer.

## ❖ **Scanner Reference**

Describes system settings, procedures and functions for using the machine as a scanner.

### **Note**

- Scanner function is available when the Printer/Scanner option is installed on your machine.

# Machine Types

This machine comes in two models which vary in copy speed. To ascertain which model you have, see the inside front cover.

	Type 1	Type 2
Copy speed	60 copies/minute (A4, 8 <sup>1</sup> / <sub>2</sub> " × 11")	75 copies/minute (A4, 8 <sup>1</sup> / <sub>2</sub> " × 11")



# 1. What You Can Do With This Machine

## Available Functions

You can use this machine as a copier, printer or scanner. This machine also has a Document Server function which has a File Merge Printing and On Demand Printing features.

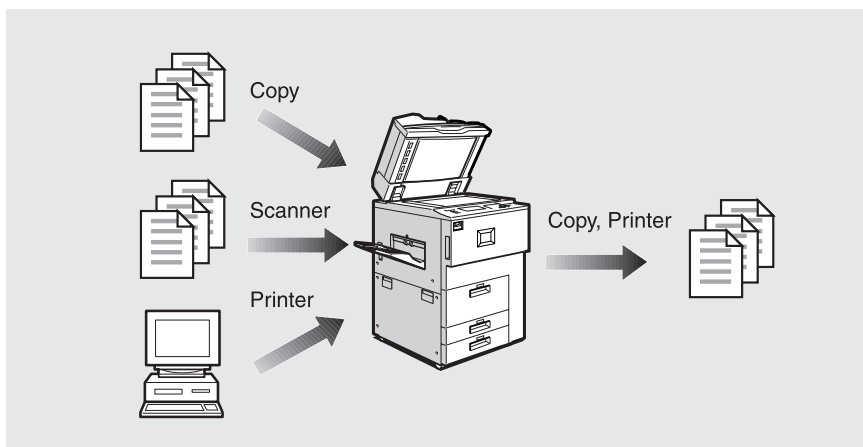

---

### Copy Mode

In copy mode you can make basic copies and also copy using more sophisticated techniques, such as reduction/enlargement or combining several originals onto one copy. You can install several options for using sort, staple and saddle stitch functions.

---

### Printer Mode

You can print documents under various environments.

---

### Scanner Mode

You can use this machine as a network scanner.

It is also possible to e-mail the scanned image as an attached file via the LAN, or Internet.

## Document Server Mode

You can save the documents from copy and printer functions to the hard disk. Documents can be printed later, or the machine can be controlled from the PC.

Scanned documents can be stored on the hard disk, or you can see the document's thumbnails on the PC.

\*1 To see the document's thumbnails on a PC, DeskTopBinder V2 Professional/Lite must be installed. ⇒ p.19 "Operation from a Computer"

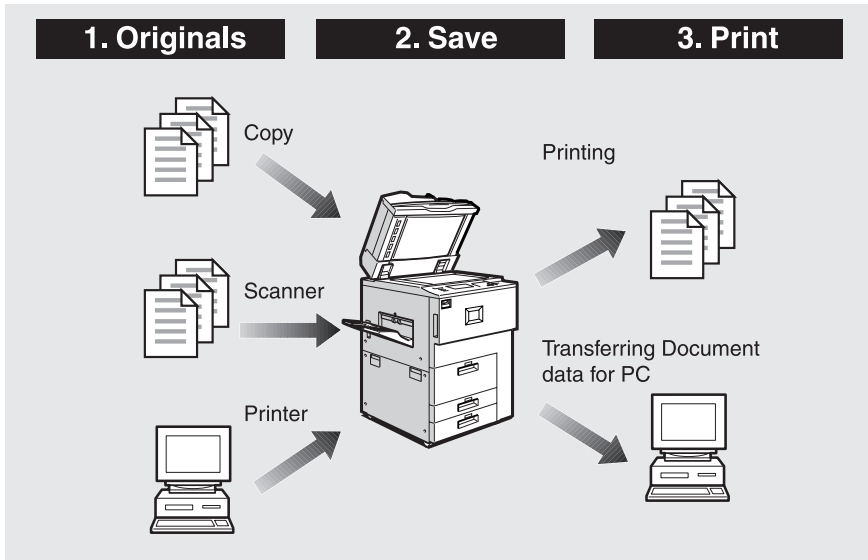

GXDOCUZE

### Note

You can save the following:

- Data from documents scanned using the document feeder
- Data from documents scanned using the exposure glass
- Data sent from a computer
- Data from documents scanned using the scanner function



 **Important**

- ❑ Do not turn off the main power switch when the On indicator is lit or blinking. If you turn it off during an operation, the memory or hard disk might be damaged.
- ❑ Avoid any strong shocks to the machine. This could damage the hard disk or delete stored files. For precautionary reasons, files should be copied to another local computer.
- ❑ Unauthorized access to the Document Server is possible when the network is connected to the Internet. To prevent access to stored confidential documents, set a firewall between the network and the Internet.

 **On Demand Printing**

If you save your document in the Document Server, you can print it out at any time with print settings such as duplex and stapling.

 **File Merge Printing**

You can merge documents, such as those stored on the Document Server, sent from the printer or scanned paper originals.

You can merge documents that were created with different applications or separately on different computers.

 **Operation from a Computer**

If you install DeskTopBinder V2 Professional or DeskTopBinder V2 Lite on your computer, you can check the contents of stored documents, print copies for confirmation and perform other operations.

You can also perform tasks on data stored in the Document Server from your computer, rather than from the machine.

 **Reference**

For more detailed information, refer to DeskTopBinder V2 Professional/Lite manuals.

## User Management

You can limit the users of the machine, and restrict their use of certain functions using user codes.

### Using the User Code

The user is requested to enter a registered user code to operate the machine. You can check the use of the machine by each user.

#### ◆ Managing items

- You can set allowed functions for each user as shown below.
- You can output list of usage amounts for each user.

The functions you can limit are as follows:

Function	Mode	Limitation	Usage amount management
Copy	--	○	○
Printer	--	○	○/Auto program
Scanner	--	○	○(manages the number of scannes)
Document Server	Document Server mode	○	(depending on the mode to store the document) *1

\*1 When you print the documents by pressing the **【Document Server】** key, the copy counter shows the number of copies for the documents stored in copy mode, and the print counter shows the number of documents stored in printer mode.

#### 🔍 Reference

⇒ p.90 “User Code Management”, p.96 “User Codes”

## Guide To Components

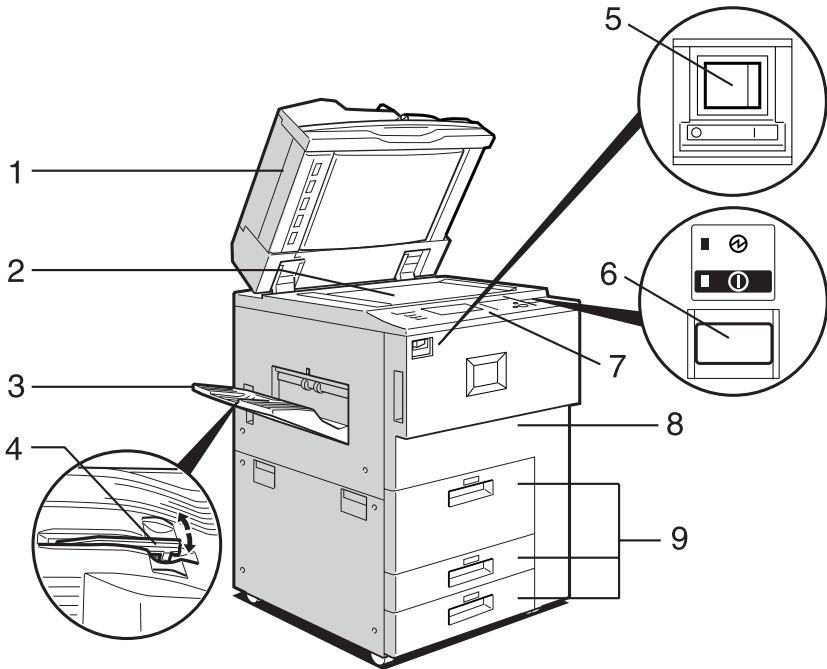

ZGVH310E

### 1. Document feeder (ADF)

Load a stack of originals here. They will be fed automatically one by one.

The front and back side of 2-Sided originals are scanned simultaneously.

### 2. Exposure glass

Place originals face down here for copying.

### 3. Copy tray (option)

Copied paper is delivered here.

### 4. Copy tray guide

When copying onto OHP transparencies and translucent paper, raise the guide. This prevents copies from curling when delivered.

### 5. Main power switch

If the machine does not operate after turning on the operation switch, check if the main power switch is turned on. ⇒ p.32 "Turning On the Power"

## 6. Operation switch

Press this switch to turn the power on (the On indicator lights up). To turn the power off, press this switch again (the On indicator goes off). ⇒ p.32 "Turning On the Power"

## 7. Control panel

⇒ p.24 "Control Panel"

## 8. Front cover

Open to access the inside of the machine.

## 9. Paper tray (tray 1-3)

Load paper here.

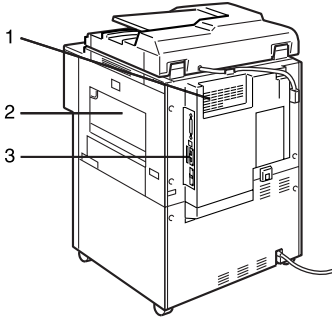

Z0VH332E

## 1. Ventilation holes

Prevent overheating. Do not obstruct the ventilation holes by placing an object near it or leaning things against it. If the machine overheats, a fault might occur.

## 2. Bypass tray

Use when copying onto OHP transparencies, label paper (adhesive labels), translucent paper, postcards and non-standard size paper.

## 3. Interface for network connections

⇒ p.27 "Connecting the Machine (Network Connections)"

# External Options

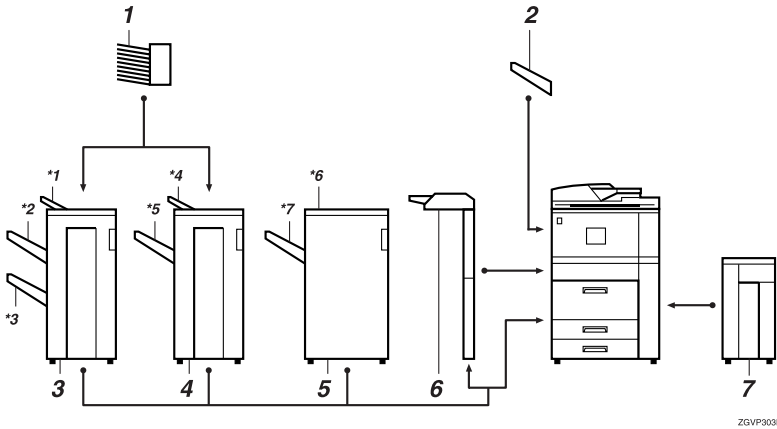

## 1. Mailbox

Sorts printed papers.

\*Mailbox tray 1-9

## 2. Copy tray

Copied paper is delivered here.

## 3. Booklet Finisher

Sorts, stacks, staples and punches copies.

The saddle stitch function is also available.

\*1: Finisher upper tray

\*2: Finisher shift tray 1

\*3: Finisher shift tray 2

## 4. Finisher 3000M (50-Sheet Staples)

Sorts, stacks, staples and punches copies.

\*4: Finisher upper tray

\*5: Finisher shift tray

## 5. Finisher 3000B (100-Sheet Staples)

Sorts, stacks, staples and punches copies.

\*6: Finisher upper tray

\*7: Finisher shift tray

## 6. Interposer

Inserts cover or slip sheets into the copies.

## 7. Large Capacity Tray (LCT)

Holds 4000 sheets of paper.

# Control Panel

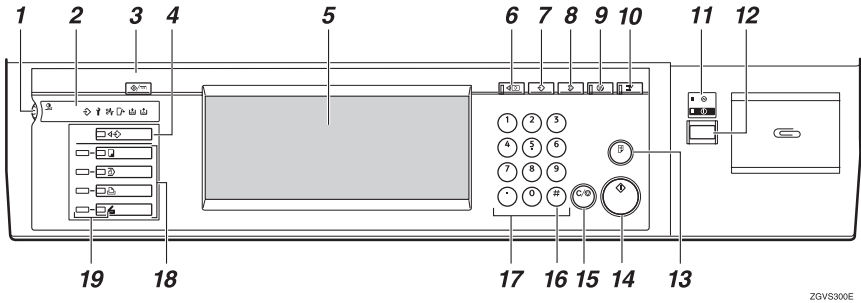

ZGVS300E

## 1. Screen contrast knob

Adjusts the brightness of the display panel.

## 2. Indicators

Show errors and machine status.

⚡: Data In indicator ⇒ p.51 "Multi-Access"

🔧: Service Call indicator

⚠️: Misfeed indicator ⇒ p.122 "Clearing Misfeeds"

🔒: Open Cover indicator

📄: Add Staple indicator ⇒ p.134 "Adding Staples"

🖨️: Add Toner indicator ⇒ p.120 "Adding Toner"

## 3. [User Tools/Counter] key

- User Tools  
Press to change the default settings and conditions to meet your requirements. ⇒ p.74 "Accessing User Tools (System Settings)"
- Counter  
Press to check or print the total number of copies made. ⇒ p.156 "Counter"
- Inquiry  
Press to check where to contact for machine repairs and ordering toner. ⇒ p.155 "Inquiry"

## 4. [Job List] key

Shows the job list.

## 5. Display panel

Shows the operation status, error messages, and function menus.

## 6. [Check Modes] key

Press this key to check settings.

## 7. [Program] key (Copy mode)

Press to register frequently used settings, or to recall registered settings.

## 8. [Clear Modes] key

Press to clear previously entered copy job settings.

## 9. [Energy Saver] key

Press to switch to and from Low Power mode.

## 10. [Interrupt] key (Copy mode)

Press to make interrupt copies during a copy run.

## 11. Main power indicator and On indicator

The main power indicator lights up when the main power switch is turned on.

The On indicator lights up when the power is turned on.

### Important

- ❑ Do not turn off the power while the On indicator is blinking. Doing so may damage the hard disk.

## 12. Operation switch

Press this switch to turn the power on (the On indicator lights up). To turn the power off, press this switch again (the On indicator goes off).

## 13. **[Sample Copy]** key

Press to make a single set of copies or prints to check for poor copying or printing before making multiple sets.

## 14. **[Start]** key

Press to start copying, scanning, or printing documents stored on the Document Server.

## 15. **[Clear/Stop]** key

- Clear  
Press to delete a number entered.
- Stop  
Press to stop a job such as scanning originals, or printing in progress.

## 16. **[#]** key

Press to enter a value.

## 17. Number keys

Use to enter the desired number of copies.

## 18. Function keys

Press to select the following functions:

- Copy
- Document Server
- Printer
- Scanner

## 19. Function Status indicator

These show the status of the above functions:

- Yellow: the function is selected.
- Green: the function is active.
- Red: the function has been interrupted.

---

## Display Panel

---

The display panel shows machine status, error messages and function menus.

### Important

A force or impact of more than 30 N (about 3 kgf) will damage the display panel.

The default setting is to display the screen for copying when you turn the power on.

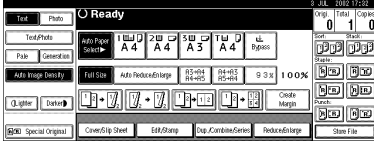

The function items displayed serve as selector keys. You can select or specify an item by lightly pressing them.

When you select or specify an item on the display panel, it is highlighted like  Full Size. Keys appearing as  OK cannot be used.

---

### Common Key Operations

---

The following keys are common to all screens.

#### ◆ Key list

[OK]	Acknowledges a selected function or entered values, and then returns to the previous screen.
[Cancel]	Deletes a selected function or entered values, and then returns to the previous screen.
[▲Prev.], [▼Next]	Moves to the previous page or the next page when all functions cannot be displayed on one page.
[OK] [Yes]	Closes message screens.
[Clear]	Clears entered values and does not change the screen.
[Exit]	Returns to the previous screen.



# Connecting the Machine (Network Connections)

2

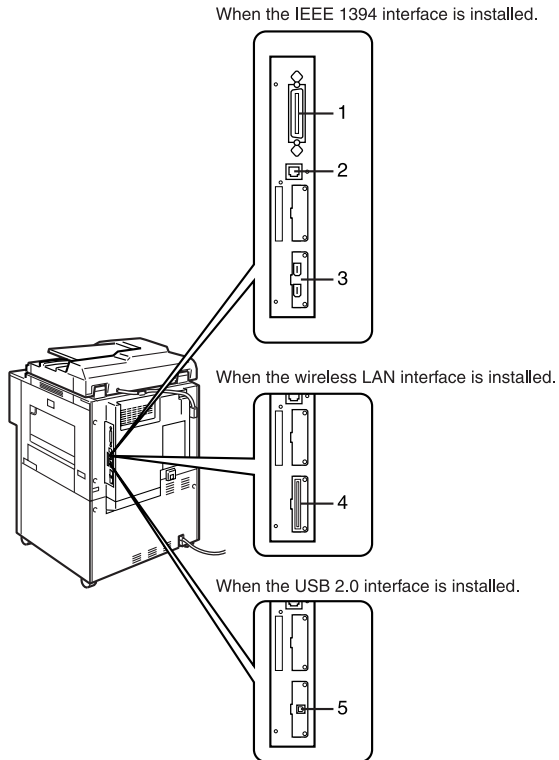

ZGVH342E

## 1. Parallel port

Port for connecting the parallel interface cable.

⇒ “Connecting the Machine” in the Printer Reference 1

## 2. 10BASE-T/100BASE-TX port

Port for connecting the 10BASE-T or 100BASE-TX cable.

## 3. IEEE 1394 ports (option)

Port for connecting the IEEE 1394 interface cable.

## 4. Wireless LAN port (option)

Port for using the wireless LAN.

## 5. USB port (option)

Port for connecting the USB 2.0 interface cable.

⇒ “Connecting the Machine” in the Printer Reference 1

## Requirements

### Requirements

Before using this machine, make sure all environmental and electrical requirements have been met. Connect the machine to the host computer using the parallel port, network interface board, or both.

Make sure you have all the cables, connectors, and electrical outlets necessary to attach the machine to the host computer or network.

#### Important

- The interface cable is not supplied. The user is required to provide the interface cable appropriate for the computer being used.

### Network cable requirements

The network interface board can be installed to allow direct connection to an Ethernet network.

The network interface board supports 10BASE-T or 100BASE-TX connections.

The IEEE 1394 Interface Board (option) supports the IEEE 1394 interface cable.

You can use the machine in the following network environments:

- Using the appropriate network management software and printer drivers
- Attaching the machine to a network computer set up as a server

<b>Client</b>	Windows 95/98/Me, Windows 2000/XP, Windows NT 4.0 <sup>*1</sup> , Mac OS <sup>*2</sup> (optional PostScript 3 Board Type 1075 is required), UNIX <sup>*3</sup>
<b>Driver</b>	PCL 6/5e, RPCS™, PostScript 3
<b>File Server</b>	NetWare 3.x, NetWare 4.x, NetWare 5/5.1
<b>Protocol</b>	TCP/IP, IPX/SPX, NetBEUI <sup>*3</sup> , AppleTalk

<sup>\*1</sup> Under Windows NT 4.0, only × 86 CPUs are supported.

<sup>\*2</sup> For information about usable versions of the Mac OS, see the Printer Reference 1.

<sup>\*3</sup> Connecting UNIX printing information, please visit our web site or consult your authorized dealer.

<sup>\*4</sup> Under Windows 95/98/Me, Windows 2000/XP and Windows NT 4.0 only. Only for Peer-Peer Printing. SmartnetMonitor for Client is required to use the NetBEUI protocol.

In a mixed network environment, protocols switch automatically.

#### Reference

For more information about network connection settings, see p.69 “User Tools (System Settings)”.

 **Note**

- Consult your network administrator before connecting the machine to a network.
- Make sure to use a properly shielded and grounded cable (UTP, STP, Category/Type5) for the connection to the host computer (and/or HUB) in order to meet FCC and EMC Directive 89/336/EEC emission guidelines.

---

## When the Wireless LAN Board (option) is installed

---

2

When using the Wireless LAN Interface on the network, keep the following points in mind:

❖ **Attach both antennas as a unit.**

❖ **When moving the machine**

Detach the antennas when relocating the machine locally.

After moving the machine, reattach the antennas, ensuring that:

- The antennas are positioned clear of obstacles.
- There is 40 to 60 mm between the antennas, so that they do not touch.
- The exposure glass cover and Document Feeder (ADF) do not knock the antennas.

❖ **If the network area provides poor radio environment**

Where radio wave conditions are bad, the network may not function due to interrupted or failed connections. When checking the Wireless LAN Signal and the access point, follow these steps to improve the situation:

- Position the access point nearer to the machine.
- Clear the space between access point and machine of obstructions.
- Move radio wave generating appliances, such as microwaves, away from the machine and access point.

 **Reference**

To check the machine's radio wave status, press **[Wireless LAN Signal]** in System Settings.⇒ p.88 "Wireless LAN Signal"

For more information about access point radio wave conditions, refer to the access point manual.

## Connecting the Network Cable to the Network

### ⚠ Limitation

- ❑ The IEEE 1394 Interface Board (option), the Wireless LAN Board (option) or USB 2.0 Interface Board (option) cannot be installed at the same time.

### 📝 Note

- ❑ Connect the machine to the computer. Set the network connection settings, and then install any necessary software such as printer drivers. For details, see the Printer Reference 1.

## Connecting to the Ethernet Interface

### 📝 Note

- ❑ Rating voltage of the interface connector: Max. DC 5V

**1** Turn off the main power switch.

**2** Attach the Ethernet interface cable to the 10BASE-T/100BASE-TX port.

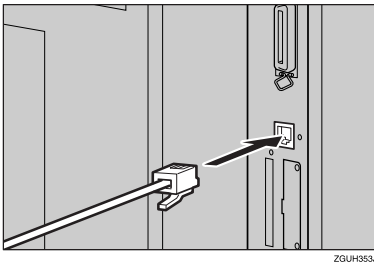

**3** Turn on the main power switch.

### ◆ Indicators on Network Interface Board

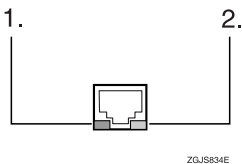

#### 1. Indicator (green)

Remains green when the machine is connected to the network correctly.

#### 2. Indicator (yellow)

Turns yellow when 100 BASE-TX is operating.  
Turns off when 10 BASE-T is operating.

## Connecting to the IEEE 1394 Interface (option)

### Important

- Before making the connection, touch the metallic part to dissipate static electricity.

### Note

- Use the interface cable supplied with the IEEE 1394 Interface Board (option).
- The interface cable should not be looped.

### 1 Attach the IEEE 1394 interface cable to the IEEE 1394 ports.

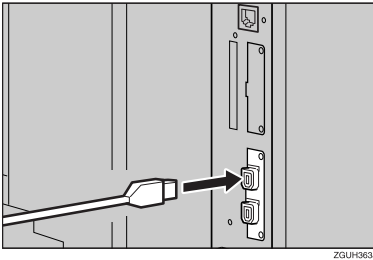

### Note

- Two interface ports are available for attaching the IEEE 1394 interface cable.

## Connecting to the USB 2.0 Interface (option)

### 1 Attach the USB 2.0 interface cable to the USB port.

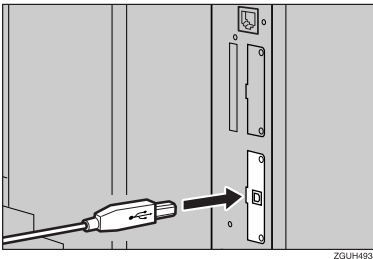

### Important

- The interface cable is not supplied. It is your responsibility to provide the interface cable appropriate for the computer that you are using.

### Reference

For more information about the USB interface cable, see the Printer Reference 1.

# Turning On the Power

This machine has two power switches.

**❖ Operation switch (right side of the control panel)**

Press this switch to activate the machine. When the machine has warmed up, you can make copies.

**❖ Main power switch (left side of the machine)**

When the machine is not to be used for an extended period of time, turn off the main power switch.

**Note**

- ❑ This machine automatically enters Low Power mode or turns itself off if you do not use it for a certain period. ⇒ p.82 "Auto Off Timer" , p.82 "Energy Saver Timer"

## Turning On the Main Power

- 1** Make sure that the power cord is firmly plugged into the wall outlet.
- 2** Open the switch cover and turn on the main power switch (make sure that the Main Power indicator lights up).

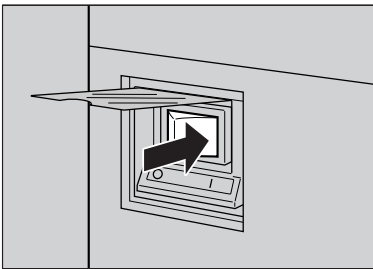

Z0YH391E

**Important**

- ❑ Do not turn off the main power immediately after it has been turned on. Failure to observe this may result in damage to the hard disk or memory, leading to malfunction.

## Turning On the Power

- 1** Press the operation switch to make the On indicator light up.

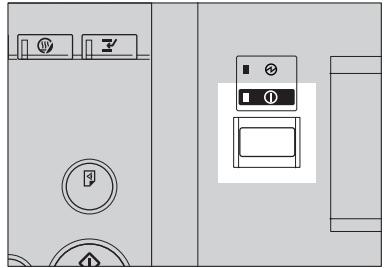

Z6V8310E

**Note**

- ❑ If the power is not turned on when the operation switch is pressed, check if the main power switch is on. If off, turn it on.

## Turning Off the Power

- 1 Press the operation switch to make the On indicator go off.

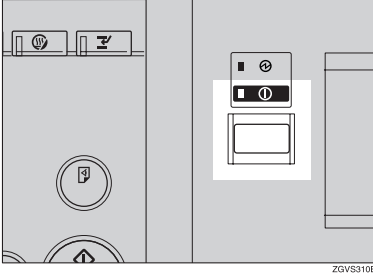

### Note

- Even if you press the operation switch, the indicator does not go off and blinks in the following cases:
  - When communication is in progress with external equipment.
  - When the hard disk is operating.

## Turning Off the Main Power

### Important

- Do not turn off the main power switch when the On indicator is on or blinking. Failure to observe this may result in damage to the hard disk or memory, leading to malfunction.
- Pull out the power cord after you turn off the main power switch. Failure to observe this may result in damage to the hard disk or memory, leading to malfunction.

- 1 Make sure the On indicator is off.
- 2 Open the switch cover, and turn off the main power switch to make the main power indicator go off.

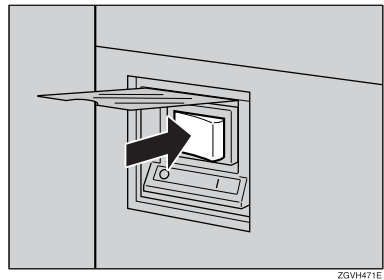

# Configuring the Network

## Configuring the Network

### Preparation

This section describes the network settings using the System Settings menu. Required setting items depend on the mode to be used.

Mode	Network Environment	Network Settings	Reference
Scanner (Network Twain Scanner) Mail Transfer	TCP/IP	IP Address, Subnet Mask, Gateway Address, Network Boot, Effective Protocol, Interface Select  (The settings must be made from the PC. Make the SMTP server name, SMTP port number and DNS server settings using a Web browser.)	⇒ p.37 “When using TCP/IP”, p.38 “Acquiring the IP Address from the DHCP Server”, “Making E-mail Settings”, Scanner Reference
	IEEE 1394 *3	IP Address, Subnet Mask, Gateway Address, Effective Protocol (TCP/IP), IP over 1394  (The settings must be made from the PC. Make the SMTP server name, SMTP port number and DNS server settings using a Web browser.)	⇒ p.37 “When using TCP/IP”, p.39 “When using the IEEE 1394 Interface (option)”, “Making E-mail Settings”, Scanner Reference
	Wireless LAN *4	IP Address, Subnet Mask, Gateway Address, Network Boot, Effective Protocol, Interface Select, Communication Mode, Channel, WEP, SSID  (The settings must be made from the PC. Make the SMTP server name, SMTP port number and DNS server settings using a Web browser.)	⇒ p.37 “When using TCP/IP”, p.41 “When using the Wireless LAN Interface (option) in Ad hoc Mode”, p.42 “When using the Wireless LAN Interface (option) in Infrastructure Mode”, “Making E-mail Settings”, Scanner Reference
Scanner (Network Delivery Scanner)	TCP/IP	IP Address, Subnet Mask, Gateway Address, Network Boot, Effective Protocol, Interface Select, Delivery Option	⇒ p.37 “When using TCP/IP”, p.38 “Acquiring the IP Address from the DHCP Server”
	IEEE 1394 *3	IP Address, Subnet Mask, Gateway Address, Effective Protocol (TCP/IP), IP over 1394, Delivery Option	⇒ p.37 “When using TCP/IP”, p.39 “When using the IEEE 1394 Interface (option)”



Mode	Network Environment	Network Settings	Reference
Scanner (Network Delivery Scanner)	Wireless LAN <sup>*4</sup>	IP Address, Subnet Mask, Gateway Address, Network Boot, Effective Protocol, Interface Select, Communication Mode, Channel <sup>*5</sup> , WEP, SSID <sup>*6</sup> , Delivery Option	⇒ p.37 “When using TCP/IP”, p.41 “When using the Wireless LAN Interface (option) in Ad hoc Mode”, p.42 “When using the Wireless LAN Interface (option) in Infrastructure Mode”
Printer	TCP/IP <sup>*1</sup>	IP Address, Subnet Mask, Gateway Address, Network Boot, Effective Protocol, Interface Select	⇒ p.37 “When using TCP/IP”, p.38 “Acquiring the IP Address from the DHCP Server”
	NetWare <sup>*1 *2</sup>	Effective Protocol, NW Frame Type	⇒ p.38 “When using NetWare”
	IEEE 1394 <sup>*3</sup>	IP Address, Subnet Mask, Gateway Address, Effective Protocol (TCP/IP), IP over 1394	⇒ p.37 “When using TCP/IP”, p.39 “When using the IEEE 1394 Interface (option)”
	Wireless LAN <sup>*4</sup>	IP Address, Subnet Mask, Gateway Address, Network Boot, Effective Protocol, Interface Select, Communication Mode, Channel <sup>*5</sup> , WEP, SSID <sup>*6</sup>	⇒ p.37 “When using TCP/IP”, p.41 “When using the Wireless LAN Interface (option) in Ad hoc Mode”, p.40 “When using the Wireless LAN Interface (option) in 802.11 Ad hoc Mode”, p.42 “When using the Wireless LAN Interface (option) in Infrastructure Mode”

<sup>\*1</sup> Make necessary settings for your network environment. For details about settings, see the Network Printing Guide.

<sup>\*2</sup> Configure TCP/IP when you use pure IP of NetWare 5/5.1.

<sup>\*3</sup> You will need the IEEE 1394 Interface Board (option).

<sup>\*4</sup> You will need the IEEE 802.11b Interface kit (option).

<sup>\*5</sup> Make necessary settings when the communication mode is Ad hoc Mode.

<sup>\*6</sup> Make necessary settings when the communication mode is 802.11 Ad hoc Mode.

### Note

- In a network environment using TCP/IP, you can use SmartNetMonitor to configure IP addresses for Admin and the web browser packaged with Printer Controller or Printer/Scanner Controller. For details about Smart Net Monitor, see the Network Printing Guide.
- For details on setting values, see p.75 “Settings You Can Change with User Tools”.

## Configuring the Network with the Display Panel

This section describes basic procedures. Please make the settings appropriate for the functions and network you are using.

### Important

- These settings should be made by the systems administrator or after consulting with the systems administrator.

### Note

- In this manual, minimum settings for network connections are described. For more details, see the Network Printing Guide.

For default settings, see p.75 “Settings You Can Change with User Tools”.

- ◆ “Interface Settings/Network” ⇒ p.84
- ◆ “Interface Settings/IEEE 1394 (option)” ⇒ p.87
- ◆ “Interface Settings/IEEE 802.11b (option)” ⇒ p.88
- ◆ “File Transfer” ⇒ p.89

## Network Settings

The following describes the settings required to use the machine in a network. For more information about the settings, see p.84 “Interface Settings/Network”.

- 1** Press the **[User Tools/Counter]** key.

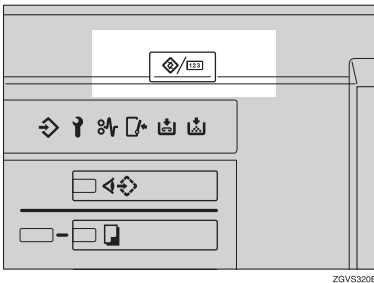

ZGVSS20E

- 2** Press the **[System Settings]** key.

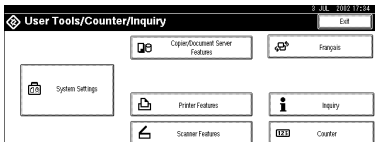

- 3 Press the [Interface Settings] key.
- 4 Make the [Effective Protocol] settings.

 **Note**

- You must configure IP address for using TCP/IP protocol. Consult the network administrator for help with the address. You don't have to configure it if Network Boot is DHCP.
  - Press the [Invalid] key for redundant protocols.
  - Press the [Effective] key for TCP/IP protocol when you use pure IP of NetWare 5/5.1.
- 1 Make sure that the [Network] key is selected, and then press the [Effective Protocol] key.

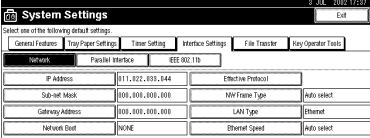

System Settings			
Select one of the following default settings:			
General Features	Trap/Paper Settings	Timer Settings	Interface Settings
Network		Packet Interface	IEEE 802.1D
IP Address	111.022.031.044	Effective Protocol	
Sub-net Mask	001.001.001.000	MII Frame Type	Auto select
Gateway Address	001.001.001.000	LAN Type	Ethernet
Network Card	NONE	Ethernet Speed	Auto select

- 2 Press the [Effective] or [Invalid] key for each protocol.
  - 3 Press the [OK] key.
- The following operation will be different, according to each protocol.

## When using TCP/IP

- 1 Make sure that the [Network] key is selected, and then press the [IP Address] key.

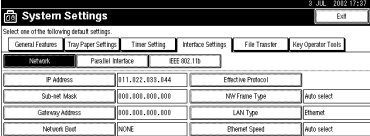

System Settings			
Select one of the following default settings:			
General Features	Trap/Paper Settings	Timer Settings	Interface Settings
Network		Packet Interface	IEEE 802.1D
IP Address	111.022.031.044	Effective Protocol	
Sub-net Mask	001.001.001.000	MII Frame Type	Auto select
Gateway Address	001.001.001.000	LAN Type	Ethernet
Network Card	NONE	Ethernet Speed	Auto select

- 2 Use the number keys to enter the IP address.
  -  **Note**
  - Press the [←] or [→] key to move in 3-digit increments.
  - Press the [Clear] key if the wrong address is entered.
- 3 Press the [OK] key.
- 4 Make the [Sub-net Mask] and [Gateway Address] settings. For each item, press the corresponding button on the screen shown in step 1, and then perform the same procedure as described in steps 2 and 3.

## Acquiring the IP Address from the DHCP Server

To use the DHCP server to acquire the IP address, select **[DHCP]** from **[Network Boot]**.

 **Note**

- You need to make settings when you use DHCP. See “Using DHCP” in the Network Printing Guide.
- To always assign the same IP address to the machine, reserve the IP address for the machine on the DHCP server. See “Using DHCP” in the Network Printing Guide.
- Use the default IP address.
- 1** Make sure that the **[Network]** key is selected, and then press the **[Network Boot]** key.

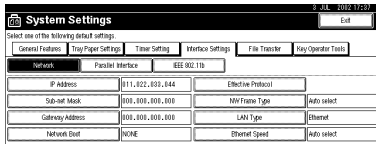

- 2** Press the **[DHCP]** key, and then press the **[OK]** key.

## When using NetWare

To use the machine on NetWare, be sure to select the type of **[NW Frame Type]**.

You can select the following frame types:

- Auto Select (Default)
- Ethernet II
- Ethernet 802.2
- Ethernet 802.3
- Ethernet SNAP

 **Note**

- Make sure to select the frame type same as the file server.
- When you select “Auto Select”, the frame type detected upon startup is automatically set. Therefore, your desired frame type may not be selected by the system, which supports multiple frame types. Select the desired frame type.
- To use the machine in a pure IP environment on NetWare 5/5.1, select **[Effective]** for TCP/IP in step **4**.

- 1 Make sure that the [Network] key is selected, and then press the [NW Frame Type] key.

The screenshot shows the 'System Settings' dialog box with the 'Network' tab selected. The 'IEEE 802.11b' sub-tab is active. The settings are as follows:

IP Address	192.168.146.200	Effective Protocol	
Sub-net Mask	255.255.255.000	MW Frame Type	Auto select
Gateway Address	192.168.146.001	LAM Type	Ethernet
Network Card	NONE	Ethernet Speed	Auto select

- 2 Select the Frame Type, and then press the [OK] key.

When using the IEEE 1394 Interface (option)

### Note

- When you use the IEEE 1394 Interface, you cannot use the DHCP. You must set the fixed IP address.
- Be sure to set the IP over 1394 to "Effective". The default is set to "Effective".

### Reference

When you use parallel printing, see the Printer Reference.

- 1 Make sure that the [Network] key is selected, and then press the [IEEE 1394] key.

The screenshot shows the 'System Settings' dialog box with the 'Network' tab selected. The 'IEEE 1394' sub-tab is active. The settings are as follows:

IP Address	192.168.146.200	Effective Protocol	
Sub-net Mask	255.255.255.000	MW Frame Type	Auto select
Gateway Address	192.168.146.001	Ethernet Speed	Auto select
Network Card	NONE		

- 2 Press the [IP Address] key.

The screenshot shows the 'System Settings' dialog box with the 'Network' tab selected. The 'IEEE 1394' sub-tab is active. The settings are as follows:

IP Address	000.000.000.000	Directional SCSI print	ON
Sub-net Mask	000.000.000.000		
IP over 1394	Active		
SCSI print (USB-2)	Active		

- 3 Use the number keys to enter the IP address, and then press the [OK] key.
- 4 Press the [Sub-net Mask] key.
- 5 Use the number keys to enter the Subnet Mask, and then press the [OK] key.
- 6 Press the [IP over 1394] key.
- 7 Make sure that [Active] is selected, and then press the [OK] key.

### Note

- If [Active] is not selected, press the [Active] key, and then press the [OK] key.

## When using the Wireless LAN Interface (option) in 802.11 Ad hoc Mode

Make sure to set 802.11 Ad hoc Mode, when SSID is necessary in Ad hoc Mode. If encrypted transmission is used, make sure to set WEP after SSID.

 **Note**

- You can set the 802.11 Ad hoc Mode from your computer when setting SSID (Network Name).
  - The network administrator must check the environment and set the Communication mode, WEP key and SSID correctly. For details on settings, see “Using the IEEE 802.11b (Wireless LAN)” in the Network Printing Guide.
  - Characters used for setting SSID are <ASCII 0x20 to 0x7e> which are case-sensitive. You can enter up to 32 characters.
  - You can also set 802.11 Ad hoc mode from the Web browser. For details on settings, see the Network Printing Guide.
- 1** Make sure that [Network] is selected, and then press [LAN Type] key.

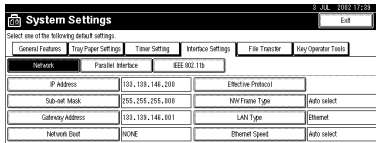

- 2** Press the [IEEE 802.11b] key, and then press the [OK] key.
- 3** Press the [IEEE 802.11b] key.

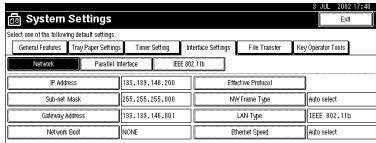

- 4** Press the [Communication Mode] key.



- 5** Press the [802.11 Ad hoc] key, and then press the [OK] key.
- 6** Press the [Channel] key.
- 7** Use the number keys to enter the channel to be used, and then press the [OK] key.
- 8** Press the [SSID Setting] key.
- 9** Press [Enter SSID] and enter the SSID, and then press the [OK] key.
- 10** Press the [OK] key.

## When using the Wireless LAN Interface (option) in Ad hoc Mode

### Note

- ❑ You can set Ad hoc Mode when you do not set SSID (Network Name) from your computer. In this case, setting SSID from this machine is ineffective.
  - ❑ The network administrator must check the environment and set the Communication mode and Channel correctly. For details on settings, see “Using the IEEE 802.11b (Wireless LAN)” in the Network Printing Guide.
  - ❑ Characters used for setting SSID are <ASCII 0x20 to 0x7e> which are case-sensitive. You can enter up to 32 characters.
  - ❑ You can set the Ad hoc mode from the Web browser. For details on settings, see the Network Printing Guide.
- 1 Make sure that the [Network] key is selected, and then press the [LAN Type] key.

The screenshot shows the 'System Settings' window with the 'Network' tab selected. Under the 'IEEE 802.11b' sub-tab, the 'LAN Type' is set to 'Ethernet'.

System Settings			
Select one of the following default settings.			
General Features		Tray Paper Settings	
Network		IEEE 802.11b	
IP Address	193.193.146.200	Effective Protocol	
Sub-net Mask	255.255.255.000	Min Frame Type	Auto select
Gateway Address	193.193.146.001	LAN Type	Ethernet
Network Card	None	Ethernet Speed	Auto select

- 2 Press the [IEEE 802.11b] key, and then press the [OK] key.
- 3 Press the [IEEE 802.11b] key.

The screenshot shows the 'System Settings' window with the 'Network' tab selected. Under the 'IEEE 802.11b' sub-tab, the 'LAN Type' is set to 'IEEE 802.11b'.

System Settings			
Select one of the following default settings.			
General Features		Tray Paper Settings	
Network		IEEE 802.11b	
IP Address	193.193.146.200	Effective Protocol	
Sub-net Mask	255.255.255.000	Min Frame Type	Auto select
Gateway Address	193.193.146.001	LAN Type	IEEE 802.11b
Network Card	None	Ethernet Speed	Auto select

- 4 Press the [Communication Mode] key.

The screenshot shows the 'System Settings' window with the 'Network' tab selected. Under the 'IEEE 802.11b' sub-tab, the 'Communication Mode' is set to '802.11 Ad hoc'.

System Settings			
Select one of the following default settings.			
General Features		Tray Paper Settings	
Network		IEEE 802.11b	
Communication Mode	802.11 Ad hoc		
SSID Setting	SSID		
Channel	1.1	Wireless LAN Signal	
WEP (Encryption) Setting	Inactive	1/2	A 0% Lock ▼ Next

- 5 Press the [Ad hoc] key, and then press the [OK] key.
- 6 Press the [Channel] key.
- 7 Use the number keys to enter the channel to be used, and then press the [OK] key.

## When using the Wireless LAN Interface (option) in Infrastructure Mode

### Note

- ❑ The network administrator must check the environment and set the Communication mode, WEP key, and SSID correctly. For details on settings, see “Using the IEEE 802.11b (Wireless LAN)” in the Network Printing Guide.
  - ❑ Enter the WEP key in hexadecimal. You can enter 10-digits for 64-bit data or 26-digits for 128-bit data.
  - ❑ Characters used for setting SSID are <ASCII 0x20 to 0x7e> which are case-sensitive. You can enter up to 32 characters.
  - ❑ You can also set the Infrastructure mode from the Web browser. For details on settings, see the Network Printing Guide.
- ① Make sure the [Network] key is selected, and then press the [LAN Type] key.

The screenshot shows the 'System Settings' window with the 'Network' tab selected. Under 'Interface Settings', 'IEEE 802.11b' is highlighted. The 'LAN Type' is set to 'Ethernet'.

IP Address	193.189.146.200	Effective Protocol	
Sub-net Mask	255.255.255.000	MW Frame Type	Auto select
Gateway Address	193.189.146.001	LAN Type	Ethernet
Network Card	NONE	Ethernet Speed	Auto select

② Press the [IEEE 802.11b] key, and then press the [OK] key.

③ Press the [IEEE 802.11b] key.

This screenshot is identical to the previous one, showing the 'System Settings' window with 'IEEE 802.11b' selected under 'Interface Settings' and 'Ethernet' as the 'LAN Type'.

④ Press the [Communication Mode] key.

The screenshot shows the 'System Settings' window with the 'Communication Mode' set to '802.11-40 sec'. The 'SSID Setting' is 'ASCII', and 'WEP (Encryption) Setting' is 'Inactive'.

Communication Mode	802.11-40 sec		
SSID Setting	ASCII		
Channel	1	Wireless LAN Signal	
WEP (Encryption) Setting	Inactive	1/2	4/128-bit

⑤ Press the [Infrastructure] key, and then press the [OK] key.

⑥ Press the [SSID Setting] key.

⑦ Press the [Enter SSID] key.

⑧ Enter the SSID, and then press the [OK] key.

⑨ Press the [OK] key.

⑩ Press the [WEP (Encryption) Setting] key if setting is required.

⑪ Press [Enter WEP key] and enter the WEP key, and then press the [OK] key.

⑫ Press the [Active] key.

⑬ Press the [OK] key.



**5** Press the [Exit] key.

**6** Print the list of entered settings if necessary.

 **Note**

- It will take up to 20 seconds for SSID to become active after it has been set.

 **Reference**

For details about List/Test Print, see “Printer Features Menu” in the Printer Reference 2.

**1** Press the [Printer Features] key.

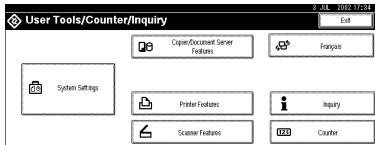

**2** Press the [Config. Page] key.

The system settings list is printed.

**7** Press the [User Tools/Counter] key.

The new settings become effective and the display returns to the main function menu.

## File Transfer Settings

The following describes the file transfer settings required for the scanner function. For more information about the settings, see p.89 “File Transfer”.

**1** Press the [User Tools/Counter] key.

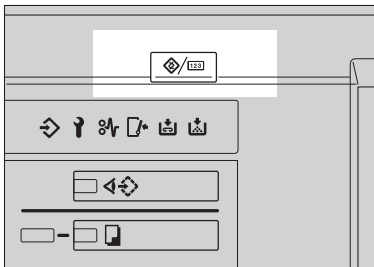

ZGV5320E

**2** Press the [System Settings] key.

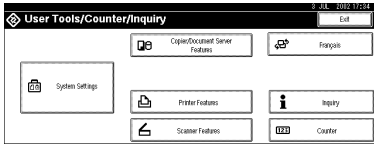

**3** Press the [File Transfer] key.

Assigning a Delivery Option

**1** Press the [Delivery Option] key.

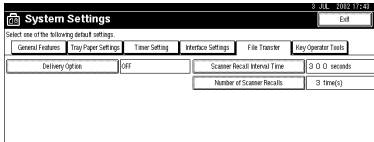

**2** Press the [ON] key.

**3** Press the [OK] key.

**Note**

- You must set the delivery server IP address through ScanRouter V2 Lite/Professional. You cannot set the address from the machine.
- The delivery server IP address set through ScanRouter V2 Lite/Professional will be displayed on the machine.

Setting the Recall Interval Time

**1** Press the [Scanner Recall Interval Time] key.

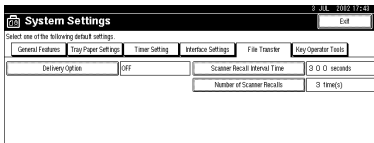

**2** Use the number keys to enter the recall interval time, and then press the [OK] key.

---

## Setting the Number of Recalls

---

- 1 Press the **[Number of Scanner Recalls]** key.

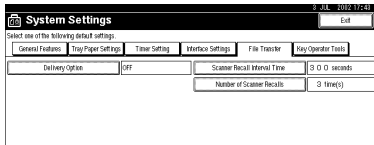

- 2 To resend files to the delivery server, press the **[ON]** key.
- 3 Use the number keys to enter the number of recalls, and then press the **[OK]** key.
- 4 Press the **[Exit]** key.
- 5 Press the **[User Tools/Counter]** key.

The new settings become effective and the display returns to the main function menu.



# 3. Combined Function Operations

## Changing Modes

### Note

- ❑ You cannot switch modes in any of the following situations:
  - When accessing user tools
  - During interrupt copying
- ❑ The default setting is to display the screen for copying when you turn the power on. You can change the setting. For details about settings, see p.75 "Function Priority"

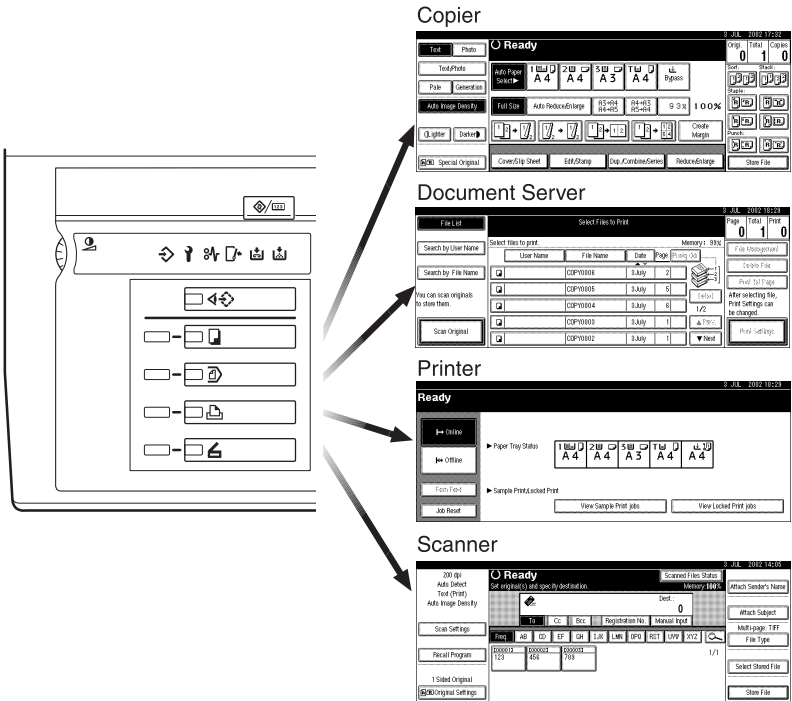

ZQVH48E

## Saving Energy

### Low Power Mode

If you do not operate the machine for a certain period after an operation or when you press the **[Energy Saver]** key, the display disappears and the machine enters Low Power mode. When you press the **[Energy Saver]** key again, the machine returns to the “Ready” status. In Low Power mode, the machine uses less electricity.

#### Note

You can change the setting of the Panel Off timer. ⇒ p.83 “Panel Off Timer”

### System Reset

The machine returns to its initial condition automatically when your job is finished, after a certain period of time. This function is called “System Reset”.

#### Note

You can change the System Reset time. ⇒ p.83 “System Auto Reset Timer”

### Auto Off

The machine turns itself off automatically after your job is finished, after a certain period of time. This function is called “Auto Off”.

#### Note

You can change the Auto Off time. ⇒ p.82 “Auto Off Timer”

Auto Off Timer function will not operate in the following cases:

- When a warning message is displayed
- When the service call message is displayed
- When paper is jammed
- When the cover is open
- When “Adding Toner” message is displayed
- When toner is being added
- When the User Tools/Counter screen is displayed
- When fixed warm-up is in progress
- When printer or other functions are operating

- When operations have been suspended during printing
- When the Data In indicator is on or blinking
- When the sample print or confidential print screen is displayed

## Job List

In the Job List, you can check and delete the contents of jobs in printing order and jobs being printed.

### Note

- In the Job List, jobs reserved using copy mode and Document Server mode are displayed. When **[Print Priority]** in the system settings is set to **[Job order]**, jobs reserved using copy mode, printer mode, Document Server mode or Net-file mode are displayed.
  - The Netfile mode  
This function allows printing from a PC, documents stored in Document Server of the machine using DeskTopBinder V2 Professional /Lite.

## Checking the List

- 1 Press the **[Job List]** key.

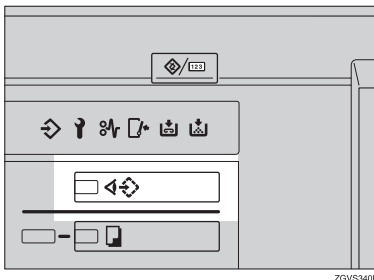



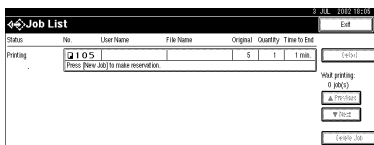

- 2 Select the job number of the list you want to check.



The job list is displayed.

The icons below show the operation mode of stored documents.

			
Job printed using copy mode.	Job printed using printer mode.	Job printed using Document Server mode.	Job printed using Netfile mode.

 **Note**

If more than six jobs are registered, press the [▲Prev.] or [▼Next] key to scroll the screen.

3

**3** Press the [Detail] key.

**4** Check the contents of the list.

**5** Press the [OK] key.

The display returns to the job list menu.

---

## Deleting Jobs

---

**1** Press the [Job List] key.

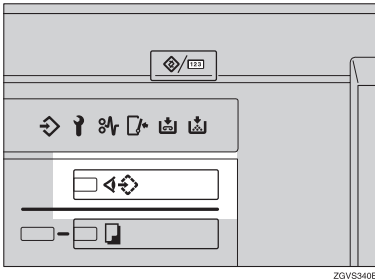

**2** Select the job number to be deleted.

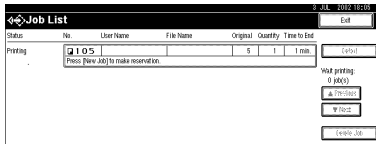

**3** Press the [Delete Job] key.

**4** Press the [Yes] key.

The display returns to the job list menu.



# Multi-Access

You can carry out another job using a different function while the current job is being performed. Performing multiple functions simultaneously like this is called "Multi-Access".

This allows you to handle your jobs efficiently, regardless of how the machine is being used. For example:

- While making copies, you can scan documents to store in the Document Server.
- While printing documents saved in the Document Server, the machine can receive print data.
- While printing print data, you can make operations for copying.

## Note

- You can set the priority of functions on p.75 "Print Priority". As default setting, the "Display Mode" is set to first priority.
- When the optional Booklet Finisher, Finisher 3000M (50-Sheet Staples) or Finisher 3000B (100-Sheet Staples) is installed on the machine, you can specify the output tray to which documents are to be delivered. For more information about how to specify the output tray for each function, see the following descriptions:
  - p.77 "Output: Copier"
  - p.77 "Output: Document Server"
  - p.78 "Output: Printer"

## ❖ What you can do with the Multi-Access Function

The multi-access function enables you to do the operations below.

- Receiving printer data while printing a document saved in the Document Server

The machine can receive printer data while copying or printing a document saved in the Document Server. The received data will be printed when the printer function is enabled.

- ① Select the document to be printed on the Document Server screen, and then press the **[Start]** key.
- ② When the machine receives the printer data, the Data In indicator blinks.  
When printing is finished, the machine starts printing printer data.

### Sample operations

The chart below shows sample operations of when “Print Priority” is set to “Interleave”. ⇒ p.75 “Print Priority”

△: Simultaneous operations are available.

●: Operation is enabled when the relevant function key is pressed and remote switching (of the scanner) is done.

○: Operation is enabled when the **[Interrupt]** key is pressed to interrupt the preceding operation.

→: Operation is performed automatically once the preceding operation ends.

×: The operation must be started once the preceding operation ends. (Simultaneous operations are not available.)

Mode before you select		Mode after you select			Printer		Scanner	Document Server	DeskTopBinder V2 Professional/Lite
		Copy	Interrupt Copying	Print	Print				
Copy	Operations for Copying	×	×	×	○	○	△	△	△
	Stapling	△ *1	→ *1	→ *1	○	○	△	△	→
	Sort	△ *1	→ *1	→ *1	○	○	△	△	△
	Operations for Copying	○	○	○	○	△	△	△	△
	Copy	○	○	○	○	△	△	△	△
	Data Reception	△	△	△	△	△	△	△	△
	Printing	△	△	△	△	△	△	△	△
	Stapling	△	△	△	△	△	△	△	△
	Operations for Scanning	●	●	●	●	●	●	●	●
	Scanning	●	●	●	●	●	●	●	●
	Operations for Document Server	●	●	●	●	●	●	●	●
	Scanning a Document to Store in Document Server	●	●	●	●	●	●	●	●
	Printing from Document Server	△	△	△	△	△	△	△	△
	Printing from Document Server	△	△	△	△	△	△	△	△

Mode before you select		Mode after you select		Printer												
				Copy				Interrupt Copying				Print		Scanner		Document Server
Interrupt Copying	Operations for Copying	○	○	○	×	×	△	△	△	×	×	×	×	×	×	△
	Copying	○	○	○	×	×	△	↓	↓	×	×	×	×	×	×	↓
Printer Print	Data Reception	△	△	△	△	△	→	→	→	△	△	△	△	△	△	△
	Sort Print	△	△	△	○	○	△	→	→	△	△	△	△	△	△	△
	Stapling	△	→	△	○	△ <sup>*4</sup>	△	→	→	△	△	△	△	△	△ <sup>*3</sup>	△ <sup>*3</sup>
Scanner	Operations for Scanning	●	●	●	○	○	△	△	△	×	×	●	●	●	△	△
	Scanning	×	×	×	×	×	△	△	△	×	×	×	×	×	×	△
Document Server	Operations for Document Server	●	●	●	○	○	△	△	△	●	●	×	×	×	×	△
	Scanning a Document to Store in Document Server	●	×	×	○	○	△	△	△	●	×	×	×	×	×	△
	Printing from Document Server	●	△ <sup>*3</sup>	△	○	○	△	△	△	△	△	△ <sup>*5</sup>	△ <sup>*5</sup>	△ <sup>*5</sup>	△	△

Mode before you select		Mode after you select	
DeskTopBinder V2 Professional/Lite	Printing from Document Server	Operations for Copying	Copy
		Stapling	
		Sort	
		Operations for Copying	Interrupt Copying
		Copying	
		Data Reception	
		Printing	Printer
		Stapling	
		Operations for Scanning	Scanner
		Scanning	
		Operations for Document Server	Document Server
		Scanning a Document to Store in Document Server	
		Printing from Document Server	
		Printing from Document Server	DeskTopBinder V2 Professional/Lite

- \*1 Simultaneous operations are only available after the preceding job documents are all scanned and the **[New Job]** key appears.
- \*2 You can scan a document after the preceding job documents are all scanned.
- \*3 During stapling, printing automatically starts after the current job.
- \*4 Stapling is not available.
- \*5 Simultaneous operations are possible once you press the **[New Job]** key.

 **Limitation**

- Stapling cannot be used at the same time for multiple functions.

 **Note**

- While printing is in progress, scanning a document using another function may take more time.
- .....

3

# 4. Document Server

## Relationship between Document Server and Other Functions

The following table describes the relationship between the Document Server and other machine functions.

Function name	Where to store documents	Displaying a list	Printing documents
Copy	Copy/Document Server	Enabled	Enabled
Printer	Personal computer	Enabled	Enabled
Scanner	Scanner	Disabled	Disabled

## Document Server Display

### ◆ Document Server Main Display

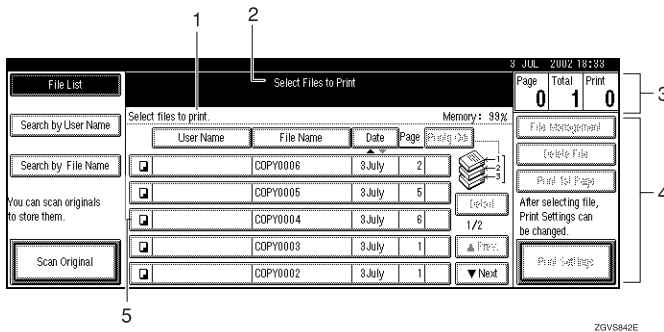

1. Operating status and messages are displayed.

2. The title of the currently selected screen is displayed.

3. The numbers of originals, copies, and printed pages are displayed.

4. The operation keys are displayed.

5. The stored operation mode is displayed.

The icons below show the operation mode when documents have been stored in the Document Server.

Function	Copier	Printer	Scanner
Icon			--

# Using the Document Server

## Scanning and Saving Originals

### ◆ File Name

The saved documents will automatically be named as “COPY0001”, “COPY0002”. You can change assigned file names.

### ◆ User Name

You can register a user name to distinguish the person or department that saved the documents. To assign a user name, you can register it by using the name assigned to the user code or by entering the name.

### 🔍 Reference

For more information about the user codes, see p.96 “User Codes”.

### ◆ Password

You can set a password for saved documents, and use it to prevent others printing them. When a password is set for the documents, **1** is added to the documents.

### 🔍 Reference

To store documents in a mode other than Document Server mode, see References for the respective functions.

### 🔴 Important

- ❑ Data stored in the machine might be lost if some kind of failure occurs. The supplier shall not be responsible for any damage that might result from the loss of data. For long-term storage of data, we recommend the use of DeskTopBinder V2 Lite or DeskTopBinder V2 Professional (option). For more information, please contact your local dealer.

### 📌 Note

- ❑ Data stored in the Document Server is set to be deleted after 3 days (72 hours) by the factory default setting. You can specify the period after which the stored data is deleted automatically. ⇒ p.94 “Auto Delete File”

## 1 Press the [Document Server] key.

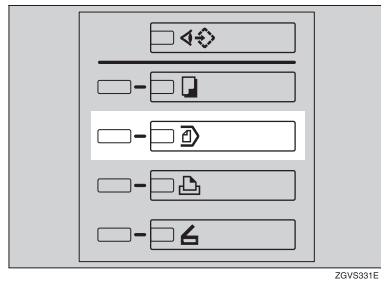

## 2 Press the [Scan Original] key.

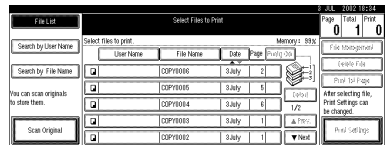

## 3 Enter a file name, user name, or password if necessary.

### 📌 Note

- ❑ If you do not register a file name, one is automatically assigned.

### 🔍 Reference

- ⇒ p.59 “To register or change a user name”
- ⇒ p.60 “To change a file name”
- ⇒ p.60 “To set or change a password”



#### 4 Place your originals.

##### Reference

For more information about how to place the types of originals that can be placed, see the Copy Reference.

#### 5 Make any desired settings.

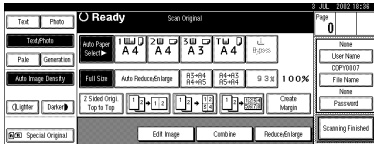

##### Reference

For details, see the Copy Reference.

#### 6 Press the [Start] key.

The document is saved in the Document Server.

##### Note

- To stop scanning, press the **[Clear/Stop]** key. To resume paused scanning job, press the **[Continue]** key in the confirmation dialog box. To delete saved images and cancel the job, press the **[Stop]** key.
- When a password has been set, **1** appears on the left side of the file name.
- The saved documents are displayed on the “Select Files to Print” display. If not displayed, press the **[Scanning Finished]** key.

#### To register or change a user name

##### 1 Display the “Scan Original” display.

##### 2 Press the [User Name] key.

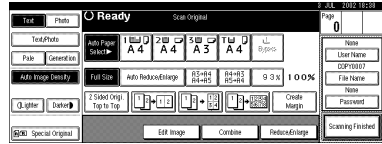

If user names have already been registered, the “User Name” display appears. When pressing **[Non-programmed Name]**, unregistered names can also be used.

If no user names are registered in “Address Book Management”, the user name entry dialog box is displayed.

##### Reference

⇒ p.96 “User Codes”

If registered user names are used

##### 1 Select a registered user name from the list, and then press the [OK] key.

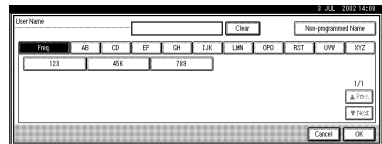

To change your user name to an unregistered user name, go to the next step.

##### Reference

⇒ p.97 “To Register a New User Code”

If unregistered user names are used

- 1 Press the [Non-programed Name] key.
- 2 Enter the new user name, and then press the [OK] key.

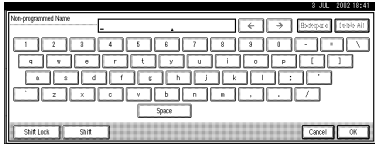

**Reference**  
 ⇒ p.110 "Entering Text"

If user names have not been registered

- 1 Enter the new user name, and then press the [OK] key.



**Reference**  
 ⇒ p.110 "Entering Text".

### To change a file name

- 1 Bring up the "Scan Original" display.
- 2 Press the [File Name] key.

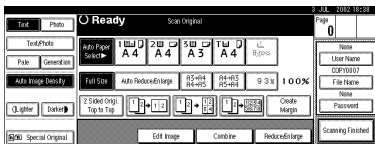

The "File Name" display appears.

- 3 Press the [Delete All] key to delete the old file name.

**Note**  
 You can also use the [Backspace] key to delete unnecessary characters.

- 4 Enter a new file name, and then press the [OK] key.

**Note**  
 A string of up to 10 characters can be entered as a file name. Note that only eight characters of each file name are displayed in the document list.

**Reference**  
 ⇒ p.110 "Entering Text"

### To set or change a password

- 1 Bring up the "Scan Original" display.
- 2 Press the [Password] key.

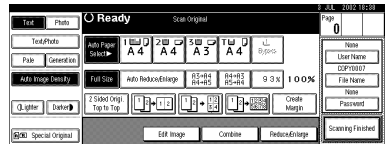

- 3 Enter the password using the number keys (4-digits), and then press the [OK] or [#] key.

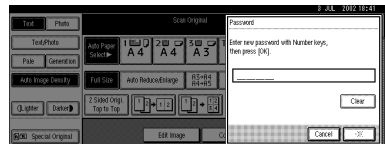

## Changing a File Name, User Name, or Password

- 1 Press the **[Document Server]** key.
- 2 Select the document for which the user name, file name, or password is to be changed.

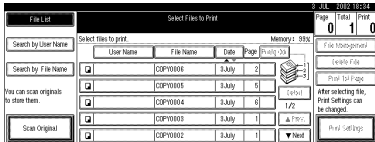

### Note

- If a password has already been set for the document, enter the password, and then press the **[OK]** key.

- 3 Press the **[File Management]** key.
- 4 Press the **[Change File Name]**, **[Change User Name]**, or **[Change Password]** key.

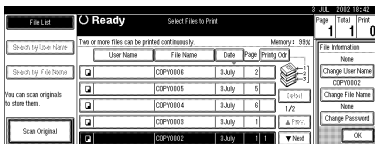

- 5 Enter the new file name, user name, or password, and then press the **[OK]** key.

### Reference

- ⇒ p.59 "To register or change a user name"
- ⇒ p.60 "To change a file name"
- ⇒ p.60 "To set or change a password"

- 6 Press the **[OK]** key.

## Selecting a Document

- 1 Press the **[Document Server]** key.
- 2 Select a document to be printed.

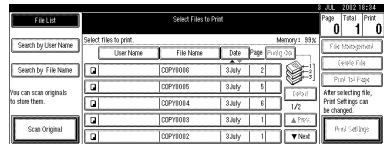

### Note

- If a password has been set for the document, enter it, and then press the **[OK]** key.
  - You can search for a desired document by using the **[Search by User Name]** or **[Search by File Name]** key. ⇒ p.62 "Searching Saved Documents"
  - You can sort document names in the list by user name, file name or date. To sort documents, press the **[User Name]**, **[File Name]** or **[Date]** key.
  - If you cannot determine the contents of a document by its file name, you can print the first page of the document to check its contents. ⇒ p.65 "Print First Page"
  - To cancel a document selection, press the highlighted document again.
- 3 To print multiple documents, repeat step 2 in the order to be printed.
- ### Note
- You can select up to 30 documents.
  - If sizes or resolutions of selected documents are not the same, the documents may not be printed.

- ❑ If you wish to change the order for printing, cancel the selection, and select documents in the desired order.
- ❑ If you press the **[Clear Modes]** key, selection of all documents will be canceled.
- ❑ If you press the **[Printg Odr]** key, the documents will be displayed in the order of printing.

### To Check Details of Stored Documents

- 4**
- 1** Select the document that you want to display detailed information for.

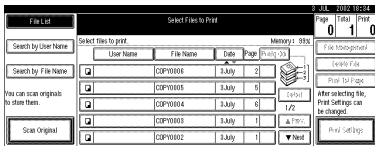

- Note**
- ❑ If a password has been set for the document, enter it, and then press the **[OK]** key.

- 2** Press the **[Detail]** key. Detailed information about the document is displayed.

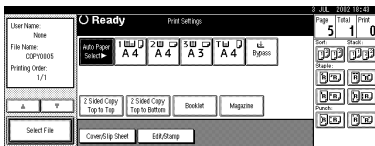

- Note**
- ❑ If you have selected several documents, use the **[▲]** and **[▼]** keys to view the details of each.
  - ❑ Press the **[OK]** key. The "Select Files to Print" display appears.

## Searching Saved Documents

You can use either the **[Search by File Name]** or **[Search by User Name]** key to search for documents stored on the Document Server. You can also list stored documents in the order you prefer.

- Note**
- ❑ If you install DeskTopBinder V2 Professional or DeskTopBinder V2 Lite on your computer, you can search and rearrange documents from your computer.

**Reference**  
For more detailed information refer to DeskTopBinder V2 Professional/Lite manuals.

### To Search by File Name

- 1** Press the **[Document Server]** key.
- 2** Press the **[Search by File Name]** key.

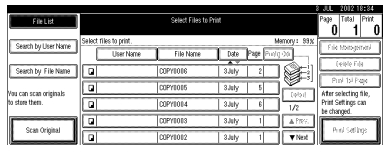

- 3** Enter the file name, and then press the **[OK]** key. Only files beginning with the name entered appear in the "Select Files to Print" display.

**Reference**  
⇒ p.110 "Entering Text".

- Note**
- ❑ To display all files saved in the Document Server, press the **[File List]** key.

## To Search by User Name

- 1 Press the **[Document Server]** key.
- 2 Press the **[Search by User Name]** key.

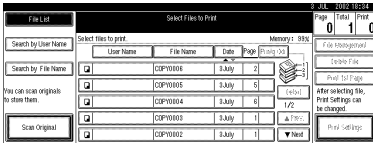

- 3 To specify a registered user name, select the user name from the displayed list, and then press the **[OK]** key.

### Note

- To specify an unregistered user name, go to the next step.

- 4 To specify an unregistered user name, press the **[Non-programed Name]** key and enter the name, and then press the **[OK]** key.

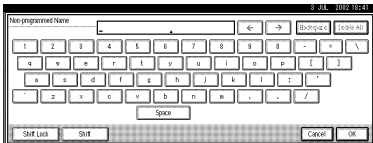

### Reference

⇒ p.110 "Entering Text"

- 5 Press the **[OK]** key.

Only files beginning with the name entered appear in the "Select Files to Print" display.

### Note

- To display all files saved in the Document Server, press the **[File List]** key.

## Printing Saved Documents

- 1 Select the document to be printed.

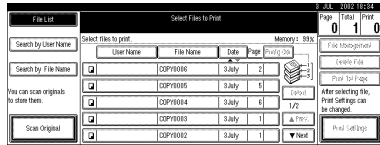

### Note

- If a password has been set for the document, enter it, and then press the **[OK]** key.
- You can print multiple documents. ⇒ p.61 "Selecting a Document"

- 2 If you need to change any print settings, press the **[Print Settings]** key.

The "Print Settings" display appears. User names, file names, and print order of documents appear.

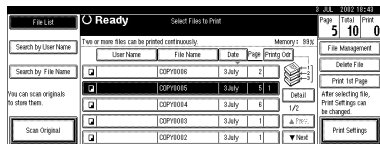

### Note

- The print settings made for printing in copier or printer mode are stored after printing and applied to the next printing.
- When multiple documents are printed at the same time, print settings made for the document printed first are applied to all other documents.
- Print setting items are listed below. For more information about print results according to each setting, see the Copy Reference.

### ❖ Binding format

- 2-Sided Copy Top to Top
- 2-Sided Copy Top to Bottom
- Booklet
- Magazine

### ❖ Cover handling

- Cover/Slip Sheet
- Edit/Stamp

### ❖ Finish

- Sort
- Stack
- Staple
- Punch

- If you print more than one set using the Sort function, you can check the print result by printing out only the first set. ⇒ p.65 "Sample Copy".
- If you select multiple files, you can confirm file names or print order you selected in step 1 by scrolling through the list with the [▼] and [▲] keys.
- Press the [Select File] key to return to the "Select Files to Print" display.

## 3 Enter the required number of copies using the number keys.

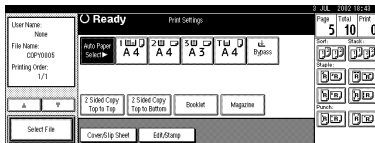

### Note

- Up to 999 can be entered.

## 4 Press the [Start] key.

The machine starts printing.

### Stopping printing

#### 1 Press the [Clear/Stop] key.

#### 2 Press the [Stop] key.

### Changing the number of copies during printing

#### Limitation

- The number of copies can only be changed when the Sort function is selected in print settings.

#### 1 Press the [Clear/Stop] key.

#### 2 Press the [Change Quantity] key.

#### 3 Use the number keys to enter a new number of copies.

#### 4 Press the [#] key.

#### 5 Press the [Continue] key.

Printing restarts.

## Sample Copy

If you print multiple sets using the Sort function, you can check if the print order or the print settings are correct by printing out only the first set using the **[Sample Copy]** key.

### Limitation

- This function can be used only when the Sort function is selected.

### 1 Select the document to be printed.

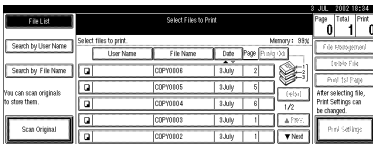

### Note

- If a password has been set for the document, enter the password, and then press the **[OK]** key.
- You can search for a document using the **[Search by User Name]** or **[Search by File Name]** key. ⇒ p.62 “Searching Saved Documents”
- You can sort document names in the list by user name, file name, or date. To sort the documents, press the **[User Name]**, **[File Name]** or **[Date]** key.
- To cancel a document selection, press the highlighted document again.

### 2 Press the **[Sample Copy]** key.

The first set is printed.

### 3 Press the **[Print]** key.

Printing restarts.

### Note

- Press the **[Suspend]** key to cancel printing and return to the “Print Settings” menu to change the settings.

## Print First Page

You can print the first page of the document selected in the “Select Files to Print” display to check content.

If more than one document is selected, the first page of each is printed.

### 1 Select the document to be printed.

#### Note

- If a password has been set for the document, enter it, and then press the **[OK]** key.

#### Note

- You can search for a document using the **[Search by User Name]** or **[Search by File Name]** keys. ⇒ p.62 “Searching Saved Documents”
- You can sort document names in the list by user name, file name, or date. To sort documents, press the **[User Name]**, **[File Name]**, or **[Date]** key.
- To cancel a document selection, press the highlighted document again.

### 2 Press the **[Print 1st Page]** key.

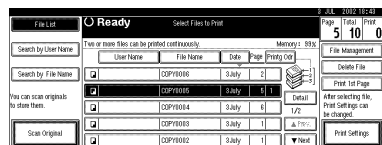

### 3 Press the **[Start]** key.

## Deleting Saved Documents

### Important

- ❑ You can save up to 3,000 documents in the Document Server. No more documents can be saved when there are 3,000 documents in the Document Server. You should delete unnecessary documents.

### Note

- ❑ You can delete all saved documents at once with User Tools. ⇒ p.94 “Delete All Files”

**1** Press the **[Document Server]** key.

**2** Select the document to be deleted.

### Note

- ❑ If a password has been set for the document, enter it, and then press the **[OK]** key.

### Note

- ❑ You can delete multiple documents at once. ⇒ p.61 “Selecting a Document”
- ❑ You can search for a document using the **[Search by User Name]** or **[Search by File Name]** keys. ⇒ p.62 “Searching Saved Documents”
- ❑ You can sort document names in the list by user name, file name, or date. To sort documents, press the **[User Name]**, **[File Name]** or **[Date]** key.
- ❑ If you cannot find a desired document using the file names, you can print the first page of a document to check its contents. ⇒ p.65 “Print First Page”
- ❑ To cancel a document selection, press the highlighted document again.

**3** Press the **[Delete File]** key.

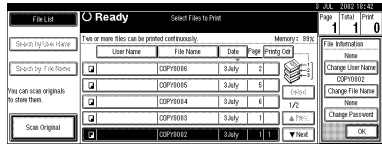

**4** Press the **[Delete]** key to delete the document.



# Settings for the Document Server

## ◆ Copier/Document Server Features ⇒ “General Features” in the Copy Reference

	Items	Default settings
General Features <sup>4</sup> /5	Document Server Storage Key: F1	2 Sided Original Top to top
	Document Server Storage Key: F2	1 Sided → 1 Sided Combine
	Document Server Storage Key: F3	1 Sided → 1 Sided Combine: 4 originals
	Document Server Storage Key: F4	1 Sided → 1 Sided Combine: 8 originals
	Document Server Storage Key: F5	Create Margin
General Features <sup>5</sup> /5	Document Server Print Key: F1	2 Sided Top to Top
	Document Server Print Key: F2	2 Sided Top to bottom
	Document Server Print Key: F3	Booklet
	Document Server Print Key: F4	Magazine
	Document Server Print Key: F5	Off

## ◆ System Settings ⇒ p.75 “General Features”, p.79 “Tray Paper Settings”, p.82 “Timer Setting”, p.90 “Key Operator Tools”

	Items	Default settings
General Features	Warm Up Notice	ON
	Copy Count Display	Up
	Output: Document Server	OFF
Tray Paper Settings	Paper Tray Priority: Document Server	Tray 1
	Cover Sheet Tray	Off
	Slip Sheet Tray	Off
Timer Setting	Copier /Document Server Auto Reset Timer	60 seconds
Key Operator Tools	Auto Delete File	After 3 days
	Delete All Files	--
	Display Password with Stored File	OFF

4

# 5. User Tools (System Settings)

## User Tools Menu (System Settings)

● These items must be set to use the function. Be sure to set them before using the corresponding function.

○ These items must be set if required.

### ◆ General Features ⇒ p.75 “General Features”

	Default settings	Copier/Document Server	Printer	Scanner
Panel Tone	ON	○	○	○
Warm Up Notice	ON	○		
Copy Count Display	Up	○		
Function Priority	Copier	○	○	○
Print Priority	Display mode	○	○	
Function Reset Timer	3 seconds	○	○	
Interleave Print	10 sheet(s)			
Output Tray Setting	According to Function Setting	○		
Output: Copier	Copy Tray <sup>*1</sup>	○		
Output: Document Server	Copy Tray <sup>*1</sup>			
Output: Printer	Copy Tray <sup>*1 *2</sup>		○	
ADF Original Table Elevation	When original is set	○		
Job List Display Time	15 seconds	○		

<sup>\*1</sup> The default tray switches to “Finisher Upper Tray” if the optional finisher is installed.

<sup>\*2</sup> The default tray switches to “Mailbox Tray” if the optional mailbox is installed.

### ◆ Tray Paper Settings ⇒ p.79 “Tray Paper Settings”

	Default settings	Copier	Printer	Scanner
Paper Tray Priority: Copier	Tray 1	○		
Paper Tray Priority: Printer	Tray 1		○	

	Default settings	Copier	Printer	Scanner
Tray Paper Size: Tray 2	A4	<input type="radio"/>	<input type="radio"/>	
Tray Paper Size: Tray 3	A4	<input type="radio"/>	<input type="radio"/>	
Paper Type: Bypass tray	No display	<input type="radio"/>	<input type="radio"/>	
Paper Type: Tray 1	No display:2 Sided Copy:Auto Paper Select on	<input type="radio"/>	<input type="radio"/>	
Paper Type: Tray 2	No display:2 Sided Copy:Auto Paper Select on	<input type="radio"/>	<input type="radio"/>	
Paper Type: Tray 3	No display:2 Sided Copy:Auto Paper Select on	<input type="radio"/>	<input type="radio"/>	
Paper Type: LCT	No display:2 Sided Copy:Auto Paper Select on	<input type="radio"/>	<input type="radio"/>	
Cover Sheet Tray	Off	<input type="radio"/>		
Slip Sheet Tray	Off	<input type="radio"/>		
Slip Sheet 1 Tray	Off	<input type="radio"/>		
Slip Sheet 2 Tray	Off	<input type="radio"/>		

◆ **Timer Setting ⇒ p.82 “Timer Setting”**

	Default settings	Copier	Printer	Scanner
Auto Off Timer	1 minute(s)	<input type="radio"/>		
Energy Saver Timer	15 minute(s)	<input type="radio"/>		
Panel Off Timer	1 minutes	<input type="radio"/>	<input type="radio"/>	<input type="radio"/>
System Reset Timer	60 seconds	<input type="radio"/>	<input type="radio"/>	<input type="radio"/>
Copier/ Document Server Auto Reset Timer	60 seconds	<input type="radio"/>		
Scanner Auto Reset Timer	60 seconds			<input type="radio"/>
Set Date	--	<input checked="" type="radio"/>		<input type="radio"/>
Set Time	--	<input checked="" type="radio"/>		<input type="radio"/>

	Default settings	Copier	Printer	Scanner
Weekly Timer Code	Off	<input type="radio"/>		
Weekly Timer: Monday - Sunday	--	<input type="radio"/>	<input type="radio"/>	<input type="radio"/>

◆ **Interface Settings** ⇒ p.84 “Interface Settings/Network”, p.86 “Interface Settings/Parallel Interface”, p.87 “Interface Settings/IEEE 1394 (option)”, p.88 “Interface Settings/IEEE 802.11b (option)”

		Default settings	Copier	Printer	Scanner
Network	IP Address	011.022.033.044		<input type="radio"/>	<input type="radio"/> *3
	Sub-net Mask	000.000.000.000		<input type="radio"/>	<input type="radio"/> *3
	Gateway Address	000.000.000.000		<input type="radio"/>	<input type="radio"/> *3
	Network Boot	NONE		<input type="radio"/>	<input type="radio"/> *3
	Effective Protocol	blank (all effective)		<input type="radio"/>	<input type="radio"/> *3
	NW Frame Type	Auto select		<input type="radio"/>	<input type="radio"/> *3
	LAN Type	Ethernet		<input type="radio"/>	<input type="radio"/> *3
	Ethernet Speed	Auto select		<input type="radio"/>	<input type="radio"/> *3
Parallel interface	Parallel Timing	ACK outside		<input type="radio"/>	
	Parallel Communication Speed	High speed		<input type="radio"/>	
	Selection Signal Status	High		<input type="radio"/>	
	Input Prime	Invalid		<input type="radio"/>	
	Bidirectional Communication	ON		<input type="radio"/>	
	Signal Control	Job acceptance priority		<input type="radio"/>	

		Default settings	Copier	Printer	Scanner
IEEE 1394 <sup>*1</sup>	IP Address	000.000.000.000		<input type="radio"/>	<input type="radio"/> <sup>*3</sup>
	Sub-net Mask	000.000.000.000		<input type="radio"/>	<input type="radio"/> <sup>*3</sup>
	IP over 1394	Active		<input type="radio"/>	<input type="radio"/> <sup>*3</sup>
	SCSI print (SBP-2)	Active		<input type="radio"/>	
	Bidirectional SCSI print	ON		<input type="radio"/>	
IEEE 802.11b <sup>*3</sup>	Communication Mode	802.11 Ad hoc		<input type="radio"/>	<input type="radio"/> <sup>*3</sup>
	SSID Setting	blank (ASSID)		<input type="radio"/>	<input type="radio"/> <sup>*3</sup>
	Channel	11		<input type="radio"/>	<input type="radio"/> <sup>*3</sup>
	WEP (Encryption) Setting	Inactive		<input type="radio"/>	<input type="radio"/> <sup>*3</sup>
	Wireless LAN Signal	--			
	Transmission Speed	Auto		<input type="radio"/>	<input type="radio"/> <sup>*3</sup>
	Return to Defaults	--			

<sup>\*1</sup> Displayed when the IEEE 1394 Interface Board (option) is installed.

<sup>\*2</sup> Displayed when the Wireless LAN board (option) is installed.

<sup>\*3</sup> Make sure to set when using delivery, TWAIN, document storage, or mail delivery.

#### ◆ File Transfer ⇒ p.89 “File Transfer”

	Default	Copier	Printer	Scanner
Delivery Option	OFF			<input type="radio"/> <sup>*1</sup>
Scanner Recall Interval Time	300 seconds			<input type="radio"/>
Number of Scanner Recalls	3 time(s)			<input type="radio"/>

<sup>\*1</sup> Make sure to set when using the machine as a delivery scanner.

◆ **Key Operator Tools ⇒ p.90 “Key Operator Tools”**

	Default settings	Copier	Printer	Scanner
User Code Management	OFF ( [Auto Program] for printer mode only)	<input type="radio"/>	<input type="radio"/>	<input type="radio"/>
Key Counter Management	OFF	<input type="radio"/>	<input type="radio"/>	<input type="radio"/>
Key Operator Code	OFF	<input type="radio"/>	<input type="radio"/>	<input type="radio"/>
Display/Print Counter	--	<input type="radio"/>	<input type="radio"/>	<input type="radio"/>
Display/Clear/Print Counter per User Code	--	<input type="radio"/>	<input type="radio"/>	
Address Book Management	--	<input type="radio"/>	<input type="radio"/>	<input type="radio"/>
Address Book: Program/Change/Delete Group	--			<input type="radio"/>
Address Book: Change Order	--			<input type="radio"/>
Address Book: Edit Title	--	<input type="radio"/>	<input type="radio"/>	<input type="radio"/>
Address Book: Select Title	Title 1	<input type="radio"/>	<input type="radio"/>	<input type="radio"/>
Auto Delete File	After 3 day(s)	<input type="radio"/>	<input type="radio"/>	<input type="radio"/>
Delete All Files	--	<input type="radio"/>	<input type="radio"/>	<input type="radio"/>
Display Password with Stored File	OFF	<input type="radio"/>	<input type="radio"/>	<input type="radio"/>
Key Operator's E-mail Address	--			<input type="radio"/>
AOF (Always ON)	ON			

# Accessing User Tools (System Settings)

This section is for key operators in charge of this machine. You can change or set the machine's default settings.

## Note

- Operations for system settings are different from normal operations. After using User Tools, be sure to exit. ⇒ p.74 "Exiting from User Tools"
- Any changes you make with User Tools remain in effect even if the main power switch or operation switch is turned off, or the **[Energy Saver]** or **[Clear Modes]** key is pressed.

5

## Changing Settings

### Note

- If a key operator code has been set, the key operator code entry dialog box appears. Enter the code, and then press the **[OK]** key. ⇒ p.90 "Key Operator Code"

- 1** Press the **[User Tools/Counter]** key.

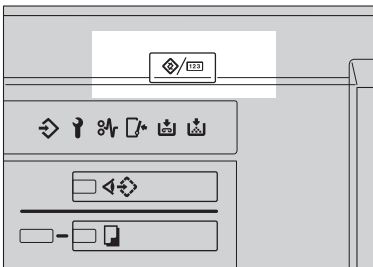

- 2** Press the **[System Settings]** key.

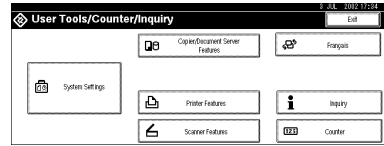

- 3** Select the desired menu, and then press the desired key.

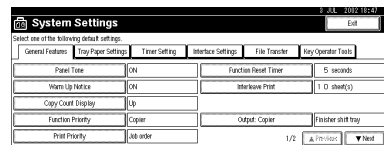

- 4** Change settings by following instructions on the display panel, and then press the **[OK]** key.

### Note

- To cancel changes made to settings and return to the normal function display, press the **[User Tools/Counter]** key.

## Exiting from User Tools

- 1** Press the **[User Tools/Counter]** key.

Changing system settings is finished, and the machine returns to Copy or Print mode.



### Note

- You can also exit from User Tools by pressing the **[Exit]** key.



# Settings You Can Change with User Tools

## Reference

To access User Tools, see p.74 "Changing Settings".

---

## General Features

---

### ❖ Panel Tone

The beeper (key tone) sounds when a key is pressed.

#### Note

Default setting: *ON*

### ❖ Warm Up Notice (Copier/Document Server)

Specify whether or not the beeper sounds when the machine becomes ready for copying after Low Power mode is deactivated, or the power is turned on.

#### Note

Default setting: *ON*

If the "Panel Tone" setting is "OFF", the beeper does not sound, whatever the "Warm Up Notice" setting.

### ❖ Copy Count Display (Copier/Document Server)

The copy counter can be set to show the number of copies made (count up) or the number of copies remaining (count down).

#### Note

Default setting: *Up (count up)*

### ❖ Function Priority

You can specify the mode to be displayed immediately after the operation switch or System Reset mode is turned on.

#### Note

Default setting: *Copier*

### ❖ Print Priority

Print priority is given to the mode selected.

#### Reference

⇒ p.51 "Multi-Access"

 **Note**

- Default setting: *Display mode*
- When the optional Booklet Finisher, Finisher 3000M (50-Sheet Staples), or Finisher 3000B (100-Sheet Staples) is installed, you can specify an output tray to which documents are delivered. For more information about how to specify an output tray for each function, see the following descriptions:
  - p.77 “Output: Copier”
  - p.77 “Output: Document Server”
  - p.78 “Output: Printer”

**◆ Function Reset Timer**

You can set the length of time the machine waits before changing modes when using the multi-access function (⇒ p.51 “Multi-Access”). This is useful if you make many copies and you have to change the settings for each copy. If you set a large value, you can prevent jobs from other functions interrupting the copy job.

 **Note**

- Default setting: *3 seconds*
- The Function Reset Timer setting is ignored if “Interleave” is set for “Print Priority” (⇒ p.75).
- When you select “Set Time”, enter the time (3–30 seconds in one second increments) using the number keys.

**◆ Interleave Print**

You can set the timing for functions to switch when **[Print Priority]** has been set to **[Interleave]**.

 **Note**

- Default setting: *10 sheet(s)*
- Depending on printing time, set values may change.
- The timing for functions can be set from 1 to 20 sheets.

**◆ Output Tray Setting**

You can set the way or timing for switching the output tray.

- Output Tray
  - You can set the way for switching the output tray from “According to Function Setting” or “Auto Change”.

 **Note**

- Default setting: *According to Function Setting*
- “Auto Change” can be used when “Print Priority” is set to “Job Order”. ⇒ p.75 “Print Priority”

- **Change Output Tray**

You can set the timing for switching the output tray, when the “Output Tray” has been set to “Auto Change”, from “When Tray is Full” or “Per Job”.

 **Note**

- Default setting: *When Tray is Full*

◆ **Output: Copier**

You can specify a tray to which documents are delivered.

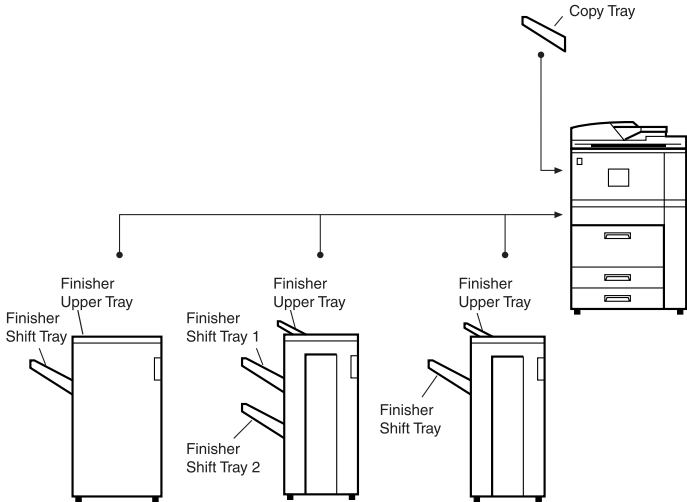

 **Note**

- Default setting: *Copy Tray, Finisher Upper Tray*
- The default settings of the tray set as output tray may vary depending on the installed optional finisher.

◆ **Output: Document Server**

You can specify a tray to which documents are delivered.

 **Note**

- Default setting: *Copy Tray, Finisher Upper Tray*
- For details about output trays, see p.77 “Output: Copier”.
- The default settings of the output tray may vary depending on the installed optional finisher.

❖ **Output: Printer**

You can specify a tray to which documents are delivered.

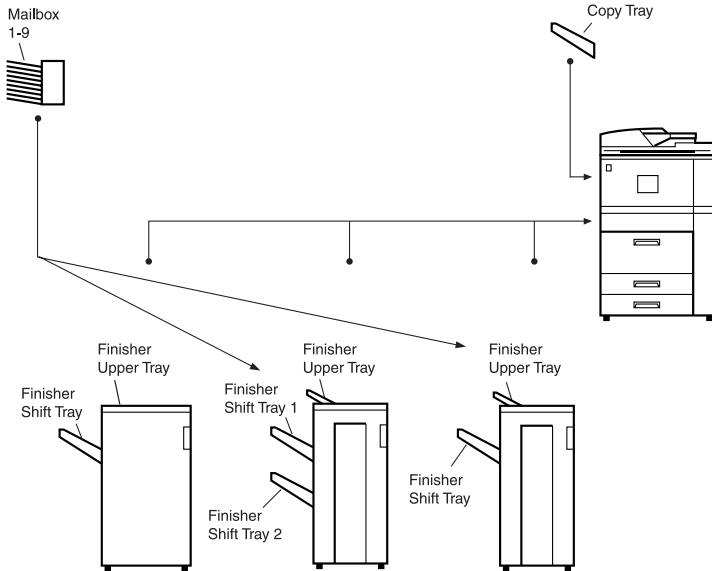

ZGVF321E

**Note**

- Default setting: *Copy Tray, Finisher Upper Tray*
- The output trays set on the Printer Driver have priority over the output tray specified above.
- The default settings of the output tray may vary depending on the installed optional finisher.

❖ **ADF Original Table Elevation**

You can set the timing for elevating the document feeder (ADF) original table.

**Note**

- Default setting: *When original is set*

❖ **Job List Display Time**

You can set the length of time the job list screen is displayed before returning automatically to the default screen.

**Note**

- Default setting: *15 seconds*
- When you select "On", enter the time from 10 to 999 seconds in one second increments using the number keys.

## Output tray settings

### Limitation

- You cannot interrupt the current stapling job even when a stapling job is specified with a different function.
- When the Booklet Finisher, Finisher 3000M (50-Sheet Staples) or Finisher 3000B (100-Sheet Staples) is installed and stapling or shift-sorting is specified, the job will be delivered to the finisher shift tray regardless of the output tray specified.

## Tray Paper Settings

### ❖ Paper Tray Priority:Copier (Copier/Document Server)

You can specify the paper tray for delivery.

#### Note

- Default setting: *Tray 1*

### ❖ Paper Tray Priority:Printer (Printer)

You can specify the paper tray for delivery.

#### Note

- Default setting: *Tray 1, LCT*
- The default tray switches to "LCT" if the optional large capacity tray (LCT) is installed.

### ❖ Tray Paper Size: (Tray 2,3)

Select the size of the copy paper loaded in the paper tray.

- The paper sizes you can load for trays, when the paper size selector knob is set to the  mark, are as follows:
  - A3 , B4 , A4 , A4 , B5 , B5 , A5 , A5 , 210 × 340 mm , 210 × 182 mm , 210 × 170 mm
  - 11"×17" , 8<sup>1</sup>/<sub>2</sub>"×14" , 8<sup>1</sup>/<sub>2</sub>"×13" , 8<sup>1</sup>/<sub>2</sub>"×11" , 8<sup>1</sup>/<sub>2</sub>"×11" , 8<sup>1</sup>/<sub>4</sub>"×13" , 8"×13" , 7<sup>1</sup>/<sub>4</sub>"×10<sup>1</sup>/<sub>2</sub>" , 5<sup>1</sup>/<sub>2</sub>"×8<sup>1</sup>/<sub>2</sub>" , 5<sup>1</sup>/<sub>2</sub>"×8<sup>1</sup>/<sub>2</sub>" , 11"×15" , 11"×14" , 10"×15" , 8<sup>1</sup>/<sub>4</sub>"×14" , 8"×10<sup>1</sup>/<sub>2</sub>" , custom size (139.7-297 mm(5.5"-11.7") wide × 139.7-431.8 mm(5.5"-17") long)
  - 8K(267 × 390 mm) , 16K(195 × 267 mm)

#### Important

- If the specified paper size differs from the size of paper actually set in the paper tray, a paper misfeed might occur because the paper size is not detected correctly.

 **Note**

- Default setting: A4 
- The tray fence for the optional large capacity tray (LCT) is fixed. If you need to change the paper size, contact your service representative.
- The optional tab sheet holder is required when using tab stock in tray 2 or 3.

 **Reference**

⇒ p.132 “Changing the Paper Size”

**◆ Paper Type: Bypass tray**

Sets the display so you can see what type of paper is loaded in the bypass tray.

- Paper types you can set for the bypass tray are as follows:
  - Plain paper (No Display), Recycled Paper, Special Paper, Colour Paper 1, Colour Paper 2, Translucent Paper, Letterhead, Thick Paper, Label Paper, OHP, Cardstock, Bond Paper, Punched Paper, Preprinted Paper

 **Note**

- Default setting: *No display*

**◆ Paper Type: (Tray1-3, LCT)**

Sets the display so you can see what type of paper is loaded in each of the trays. This information is used by the print function to automatically select the paper tray.

- Paper types you can set for trays are as follows:
  - Plain paper (No Display), Recycled Paper, Special Paper, Translucent Paper, Letterhead, Thick Paper, Colour Paper 1, Colour Paper 2, Tab stock (2-3 tray), Bond Paper, Punched Paper, Preprinted Paper

 **Note**

- Default settings:
  - Paper Type: *No display*
  - Copying Method: *2 Sided Copy*
  - Apply Auto Paper Select: *Yes*
- A  is displayed next to the paper tray if “No” is selected.
- The optional tab sheet holder is required when using tab stock in tray 2 or 3.
- The number of tab stock shifts can be set to millimeters, when **[Tab Stock]** has been selected.
- Set the tab stock shift number in the “0 to 15 mm(0” to 0.6”)” range in 1 millimeter (1 inch) units. The default setting is “13 mm(0.5”)”.
- “Thick Paper” and “Tab Stock” can be set simultaneously.

### **Limitation**

- Auto paper select can only be selected for the Copy function if “No Display” and “Recycled Paper” are selected. However, auto paper select is not used if “No” is selected.

### **Cover Sheet Tray**

Allows you to specify and display the paper tray to set cover sheets. After selecting the paper tray, you can also specify the display timing and copy method for two-sided copying.

#### **Note**

- Default setting:
  - Tray to program: *Off*
- The functions that use the Cover Sheet Tray setting are front cover function and front/back cover function.
- When “At Mode Selected” is selected, the cover settings options are only displayed when the cover function or slip sheet function is selected.
- You can set Copying Method in Duplex setting only when “At Mode Selected” is selected.

#### **Reference**

⇒ “Cover” in the Copy Reference

### **Slip Sheet Tray, Slip Sheet Tray 1/2**

Allows you to specify and display the paper tray to set slip sheets. After selecting, you can also specify the display timing and copy method for two-sided copying.

#### **Note**

- Default setting:
  - Tray to program: *Off*
- When “At Mode Selected” is selected, the cover settings options are only displayed when the cover function or slip sheet function is selected.
- When “Interposer Tray” has been selected in the slip sheet 2 tray settings, “Copying Method in Duplex” will not be displayed.
- OHP slip sheets cannot be copied when using the interposer.

#### **Reference**

⇒ “Slip Sheets” in the Copy Reference

## Timer Setting

### ❖ Auto Off Timer

The machine turns off automatically to conserve energy after a specified amount of time has passed following job completion. This function is called "Auto Off".

The machine status after Auto Off operation is called "Off mode" or "Sleep mode". For Auto Off Timer, specify the time to elapse before the Auto Off function is activated.

#### Note

Default setting: *1 minutes*

When in "Off mode" or "Sleep mode", the machine can be ready for use within 25 seconds.

Auto Off Timer function will not operate in the following cases.

- When a warning message is displayed
- When the service call message is displayed
- When the paper is jammed
- When the cover is open
- When "Adding Toner" message is displayed
- When the toner is being replenished
- When the User Tools/Counter screen is displayed
- When fixed warm-up is in progress
- When the printer or other functions are operating
- When operations have been suspended during printing
- When the Data In indicator is on or blinking
- When the sample print or confidential print screen is displayed

The time can be set from 1 minute to 240 minutes using the number keys.

### ❖ Energy Saver Timer

Set the amount of time the machine waits before switching to Low Power mode after copying has finished or the last operation is performed.

The time can be set from 1 minute to 240 minutes using the number keys.

#### Note

Default setting: *15 minutes*



### ❖ Panel Off Timer

Set the amount of time the machine waits before switching the panel off after copying has finished or the last operation is performed.

#### Note

- Default setting: *1 minutes*
- The warm up time for making a copy from standby mode is 0 seconds.
- The interval time can be set from 10 seconds to 240 minutes using the number keys.

### ❖ System Auto Reset Timer

The System Reset setting automatically switches to the screen of the function set in Function Priority. This happens if no operations are performed or when an interrupted job is cleared. This setting sets the system reset interval. ⇒ p.75 "Function Priority"

#### Note

- Default setting: *60 seconds*
- The time can be set from 10 to 999 seconds in one second increments using the number keys.

### ❖ Copier/Document Server Auto Reset Timer (Copier/Document Server)

Specifies the time to elapse before copier and Document Server functions are reset.

#### Note

- Default setting: *60 seconds*
- If "OFF" is selected, the machine will not automatically switch to the user code entry screen, and you will not be able to limit who uses the machine.
- The time can be set from 10 to 999 seconds in one second increments using the number keys.

### ❖ Scanner Auto Reset Timer (Scanner)

Specifies the time to elapse before the scanner function is reset.

#### Note

- Default setting: *60 seconds*
- If "OFF" is selected, the machine will not automatically switch to the user code entry screen, and you will not be able to limit who uses the machine.
- The time can be set from 10 to 999 seconds in one second increments using the number keys.

### ❖ Set Date

Set the date for the copier's internal clock using the number keys.

#### Note

- To change between year, month and day, press the [←] and [→] keys.

### ❖ Set Time

Set the time for the copier's internal clock using the number keys.

#### Note

- To change between hours, minutes and seconds, press the [←] and [→] keys.

### ❖ Weekly Timer Code

Sets an 8-digit code to turn on the main power during a time frame in “Weekly Timer”.

#### Note

- Default setting: *OFF*
- If “ON” is selected, enter the timer code.
- If “ON” is selected without entering the timer code, the machine cannot be used, even if the power is turned on. If “Off” is selected, the machine can be used without entering a timer code, when it is turned on.

### ❖ Weekly Timer: (Monday-Sunday)

Set the power on timer using the number keys.

5

---

## Interface Settings/Network

---

### ❖ IP Address

Before using this machine with the network environment, you must configure the IP address.

#### Note

- Default setting: *011.022.033.044*
- Do not use an IP address that is used for another machine. To get the addresses, contact your network administrator.
- If you install the IEEE 1394 Interface Board (option) and use the IEEE 1394 interface, you must set the address of the domain, different from the IP address of [IEEE 1394]. If you intend to set the address for the same domain, set a different value for the Sub-net Mask.
- Press the [←] or [→] key to move in 3-digit increments.
- Press the [Clear] key when the wrong address is entered.

### ❖ Sub-net Mask

This is a number used to mathematically “mask” or hide an IP address on the network by eliminating those parts of the address that are alike for all machines on the network.

#### Note

- Default setting: *000.000.000.000*
- Press the [←] or [→] key to move in 3-digit increments.
- Press the [Clear] key when the wrong address is entered.

### ❖ Gateway Address

A gateway is a connection or interchange point connecting two networks. Configure the gateway address for the router or host computer used as a gateway.

#### Note

- Default setting: *000.000.000.000*
- Press the [←] or [→] key to move in 3-digit increments.
- Press the [Clear] key when the wrong address is entered.

### ❖ Network Boot

Select how to set an IP address from a client.

#### Note

- Default setting: *NONE*
- For details about settings, consult your network administrator.

#### Reference

For details, see the Network Printing Guide.

### ❖ Effective Protocol

Select the protocol to use in the network.

#### Note

- Default settings: *TCP/IP:Effective, NetWare:Effective, NetBEUI:Effective, AppleTalk:Effective*

### ❖ NW Frame Type

Select the frame type when you use NetWare.

#### Note

- Default setting: *Auto select*

### ❖ LAN Type

When you have installed the Wireless LAN board (option), select interface, Wireless LAN (IEEE 802.11b) or Ethernet.

#### Note

- Default setting: *Ethernet*

### ❖ Ethernet Speed

Set the access speed for networks.

Select a speed that matches your network environment. "Auto Select" should usually be specified.

#### Note

- Default setting: *Auto select*

## Interface Settings/Parallel Interface

### ❖ Parallel Timing

Specifies the timing setting for the parallel interface. Under normal circumstances, you will not need to change this setting.

#### Note

Default setting: *ACK outside*

### ❖ Parallel Communication Speed

Specifies the communication speed of the parallel interface. If the communication speed is set too fast, data transfer may not flow smoothly. If this occurs, change the setting to "Standard".

#### Note

Default setting: *High speed*

### ❖ Selection Signal Status

Specifies the signal setting of the parallel interface.

#### Note

Default setting: *High*

### ❖ Input Prime

Specifies whether the prime signal is active or inactive when an input prime signal is sent. Under normal circumstances, you will not need to change this setting.

#### Note

Default setting: *Invalid*

### ❖ Bidirectional Communication

Specifies the printer's response mode and so forth for a status request when using the parallel interface. If you experience problems when using other manufacturers, printers, set this to "OFF".

#### Limitation

If this is set to "OFF", bidirectional communication functions will not work.

#### Note

Default setting: *ON*

### ❖ Signal Control

Specifies the error processing settings for when an error occurs when printing from a computer. Under normal circumstances, you will not need to change this setting.

#### Note

Default setting: *Job acceptance priority*

## Interface Settings/IEEE 1394 (option)

### Preparation

You must install the IEEE 1394 Interface Board (option) into the machine.

### ❖ IP Address

When you connect this machine to a network using the IEEE 1394 Interface Board (option), you must configure the IP address.

#### Note

- Default setting: 000.000.000.000
- When you use the IEEE 1394 interface on a network, you cannot use the Ethernet interface in the same domain. To use in the same domain, set a different value for the Sub-net Mask.

### ❖ Sub-net Mask

This is a number used to mathematically “mask” or hide an IP address on the network by eliminating those parts of the address that are alike for all machines on the network.

#### Note

- Default setting: 000.000.000.000
- When you use the IEEE 1394 interface on a network, you cannot use the IEEE 1394 interface in the same domain. To use in the same domain, set a different value for the Sub-net Mask.
- Press the [**←**] or [**→**] key to move in 3-digit increments.
- Press the [**Clear**] key when the wrong address is entered.

### ❖ IP over 1394

When you use the IP over 1394 function of the IEEE 1394 interface to connect the machine to the network, or you print using a personal computer with the IP over 1394 driver, you must set IP over 1394.

#### Note

- Default setting: *Active*

#### Reference

For details, see the Printer Reference 1.

### ❖ SCSI print (SBP-2)

When you print using the SCSI Print client function supported by Windows 2000 or Windows XP, you must set SCSI Print.

#### Note

- Default setting: *Active*

### ❖ Bidirectional SCSI print

Specifies the printer's response mode and so forth for a status request when using the IEEE 1394 interface.

#### Note

- Default setting: *ON*
- If this is set to "OFF", bidirectional communication functions will not work.

---

## Interface Settings/IEEE 802.11b (option)

---

### Preparation

You must install the Wireless LAN board (option) into the machine.

#### Note

- Be sure to make all settings simultaneously.

### ❖ Communication Mode

Specifies the communication mode of the Wireless LAN.

#### Note

- Default setting: *802.11 Ad hoc*

### ❖ SSID Setting

Specifies SSID to distinguish the access point in the Infrastructure mode.

#### Note

- Default setting: *blank (ASSID)*
- If blank is specified in 802.11b Ad hoc mode or Ad hoc mode, "ASSID" appears.

### ❖ Channel

Specifies a channel when you select 802.11b Ad hoc mode or Ad hoc mode.

#### Note

- Default setting: 11
- The channel can be set from 1 - 13.

### ❖ Wireless LAN Signal

Shows the radio-wave conditions of the access point connected in Infrastructure mode.

#### Note

- Radio wave status is shown when you press the **[Wireless LAN Signal]** key.

### ❖ WEP (Encryption) Setting

Specifies the encryption of the Wireless LAN. If this is set to “Effective”, you must enter the WEP key.

#### Note

Default setting: *Inactive*

### ❖ Transmission Speed

Specifies the communication speed of the Wireless LAN.

#### Note

Default setting: *Auto*

### ❖ Return to Defaults

You can return the Wireless LAN settings to the default setting.

---

## File Transfer

---

### ❖ Delivery Option

Enables or disables the function for sending documents stored in this machine or scanned documents via the ScanRouter V2 Professional/Lite delivery server.

#### Note

Default setting: *OFF*

Set this option when you specify whether or not to use ScanRouter V2 Professional/Lite. If you use, you will have to reregister the I/O devices in the ScanRouter V2 Professional/Lite.

### ❖ Scanner Recall Interval Time

Specifies the interval the machine waits before resending data or a document, if it could not be sent to ScanRouter V2 Professional.

#### Note

Default setting: *300 Seconds*

The interval time can be set from 60 to 999 seconds in one second increments using the number keys.

This setting is for the Scanner function.

### ❖ Number of Scanner Recalls

Sets a maximum number of resend documents or data in the machine to the delivery server.

#### Note

Default setting: *3 times*

The number of times can be set from 1 to 99 using the number keys.

This setting is for the Scanner function.

## Key Operator Tools

The key operator must set the following items. For settings or more information, contact the key operator.

### ❖ User Code Management

Allows you to control who uses the machine by setting codes for users. User codes must be registered for user code management. ⇒ p.96 “User Codes”.

#### Note

- Default settings: *Copier/OFF, Document Server/OFF, Printer/Auto Program, Scanner/OFF*
- By using “Auto Program” for the printer, you can keep a print log for each user code entered from the driver.

### ❖ Key Counter Management

Use the key counter to specify whether users are limited or not.

#### Note

- Default settings: *Copier/OFF, Document Server/OFF, Printer/OFF, Scanner/OFF*

### ❖ Key Operator Code

This specifies whether or not to use passwords (max. 8-digits) to control use of the “Key Operator Tools” settings for the key operator code.

#### Note

- Default setting: *OFF*
- If you select “ON”, enter the key operator code (max. 8-digits) using the number keys, and then select “Partial” or “All Initial Settings” to set the access limit.
  - If you selected “Partial”
 

An access code is only required for the “Timer Setting”, “Key Operator Tools” initial settings. “MENU PROTECT” will be set for “CHANGE/CONTROL” in the printer initial settings. If you set “MENU PROTECT”, you can set the key operator code in a part of the printer initial settings. ⇒ “Printer Features Parameters” in the Printer Reference 2
  - If you selected “All Initial Settings”
 

An access code will be required to access all the items in the System Settings, Copier/Document Server Features, Printer Features, and Scanner Features.
- If you set the key operator code, you will need to enter it to access the Key Operator Code screen.



## ❖ Display/Print Counter

Allows you to view and print the various counters.

- Display/Print Counter  
Displays counters for each functions (Total, Copier, Printer, A3/DLT, Duplex, Staple).
- Print Counter List  
Prints out a list of counters for each functions.
- To print the counter list
  - ① Press the **[User Tools/Counter]** key.
  - ② Press the **[System Settings]** key.
  - ③ Press the **[Key Operator Tools]** key.
  - ④ Press the **[Display/Print Counter]** key.
  - ⑤ Press the **[Print Counter List]** key.

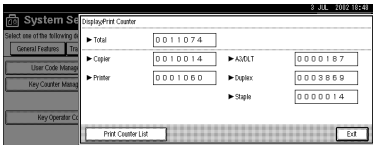

- ⑥ Press the **[Start]** key.
- ⑦ Press the **[Exit]** key.

## ❖ Display/Clear/Print Counter per User Code

Allows you to view and print the various counters accessed with user codes and to set the values to 0.

### Note

- Press the **[▲Prev.]** and **[▼Next]** keys to show all counters.
  - Print Counter for All User Codes  
Prints the counter values for all of the user codes.
  - Clear Counter for All User Codes  
Sets the counter value for all of the user codes to 0.
  - Print Counter per User Code  
Prints the counter values for each of the user codes.
  - Clear Counter per User Code  
Sets the counter value for each of the user codes to 0.

### Note

- Print List for Each User Code ⇒ p.100 "Printing the Counter for Each User Code".

## ❖ Address Book Management

Adds, changes or deletes user codes (max 8-digits). For details on operations, see p.96 "User Codes".

### Note

- You can register up to 1,500 user names.
- You can register up to 500 user codes.
- You can also register user codes from SmartNetMonitor for Admin.
- Even if you change the user codes, the counter values are not cleared.
- If you clear a user code, the counter values associated with it are also automatically cleared.
  - **[Program/Change]**  
This registers new user codes. You can register and change user codes and user names.
  - Name  
User (destination) name, key display, registration number, title selection
  - User Code  
User code, available functions
  - E-mail Address  
E-mail address, register as a sender, sender's password, enter password
  - Group  
Switch title, registration number
  - **[Delete]**  
Deletes a user.

## ❖ Address Book: Program/Change/Delete Group

You can register multiple e-mail addresses in a group.

Then you can easily control the registered e-mail address for each group.

- **[Program/Change]**  
This registers new groups, or changes a group name, key display, title selection, registration number.
- **[Delete]**  
Deletes a group.

## ❖ Address Book: Change Order

Changes the order of registered users (destination).

### Note

- You can rearrange the order of items on the same page, but you cannot move the items to another page. For example, you cannot move an item from "PLANNING" ([OPQ]) to "DAILY" ([CD]).
- ① Press the **[User Tools/Counter]** key.
- ② Press the **[System Settings]** key.

- ③ Press the **[Key Operator Tools]** key.
- ④ Press the **[Address Book:Change Order]** key.

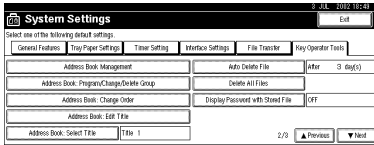

- ⑤ Press the user (destination) key to be moved.

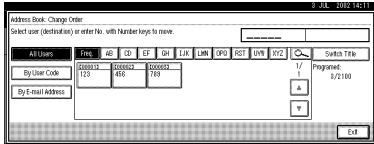

### Note

- You can select a user using the number keys.

- ⑥ Press the user (destination) key in the place you want to move to.

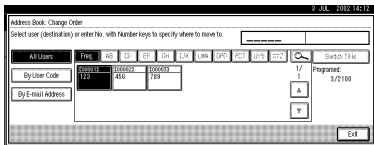

The user (destination) selected in step ⑤ moves to the place selected in step ⑥, and the keys for other users will shift.

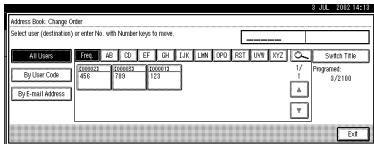

### Note

- You can select a user using the number keys.

## ◆ Address Book: Edit Title

You can edit the title to search for a desired user easily.

- ① Press the **[User Tools/Counter]** key.
- ② Press the **[System Settings]** key.
- ③ Press the **[Key Operator Tools]** key.
- ④ Press the **[Address Book: Edit Title]** key.

- ⑤ Press the title key to be changed.

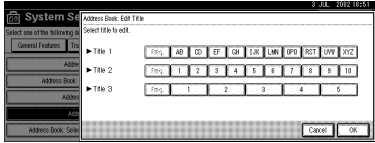

- ⑥ Enter the new name, and then press the **[OK]** key.
- ⑦ Press the **[OK]** key.

❖ **Address Book: Select Title**

Specifies the title to select a user.

 **Note**

- Default setting: *Title 1*

❖ **Auto Delete File**

Specifies whether documents stored in the Document Server are deleted or not after a specified period of time.

 **Note**

- Default setting: *Yes After 3 day (s)*
- If you select “Yes”, documents stored after this setting will be deleted.
- If you select “No”, documents will not be deleted automatically.
- If you select “Yes”, enter a number of days in the range of 1 - 180.
- The default setting is 3 days, which means documents will be deleted 3 days (72 hours) after they are stored.

❖ **Delete All Files**

All documents stored in Document Server will be deleted.

 **Note**

- Even if a password has been set, all documents will be deleted.
- A confirmation dialog box will appear. To delete all documents, select **[Yes]**.

❖ **Display Password with Stored File**

Specifies whether the password for the documents stored in the Document Server is temporarily displayed or not.

 **Note**

- Default setting: *OFF*
- Only when you forget the password, set to **[ON]**. After you confirm the password, be sure to return the setting to **[OFF]**.
- If you set to “ON”, set the “Key Operator Code” to “ON”.

5

❖ **Key Operator's E-mail Address**

By registering the operator's e-mail Address, you can send an e-mail in case of difficulty. Specify whether or not to use this function.

 **Note**

- Default setting: blank

❖ **AOF (Always ON)**

Specify whether or not to use Auto Off function.

 **Note**

- Default setting: ON
- For details about this function, contact your service representative.

# User Codes

By registering user codes, you can limit the users to particular functions and check their use of each function.

## Reference

User codes can also be registered using SmartNetMonitor for Admin (printer option required). ⇒ Network Printing Guide

The management and control items for each function are as follows:

### ❖ Copier

When you set User Code Management, entering the user code is requested before using the Copy function. This enables you to limit user copying.

The number of copies is counted for each user code, so you can check usage of each user.

## Reference

Select the Copier function in User Code Management. ⇒ p.90 "User Code Management"

### ❖ Document Server

When you set User Code Management, the user code is requested before using the Document Server function. This enables you to limit users of the Document Server.

The number of copies in Document Server mode is counted for each user code as an accumulated figure.

## Reference

Select the Document Server function in User Code Management. ⇒ p.90 "User Code Management"

### ❖ Printer

When you set User Code Management, you can print documents from the printer driver using the user code registered.

The number of printed documents is counted for each user code. You can check the usage of each user.

## Note

- To register the printer driver automatically, select "Auto Program" for the printer in User Code Management. If you use the user code set in User Tools, select "Not Auto Program". Set the user codes registered in User Tools for the printer driver.

## Reference

Select the Printer function in User Code Management. ⇒ p.90 "User Code Management"

### ❖ Scanner

Limits who can use the Scanner function and manages use of each user code.

## Reference

Select the Scanner function in User Code Management settings. ⇒ p.90 "User Code Management"

## Important

- The functions associated with each user code are the same. If you change or delete user codes, management data and limits associated with that code will become invalid.

## To Register a New User Code

- 1 Press the **[User Tools/Counter]** key.

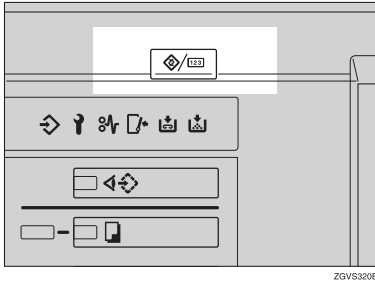

ZGVS320E

- 2 Press the **[System Settings]** key.

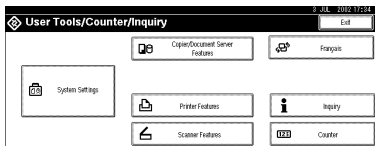

- 3 Press the **[Key Operator Tools]** key.

- 4 Press the **[Address Book Management]** key.

- 5 Press the **[New Program]** key.

### Note

- To register a user code to a registered user, press the user key where the user code is to be registered, or enter the number using the number keys.

- 6 Set the user information.

### Note

- To register a user code to a registered user, skip to step **7**.

## To Register a User Name and Key Name

- 1 Press the **[Change]** key on the right of the user name or key name.

The user name or key name entry dialog box appears.

- 2 Enter the user name or key name, and then press the **[OK]** key.

### Note

- You can use the user name as the user name assigned to the documents in Document Server mode. In this case, entry of the user code is not required. ⇒ p.57 "Document Server"

### Reference

⇒ p.110 "Entering Text"

## To Select the Title

- 1 Press the key for the classification you want to use from "Select Title".

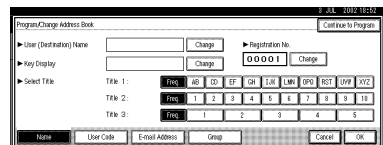

### Note

- The keys you can select are as follows.
  - [Freq.]... Added to the page that is displayed first.
  - [AB],[CD],[EF],[GH],[IJK],[LMN],[OPQ],[RST],[UVW],[XYZ]... Added to the list of items in the title selected.
- You can only select one page for "Select Title".

**7** Press the [User Code] key.

**8** Enter the user code using the number keys, and then press the [#] key.

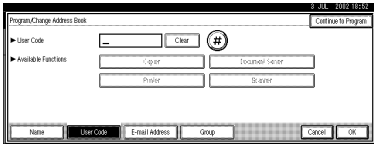

#### Note

- If you make a mistake, press the [Clear] or [Clear/Stop] key, and then enter the user code again.

**9** Select the functions to be used with the user code from “Available Functions”.

**10** To continue registering user codes, press the [Continue to Program] key, and then repeat the procedures from step 6.

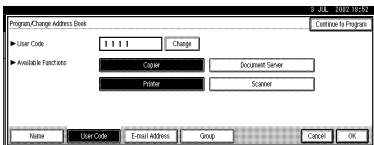

**11** Press the [OK] key.

**12** Press the [Exit] key.

**13** Press the [User Tools/Counter] key.

## Changing a User Code

**1** Press the [User Tools/Counter] key.

**2** Press the [System Settings] key.

**3** Press the [Key Operator Tools] key.

**4** Press the [Address Book Management] key.

**5** Select the registered user code you want to change, or enter the registered number using the number keys.

**6** Enter the new information for the item you want to change.

### Changing a User (Destination) Name or Key Name

**1** Press the [Change] key to the right of the user (destination) name or key name.

**2** Enter the user (destination) name, and then press the [OK] key.

#### Reference

⇒ p.110 “Entering Text”

### Changing a Title

**1** Press the key for the classification you want to use from “Select Title”.

### Changing a User Code

**1** Press the [User Code] key.



- Press the [Change] key, and then enter the new user code using the number keys.

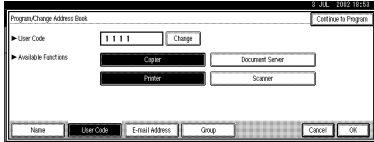

- Press the [#] key.

---

### To change Available Functions

---

- Press the [User Code] key.
- Press the key to select the functions to be enabled.

#### Note

- Press the key to make it highlighted, and the key will be enabled.

- Press the [OK] key.
- Press the [Exit] key.
- Press the [User Tools/Counter] key.

---

## Clearing a User Code

---

### Important

- This operation also deletes user codes registered for multiple functions. User control with the deleted user code will be disabled.

- Press the [User Tools/Counter] key.
- Press the [System Settings] key.
- Press the [Key Operator Tools] key.
- Press the [Address Book Management] key.

---

### To clear a User (destination)

---

- Press the [Delete] key.
- Select the user (destination) you want to delete.  
Press the user (destination) key, or enter the registered number using the number keys.
- Press the [Yes] key in the confirmation screen.

---

### To delete the User Code

---

- Select a user (destination) whose user code is to be deleted.  
Press the user (destination) key to be deleted, or enter the registered number using the number key.
- Press the [User Code] key.

- Press the [Change] key to delete the user code, and then press the [#] key.

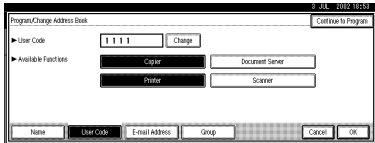

- Press [OK] key.
- Press the [Exit] key.
- Press the [User Tools/Counter] key.

## Displaying the Counter for Each User Code

You can check the counter for each function's user code.

- Press the [User Tools/Counter] key.
- Press the [System Settings] key.
- Press the [Key Operator Tools] key.
- Press the [Display/Clear/Print Counter per User Code] key.
- Press the [Print Counter] key.

The individual function counters for each user code are displayed.

## Printing the Counter for Each User Code

You can print out the counter for each user code using [Print Counter] or [Scanner Counter]. Also, you can print out using both of them together.

- Press the [User Tools/Counter] key.
- Press the [System Settings] key.
- Press the [Key Operator Tools] key.
- Press the [Display/Clear/Print Counter per User Code] key.

To print the number of copies (counter) for each user code

- Select a user code from the left side of the display.

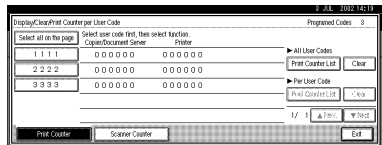

### Note

- Press the [Select all on the page] key if you want to select all user codes on the page.
- Press the [Print Counter List] key of "Per User Code".

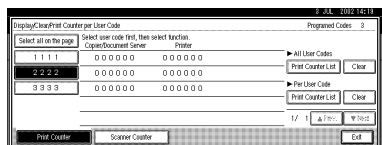

### Note

- Enter the user code, and then press the [#] key if the user code is registered.

To print the number of copies (counter) for all user codes

- 1 Press the **[Print Counter List]** key for "All User Codes".

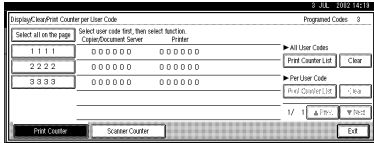

- Enter the user code, and then press the **[#]** key if the user code is registered.

- 5 Press the **[Print Counter]** key.
- 6 Press the **[Print]** key.

## Clearing the Counter

- 1 Press the **[User Tools/Counter]** key.
- 2 Press the **[System Settings]** key.
- 3 Press the **[Key operator Tools]** key.
- 4 Press the **[Display/Clear/Print Counter per User Code]** key.
- 5 Select the user code to clear.

To clear the number of copies (counter) for each user code

- 1 Select a user code from the left side of the display.

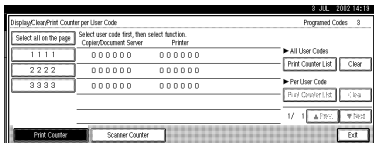

- Press the **[Select all on the page]** key if you want to select all user codes on the page.

- 2 Press the **[Clear]** key for "Per User Code".

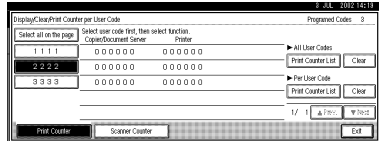

To clear the number of copies (counter) for all user codes

- 1 Press the **[Clear]** key for "All User Codes".

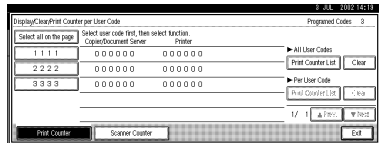

- 6 Press the **[Print Counter]** key.
- 7 Press the **[Print]** key.

# E-mail Destination

By registering an e-mail destination, you can send scanned documents by e-mail.

- It is easy to select an e-mail destination if you register "User (destination) name" and "Key name" for the e-mail destination.
- You can register an e-mail destination as a group.
- You can use the e-mail destination as the Sender's address. In this case, you can set a password in order to prevent its use by other people.

5

## Reference

E-mail destination can also be registered using SmartNetMonitor for Admin (printer option required).  
⇒ Network Printing Guide

## Registering an E-mail Destination

- 1 Press the **[User Tools/Counter]** key.

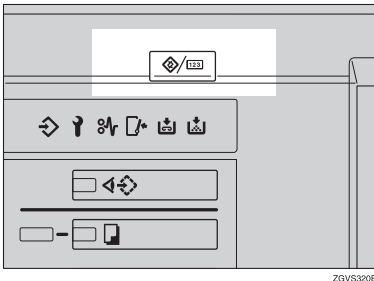

- 2 Press the **[System Settings]** key.

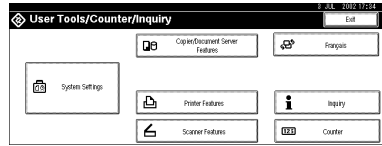

- 3 Press the **[Key Operator Tools]** key.

- 4 Press the **[Address Book Management]** key.

- 5 Press the **[New Program]** key.

### Note

- ❑ To register an e-mail destination to a registered user, press the user key you want to register, or enter the registered number using the number keys.

- 6 Set the user's information.

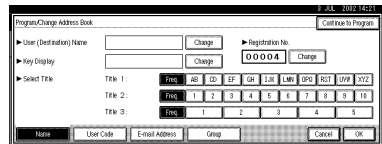

### Note

- ❑ To register an e-mail destination to a registered user, skip to step 7.

To register the user (destination) name and key name

- 1 Press the **[Change]** key on the right of "User (Destination) Name" or "Key Display".

The user (destination) name or key name entry dialog box appears.

- 2** Enter the user (destination) name or key name, and then press the [OK] key.

 **Note**

- You can use the user name when selecting an address to send an e-mail to.
- You can register the user code following the user name. For more details, see p.96 "User Codes".

 **Reference**

⇒ p.110 "Entering Text"

### To select the title

- 1** To classify the user with the title, press the title key from "Select Title".

 **Note**

- The keys you can select are as follows.
  - [Freq.]... Added to the page that is displayed first.
  - [AB], [CD], [EF], [GH], [IJK], [LMN], [OPQ], [RST], [UVW], [XYZ],... Added to the list of items in the title selected.
- You can only select one page for "Select Title".

- 7** Press the [E-mail Address] key.

- 8** Press the [Change] key on the right of the "E-mail Address".

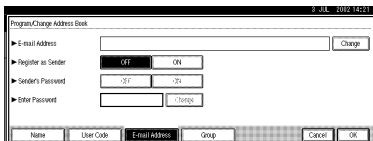

The e-mail address entry dialog box appears.

- 9** Enter the e-mail address.

 **Note**

- You can use the e-mail address as the Sender's address. In this case, you can set a password in order to prevent its use by other people.

 **Reference**

⇒ p.110 "Entering Text"

### Using as a Sender

- 1** Press the [ON] key on the right of the [Register as Sender].

### Setting a password

- 1** Press the [ON] key on the right of the [Sender's Password].
- 2** Press the [Change] key on the right of the "Enter Password".
- 3** Enter the password using the number keys and then press the [#] key.

- 10** Press the [OK] key.

 **Note**

- When a group is registered, other e-mail destinations can be added to the group. ⇒ p.107 "Registering E-mail Destinations to a Group"

## Changing a Registered E-mail Destination

**1** Press the **[User Tools/Counter]** key.

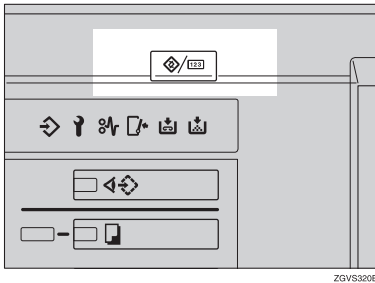

**2** Press the **[System Settings]** key.

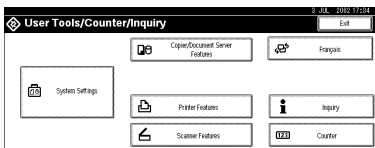

**3** Press the **[Key Operator Tools]** key.

**4** Press the **[Address Book Management]** key.

The registered user list appears.

**5** Select the user of the registered e-mail address you want to change.

Press the user key you want to change or enter the registered number using the number keys.

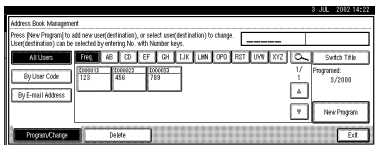

**6** Press the **[E-mail Address]** key.

**7** Enter the items.

To change the e-mail address

**1** Press the **[Change]** key on the right of the e-mail address.

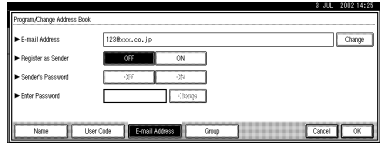

**2** Enter the e-mail address, and then press the **[OK]** key.

**Reference**

⇒ p.110 "Entering Text"

To change the password

**1** Press the **[Change]** key on the right of the password.

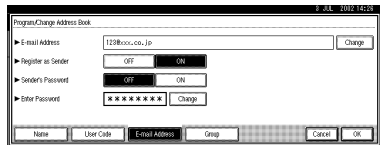

**2** Enter the new password using the number keys, and then press the **[#]** key.

**8** Press the **[OK]** key.

**Note**

- To change the user name, see p.98 "Changing a User (Destination) Name or Key Name".
- To clear the user name, see p.99 "To clear a User (destination)"

## Clearing a Registered E-mail Destination

- 1 Press the **[User Tools/Counter]** key.

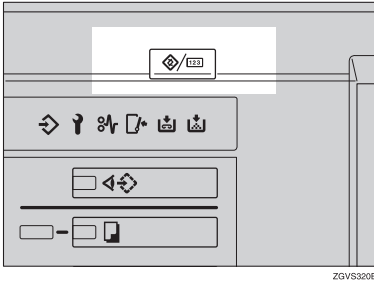

ZGV5320E

- 2 Press the **[System Settings]** key.

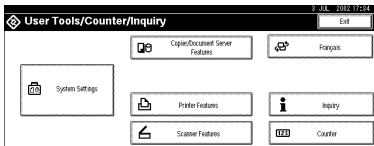

- 3 Press the **[Key Operator Tools]** key.

- 4 Press the **[Address Book Management]** key.

To clear only the e-mail address

- 1 Select the user of the e-mail address you want to clear.

Press the user key you want to clear or enter the registered number using the number keys.

- 2 Press the **[E-mail Address]** key.
- 3 Press the **[Change]** key on the right of the "E-mail Address".
- 4 Press the **[Delete All]** key, and then press the **[OK]** key.

To clear all the informations for the user

- 1 Press the **[Delete]** key.
- 2 Select the user you want to clear.

Press the user key you want to clear or enter the registered number using the number keys.

- 3 Press the **[Yes]** key.

- 5 Press the **[Exit]** key.

# Registering E-mail Destinations to a Group

By registering groups, you can use them as follows;

- You can easily control the registered e-mail destinations for each group.
- You can send the same messages to multiple addresses in a group in bulk.

To divide e-mail destinations into groups, the groups must be registered beforehand.

## Reference

E-mail destination can also be registered into groups using Smart-NetMonitor for Admin (printer option required). ⇒ Network Printing Guide

5

## Registering a New Group

- 1 Press the **[User Tools/Counter]** key.

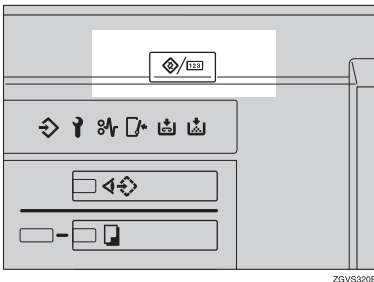

ZGV5320E

- 2 Press the **[System Settings]** key.

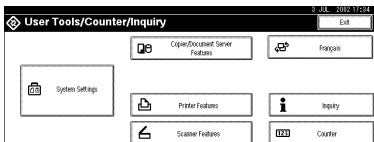

- 3 Press the **[Key Operator Tools]** key.

- 4 Press the **[Address Book: Program/Change/Delete Group]** key.

- 5 Press the **[New Program]** key.

- 6 Press the **[Change]** key on the right of the group name.

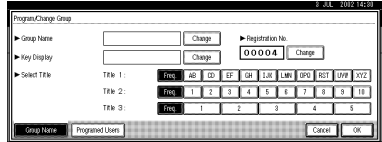

- 7 Enter the group name, and then press the **[OK]** key.

- 8 When you want to change the key name, and then press the **[Change]** key on the right of the key display name. Enter the key display name, and then press the **[OK]** key.

For entering the group name, the key display name is automatically set.

- 9 Press the **[Select Title]** key to sort the group. Go to step 10 if you do not sort the group.

- 10 Press the **[OK]** key.



## Registering E-mail Destinations to a Group

You can register the e-mail destination to a group.

**Note**

- When newly registering an e-mail destination, you can also register groups at the same time.

**1** Press the **[User Tools/Counter]** key.

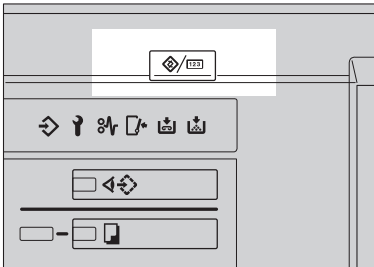

ZGV5320E

**2** Press the **[System Settings]** key.

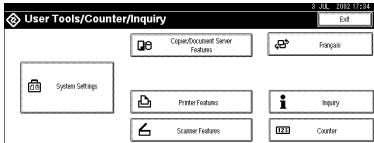

**3** Press the **[Key Operator Tools]** key.

**4** Press the **[Address Book Management]** key.

**5** Press the user (destination) key that you want to register in a group.

**6** Press the **[Group]** key.

**7** Select a group to which you want to register the e-mail destinations.

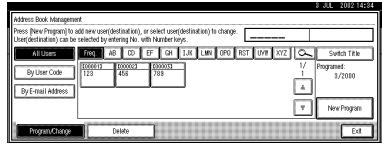

**8** Press the **[OK]** key.

## Deleting an E-mail Destination from a Group

**1** Press the **[User Tools/Counter]** key.

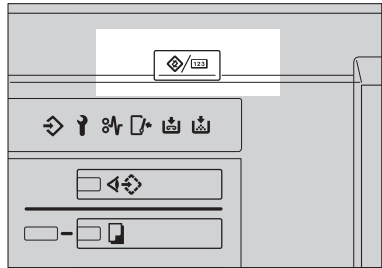

ZGV5320E

**2** Press the **[System Settings]** key.

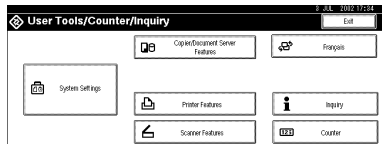

**3** Press the **[Key Operator Tools]** key.

**4** Press the **[Address Book Management]** key.

**5** Select the user (destination) key to delete from a group.

Press the user (destination) key which you want to delete, or enter the registered number using the number keys.

**6** Press the **[Group]** key.

**7** Press the highlighted group key.

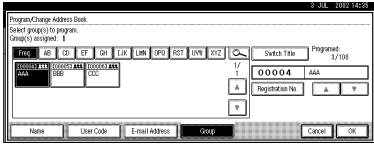

The user is deleted.

**8** Press the [OK] key.

## Displaying an E-mail Destination

You can confirm the user (destination) of each group.

**1** Press the [User Tools/Counter] key.

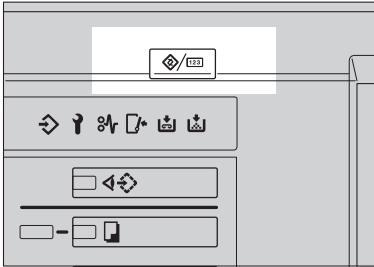

**2** Press the [System Settings] key.

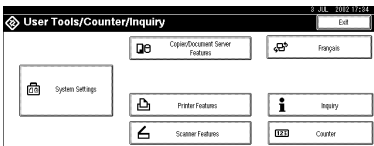

**3** Press the [Key Operator Tools] key.

**4** Press the [Address book: Program/Change/Delete Group] key.

**5** Select a group where the data you want to confirm is registered.

**6** Press the [Programed Users] key.

All the user names (e-mail destinations) are displayed.

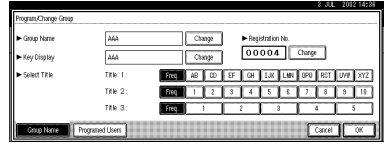

**7** Press the [OK] key.

## Deleting a Group

**1** Press the [User Tools/Counter] key.

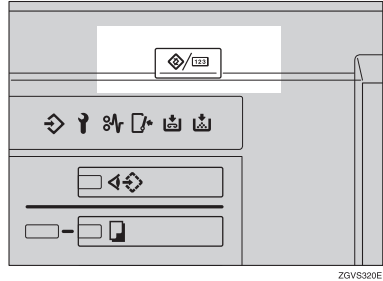

**2** Press the [System Settings] key.

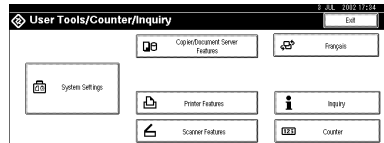

**3** Press the [Key Operator Tools] key.

**4** Press the [Address Book: Program/Change/Delete Group] key.

**5** Press the [Delete] key.

**6** Press the group key you want to delete.

**7** Press the [Yes] key.

## Changing a Group Name

- 1 Press the [User Tools/Counter] key.

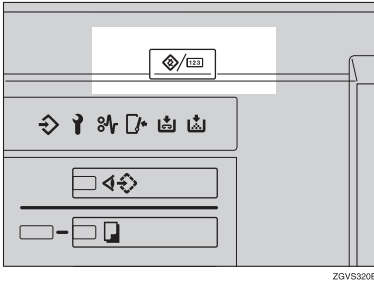

ZGV5320E

- 2 Press the [System Settings] key.

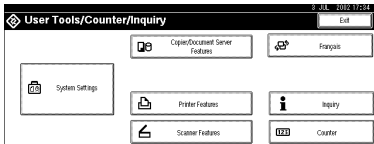

- 3 Press the [Key Operator Tools] key.

- 4 Press the [Address Book: Program/Change/Delete Group] key.

- 5 Press the group key you want to change.

- 6 Reenter the item you want to change.

To change a group name or the key display

- 1 Press the [Change] key in "Group Name" or "Key Display".

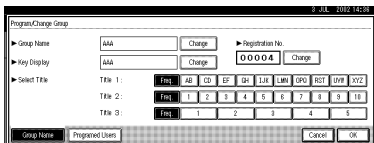

- 2 Reenter the group name or key display, and then press the [OK] key.

To change a title

- 1 Press the title key in "Select Title" of the group you want to sort.

To change a registration number

- 1 Press the [Change] key in "Registration No."

- 2 Enter the registration number using the number keys.

- 3 Press the [#] key.

- 7 Press the [OK] key.

# Entering Text

This section describes how to enter characters. When you enter a character, it is shown at the position of the cursor. If there is a character at the cursor position, the entered character is shown before that character.

---

## Available Characters

---

- Alphabetic characters  
ABCDEFGHIJKLMNOPQRSTUVWXYZabcdefghijklmnopqrstuvwxyz
- Symbols
- Numerals  
0123456789

---

## Keys

---

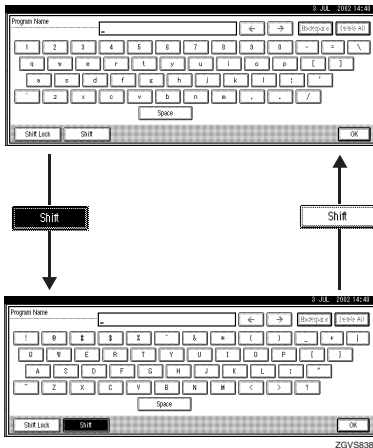

 **Note**

- When entering uppercase or lowercase letters continuously, use the **[Shift Lock]** key to lock the case.

---

## Entering Text

---

---

### Entering letters

---

- 1** Press the [Shift] key to switch between uppercase and lowercase.
  - 2** Press the letters you want to enter.
- 

### Deleting characters

---

- 1** Press the [Backspace] or [Delete All] key to delete characters.



# 6. Troubleshooting

## If Your Machine Does Not Operate as You Want

### General

Machine Status	Problem/Cause	Action
Please wait.	This message appears when you turn on the operation switch or change the toner bottle.	Wait for the machine.
The display panel is off.	The screen contrast knob is turned to the dark position.	Set the screen contrast knob to the light position for proper viewing of the display panel.
	The machine is in Low Power mode.	Press the <b>[Energy Saver]</b> key to cancel Low Power mode.
	The operation switch is turned off.	Turn on the operation switch.
Nothing happens when the operation switch is turned on.	The main power switch is turned off.	Turn on the main power switch.
Memory is full.	The number of scanned pages exceeds the capacity of the hard disk.	Press the <b>[Delete File]</b> key to delete unnecessary documents. ⇒ p.66 "Deleting Saved Documents"
The function status indicator is red.	The function associated with the red indicator has been interrupted.	Press the function key corresponding to the indicator. Follow the instructions displayed in the display panel.
The operation switch continues blinking and does not turn off when pressed.	This occurs in the following cases: <ul style="list-style-type: none"><li>• The machine is in communication with external equipment.</li><li>• The hard disk is in operation.</li></ul>	Check that the computer does not control the machine when you turn off the main power switch.
The original images are printed on the reverse side of the paper.	You may have loaded the paper incorrectly.	Load paper into the large capacity tray (LCT) and a bypass tray with the print side up, or into a paper tray with the print side down. ⇒ p.116 "Loading Paper"

Machine Status	Problem/Cause	Action
Misfeeds occur frequently.	The side guides of the paper tray may not be locked.	Check the side guides are locked. ⇒ p.132 "Changing the Paper Size"
	The end guide of the paper tray may not be locked.	Check that the end guide is locked. ⇒ p.132 "Changing the Paper Size"
	You may have loaded paper whose size cannot be detected automatically.	When you use paper of a size that cannot be detected automatically, set the paper size. ⇒ p.79 "Tray Paper Size: (Tray 2,3)", p.177 "Copy Paper"
	The saddle stitching staple cartridge for the Booklet Finisher has been removed.	Reset the saddle stitching staple cartridge. ⇒ p.134 "Adding Staples"
An error message remains, even if misfed paper is removed.	When a misfeed message appears, it remains until you open and close the cover, as required.	Clear misfed paper and open and close the front cover. ⇒ p.122 "Clearing Misfeeds"
Cannot duplex print	You cannot use the paper in the bypass tray for duplex printing.	For duplex printing, select Tray 1-3 in Copier mode or with the printer driver.
	The setting for the Paper Type: Tray 1-3 is "1 Side Copy".	Select "2 Sided Copy" for Paper Type: Tray 1-3 ⇒ p.80 "Paper Type: (Tray1-3, LCT)"
During saddle stitching, paper comes out open and not neatly stacked.	Depending on the type of paper, the paper opens as it rebounds when it is folded.	Select a paper type with low rebound.
The user code entry dialog box is displayed.	Users are restricted by user management.	Enter the user code (up to 8-digits), and then press the [#] key.



## Document Server

Problem	Action
"Scanned pages exceeded max. number. Do you want to store the scanned pages as a file?" appears.	<p>The number of scanned pages exceeds the capacity per file of the Document Server.</p> <p>If you want to store scanned originals as a file, press the <b>[Yes]</b> key. The originals are stored as a file in the Document Server.</p> <p>If you don't want scanned originals to be stored, press the <b>[No]</b> key. The scanning data will be cleared.</p>
You forgot your password.	<p>You can confirm your password.</p> <p>Press the <b>[ON]</b> key temporarily for "Display Password with Stored File" in the User Tools. You can check the password when you have selected the file.</p> <p>You can delete all the saved documents at once with the User Tools.</p> <p>Make sure that no important documents are saved in the Document Server before deleting all saved documents.</p> <p>⇒ p.94 "Delete All Files"</p>
You cannot find out what is saved in a file.	Check the date or time column in the "Document Server: Files" display.
	Check the contents of the document by printing the first page of it. Press the desired document in the "Document Server: Files" display, and press the <b>[Print 1st Page]</b> key followed by the <b>[Start]</b> key.
Memory becomes full frequently.	Press the <b>[Delete File]</b> key to delete selected documents, thereby increasing available memory.
You want to check print before making a large print run.	Check print quality by printing out only the first set using the <b>[Sample Copy]</b> key.
You want to save a document so it will not be deleted automatically.	<p>Turn "Auto Delete File" off, and then save the document in the Document Server. ⇒ p.94 "Auto Delete File"</p> <p>If you later turn on "Auto Delete File", the function is only applied to documents saved after turning the function on.</p>
"Cannot copy. Original is being scanned by other functions." appears.	The Copy function is in use. To cancel the job in process, first press the <b>[Exit]</b> key, and then press the <b>[Copy]</b> key. Next press the <b>[Clear/Stop]</b> key. When the message "[Stop] key was pressed. Stop printing?" appears, press the <b>[Stop]</b> key.

# Loading Paper

## Note

- You can change the paper size in tray 2 and 3.⇒ p.132 “Changing the Paper Size”

## Reference

For details about paper types and sizes, see p.177 “Copy Paper”.

---

## Loading Paper in Tray 1 (Tandem Tray)

---

### Important

- When paper on the right side in tray 1 runs out, paper on the left will automatically move to the right. While the paper is moving, the machine instructs you to wait. At this time, do not pull out the tray.

### Note

- You can load paper even while making copies using paper in tray 1. During copying, you can pull out the left half of the tray.

- 1** Pull out the paper tray until it stops.

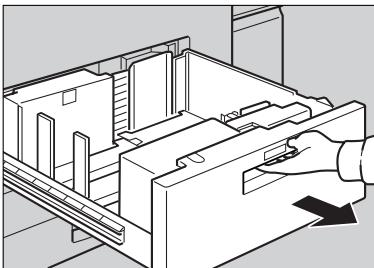

Z6VY301E

- 2** Square the paper, and then load it in the tray.

---

When the whole tray is pulled out

---

- 1** Load the paper.

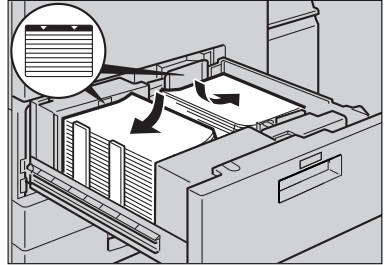

Z6VY311E

### Important

- Align the right edge of the right copy paper stack to the right edge of the tray, or the left edge of the left copy paper stack to the left edge of the tray.

---

When the left half of the tray is pulled out

---

- 1** Load the paper in the left tray.

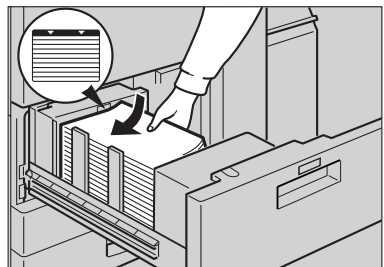

Z6VY321E

**⚠️ Important**

- ❑ Confirm that the top of the stack is no higher than the limit mark inside the tray.
- ❑ Align the left edge of the paper stack to the left edge of the tray.

**📌 Note**

- ❑ Shuffle the paper before loading.
- ❑ Straighten curled or warped paper before loading.

**3** Gently push the paper tray in until it stops.

## Loading Paper in Tray 2 and 3

**1** Pull out the paper tray until it stops.

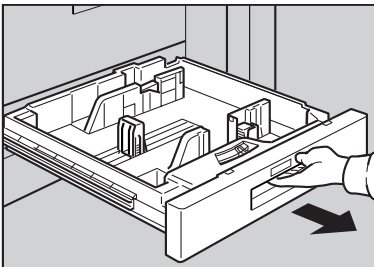

ZGVY331E

**2** Square the paper, and then load it in the tray.

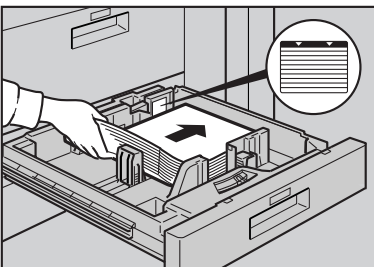

ZGVY341E

**⚠️ Important**

- ❑ Confirm that the top of the stack is not higher than the limit mark inside the tray.
- ❑ Align the left edge of the copy paper stack to the left edge of the tray.

**📌 Note**

- ❑ Shuffle the paper before loading.
- ❑ Straighten curled or warped paper before loading.

**3** Gently push the paper tray in until it stops.

## Loading Paper in the Large Capacity Tray (LCT)

**1** Open the top cover of the large capacity tray (LCT).

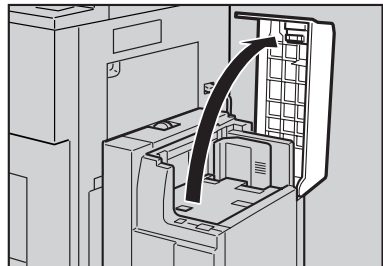

ZGVY371E

**2** Load the paper in the tray along the edge on the left.

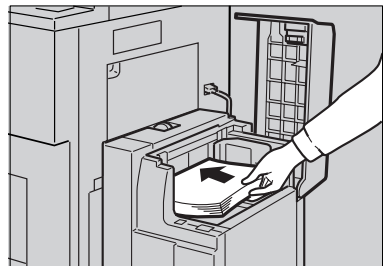

ZGVY382E

**3** Press the **[Down]** key.

The key blinks while the bottom plate is moving down.

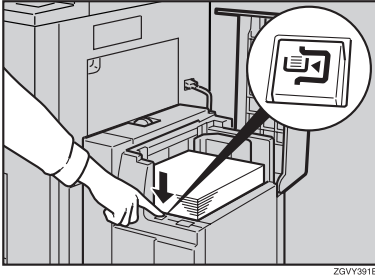

ZGVY391E

**4** Load paper by repeating steps **2** and **3**.

**Note**

- The tray can hold up to 4,000 sheets.

**5** Close the top cover of the large capacity tray (LCT).

**Important**

- Align the left edge of the copy paper stack to the left edge of the tray.

## Loading Paper in the Interposer

**Important**

- Load paper on the side already printed (the side you want as front).
- Load paper in the interposer in the same orientation as paper in the paper tray.
- The staple or punching location will be on the left side of the paper, when you are facing the machine.
- Do not place anything on top of or leave documents on the sensor. This may lead to the paper size not being correctly scanned or paper jams.

**1** Load the paper.

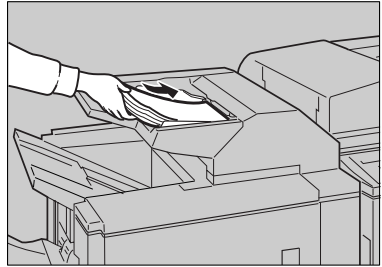

ZGVY602E

**Important**

- Confirm the top of the stack is not higher than the limit mark inside the tray.

**Note**

- Shuffle paper before loading.
- Straighten curled or warped paper before loading.

**2** Adjust the paper guides to the paper size.

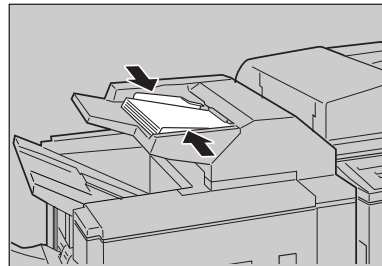

ZGVY611E

# Suspend Copy when using Finisher 3000B (100-Sheet Staples)

You can suspend a large volume of copies when using Finisher 3000B (100-Sheet Staples).

## Note

- You can suspend copy only when the output tray is specified as the finisher shift tray. ⇒ p.77 “Output: Copier”

## **1** Press the **[Suspend/Resume]** key.

The key lights up.

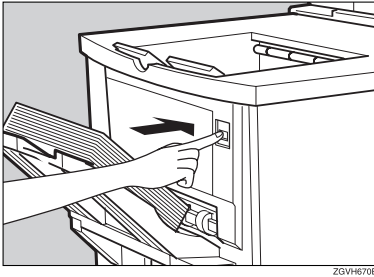

## **2** Remove the stack of paper from the finisher shift tray.

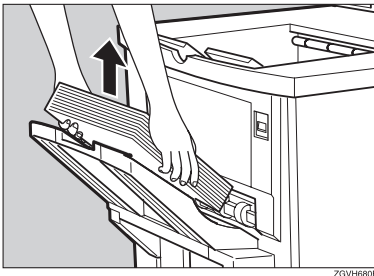

## **3** Press the **[Start]** key.

The key turns off, and then copying restarts.

## Adding Toner

When  is displayed, it is time to add toner.

### **WARNING:**

- **Do not incinerate used toner or toner containers. Toner dust might ignite when exposed to an open flame. Dispose of used toner containers in accordance with local regulations.**

### **CAUTION:**

- *Keep toner (used or unused) and toner containers out of reach of children.*



### **CAUTION:**

- *Our products are engineered to meet high standards of quality and functionality, and we recommend that you use only the expendable supplies available at an authorized dealer.*

### **Important**

- If you use toner other than that recommended, an error might occur.
- When adding toner, do not turn off the operation switch. If you do, your settings will be cleared and  will appear again because the machine will not recognize that toner has been added.
- Always add toner after the machine instructs you.

### **Note**

- You can still make about 1000 copies after the messages “ Toner is almost empty.” and “Change Toner Cartridge.” appear cyclically, but replace toner early to prevent poor copy quality.
- When the toner runs out, “ Add Toner” will be displayed on the screen and printing will be disabled.

### **Reference**

For details about toner storage, see p.150 “Toner Storage”.

# Replacing Toner

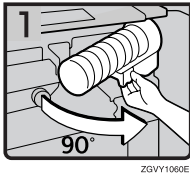

- Open the front cover of the machine.
- Pull out the lever under the toner bottle toward you 90°.

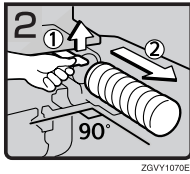

- Raise the green lever, and then gently pull out the toner bottle.

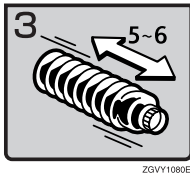

- Hold the new bottle horizontally, and then shake it five or six times without removing the outer cap.

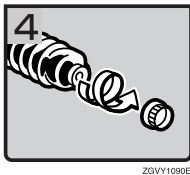

- Remove the outer cap.

 **Note**

- Do not remove the inner cap.

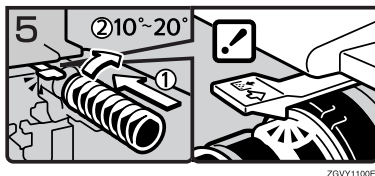

- Place the toner bottle in position, then push it in until the green lever clicks.

 **Note**

- If you cannot get it to click in, pull out the toner bottle a little, slightly rotate it to the right by 10 – 20°, then try again.

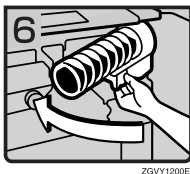

- Return the lever under the toner bottle to its original position.
- Close the front cover of the machine.

## Clearing Misfeeds

### **CAUTION:**

- *The fusing section of this machine might be very hot. Caution should be taken when removing misfed paper.*

### **Important**

- When clearing misfeeds, do not turn off the operation switch. If you do, your copy settings are cleared.
- To prevent misfeeds, do not leave any torn scraps of paper within the machine.
- If misfeeds occur repeatedly, contact your service representative.

### **Note**

- More than one misfeed location may be indicated. In such a case, check every applicable area. See the following charts: A, B, C, D, E, F, P, Q, R, U, W
- You can find a sticker explaining how to remove misfed paper inside the front cover or finisher.





**When D is lit**

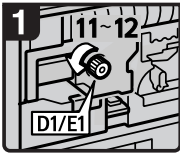

- Open the front cover.
- Turn fuser unit knob D1/E1 11-12 times counterclockwise to eject the paper.

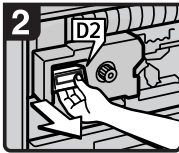

- Pull handle D2 and pull out the fuser unit.

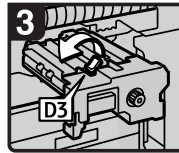

- Raise lever D3.

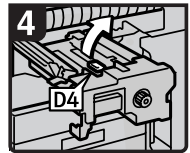

- Raise lever D4.

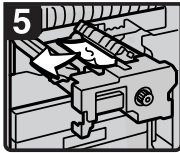

- Remove the paper being careful not to touch the area around lever D4.

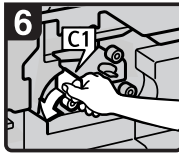

- Turn lever C1 to the left.

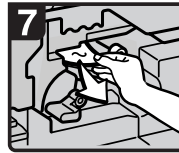

- Remove misfed paper.
- Return lever C1 to its original position.
- Close the front cover.

6

**When E is lit**

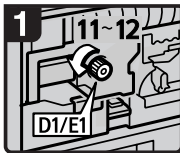

- Open the front cover.
- Turn fuser unit knob D1/E1 11-12 times counterclockwise to eject the paper.



- Pull handle E2 and fully pull out the duplex unit.

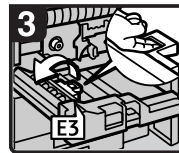

- Raise lever E3.

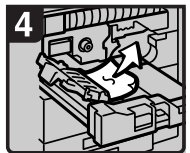

- Remove the paper being careful not to touch the area around lever E3.

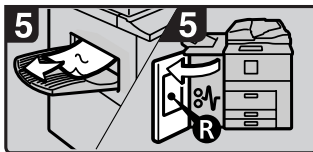

- Remove the paper from the output tray if it is visible. (When the finisher is installed, open the finisher front cover and remove misfed paper.)
- Close the front cover.

**When C is lit**

- 1
- 2

- Open the front cover.
- Turn lever C1 to the left.
- Turn lever C2 counter-clockwise and remove misfed paper.
- Close the front cover.

**When B is lit**

- 1
- 2

- Open the front cover.
- Turn knob B1 counter-clockwise and remove misfed paper.
- Return lever B2 to its original position.
- Close the front cover.

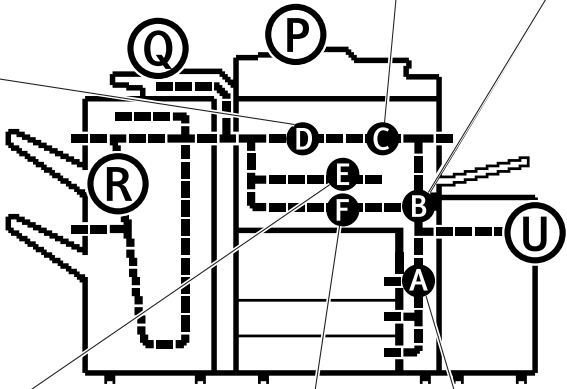

**When A is lit**

- 1
- 2

- Open the front cover.
- Push button A and open the guide plate.
- Remove misfed paper.
- Close the front cover.

**When F is lit**

- 1
- 2
- 3

- Open the front cover.
- Pull handle E2 and fully pull out the duplex unit.
- Lower lever F while pressing it.
- Remove misfed paper.
- Return lever F to its original position.
- Close the front cover.

ZGVY449E

**When Q is lit**

**Interposer**

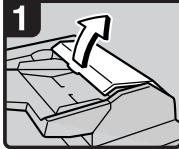

- Open the interposer upper cover.

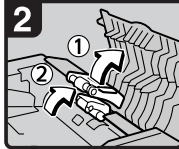

- Raise the feed roller.

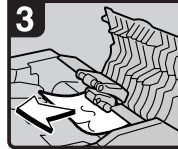

- Remove misfed paper.
- Close the interposer upper cover.

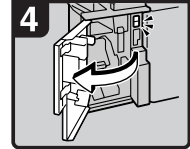

- Open the finisher front cover.

**When R is lit**

**Finisher 3000M (50-Sheet Staples)**

When R1, R2 or R3 is lit

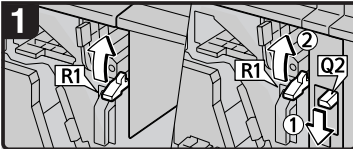

- Open the front cover.
- Raise lever R1.
- When the optional interposer is installed, lower lever Q2, and then raise lever R1.

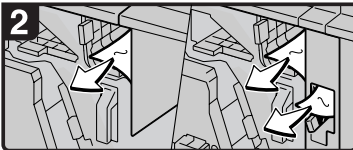

- Remove misfed paper.

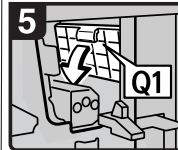

- Lower lever Q1.



- Remove misfed paper.
- Close the finisher front cover.

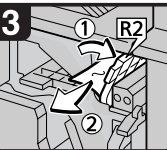
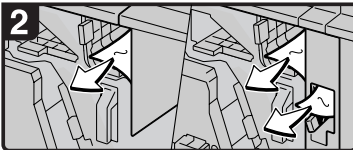

- If you cannot remove misfed paper, raise lever R2 and remove it.

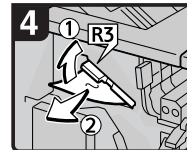

- Raise lever R3 and remove misfed paper.
- Close the front cover.

When R4, R5, R6 or R7 is lit

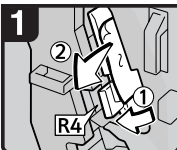

- Open the front cover.
- Lower lever R4 and remove misfed paper.

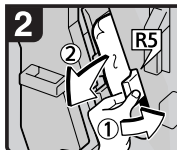

- If you cannot remove misfed paper, lower lever R5 and remove it.

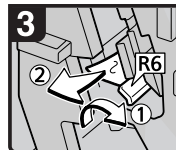

- If you cannot remove misfed paper, raise lever R6 and remove it.

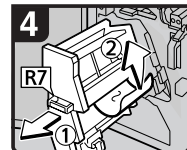

- Pull handle R7 and pull out the staple unit, then remove misfed paper.
- Close the front cover.

**When P<sub>1</sub> is lit**

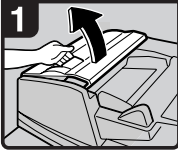

- Open the document feeder cover.



- Raise the feed roller.

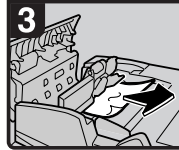

- Remove misfed originals.
- Close the document feeder cover.

**When P<sub>2</sub> is lit**

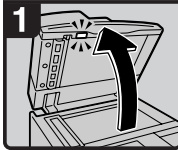

- Lift the document feeder.

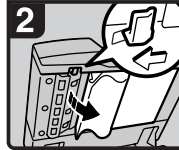

- Slide the lever and open the cover.



- Remove misfed originals.
- Close the cover.

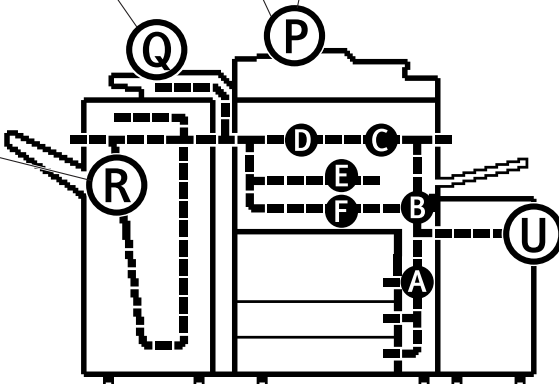

**When U is lit**



- Open the top cover and remove misfed paper.
- Close the top cover.

Z6VY462E

**When R is lit**

**Booklet Finisher**

When R1, R2 or R3 is lit

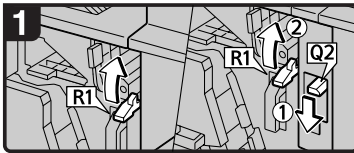

- Open the front cover.
- Raise lever R1.
- When the optional interposer is installed, lower lever Q2, and then raise lever R1.

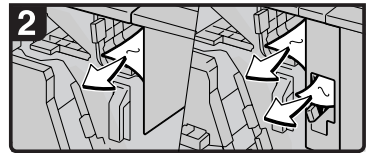

- Remove misfed paper.

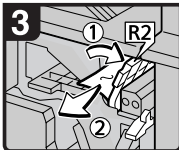

- If you cannot remove misfed paper, raise lever R2 and remove it.

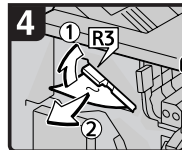

- Raise lever R3 and remove misfed paper.
- Close the front cover.

When R4, R5 or R6 is lit

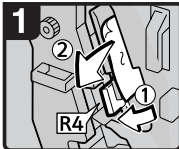

- Open the front cover.
- Lower lever R4 and remove misfed paper.

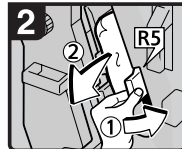

- If you cannot remove misfed paper, lower lever R5 and remove it.

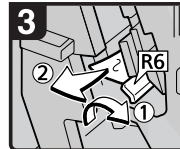

- If you cannot remove misfed paper, raise lever R6 and remove it.

When R7, R8 or R9 is lit

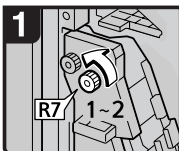

- Turn knob R7 counter-clockwise.

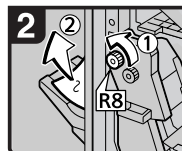

- Turn knob R8 counter-clockwise and remove misfed papers.

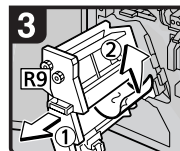

- Pull handle R9 and pull out the staple unit, then remove misfed paper.
- Close the front cover.

**When W is lit**

**Mailbox**

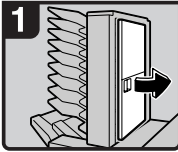

• Open the mailbox right cover.



• Remove misfed paper.

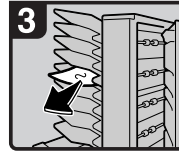

• Remove misfed paper.  
• Close the mailbox right cover.

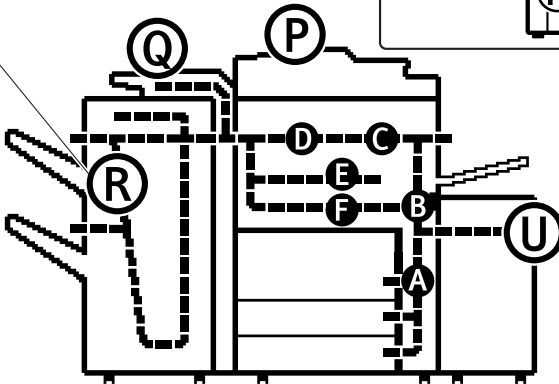
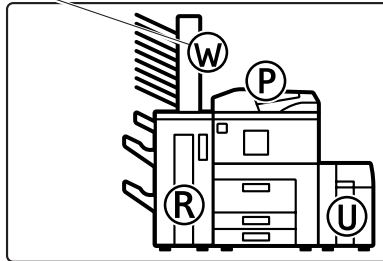

**When R is lit**

**Finisher 3000B (100-Sheet Staples)**

When R1, R2 or R3 is lit

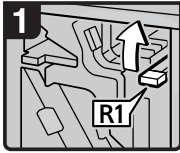

- Open the front cover.
- Raise lever R1.

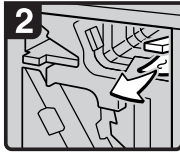

- Remove misfed paper.

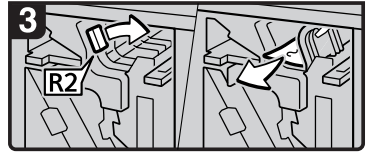

- If you cannot remove misfed paper, turn lever R2 to the right and remove it.

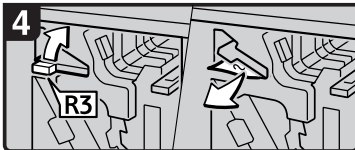

- If you cannot remove misfed paper, raise lever R3 and remove it.

When R4 or R5 is lit

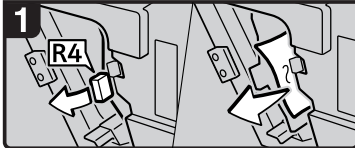

- Open the front cover.
- Pull lever R4 and remove misfed paper.

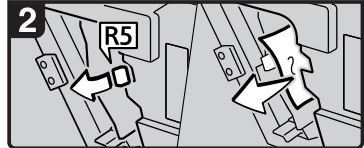

- If you cannot remove misfed paper, pull lever R5 and remove it.

When R6 or R7 is lit

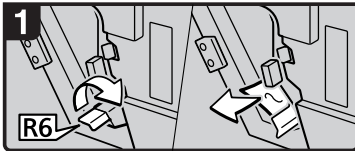

- If you cannot remove misfed paper, raise lever R6 and remove it.

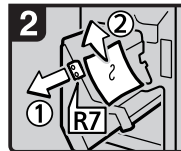

- Pull handle R7 and pull out the staple unit, then remove misfed paper.
- Close the front cover.



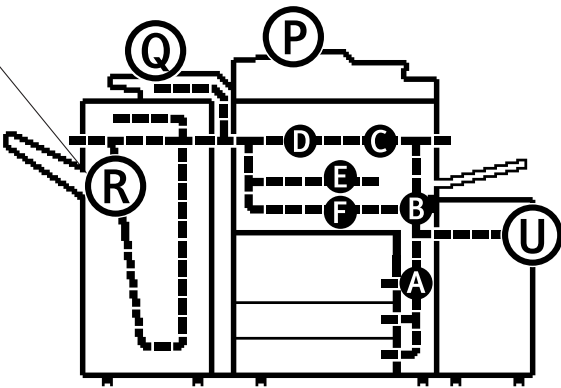

ZGVY520E

# Changing the Paper Size

## Preparation

Be sure to select the paper size with User Tools. Otherwise, mis-feeds might occur. ⇒ p.79 "Tray Paper Size: (Tray 2,3)"

## Important

- ❑ If you wish to change the paper size set in the paper tray 1 or the optional large capacity tray (LCT), contact your service representative.

## Reference

For details about paper sizes, and types see ⇒ p.177 "Copy Paper".

- 2 Press the lock button, and then adjust the side fences and back fence to the new paper size while pushing the release lever.

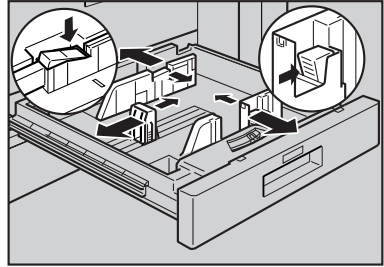

ZGVY411E

- 3 Square the paper and load it in the paper tray, and then press the lock button.

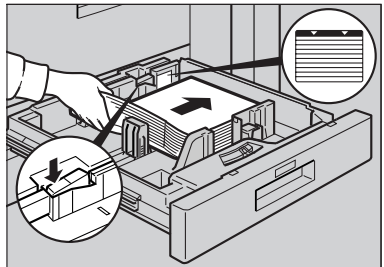

ZGVY421E

## 6 Changing the Paper Size in Tray 2 or 3

- 1 Make sure the paper tray is not being used. Then fully pull out the paper tray.

Remove the paper in the tray.

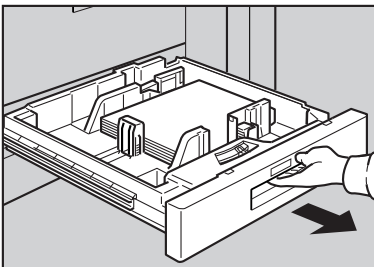

ZGVY401E

## Important

- ❑ Confirm that the top of the stack is not higher than the limit mark inside the tray.
- ❑ Align the right edge of the copy paper stack to the right edge of the tray.

## Note

- ❑ Shuffle the paper before loading it in the tray.
- ❑ Straighten curled or warped paper before loading it in the tray.

- 4** Set the paper size selector knob inside the tray to the new size.

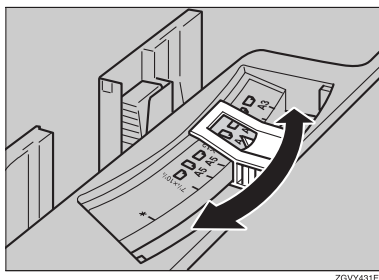

ZGVY431E

- 6** Check the paper size displayed on the display panel.

### Important

- Problems might occur if the size of the paper set does not match the paper size selector, such as:
  - Misfeeds
  - Parts of the image are not copied

---

To adjust the paper size to one not available on the paper size selector

---

- 1** Set the paper size selector knob to the **\*** mark on the left.
- 2** Press the **[User Tools/Counter]** key.
- 3** Press the **[System Settings]** key.
- 4** Press the **[Tray Paper Setting]** key.
- 5** Press the **[Tray Paper Size]** key.
- 6** Select the size, and then press the **[OK]** key.
- 7** Press the **[Exit]** key or press the **[User Tools/Counter]** key to exit the User Tools.

### Reference

For details, see p.79 "Tray Paper Settings".

- 5** Gently push the paper tray until it stops.

# Adding Staples

**Note**

- When removing jammed staples, staples might not be ejected the first few times you try to use the stapler.

**Important**

- If you use a staple cartridge other than that recommended, staple failure or staple jams might occur.
- A paper jam will occur if the machine staples using the Booklet Finisher without the saddle stitch stapler cartridge. Make sure the cartridge is set.

**Reference**

For details about the type of finisher, see p.23 “External Options”.

## Finisher 3000M (50-Sheet Staples), Booklet Finisher

6

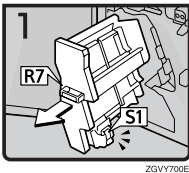

- Open the finisher front cover.
- Pull out the staple unit.

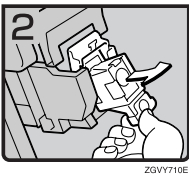

- Pull out the cartridge gently.

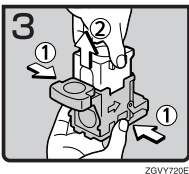

- Pull up the upper unit of the cartridge while holding both sides of the cartridge.

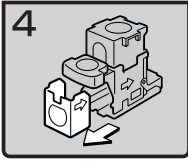

ZGVY730E

- Take out the empty refill in the direction of the arrow.

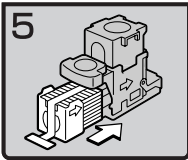

ZGVY740E

- Align the arrows on the new refill and the cartridge, and then push in the refill until it clicks.

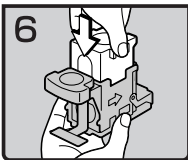

ZGVY750E

- Push down the upper unit gently into the cartridge.

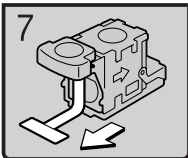

ZGVY760E

- Pull out the ribbon.

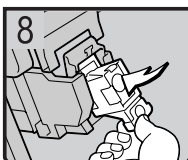

ZGVY770E

- Push the cartridge down until it clicks.

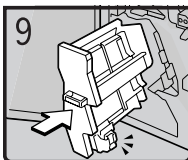

ZGVY780E

- Return the staple unit to its original position.
- Close the finisher front cover.

## Booklet Finisher (Saddle Stitch)

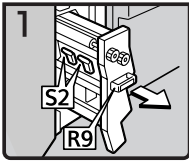

ZGVY790E

- Open the finisher front cover.
- Pull out the staple unit.

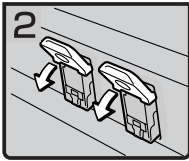

ZGVY800E

- Pull lever S2.

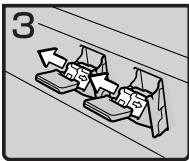

ZGVY810E

- Pull out the cartridge gently.

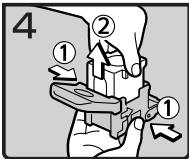

ZGVY820E

- Pull up the upper unit of the cartridge while holding both sides of the cartridge.

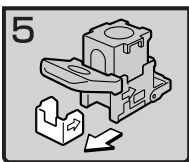

ZGVY830E

- Take out the empty refill in the direction of the arrow.

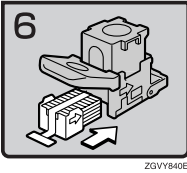

- Align the arrows on the new refill and the cartridge, and then push in the refill until it clicks.

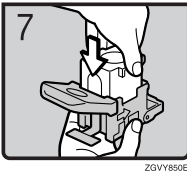

- Push down the upper unit gently into the cartridge.

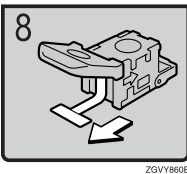

- Pull out the ribbon.

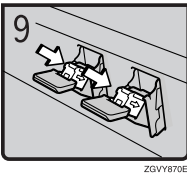

- Push the cartridge down until it clicks.

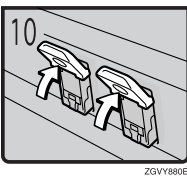

- Return lever S2 to its original position.

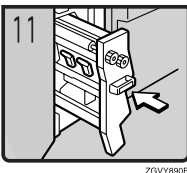

- Return the staple unit to its original position.
- Close the finisher front cover.

## Finisher 3000B (100-Sheet Staples)

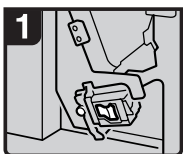

ZGVY1300E

- Open the finisher front cover.

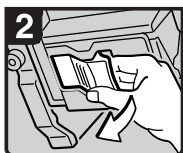

ZGVY1400E

- Pull out the cartridge lever.

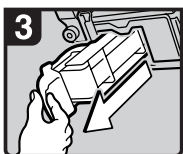

ZGVY1500E

- Pull out the cartridge.

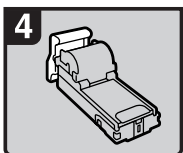

ZGVY1600E

- Put the cartridge down on a level surface.

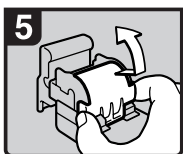

ZGVY1700E

- Raise the cover up.

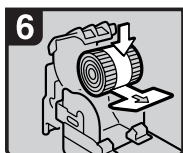

ZGVY1800E

- Set the new refill.



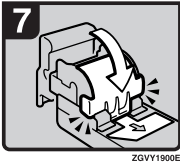

- Lower the cover until it clicks.

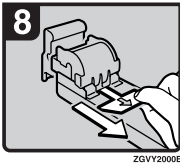

- Pull out the ribbon.

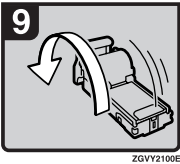

- Turn the cartridge around.

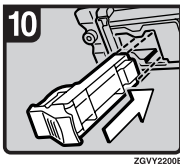

- Reinstall the cartridge.

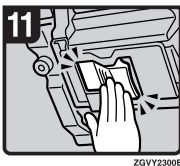

- Push the cartridge until it clicks.



- Close the finisher front cover.

# 🔧 Removing Jammed Staples

## ⚠️ Important

- ❑ A paper jam will occur if the machine staples using the Booklet Finisher without the saddle stitch stapler cartridge. Make sure the cartridge is set.

## 📝 Note

- ❑ Staples might jam due to curled copy paper. In this case, try turning the paper over in the tray. If there is no improvement, change to paper with less curl.
- ❑ When removing jammed staples, staples might not be ejected the first few times you try to use the stapler.

## 🔍 Reference

For details about the type of finisher, see p.23 “External Options”.

## Finisher 3000M (50-Sheet Staples), Booklet Finisher

6

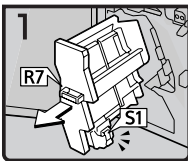

ZGVY900E

- Open the finisher front cover.
- Pull out the staple unit.

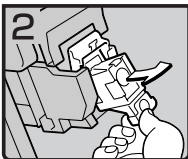

ZGVY910E

- Pull out the cartridge gently.

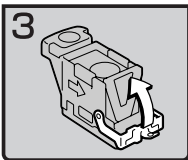

ZGVY920E

- Open the face plate.

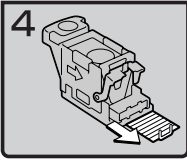

- Remove jammed staples.

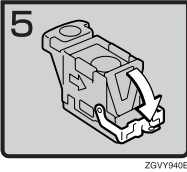

- Pull down the face plate of the cartridge until it clicks.

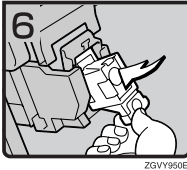

- Push the cartridge down until it clicks.

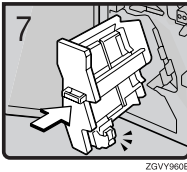

- Return the staple unit to its original position.
- Close the finisher front cover.

## Booklet Finisher (Saddle Stitch)

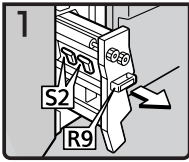

ZGVY970E

- Open the finisher front cover.
- Pull out the staple unit.

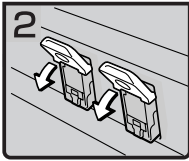

ZGVY980E

- Pull lever S2.

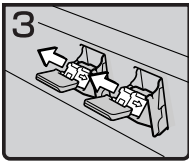

ZGVY990E

- Pull out the cartridge gently.

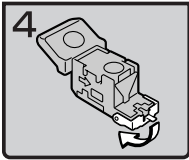

ZGVY1000E

- Open the face plate of the cartridge.

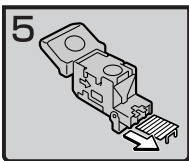

ZGVY1010E

- Remove jammed staples.

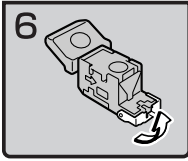

ZGVY1020E

- Pull the face plate of the cartridge down until it clicks.

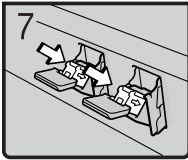

ZGVY1030E

- Push the cartridge down until it clicks.

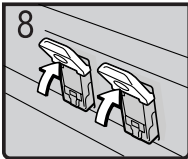

ZGVY1040E

- Return lever S2 to its original position.

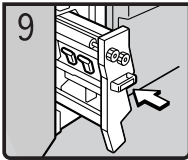

ZGVY1050E

- Return the staple unit to its original position.
- Close the front cover of the finisher.

## Finisher 3000B (100-Sheet Staples)

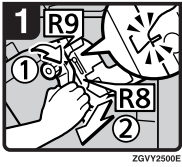

- Open the finisher front cover.
- Turn knob R9 until the marks are aligned.
- Pull lever R8 and pull out the staple unit completely.

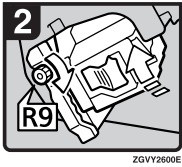

- Turn knob R9 to rotate the staple unit.

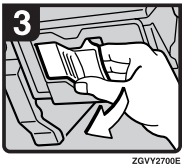

- Pull out the cartridge lever.

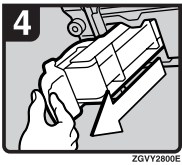

- Pull out the cartridge.

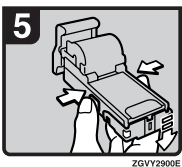

- Push the buttons on the both sides of the cartridge and open the face plate.

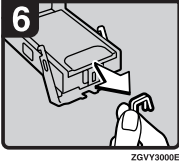

- Remove jammed staples.

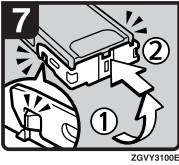

- Lower the face plate until it clicks.

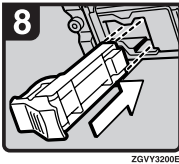

- Reinstall the cartridge.

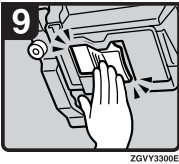

- Push the cartridge until it clicks.

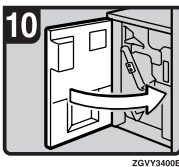

- Close the finisher front cover.

## Removing Punch Waste

### Note

- When “Hole punch receptacle is full.” is displayed, you cannot use the Punch function.

---

### Finisher 3000M (50-Sheet Staples), Booklet Finisher

---

- 1** Open the finisher front cover.

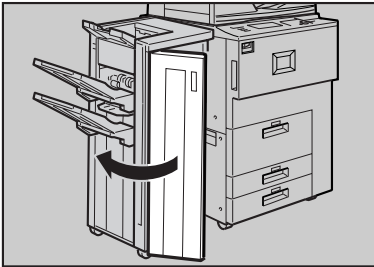

ZGVH400E

- 2** Pull out the punch waste box, and then remove punch waste.

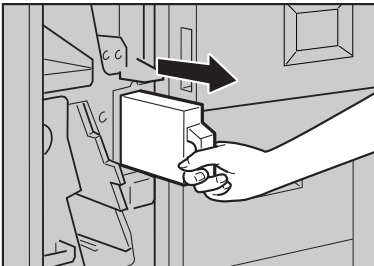

ZGVH410E

- 3** Reinstall the punch waste box.

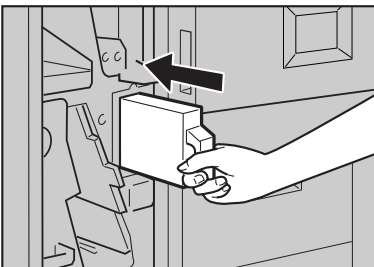

ZGVH420E



**Note**

- If you do not, "Hole punch receptacle is full." is still displayed.

**4** Close the front cover of the finisher.

"Hole punch receptacle is full." disappears.

**Note**

- If the message is still displayed, reinstall the punch waste box.

## Finisher 3000B (100-Sheet Staples)

**1** Open the finisher front cover.

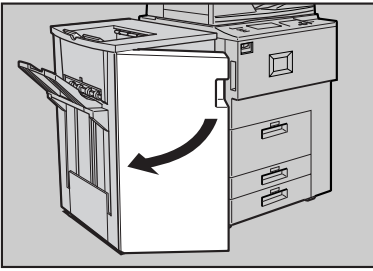

ZGVH600E

**2** Pull out the punch waste box, and then remove punch waste.

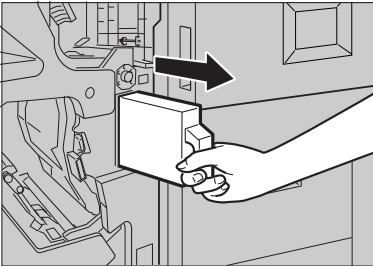

ZGVH610E

**3** Reinstall the punch waste box.

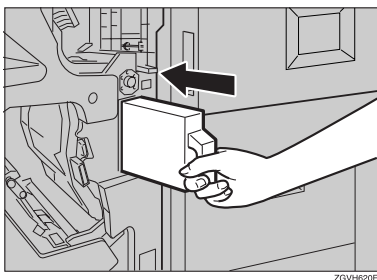

**Note**

- If you do not, "Hole punch receptacle is full." is still displayed.

**4** Close the front cover of the finisher.

"Hole punch receptacle is full." disappears.

**Note**

- If the message is still displayed, reinstall the punch waste box.

## Do's And Don'ts

### CAUTION:

- *Unplug the power cord from the wall outlet before you move the machine. While moving the machine, you should take care that the power cord will not be damaged under the machine.*
- Do not turn off the main power switch while the On indicator is lit or blinking. This may cause damage to the hard disk or memory.
- Do not touch areas on or around the fusing unit. These areas get hot.
- After making copies continuously, the exposure glass may become warm—this is not a malfunction.
- When you use this machine for a long time in a confined space without good ventilation, you may detect an odd smell. To keep the workplace comfortable, we recommend that you keep it well ventilated.
- The area around the ventilation hole may become warm. This is caused by exhaust air and is not a malfunction.
- Do not turn off the operation switch while copying or printing. Make sure all copying or printing has finished.
- The machine might fail to produce good copy images if condensation forms inside due to rapid temperature change.
- Do not open the covers of the machine while copying or printing. If you do, misfeeds might occur.
- Do not move the machine while copying or printing.
- If you operate the machine improperly or a failure occurs, settings might be lost. Be sure to make a note of your machine settings.
- The supplier shall not be liable for any loss or damage resulting from a failure of the machine, loss of settings, or use of the machine.

# Toner

---

## Handling Toner

---

 **WARNING:**

- *Do not incinerate used toner or toner containers. Toner dust might ignite when exposed to an open flame. Dispose of used toner containers in accordance with local regulations.*

 **CAUTION:**

- *Keep toner (used or unused) and toner containers out of reach of children.*

 **CAUTION:**

- *Our products are engineered to meet high standards of quality and functionality, and we recommend that you use only the expendable supplies available at an authorized dealer.*

 **Important**

- If you use toner other than the recommended type, an error might occur.

 **Reference**

If you want to add toner. ⇒ p.120 “ Adding Toner”

---

## Toner Storage

---

When storing toner, the following precautions should always be followed:

- Store toner containers in a cool, dry place free from direct sunlight.
- Store on a flat surface.

---

## Used Toner

---

 **Note**

- Toner cannot be re-used.

# Where to Put Your Machine

---

## Machine Environment

---

Your machine's location should be carefully chosen because environmental conditions greatly affect its performance.

---

### Optimum environmental conditions

---

**⚠ CAUTION:**

- *Keep the machine away from humidity and dust. Otherwise a fire or an electric shock might occur.*
- *Do not place the machine on an unstable or tilted surface. If it topples over, an injury might occur.*

**⚠ CAUTION:**

- *If you use the machine in a confined space, make sure there is a continuous air turnover.*
- Temperature: 10 – 32°C (50 – 89.6°F)(humidity to be 54% at 32°C, 89.6°F)
- Humidity: 15 – 80% (temperature to be 27°C, 80.6°F at 80%)
- A strong and level base.
- The machine must be level within 5 mm, 0.2" both front to rear and left to right.
- To avoid possible buildup of ozone, be sure to locate this machine in a large well ventilated room that has an air turnover of more than 30 m<sup>3</sup>/hr/person.

---

### Environments to avoid

---

- Locations exposed to direct sunlight or strong light (more than 1,500 lux).
- Locations directly exposed to cool air from an air conditioner or heated air from a heater. (Sudden temperature changes might cause condensation within the machine.)
- Locations close to machines generating ammonia such as a diazo copy machine.
- Places where the machine might be subjected to frequent strong vibration.
- Dusty areas.
- Areas with corrosive gases.

---

## Moving

---

**⚠ CAUTION:**

- *Unplug the power cord from the wall outlet before you move the machine. While moving the machine, you should take care that the power cord will not be damaged under the machine.*

**🔊 Important**

- When moving the machine, the following precautions should always be followed:
  - Turn off the main power. ⇒ p.33 “Turning Off the Main Power”
  - Unplug the power cord from the wall outlet. When you do, grip the plug to avoid damaging the cord and causing fire or electric shock.
  - Close all covers and trays including the front cover and bypass tray.

**💡 Limitation**

- Carefully move the machine. If you do not, the machine might be damaged or a stored file might be deleted.
- Avoid any strong shock to the machine. This could damage the hard disk and cause stored files to be deleted. For precautionary reasons, files should be copied to another local computer.

---

## Power Connection

---

**⚠ WARNING:**

- ***Connect the machine only to the power source described on the inside front cover of this manual. Connect the power cord directly into a wall outlet and do not use an extension cord.***
- ***Do not damage, break or make any modifications to the power cord. Do not place heavy objects on it. Do not pull it hard nor bend it more than necessary. These actions could cause an electric shock or fire.***

**⚠ CAUTION:**

- *Unplug the power cord from the wall outlet before you move the machine. While moving the machine, you should take care that the power cord will not be damaged under the machine.*

**⚠ CAUTION:**

- *When you disconnect the power plug from the wall outlet, always pull the plug (not the cable).*

- When the main power switch is in the Stand-by position, the optional anti-condensation heaters are on. In case of emergency, unplug the machine's power cord.
- When you unplug the power cord, the anti-condensation heaters turn off.
- Make sure that the plug is firmly inserted in the outlet.
- Voltage must not fluctuate more than 10%.
- The socket-outlet should be installed near the equipment and should be easily accessible.

## Access to the Machine

Place the machine near the power source, providing clearance as shown.

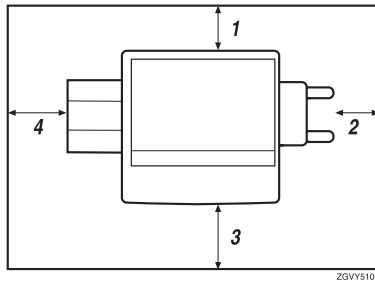

- |  |  |
|--|--|
| <b>1. Rear: more than 5 cm (2")</b>    | <b>3. Front: more than 70 cm (27.5")</b> |
| <b>2. Right: more than 4 cm (1.6")</b> | <b>4. Left: more than 5 cm (2")</b>      |

### Note

- For required space when options are installed, contact your service representative.

# Maintaining Your Machine

If the exposure glass or document feeder is dirty, you might not be able to make clear copies. Clean these parts when you find them dirty.

## ❖ Cleaning the machine

Wipe the machine with a soft, damp cloth. Then, wipe it with a dry cloth to remove the water.

## ⚠ Important

- ❑ Do not use chemical cleaner or organic solvents, such as thinner or benzene. If they get into the machine or melt plastic parts, a failure might occur.
- ❑ Do not clean parts other than those specified in this manual. Such parts should be cleaned by your service representative.

## Cleaning the Exposure Glass

### 1 Clean 1 and 2.



ZGUH451J

## Cleaning the Document Feeder

### 1 Clean the white sheet of the document feeder.

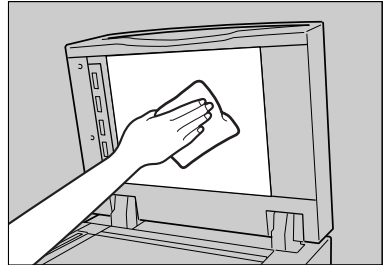

ZGUH441J

### 2 Pull the lever.

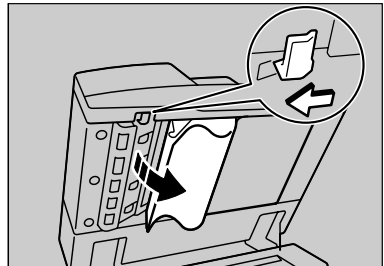

ZGUH700J

### 3 Wipe the scanning glass.

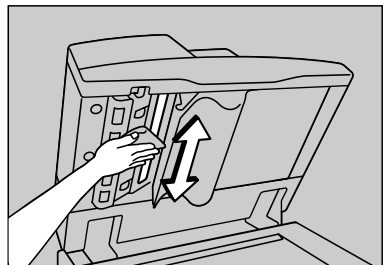

ZGUH710J



# Other Functions

## Inquiry

The inquiry functions lets you confirm the telephone numbers to contact for repairs or to order toner. Be sure to contact your service engineer to verify the following:

- ❖ **Machine Maintenance/Repair**
  - Telephone No.
  - Serial No. of the machine
- ❖ **Sales Representative**
  - Telephone No.

**1** Press the **[User Tools/Counter]** key.

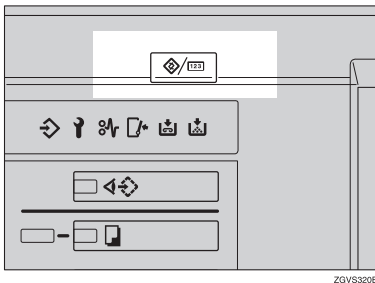

ZGV5320E

**2** Press the **[Inquiry]** key.

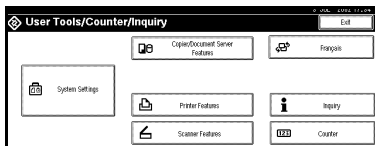

Inquiry information is displayed.

## Printing inquiry information

**1** Press the **[Print Inquiry List]** key.

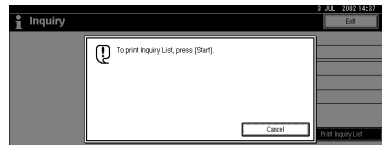

**2** Press the **[Start]** key.

Inquiry information is printed.

**3** Press the **[Exit]** key.

**4** Press the **[Exit]** key.

## Changing the Display Language

You can change the language used on the display. English is set as default setting.

**1** Press the **[User Tools/Counter]** key.

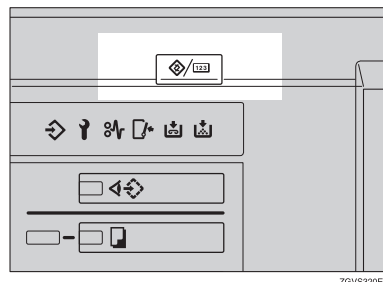

ZGV5320E

**2** Press the **[Français]** key.

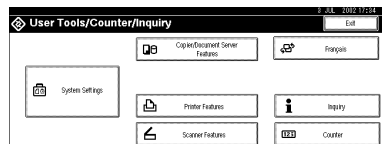

The display language is changed to French.

**3** Press the **[Exit]** key.

The menu appears in French.

**Note**

- If you want to return the display language to “English”, repeat step **1** and press the **[English]** key.

---

## Counter

---



---

### Displaying the Total Counter

---

You can display the total number of sheets used for all functions and the total number of sheets used for copying.

You can also print the counter list.

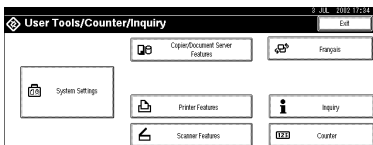
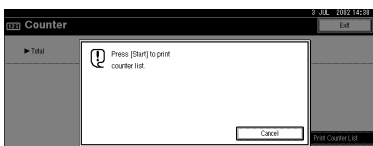
**1** Press the **[User Tools/Counter]** key.**2** Press the **[Counter]** key.**3** To print a counter list, press the **[Print Counter List]** key.**4** Press the **[Start]** key.

A counter list is printed.

# 8. Specification

## Mainframe

- ❖ **Configuration:**  
Console
- ❖ **Photosensitivity type:**  
OPC drum (Φ100)
- ❖ **Original scanning:**  
CCD-CIS
- ❖ **Copy process:**  
Dry electrostatic transfer system
- ❖ **Development:**  
Dry two-component magnetic brush development system
- ❖ **Fusing:**  
Heating roll pressure system
- ❖ **Resolution:**  
1200 dpi
- ❖ **Exposure glass:**  
Stationary original exposure type
- ❖ **Original reference position:**  
Rear left corner
- ❖ **Warm-up time:**  
Operation Switch: Less than 300 seconds (23°C, 73°F)  
Low Power Mode: Less than 25 seconds
- ❖ **Originals:**  
Sheet/book/objects
- ❖ **Maximum original size:**  
A3☐, 11" × 17"☐, Long length: 1260 mm
- ❖ **Minimum original size:**  
B6,  
5<sup>1</sup>/<sub>2</sub>" × 8<sup>1</sup>/<sub>2</sub>" (when using document feeder)

### ❖ Copy paper size:

- Trays: A3  $\square$  – A5  $\square$   $\square$ , 11"  $\times$  17"  $\square$  – 5<sup>1</sup>/<sub>2</sub>"  $\times$  8<sup>1</sup>/<sub>2</sub>"  $\square$   $\square$ , 8K(267  $\times$  390 mm)  $\square$ , 16K(195  $\times$  267 mm)  $\square$   $\square$
- Bypass: A3  $\square$  – A6  $\square$ , 11"  $\times$  17"  $\square$  – 5<sup>1</sup>/<sub>2</sub>"  $\times$  8<sup>1</sup>/<sub>2</sub>"  $\square$
- Bypass (non-standard size):  
Vertical: 100 – 305 mm, 4" – 12"  
Horizontal: 139.7 – 600 mm, 5.5" – 23.6"
- Duplex: A3  $\square$  – A5  $\square$   $\square$ , 11"  $\times$  17"  $\square$  – 5<sup>1</sup>/<sub>2</sub>"  $\times$  8<sup>1</sup>/<sub>2</sub>"  $\square$   $\square$

### ❖ Copy paper weight:

- Paper tray: 52.3 – 127.9 g/m<sup>2</sup>, 14 – 34 lb. Bond
- Bypass tray: 52.3 – 105 g/m<sup>2</sup>, 14 – 28 lb. Bond  
105 – 216 g/m<sup>2</sup>, 28 – 57.6 lb. Bond (Thick Paper)
- Duplex: 64 – 127.9 g/m<sup>2</sup>, 17 – 34 lb. Bond

### ❖ Non-reproduction area:

- Leading edge: Less than 4  $\pm$  2 mm
- Trailing edge: More than 1 mm
- Left edge: More than 2  $\pm$  1.5 mm
- Right edge: More than 0.5 mm

### ❖ First copy time:

- 3.5 seconds or less  
(face up feed, A4  $\square$ , 8<sup>1</sup>/<sub>2</sub>"  $\times$  11"  $\square$ , 100%, feeding from tray 1, on the exposure glass)
- 5.3 seconds or less  
(face down feed, A4  $\square$ , 8<sup>1</sup>/<sub>2</sub>"  $\times$  11"  $\square$ , 100%, feeding from tray 1, on the exposure glass)

### ❖ Copying speed: (Type 1)

- 34 copies/minute (A3  $\square$ , 11"  $\times$  17"  $\square$ )
- 60 copies/minute (A4  $\square$ , 8<sup>1</sup>/<sub>2</sub>"  $\times$  11"  $\square$ )

### ❖ Copying speed: (Type 2)

- 38 copies/minute (A3  $\square$ , 11"  $\times$  17"  $\square$ )
- 75 copies/minute (A4  $\square$ , 8<sup>1</sup>/<sub>2</sub>"  $\times$  11"  $\square$ )

### ❖ **Reproduction ratio:**

Preset reproduction ratios:

	<b>Metric version</b>	<b>Inch version</b>
Enlargement	400%	400%
	200%	200%
	141%	155%
	122%	129%
	115%	121%
Full Size	100%	100%
Reduction	93%	93%
	82%	85%
	75%	78%
	71%	73%
	65%	65%
	50%	50%
	25%	25%

Zoom: From 25 to 400% in 1% steps.

### ❖ **Maximum continuous copy run:**

999 sets

### ❖ **Copy paper capacity:**

- Tray 1 (Tandem tray) : 3,100 sheets (1,550 sheets × 2) (80 g/m<sup>2</sup>, 20 lb. Bond)
- Tray 2 (550-sheet tray) : 550 sheets (80 g/m<sup>2</sup>, 20 lb. Bond)
- Tray 3 (550-sheet tray) : 550 sheets (80 g/m<sup>2</sup>, 20 lb. Bond)
- Bypass tray: 100 sheets (69 g/m<sup>2</sup>, 18 lb. Bond)

### ❖ **Power consumption:**

- Mainframe only

	<b>Type 1</b>	<b>Type 2</b>
Warm-up	about 1.20 kw	about 1.20 kw
Stand-by	about 0.30 kw	about 0.30 kw
During printing	about 1.55 kw	about 1.55 kw
Maximum	less than 1.60 kw	less than 1.60 kw

- Complete system <sup>\*1</sup>

	Type 1	Type 2
Warm-up	about 1.25 kw	about 1.25 kw
Stand-by	about 0.32 kw	about 0.32 kw
During printing	about 1.65 kw	about 1.65 kw
Maximum	less than 1.70 kw	less than 1.70 kw

<sup>\*1</sup> The Complete System consists of the mainframe, finisher, large capacity tray (LCT) and mailbox.

❖ **Dimensions (W × D × H up to exposure glass):**

Type 1,2: 690 × 750 × 985(1165 <sup>\*1</sup>) mm, 27.2" × 29.6" × 38.8"(45.9" <sup>\*1</sup>)

<sup>\*1</sup> The height include the document feeder.

❖ **Space for mainframe (W × D):**

Type 1,2: 1,175 × 794 mm, 46.3" × 31.3"

❖ **Noise Emission <sup>\*1</sup>:**

Sound Power Level:

- Mainframe only

	Type 1	Type 2
Stand-by	Less than 48 dB (A)	Less than 48 dB (A)
Copying	Less than 70 dB (A)	Less than 71 dB (A)

- Complete system <sup>\*3</sup>

	Type 1	Type 2
Stand-by	Less than 49 dB (A)	Less than 49 dB (A)
Copying	Less than 74 dB (A)	Less than 74 dB (A)

Sound Pressure Level <sup>\*2</sup>:

- Mainframe only

	Type 1	Type 2
Stand-by	Less than 37 dB (A)	Less than 37 dB (A)
Copying	Less than 56 dB (A)	Less than 57 dB (A)

- Complete system <sup>\*3</sup>

	Type 1	Type 2
Stand-by	Less than 38 dB (A)	Less than 38 dB (A)
Copying	Less than 63 dB (A)	Less than 63 dB (A)

<sup>\*1</sup> The above measurements made in accordance with ISO 7779 are actual value.

<sup>\*2</sup> It is measured at the position of the bystander.

<sup>\*3</sup> The Complete System consists of the mainframe, finisher, large capacity tray (LCT) and mailbox.

❖ **Weight:**

Type 1, 2: Approx. 200 kg, 440.9 lb

---

## Document Server

---

❖ **HDD:**

40 GB

❖ **HDD (Document Server):**

23.45 GB

❖ **Capacity:**

- Copy: Approx. 2,000 (ITUT-No.4 chart)
- Batch mode: Approx. 2,000 (ITUT-No.4 chart)
- Printer: Approx. 10,000 (600 dpi)
- Scanner: Approx. 2,000 (200 dpi/Text) (ITUT-No.4 chart) \*<sup>1</sup>

❖ **Maximum number of stored documents:**

3,000 documents

❖ **Maximum pages of stored documents:**

10,000 pages

❖ **Maximum number of pages per document:**

2,000 pages

❖ **Capacity (Memory Sorting):**

4,5 GB (A4/8<sup>1</sup>/<sub>2</sub>" × 11" : Approx. 333 sheets-2000 sheets at maximum) \*<sup>2</sup>

❖ **Capacity (Others):**

6,62 GB

\*<sup>1</sup> Scanning Condition: ITUT-No. 4 chart/200 dpi/Text/A4/MMR

\*<sup>2</sup> The capacity will change when the multiple functions are used.

---

## Document Feeder







---

**❖ Mode:**







Batch (SADF) mode, Mixed Sizes mode, Paper Orientation mode

**❖ Original size:**

Metric version:

- A3  – B6   (1-sided originals)
- A3  – A5   (2-sided originals)

Inch version:

- 11" × 17"  – 5<sup>1</sup>/<sub>2</sub>" × 8<sup>1</sup>/<sub>2</sub>"   (1-sided originals)
- 11" × 17"  – 5<sup>1</sup>/<sub>2</sub>" × 8<sup>1</sup>/<sub>2</sub>"   (2-sided originals)

**❖ Original weight:**

- 1-sided originals: 40 – 128 g/m<sup>2</sup> (11 – 34 lb. Bond)
- 2-sided originals: 52 – 128 g/m<sup>2</sup> (14 – 34 lb. Bond) (Duplex)

**❖ Number of originals to be set:**

100 sheets (81.4 g/m<sup>2</sup>, 22 lb. Bond) or less than 12 mm, 0.4"

**❖ Maximum power consumption:**

Less than 110 W (power is supplied from the mainframe)

**❖ Dimensions (W×D×H)**

680 × 560 × 180 mm, 26.8" × 22" × 7.1"

**❖ Weight:**

Approx. 18 kg, 39.7 lb.

** Note**

 Specifications are subject to change without notice.



# Mailbox (option)

## ❖ Number of trays:

9 trays

## ❖ Paper size:

A3, B4, A4, B5, A5 \*<sup>1</sup>, 11" × 17", 8<sup>1</sup>/<sub>2</sub>" × 14", 8<sup>1</sup>/<sub>2</sub>" × 11", 5<sup>1</sup>/<sub>2</sub>" × 8<sup>1</sup>/<sub>2</sub>" \*<sup>1</sup>

## ❖ Paper capacity:

100 sheets (80 g/m<sup>2</sup>, 20 lb. Bond)

## ❖ Paper weight:

60 – 128 g/m<sup>2</sup>, 16 – 34 lb. Bond

## ❖ Power consumption:

Approx. 48 W (power is supplied from the mainframe)

## ❖ Dimensions (W × D × H):

540 × 600 × 660 mm, 21.3" × 23.6" × 26"

## ❖ Weight:

Approx. 15 kg, 33 lb.

\*<sup>1</sup> These sizes cannot be detected automatically.

## Note

☐ Specifications are subject to change without notice.

# Booklet Finisher (option)

## Finisher Upper Tray:

### ❖ Paper size:

A3, B4, A4, B5, A5, B6, A6, 11" × 17", 8<sup>1</sup>/<sub>2</sub>" × 14", 8<sup>1</sup>/<sub>2</sub>" × 11", 5<sup>1</sup>/<sub>2</sub>" × 8<sup>1</sup>/<sub>2</sub>", 12" × 18"

### ❖ Paper weight:

52 – 163 g/m<sup>2</sup>, 14 – 43 lb. Bond

### ❖ Stack capacity:

- 250 sheets (A4, B5, A5, B6, 8<sup>1</sup>/<sub>2</sub>" × 11", 5<sup>1</sup>/<sub>2</sub>" × 8<sup>1</sup>/<sub>2</sub>) (80 g/m<sup>2</sup>, 20 lb. Bond)
- 50 sheets (A3, B4, 11" × 17", 8<sup>1</sup>/<sub>2</sub>" × 14", 12" × 18") (80 g/m<sup>2</sup>, 20 lb. Bond)

## Finisher Shift Tray 1:

### ❖ Paper size:

A3, B4, A4, B5, A5, B6, A6, 11" × 17", 8<sup>1</sup>/<sub>2</sub>" × 14", 8<sup>1</sup>/<sub>2</sub>" × 11", 5<sup>1</sup>/<sub>2</sub>" × 8<sup>1</sup>/<sub>2</sub>", 12" × 18"

### ❖ Paper weight:

52 – 216 g/m<sup>2</sup>, 14 – 58 lb. Bond

### ❖ Stack capacity:

- 500 sheets (A4, B5, A5, 8<sup>1</sup>/<sub>2</sub>" × 11") (80 g/m<sup>2</sup>, 20 lb. Bond)
- 250 sheets (A3, B4, 11" × 17", 8<sup>1</sup>/<sub>2</sub>" × 14", 12" × 18") (80 g/m<sup>2</sup>, 20 lb. Bond)
- 100 sheets (A5, B6, 5<sup>1</sup>/<sub>2</sub>" × 8<sup>1</sup>/<sub>2</sub>") (80 g/m<sup>2</sup>, 20 lb. Bond)

### ❖ Staple paper size:

A3, B4, A4, B5, 11" × 17", 8<sup>1</sup>/<sub>2</sub>" × 14", 8<sup>1</sup>/<sub>2</sub>" × 11"

### ❖ Staple paper weight:

64 – 90 g/m<sup>2</sup>, 17 – 28 lb. Bond

### ❖ Staple capacity:

Without Mixed Size mode:





- 50 sheets (A4, B5, 8<sup>1</sup>/<sub>2</sub>" × 11") (80 g/m<sup>2</sup>, 20 lb. Bond)
- 30 sheets (A3, B4, 11" × 17", 8<sup>1</sup>/<sub>2</sub>" × 14") (80 g/m<sup>2</sup>, 20 lb. Bond)

With Mixed Size mode:







- 30 sheets (A4 / A3, B5 / B4, 8<sup>1</sup>/<sub>2</sub>" × 11" / 11" × 17") (80 g/m<sup>2</sup>, 20 lb. Bond)

### ❖ Stack capacity after stapling

Without Mixed Size mode:

- 50–10 sets (10–50 sheets) (A4 , 8<sup>1</sup>/<sub>2</sub>" × 11" ) (80 g/m<sup>2</sup>, 20 lb. Bond)
- 50 sets (2–9 sheets) (A4 , 8<sup>1</sup>/<sub>2</sub>" × 11" ) (80 g/m<sup>2</sup>, 20 lb. Bond)
- 25–16 sets (10–30 sheets) (other paper size) (80 g/m<sup>2</sup>, 20 lb. Bond)
- 25 sets (2–9 sheets) (other paper size) (80 g/m<sup>2</sup>, 20 lb. Bond)

With Mixed Size mode:

















- 16 sets (2–30 sheets) (A4  / A3 , B5  / B4 , 8<sup>1</sup>/<sub>2</sub>" × 11"  / 11" × 17" ) (80 g/m<sup>2</sup>, 20 lb. Bond)

### ❖ Staple position:

4 position (Top, Top Slant, Bottom, 2 Staples)

Finisher Shift Tray 2:

















### ❖ Paper size:

A3 , B4 , A4  , B5  , A5  , B6 , A6 , 11" × 17" , 8<sup>1</sup>/<sub>2</sub>" × 14" , 8<sup>1</sup>/<sub>2</sub>" × 11"  , 5<sup>1</sup>/<sub>2</sub>" × 8<sup>1</sup>/<sub>2</sub>"  , 12" × 18" 











### ❖ Paper weight:

52 – 216 g/m<sup>2</sup>, 14 – 58 lb. Bond

### ❖ Stack capacity:

- 2,500 sheets (A4 , 8<sup>1</sup>/<sub>2</sub>" × 11" ) (80 g/m<sup>2</sup>, 20 lb. Bond)
- 1,250 sheets (A3 , B4 , A4 , B5  , 11" × 17" , 8<sup>1</sup>/<sub>2</sub>" × 14" , 8<sup>1</sup>/<sub>2</sub>" × 11"  , 12" × 18" ) (80 g/m<sup>2</sup>, 20 lb. Bond)
- 500 sheets (A5 ) (80 g/m<sup>2</sup>, 20 lb. Bond)
- 100 sheets (A5 , B6  or 5<sup>1</sup>/<sub>2</sub>" × 8<sup>1</sup>/<sub>2</sub>" ) (80 g/m<sup>2</sup>, 20 lb. Bond)

### ❖ Staple paper size:









A3 , B4 , A4  , B5  , 11" × 17" , 8<sup>1</sup>/<sub>2</sub>" × 14" , 8<sup>1</sup>/<sub>2</sub>" × 11"  

### ❖ Staple paper weight:







64 – 90 g/m<sup>2</sup>, 17 – 28 lb. Bond

### ❖ Staple capacity:

Without Mixed Size mode:











- 50 sheets (A4 , B5  , 8<sup>1</sup>/<sub>2</sub>" × 11"  ) (80 g/m<sup>2</sup>, 20 lb. Bond)
- 30 sheets (A3 , B4 , 11" × 17" , 8<sup>1</sup>/<sub>2</sub>" × 14" ) (80 g/m<sup>2</sup>, 20 lb. Bond)

With Mixed Size mode:







- 30 sheets (A4  / A3 , B5  / B4 , 8<sup>1</sup>/<sub>2</sub>" × 11"  / 11" × 17" ) (80 g/m<sup>2</sup>, 20 lb. Bond)

### ❖ Stack capacity after stapling

Without Mixed Size mode:

- 250–50 sets (10–50 sheets) (A4 , 8<sup>1</sup>/<sub>2</sub>" × 11" ) (80 g/m<sup>2</sup>, 20 lb. Bond)
- 250 sets (2–9 sheets) (A4 , 8<sup>1</sup>/<sub>2</sub>" × 11" ) (80 g/m<sup>2</sup>, 20 lb. Bond)
- 125–25 sets (10–50 sheets) (A4 , B5 , 8<sup>1</sup>/<sub>2</sub>" × 11" ) (80 g/m<sup>2</sup>, 20 lb. Bond)
- 125 sets (2–9 sheets) (A4 , B5 , 8<sup>1</sup>/<sub>2</sub>" × 11" ) (80 g/m<sup>2</sup>, 20 lb. Bond)
- 125–40 sets (10–30 sheets) (other paper size) (80 g/m<sup>2</sup>, 20 lb. Bond)
- 125 sets (2–9 sheets) (other paper size) (80 g/m<sup>2</sup>, 20 lb. Bond)





With Mixed Size mode:

- 50 sets (2–30 sheets) (A4 , A3 , B5 , B4 , 8<sup>1</sup>/<sub>2</sub>" × 11" , 11" × 17" ) (80 g/m<sup>2</sup>, 20 lb. Bond)

### ❖ Staple position:

4 position (Top, Top Slant, Bottom, 2 Staples)

### ❖ Saddle stitch paper size:

A3 , B4 , A4 , 11" × 17" , 8<sup>1</sup>/<sub>2</sub>" × 11" 







### ❖ Saddle stitch paper weight:

64 – 90 g/m<sup>2</sup>, 17 – 28 lb. Bond

### ❖ Saddle stitch capacity:

1 set (15 sheets)

### ❖ Stack capacity after Saddle stitching

- 25 sets (2–5 sheets) (A4 , 8<sup>1</sup>/<sub>2</sub>" × 11" ) (80 g/m<sup>2</sup>, 20 lb. Bond)
- 15 sets (6–10 sheets) (A4 , 8<sup>1</sup>/<sub>2</sub>" × 11" ) (80 g/m<sup>2</sup>, 20 lb. Bond)
- 10 sets (11–15 sheets) (A4 , 8<sup>1</sup>/<sub>2</sub>" × 11" ) (80 g/m<sup>2</sup>, 20 lb. Bond)
- 30 sets (2–5 sheets) (other paper size) (80 g/m<sup>2</sup>, 20 lb. Bond)
- 20 sets (6–10 sheets) (other paper size) (80 g/m<sup>2</sup>, 20 lb. Bond)
- 10 sets (11–15 sheets) (other paper size) (80 g/m<sup>2</sup>, 20 lb. Bond)

### ❖ Saddle stitch position:

Center 2 position

### ❖ Power consumption:

Approx. 72 W (power is supplied from the mainframe)

### ❖ Dimensions (W × D × H):

700 × 620 × 960 mm, 27.6" × 24.5" × 37.8"

### ❖ Weight:

Approx. 62 kg, 136.7 lb.

### Note

- ❑ Specifications are subject to change without notice.

# Finisher 3000M (50-Sheet Staples) (option)

## Finisher Upper Tray:

### ❖ Paper size:

A3, B4, A4, B5, A5, B6, A6, 11" × 17", 8 1/2" × 14", 8 1/2" × 11", 5 1/2" × 8 1/2", 12" × 18"

### ❖ Paper weight:

52 – 163 g/m<sup>2</sup>, 14 – 43 lb. Bond

### ❖ Stack capacity:

- 250 sheets (A4, B5, A5, B6, 8 1/2" × 11", 5 1/2" × 8 1/2") (80 g/m<sup>2</sup>, 20 lb. Bond)
- 50 sheets (A3, B4, 11" × 17", 8 1/2" × 14", 12" × 18") (80 g/m<sup>2</sup>, 20 lb. Bond)

## Finisher Shift Tray:

### ❖ Paper size:

A3, B4, A4, B5, A5, B6, A6, 11" × 17", 8 1/2" × 14", 8 1/2" × 11", 5 1/2" × 8 1/2", 12" × 18"

### ❖ Paper weight:

52 – 216 g/m<sup>2</sup>, 14 – 58 lb. Bond

### ❖ Stack capacity:

- 3,000 sheets (A4, 8 1/2" × 11") (80 g/m<sup>2</sup>, 20 lb. Bond)
- 1,500 sheets (A3, B4, A4, B5, 11" × 17", 8 1/2" × 14", 8 1/2" × 11", 12" × 18") (80 g/m<sup>2</sup>, 20 lb. Bond)
- 500 sheets (A5) (80 g/m<sup>2</sup>, 20 lb. Bond)
- 100 sheets (A5, B6, 5 1/2" × 8 1/2") (80 g/m<sup>2</sup>, 20 lb. Bond)

### ❖ Staple paper size:

A3, B4, A4, B5, 11" × 17", 8 1/2" × 14", 8 1/2" × 11"

### ❖ Staple paper weight:

64 – 90 g/m<sup>2</sup>, 17 – 28 lb. Bond

### ❖ Staple capacity:

Without Mixed Size mode:











- 50 sheets (A4, B5, 8 1/2" × 11") (80 g/m<sup>2</sup>, 20 lb. Bond)
- 30 sheets (A3, B4, 11" × 17", 8 1/2" × 14") (80 g/m<sup>2</sup>, 20 lb. Bond)

With Mixed Size mode:







- 30 sheets (A4 / A3, B5 / B4, 8 1/2" × 11" / 11" × 17") (80 g/m<sup>2</sup>, 20 lb. Bond)

### ❖ Stack capacity after stapling

Without Mixed Size mode:

- 300–60 sets (10–50 sheets) (A4 , 8 1/2" × 11" ) (80 g/m<sup>2</sup>, 20 lb. Bond)
- 300 sets (2–9 sheets) (A4 , 8 1/2" × 11" ) (80 g/m<sup>2</sup>, 20 lb. Bond)
- 150–30 sets (10–50 sheets) (A4 , B5 , 8 1/2" × 11" ) (80 g/m<sup>2</sup>, 20 lb. Bond)
- 150 sets (2–9 sheets) (A4 , B5 , 8 1/2" × 11" ) (80 g/m<sup>2</sup>, 20 lb. Bond)
- 150–50 sets (10–30 sheets) (other size paper) (80 g/m<sup>2</sup>, 20 lb. Bond)
- 150 sets (2–9 sheets) (other size paper) (80 g/m<sup>2</sup>, 20 lb. Bond)

With Mixed Size mode:

- 50 sets (2–30 sheets) (A4 , A3 , B5 , B4 , 8 1/2" × 11" , 11" × 17" ) (80 g/m<sup>2</sup>, 20 lb. Bond)

### ❖ Staple position:

4 position (Top, Top Slant, Bottom, 2 Staples)

### ❖ Power consumption:

Approx. 72 W (power is supplied from the mainframe)

### ❖ Dimensions (W × D × H):

700 × 620 × 960 mm, 27.6" × 24.5" × 37.8"

### ❖ Weight:

Approx. 51 kg, 112.4 lb.

### Note

- Specifications are subject to change without notice.

# Finisher 3000B (100-Sheet Staples) (option)

## Finisher Upper Tray:

### ❖ Paper size:

A3, B4, A4, B5, A5, B6, A6, 11" × 17", 8<sup>1</sup>/<sub>2</sub>" × 14", 8<sup>1</sup>/<sub>2</sub>" × 11", 5<sup>1</sup>/<sub>2</sub>" × 8<sup>1</sup>/<sub>2</sub>", 12" × 18"

### ❖ Paper weight:

52 – 216 g/m<sup>2</sup>, 14 – 58 lb. Bond

### ❖ Stack capacity:

- 500 sheets (A4, B5, A5, B6, A6, 8<sup>1</sup>/<sub>2</sub>" × 11", 5<sup>1</sup>/<sub>2</sub>" × 8<sup>1</sup>/<sub>2</sub>) (80 g/m<sup>2</sup>, 20 lb. Bond)
- 250 sheets (A3, B4, 11" × 17", 8<sup>1</sup>/<sub>2</sub>" × 14", 12" × 18") (80 g/m<sup>2</sup>, 20 lb. Bond)

## Finisher Shift Tray:

### ❖ Paper size:

A3, B4, A4, B5, A5, 11" × 17", 8<sup>1</sup>/<sub>2</sub>" × 14", 8<sup>1</sup>/<sub>2</sub>" × 11", 5<sup>1</sup>/<sub>2</sub>" × 8<sup>1</sup>/<sub>2</sub>", 12" × 18"

### ❖ Paper weight:

52 – 216 g/m<sup>2</sup>, 14 – 58 lb. Bond

### ❖ Stack capacity:

- 3,000 sheets (A4, B5, 8<sup>1</sup>/<sub>2</sub>" × 11") (80 g/m<sup>2</sup>, 20 lb. Bond)
- 1,500 sheets (A3, B4, A4, B5, 11" × 17", 8<sup>1</sup>/<sub>2</sub>" × 14", 8<sup>1</sup>/<sub>2</sub>" × 11", 12" × 18") (80 g/m<sup>2</sup>, 20 lb. Bond)
- 500 sheets (A5, 5<sup>1</sup>/<sub>2</sub>" × 8<sup>1</sup>/<sub>2</sub>) (80 g/m<sup>2</sup>, 20 lb. Bond)
- 100 sheets (A5, 5<sup>1</sup>/<sub>2</sub>" × 8<sup>1</sup>/<sub>2</sub>) (80 g/m<sup>2</sup>, 20 lb. Bond)

### ❖ Staple paper size:

A3, B4, A4, B5, 11" × 17", 8<sup>1</sup>/<sub>2</sub>" × 14", 8<sup>1</sup>/<sub>2</sub>" × 11"















### ❖ Staple paper weight:

64 – 80 g/m<sup>2</sup>, 17 – 20 lb. Bond

### ❖ Staple capacity:

- 100 sheets (A4, B5, 8<sup>1</sup>/<sub>2</sub>" × 11") (80 g/m<sup>2</sup>, 20 lb. Bond)
- 50 sheets (A3, B4, 11" × 17", 8<sup>1</sup>/<sub>2</sub>" × 14") (80 g/m<sup>2</sup>, 20 lb. Bond)

❖ **Stack capacity after stapling**

- 200–30 sets (10–100 sheets) (A4 , B5 , 8 1/2" × 11" ) (80 g/m<sup>2</sup>, 20 lb. Bond)
- 150 sets (2–9 sheets) (A4 , B5 , 8 1/2" × 11" ) (80 g/m<sup>2</sup>, 20 lb. Bond)
- 150–30 sets (10–50 sheets) (A3 , B4 , 11" × 17" , 8 1/2" × 14" ) (80 g/m<sup>2</sup>, 20 lb. Bond)
- 150 sets (2–9 sheets) (A3 , B4 , 11" × 17" , 8 1/2" × 14" ) (80 g/m<sup>2</sup>, 20 lb. Bond)

❖ **Staple position:**

4 position (Top, Top Slant, Bottom, 2 Staples)

❖ **Power consumption:**

Approx. 100 W (power is supplied from the mainframe)

❖ **Dimensions (W × D × H):**

800 × 730 × 980 mm, 31.5" × 28.7" × 38.6"

❖ **Weight:**

Approx. 65 kg, 143.3 lb.

 **Note**

- Specifications are subject to change without notice.



# Copy Tray (option)

## ❖ Paper capacity:

- A3, 11" × 17" : 250 sheets
- B4, 8<sup>1</sup>/<sub>2</sub>" × 14" : 500 sheets
- A4, 8<sup>1</sup>/<sub>2</sub>" × 11" : 500 sheets
- B5, 5<sup>1</sup>/<sub>2</sub>" × 8<sup>1</sup>/<sub>2</sub>" : 250 sheets

## ❖ Dimensions (W × D × H):

390 × 330 × 130 mm, 15.4" × 13" × 5.1"

## ❖ Weight:

Approx. 650 g, 1.4 lb

## Note

- Specifications are subject to change without notice.

## Large Capacity Tray (LCT) (option)

❖ **Paper size:**

A4☐, B5☐, 8<sup>1</sup>/<sub>2</sub>" × 11"☐

❖ **Paper weight:**

52 – 128 g/m<sup>2</sup>, 14 – 34 lb. Bond

❖ **Paper capacity:**

4,000 sheets (80 g/m<sup>2</sup>, 20 lb. Bond)

❖ **Power consumption**

Maximum. 50 W (power is supplied from the mainframe)

❖ **Dimensions (W × D × H, option unit):**

314 × 458 × 659 mm, 12.4" × 18" × 25.9"

❖ **Weight:**

Approx. 20 kg, 44 lb.

 **Note**

☐ Specifications are subject to change without notice.

## Interposer (option)

❖ **Paper size:**

A3, B4, A4, B5, A5, 11" × 17", 8<sup>1</sup>/<sub>2</sub>" × 14", 8<sup>1</sup>/<sub>2</sub>" × 11", 5<sup>1</sup>/<sub>2</sub>" × 8<sup>1</sup>/<sub>2</sub>"

❖ **Paper weight:**

64 – 216 g/m<sup>2</sup>, 20 – 58 lb. Bond

❖ **Paper Capacity:**

200 sheets (80 g/m<sup>2</sup>, 20 lb. Bond)

❖ **Power consumption (Max):**

Approx. 48 W (power is supplied from the mainframe)

❖ **Dimensions (W × D × H):**

500 × 620 × 200 mm, 19.7" × 24.4" × 7.9"

❖ **Weight:**

Approx. 12 kg, 26.5 lb.











 **Note**

- ☐ Specifications are subject to change without notice.

# Punch Unit (option)

Booklet Finisher, Finisher 3000M (50-Sheet Staples)

## ❖ Paper size:

Punch unit type			
2 & 4 holes type	2 holes		A3-A5, 11" × 17"-5 <sup>1</sup> / <sub>2</sub> " × 8 <sup>1</sup> / <sub>2</sub> "
			A4-A5, 8 <sup>1</sup> / <sub>2</sub> " × 11", 5 <sup>1</sup> / <sub>2</sub> " × 8 <sup>1</sup> / <sub>2</sub> "
	4 holes		A3, B4, 11" × 17"
			A4, B5, 8 <sup>1</sup> / <sub>2</sub> " × 11"
4 holes type	4 holes		A3-A5, 11" × 17"-5 <sup>1</sup> / <sub>2</sub> " × 8 <sup>1</sup> / <sub>2</sub> "
			A4-A5, 8 <sup>1</sup> / <sub>2</sub> " × 11", 5 <sup>1</sup> / <sub>2</sub> " × 8 <sup>1</sup> / <sub>2</sub> "
2 & 3 holes type	2 holes		A3-A5, 11" × 17"-5 <sup>1</sup> / <sub>2</sub> " × 8 <sup>1</sup> / <sub>2</sub> "
			A4-A5, 8 <sup>1</sup> / <sub>2</sub> " × 11", 5 <sup>1</sup> / <sub>2</sub> " × 8 <sup>1</sup> / <sub>2</sub> "
	3 holes		A3, B4, 11" × 17"
			A4, B5, 8 <sup>1</sup> / <sub>2</sub> " × 11"

## ❖ Paper weight:

52 – 163 g/m<sup>2</sup>, 14 lb. – 43 lb. Bond

## ❖ Power consumption:

26.4 W (power is supplied from the mainframe.)

## ❖ Dimensions (W × D × H):











142 × 456 × 92 mm, 55.9" × 179.5" × 36.2"

## ❖ Weight:

Approx. 2.9 kg, 6.4 lb

Finisher 3000B (100-Sheet Staples)

### ❖ Paper size:

Punch unit type			
2 & 4 holes type	2 holes		A3-A5, 11" × 17"-5 <sup>1</sup> / <sub>2</sub> " × 8 <sup>1</sup> / <sub>2</sub> "
			A4-A5, 8 <sup>1</sup> / <sub>2</sub> " × 11", 5 <sup>1</sup> / <sub>2</sub> " × 8 <sup>1</sup> / <sub>2</sub> "
	4 holes		A3, 11" × 17"
			A4, 8 <sup>1</sup> / <sub>2</sub> " × 11"
4 holes type	4 holes		A3-B5, 11" × 17"-8 <sup>1</sup> / <sub>2</sub> " × 11"
			A4-A5, 8 <sup>1</sup> / <sub>2</sub> " × 11", 5 <sup>1</sup> / <sub>2</sub> " × 8 <sup>1</sup> / <sub>2</sub> "
2 & 3 holes type	2 holes		A3-A5, 11" × 17"-5 <sup>1</sup> / <sub>2</sub> " × 8 <sup>1</sup> / <sub>2</sub> "
			A4-A5, 8 <sup>1</sup> / <sub>2</sub> " × 11", 5 <sup>1</sup> / <sub>2</sub> " × 8 <sup>1</sup> / <sub>2</sub> "
	3 holes		A3, B4, 11" × 17"
			A4, B5, 8 <sup>1</sup> / <sub>2</sub> " × 11"

### ❖ Paper weight:

- 4 holes: 52 – 128 g/m<sup>2</sup>, 14 lb. – 34 lb. Bond
- 2 & 3 holes: 52 – 163 g/m<sup>2</sup>, 14 lb. – 43 lb. Bond

### ❖ Power consumption:

60 W (power is supplied from the mainframe.)

### ❖ Dimensions (W × D × H):

- 4 holes: 92 × 463 × 100 mm, 3.6" × 18.2" × 3.9"
- 2 & 3 holes, 2 & 4 holes: 105 × 463 × 100 mm, 4.1" × 18.2" × 3.9"

### ❖ Weight:

- 4 holes: Approx. 2.4 kg, 5.3 lb
- 2 & 3 holes, 2 & 4 holes: Approx. 2.6 kg, 5.7 lb

### Note

- Specifications are subject to change without notice.

## Others

❖ **A3/11" × 17" Tray Unit (option)**

You can load A3 or 11" × 17" paper in the tray 1 using this unit.

❖ **B4/8<sup>1</sup>/<sub>2</sub>" × 14" Tray Unit (option)**

You can load B4/A4 or 8<sup>1</sup>/<sub>2</sub>" × 14" paper in the large capacity tray (LCT) using this unit.

❖ **Tab Sheet Holder (option)**

You can use tab sheets with this holder.

❖ **Output Jogger (option)**

You can tidy the printout with Finisher 3000B (100–Sheet Staples).

# Copy Paper

## Recommended Paper Sizes and Types

The following limitations apply to each tray:

Tray Type	Paper Type and Weight	Metric Version	Inch Version	Paper Capacity <sup>*9</sup>
Tray 1 <sup>*1</sup>	52.3-127.9 g/m <sup>2</sup> (14-34 lb. Bond)	A4 □, 8 <sup>1</sup> / <sub>2</sub> " × 11" □		1,550 sheets × 2
Tray 1 <sup>*1</sup> (A3/11" × 17" Tray Unit (option))		A3□, B4□, A4 □ □, 11"×17"□, 8 <sup>1</sup> / <sub>2</sub> " × 14"□, 8 <sup>1</sup> / <sub>2</sub> " × 11" □ □		1,000 sheets
Tray 2, 3	52.3-127.9 g/m <sup>2</sup> (14-34 lb. Bond)	<sup>*3</sup> A3□, A4 □ □, A5 □ □, 8 <sup>1</sup> / <sub>2</sub> " × 13"□, 8 <sup>1</sup> / <sub>4</sub> " × 13"□	<sup>*3</sup> 11" × 17"□, 8 <sup>1</sup> / <sub>2</sub> " × 14"□, 8 <sup>1</sup> / <sub>2</sub> " × 11" □ □, 8 <sup>1</sup> / <sub>2</sub> " × 5 <sup>1</sup> / <sub>2</sub> " □ □, 8" × 13"□, 7 <sup>1</sup> / <sub>4</sub> " × 10 <sup>1</sup> / <sub>2</sub> "□, 8" × 10 <sup>1</sup> / <sub>2</sub> "□	550 sheets
		<sup>*4</sup> B4□, B5 □ □, 11" × 17"□, 8 <sup>1</sup> / <sub>2</sub> " × 14"□, 8 <sup>1</sup> / <sub>2</sub> " × 11" □ □, 5 <sup>1</sup> / <sub>2</sub> " × 8 <sup>1</sup> / <sub>2</sub> " □ □, 8" × 13"□, 7 <sup>1</sup> / <sub>4</sub> " × 10 <sup>1</sup> / <sub>2</sub> "□, 11" × 15"□, 10" × 15"□, 8 <sup>1</sup> / <sub>4</sub> " × 14"□, 8" × 10 <sup>1</sup> / <sub>2</sub> , 210 × 340 mm□, 210 × 182 mm □, 210 × 170 mm □, 8K(267 × 390 mm)□, 16K(195 × 267 mm) □ □	<sup>*4</sup> A3□, B4□, A4 □ □, B5 □ □, A5 □ □, 8 <sup>1</sup> / <sub>2</sub> " × 13"□, 8 <sup>1</sup> / <sub>4</sub> " × 13"□, 11" × 15"□, 10" × 15"□, 8 <sup>1</sup> / <sub>4</sub> " × 14"□, 210 × 340 mm□, 210 × 182 mm □, 210 × 170 mm □, 8K(267 × 390 mm)□, 16K(195 × 267 mm) □ □	
		Custom size Vertical: 139.7-297 mm Horizontal: 139.7-431.8 mm	Custom size Vertical: 5.5"-11.7" Horizontal: 5.5"-17.0"	
	Tab sheets 163 g/m <sup>2</sup> , 199 g/m <sup>2</sup> (90 lb. Index, 110 lb. Index) <sup>*2</sup>	A4 □, 8 <sup>1</sup> / <sub>2</sub> " × 11" □, 8 <sup>1</sup> / <sub>2</sub> " × 14"□ (90 lb. Index only)		500 sheets

Tray Type	Paper Type and Weight	Metric Version	Inch Version	Paper Capacity <sup>*9</sup>
Bypass Tray	52.3-216 g/m <sup>2</sup> (14-57.6 lb. Bond)	<sup>*3</sup> A3☐, A4☐, A5☐	<sup>*3</sup> A3☐, 11" × 17"☐, 8 <sup>1</sup> / <sub>2</sub> " × 14"☐, 5 <sup>1</sup> / <sub>2</sub> " × 8 <sup>1</sup> / <sub>2</sub> "☐,	100 sheets (52.3-105 g/m <sup>2</sup> (14-28 lb. Bond))
		<sup>*5</sup> B4☐, A4☐, B5☐☐, A5☐, B6☐, A6☐, 11" × 17"☐, 8 <sup>1</sup> / <sub>2</sub> " × 14"☐, 8 <sup>1</sup> / <sub>2</sub> " × 11"☐☐, 5 <sup>1</sup> / <sub>2</sub> " × 8 <sup>1</sup> / <sub>2</sub> "☐☐, 8 <sup>1</sup> / <sub>2</sub> " × 13"☐, 8 <sup>1</sup> / <sub>4</sub> " × 13"☐, 8" × 13"☐, 7 <sup>1</sup> / <sub>4</sub> " × 10 <sup>1</sup> / <sub>2</sub> "☐☐, 11" × 15"☐, 11" × 14"☐, 10" × 15"☐, 15"☐, 10" × 14"☐, 8 <sup>1</sup> / <sub>4</sub> " × 14"☐, 8" × 10 <sup>1</sup> / <sub>2</sub> "☐☐, 8" × 10"☐☐	<sup>*5</sup> B4☐, A4☐☐, B5☐☐, A5☐☐, B6☐, A6☐, 8 <sup>1</sup> / <sub>2</sub> " × 11"☐☐, 5 <sup>1</sup> / <sub>2</sub> " × 8 <sup>1</sup> / <sub>2</sub> "☐, 8 <sup>1</sup> / <sub>2</sub> " × 13"☐, 8 <sup>1</sup> / <sub>4</sub> " × 13"☐, 8" × 13"☐, 7 <sup>1</sup> / <sub>4</sub> " × 10 <sup>1</sup> / <sub>2</sub> "☐☐, 11" × 15"☐, 11" × 14"☐, 10" × 15"☐, 10" × 14"☐, 8 <sup>1</sup> / <sub>4</sub> " × 14"☐, 8" × 10 <sup>1</sup> / <sub>2</sub> "☐☐, 8" × 10"☐☐	30 sheets (105-157 g/m <sup>2</sup> (28-41.7 lb. Bond))
		<sup>*6</sup> Custom size Vertical: 100-305 mm Horizontal: 139.7-600 mm	<sup>*6</sup> Custom size Vertical: 4"-12" Horizontal: 5.5"-23.6"	20 sheets (157-216 g/m <sup>2</sup> (41.7-57.6 lb. Bond))
		Translucent paper <sup>*11</sup>	A3☐, B4☐, A4☐, B5☐, A4☐ <sup>*5</sup> , B5☐ <sup>*5</sup>	50 sheets <sup>*10</sup>
		OHP transparencies <sup>*7</sup>	A4☐, 8 <sup>1</sup> / <sub>2</sub> " × 11"☐, A4☐ <sup>*5</sup> , 8 <sup>1</sup> / <sub>2</sub> " × 11"☐ <sup>*5</sup>	50 sheets <sup>*10</sup>
Postcards <sup>*3</sup> <sup>*7</sup>	100 × 148 mm☐	30 sheets <sup>*10</sup>		
Label paper (adhesive labels)	B4☐, A4☐, A4☐ <sup>*5</sup>	1 sheet		
Large Capacity Tray (LCT) (option) <sup>*1</sup>	52.3-127.9 g/m <sup>2</sup> (14-34 lb. Bond)	B4☐ <sup>*8</sup> , A4☐ <sup>*8</sup> , 8 <sup>1</sup> / <sub>2</sub> " × 14"☐ <sup>*8</sup> , A4☐, B5☐, 8 <sup>1</sup> / <sub>2</sub> " × 11"☐	4,000 sheets	

<sup>\*1</sup> The paper tray fence is fixed. If you wish to change the size of paper placed in this tray, contact your service representative.  
<sup>\*2</sup> The optional tab sheet holder is required.  
<sup>\*3</sup> The paper size is detected automatically.  
<sup>\*4</sup> Select the paper size in System Settings. ⇒ p.79 "Tray Paper Size: (Tray 2,3)"  
<sup>\*5</sup> Press the [Bypass] key, and the [#] key, and then select the paper size.  
<sup>\*6</sup> Press the [Bypass] key, and the [#] key, and then enter the paper size using the number keys.  
<sup>\*7</sup> If you wish to copy onto OHP transparencies or thick paper, select "OHP" or "Thick Paper". ⇒ "When copying onto OHP transparencies or Thick Paper" in the Copy Reference



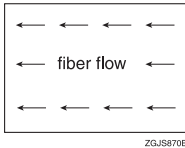

- \*<sup>8</sup> The optional B4/8<sup>1</sup>/<sub>2</sub>" × 14" tray unit is required to load B4/8<sup>1</sup>/<sub>2</sub>" × 14" size paper. (2,500 sheets can be loaded in this tray.)
- \*<sup>9</sup> When loading paper, make sure the stack height does not exceed the lower limit mark of the paper tray. The amount of paper that can be set is 10 mm/100 sheets approximately. ⇒ p.116 "Loading Paper"
- \*<sup>10</sup> It is recommended to place one sheet at a time.
- \*<sup>11</sup> When loading translucent papers, set the paper direction according to fiber flow.



### Important

- If you use damp or curled paper, a misfeed may occur.

### Note

- When loading paper in the paper trays 1-3, place the copy side face down.
- When loading paper in the large capacity tray (LCT), place the copy side face down.
- When loading paper in the bypass tray, place the copy side face up.
- When you use the bypass tray, it is recommended to set the copy paper direction to .
- Do not use paper for inkjet printers.
- When you load OHP transparencies, check the front and back of the sheets, and place them correctly, or a misfeed might occur. Set the paper direction to . ⇒ "Copying from the Bypass Tray" in the Copy Reference.
- When you use OHP transparencies, shuffle them for each use.
- If multiple sheet feeding occurs, load sheets one by one.
- When you load label paper, set the paper direction to .
- If you load paper of the same size in the same direction in two or more trays, the machine automatically shifts to the other tray when the first tray in use runs out of paper. This function is called Auto Tray Switching. (However, if the Paper Type of one tray is recycled or special paper, the settings of the other trays must be the same for the Auto Tray Switching function to work.) This saves interrupting a copy run to replenish paper when making a large number of copies. ⇒ "General Features <sup>1</sup>/<sub>5</sub> - Auto Tray Switching" in the Copy Reference, p.79 "Tray Paper Size: (Tray 2,3)"

---

## Non-recommended Paper

---

 **CAUTION:**

- *Do not use aluminum foil, carbon paper, or similar conductive paper to avoid a fire or machine failure.*

 **Important**

- Do not use any of the following kinds of paper or a fault might occur.
  - Paper for inkjet printers
  - Thermal fax paper
  - Art paper
  - Aluminum foil
  - Carbon paper
  - Conductive paper
  - Paper with perforated lines
  - Hemmed paper
  - Envelopes
- Do not copy on the side of paper that has been already copied onto or a fault might occur.

 **Note**

- Do not use the following kinds of paper or a misfeed might occur.
  - Bent, folded, or creased paper
  - Torn paper
  - Slippery paper
  - Perforated paper
  - Rough paper
  - Thin paper with low stiffness
  - Paper with a dusty surface
- If you copy onto rough grain paper, the image might be blurred.

---

## Paper Storage

---

 **Note**

- When storing paper, the following precautions should always be followed:
  - Do not store paper where it will be exposed to direct sunlight.
  - Avoid storing paper in humid areas (humidity: 70% or less).
  - Store on a flat surface.
- Do not store paper vertically.
- In high temperature/high humidity conditions or low temperature/ low humidity conditions, store paper in a vinyl bag.

# INDEX

10BASE-T/100BASE-TX, 27

## A

---

- A3/11" × 17" Tray Unit, 176
- Access to the Machine, 153
- Acquiring
  - IP Address, 38
- Adding
  - Staples, 134
  - Toner, 120
- Adding Staples
  - Booklet Finisher (Saddle Stitch), 136
  - Finisher 3000B (100-Sheet Staples), 138
  - Finisher 3000M (50-Sheet Staples),  
Booklet Finisher, 134
- Address Book
  - Change Order, 92
  - Edit Title, 93
  - Program/Change/Delete Group, 92
  - Select Title, 94
- Address Book Management, 92
- ADF Original Table Elevation, 78
- AOF (Always ON), 95
- Assigning
  - Delivery Option, 44
- Auto Delete File, 94
- Auto Off, 48
- Auto Off Timer, 82
- Available Functions, 17
  - Copy Mode, 17
  - Document Server Mode, 18
  - Printer Mode, 17
  - Scanner Mode, 17

## B

---

- B4/81/2" × 14" Tray Unit, 176
- Bidirectional Communication, 86
- Bidirectional SCSI print, 88
- Bypass tray, 22

## C

---

- Changing
  - Display Language, 155
  - E-mail Destination, 104
  - File Name, 60, 61
  - Group Name, 109
  - Modes, 47
  - Paper Size, 132
  - Password, 61
  - User Code, 98
  - User Name, 61
  - User Tools, 74
- Changing the Paper Size
  - Tray 2, 132
  - Tray 3, 132
- Channel, 88
- Checking
  - Job List, 49
  - Stored Documents, 62
- [Check Modes]** key, 24
- Cleaning
  - Document feeder, 154
  - Exposure glass, 154
- Clearing
  - Counter, 101
  - E-mail Destination, 105
  - Misfeeds, 122
  - User Code, 99
- [Clear Modes]** key, 24
- [Clear/Stop]** key, 25
- Combined Function Operations, 47
- Common key operations, 26
- Communication Mode, 88
- Configuring
  - Network, 34
- Connecting
  - Ethernet Interface, 30
  - IEEE 1394 Interface, 31
  - Machine (Network Connections), 27
  - Network Cable, 30
  - USB 2.0 Interface, 31
- Control panel, 22, 24
- Copier/Document Server Auto Reset Timer, 83
- Copy Count Display
  - (Copier/Document Server), 75
- Copy Paper, 177
- Copy tray, 21, 23, 171
- Copy tray guide, 21

## Counter

*Clearing*, 101

*Displaying*, 156

## Counter for Each User Code

*Displaying*, 100

*Printing*, 100

Cover Sheet Tray, 81

## D

---

Delete All Files, 94

### Deleting

*E-mail Destination from a Group*, 107

*Group*, 108

*Job List*, 50

*Saved Documents*, 66

Delivery Option, 89

*Assigning*, 44

Display/Clear/Print Counter per User Code, 91

### Displaying

*Counter*, 156

*Counter for Each User Code*, 100

*E-mail Destination*, 108

### Display Language

*Changing*, 155

Display panel, 24, 26

Display Password with Stored File, 94

Display/Print Counter, 91

### Document

*Selecting*, 61

Document feeder, 21, 162

Document Server, 57, 161

*Settings*, 67

*Using*, 58

### Document Server Mode

*File Merge Printing*, 19

*On Demand Printing*, 19

*Operation from a Computer*, 19

Do's And Don'ts, 149

Duplex Priority, 13

## E

---

Effective Protocol, 85

E-mail Destination, 102

*Changing*, 104

*Clearing*, 105

*Displaying*, 108

*Registering*, 102

**[Energy Saver]** key, 24

Energy Saver Timer, 82

ENERGY STAR Program, 12

Entering Text, 110

### Ethernet Interface

*Connecting*, 30

Ethernet Speed, 85

### Exiting

*User Tools*, 74

Exposure glass, 21

External Options, 23

## F

---

### File Name

*Changing*, 60, 61

File Transfer, 89

File Transfer Settings, 43

### Finisher

*Booklet Finisher*, 23, 164

*Finisher 3000B (100-Sheet Staples)*, 23, 169

*Finisher 3000M (50-Sheet Staples)*, 23, 167

Front cover, 22

Function keys, 25

Function Priority, 75

Function Reset Timer, 76

Function Status indicator, 25

## G

---

Gateway Address, 85

General Features, 75

### Group

*Deleting*, 108

### Group Name

*Changing*, 109

Guide To Components, 21

## I

---

- IEEE 1394 Interface
  - Connecting*, 31
- IEEE 1394 ports, 27
- Indicators, 24
- Input Prime, 86
- Inquiry, 155
- Interface, 22
- Interface Settings/IEEE 1394, 87
- Interface Settings/IEEE 802.11b, 88
- Interface Settings/Network, 84
- Interface Settings/Parallel Interface, 86
- Interleave Print, 76
- Interposer, 23, 173
- 【Interrupt】** key, 24
- IP Address, 84, 87
  - Acquiring*, 38
- IP over 1394, 87

## J

---

- Jammed Staples
  - Removing*, 140
- Job List, 49
  - Checking*, 49
  - Deleting*, 50
- Job List Display Time, 78
- 【Job List】** key, 24

## K

---

- 【#】** key, 25
- Key Counter Management, 90
- Key Operator Code, 90
- Key Operator's E-mail Address, 95
- Key Operator Tools, 90

## L

---

- LAN Type, 85
- Large Capacity Tray (LCT), 23, 172
- Loading Paper, 116
  - Interposer*, 118
  - Large Capacity Tray (LCT)*, 117
  - Tray 1 (Tandem Tray)*, 116
  - Tray 2*, 117
  - Tray 3*, 117
- Low Power Mode, 48

## M

---

- Machine Environment, 151
- Machine (Network Connections)
  - Connecting*, 27
- Machine Types, 15
- Mailbox, 23, 163
- Mainframe, 157
- Main Power
  - Turning Off*, 33
  - Turning On*, 32
- Main power indicator, 25
- Main power switch, 21, 32
- Maintaining Your Machine, 154
- Manuals for this Machine, 14
- Misfeeds
  - Clearing*, 122
- Moving, 152
- Multi-Access, 51

## N

---

- Network
  - Configuring*, 34
- Network Boot, 85
- Network Cable
  - Connecting*, 30
- Network Settings, 36
  - IEEE 1394 Interface*, 39
  - NetWare*, 38
  - TCP/IP*, 37
  - Wireless LAN Interface in 802.11 Ad hoc Mode*, 40
  - Wireless LAN Interface in Ad hoc Mode*, 41
  - Wireless LAN Interface in Infrastructure Mode*, 42
- Non-recommended Paper, 180
- Number keys, 25
- Number of Recalls
  - Setting*, 45
- Number of Scanner Recalls, 89
- NW Frame Type, 85

## O

---

- Off Mode, 12
- On indicator, 25
- Operation switch, 22, 25, 32
- Output
  - Copier*, 77
  - Document Server*, 77
  - Printer*, 78
- Output Jogger, 176
- Output Tray Setting, 76

## P

---

- Panel Off Timer, 83
- Panel Tone, 75
- Paper Storage, 181
- Paper tray, 22
  - tray 1, 22
  - tray 2, 22
  - tray 3, 22
- Paper Tray Priority
  - Copier, 79
  - Printer, 79
- Paper Type
  - Bypass tray, 80
  - LCT, 80
  - Tray 1, 80
  - Tray 2, 80
  - Tray 3, 80
- Parallel Communication Speed, 86
- Parallel port, 27
- Parallel Timing, 86
- Password
  - Changing, 61
  - Setting or changing, 60
- Power
  - Turning Off, 33
  - Turning On, 32
- Power Connection, 152
- Print First Page, 65
- Printing
  - Counter for Each User Code, 100
  - Saved Documents, 63
- Printing Saved Documents
  - Changing, 64
  - Stopping, 64
- Print Priority, 75
- 【Program】** key, 24
- Punch Unit, 174
- Punch Waste
  - Removing, 146

## R

---

- Recall Interval Time
  - Setting, 44
- Recommended Paper Sizes and Types, 177
- Registering
  - E-mail Destination, 102
  - E-mail Destinations to a Group, 107
  - New Group, 106
  - User Code, 97
- Registering or changing
  - User Name, 59
- Remarks, 149
- Removing
  - Jammed Staples, 140
  - Punch Waste, 146
- Removing Jammed Staples
  - Booklet Finisher (Saddle Stitch), 142
  - Finisher 3000B (100-Sheet Staples), 144
  - Finisher 3000M (50-Sheet Staples), Booklet Finisher, 140
- Removing Punch Waste
  - Finisher 3000B (100-Sheet Staples), 147
  - Finisher 3000M (50-Sheet Staples), Booklet Finisher, 146
- Replacing
  - Toner, 121
- Return to Defaults, 89

## S

---

- Safety information, 8
- Sample Copy, 65
- 【Sample Copy】** key, 25
- Saved Documents
  - Deleting, 66
  - Printing, 63
  - Searching, 62
- Saving Energy, 48
  - Auto Off, 48
  - Low Power Mode, 48
  - System Reset, 48
- Scanner Auto Reset Timer, 83
- Scanner Recall Interval Time, 89
- Scanning and Saving Originals, 58
- Screen contrast knob, 24
- SCSI print (SBP-2), 87
- Searching
  - by File Name, 62
  - by User Name, 63
  - Saved Documents, 62
- Selecting
  - Document, 61

- Selection Signal Status, 86
- Set Date, 83
- Set Time, 84
- Setting
  - Number of Recalls*, 45
  - Recall Interval Time*, 44
- Setting or changing
  - Password*, 60
- Settings
  - Document Server*, 67
- Signal Control, 86
- Sleep Mode, 12
- Slip Sheet Tray, 81
- Slip Sheet Tray 1, 81
- Slip Sheet Tray 2, 81
- Specification, 157
  - Booklet Finisher*, 164
  - Copy tray*, 171
  - Document feeder*, 162
  - Document Server*, 161
  - Finisher 3000B (100-Sheet Staples)*, 169
  - Finisher 3000M (50-Sheet Staples)*, 167
  - Interposer*, 173
  - Large Capacity Tray (LCT)*, 172
  - Mailbox*, 163
  - Mainframe*, 157
  - Punch Unit*, 174
- SSID Setting, 88
- Staples
  - Adding*, 134
- 【Start】** key, 25
- Stored Documents
  - Checking*, 62
- Sub-net Mask, 84, 81
- Suspend Copy
  - Finisher 3000B (100-Sheet Staples)*, 119
- System Auto Reset Timer, 83
- System Reset, 48

## T

---

- Tab Sheet Holder, 176
- Text
  - Deleting*, 111
  - Entering*, 111
- Timer Setting, 82
- Toner, 150
  - Adding*, 120
  - Handling*, 150
  - Replacing*, 121
  - Storing*, 150
- Transmission Speed, 89
- Tray Paper Settings, 79
- Tray Paper Size
  - Tray 2*, 79
  - Tray 3*, 79
- Troubleshooting, 113
- Turning Off
  - Main Power*, 33
  - Power*, 33
- Turning On
  - Main Power*, 32
  - Power*, 32

## U

---

- USB 2.0 Interface
  - Connecting*, 31
- USB port, 27
- User Code
  - Changing*, 98
  - Clearing*, 99
  - Registering*, 97
- User Code Management, 90
- User Codes, 96
- User Management, 20
  - Using*, 20
- User Name
  - Changing*, 61
  - Registering or changing*, 59
- User Tools
  - Changing*, 74
  - Exiting*, 74
- 【User Tools/Counter】** key, 24
- User Tools Menu (System Settings), 69
- User Tools (System Settings), 69
- Using
  - Document Server*, 58
  - User Management*, 20



## **V**

---

Ventilation holes, 22

## **W**

---

Warm Up Notice

(Copier/Document Server), 75

Weekly Timer, 84

Weekly Timer Code, 84

WEP (Encryption) Setting, 89

Where to Put Your Machine, 151

Wireless LAN port, 27

Wireless LAN Signal, 88

MEMO

## Free Manuals Download Website

<http://myh66.com>

<http://usermanuals.us>

<http://www.somanuals.com>

<http://www.4manuals.cc>

<http://www.manual-lib.com>

<http://www.404manual.com>

<http://www.luxmanual.com>

<http://aubethermostatmanual.com>

Golf course search by state

<http://golfingnear.com>

Email search by domain

<http://emailbydomain.com>

Auto manuals search

<http://auto.somanuals.com>

TV manuals search

<http://tv.somanuals.com>