



**RICOH COMPANY, LTD.**

15-5, Minami Aoyama 1-chome,  
Minato-ku, Tokyo 107-8544, Japan  
Phone: +81-(0)3-3479-3111



# Aficio™ 1013/1013F

## Operating Instructions Copy Reference

Aficio™ 1013/1013F Operating Instructions Copy Reference

### Overseas Affiliates

**U.S.A.**

RICOH CORPORATION  
5 Dedrick Place  
West Caldwell, New Jersey 07006  
Phone: +1-973-882-2000

**The Netherlands**

RICOH EUROPE B.V.  
Groenelaan 3, 1186 AA, Amstelveen  
Phone: +31-(0)20-5474111

**United Kingdom**

RICOH UK LTD.  
Ricoh House,  
1 Plane Tree Crescent, Feltham,  
Middlesex, TW13 7HG  
Phone: +44-(0)20-8261-4000

**Germany**

RICOH DEUTSCHLAND GmbH  
Mergenthalerallee 38-40,  
65760 Eschborn  
Phone: +49-(0)6196-9060

**France**

RICOH FRANCE S.A.  
383, Avenue du Général de Gaulle  
BP 307-92143 Clamart Cedex  
Phone: +33-(0)-821-01-74-26

**Spain**

RICOH ESPAÑA S.A.  
Avda. Litoral Mar, 12-14,  
08005 Barcelona  
Phone: +34-(0)93-295-7600

**Italy**

RICOH ITALIA SpA  
Via della Metallurgia 12,  
37139 Verona  
Phone: +39-045-8181500

**Hong Kong**

RICOH HONG KONG LTD.  
21/F., Tai Yau Building,  
181, Johnston Road,  
Wan Chai, Hong Kong  
Phone: +852-2862-2888

**Singapore**

RICOH ASIA PACIFIC PTE.LTD.  
260 Orchard Road,  
#15-01/02 The Heeren,  
Singapore 238855  
Phone: +65-830-5888

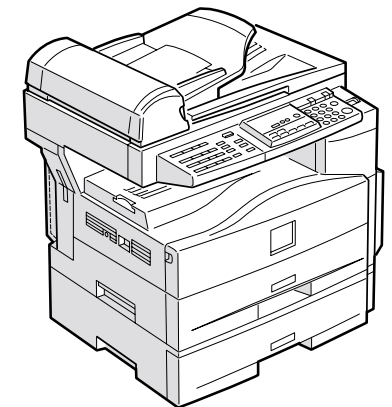

ZFKH010E

Printed in China

AE (AE) B045-7208

Read this manual carefully before you use this product and keep it handy for future reference.  
For safety, please follow the instructions in this manual.

## Introduction

This manual contains detailed instructions on the operation and maintenance of this machine. To get maximum versatility from this machine all operators should carefully read and follow the instructions in this manual. Please keep this manual in a handy place near the machine.

Please read the Safety Information before using this machine. It contains important information related to USER SAFETY and PREVENTING EQUIPMENT PROBLEMS.

---

### Notes:

Some illustrations might be slightly different from your machine.

Certain options might not be available in some countries. For details, please contact your local dealer.

---

### Operator Safety:

This machine is considered a class I laser device, safe for office/EDP use. The machine contains a 5-milliwatt, 760 - 800 nanometer wavelength, GaAlAs laser diode. Direct (or indirect reflected) eye contact with the laser beam might cause serious eye damage. Safety precautions and interlock mechanisms have been designed to prevent any possible laser beam exposure to the operator.

The following label is attached on the back side of the machine.

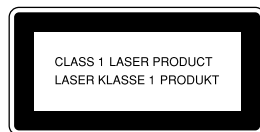

### Laser Safety:

The optical housing unit can only be repaired in a factory or at a location with the requisite equipment. The laser subsystem is replaceable in the field by a qualified Customer Engineer. The laser chassis is not repairable in the field. Customer engineers are therefore directed to return all chassis and laser subsystems to the factory or service depot when replacement of the optical subsystem is required.

### Warning:

Use of controls or adjustment or performance of procedures other than those specified in this manual might result in hazardous radiation exposure.

### Notes:

The models of the machines do not appear in the following pages. Check the type of your machine before reading this manual. (For details, see P.v "Machine Types".)

- Type 1: Aficio 1013
- Type 2: Aficio 1013F

Certain types might not be available in some countries. For details, please contact your local dealer.

Two kinds of size notation are employed in this manual. With this machine refer to the metric version.

For good copy quality, Ricoh recommends that you use genuine Ricoh toner.

Ricoh shall not be responsible for any damage or expense that might result from the use of parts other than genuine Ricoh parts in your Ricoh office product.

### Power Source:

220-240V, 50/60Hz, 4A or more

Please be sure to connect the power cord to a power source as above. For details about power source, see P.61 "Power Connection"

In accordance with IEC 60417, this machine uses the following symbols for the main power switch:

**I** means POWER ON.

**⏻** means STAND BY.

# Safety Information

When using your equipment, the following safety precautions should always be followed.

---

## Safety During Operation

---

In this manual, the following important symbols are used:

**⚠ WARNING:**  
*Indicates a potentially hazardous situation which, if instructions are not followed, could result in death or serious injury.*

**⚠ CAUTION:**  
*Indicates a potentially hazardous situation which, if instructions are not followed, may result in minor or moderate injury or damage to property.*

---

**⚠ WARNING:**

---

- **Connect the power cord directly into a wall outlet and never use an extension cord.**
- **Disconnect the power plug (by pulling the plug, not the cable) if the power cable or plug becomes frayed or otherwise damaged.**
- **To avoid hazardous electric shock or laser radiation exposure, do not remove any covers or screws other than those specified in this manual.**
- **Turn off the power and disconnect the power plug (by pulling the plug, not the cable) if any of the following conditions exists:**
  - **You spill something into the equipment.**
  - **You suspect that your equipment needs service or repair.**
  - **Your equipment's cover has been damaged.**
- **Do not incinerate spilled toner or used toner. Toner dust might ignite when exposed to an open flame.**
- **Disposal can take place at our authorized dealer or at appropriate collection sites.**
- **Dispose of the used toner cartridge in accordance with the local regulation.**

---

**⚠ CAUTION:**

---

- *Protect the equipment from dampness or wet weather, such as rain, snow, and so on.*
- *Unplug the power cord from the wall outlet before you move the equipment. While moving the equipment, you should take care that the power cord will not be damaged under the equipment.*
- *When you disconnect the power plug from the wall outlet, always pull the plug (not the cable).*
- *Do not allow paper clips, staples, or other small metallic objects to fall inside the equipment.*
- *Keep toner (used or unused) and toner cartridge out of the reach of children.*
- *For environmental reasons, do not dispose of the equipment or expended supply waste at household waste collection points. Disposal can take place at an authorized dealer or at appropriate collection sites.*
- *The inside of the machine could be very hot. Do not touch the parts with a label indicating the "hot surface". Otherwise it could cause a personal burn.*
- *Our products are engineered to meet high standards of quality and functionality, and we recommend that you only use the expendable supplies available at an authorized dealer.*

## Positions of Labels and Hallmarks for ⚠WARNING and ⚠CAUTION

This machine has labels and hallmarks for ⚠WARNING, ⚠CAUTION at the positions shown below. For safety, please follow the instructions and handle the machine as indicated.

The inside of the machine becomes very hot. Do not touch the inside. Doing so could result in a burn.

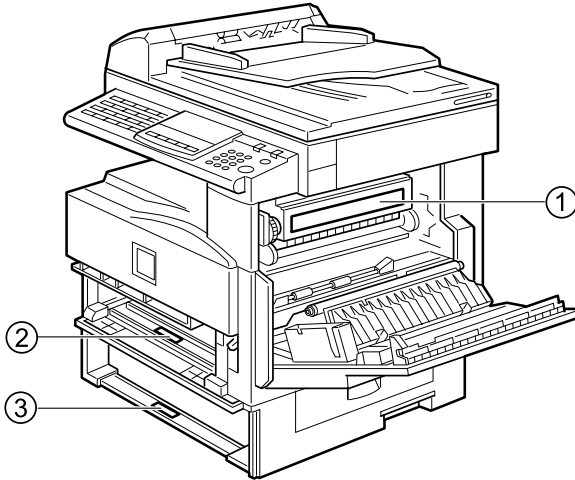

①



② The anti-condensation heater in the inner lower part of the machine becomes very hot. Do not touch it. Doing so could result in a burn.



③ The anti-condensation heater in the inner upper part of the machine becomes very hot. Do not touch it. Doing so could result in a burn.



### Note

- The anti-condensation heater is optional. For details, contact your service representative.

# How to Read this Manual

---

## Symbols

---

In this manual, the following symbols are used:

### **WARNING:**

This symbol indicates a potentially hazardous situation that might result in death or serious injury when you misuse the machine without following the instructions under this symbol. Be sure to read the instructions, all of which are described in the Safety Information section.

### **CAUTION:**

This symbol indicates a potentially hazardous situation that might result in minor or moderate injury or property damage that does not involve personal injury when you misuse the machine without following the instructions under this symbol. Be sure to read the instructions, all of which are described in the Safety Information section.

\* The statements above are notes for your safety.

### **Important**

If this instruction is not followed, paper might be misfed, originals might be damaged, or data might be lost. Be sure to read this.

### **Preparation**

This symbol indicates the prior knowledge or preparations required before operating.

### **Note**

This symbol indicates precautions for operation, or actions to take after misoperation.

### **Limitation**

This symbol indicates numerical limits, functions that cannot be used together, or conditions in which a particular function cannot be used.

### **Reference**

This symbol indicates a reference.

### 

Keys built into the machine's operation panel.

# Machine Types

This machine has two models. Type 2 machine is installed with the fax unit as a standard.

	Type 1	Type 2
Fax unit	Option	Standard
Printer unit	Option	Option

# What You Can Do with This Machine

\*1The optional 32MB copier memory unit is required.

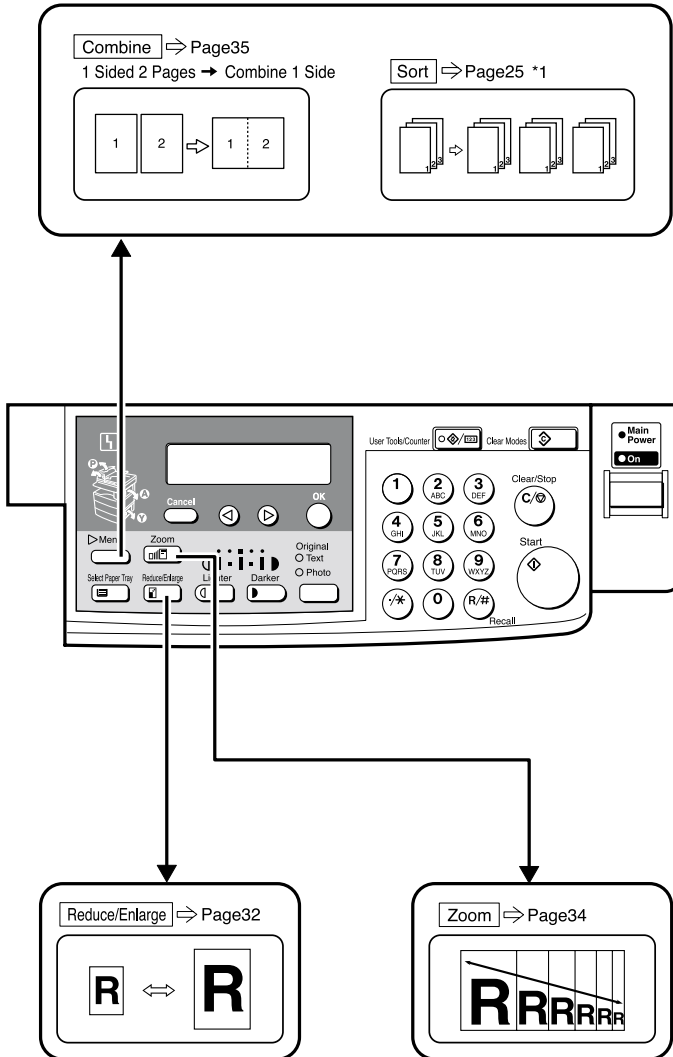

ZF0S990A



# TABLE OF CONTENTS

<b>Guide to Components</b> .....	<b>1</b>
<b>Options</b> .....	<b>3</b>
<b>Control Panel</b> .....	<b>4</b>
<b>Panel Display</b> .....	<b>6</b>
Displays and Key Operations .....	6

## 1. Basics

---

<b>Turning On the Power</b> .....	<b>7</b>
Turning On the Main Power .....	7
Starting the Machine .....	8
<b>Changing Modes</b> .....	<b>9</b>
<b>Originals</b> .....	<b>10</b>
Sizes and Weights of Recommended Originals .....	10
Original Sizes and Scanning Area/Missing Image Area .....	11
<b>Copy Paper</b> .....	<b>12</b>
Recommended Paper Sizes and Types .....	12
Non-recommended Paper .....	13
Paper Storage .....	14
<b>Toner</b> .....	<b>15</b>
Handling Toner .....	15
Toner Storage .....	15
Used Toner .....	15

## 2. Copying

---

<b>Basic Procedure</b> .....	<b>17</b>
<b>Placing Originals</b> .....	<b>19</b>
Placing Originals on the Exposure Glass .....	19
Loading Originals in the Document Feeder (ADF) .....	20
Placing Standard Size Originals .....	20
Placing Custom Size Originals .....	21
<b>Basic Functions</b> .....	<b>23</b>
Adjusting Copy Image Density .....	23
Selecting an Original Type .....	23
Selecting Copy Paper .....	24
<b>Sort</b> .....	<b>25</b>
Sort .....	25
<b>Copying from the Bypass Tray</b> .....	<b>27</b>
When copying onto OHP transparencies .....	28
When copying onto standard size paper .....	29
When copying onto custom size copy paper .....	29
When copying onto envelopes .....	30

<b>Other Functions</b> .....	<b>31</b>
User Codes .....	31
Auto Start .....	31
<b>Preset Reduce/Enlarge</b> .....	<b>32</b>
<b>Zoom</b> .....	<b>34</b>
<b>Combine</b> .....	<b>35</b>
<b>Combination Chart</b> .....	<b>37</b>

### 3. Troubleshooting

---

<b>Machine Operation Problems</b> .....	<b>39</b>
General .....	39
Display .....	39
<b>Cannot Make Clear Copies</b> .....	<b>40</b>
<b>Cannot Make Desired Copies</b> .....	<b>41</b>
Combine .....	41
<b>↳ Loading Paper</b> .....	<b>42</b>
Loading paper in the optional paper tray unit.....	42
<b>↳ Changing the Toner Cartridge</b> .....	<b>44</b>
<b>↳ Clearing Misfeeds</b> .....	<b>46</b>
<b>Changing the Paper Size</b> .....	<b>48</b>
Changing the Paper Size in the Paper Tray.....	48
Changing the Paper Size in the Optional Paper tray unit.....	49
Selecting the Paper Size with the User Tools .....	51

### 4. User Tools (Copier Features)

---

<b>Accessing the User Tools (Copier Features)</b> .....	<b>53</b>
Exiting the User Tools .....	54
<b>User Tools Menu (Copier Features)</b> .....	<b>55</b>
<b>Settings You Can Change with the User Tools</b> .....	<b>56</b>
Copier Features .....	56

### 5. Remarks

---

<b>Do's and Don'ts</b> .....	<b>59</b>
<b>Where to Put Your Machine</b> .....	<b>60</b>
Machine Environment .....	60
Power Connection .....	61
Access to Machine .....	62
<b>Maintaining Your Machine</b> .....	<b>63</b>
Cleaning the Exposure Glass.....	63
Cleaning the Exposure Glass Cover .....	63
Cleaning the Document Feeder (ADF).....	63

## 6. Specifications

---

<b>Mainframe.....</b>	<b>65</b>
<b>Document Feeder (ADF) (Option for Type 1) .....</b>	<b>68</b>
<b>Paper Tray Unit (Option).....</b>	<b>69</b>
<b>32MB Copier Memory Unit (Option).....</b>	<b>70</b>
<b>INDEX.....</b>	<b>71</b>



# Guide to Components

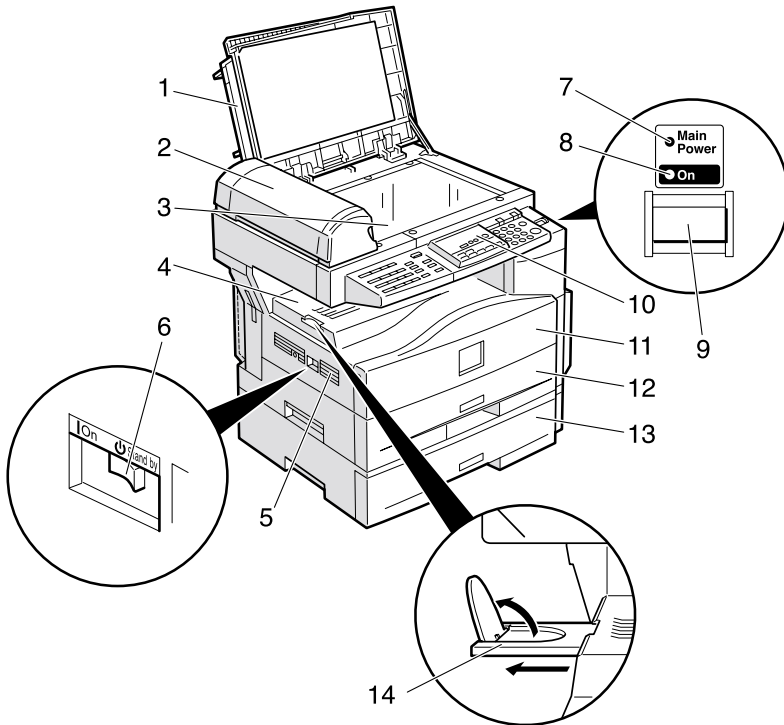

ZFOH790N

## 1. Exposure glass cover

Lower the exposure glass cover over the original placed on the exposure glass for copying.

## 2. Document feeder (ADF) (Option for Type 1)

Originals will be fed automatically.

## 3. Exposure glass

Position originals here face down for copying. See p.10 "Originals".

## 4. Internal tray

Copied paper is delivered here face down.

## 5. Ventilation hole

Prevents overheating. Do not obstruct the ventilation hole by placing or leaning an object near it. If the machine overheats, a fault might occur.

## 6. Main power switch

If the machine does not operate after turning on the operation switch, check if the main power switch is turned on. If it is off, turn it on. However, if the machine is installed with the fax function, do not turn the main power off.

## 7. Main Power indicator

This indicator lights up when the main power switch is turned on, and goes off when the switch is turned off.

### **8. On indicator**

This indicator lights up when the operation switch is turned on, and goes off when the switch is turned off.

### **9. Operation switch**

Press this switch to turn the power on (the On indicator lights up). To turn the power off, press this switch again (the On indicator goes off).

### **10. Control panel**

See p.4 "Control Panel".

### **11. Front cover**

Open to access the inside of the machine.

### **12. Paper tray**

Place paper here. See p.42 " Loading Paper".

### **13. Paper tray unit (option)**

Holds 500 sheets of paper.

### **14. Internal tray guide**

Swing out to support large papers and raise the end fence.

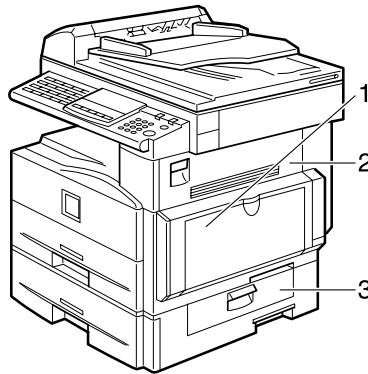

ZFOH020E

### **1. Bypass tray**

Use to copy onto OHP transparencies, adhesive labels, translucent paper, post-cards, envelopes, and custom size paper. See p.27 "Copying from the Bypass Tray".

### **2. Right cover**

Open this cover to remove jammed paper fed from the paper tray.

### **3. Lower right cover**

Open this cover to remove jammed paper fed from the optional paper tray unit.

# Options

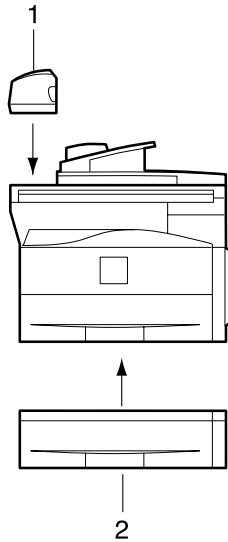

ZFOP030E

## **1. Document feeder (ADF) (Option for Type 1)**

Originals will be fed automatically.

Other options:

- 32MB copier memory unit  
Increases memory capacity.

## **2. Paper tray unit**

Holds 500 sheets of paper.

# Control Panel

## ❖ Copier only

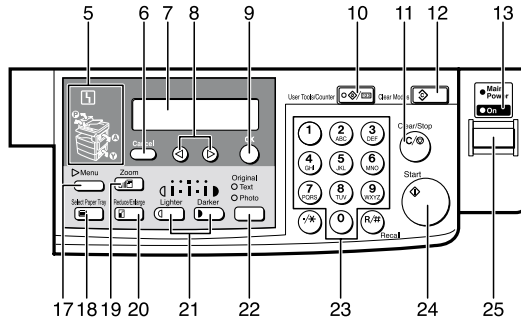

ZFOS980A

## ❖ Fax and/or printer installed

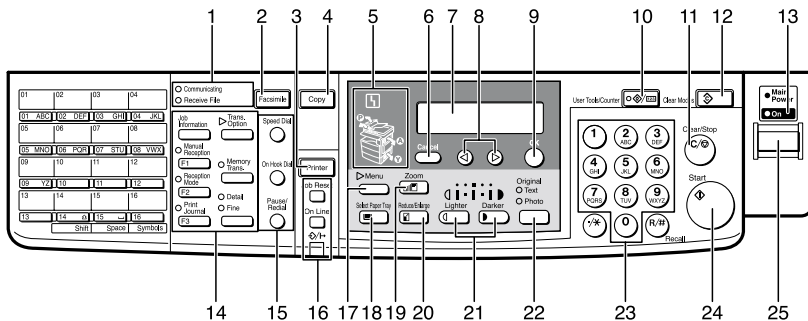

ZFOS970A

### 1. Indicators for fax mode (Fax installed machine only)

See the Facsimile Reference manual.

### 2. [Facsimile] key (Fax installed machine only)

Press to use facsimile functions.

### 3. [Printer] key (Printer installed machine only)

Press to use printer functions.

### 4. [Copy] key

Press to use copy functions.

### 5. Indicators

These indicators show errors or the status of the machine. See p.39 "Troubleshooting".

### 6. [Cancel] key

Press to cancel an operation or return to the previous display.

### 7. Panel display

Shows operation status, error messages, and function menu. See p.6 "Panel Display".

### 8. ⏪ ⏩ keys (Cursor keys)

Press to select an item on the panel display.

### 9. [OK] key

### 10. [User Tools/Counter] key

Press to change the default settings and conditions to meet your requirements. See p.53 "User Tools (Copier Features)".



### **11. [Clear/Stop] key**

While entering numbers, press to cancel a number you have entered. While copying, press to stop copying.

### **12. [Clear Modes] key**

Press to clear the previously entered copy job settings.

### **13. On indicator**

This indicator lights up when the operation switch is turned on, and goes off when the operation switch is turned off.

### **14. Fax function keys (Fax installed machine only)**

Press to change modes. To use copy functions, press the **[Copy]** key.

### **15. Dial Function keys (Fax installed machine only)**

See the Facsimile Reference manual.

### **16. Printer function keys (Printer installed machine only)**

Press to change modes. To use copy functions, press the **[Copy]** key.

### **17. [Menu] key**

Press this key to set the following functions.

- **Combine**  
Press to make combined copies. See p.35 "Combine".
- **Sort (Optional 32MB copier memory unit is required)**  
Automatically sorts copies. See p.25 "Sort"
- **Original Size**  
Select the original size that matches the originals placed. See p.20 "Placing Standard Size Originals"

### **18. [Select Paper Tray] key**

Press to select the paper tray.

### **19. [Zoom] key**

Changes the reproduction ratio in 1% steps.

### **20. [Reduce/Enlarge] key**

Press to make reduced or enlarged copies. See p.32 "Preset Reduce/Enlarge".

### **21. [Lighter] and [Darker] keys**

Adjusts the copy image density.

### **22. [Original] key**

Press to select the original type.

### **23. Number keys**

Use to enter the desired number of copies and data for selected modes.

### **24. [Start] key**

Press to start copying. Also use to initiate Auto Start. See p.31 "Auto Start".

### **25. Operation switch**

Press this switch to turn the power on or return from the Low Power mode, the Sleep mode or the Auto Off mode (the **On** indicator lights up). To turn the power off, press this switch again (the **On** indicator goes off).

# Panel Display

The panel display shows the status of the machine, error messages, and function menus.

## Important

- Do not apply a strong shock or force of about 30N (about 3kgf) or more to the panel display. Otherwise, the display might be damaged.

## Note

- The machine is in Copy mode when turned on. This can be changed. See “Settings You Can Change with the User Tools” in the System Settings manual.

---

## Displays and Key Operations

---

### ◆ Copy display

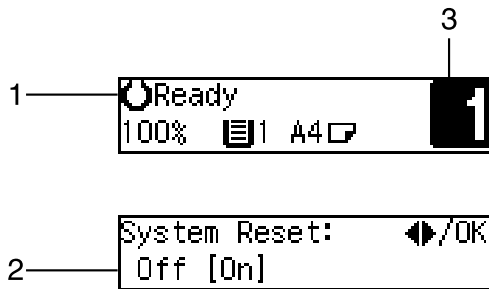

ZFOS570E

**1. Upper line:** The machine status or currently selected functions appear here.

**2. Bottom line:** Items which can be selected or specified, or messages appear here. Currently selected items are displayed with brackets.

**3. Number of copies set and number of copies made.**

### ◆ Common keys

◀ or ▶	Press to move between pages or select function.
<b>[Cancel]</b>	Press to cancel an operation or return to the previous display.
<b>[Clear /Stop]</b>	While entering numbers, press to cancel a number you have entered. While copying, press to stop copying.
<b>[Clear Modes]</b>	Press to cancel the settings and return to the standby mode.
<b>[OK]</b>	Press to set a selected function or entered value.

## Turning On the Power

To turn the machine on, press the operation switch.

### Note

- ❑ This machine automatically enters Energy Saver mode or turns itself off if you do not use the machine for a while. See “6. Auto Off Timer” in the System Settings manual.

### Power switches

This machine has two power switches.

#### ❖ Operation switch (right side of the control panel)

Press this switch to activate the machine. When the machine has warmed up, you can make copies.

#### ❖ Main power switch (left side of the machine)

When the machine is not to be used for an extended period of time, turn off the main power switch.

---

## Turning On the Main Power

---

**1** Make sure that the power cord is firmly plugged into the wall outlet.

**2** Turn on the main power switch.

The main power indicator on the control panel goes on.

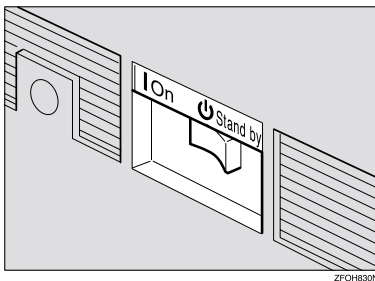

## Starting the Machine

1

- 1 Press the operation switch to make the On indicator go on.

The display panel will come on.

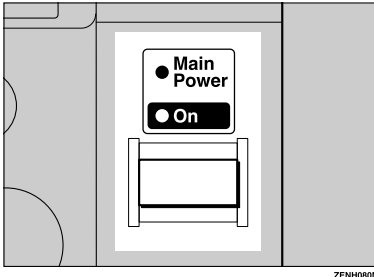

### Note

- If the power is not turned on when the operation switch is pressed, check if the main power switch is on. If off, turn it on.
- During the warm-up period (less than 20 seconds), you can use the Auto Start function. See p.31 "Auto Start".
- You can set up a copy job and press the **[Start]** key while the "Select Modes and Press Start" message is displayed.
- When "Input User Code and Press OK" is displayed, enter your user code.

## Shutting Down the Machine

- 1 Press the operation switch to make the On indicator go off and change to Low Power mode.

## Turning Off the Main Power

- 1 Turn off the main power switch.

The **main power** indicator of the control panel goes off.

### Important

- Fax files stored in memory will be lost 12 hours after you turn the main power switch off or you unplug the power cord.

# Changing Modes

You can use this machine not only as a copier, but optionally as a fax machine or a printer as well. (Type 2 machine is installed with the fax function as the standard.) Press the **[Copy]** key to use copy functions, or press the **[Facsimile]** key to use facsimile functions.

If the display shows a mode other than copy mode, press the **[Copy]** key to switch to copy mode.

For details about how to change the mode the machine starts in when you turn the operation switch on, see "1. Function Priority" in the System Settings manual.

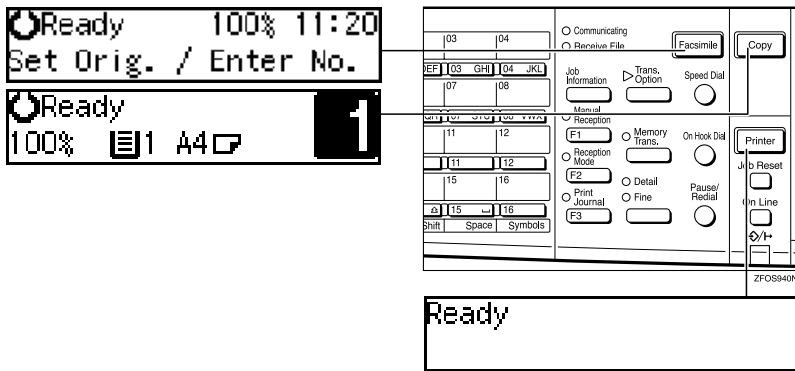

## ! Limitation



- You cannot switch modes in any of the following cases:
  - When scanning in a fax message for transmission.
  - During immediate transmission.
  - When accessing the user tools.
  - During On Hook dialing for fax transmission.
  - During Energy Saver mode.

# Originals



1

## Sizes and Weights of Recommended Originals

### ❖ Metric version

Where original is placed	Original Size	Original Weight
Exposure glass	Up to A4 	--
Document feeder (ADF)	A4  - A5 	52 - 105g/m <sup>2</sup>

### ❖ Inch version

Where original is placed	Original Size	Original Weight
Exposure glass	Up to 8 <sup>1</sup> / <sub>2</sub> " × 11" 	--
Document feeder (ADF)	8 <sup>1</sup> / <sub>2</sub> " × 14"  - 5 <sup>1</sup> / <sub>2</sub> " × 8 <sup>1</sup> / <sub>2</sub> " 	14 - 28 lb

### Non-recommended originals for the document feeder (ADF)

Placing the following originals in the document feeder (ADF) might cause paper misfeeds or damage to the originals. Place these originals on the exposure glass.

- Originals other than those specified in p.10 "Sizes and Weights of Recommended Originals"
- Stapled or clipped originals
- Perforated or torn originals
- Curled, folded, or creased originals
- Pasted originals
- Originals with any kind of coating, such as thermal fax paper, art paper, aluminum foil, carbon paper, or conductive paper
- Originals with indexes, tags, or other projecting parts
- Sticky originals such as translucent paper
- Thin originals that have low stiffness
- Originals of inappropriate weight other than those specified in p.10 "Sizes and Weights of Recommended Originals"
- Bound originals such as books
- Transparent originals such as OHP transparencies or translucent paper

## Original Sizes and Scanning Area/Missing Image Area

### ❖ Exposure glass

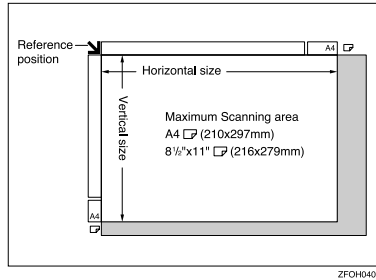

### ❖ Document feeder (ADF)

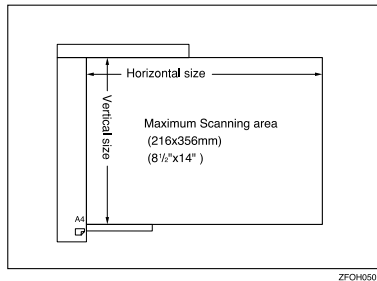

### ! Limitation

- ❑ Even if you correctly place originals in the document feeder (ADF) or on the exposure glass, margins (about 4mm, 0.2") on all four sides might not be copied.

# Copy Paper

1

## Recommended Paper Sizes and Types

The following limitations apply to each tray:

		Paper sizes	Paper weight	Paper capacity
Paper Tray		A4☐, A5☐, 8 <sup>1</sup> / <sub>2</sub> " × 11"☐, 5 <sup>1</sup> / <sub>2</sub> " × 8 <sup>1</sup> / <sub>2</sub> "☐ <b>Note</b> ☐ You can specify the paper size with the user tools. See p.51 "Selecting the Paper Size with the User Tools".	60 – 90g/m <sup>2</sup> , 16 – 24 lb	250 sheets <sup>*1</sup>
Paper tray unit (option)		A4☐, 8 <sup>1</sup> / <sub>2</sub> " × 14"☐, 8 <sup>1</sup> / <sub>2</sub> " × 13"☐, 8 <sup>1</sup> / <sub>4</sub> " × 14"☐, 8 <sup>1</sup> / <sub>4</sub> " × 13"☐, 8 <sup>1</sup> / <sub>2</sub> " × 11"☐ <b>Note</b> ☐ You can specify the paper size with the user tools. See p.51 "Selecting the Paper Size with the User Tools".	60 – 90g/m <sup>2</sup> , 16 – 24 lb	500 sheets <sup>*1</sup>
Bypass tray	Standard sizes	A4☐, A5☐☐, 8 <sup>1</sup> / <sub>2</sub> " × 11"☐, 5 <sup>1</sup> / <sub>2</sub> " × 8 <sup>1</sup> / <sub>2</sub> "☐☐, 8 <sup>1</sup> / <sub>2</sub> " × 14"☐, 8" × 13"☐, 8 <sup>1</sup> / <sub>2</sub> " × 13"☐, 8 <sup>1</sup> / <sub>4</sub> " × 13"☐, 8 <sup>1</sup> / <sub>4</sub> " × 14"☐ <b>Note</b> ☐ You can specify the paper size. See p.27 "Copying from the Bypass Tray"	60 – 157g/m <sup>2</sup> , 16 – 42 lb	100 sheets <sup>*1</sup>
	Custom sizes	Metric version	Vertical: 90 – 216mm Horizontal: 140 – 356mm	
		Inch version	Vertical: 3.5" – 8.5" Horizontal: 5.5" – 14"	
		Envelopes <sup>*2</sup> : Com#10 Env (104.8 × 241.3mm, 4 <sup>1</sup> / <sub>8</sub> " × 9 <sup>1</sup> / <sub>2</sub> " ), CA Env (162 × 229mm, 6.38" × 9.02"), C6 Env (114 × 162mm, 4.49" × 6.38"), DL Env (110 × 220mm, 4.33" × 8.66"), Monarch Env (98.4 × 190.5mm, 3 <sup>7</sup> / <sub>8</sub> " × 7 <sup>1</sup> / <sub>2</sub> " )	72 – 90g/m <sup>2</sup> , 19 – 24 lb	10 sheets
		Translucent paper ( A4☐ ), OHP transparencies <sup>*2</sup>	–	10 sheets
	postcards <sup>*2</sup>		40 sheets	
	Adhesive labels ( A4☐ ) <sup>*2</sup>		1 sheet	

<sup>\*1</sup> Paper weight: 80g/m<sup>2</sup>, 20 lb

<sup>\*2</sup> Place one sheet at a time. See p.27 "Copying from the Bypass Tray".



**Important**

- Use of damp or curled paper may cause a misfeed. If a misfeed occurs, try turning over the paper stack in the paper tray. If there is no improvement, change to copy paper with less curl.

**Note**

- Postcards should be fed from the bypass tray.
- When printing on envelopes, note the following:
  - Load envelopes with the copy side face down on the bypass tray.
  - Check that envelope flaps are securely folded up.
  - Make sure that there is no air between envelopes.
  - Load only envelopes of the same size and type at the same time.
  - Before loading envelopes, flatten the leading edge (the side being fed into the machine) by running a pencil or ruler across them.
  - Use only rectangular envelopes.
- If you load paper of the same size and in the same direction in two trays, the machine automatically switches to another tray when the tray in use runs out of paper. This function is called Auto Tray Switch. This saves interrupting a copy run to replenish paper even when you make a large number of copies. You can cancel this setting. The optional paper tray unit is required to use this setting. See "10Auto Tray Switch" of the System Settings manual.

**Reference**

If you want to add paper, see p.42 "  Loading Paper".

If you want to change the paper size, see p.48 "Changing the Paper Size".

**Non-recommended Paper****CAUTION:**

- *Do not use aluminum foil, carbon paper, or similar conductive paper to avoid a fire or equipment failure.*

**Important**

- Do not use any of the following kinds of paper or a fault might occur.
  - Thermal fax paper
  - Art paper
  - Aluminum foil
  - Carbon paper
  - Conductive paper
- Do not use copy paper that has been already copied on. Otherwise, a paper misfeed might occur.

 **Note**

- Do not use any of the following kinds of paper or a misfeed might occur.
  - Bent, folded, or creased paper
  - Damp paper
  - Torn paper
  - Slippery paper
  - Perforated paper
  - Rough paper
  - Thin paper that has low stiffness
  - Paper with much paper dust on its surface
- If you make copies on rough grain paper, the copy image might be blurred.
- Do not use envelopes in the following conditions.
  - damp
  - excessively curled or twisted
  - stuck together
  - damaged in any way
  - with stamps attached
  - with windows, holes, perforations, cutouts or embossing
  - with metal clasps, string ties or metal folding bars
  - designed to be interlocked
  - with nicked edges or bent corners
  - with rough, wrinkled or laid finishes
  - with any exposed adhesive, when the flap is in the sealed or closed position

---

## Paper Storage

---

 **Note**

- When storing paper, the following precautions should always be followed:
  - Do not store paper where it will be exposed to direct sunlight.
  - Avoid storing paper in humid areas (humidity: 70% or less).
  - Store on a flat surface.
- Keep open reams of paper in the package, and store as you would unopened paper.
- Under high temperature and high humidity, or low temperature and low humidity conditions, store paper in a plastic bag.

---

# Toner

---

## Handling Toner

---

 **WARNING:**

- ***Do not incinerate used toner or toner containers. Toner dust might ignite when exposed to an open flame. Dispose of used toner containers in accordance with local regulations for plastics.***

 **CAUTION:**

- *Keep toner (used or unused) and toner containers out of reach of children.*

 **CAUTION:**

- *Our products are engineered to meet high standards of quality and functionality, and we recommend that you only use the expendable supplies available at an authorized dealer.*

 **Important**

- If you use toner other than that recommended type, a fault might occur.

 **Reference**

If you want to add toner, see p.44 “ Changing the Toner Cartridge”.

---

## Toner Storage

---

 **Note**

- When storing toner, the following precautions should always be followed:
  - Store toner containers in a cool, dry place free from direct sunlight.
  - Store on a flat surface.

---

## Used Toner

---

 **Note**

- Toner cannot be re-used.



# 2. Copying

## Basic Procedure

- 1 Make sure that the machine is in Copy mode.



**Note**

- If not, press the **[Copy]** key.

- 2 If the machine is set for User Code, enter the code with the number keys, and then press the **[OK]** key. See p.31 "User Codes".

- 3 Make sure that there are no previous settings remaining.

**Note**

- To clear settings, press the **[Clear Modes]** key.

- 4 Place your originals.

**Reference**

See p.19 "Placing Originals".

- 5 Make the desired settings.

- 6 Enter the number of copies required with the number keys.

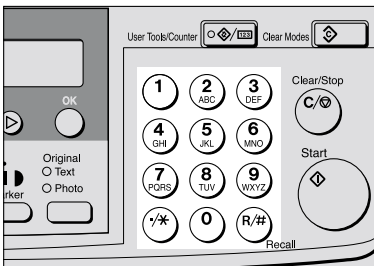

ZF05960A

**Note**

- The maximum copy quantity can be set between 1 and 99 (default: 99). See "1. Max. Copy Q'ty" in p.56 "Copier Features".
- To change the number entered, press the **[Clear/Stop]** key, and then enter the new number.

- 7 Press the **[Start]** key.

The machine starts copying.

**Note**

- To stop the machine during the multi-copy run, press the **[Clear/Stop]** key.
- To return the machine to the initial condition after copying, press the **[Clear Modes]** key.

### System Reset

The machine returns to its prioritized mode automatically after your job is finished, after a certain period of time. This function is called "System Reset".

**Note**

- You can change the System Reset time. See "3. System Reset" in the System Settings manual.

  
 **Auto Off**

The machine turns itself off automatically after your job is finished, after a certain period of time. This function is called “Auto Off”.

2

 **Note**

- How to exit Auto Off mode:
    - Turn on the operation switch
    - Place an original in the document feeder (ADF)
    - Lift and lower the exposure glass cover
  - You can change the Auto Off time. See “6. Auto Off Timer” in the System Settings manual.
- 





# Placing Originals

## ⚠ Limitation

- ❑ Place originals after correction fluid and ink has completely dried. Not taking this precaution could mark the exposure glass and cause marks to be copied.

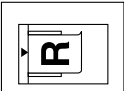
## 📝 Note

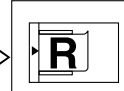
- ❑ Basically, the originals should be aligned to the rear left corner. However, some copy functions may produce different results depending on the direction of the originals. For details, see explanations of each function.

Originals	Document feeder (ADF)	Exposure glass
		
	<small>GGC0600E</small>	
		
	<small>96C23EE</small>	

## 🔍 Reference

See p.10 "Originals".

## Placing Originals on the Exposure Glass

- 1** Lift the exposure glass cover or the document feeder (ADF).
- 2** Place the original face down on the exposure glass. The original should be aligned to the rear left corner.

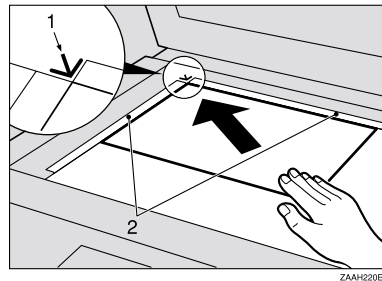

**1.** Reference mark

**2.** Scale

- 3** Lower the exposure glass cover or the document feeder (ADF).

## Loading Originals in the Document Feeder (ADF)

### Note

- The original might become dirty if it is written with a pencil or similar tools.
- Do not place any foreign objects on the document feeder (ADF) or cover it with your hand.

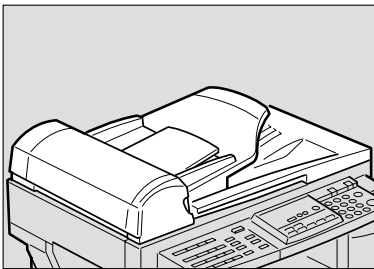

ZFOP430E

### Reference

Regarding originals that the document feeder (ADF) can handle, see p.10 "Originals".

**1** Adjust the guide to the original size.

**2** Place the aligned originals face up into the document feeder (ADF).

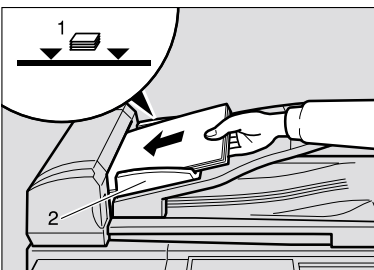

ZFOP440E

1. Limit mark
2. Document guide

### Note

- Do not stack originals above the limit mark.
- To avoid a multi-sheet feed, shuffle the originals before setting them in the document feeder (ADF).

## Placing Standard Size Originals

### Note

- When the copy paper size and the original size differ, follow the steps below.

**1** Press the **[Menu]** key.

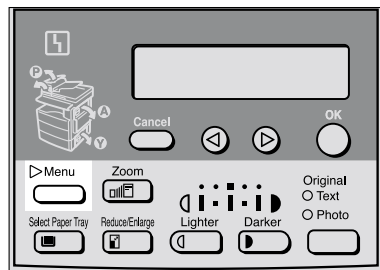

ZFC0850N

**2** Press the **[Left]** or **[Right]** key to select "3. Original Size", and then press the **[OK]** key.

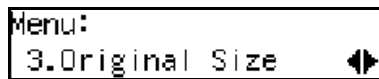

### Note

- You can also enter this mode by pressing the **[R/#]** key.
- When the bypass tray is selected, the **[R/#]** key does not work to enter this mode.



- 3** Make sure that "Standard Size" is selected, and then press the **[OK]** key.

Original Size: ◀▶/OK  
[Standard Size]

**Note**

- If not, press the ◀ or ▶ key to select it.

- 4** Press the ◀ or ▶ key to select original size, and then press the **[OK]** key.

Standard Size: ◀▶/OK  
[A5]

- 5** Press the **[Select Paper Tray]** key to select your desired tray.

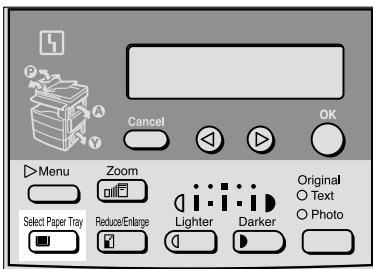

**Note**

- Select the same size and direction copy paper as the original.

- 6** Press the **[Start]** key.

## Placing Custom Size Originals

### Limitation

- Enter the size of your original if it is not one of the following: A4, A5, 8<sup>1</sup>/<sub>2</sub>" × 14", 8<sup>1</sup>/<sub>2</sub>" × 13", 8<sup>1</sup>/<sub>2</sub>" × 11", 5<sup>1</sup>/<sub>2</sub>" × 8<sup>1</sup>/<sub>2</sub>", 8" × 13", 8<sup>1</sup>/<sub>4</sub>" × 13", 8<sup>1</sup>/<sub>4</sub>" × 14"
- For exposure glass, the paper size that can be set with this function is vertical 105–216mm, 4.1"–8.5", horizontal 128–297mm, 5"–11"
- For document feeder (ADF), the paper size that can be set with this function is vertical 140–216mm, 5.5"–8.5", horizontal 140–356mm, 5.5"–14"
- For exposure glass, the maximum copy paper size is 210 × 297mm, 8<sup>1</sup>/<sub>2</sub>" × 11"
- For document feeder (ADF), the maximum copy paper size is 216 × 356mm, 8<sup>1</sup>/<sub>2</sub>" × 14"

- 1** Place one original face down on the exposure glass or face up into the document feeder (ADF).

- 2** Press the **[Menu]** key.

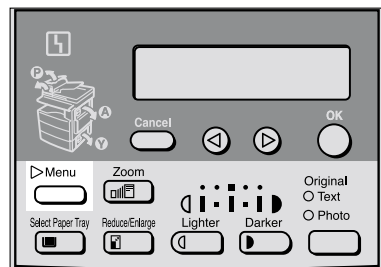

2

- Press the **⏪** or **⏩** key to select "3. Original Size", and then press the **[OK]** key.

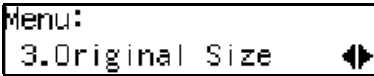

**Note**

- You can also enter this mode by pressing the **[R/#]** key.

- Press the **⏪** or **⏩** key to select "Custom Size", and then press the **[OK]** key.

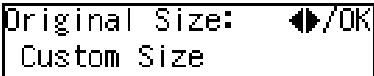

- Enter the horizontal size of the original with the number keys, and then press the **[OK]** key.

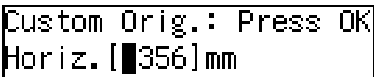

- Enter the vertical size of the original with the number keys, and then press the **[OK]** key.

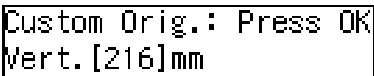

- Press the **[Select Paper Tray]** key to select your desired paper tray.

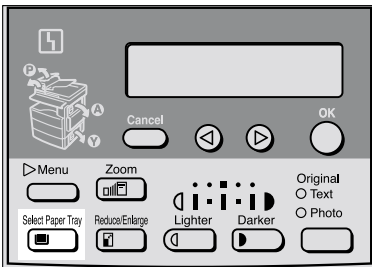

ZF05860N

- Press the **[Start]** key.

# Basic Functions

## Note

- ❑ You can select functions to be activated when System Reset is turned on, when Energy Saver is turned off, or after the machine is powered on. See p.56 “Settings You Can Change with the User Tools”.
- ❑ You can change default settings for basic functions. See p.56 “Settings You Can Change with the User Tools”.

## Adjusting Copy Image Density

You can adjust the copy image density to match your originals.

If you require darker or lighter copies, adjust the image density yourself.

- 1 Press the **[Lighter]** or **[Darker]** key to adjust the image density.

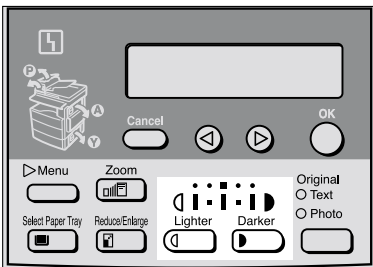

ZF0S870N

## Selecting an Original Type

There are two ways to match your originals:

### ❖ Text

If you do not select either mode, your originals will be scanned with the settings suitable for text originals with this mode.

### ❖ Photo

Delicate tones of photographs and pictures can be reproduced with this mode.

## Note

- ❑ You can change the detailed settings for Text and Photo each with the User Tools. See p.56 “Settings You Can Change with the User Tools”.

- 1 Press the **[Original]** key, and then select the original type.

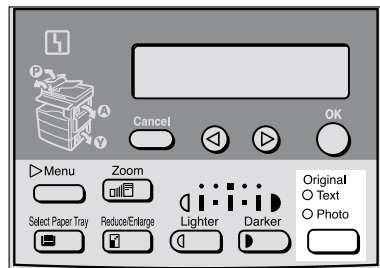

ZF0S880N

## Note

- ❑ Press the **[Original]** key to step through the following types:

Upper indicator lit	Text
Lower indicator lit	Photo

## Selecting Copy Paper

You can manually select the paper tray for the paper size you wish to use.

2

- 1 Select the paper tray or bypass tray by pressing the **[Select Paper Tray]** key.

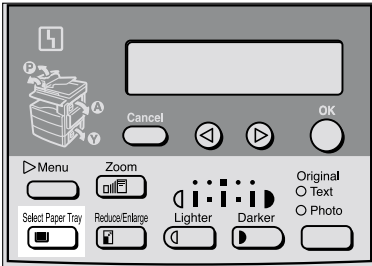

ZFOS860N

# Sort

The optional 32MB copier memory unit is required to use this function.

The machine can scan your originals into memory and automatically sort the copies.

## ⚠ Limitation

- The maximum paper length for the sort function is 356 mm.

## 📝 Note

- The maximum tray capacity is as follows. When the number of copies exceeds the tray capacity, remove copies from the tray.

### ◆ Metric version

Internal tray	<ul style="list-style-type: none"> <li>• A4 or smaller: 250 sheets (80g/m<sup>2</sup>)</li> </ul>
---------------	---

### ◆ Inch version

Internal tray	<ul style="list-style-type: none"> <li>• 8<sup>1</sup>/<sub>2</sub>" × 11" or smaller: 250 sheets (20 lb)</li> </ul>
---------------	--

- The maximum tray capacity might also be reduced when copy paper is considerably curled.

## Sort

Copies can be assembled as sets in sequential order.

### ◆ Sort

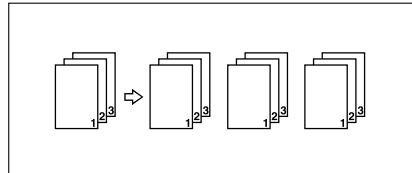

CP160-A

### 1 Press the **[Menu]** key.

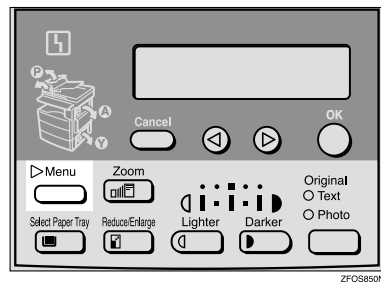

ZFC08850N

### 2 Select "2. Sort" with the **⏪** or **⏩** key, and then press the **[OK]** key.



### 3 Select "Sort" with the **⏪** or **⏩** key, and then press the **[OK]** key.



#### 4 Enter the number of copy sets with the number keys.

##### Note

- The maximum number of sets is 99. You can change the default number with "1. Max. Copy Q'ty" in the copier features. See p.56 "Settings You Can Change with the User Tools".
- To change the number entered, press the **[Clear/Stop]** key and enter the new number.

#### 5 Place your originals.

---

When loading originals in the document feeder (ADF)

---

##### 1 Load your originals in the document feeder (ADF), and then press the **[Start]** key.

##### Note

- The last page should be on the bottom.
- If an original is misfed, place your originals in the document feeder (ADF) again according to the instruction on the display.

---

When placing an original on the exposure glass

---

##### 1 Place the original, and then press the **[Start]** key.

##### 2 Place the next original, and then press the **[Start]** key.

##### Note

- Place the original in the same direction as the first one.
- 3 After all originals are scanned, press the **[R/#]** key.  
The copies are delivered to the tray.

# Copying from the Bypass Tray

Use the bypass tray to copy onto OHP transparencies, adhesive labels, translucent paper, postcards, envelopes, and copy paper that cannot be set in the paper tray.

## Note

- ☐ If you do not use standard size copy paper, you should enter vertical and horizontal dimensions. The sizes that you can enter are as follows:

Metric version	<ul style="list-style-type: none"> <li>• Vertical: 90 – 216mm</li> <li>• Horizontal: 140 – 356 mm</li> </ul>
Inch version	<ul style="list-style-type: none"> <li>• Vertical: 3.5" – 8.5"</li> <li>• Horizontal: 5.5" – 14"</li> </ul>

## Reference

For details about paper capacity in the bypass tray, see p.12 "Copy Paper".

## 1 Open the bypass tray.

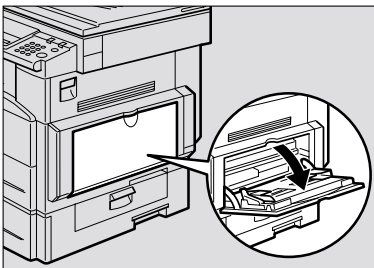

ZFOY260E

## 2 Push up the paper guide release lever.

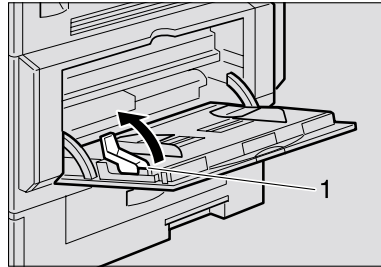

ZFOY310E

## 1. Paper guide release lever

## 3 Gently insert the copy paper face down and adjust the paper guides.

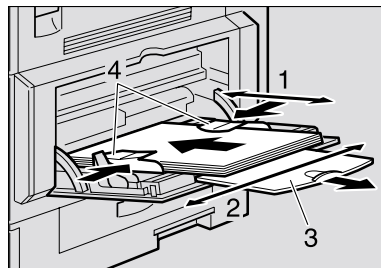

ZFOY250E

## 1. Horizontal size

## 2. Vertical size



## 3. Extender

## 4. Paper guides

## Important

- ☐ If the guides are not flush with the copy paper, a skew image or paper misfeeds might occur.

**Note**

- ❑ Set the direction of the copy paper to .
- ❑ Swing out the extender to support paper sizes larger than A4 , 8 1/2" x 14" .
- ❑ Fan paper to get air between the sheets and avoid a multi-sheet feed.

**Reference**

For details about how to set the copy paper, see p.28 "When copying onto OHP transparencies", p.29 "When copying onto standard size paper", p.29 "When copying onto custom size copy paper" or p.30 "When copying onto envelopes".

- 4** Push down the paper guide release lever.

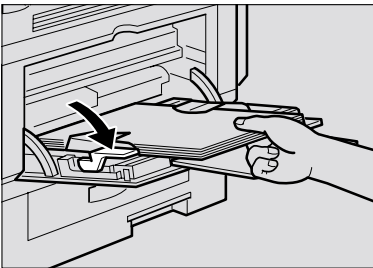

**Note**



- ❑ If you set A4, 8 1/2" x 14" or larger copy paper, hold the edge of the paper and push down the paper guide release lever.
- ❑ If you do not push down the paper guide release lever, a mis-feed might occur.
- ❑ You can specify the type of paper used for the bypass tray. See "6. Bypass Paper Type" in p.56 "Copier Features"

- 5** Place your originals, and then press the **[Start]** key.

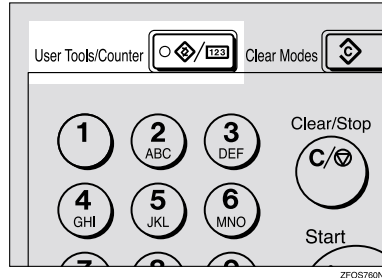

## When copying onto OHP transparencies

- 1** Press the **[User Tools/Counter]** key.





- 2** Press the  or  key to display "3. Copier Features", and then press the **[OK]** key.



- 3** Press the  or  key to display "6. Bypass Paper Type", and then press the **[OK]** key.



- 4** Press the  or  key to display "Special/OHP", and then press the **[OK]** key.



- 5** Press the **[User Tools/Counter]** key to exit from the user tools.



- 6 Gently insert the OHP transparencies face down and adjust the paper guide.

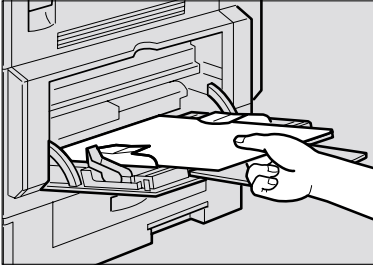

ZFOY330E

**Important**

- The side of OHP transparencies that is copied is fixed. Before you place the OHP transparencies in the bypass tray, check the cutting position of the OHP transparencies.

## When copying onto standard size paper

**Important**

- You should specify the size of paper to avoid paper misfeeds.

**Note**

- The default copy paper size for the paper tray, the optional paper tray unit and the bypass tray is A4, 8 1/2" x 11"

- 1 Press the **[R/#]** key.

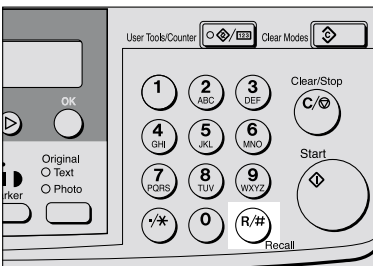

ZFOS102A

- 2 Make sure that "Standard Size" is selected, and then press the **[OK]** key.

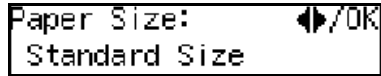

**Note**

- If not, press the **[Left]** or **[Right]** key to select it.

- 3 Press the **[Left]** or **[Right]** key to select paper size, and then press the **[OK]** key.

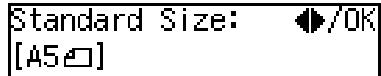

## When copying onto custom size copy paper

**Important**

- You should specify the size of paper to avoid paper misfeeds.

- 1 Press the **[R/#]** key.

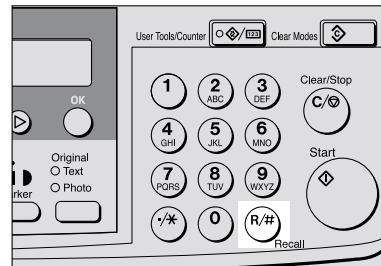

ZFOS102A

- 2 Press the **[Left]** or **[Right]** key to select "Custom Size", and then press the **[OK]** key.

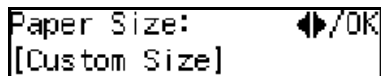

- Enter the horizontal size of the paper with the number keys, and then press the **[OK]** key.

```
Custom Size: Press OK
Horiz. [ 356]mm
```

**Note**

- To change the number entered, press the **[Clear/Stop]** key, and then enter the new number.

- Enter the vertical size of the paper with the number keys, and then press the **[OK]** key.

```
Custom Size: Press OK
Vert. [216]mm
```

**Note**

- To change the number entered, press the **[Clear/Stop]** key, and then enter the new number.

## When copying onto envelopes

**Note**

- Set the direction of the envelope to 

**Reference**

For details about envelopes, see p.12 "Copy Paper"

- Press the **[User Tools/Counter]** key.

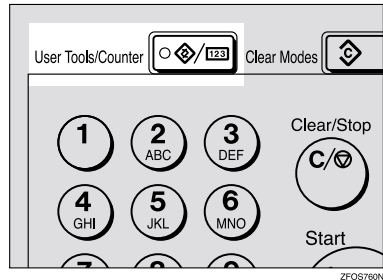

- Press the **[Left Arrow]** or **[Right Arrow]** key to display "3. Copier Features", and then press the **[OK]** key.

```
User Tools:
3.Copier Features
```

- Press the **[Left Arrow]** or **[Right Arrow]** key to display "6. Bypass Paper Type", and then press the **[OK]** key.

```
Copier Features
6.Bypass Paper Type
```

- Press the **[Left Arrow]** or **[Right Arrow]** key to display "Special/OHP", and then press the **[OK]** key.

```
Bypass PaperType: /OK
Special/OHP
```

- Press the **[User Tools/Counter]** key to exit from the user tools.

# Other Functions

## User Codes

When user codes are set, operators must enter their user codes before the machine can be operated. The machine keeps count of the number of copies made under each user code.

### Note

- When user codes are set, the machine will prompt you for your user code after the power switch is turned on or Copy Reset Timer comes into effect.
- To prevent others from making copies using your user code, press the **[Clear Modes]** and **[Clear/Stop]** keys simultaneously after copying.

### Reference

For details about user codes, see p.56 "Settings You Can Change with the User Tools".

## Setting the User Code

- 1** Press the **[User Tools/Counter]** key.

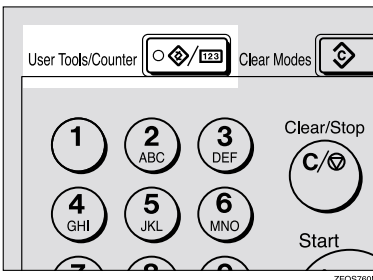

- 2** Press the **[Left Arrow]** or **[Right Arrow]** key to display "3. Copier Features", and then press the **[OK]** key.

```
User Tools:
3.Copier Features
```

- 3** Press the **[Left Arrow]** or **[Right Arrow]** key until "7. Key Op. Tools" is displayed, and then press the **[OK]** key.

```
Copier Features
7.Key Op. Tools
```

- 4** Press the **[Left Arrow]** or **[Right Arrow]** key until "7. Program User Code" is displayed, and then press the **[OK]** key.

```
Key Op. Tools:
7.Program User Code
```

- 5** Enter the desired user code with the number keys, and then press the **[OK]** key.

```
Program User Code: /OK
[12345678] (01/10)
```

## Auto Start

If you press the **[Start]** key during the warm-up period, the **[Start]** key will blink and your copies will be made as soon as warm-up finishes.

- 1** Make any adjustments to copy settings during the warm-up period.
- 2** Place your originals.
- 3** Press the **[Start]** key.

The **[Start]** key indicator flashes green.

### Note

- To cancel Auto Start, press the **[Clear/Stop]** key.

# Preset Reduce/Enlarge

You can select a preset ratio for copying.

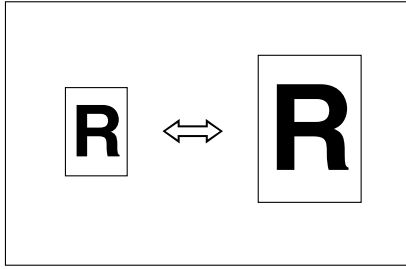

CPPT100

### Note

- You can select one of 5 preset ratios (2 enlargement ratios, 3 reduction ratios).
- You can change the preset ratios to other ratios you frequently use. See "3. Set Ratio" in p.56 "Copier Features".
- You can select a ratio regardless of the size of an original or copy paper. With some ratios, parts of the image might not be copied or margins will appear on copies.
- Copies can be reduced or enlarged as follows:

### ◆ Metric version

Ratio (%)	Original → Copy paper size
200 (enlarge area by 4)	A6→A4
141 (enlarge area by 2)	A5→A4
100	Full Size
93	A little reduced. (Create Margin)
71 (reduce area by 1/2)	A4→A5
50 (reduce area by 1/4)	A4→A6

### ◆ Inch version

Ratio (%)	Original → Copy paper size
155 (enlarge area by 2)	5 <sup>1</sup> / <sub>2</sub> " × 8 <sup>1</sup> / <sub>2</sub> " → 8 <sup>1</sup> / <sub>2</sub> " × 14"
129	5 <sup>1</sup> / <sub>2</sub> " × 8 <sup>1</sup> / <sub>2</sub> " → 8 <sup>1</sup> / <sub>2</sub> " × 11"
100	Full Size
93	A little reduced. (Create Margin)
78	8 <sup>1</sup> / <sub>2</sub> " × 14" → 8 <sup>1</sup> / <sub>2</sub> " × 11"
65 (reduce area by 1/4)	8 <sup>1</sup> / <sub>2</sub> " × 11" → 5 <sup>1</sup> / <sub>2</sub> " × 8 <sup>1</sup> / <sub>2</sub> "

**1** Press the **[Reduce/Enlarge]** key.

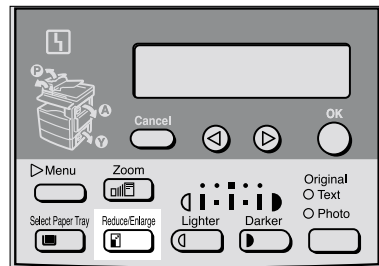

ZFCS900N

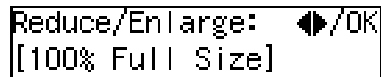

**2** Press the **[Reduce/Enlarge]** key or the **⏪** or **⏩** key until the desired reduce/enlarge size is displayed.

### Note

- The ratio displayed changes every time you press the **[Reduce/Enlarge]** key or the **⏪** or **⏩** key.

**3** Press the **[OK]** key.

**4** Place your originals, and then press the **[Start]** key.

 **Note**

- When the copy paper size and the original size differ, set the original size. See p.20 "Placing Standard Size Originals"

## Zoom

You can change the reproduction ratio in 1% steps.

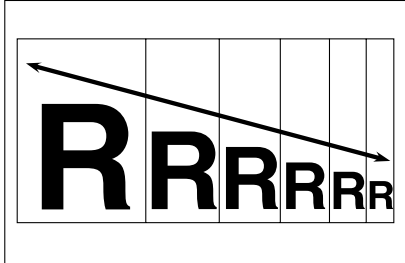

CP220100

### Note

- You can change the reproduction ratio from 50–200%.
- You can select a ratio regardless of the size of an original or copy paper. With some ratios, parts of the image might not be copied or margins will appear on copies.
- You can select a preset ratio which is near the desired ratio, and then adjust the ratio with the ◀ or ▶ key.

### 1 Press the **[Zoom]** key.

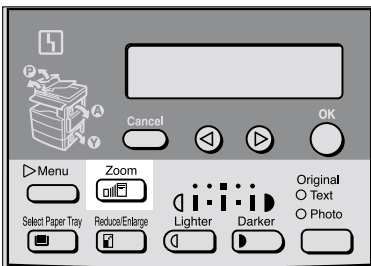

ZF05910N

### 2 Enter the ratio.

When using the ◀ or ▶ key

- 1 Enter the desired reproduction ratios with the ◀ or ▶ key.



### Note

- To change the ratio in 1% steps, just press the ◀ or ▶ key. To change the ratio in 10% steps, press and hold down the ◀ or ▶ key.
- To change the ratio entered, press the **[Clear/Stop]** key, and then enter the new ratio.

When using the number keys

- 1 Enter the desired ratio with the number keys.

### Note

- To change the ratio entered, press the **[Clear/Stop]** key, and then enter the new ratio.

### 3 Press the **[OK]** key.

### 4 Place your originals, and then press the **[Start]** key.

### Note

- When you place originals in the document feeder, set the original size. See p.20 “Placing Standard Size Originals”

# Combine

Use this feature to combine two original images onto one page.

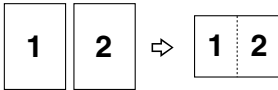

Combine1

## ◆ Portrait (📄) originals

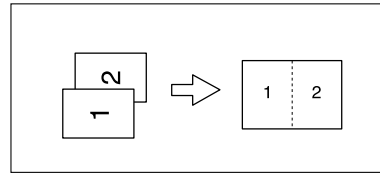

GCC0610E

## ◆ Landscape (📄) originals

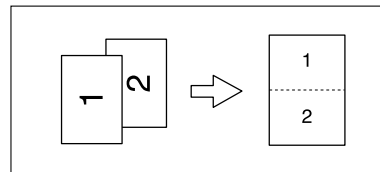

GCC0620E

### ⚠ Limitation

- ❑ The machine cannot copy originals different in size and direction.

### 📝 Note

- ❑ A5, 5<sup>1</sup>/<sub>2</sub>" × 8<sup>1</sup>/<sub>2</sub>" 📄 copy paper cannot be combined.
- ❑ The number of originals copied (combined) can be 2.
- ❑ In this mode, the machine selects the reproduction ratio automatically. This reproduction ratio depends on the copy paper size and the original size.
- ❑ You can change the reproduction ratio from 50–200%.
- ❑ If the calculated ratio is under the minimum ratio, it is corrected within the range of the ratio automatically. However, with some ratios, parts of the image might not be copied or blank margins appear on copies.
- ❑ When the number of originals placed is less than the number specified for combining, the last page(s) will be copied blank.
- ❑ Direction of the originals and arrangement of combined images.

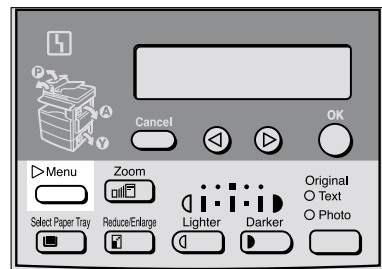

## 1 Press the [Menu] key.

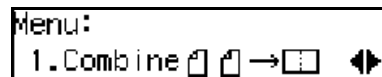

ZF08580N

## 2 Make sure that "1. Combine 📄 📄 → 📄" is selected, and then press the [OK] key.



- 3** Select “  → ” with the **⏪** or **⏩** key, and then press the **[OK]** key.

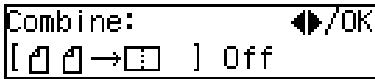

**Note**

- You can specify the orientation of originals. See “5. Orig. Orientation” in the Copier Features in p.56 “Settings You Can Change with the User Tools”

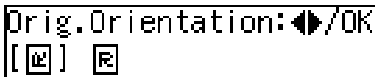

- 4** Press the **[Select Paper Tray]** key to select the copy paper.

- 5** Place your originals.

**Note**

- Set the direction of the original to .

---

When placing an original on the exposure glass

---

- 1** Place the original, and then press the **[Start]** key.
- 2** Place the next original, and then press the **[Start]** key.

**Note**

- To finish copying, press the **[R/#]** key to eject the copy.
- 

When loading originals in the document feeder (ADF)

---

- 1** Load your originals, and then press the **[Start]** key.



# Combination Chart

The combination chart given below shows which modes can be used together. When you read the chart, please refer to the following table.

☆	means that these modes can be used together.
→	means that these modes cannot be used together. The mode after you select will be the mode you're working in.
×	means that these modes cannot be used together. The mode before you select will be the mode you're working in.

2

The following shows the combinations of functions.

Mode after you select	Custom Originals	Copying from the Bypass Tray	Image Density	Text Originals	Photo Originals	Zoom	Preset Reduce/Enlarge	Combine	Sort
Mode before you select									
Custom Originals	-	☆	☆	☆	☆	☆	☆	☆	☆
Copying from the Bypass Tray	☆	-	☆	☆	☆	☆	☆	☆	☆
Image Density	☆	☆	-	☆	☆	☆	☆	☆	☆
Text Originals	☆	☆	☆	-	→	☆	☆	☆	☆
Photo Originals	☆	☆	☆	→	-	☆	☆	☆	☆
Zoom	☆	☆	☆	☆	☆	-	→	→	☆
Preset Reduce/Enlarge	☆	☆	☆	☆	☆	→	-	→	☆
Combine	☆	☆	☆	☆	☆	☆	☆	-	☆
Sort	☆	☆	☆	☆	☆	☆	☆	☆	-



# 3. Troubleshooting

## Machine Operation Problems

### General

Machine's Condition	Problem/Cause	Action
The machine instructs you to wait.	The machine is warming up.	Wait for the machine to warm-up.  <b>Reference</b> You can use Auto Start mode during the warm-up period. See p.31 "Auto Start".
You cannot enter the desired copy set number.	The number of copies exceeds the maximum copy quantity.	You can change the maximum copy quantity that you can make at a time. See "1. Max. Copy Q'ty" in p.56 "Copier Features".
The machine instructs you to enter the user code (8-digit number).	User codes are set.	Enter the user codes. See p.31 "User Codes".

### Display

Problem	Cause	Action
The panel display is off.	The machine is in Energy Saver mode.	Turn on the operation switch. See p.1 "Guide to Components"
	The operation switch is turned off.	
	The main power switch is turned off.	Turn on the main power switch. See p.1 "Guide to Components"
	The power cord is unplugged.	Make sure that the power cord is plugged into the wall outlet firmly.
Nothing happens when the operation switch is turned on.	The main power switch is turned off.	Turn on the main power switch. See p.1 "Guide to Components".
	The power cord is unplugged.	Make sure that the power cord is plugged into the wall outlet firmly.

# Cannot Make Clear Copies

3

Problem	Cause	Action
Copies appear dirty.	The image density is too dark.	Adjust the image density. See p.23 "Adjusting Copy Image Density".
The reverse side of an original image is copied.	The image density is too dark.	Adjust the image density. See p.23 "Adjusting Copy Image Density".
A shadow appears on copies if you use the pasted originals.	The image density is too dark.	Adjust the image density. See p.23 "Adjusting Copy Image Density".
		Change the original direction.
		Put mending tape on the pasted part.
The same copy area is dirty whenever making copies.	The exposure glass, exposure glass cover, or document feeder (ADF) white sheet is dirty.	Clean them. See p.63 "Maintaining Your Machine".
When copying with the document feeder (ADF), black lines appear in a copy.	Your document feeder (ADF) might be dirty.	Clean the document feeder (ADF) with a cloth. See p.63 "Maintaining Your Machine".
Copies are too light.	The image density is too light.	Adjust the image density. See p.23 "Adjusting Copy Image Density".
	Damp or rough grain paper is used.	Use dry paper without rough grain.
	Toner cartridge is almost empty.	Add toner. See p.44 "Changing the Toner Cartridge".
Parts of the image are not copied.	The original is not placed correctly.	Place originals correctly. See p.19 "Placing Originals".
	An improper paper size is selected.	Select the proper paper size.
Copies are blank.	The original is not placed correctly.	Place originals correctly. See p.19 "Placing Originals".
	The side of the original placed is incorrect.	Place originals correctly.
A moire pattern is produced on copies.	Your original has a dot pattern image or many lines.	Change the original direction.
 <p style="text-align: center; font-size: small;">CP268</p>		

# Cannot Make Desired Copies

Problem	Cause	Action
Misfeeds occur frequently.	Copy paper size setting is not correct.	Set the proper paper size. See p.48 "Changing the Paper Size" or p.27 "Copying from the Bypass Tray".
You cannot combine several functions.	Selected functions cannot be used together.	Refer to the combination chart. See p.37 "Combination Chart".

3

## Combine

Problem	Cause	Action
Parts of the image are not copied.	The original size and the copy paper size do not match.	Set the original size and the copy paper size correctly. See p.20 "Placing Standard Size Originals"
	Your originals are not identical in size and direction.	Use originals that are identical in size and direction.
Order of copies is not correct.	You placed originals in an incorrect order.	When loading originals in the document feeder (ADF), the last page should be on the bottom.
		If you place an original on the exposure glass, start with the first page to be copied.

# 4 Loading Paper

**Note**

- If you want to change the paper size, see p.48 "Changing the Paper Size".

**Reference**

Regarding paper types and sizes that can be used, see p.12 "Copy Paper".

- 1** Make sure that the paper tray is not being used.
- 2** Pull out the paper tray until it stops.
- 3** Push the metal plate down, and then square the paper and load it in the tray.

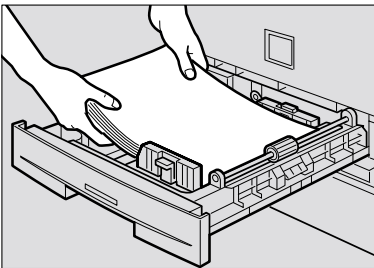

ZFOY280E

**Important**

- Do not stack paper over the limit mark.

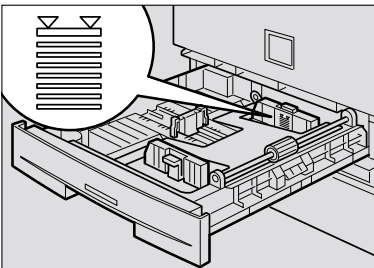

ZFOY300E

- If paper is left in the paper tray and then you add paper, a misfeed might occur.

**Note**

- Shuffle the paper before setting it in the tray.

- 4** Push the paper tray in until it stops.

## Loading paper in the optional paper tray unit

- 1** Make sure that the optional paper tray unit is not being used.
- 2** Pull out the paper tray until it stops.
- 3** While pinching the release lever, adjust the back fence and side fences.
- 4** Push the metal plate down, and then square the paper and load it in the tray.

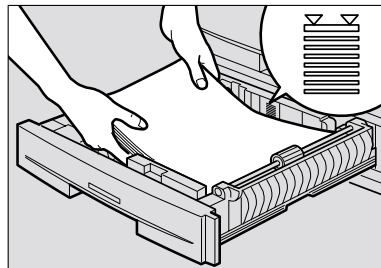

ZFOY290E

**Important**

- If paper is left in the paper tray and then you add paper, a misfeed might occur.
- Do not stack paper over the limit mark.
- Load paper so that the paper touches the right side of the tray, or misfeeds might occur.

 **Note**

- Shuffle the paper before loading it in the tray.
- If the paper is curled, load the paper up side down.

**5** **Readjust the back fence and side fences.** **Important**

- When loading small quantities of copy paper, be careful not to squeeze in the side fence too much or paper will not be fed properly.

**6** **Push the paper tray in until it stops.**

## ⚡ Changing the Toner Cartridge

When ⚡ is displayed, it is time to supply toner.

**⚠ WARNING:**

- *Do not incinerate used toner or toner containers. Toner dust might ignite when exposed to an open flame. Dispose of used toner containers in accordance with local regulations for plastics.*

**⚠ CAUTION:**

- *Keep toner (used or unused) and toner containers out of reach of children.*

**⚠ CAUTION:**

- *Our products are engineered to meet high standards of quality and functionality, and we recommend that you only use the expendable supplies available at an authorized dealer.*

3

**🔧 Important**

- If you use toner other than that recommended, a fault might occur.
- When adding toner, do not turn off the power switch. If you do, your settings are cleared.
- Always add toner after the machine instructs you to add toner.

**📝 Note**

- You can still make about 50 copies after the ⚡ symbol is lit and “Toner is Almost Empty” is displayed, but replace the toner early to prevent poor copy quality.

**🔍 Reference**

Regarding toner storage, see p.15 “Toner Storage”.

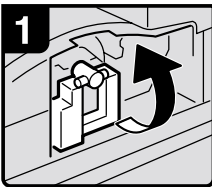

ZFOT130E

- Open the front cover of the machine.
- Lift the green holder.

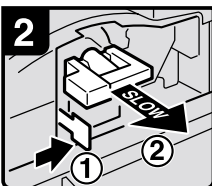

ZFOT140E

- Push the green lever, and then gently pull out the holder.



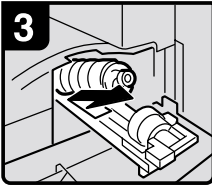

ZFOT150E

- Press the Toner Cartridge backward to raise its head, and then gently pull out the bottle.

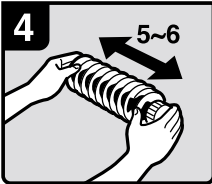

ZFOT160E

- Hold the new bottle horizontally, and then shake it 5 or 6 times.

 **Note**

- Do not remove the black cap when shaking.



ZFOT170E

- Remove the black cap.

 **Note**

- Do not remove the inner cap.

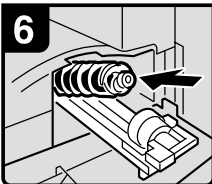

ZFOT180E

- Put the Toner Cartridge on the holder, and then press its head forward.

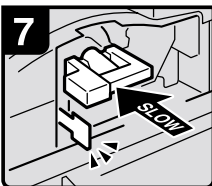

ZFOT190E

- Push the holder in until it clicks.

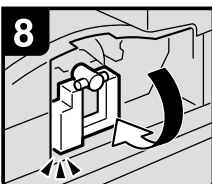

ZFOT200E

- Push down the green holder.
- Close the front cover of the machine.

## 4 Clearing Misfeeds

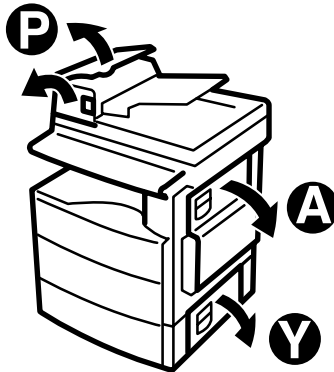

ZFOH210E

### **⚠ CAUTION:**

- *The fusing section of this equipment might be very hot. You should be very careful that you don't touch this section when removing the misfed paper.*

### **⚠ Important**

- When clearing misfeeds, do not turn off the power switch. If you do, your copy settings are cleared.
- To prevent misfeeds, do not leave any torn scraps of paper within the machine.
- If paper misfeeds occur repeatedly, contact your service representative.

### **📝 Note**

- More than one misfed areas may be indicated. In this case, check every applicable area. Refer to the following charts: A, P, Y.
- You can find a sticker explaining how to remove misfed paper inside of the right cover.
- When the machine instructs you to place originals once again, place your originals in the feeding position. The display might indicate the number of originals you should return.

■ When P is lit

<p>1. Open the cover of the document feeder, and then remove the misfed original.</p>	<p>2. While pressing the knob, lift the internal cover of the document feeder.</p>	<p>3. Remove the misfed original.</p>
---	--	---------------------------------------

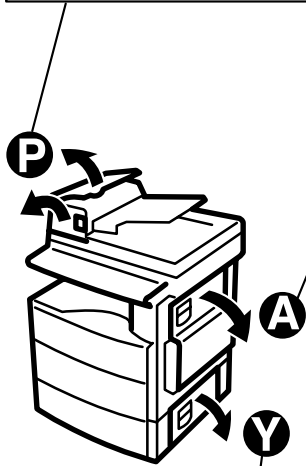

■ When A is lit

<p>1. Open the right cover.</p>	<p>2. Remove the misfed paper.</p>
<p>1. Open the right cover, and then open the blue cover.</p>	<p>2. Remove the misfed paper.</p>

■ When Y is lit

<p>1. Open the lower right cover.</p>	<p>2. Remove the misfed paper.</p>
---------------------------------------	------------------------------------

# Changing the Paper Size

## Important

- ☐ Select the paper size with the user tools, or misfeeds might occur.

## Reference

For paper sizes, weight, and capacity that can be loaded in each tray, see p.12 "Copy Paper".

## Note

- ☐ When you load A4 copy paper, place the back fence in the corner pocket on the left.

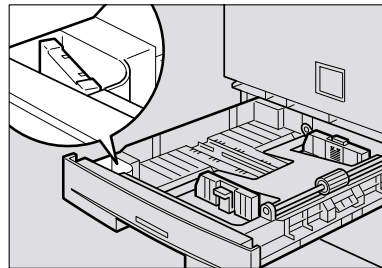

ZFOY640E

## Changing the Paper Size in the Paper Tray

- 1** Make sure that the paper tray is not being used.

- 2** Pull out the paper tray until it stops.

## Note

- ☐ Remove any remaining copy paper.

- 3** Adjust the back fence.

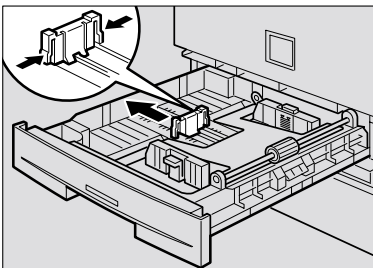

ZFOY630E

- 4** While pressing the release lever, adjust the side fences.

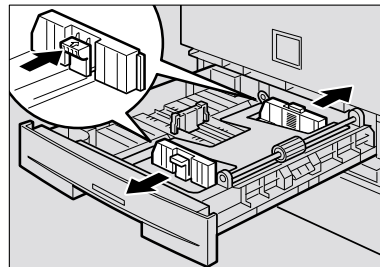

ZFOY240E

- 5** Push the metal plate down.

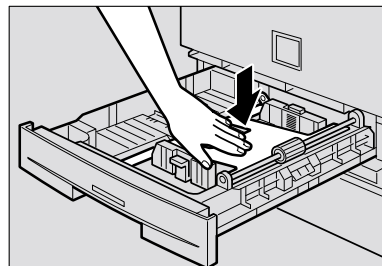

ZFOY340E

- 6** Square the paper and load it in the tray.

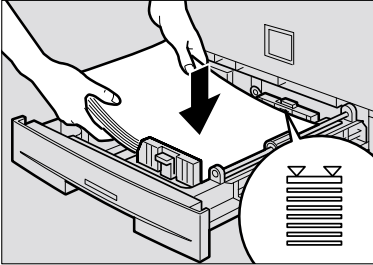

ZFOY360E

### Important

- Do not stack paper over the limit mark.

- 7** Adjust the side and back fences to the new paper size.

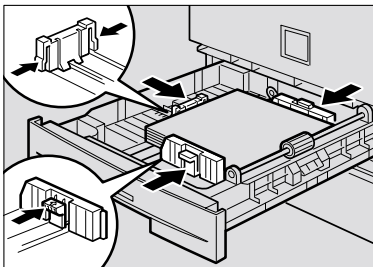

ZFOY360E

### Important

- When setting small quantities of copy paper, be careful not to squeeze in the side fence too much or paper will not be fed properly.

- 8** Push the paper tray in until it stops.

### Note

- Select the new paper size with the User Tools. See p.51 "Selecting the Paper Size with the User Tools".

## Changing the Paper Size in the Optional Paper tray unit

- 1** Make sure that the paper tray is not being used.
- 2** Pull out the paper tray until it stops.

### Note

- Remove any remaining copy paper.

- 3** Adjust the back fence.

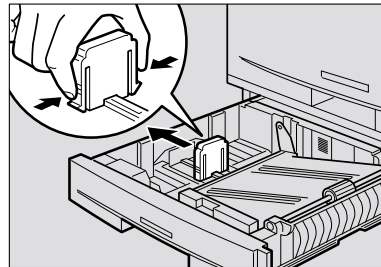

ZFOY370E

### Note

- When you load  $8\frac{1}{4} \times 14$ " or  $8\frac{1}{2} \times 14$ " copy paper, place the back fence in the corner pocket on the left.

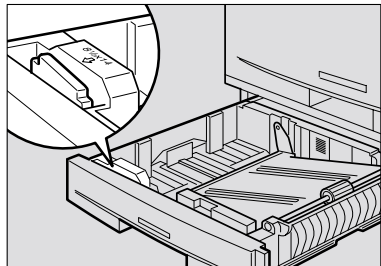

ZFOY650E

- 4** While pressing the release lever, adjust the side fences.

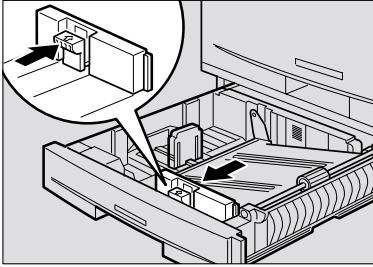

ZFOY380E

- 6** Adjust the side and back fences to the new paper size.

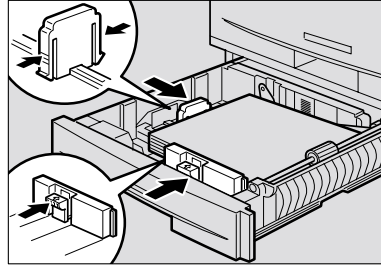

ZFOY400E

- 5** Push the metal plate down, and then square the paper and load it in the tray.

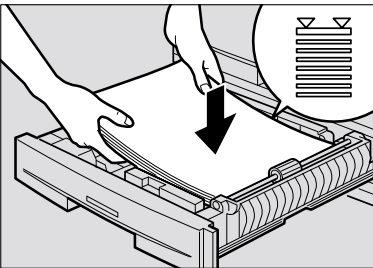

ZFOY380E

**Important**

- Do not stack paper over the limit mark.
- Load paper so that the paper touches the right side of the tray, or misfeeds might occur.

**Note**

- Shuffle the paper before loading it in the tray.

**Important**

- When loading small quantities of copy paper, be careful not to squeeze in the side fence too much or paper will not be fed properly.

- 7** Push the paper tray in until it stops.

**Note**

- Select the new paper size with the User Tools. See p.51 "Selecting the Paper Size with the User Tools".

## Selecting the Paper Size with the User Tools

- 1 Press the **[User Tools/Counter]** key.

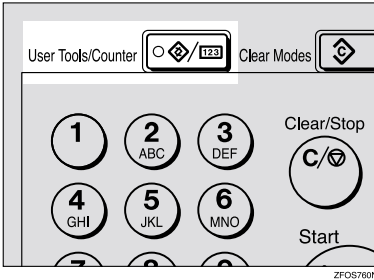

- 2 Press the **[Left]** or **[Right]** key to display "2.System Settings", and then press the **[OK]** key.

```
User Tools:
2.System Settings  [OK]
```

- 3 Press the **[Left]** or **[Right]** key until "8. Tray Paper Size" is displayed, and then press the **[OK]** key.

```
System Settings:
8.Tray Paper Size  [OK]
```

- 4 Press the **[Left]** or **[Right]** key to select the paper tray you want to change the paper size for, and then press the **[OK]** key. When you select "1. Tray 1" or "2. Tray 2", go to step 6.

```
Tray Paper Size: [Left]/[OK]
1.Tray 1
```

- 5 If you have selected "3. Bypass" on step 4, select "Standard Size" or "Custom Size", and then press the **[OK]** key.

```
Bypass [Left]/[OK]
[Standard Size]
```

- 6 Select the desired paper size.

When you have selected "Custom Size" on step 5

- 1 Enter the horizontal size of the paper with the number keys, and then press the **[OK]** key.

```
Custom Size: Press [OK]
Horiz. [140]mm
```

- 2 Enter the vertical size of the paper with the number keys, and then press the **[OK]** key.

```
Custom Size: Press [OK]
Vert. [90]mm
```

- 7 Press the **[User Tools/Counter]** key to exit from the user tools.





# 4. User Tools (Copier Features)

## Accessing the User Tools (Copier Features)

This section is for the key operators in charge of this machine. The user tools allow you to change or set the machine's default settings.

### Preparation

Always exit the user tools when you have finished.

### Reference

For details about how to access the system settings, see "Accessing The User Tools (System Settings)" in the System Settings manual.

For information about the Fax user tools, see the Facsimile Reference manual.

### **1** Press the **[User Tools/Counter]** key.

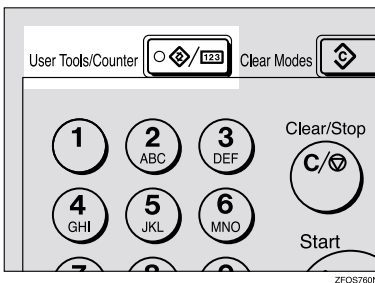

### **2** Press the **[Left Arrow]** or **[Right Arrow]** key to display "3. Copier Features", and then press the **[OK]** key.



### **3** Press the **[Left Arrow]** or **[Right Arrow]** key until desired User Tools menu is displayed, and then press the **[OK]** key.



### **4** Change the settings by following the instructions on the panel display, and then press the **[OK]** key.

### Reference

See p.56 "Settings You Can Change with the User Tools".

### Note

- [OK]** key: Press to make the new settings and return to the previous menu. **[Cancel]** key: Press to return to the previous menu without changing any data.
- The settings are not canceled even if the main power switch is turned off or the **[Clear Modes]** key is pressed.

## Exiting the User Tools

- 1 Press the **【User Tools/Counter】** key.

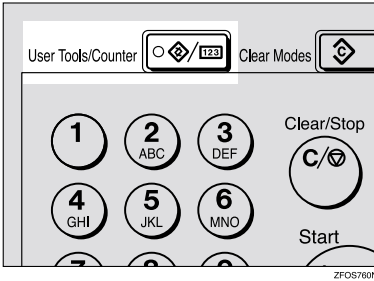

4

### Note

- ❑ You can exit the User Tools mode by pressing the **【Cancel】** key.
- ❑ If you want to return to the previous mode (copy or facsimile), press the **【User Tools/Counter】** key.

# User Tools Menu (Copier Features)

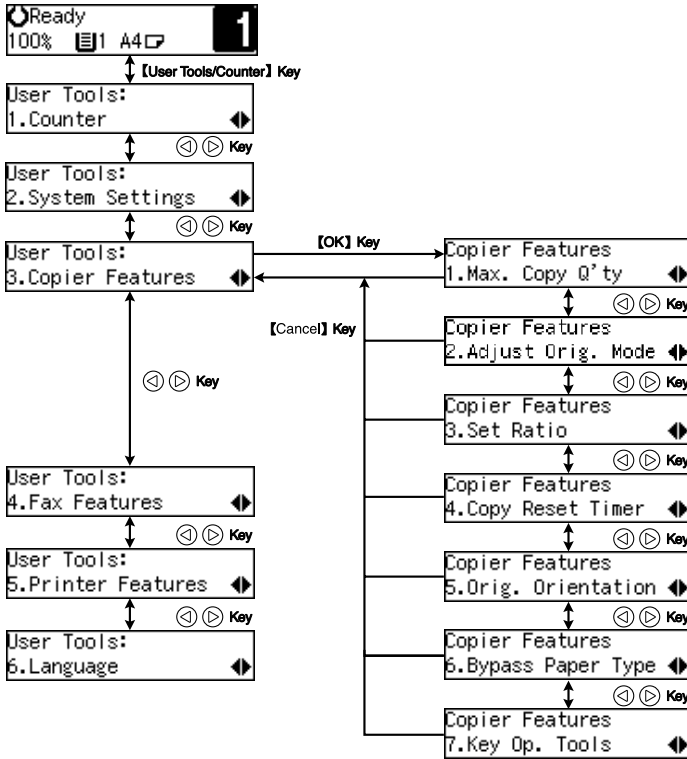



ZF05990E





# Settings You Can Change with the User Tools





## Reference

For details about how to access the user tools, see p.53 “Accessing the User Tools (Copier Features)”.

## Copier Features

Menu	Description
1. Maximum Copy Quantity (1. Max. Copy Q'ty)	<p>The maximum copy quantity can be set between 1 and 99.</p> <p> <b>Note</b></p> <p><input type="checkbox"/> Default: 99</p>
2. Adjust Original Mode	<p>You can adjust the finish quality level of copies depending on the type of the original. You can choose these mode after selecting “1. Text” or “2. Photo”.</p> <ul style="list-style-type: none"> <li>• Text Mode 1 For normal text originals</li> <li>• Text Mode 2 For newspapers, originals through which the rear side is moderately visible with light text</li> <li>• Photo Mode 1 For text/photo images which contain mainly photo areas</li> <li>• Photo Mode 2 For text/photo images which contain mainly text areas</li> <li>• Special Mode 1 For originals with colored text and lines</li> <li>• Special Mode 2 For photo images</li> <li>• Special Mode 3 For normal text originals (when preserving the background)</li> </ul> <p> <b>Note</b></p> <p><input type="checkbox"/> Default:</p> <ul style="list-style-type: none"> <li>• 1. Text: Text Mode 1</li> <li>• 2. Photo: Photo Mode 1</li> </ul>

Menu	Description
3. Set Ratio	<p>Select which Reduce, Enlarge or Input Ratio is shown on the panel display with priority when the <b>【Reduce/Enlarge】</b> key is pressed.</p> <p> <b>Note</b></p> <p><input type="checkbox"/> Default:</p> <ul style="list-style-type: none"> <li>• Ratio 1: 50% A4→A6</li> <li>• Ratio 2: 71% A4→A5</li> <li>• Ratio 3: 93%</li> <li>• Ratio 4: 141% A5→A4</li> <li>• Ratio 5: 200% A6→A4</li> </ul>
4. Copy Reset Timer	<p>The machine returns to its initial condition automatically after your job is finished. When you set the time, select “1. On/Off” to “On” and then set the “2. Timer” to the desired time. The time can be selected from 10 to 999 seconds.</p> <p> <b>Note</b></p> <p><input type="checkbox"/> Default:</p> <ul style="list-style-type: none"> <li>• 1. On/Off: On</li> <li>• 2. Timer: 60 sec.</li> </ul>
5. Orig. Orientation	<p>You can select the orientation of originals with Combine mode.</p> <p> <b>Note</b></p> <p><input type="checkbox"/> Default: <i>Off</i></p>
6. Bypass Paper Type	<p>You can select the type of paper for the bypass tray.</p> <p> <b>Note</b></p> <p><input type="checkbox"/> Default: <i>Thick</i></p>
7. Key Op. Tools	<p>If the machine is set to use the User Code function, operators must enter their user codes before the machine can operate.</p> <p>The machine can keep count of the number of copies made under each user code.</p>
1. User Code Access	<p>Specify whether to employ user codes to restrict copier users, and manage the number of copies made.</p> <p> <b>Note</b></p> <p><input type="checkbox"/> Default: <i>Off</i></p>
2. Check Copy Counter	<p>You can check the number of copies made under each user code.</p>
3. Print Counter List	<p>You can print counter lists.</p>
4. Reset Counter	<p>You can check the number of copies made under each user code. You can also reset each user code's counter to 0.</p>

Menu	Description
5. Clear all User Codes (5. Clr All User Codes)	You can clear all user codes.  <b>Note</b> <input type="checkbox"/> The number of copies made under the old code is added to that made under the new user code. <input type="checkbox"/> The number of copies made under the deleted code is also deleted.
6. Reset All Counters	You can reset each user code's counter to 0.
7. Program User Code	You can register user codes.  <b>Note</b> <input type="checkbox"/> Up to 10 user codes (8 digits or less) can be registered.
8. Change User Code	You can change user codes.  <b>Note</b> <input type="checkbox"/> The number of copies made under the old code is added to that made under the new user code.
9. Delete User Code	You can delete user codes.  <b>Note</b> <input type="checkbox"/> The number of copies made under the deleted code is also deleted.

## Do's and Don'ts

### **CAUTION:**

- *Unplug the power cord from the wall outlet before you move the equipment. While moving the equipment, you should take care that the power cord will not be damaged under the equipment.*

### **Important**

- Make sure the remaining memory space is 100%, before you unplug the power cord.
- While the machine is unplugged, you can neither send nor receive a fax.

### **Reference**

For details, see the Facsimile Reference manual.

- When you use this machine for a long time in a confined space without good ventilation, you may notice an odd smell. To keep the workplace comfortable, we recommend that you keep it well ventilated.
- Do not touch areas on or around the fusing unit. These areas get hot.
- After making copies continuously, you may feel the exposure glass is heated. This is not a malfunction.
- You may feel warm around the ventilation hole. This is caused by exhaust air, and is not a malfunction.
- Do not turn off the operation switch while copying or printing. When turning off the operation switch, copying with memory and printing continue. However, scanning of copy originals is interrupted.
- The machine might fail to produce good copy images if condensation forms inside the machine due to temperature change.
- Do not open the covers of the machine while copying or printing. If you do, misfeeds might occur.
- Do not move the machine while copying or printing.
- If you operate the machine improperly or a failure occurs, your settings might be lost. Be sure to take a note of your machine settings.
- Supplier shall not be liable for any loss or damages resulting from a failure on the machine, loss of machine settings, and use of the machine.

# Where to Put Your Machine

## Machine Environment

Your machine's location should be carefully chosen because environmental conditions greatly affect its performance.

### Optimum environmental conditions

#### **⚠ CAUTION:**

- *Keep the equipment away from humidity and dust. Otherwise a fire or an electric shock might occur.*
- *Do not place the equipment on an unstable or tilted surface. If it topples over, it could cause injury.*

#### **⚠ CAUTION:**

- *Before moving the equipment, be sure to pull all four handles fully out. Not doing this may result in an injury, such as getting your fingers pinched. After moving the equipment, return the four handles to their original positions.*
- *When the optional paper tray unit is installed, do not push the upper part of the main unit horizontally. If the paper tray unit becomes detached from the main unit, this could cause an injury.*

#### **⚠ CAUTION:**

- *If you use the equipment in a confined space, make sure there is a continuous air turnover.*
- Temperature: 10 – 32°C (50 – 89.6°F), humidity 54% at 32°C, 89.6°F
- Humidity: 15 – 80%, temperature 27°C, 80.6°F at 80%
- A strong and level base.
- The machine must be level within 5mm, 0.2" both front to rear and left to right.
- To avoid possible build-up of ozone, be sure to locate this machine in a large well ventilated room that has an air turnover of more than 30 m<sup>3</sup>/hr/person.

### Environments to avoid

- Locations exposed to direct sunlight or strong light (more than 1,500 lux).
- Locations directly exposed to cool air from an air conditioner or heated air from a heater. (Sudden temperature changes might cause condensation within the machine.)
- Locations close to such machines generating ammonia such as diazo copy machines.
- Places where the machine might be subjected to frequent, strong vibrations.
- Dusty areas.
- Areas with corrosive gases.



---

## Power Connection

---

**⚠ WARNING:**

- **Only connect the machine to the power source described on the inside front cover of this manual. Connect the power cord directly into a wall outlet and do not use an extension cord.**
- **Do not damage, break or make any modifications to the power cord. Do not place heavy objects on it. Do not pull it hard nor bend it more than necessary. These actions could cause an electric shock or fire.**

**⚠ WARNING:**

- **Unplug the power cord from the wall outlet before you move the equipment. While moving the equipment, you should take care that the power cord will not be damaged under the equipment.**

**⚠ CAUTION:**

- *When you disconnect the power plug from the wall outlet, always pull the plug (not the cable).*
- When the main switch is in the Stand-by position, the optional anti-condensation heaters are on. In case of emergency, unplug the machine's power cord.
- When you unplug the power cord, the anti-condensation heaters turn off.
- Make sure the plug is firmly inserted in the outlet.
- Voltage must not fluctuate more than 10%.
- The socket-outlet shall be installed near the equipment and shall be easily accessible.

## Access to Machine

Place the machine near the power source, providing clearance as shown.

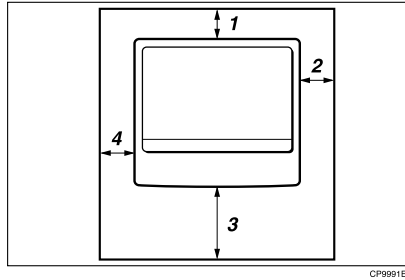

**1. Rear: more than 1cm (0.4")**

**3. Front: more than 75cm (29.6")**

**2. Right: more than 1cm (0.4")**

**4. Left: more than 1cm (0.4")**

### Note

- For information about required space when options are installed, please contact your service representative.

# Maintaining Your Machine

If the exposure glass, exposure glass cover or document feeder (ADF) white sheet is dirty, clean them if you find them dirty.

## ❖ Cleaning the machine

Wipe the machine with a soft, damp cloth. Then wipe it with a dry cloth to remove the water.

## ⚠ Important

- Do not use chemical cleaner or organic solvent such as thinner or benzene. If they get into the machine or melt plastic parts, a failure might occur.
- Do not clean parts other than those specified on this page. Such parts should be cleaned by your service representative.

## Cleaning the Exposure Glass

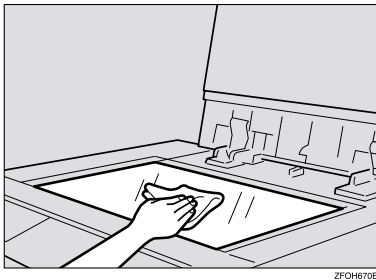

## Cleaning the Exposure Glass Cover



## Cleaning the Document Feeder (ADF)

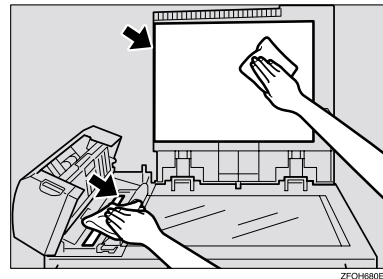



# 6. Specifications

## Mainframe

❖ **Configuration:**

Desktop

❖ **Photosensitivity type:**

OPC drum (Φ30)

❖ **Original scanning:**

One-dimensional solid scanning system through CCD

❖ **Copy process:**

Dry electrostatic transfer system

❖ **Development:**

Dry two-component magnetic brush development system

❖ **Fusing:**

Heating roll system

❖ **Resolution:**

600dpi

❖ **Exposure glass:**

Stationary original exposure type

❖ **Original reference position:**

Rear left corner

❖ **Warm-up time:**

Less than 20 seconds (20°C, 68°F)

❖ **Originals:**

Sheet/book/objects

❖ **Maximum original size:**

- Exposure glass: A4☐, 8<sup>1</sup>/<sub>2</sub>" × 11"☐
- Document feeder (ADF): A4☐, 8<sup>1</sup>/<sub>2</sub>" × 14"☐

❖ **Copy paper size:**

- Paper tray: A4☐, A5☐, 8<sup>1</sup>/<sub>2</sub>" × 11"☐, 5<sup>1</sup>/<sub>2</sub>" × 8<sup>1</sup>/<sub>2</sub>"☐
- Bypass tray: A4☐, A5☐☐, 8<sup>1</sup>/<sub>2</sub>" × 11"☐, 5<sup>1</sup>/<sub>2</sub>" × 8<sup>1</sup>/<sub>2</sub>"☐☐, 8<sup>1</sup>/<sub>2</sub>" × 14"☐, 8" × 13"☐, 8<sup>1</sup>/<sub>2</sub>" × 13"☐, 8<sup>1</sup>/<sub>4</sub>" × 13"☐, 8<sup>1</sup>/<sub>4</sub>" × 14"☐

- Bypass tray (custom size):  
Vertical: 90 – 216mm, 3.5" – 8.5"  
Horizontal: 140 – 356mm, 5.5" – 14"
- Paper tray unit: A4☐, 8<sup>1</sup>/<sub>2</sub>" × 14"☐, 8<sup>1</sup>/<sub>2</sub>" × 13"☐, 8<sup>1</sup>/<sub>4</sub>" × 14"☐, 8<sup>1</sup>/<sub>4</sub>" × 13"☐, 8<sup>1</sup>/<sub>2</sub>" × 11"☐

❖ **Copy paper weight:**

- Paper tray (Standard size): 60 – 90g/m<sup>2</sup> (16 – 24 lb.)
- Bypass tray: 60 – 157g/m<sup>2</sup> (16 – 42 lb.)
- Paper tray unit: 60 – 90g/m<sup>2</sup> (16 – 24 lb.)

❖ **Non-reproduction area:**

- Leading edge: 3 ± 2mm, 0.14" ± 0.08"
- Trailing edge: 3 ± 2mm, , 0.14" ± 0.08"
- Left edge: 2 ± 1.5mm, , 0.08" ± 0.07"
- Right edge: more than 0.5mm, 0.02"

❖ **First copy time:**

8 seconds or less

(A4☐, 8<sup>1</sup>/<sub>2</sub>" × 11"☐ 100%, placing an original on the exposure glass, feeding from the paper tray)

❖ **Copying speed:**

- 13 copies/minute (A4☐, 8<sup>1</sup>/<sub>2</sub>" × 11"☐, feeding from the paper tray or the optional paper tray unit)

❖ **Reproduction ratio:**

Preset reproduction ratios:

--	Metric version	Inch version
Enlargement	200%	155%
	141%	129%
Full Size	100%	100%
Reduction	93%	93%
	71%	78%
	50%	65%

Zoom: from 50% to 200% in 1% step.

❖ **Continuous copying count:**

1 – 99 copies

❖ **Copy paper capacity:**

250 sheets (80g/m<sup>2</sup>, 20 lb)

### ❖ Power consumption:

	Mainframe only	Full system *1
Warm up	About 890W	About 890W
Stand-by	About 90Wh	About 100Wh
During printing	About 480Wh	About 480Wh
Maximum	Less than 1,000W	Less than 1,000W

\*1 Mainframe with the optional document feeder (ADF), paper tray unit.

### ❖ Dimensions (W × D × H up to exposure glass):

- Type 1: 468 × 450 × 371mm (18.43 × 17.72 × 14.61 inch)
- Type 2: 468 × 450 × 461mm (18.43 × 17.72 × 18.15 inch)

### ❖ Noise Emission \*1 :

- Sound power level

	Mainframe only	Complete System *3
Stand-by	40.0dB (A)	40.0dB (A)
During printing	62.0dB (A)	66.0dB (A)

- Sound pressure level \*2

	Mainframe only	Complete System *3
Stand-by	27.0dB (A)	27.0dB (A)
During printing	54.0dB (A)	54.0dB (A)

\*1 The above measurements made in accordance with ISO 7779 are actual value.

\*2 It is measured at the position of the operator.

\*3 The Complete System consists of mainframe with full options.

### ❖ Weight:

- Type 1: Approx. 20kg (44.09 lb.)
- Type 2: Approx. 23kg (50.7 lb.)

### Note







- ❑ Specifications are subject to change without notice.

## Document Feeder (ADF) (Option for Type 1)

❖ **Mode:**

- ADF mode

❖ **Original size:**

- A4  – A5  
- 8<sup>1</sup>/<sub>2</sub>" × 14"  – 5<sup>1</sup>/<sub>2</sub>" × 8<sup>1</sup>/<sub>2</sub>"  

❖ **Original weight:**

- 1-sided originals: 52 – 105g/m<sup>2</sup> (14 – 28 lb.)

❖ **Number of originals to be set:**

- 30 sheets (80g/m<sup>2</sup>, 20 lb.)

❖ **Maximum power consumption:**

- less than 50W (power is supplied from the main frame.)

❖ **Dimensions (W × D × H):**

- 110 × 360 × 95mm (4.3 × 14.2 × 3.8 inch)

❖ **Weight:**

- Approx. 2kg, (4.4 lb.)

 **Note**

- Specifications are subject to change without notice.



## Paper Tray Unit (Option)

❖ **Copy paper weight:**

60 – 90g/m<sup>2</sup> (16 – 24 lb.)

❖ **Available paper size:**

A4, 8<sup>1</sup>/<sub>2</sub>" × 14", 8<sup>1</sup>/<sub>2</sub>" × 13", 8<sup>1</sup>/<sub>4</sub>" × 14", 8<sup>1</sup>/<sub>4</sub>" × 13", 8<sup>1</sup>/<sub>2</sub>" × 11"

❖ **Maximum power consumption:**

15W (power is supplied from the main frame.)

❖ **Paper capacity:**

500 sheets (80g/m<sup>2</sup>, 20 lb)

❖ **Dimensions (W × D × H):**

430 × 414 × 140mm (17.0 × 16.3 × 5.6 inch)

❖ **Weight:**

Approx. 6kg (13.3 lb.)

 **Note**

- Specifications are subject to change without notice.
- For details about the optional anti-condensation heater, contact your service representative.

## 32MB Copier Memory Unit (Option)

- ❖ **Memory capacity:**  
32MB
- ❖ **Additional functions:**  
Increased memory capacity
- ❖ **Number of originals that can be stored: about 99 pages**  
ITU-T No.4 chart

# INDEX

---

32MB Copier Memory Unit, 3, 70

## A

---

Access to Machine, 62  
Adjusting Copy Image Density, 23  
Adjust Original Mode, 56  
Auto Off, 18  
Auto Start, 31

## B

---

Basic Functions, 23  
Bypass Paper Type, 57  
Bypass tray, 2

## C

---

Changing the Paper Size, 48  
Changing the Toner Cartridge, 44  
Clearing Misfeeds, 46  
Combination Chart, 37  
Combine, 35  
Control panel, 2, 4  
Copy display, 6  
Copying from the Bypass Tray, 27  
Copy key, 4  
Copy Paper, 12  
Copy Reset Timer, 57

## D

---

Document feeder (ADF), 3, 20, 63, 68  
Do's and Don'ts, 59

## E

---

Exposure glass, 1, 10, 11, 19, 63  
Exposure glass cover, 1, 63

## F

---

Facsimile key, 4, 9  
Front cover, 2

## I

---

Internal tray, 1

## K

---

Key Op. Tools, 57

## L

---

Loading Paper, 42

## M

---

Machine Environment, 60  
Mainframe, 65  
Main Power indicator, 1  
Main power switch, 1, 7  
Maintaining, 63  
Maximum copy quantity, 56  
Message, 39

## O

---

On indicator, 2  
Operation switch, 2, 7  
Options, 3  
Originals, 10, 19  
Original Type, 23  
Orig.Orientation, 57  
Other Functions, 31

## P

---

Panel Display, 6  
Paper tray, 2  
Paper tray unit, 2, 3, 69  
Power Connection, 61  
Preset Reduce/Enlarge, 32  
Printer key, 4

## R

---

Remarks, 59  
Right cover, 2

## S

---

Safety Information, i  
Selecting an Original Type, 23  
Selecting Copy Paper, 24  
Set Ratio, 57  
Sort, 25  
Specification, 65  
System Reset, 17

## **T**

---

Toner, 15

## **U**

---

User Codes, 31

User Tools, 53

## **V**

---

Ventilation hole, 1

## **Z**

---

Zoom, 34

MEMO

MEMO

## Free Manuals Download Website

<http://myh66.com>

<http://usermanuals.us>

<http://www.somanuals.com>

<http://www.4manuals.cc>

<http://www.manual-lib.com>

<http://www.404manual.com>

<http://www.luxmanual.com>

<http://aubethermostatmanual.com>

Golf course search by state

<http://golfingnear.com>

Email search by domain

<http://emailbydomain.com>

Auto manuals search

<http://auto.somanuals.com>

TV manuals search

<http://tv.somanuals.com>