

RICOH

RICOH FT1008/1208

OPERATOR'S MANUAL

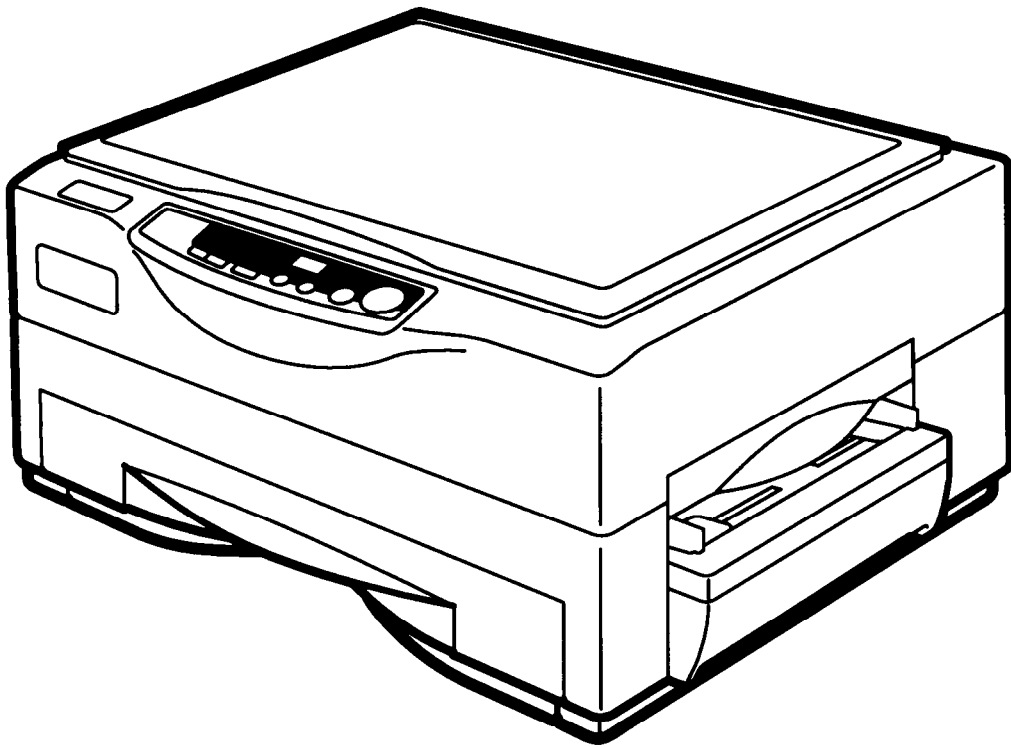

English

Read this manual carefully before you use this product and keep it handy for future reference.
For safety, please follow the instructions in this manual.

Notes: Model names for the machines do not appear in the following pages. Check the type of your machine before reading this manual.

(For details, see pages 8-9.)

Type 1 RICOH FT1008

Type 2 RICOH FT1208

Certain types may not be available in some countries. For details, contact your local dealer.

For good copy quality, Ricoh recommends that you use genuine Ricoh toner.

Ricoh shall not be responsible for any damage or expense that may result from the use of parts and supplies other than genuine Ricoh parts in your Ricoh office product.

Note: Some illustrations may be slightly different from your machine.

Power Source: 220-240 V, 50/60 Hz, 6 A

Please make sure to connect the power cord to a power source as above. For details about power connection, see page 20.

SAFETY INFORMATION

This manual contains detailed instructions for the operation and maintenance of this copier. To ensure maximum versatility from this copier, all operators should carefully read and follow the instructions in this manual. Please keep this manual in a handy place near the copier. Before using this copier, please read the following cautions section. It contains important information related to user safety and the prevention of equipment problems.

ESSENTIAL SYMBOLS

The following essential symbols are used in this manual:



Ignoring this warning could cause serious injury or even death.



Ignoring this caution could cause injury or damage to property.

EXAMPLES OF INDICATIONS



Symbol  means a situation that requires you to take care.











DO NOT carry out the operation represented by the symbol .

This example means “Do not take apart”.









Symbol  means you **MUST** perform this operation. This example means “You must remove the wall plug”.

⚠ WARNINGS

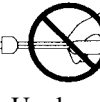
 <p>Power Connection Warning</p>	<p>Only connect the copier to the power source described on the inside front cover of this manual. Avoid multi-wiring as it could cause an electrical shock or fire. Avoid using an extension cord. Make sure the wall outlet is near the copier and freely accessible so that in event of an emergency it can be unplugged easily.</p>	 <p>Damage Warning</p>	<p>If the copier looks damaged or breaks down, smoke is coming out, there is a strange smell or anything looks unusual, immediately turn off the main switch then unplug the power cord from the wall. Do not continue using the copier in this condition. Contact your service representative.</p>
 <p>Power Cord Warning</p>	<p>Do not damage, break or make any modifications to the power cord. Do not place heavy objects on it, pull it hard or bend it more than necessary. These actions could cause an electric shock or fire</p>	 <p>Electrical Shock Warning</p>	<p>Do not put any containers holding metal objects or water (e.g. vases, flower-pots, glasses) on the copier. If the contents fall inside the copier a fire or electric shock could occur.</p>
 <p>Modification Warning</p>	<p>Do not remove any covers or screws other than those specified in this manual. Some parts of the copier are charged with high voltage and could give you an electric shock. When the copier needs to be checked, adjusted or repaired, contact your service representative. Do not take apart or attempt any modifications to this copier. There is a risk of fire, electric shock, explosion or loss of sight.</p>	 <p>Toner Warning</p>	<p>Do not incinerate used toner or toner containers. Toner dust might ignite when exposed to an open flame. Dispose of the used toner containers according to local regulations.</p>
 <p>Foreign Object Warning</p>	<p>If any metal, liquid or foreign matter falls into the copier, turn off the main switch and unplug the main power cord. Contact your service representative. Do not continue using the copier with a fault or defect.</p>	 <p>Electrical Shock Warning</p>	<p>Do not plug or unplug the power cord with wet hands or an electric shock might occur.</p>

⚠ CAUTIONS

 <p>Unplug Caution</p>	<p>When you move the copier, unplug the power cord from the wall outlet to avoid fire or electric shock.</p>	 <p>Unplug Caution</p>	<p>When the copier will not be used for a long time, unplug the power cord.</p>
 <p>Unplug Caution</p>	<p>When you pull out the plug from the socket, grip the plug to avoid damaging the cord and causing fire or electric shock.</p>	 <p>Copier Location Caution</p>	<p>If you use this copier in a confined space, make sure there is a continuous air turnover.</p>
 <p>Copier Location Caution</p>	<p>Keep the copier away from humidity and dust. A fire or an electric shock might occur.</p> <p>Do not place the copier on an unstable or tilted surface. If it topples over it could cause injury.</p>	 <p>Clearing Misfeed Caution</p>	<p>When removing misfed paper, do not touch the fusing section — it could be very hot.</p>
 <p>Parts Caution</p>	<p>This copier has been tested for safety using this supplier's parts and consumables. We recommend you only use these specified supplies.</p>		

NAME/FUNCTION OF PARTS

Exterior

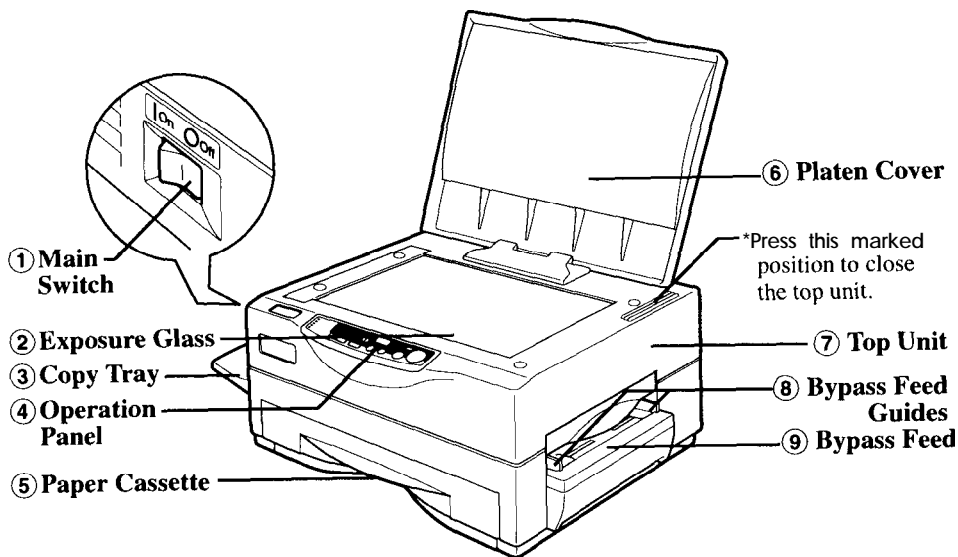
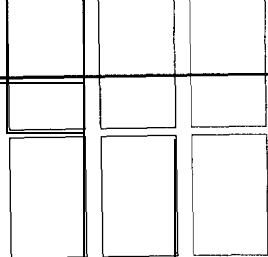

1. Main Switch

For turning copier on/off.

2. Exposure Glass

Position originals face down.

3. Copy Tray

Finished copies are delivered here.

4. Operation Panel

Panel type 1 or 2 depends on copier model. (See pages 8-9.)

5. Paper Cassette

Holds up to 250 sheets of paper.

6. Platen Cover

7. Top Unit

Open to access inside of copier.

8. Bypass Feed Guides

Assist alignment of copy paper in the bypass feed. (See page 26.)

9. Bypass Feed

Use to copy to transparencies, adhesive labels and translucent paper. (See pages 26-27.)

* Make sure to press down on this position when closing the top unit.

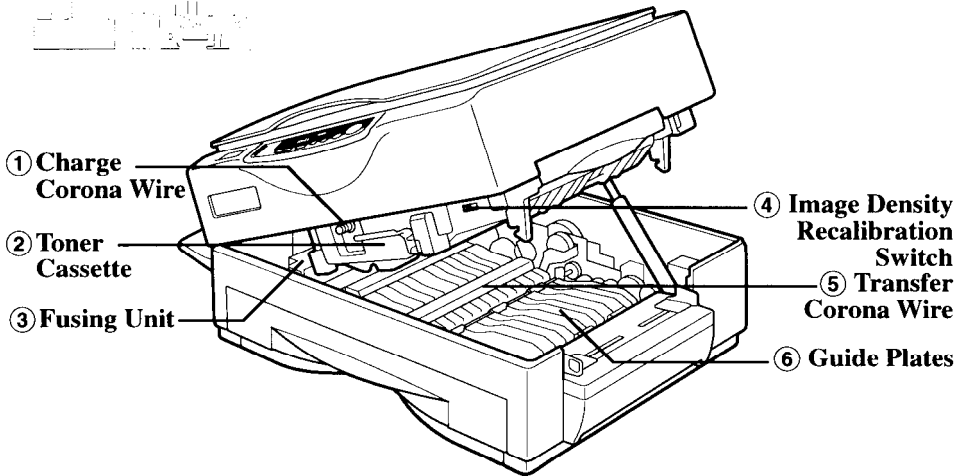

1. Charge Corona Wire

If white streaks appear on copies, or image density appears uneven, clean this wire. (See page 45.)

2. Toner Cassette

When  lights up or blinks, replace the toner cassette. (See page 42.)

3. Fusing Unit

Fuses the copy image to the paper.

CAUTION: This unit may be very hot. When accessing the inside of the copier, use caution.

4. Image Density Recalibration Switch

When you want to adjust the image density after using the copier for a long time, adjust this switch. (See page 34.)

5. Transfer Corona Wire

If white streaks appear on copies, or image density appears uneven, clean this wire. (See page 45.)

6. Guide Plates

If the reverse side of copies appears dirty, clean the guide plates. (See page 47.)

Operation Panel

Type 1 & 2

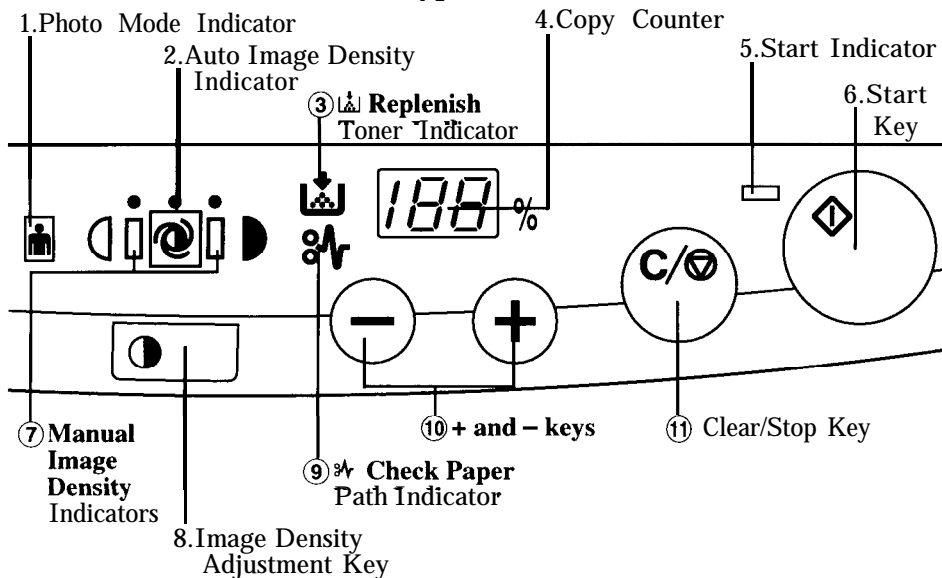

1. **Photo Mode Indicator:** Lights up when photo mode is selected with image density indicator. (See page 28.)
2. **Auto Image Density Indicator:** Lights up to show copier is in automatic image density mode. (See page 28.)
3. **Replenish Toner Indicator:** Replenish toner when this indicator lights up. (See page 42.)
4. **Copy Counter:** Indicates the number of copies. Shows reduction/enlargement size in % in zooming mode (Type 2 panel only); **PE** display tells you to replenish paper, and displays other data.
5. **Start Indicator:** Lights green when copier is ready to make copies.
6. **Start Key:** Press to start copying.
7. **Manual Image Density Indicators:** Lights up when image density is adjusted manually. (See page 28.)
8. **Image Density Adjustment Key:** Used to adjust image density. (See page 28.)
9. **Check Paper Path Indicator:** Lights up to indicate paper jam. To clear paper misfeeds, see page 60.
10. **+ and - keys:** Used to increase or reduce the desired number of copies. Or type 2 only, for reduction or enlargement in 1% increments. (See page 30.)
11. **Clear/Stop Key:** Press to reset the counter to 1. During copying, press to stop copying.

Type 2

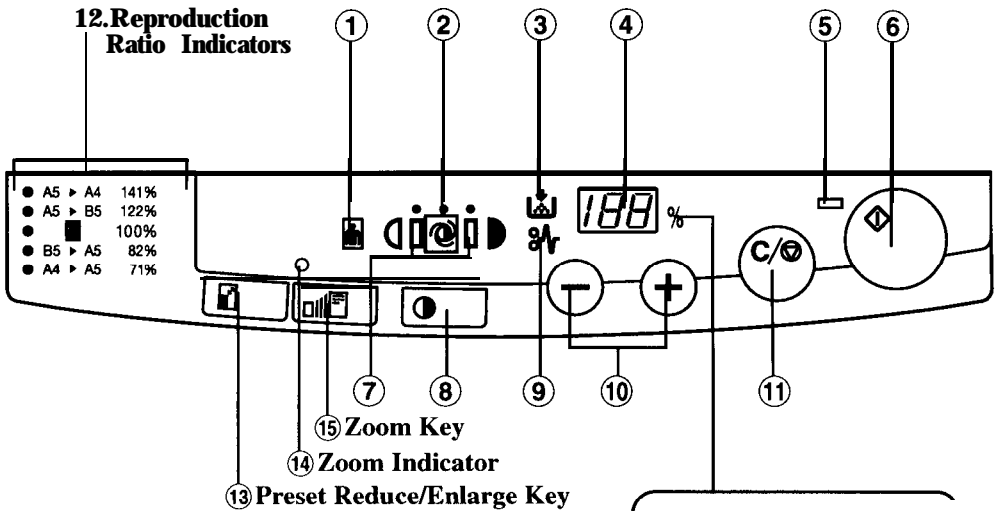

- ⑫ **Reproduction Ratio Indicators:** Shows the preset reproduction ratio selected. (See page 29.)
- ⑬ **Preset Reduce/Enlarge Key:** Press to reduce/enlarge copies in preset ratios. (See page 29.)
- 14. Zoom Indicator:** Lights to indicate the copier is in zoom mode. (See page 30.)
- ⑮ **Zoom Key:** Press before using + or key to zoom up/down copies in 1% increments. (See page 30.)

CONTENTS

SAFETY INFORMATION	3-5
NAME/FUNCTION OF PARTS	6-9
Exterior	6
Interior	7
Operation Panel	8-9
CONTENTS	10-11

PREPARATIONS

13-22

INSTALLATION	14-19
Checking the Package Contents	14
Unpacking	14
Installing Copier	15
Loading Toner Cassette	16
Setting or Changing Paper Size	17
Loading Copy Paper	18
Notes on copy paper	18
Attaching Copy Tray	19
TURNING COPIER ON	20-21
Auto-off mode – for automatically saving power..	21
NOTES ON INSTALLATION LOCATION	22

OPERATIONS

23-32

PLACEMENT OF ORIGINALS	24
Alignment of Originals	24
FULL-SIZE COPYING	25
Auto Start – Setting Copy Orders During Warm-Up	25
BYPASS FEED COPYING	26-27
Original and Copy Directions	27
ADJUSTING COPY DENSITY	28
Auto image density	28
Manual image density	28
REDUCING/ENLARGING	29-30
Reducing/Enlarging Using Preset Ratios	29
Zooming in 1% Increments	30
MAKING TWO-SIDED COPIES	31
MAKING BOOK COPIES	32

COPIER SETTING ADJUSTMENT	33-40
RECALIBRATING IMAGE DENSITY	34
USER TOOLS	35-40
List of User Tools	35
Making Adjustment with User Tools	36-37
User Tool Menu	37-40

MAINTENANCE	41-53
REPLACING THE TONER CASSETTE	42-43
Copy Yield	43
MAINTAINING COPIER	44-47
Daily Maintenance	44
Corona Wires	45-46
Guide Plates	47
NOTES	48-49
General Operation	48
Replenishing Toner	49
Removing Misfed Paper	49
STORAGE	50
Paper	50
Toner Cassette	50
REPACKING	51-53

TROUBLESHOOTING	55-60
TROUBLESHOOTING	56-57
CLEARING MISFEEDS	58-60
When PE appears on the copy counter	59
When *A stays on	60

SPECIFICATIONS	61-63
SPECIFICATIONS	62-63

INDEX	64-65
--------------------	--------------

PREPARATIONS



INSTALLATION	14-19
Checking the Package Contents	14
Unpacking	14
Installing Copier	15
Loading Toner Cassette	16
Setting or Changing Paper Size	17
Loading Copy Paper	18
Notes on copy paper	18
Attaching Copy Tray	19
TURNING COPIER ON	20-21
Auto-off mode -for automatically saving power	21
NOTES ON INSTALLATION	
LOCATION	22

INSTALLATION

Checking the Package Contents

When you open the cardboard box, verify that the following items are inside.

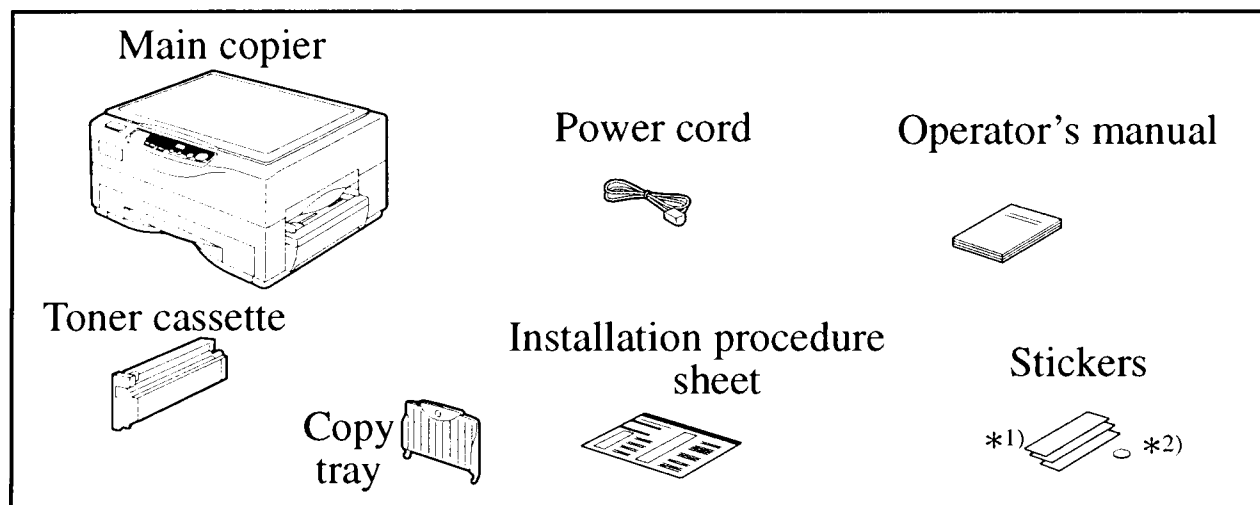

- *1) Number and types of these message guidance stickers may differ depending on the market.
- *2) This round sticker is for concealing the hole after the shipping thumbscrew ② has been removed. (See step ② on page 15.)

Unpacking

Keep the foam blocks, supports and the vinyl bag in the original cardboard box to facilitate moving or returning the copier.

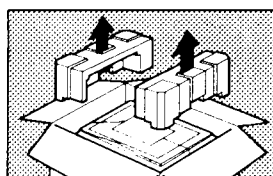

1

Open the cardboard box and remove the foam blocks.

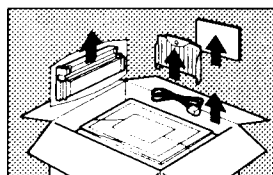

2

Remove the toner cassette, copy tray, operator's manual and power cord from the box.

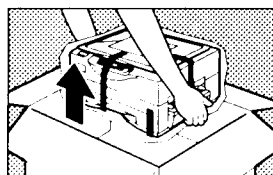

3

Remove the copier from the box.
• Lift the copier from the bottom as illustrated.

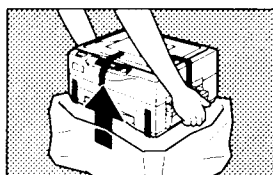

4

Open the vinyl bag and take the copier out carefully.
• The copier must be level within 3mm (0.11 in.) both front to rear and left to right.

Installing Copier

- Be careful not to touch the OPC (Organic Photo Conductor, blue material) inside the copier.
- Do not expose the OPC to light.

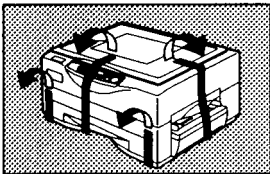

1 Remove all tapes.

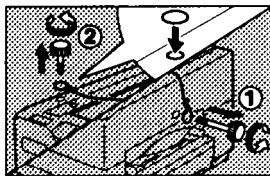

2 Remove shipping thumbscrew ①, then open the platen cover. (No thumbscrew ① for type 1 model)

Next, remove shipping thumbscrew ②, and attach the sticker to conceal the hole of shipping thumbscrew ②.

The removed shipping thumbscrews should be kept as shown in step **4** for future shipping.

WARNING: Do not turn on the main switch until the two shipping thumbscrews have been removed, otherwise the copier may be damaged.



3 Open the top unit.



4 Store the two shipping thumbscrews as shown. (Only short thumbscrew with type 1 model)

CAUTION: Make sure to keep the shipping thumbscrews; they must be attached prior to shipping.

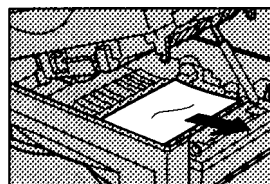

5 Remove the paper in the unit.



6 Close the ton unit by pressing down firmly on the marked position.

Attention: Make sure to press the marked position.

Loading Toner Cassette

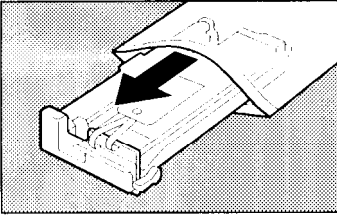

1

Remove the toner cassette from the vinyl bag.

- Keep the vinyl bag for repacking.

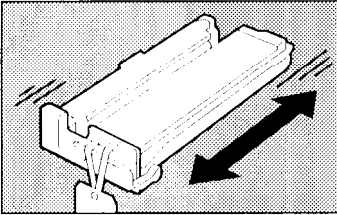

2

Rock the toner cassette back and forth five or six times.

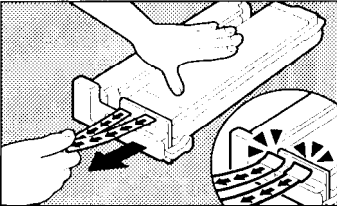

3

Set the toner cassette on a flat surface and remove the two tapes inside the unit completely as shown.

- Hold the toner cassette firmly with one hand to prevent it from turning over.
- Yellow marks appear at the end of the tapes. Make sure to remove the tapes completely from the toner cassette.

CAUTION: If these tapes are not removed, the toner cassette may be damaged, and unable to make a copy.

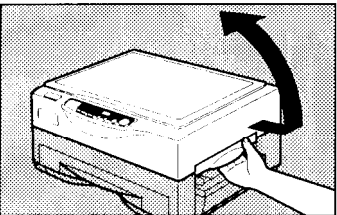

4

Open the top unit.

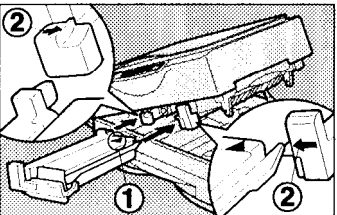

5

Confirm that the A mark ① of the toner cassette is pointing upward. Align guides on both sides of the toner cassette with the left (with ● mark) and right (with ◀ mark) guides ② of the toner cassette holder, then insert the toner cassette into the copier as shown until it clicks into place.

- Do not insert the toner cassette into the copier until the tapes are completely removed.

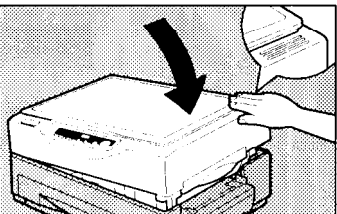

6

Close the top unit by pressing down firmly on the marked position.

Attention: Make sure to press the marked position.

Setting or Changing Paper Size

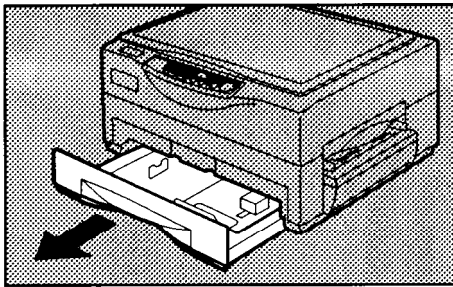

1

Pull the paper cassette out. Check the set paper size. If preset paper size is the setting you want to use, disregard steps 2 to 6.

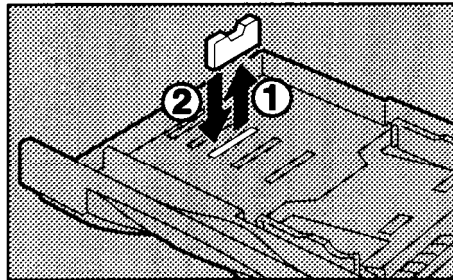

2

If you need to change the paper size, continue to the following steps.

Adjusting the paper length

Remove the end plate 1 and set it to your desired paper size 2.

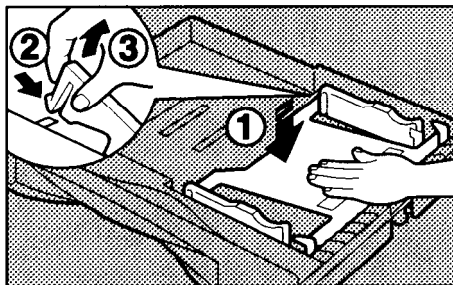

3

Adjusting the paper width

Push the bottom plate halfway down 1, and carefully remove the two side guides by pushing 2 and lifting 3 the end of the side guides as illustrated.

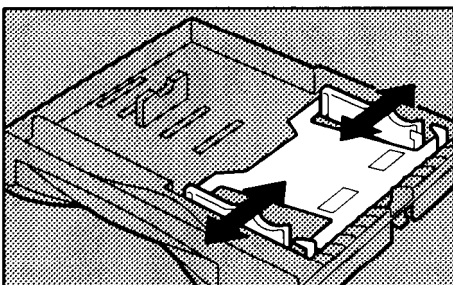

4

Move the two side guides to your desired paper size, while pushing the bottom plate halfway down.

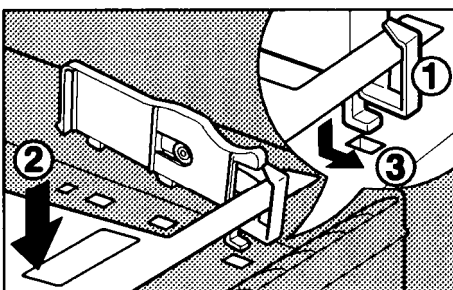

5

To set the side guides, confirm that the metal hook of the side guide is above the protrusion of the bottom plate 1, push the bottom plate halfway down 2, and insert the bottom hook of the side guide into the hole 3.

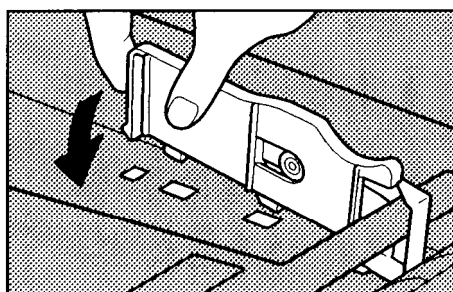

6

Then slowly insert the hook on the other end into the hole until it clicks into place.

Loading Copy Paper

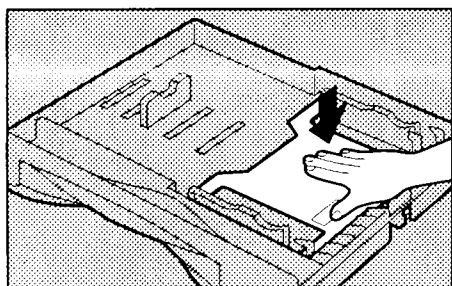

1

Push the bottom plate down firmly until it locks into place.

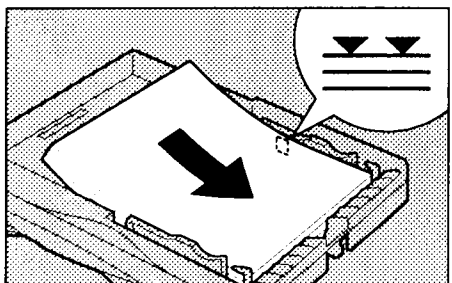

2

Load paper in the paper cassette.

- Do not stack paper above the limit mark on the side guide.
- Maximum capacity: 250 sheets (80g/m², 20 lb)

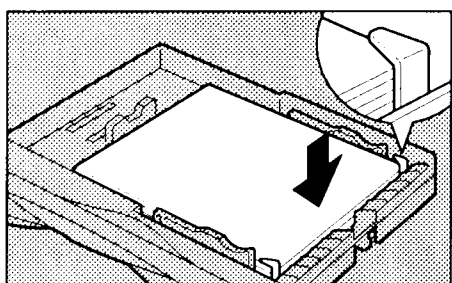

3

Make sure the leading corners of the paper fit under the corner guides.

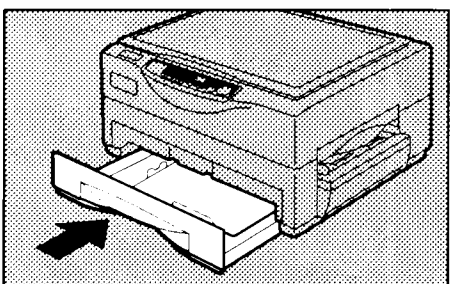

4

Push the cassette in horizontally.

- After making one copy, make sure that the Load Paper (PE) indication is off.

Notes on copy paper

- Copy paper of the types or in the conditions listed below are not recommended for this copier.
 - Folded, curled, creased, or damaged paper
 - Torn paper
 - Damp paper
 - Perforated paper
 - Paper with low electrical resistance such as carbon or silver-coated paper
 - Wavy paper
 - Thermal paper, art paper
 - Thin, flimsy paper
- Adhesive labels should be fed from the bypass feed one sheet at a time.
- Translucent paper should be fed from the bypass feed.
- Translucent paper should be fed so that the paper grain is oriented with the paper path.
- Do not touch copy paper if your fingers are wet or oily; fingerprints may appear on the copy.

Attaching Copy Tray

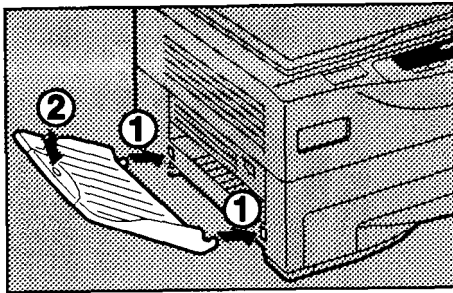

1

Attach copy tray as shown ①, then depress it slightly to fix it in place ②.

- Confirm that the copy tray is securely in place.

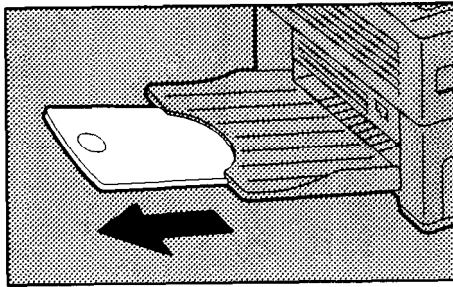

2

When you copy onto long-size paper, extend-the copy tray as shown.

TURNING COPIER ON

Power Connection



Only connect the copier to the power source described on the inside front cover of this manual. Avoid multi-wiring as it could cause an electric shock or fire.
Avoid using an extension cord. Make sure the wall outlet is near the copier and freely accessible so it can be unplugged easily in the event of an emergency.

- Make sure the plug is firmly inserted in the outlet.
- Voltage must not fluctuate more than 10%.
- Do not set anything on the power cord.
- Always turn the copier off when you have finished copying for the day.

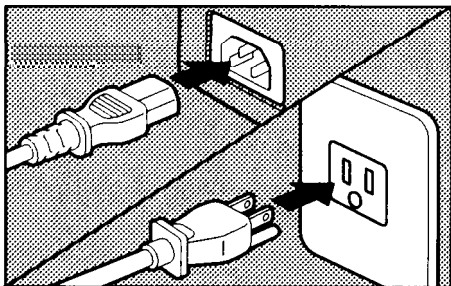

Firmly insert the plug into the copier and outlet.

Turning Copier On

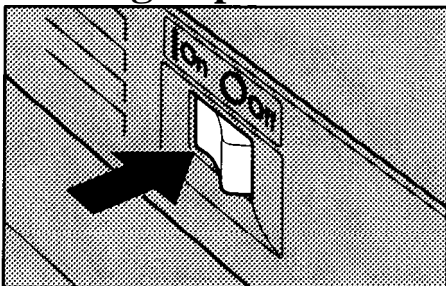

1 Turn the main switch on.

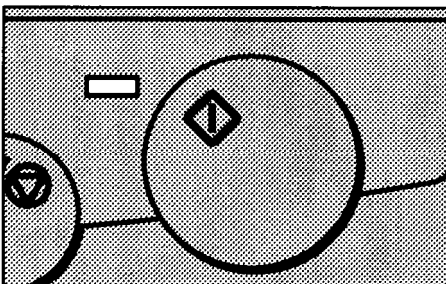

2 Wait for the copier to warm up. During warm-up, the **Start** indicator lights red.

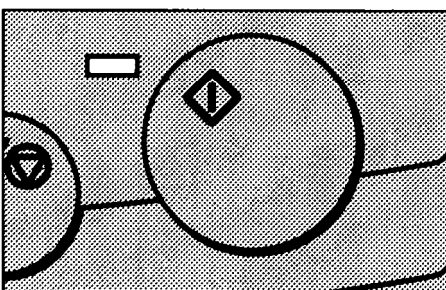

3 When the **Start** indicator turns green, the copier is ready to make copies.
• If Load Paper "**PE**" indication is on when starting, load paper.

Auto-off mode — for automatically saving power

To conserve energy, this copier automatically shifts to the “Auto-off mode” 30 minutes after you make a copy. In Auto-off mode, power consumption is reduced from less than 91W (standby) to less than 5W. To re-activate the copier, press any key.

- The copier does not enter Auto-off mode when:
 - the **Start** indicator is red.
 - You are accessing the user tools.
- Initial Auto-off duration is 30 minutes. To change this duration with the user tools, follow the steps on page 38.
- When the copier is in Auto-off mode, the Start indicator (green) blinks.

NOTES ON INSTALLATION LOCATION

Environmental conditions greatly affect the performance of a copier. Be sure to choose your installation location carefully.

Optimum Setting Conditions

- Temperature: 10 - 35°C (50 - 95°F)
- Humidity: 15 - 80% RH
- Place upon a strong, stable, level base with a flat, even surface. Do not place on a surface that has holes, ruts, cavities or is uneven in any way.
- The copier must be level within 3mm (0.11 in.) both front to rear and left to right.
- To avoid a possible ozone buildup, be sure to locate this copier in a large well ventilated room with an air turnover of more than 3 times/hr/person.

Locations to Avoid

- Locations exposed to direct sunlight or strong light (more than 2,000 lux).
- Locations directly exposed to cool air from an air conditioner or heated air from a heater. (Sudden temperature changes may cause condensation within the copier.)
- Places where the copier might be subjected to frequent strong vibration.
- Dusty areas.
- Areas exposed to corrosive gases.
- Places higher than 2,000m (6,500 ft.) above sea level.

Copier Location

Place the copier near the wall outlet, providing minimum clearance as shown.

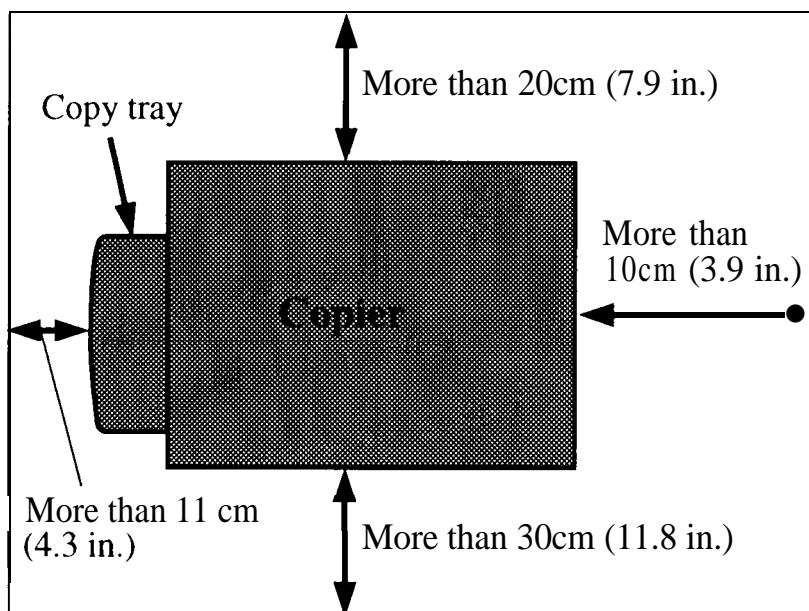

OPERATIONS



PLACEMENT OF ORIGINALS	24
Alignment of Originals	24
FULL-SIZE COPYING	25
Auto Start — Setting Copy Orders	
During Warm-Up	25
BYPASS FEED COPYING	26-27
Original and Copy Directions	27
ADJUSTING COPY DENSITY..	28
Auto image density	28
Manual image density	28
REDUCING/ENLARGING	29-30
Reducing/Enlarging Using Preset Ratios .	29
Zooming in 1% Increments	30
MAKING TWO-SIDED COPIES	31
MAKING BOOK COPIES..	32

PLACEMENT OF ORIGINALS

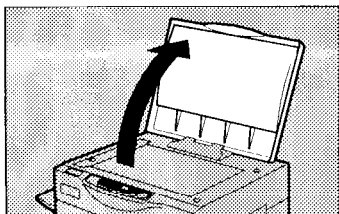

1 Lift the platen cover.

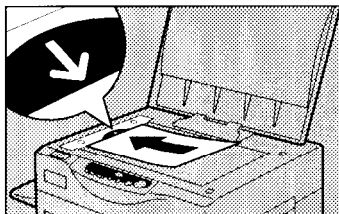

2 Set the original face down on the exposure glass. Align the center of your original with the arrow mark on the scale.

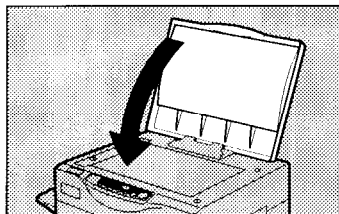

3 Lower the platen cover.
• When copying from a book, the thickness of the book should be no more than 20mm (0.78 in.).

Alignment of Originals

Align the original with the scale on the left side of the exposure glass.

- When the original is a standard size such as 8 1/2 or A4, align it to the indexes on the scale.
- When your original is not a standard size, align the center of the original to the arrow mark at the center of the scale.

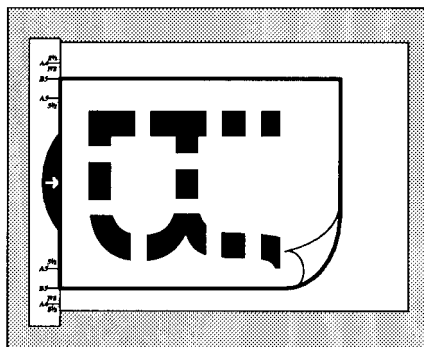

FULL-SIZE COPYING

To make copies the same size as your originals.

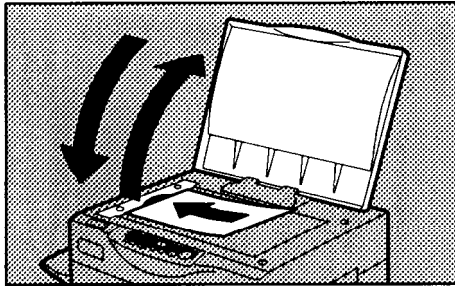

1

Lift the platen cover and place the original face down on the exposure glass. Align the center of your original with the arrow mark on the scale. Lower the platen cover.

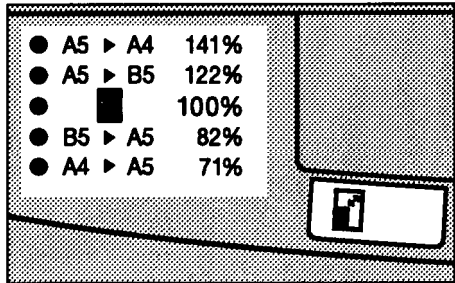

2

If your copier includes an enlargement/ reduction feature (Type 2 panel only), make sure the magnification ratio is set to Full Size. If not, press the **Reduce/Enlarge** key until Full Size indicator is lit.

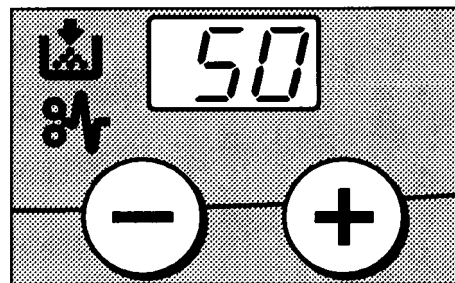

3

Enter your desired number of copies using the + key (to increase copy number) or - key (to reduce copy number).

- Up to 50 copies can be entered.
- To reset the number to 1, press the **Clear/Stop** key.
- When copy counter is 1, pressing the - key changes the counter to 50. Likewise, when the counter is 50, pressing the + key changes the counter to 1.

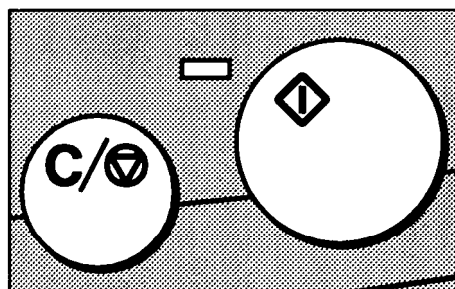
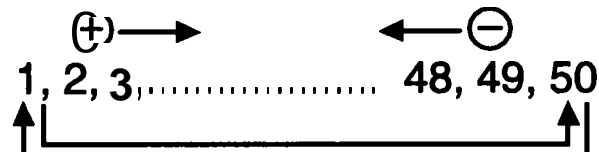

4

Press the **Start** key.

- To stop the machine during a multi-copy run, press the **Clear/Stop** key.
- To resume copying, press the **Start** key.
- To clear the copy counter, press the **Clear/Stop** key.

Auto Start — Setting Copy Orders During Warm-Up

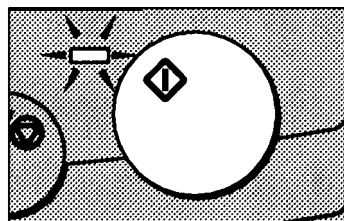

If you press the **Start** key during warm-up, the Start indicator will blink in red and green. The copier will start copying when warm-up is completed.

- To cancel Auto Start, press the **Clear/Stop** key.

BYPASS FEED COPYING

To copy onto paper different from the type in the paper cassette, use the bypass feed.

- One sheet should be inserted into the bypass feed at a time.
- Bypass feed copying should also be used for transparencies, adhesive labels, translucent paper or postcards.

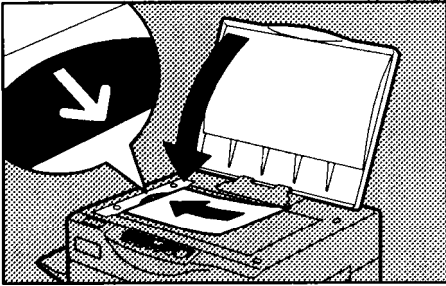

1

Place the original face down on the exposure glass and lower the platen cover.

- Align the center of the original to the arrow mark.

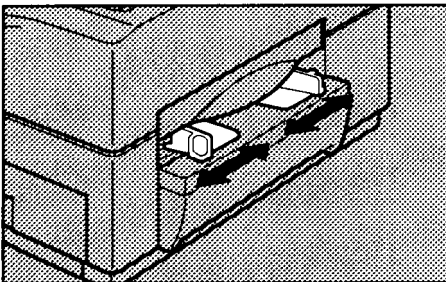

2

Adjust the bypass feed guides to the proper width.

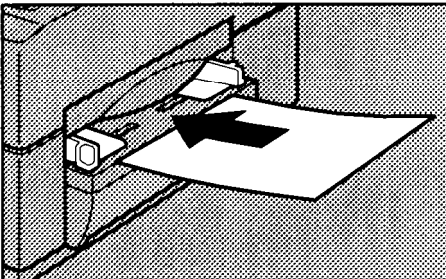

3

Gently insert the copy paper into the bypass feed.

- Never insert more than one copy paper at a time.

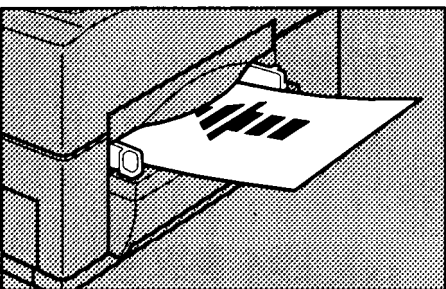

4

Copy starts automatically.

When making multiple copies using the bypass feed, gently insert the next copy paper into the bypass feed until the paper is fed automatically.

- Do not set the next paper before the **Start** indicator turns green. A misfeed may occur.

Original and Copy Directions

When making copies using bypass feed, directions of placed original and copies are as follows.

Transparencies

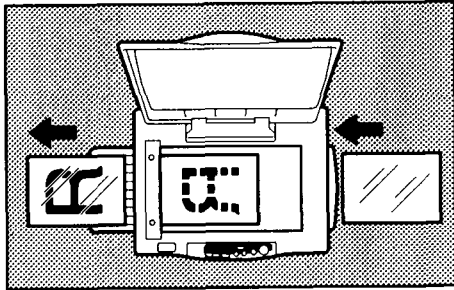

Set the originals and transparencies as shown.

- Remove copies delivered to the copy tray one by one.

Letterhead

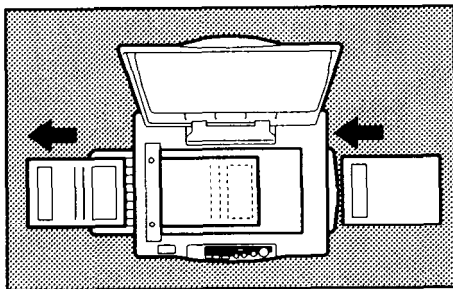

Set the originals and letterhead as shown.

Two-sided copies

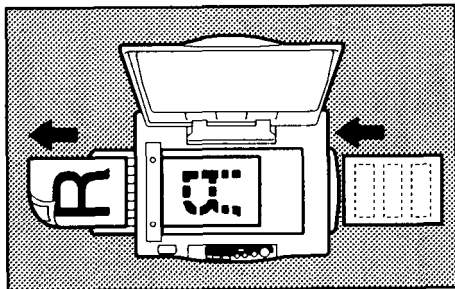

Set the originals and copy paper for copying the reverse side as shown.

- Do not use paper that has been printed on using other copiers or printers.
- For instructions on making two-sided copies, see page 31.

ADJUSTING COPY DENSITY

If the copy image appears dirty, too dark or too light, adjust the image density.

- Auto image density can be increased or decreased with the user tools.
See page 38.

Auto image density

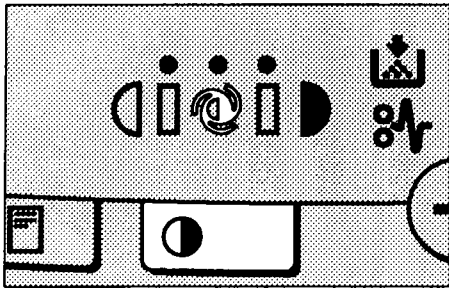

If the center image density indicator  is lit, the copier will automatically control the image density.

If the density has been manually adjusted, press the **Image Density** adjustment key so the center image density indicator lights.

Manual image density

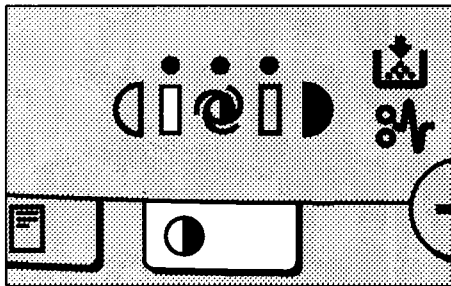

For dark or light originals, or to copy photographs, adjust the image density.

Press the **Image Density** adjustment key to change the image density in the following order:

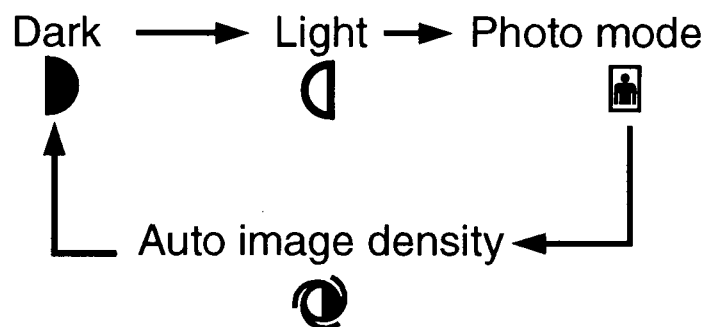

REDUCING/ENLARGING

Reducing/Enlarging Using Preset Ratios

(Type 2 model only)

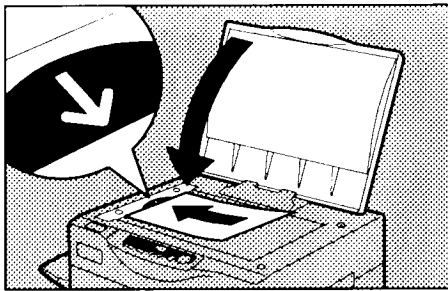

1

Place the original face down on the exposure glass, and lower the platen cover.

- Align the center of the original to the arrow mark on the scale.

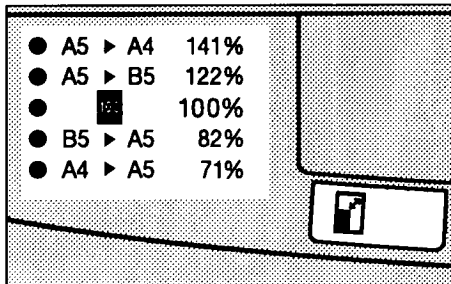

2

To reduce or increase the reproduction ratio, press the **Reduce/Enlarge** key. The reproduction ratio will change as follows:

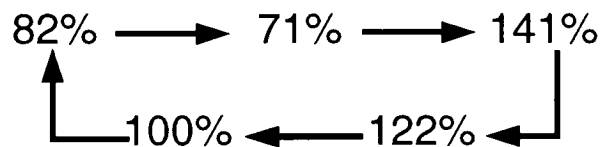

3

Enter any other desired settings, then press the **Start** key to make your copies.

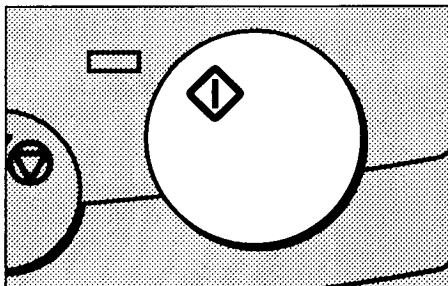

Zooming in 1% Increments

(Type 2 model only)

The copy image can be reduced down to 70% or enlarged up to 141% in 1 percent increments.

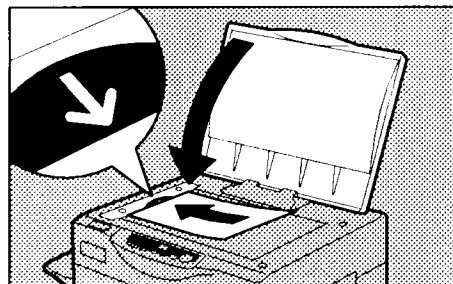

1

Place the original face down on the exposure glass, and lower the platen cover.

- Align the center of the original to the arrow mark on the scale.

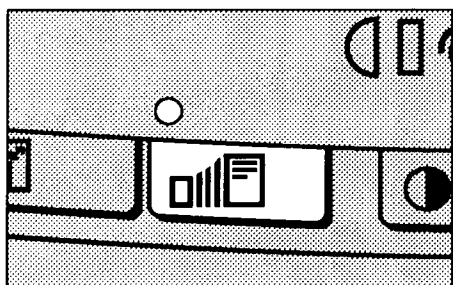

2

Press the **Zoom** key.
Zoom indicator lights.

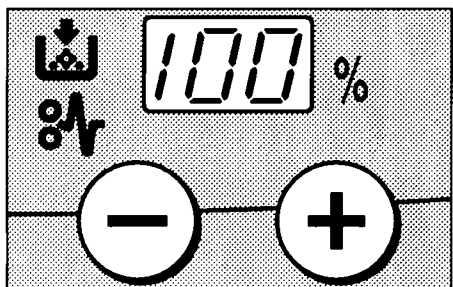

3

% appears next to the copy counter indicating that the copy counter has changed to the zoom display with the size ratio in percentage. Press the – key repeatedly to reduce the ratio in 1% increments.

Or, press the + key repeatedly to increase the ratio in 1% increments.

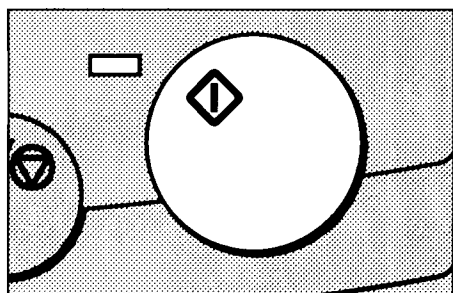

4

Enter any other desired settings, then press the **Start** key to make your copies.

- The reproduction ratio display changes to the copy counter display 3 to 4 seconds after releasing the **Zoom** key.
- To reset the ratio to 100%, press the **Reduce/Enlarge** key.

MAKING TWO-SIDED COPIES

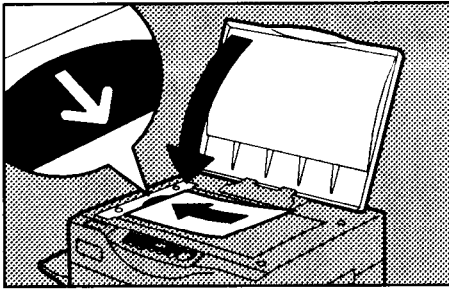

1

Place the original for the front side of the copy on the exposure glass and lower the platen cover.

- Align the center of the original to the arrow mark on the scale.

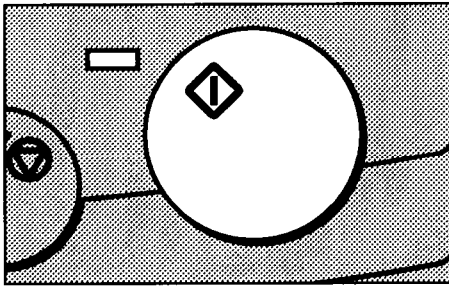

2

Press the **Start** key to make the first copy.

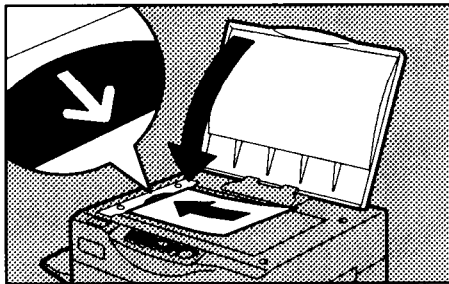

3

Place the original for the reverse side of the copy on the exposure glass and lower the platen cover.

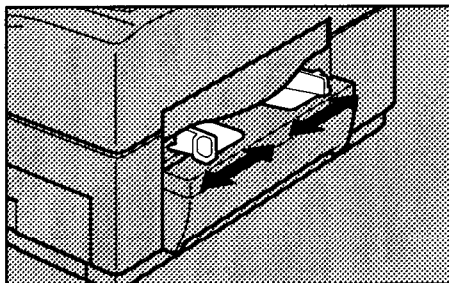

4

Adjust the bypass feed guides to the proper width.

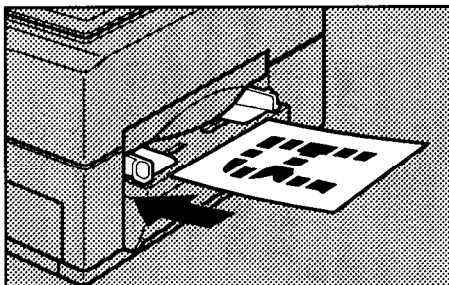

5

Insert the copy paper into the bypass feed blank side facing upward.

- If the paper is curled, straighten it before insertion. (See page 48.)

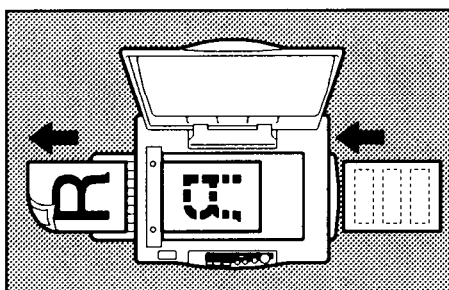

6

Copy directions are as indicated.

MAKING BOOK COPIES

When copying from a book, the thickness of the book should be no more than 20mm (0.78 in.).

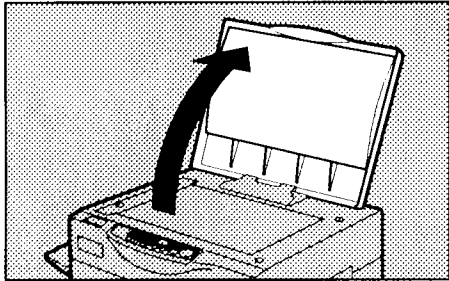

1

Lift the platen cover.

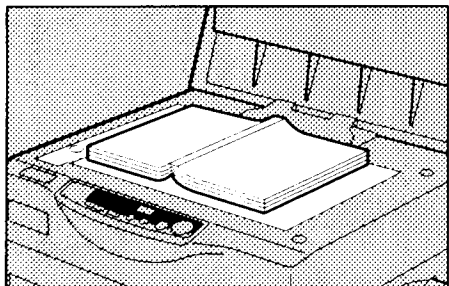

2

Open the page(s) of the book to be copied face down on the exposure glass.

Align the center of your book with the arrow mark on the scale.

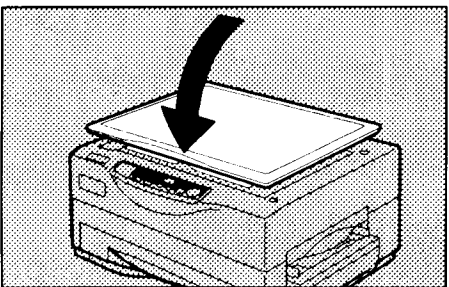

3

Lower the platen cover and start copying.

COPIER SETTING ADJUSTMENT

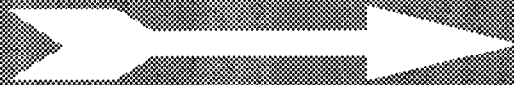

RECALIBRATING COPY DENSITY	34
USER TOOLS	35-40
List of User Tools	35
Making Adjustment with User Tools . .	36-37
User Tool Menu	37-40

RECALIBRATING IMAGE DENSITY

When copies have become unclear or dirty after using the copier for a long time, adjust copy density using the image density recalibration switch.

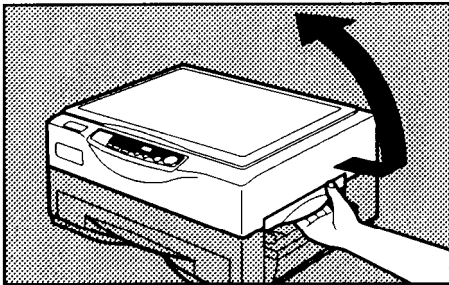

1 Open the top unit.

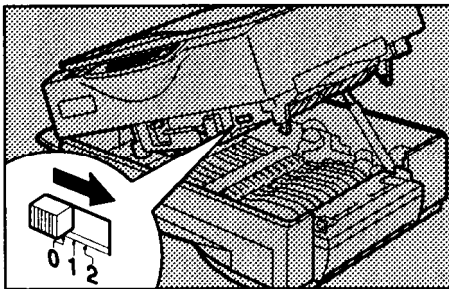

2 Slide the image density recalibration switch to 1 to make the image clearer. If the copies are still unclear or dirty, slide the image density recalibration switch to 2.

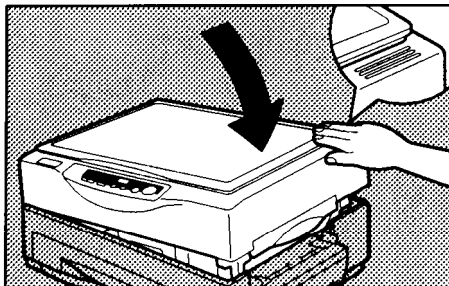

3 Close the top unit by pressing down firmly on the marked position. Attention: Make sure to press the marked position.

USER TOOLS

List of User Tools

The value or mode of the following items can be adjusted with the corresponding User Tool.

User Tool number	Adjustable item	See page
1	Auto image density level	37
2	Darker-side manual image density level	38
3	Lighter-side manual image density level	38
4	Photo mode level	38
5	Auto-off duration	38
6	Auto reset duration	39
7	Counter up/down	39
8	Total copy number	39-40

Making Adjustment with User Tools

Accessing user tools

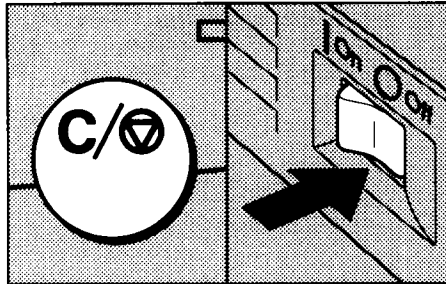

1

Turn off the main switch and, while pressing the **Clear/Stop** key, turn it back on.

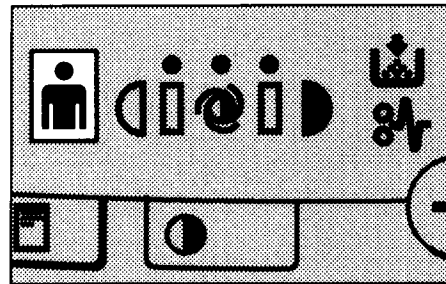

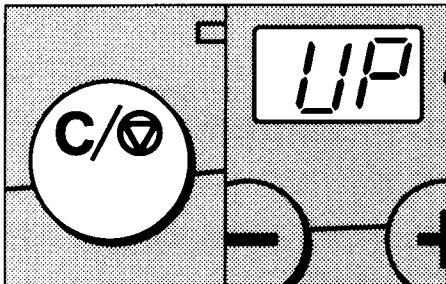
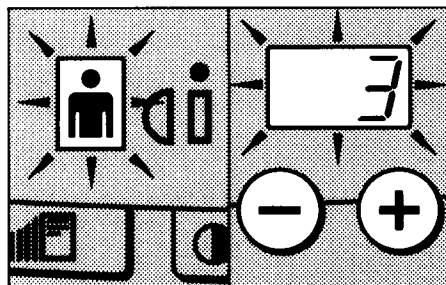

Photo Mode indicator  appears in the operation panel.



2

Release the **Clear/Stop** key. **UP** will appear on the copy counter to show you are in the User Tools mode.



3

Enter the user tool number you want to access using the **+** and **-** keys.

- The user tool number blinks on the copy counter and the Photo Mode indicator blinks.

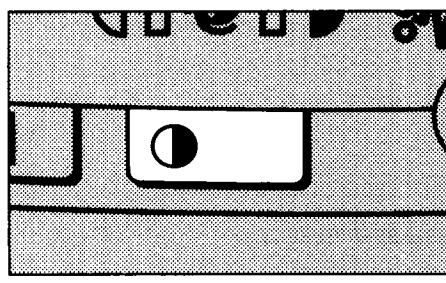

4

Press the **Image Density** adjustment key to select the tool number.

- The selected user tool number appears without blinking and the Photo Mode indicator blinks.

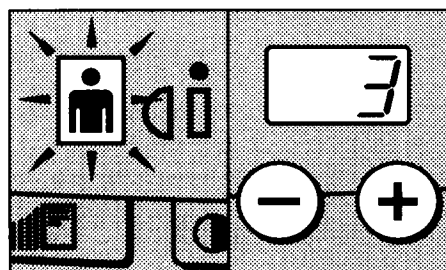

Adjusting values/modes

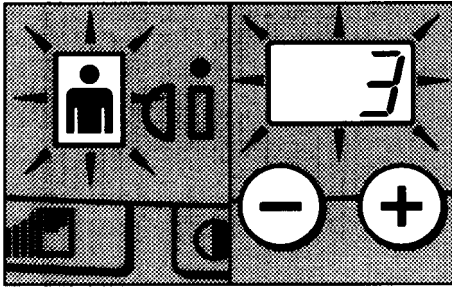

5

When the desired user tool number is lit on the copy counter and the Photo Mode indicator is blinking, enter the required setting using the + and – keys.

- For the settings, refer to pages 37-40.

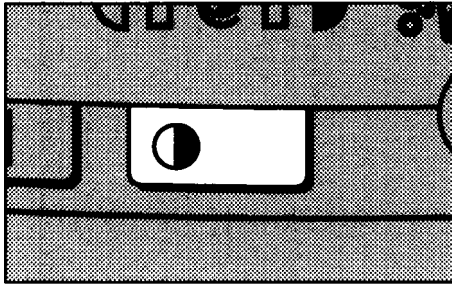

6

Press the **Image Density** adjustment key.

The setting will be stored in memory.

- The setting number and the Photo Mode indicator blink. Now, you can access another user tool number by pressing the + and – keys.

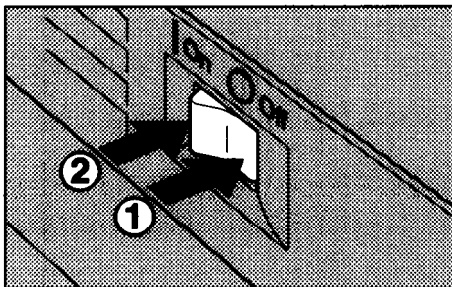

7

To exit user tools, turn the main switch off and then back on again.

COVER SETTING ADJUSTMENT

User Tool Menu

1. Auto image density level _____ User mode 1

If the image density in the auto image density mode is too dark or too light, adjust it using this function.

Default: Normal (Number: 0)

Setting	Normal	Light	Lighter	Lightest	Dark	Darker	Darkest
Number	0	1	3	5	2	4	6

- If your desired image density could not be obtained with the adjustment in “User mode 1” adjust it by sliding the image density recalibration switch to the right. (Refer to page 34.)

2. Darker-side manual image density level ————— User mode 2

The density represented by the right indicator can be made darker.

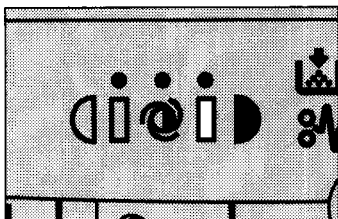

Default: Normal (Number: 0)

Setting	Normal	Dark	Darker
Number	0	1	2

3. Lighter-side manual image density level ————— User mode 3

The density represented by the left indicator can be made lighter.

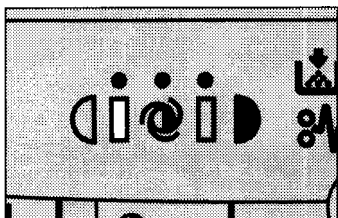

Default: Normal (Number: 0)

Setting	Normal	Light	Lighter
Number	0	1	2

4. Photo mode level ————— User mode 4

If the image density in the photo mode is too dark, adjust it using this function.

Default: Normal (Number: 3)

Setting	Lightest	Lighter	Light	Normal	Dark	Darker
Number	0	1	2	3	4	5

5. Auto-off duration ————— User mode 5

To conserve energy, this copier automatically shifts to the Auto-off mode 30 minutes after the last copying job has been completed. This time can be adjusted using this function.

Default: 30 minutes (Number: 2)

Setting	5 minutes	10 minutes	30 minutes	60 minutes	90 minutes	120 minutes
Number	0	1	2	3	4	5
Setting	180 minutes	240 minutes				
Number	6	7				

6. Auto reset duration _____ User mode 6

As a default setting, the copier will reset itself 1 minute after the final copy is made or after the last time any key is pressed. If a 1 minute reset time is not appropriate, you can change this time.

Default: 1 minute (Number: 0)

Setting	1 minute	3 minutes	Off
Number	0	1	2

7. Counter up/down _____ User mode 7

The copy counter can be set to show the number of copies made (count up) or the number of copies remaining to be made (count down).

Default: Up (Number: 0)

Setting	U p	Down
Number	0	1

8. Total copy counter _____ User mode 8

You can check the total number of copies made.

How to check the total copy counter:

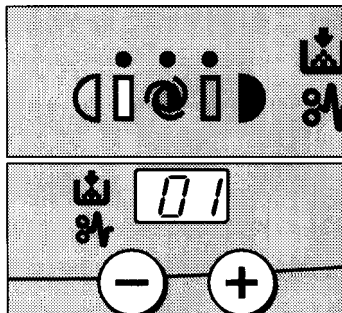

Access user tool number “8”. You will find the first two digits of the total copy quantity (configured in six digits) are displayed on the copy counter.

- Example: When 12345 copies are made, “01” is displayed on the copy counter.
- For the first two digits, the left image density indicator is lit.



2

Press the **Start** key. You will find the second two digits of the total copy quantity are displayed on the copy counter.

- Example: When 12345 copies are made, “23” is displayed on the copy counter.
- For the second two digits, the center image density indicator is lit.

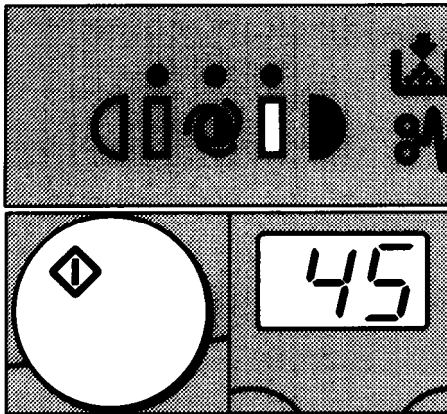

3

Press the **Start** key again. You will find the last two digits of the total copy quantity are displayed on the copy counter.



- Example: When 12345 copies are made, “45” is displayed on the copy counter.
- For the last two digits, the right image density indicator is lit.
- When you want to see the first two digits again, press the **Start** key once. When you want to see the second two digits, press the **Start** key twice.
- To access another user tool number, press the **Image Density** adjustment key.
- To exit the user tools, turn the main switch off and then back on again.

MAINTENANCE



REPLACING THE TONER	
CASSETTE	42-43
Copy Yield	43
MAINTAINING THE COPIER	44-47
Daily Maintenance	44
Corona Wires	45-46
Guide Plates	47
NOTES	48-49
General Operation	48
Replenishing Toner	49
Removing Misfed Paper	49
STORAGE	50
Paper	50
Toner Cassette	50
REPACKING	51-53

REPLACING THE TONER CASSETTE

When  blinks on the operation panel, it is time to replace the toner cassette (copying is still possible). When  is continuously displayed, copies cannot be made until the cassette is replaced.

- When you install the new toner cassette, be careful not to touch the OPC (blue material). Copy image and copy quality could be affected.
- After a new toner cassette is installed, the density of the first few copies may be slightly lighter.

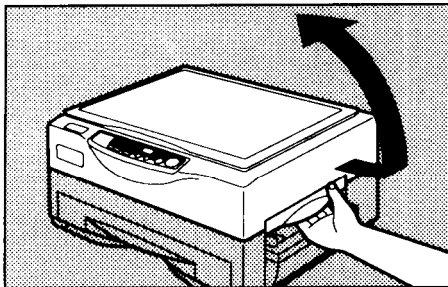

1 Open the top unit.

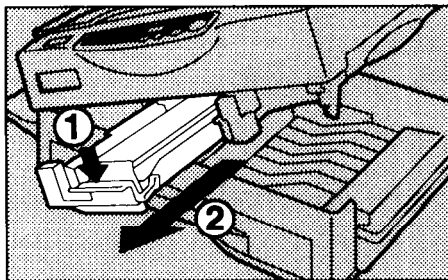

2 Remove the used toner cassette carefully.

- Be careful not to stain your hands with the toner. If toner is present, clean up with a cold damp cloth.

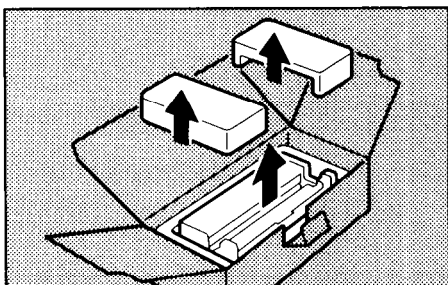

3 Open the new toner cassette cardboard box.

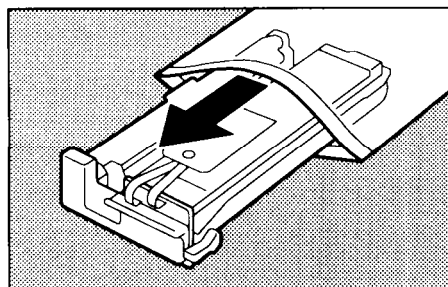

4 Remove the toner cassette from the vinyl bag.

- Keep the vinyl bag for repacking.

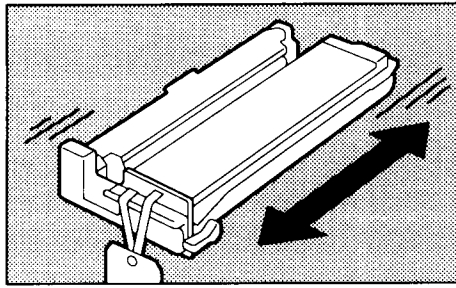

5 Rock the toner cassette back and forth five or six times.

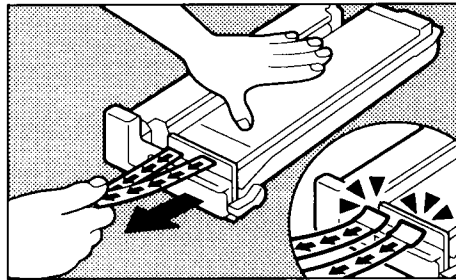

6 Set the toner cassette on a flat surface and remove two tapes inside the unit completely as shown.

- Hold the toner cassette firmly with one hand to prevent it from turning over.
- Yellow marks appear at the end of the tapes. Make sure to remove the tapes completely from the toner cassette.

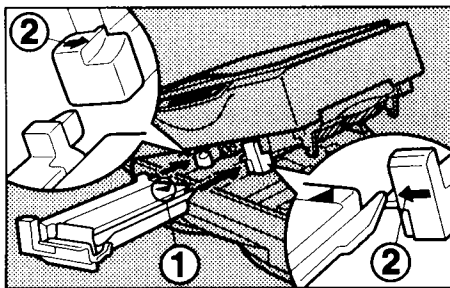

7 Confirm that the ▲ mark ① of the toner cassette is pointing upward. Align guides on both sides of the toner cassette with the left (with → mark) and right (with ← mark) guides ② of the toner cassette holder, then insert the toner cassette into the copier as shown until it clicks into place.

- Do not insert the toner cassette into the copier until the tapes are completely removed.

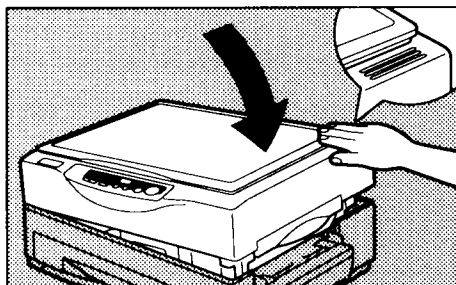

8 Close the top unit by pressing down firmly on the marked position.

Attention: Make sure to press the marked position.

Copy Yield

Toner cassette yields approximately 3,000 copies when copies are made from an original on which black ink covers 6% of the total area of an A4-size paper.

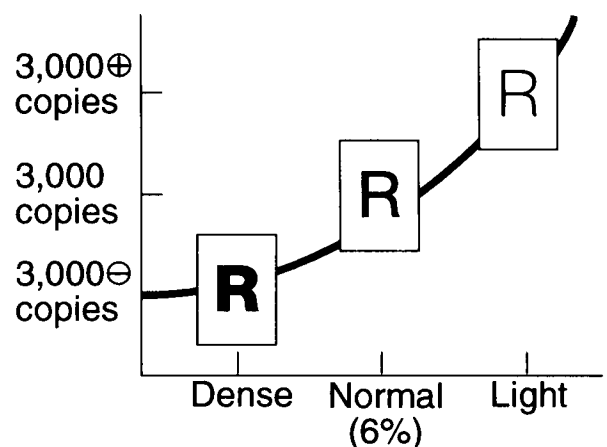

MAINTAINING THE COPIER

Daily Maintenance

Clean with a damp cloth and wipe dry.

Exposure Glass

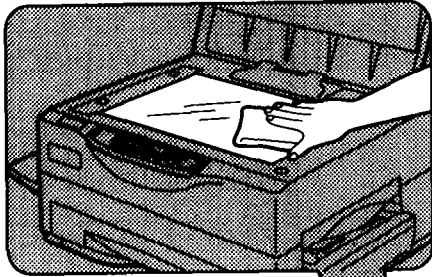

Platen Cover

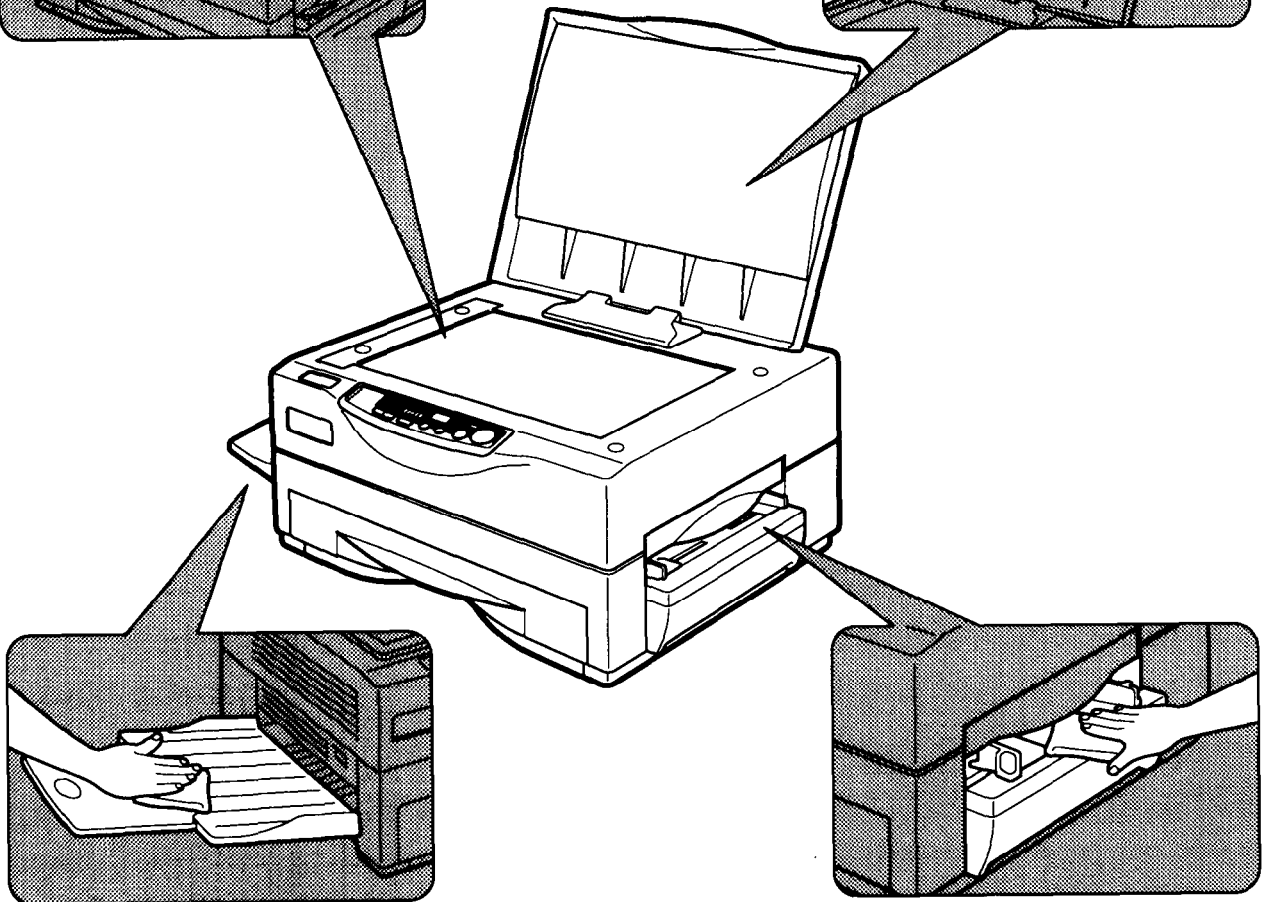
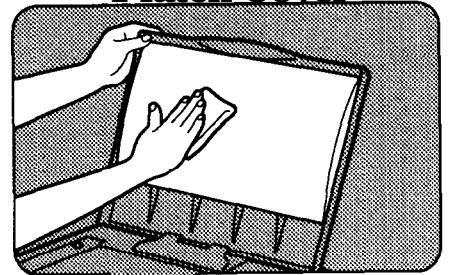

Copy Tray

Bypass Feed

Corona Wires

If white streaks appear on copies or the image density becomes uneven, clean the corona wires according to the following procedure:



When cleaning corona wires, do not touch the fusing unit because it could be very hot.

Fusing unit

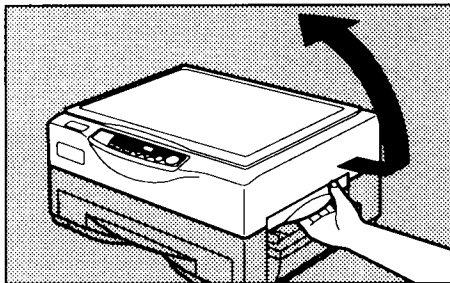
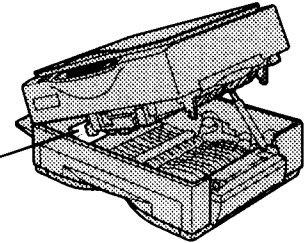

1

Open the top unit.

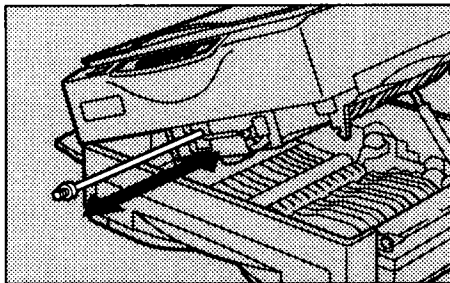

2

Move the lever in and out a few times to clean the charge corona wire.

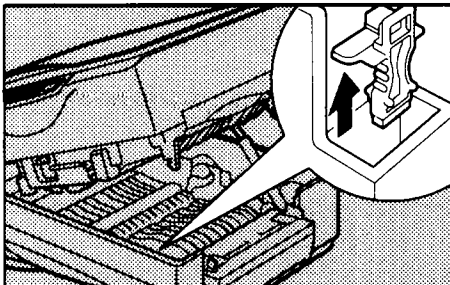

3

Remove tape and take out the small tool for cleaning the corona wires from inside the copier. The tool is placed inside the copier as shown.

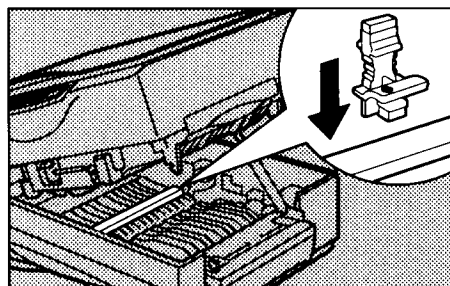

4

Insert the forked end of the tool onto the transfer corona wire as shown.

Note: Be sure to insert the cleaning tool as shown. If you set the tool in the wrong direction, the corona wires may be damaged.

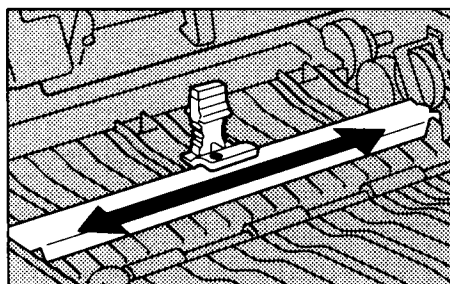

5

Move the tool from right to left (end to end) a few times and remove it.

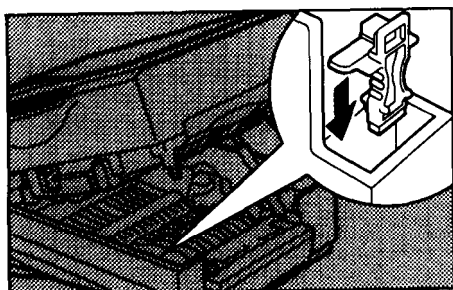

6

Remove the tool from the transfer corona wire and store it as shown.
• Keep this tool inside the copier.

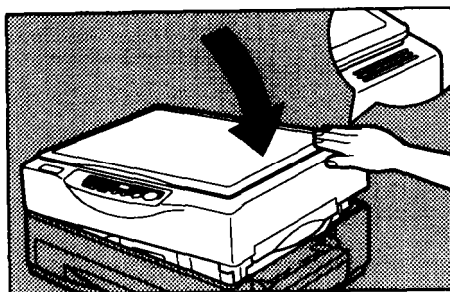

7

Close the top unit by pressing down firmly on the marked position.
Attention: Make sure to press the marked position.

Guide Plates



1

Open the top unit, clean the transfer and transport guide plates with a damp cloth, and wipe them with a dry cloth.

- If you do not clean the guide plates, the leading and trailing edges of the reverse side of copies become dirty.

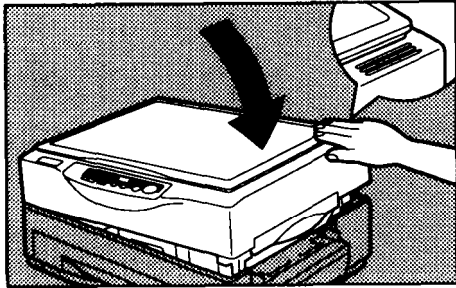

2

Close the top unit by pressing down firmly on the marked position.

Attention: Make sure to press the marked position.

NOTES

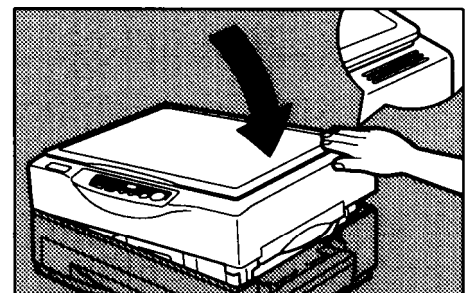
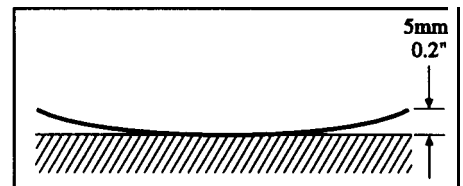

General Operation

- When using transparencies, set one sheet at a time into the bypass feed and open the copy tray. Remove copies delivered to the copy tray one by one.
- When you use translucent paper in low-temperature and low-humidity conditions, it may be misfed. Set the paper aside with paper curl face down until paper is flat with surface. Set one sheet at a time into the bypass feed. Then, deliver the paper to the copy tray.
- Under the following conditions, you might get light copies:
 - When you make 150 or more copies continuously.
 - When you make solid full image copies.
 - When you make copies while the Replenish Toner  indicator is blinking.
- Copies may be curled after coming out of the copier. If necessary, uncurl the paper within 5mm (0.2 in.) of its edges, as shown, before inserting it in the bypass feed to make a two-sided copy.
- Keep the used toner cassette horizontal. If you tilt the unit, toner may spill.
- Do not store the toner cassette in high-temperature and high-humidity conditions.
- If you make copies continuously under high temperatures, the copier may stop to prevent overheating. The Start indicator will turn red and “U!” is displayed on the copy counter. In this case, let the copier cool down, and wait until the Start indicator turns green.
- When you replace the toner cassette and close the top unit, press down firmly on the marked position.



- While copying, do not turn off the main switch.
- While copying, do not open the top unit.
- While copying, do not lift the platen cover.
- While copying, do not unplug the power cord.
- Do not lay anything weighing more than 10kg (22 lb) on the exposure glass.
- Do not place tools or other hard objects on the exposure glass.
- Do not allow paper clips, staples, or other small metallic objects to fall inside the copier.
- Always turn the copier off when you have finished copying for the day.

Replenishing Toner

- Replenish toner when replenish toner  indicator is blinking. When  is continuously lit, copies can no longer be made.
- Before installing a new toner cassette, rock it back and forth, at least five or six times.
- When removing the tapes inside the cassette, make sure to remove the tapes completely.
- Do not insert the toner into the copier until the tapes are completely removed.
- Do not eat or swallow toner, and keep it out of reach of children.
- Replace the toner cassette with the new one, turn the main switch on, and let the copier warm up.
In several seconds, it is ready to make copies in the initial status mode.

Removing Misfed Paper

- Do not leave any torn scraps of paper inside the copier.
- After clearing misfeeds, make sure that all units are returned to their original positions and all covers are closed.
- Do not touch the copy image when removing misfed paper — toner may stain your hands.

STORAGE

Paper

Paper should always be stored properly. Improperly stored paper might result in poor image reproduction, creased copies, or paper misfeeds. Generally, avoid paper curling and absorption of moisture.

- Avoid storing paper in humid areas. In high-temperature and high-humidity, or low-temperature and low-humidity conditions, store paper in a vinyl bag.
- Do not store paper where it will be exposed to heat.
- Store on a flat surface.
- Use older stock first.
- Do not lay heavy objects on paper.
- Keep open reams of paper in the package, and store as you would unopened paper.

Toner Cassette

- Store horizontally in a cool, dark place.
- Never store toner cassette where it will be exposed to heat.
- Do not lay heavy objects on the toner cassette.
- Keep the toner cassette out of children's reach.

REPACKING

If you have to ship the copier for repair or otherwise transport it, pack it in the cardboard box as follows.

If you have not stored the box your copier came in:

Find a cardboard box of approximately 715 x 485 x 353mm (28.1 x 19.1 x 13.9 in.).

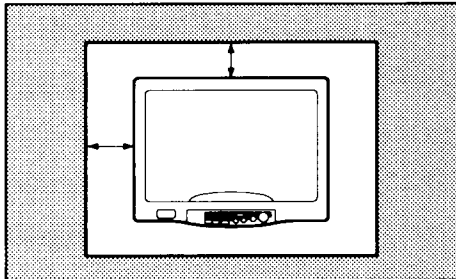

1 Find the box your copier came in.

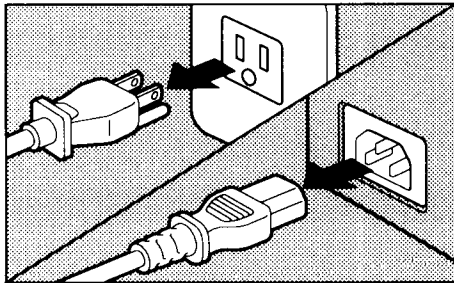

2 Pull out the plug from the outlet and copier.

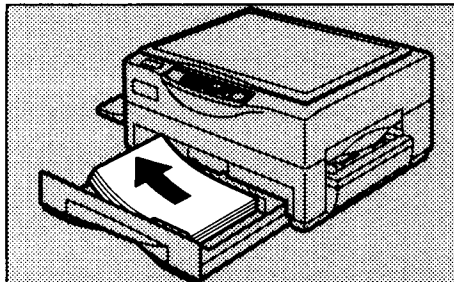

3 Remove paper from the cassette.

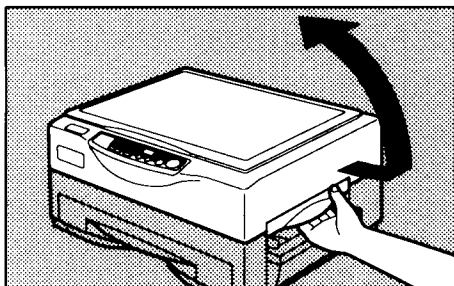

4 Open the top unit.

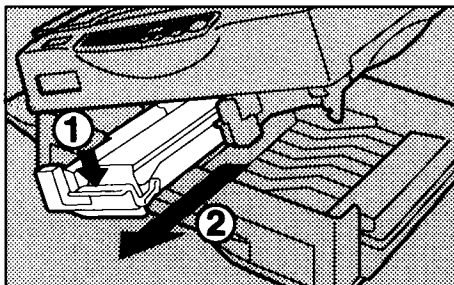

5 Remove the toner cassette.

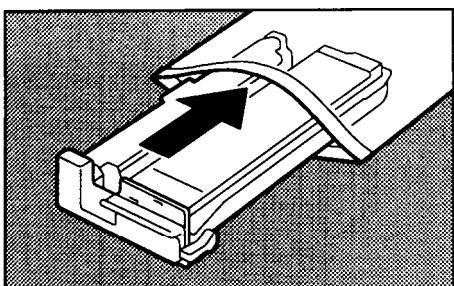

6

Put the toner cassette in a vinyl bag.

CAUTION: To prevent the toner from spilling out, make sure you seal the vinyl bag firmly.

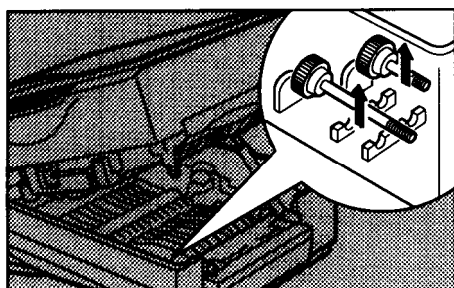

7

Remove the two shipping thumbscrews from inside the copier. (Only short thumbscrew with type 1 model.)

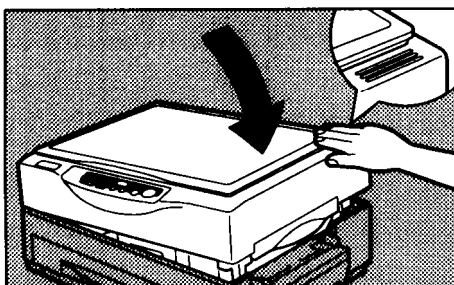

8

Close the top unit by pressing down firmly on the marked position.

Attention: Make sure to press the marked position.

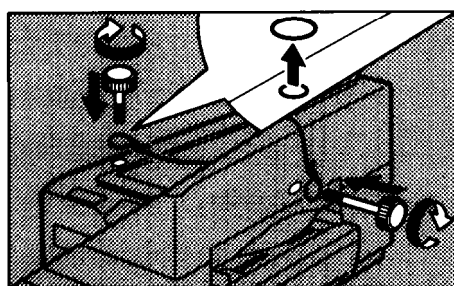

9

Remove the sticker and insert the two shipping thumbscrews into the holes, then tighten them as shown. (Only short thumbscrew with type 1 model.)

• Make sure to insert the shipping thumbscrews to prevent damage while moving the copier.

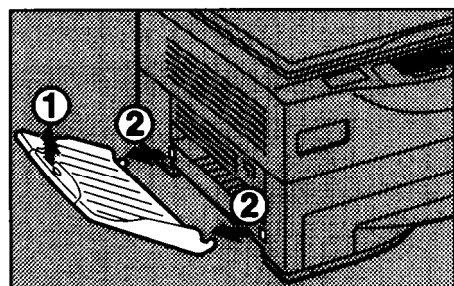

10

Remove copy tray as shown.

First, gently lift it up ①, then pull it out ②.

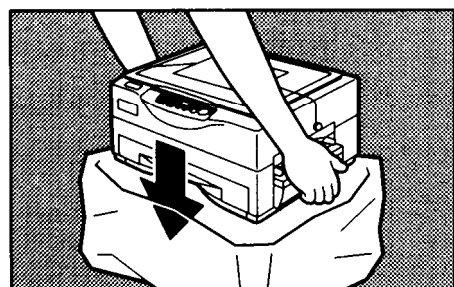

11

Put the copier in the vinyl bag.

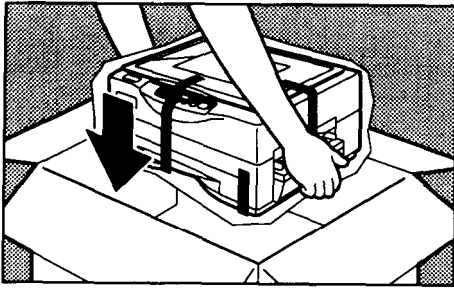

12

Put the copier in the cardboard box.

- Lift the copier from the bottom as illustrated.

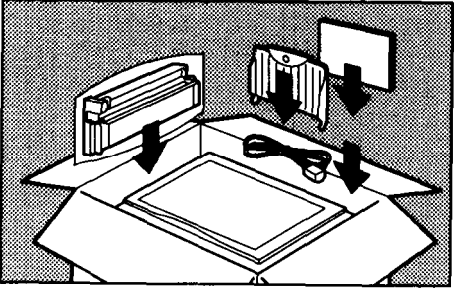

13

Insert the toner cassette, copy tray, operator's manual and power cord into the box.

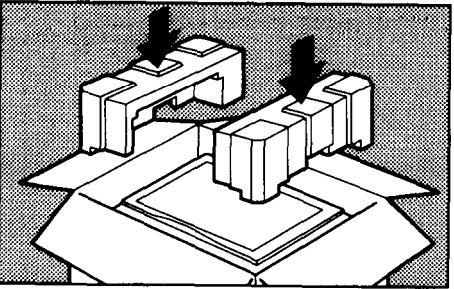

14

Firmly put the foam blocks on the copier.

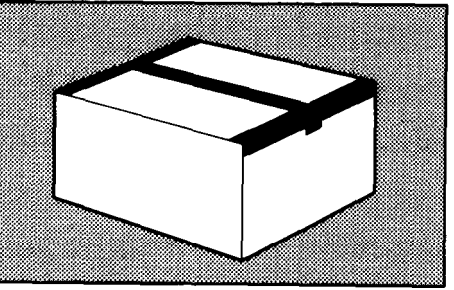

15

Seal the box firmly using tape.

TROUBLESHOOTING



TROUBLESHOOTING	56-57
CLEARING MISFEEDS	58-60
When PE appears on the copy counter ...	59
When * stays on	60

TROUBLESHOOTING

Condition	Cause	Remedy	See Page
Nothing happens when the switch is turned on.	Power cord is not properly plugged into the outlet.	Plug it in firmly.	—
	Top unit is not completely closed.	Check that the both ends of the top unit are securely closed. If not, close the top unit firmly by pressing the marked position.	15
PE is displayed on the copy counter.	Paper cassette is empty.	Load paper.	18
Ⓛ is blinking.	Toner has nearly run out	Replace toner cassette.	42
Ⓛ stays on.	Toner has run out.	Replace toner cassette.	42
✳ stays on.	A misfeed has occurred.	Clear misfed paper.	59
The copier has entered Auto-off mode (30 minutes after a copy was made or a key was pressed).	The copier has shifted to the Auto-off function.	Press any key to re-activate the copier.	21
Copies have white streaks.	Corona wires are dirty.	Clean the corona wires.	45
Copy image density is uneven.			
Ⓛ is displayed on the copy counter.	The copier is overheated.	Wait for a while until the copier cools down and Ⓛ is no longer displayed.	48

ATTENTION: If the error code (E ..) appears, turn off the main switch, then turn it on. If the error code disappears, the copier will function. If the error code appears again, turn off the main switch and immediately call your service personnel.

Condition	Cause	Remedy	See page
Misfeeds occur frequently.	Paper does not meet specification.	Set proper paper. Paper size and weight must comply with the standards set for this copier.	62
	Folded, wrinkled, damp, or curled paper is in the cassette.	Load paper correctly.	18
	Paper is positioned improperly.	Position the end plate and the side guides properly.	17
	A piece of misfed paper or another foreign object is in the copier.	Clear paper path completely of paper and other material.	58
Copies appear dirty.	The original has a gray or colored background.	Adjust the image density.	28
	The image density is too dark.		
	The platen cover or exposure glass is dirty.	Clean platen cover and exposure glass.	44
The reverse side of an original image is copied.	The image density is too dark.	Adjust the image density.	28
Copies are too light.	The original has a low contrast image.		
	The image density is too light.		
	Damp or rough grain paper is used.	Use dry paper without rough grain.	18
The same copy area is dirty whenever making copies.	The platen cover or exposure glass is dirty.	Clean platen cover and exposure glass.	44
Copies are blank or parts of the image are not copied.	The original is not set correctly.	Set originals correctly.	24
	An improper paper size is selected.		17

CLEARING MISFEEDS

When there is a paper misfeed, the Check Paper Path (⚠) indicator or Load Paper (PE) indication on the copy counter will light.



When removing misfed paper, do not touch the fusing unit because it could be very hot.

- Do not leave any torn scraps of paper inside the copier.
- After removing the misfed paper, make sure that all units are returned to their original positions and the top unit is closed.
- When a paper misfeed occurs, the copier keeps track of the selected copy modes and how many copies have been completed. It is not necessary to reset the copy modes or the copy quantity after removing misfed paper.
- Repeat the procedures described in this section until the Check Paper Path ⚠ indicator goes out. (The indicators do not function unless the top unit is closed.)
- Do not touch the copy image when removing misfed paper — toner may stain your hands.

When **PE** appears on the copy counter:

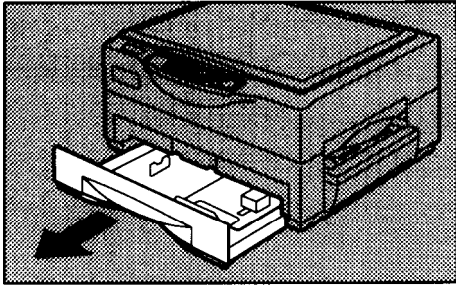

1

Pull out the paper cassette and check if paper remains in the cassette.

- If the paper cassette has run out of paper, load paper. See page 18.

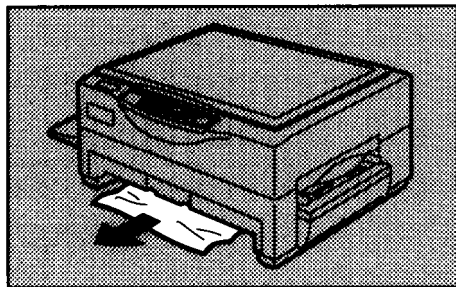

2

Remove the misfed paper completely.

- Make sure that there are no scraps of paper inside the copier.

If paper remains in the paper cassette and there is no misfed paper, follow the steps below.

- 1) Make sure that the end plate and side plates are positioned properly to match the paper size you are using.
- 2) If **PE** is still displayed, change the paper type.
If the **PE** indication does not go out, call for a service representative. See the back cover of this manual for the telephone number.

When is lit:

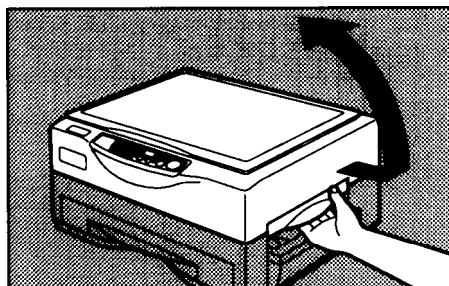

1 Open the top unit.

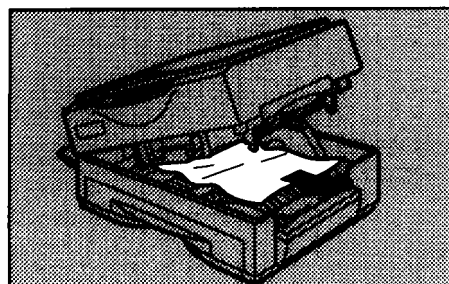

2 Remove the misfed paper completely.
• If it is difficult to remove the misfed paper, gently take it out through the copy tray area.

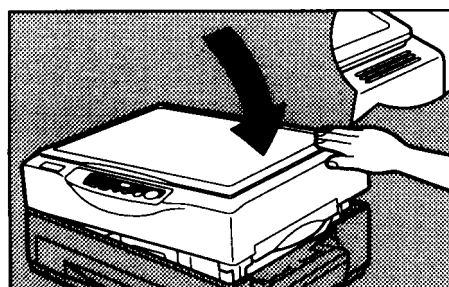

3 Close the top unit by pressing down firmly on the marked position.
• Make sure that the Check Paper Path  indicator is turned off.

SPECIFICATIONS



SPECIFICATIONS 62-63

SPECIFICATIONS

Configuration	Desktop
Copy Process	Dry electrostatic transfer system
Originals	Sheet/Book
Maximum Original Size	A4, 8 1/2 x 14 in.
Copy Paper Size	A5 to A4, 5 1/2 x 8 1/2 to 8 1/2 x 14 in.
Bypass Feed Paper Size	A6 to A4, 5 1/2 x 8 1/2 to 8 1/2 x 14 in.
Copy Paper Weight	Paper tray feed: 60 - 90g/m ² , 16 - 24 lb Bypass feed: 60 - 180g/m ² , 16 - 48 lb

**Reproduction Ratios
(Type 2 only)**

	[Metric version	Inch version
Enlargement	141%	141%
	122%	
Full size	100%	100%
Reduction	82%	93%
	71%	78%
		70%

Zoom (Type 2 only)	From 70% to 141% in 1% increments
Copying Speed	8 copies/minute (A4 lengthwise or 8 1/2 x 11 in. lengthwise)
Warm-Up Time	Less than 15 seconds (at 23°C or 73°F)
First Copy Time	Less than 10 seconds (A4 lengthwise or 8 1/2 x 11 in. lengthwise)
Copy Number Input	+/- key, 1 to 50 (count up or count down)
Manual Image Density Selection	4 steps including halftone
Automatic Reset	1 minute standard setting; can also be set to 3 minutes or no auto reset.

Paper Capacity

Paper cassette:
250 sheets (80g/m², 20 lb)
Bypass feed entrance: 1 sheet (180g/m², 48 lb)

Toner Replenishment

Toner cassette exchange (140g/unit)

Copy Tray Capacity

50 sheets

Power Source

See the inside of the front cover of this manual

Power Consumption

Maximum	1,300W
Copy cycle condition	450W
Warm-up condition	790W
Standby condition	91 W
Auto-off condition	5W

Noise Emission

Sound pressure level
(Measured according to
ISO 7779 at operator
position.)

Less than 55dB

Noise Emission

Sound power level
(Measured according to
ISO 7779)

Standby condition	less than 40dB
Copy cycle condition	less than 62dB

Dimensions

Width	Depth	Height
485mm (19.1 in.)	385mm (15.2 in.)	260mm (10.2 in.)

Weight

Copier with toner cassette:
Less than 16.5kg, 36.4 lb

Specifications are subject to change without notice.

+ and – keys 8

A

ADJUSTING COPY DENSITY 28
 Alignment of Originals 24
 Auto image density 28
 Auto Image Density Indicator 8
 Auto image density level —
 User Mode 1 37
 Auto-off mode for automatically
 saving power 21
 Auto-off duration — User Mode 5 .. 38
 Auto reset duration —
 User Mode 6 39
 Auto Start 25

B

BYPASS FEED COPYING 26-27
 Bypass Feed 6

C

CAUTIONS 5
 Charge Corona Wire 7
 Check Paper Path indicator 8
 Checking the Package Contents 14
 Clear/Stop Key 8
 CLEARING MISFEEDS 58-60
 Copy Counter 8
 Copy Yield 43
 Corona Wires Maintenance 45-46
 Counter up/down – User mode 7 ... 39

D

Darker-side manual image density
 level adjustment — User Mode 2 ... 38
 Daily Maintenance 44

E

Exposure Glass 6
 Exterior — Names/Functions 6

F

FULL-SIZE COPYING 25

G

Guide Plates Maintenance 47

I

Image Density Adjustment 28
 Image Density Adjustment Key 8
 INSTALLATION 14-19
 Installing Copier 15
 Interior — Names/Functions 7

L

Letterhead copying 27
 Lighter-side manual image
 density level adjustment —
 User mode 3 38
 List of User Tools 35
 Loading Copy Paper 18
 Loading Toner Cassette 16

M

MAINTAINING THE COPIER 44-47
 Making Adjustment with
 User Tools 36-40
 MAKING TWO-SIDED
 COPIES 31
 MAKING BOOK COPIES 32
 Manual Image Density 28
 Manual Image Density indicators 8

N

NAME/FUNCTION OF PARTS	6-9
NOTES	48-49
General Operation	48
Replenishing Toner	49
Removing Misfed Paper	49
Notes on copy papers	18
NOTES ON INSTALLATION	
LOCATION	22

O

Operation Panel —	
Names/Functions	8-9
Original and Copy Directions	27

P

Paper misfeeds	58-60
Photo mode level — User mode 4 .	38
PLACEMENT OF ORIGINALS	24
Power Connection	20
Preset Reduce/Enlarge Key	9

R

Recalibrating Copy Density	34
REDUCING/ENLARGING	29-30
Reducing/Enlarging Using Preset	
Ratios	29
REPACKING	51-53
REPLACING THE TONER	
CASSETTE	42-43
Replenish Toner Indicator	8
Reproduction Ratio Indicators	9

S

SAFETY INFORMATION	3-5
Setting Copy Orders During	
Warm-up (Auto Start)	25
Setting or Changing	
Paper Size	17
SPECIFICATIONS	62-63
Start Key	8
STORAGE	50
Paper	50
Toner cassette	50

T

Toner Cassette	7
Total copy counter —	
User mode 8	39, 40
Transparencies copying	27
Transfer Corona Wire	7
TROUBLESHOOTING	56-57
TURNING COPIER ON	20
Two-sided copying	27
Type 1 Operation Panel	8
Type 2 Operation Panel	8-9

U

Unpacking	14
USER TOOLS	35-40
User Tools Menu	37-40

W

WARNINGS	4
----------------	---

Z

Zooming In 1% Increments	30
Zoom Key	9

In accordance with ISO Standard 700 1, this machine uses the following symbols for the main switch:

! means POWER ON.
○ means POWER OFF.



Declaration of Conformity

“The Product complies with the requirements of the **EMC Directive 89/336/EEC** and the **Low Voltage Directive 73/23/EEC**”.



SUPPLIES MODEL NAMES

The correct model name of supplies for
your machine as listed below.
Toner cassette Type 1215

■ Overseas Affiliates

U.S.A.

RICOH CORPORATION
5 **Dedrick** Place
West Caldwell, New Jersey 07006
Phone: +1-973-882-2000

The Netherlands

RICOH EUROPE B.V.
Groenelaan 3, 1186 AA, Amstelveen
Phone: +31-(0)20-5474111

United Kingdom

RICOH UK LTD.
Ricoh House, 1 Plane Tree Crescent,
Feltham, Middlesex, TW1 3 7HG
Phone: +44-(0)181-261-4000

Germany

RICOH DEUTSCHLAND GmbH
Mergenthaler Allee 38-40, 65760
Eschborn
Phone: +49-(0)6196-9060

France

RICOH FRANCE S.A.
383, Avenue du General de Gaulle-
BP 307-92143 Clamart Cedex
Phone: +33-(0)1-40-94-38-38

Spain

RICOH **ESPAÑA** S.A.
Av. Litoral Mar, 12-14, 08005 Barcelona
Phone: +34-(0)93-295-7600

Italy

RICOH ITALIA SpA
Viale, Della Metallurgia 12,
Zona Basson 37139 Verona
Phone: +39-(0)45-8181500

Hong Kong

RICOH HONG KONG LTD.
23/F., China Overseas Building, 139,
Hennessy Road, Wan Chai, Hong Kong
Phone: +852-2862-2888

Singapore

RICOH ASIA PACIFIC PTE. LTD.
260 Orchard Road, #15-01/02
The Heeren, Singapore 238855
Phone: +65-830-5888

RICOH COMPANY, LTD.

15-5, 1 -chome, Minami-Aoyama,
Minato-ku, Tokyo, Japan
Phone: +81(3)3479-3111

Printed in The Netherlands

EE  A2268600B

Free Manuals Download Website

<http://myh66.com>

<http://usermanuals.us>

<http://www.somanuals.com>

<http://www.4manuals.cc>

<http://www.manual-lib.com>

<http://www.404manual.com>

<http://www.luxmanual.com>

<http://aubethermostatmanual.com>

Golf course search by state

<http://golfingnear.com>

Email search by domain

<http://emailbydomain.com>

Auto manuals search

<http://auto.somanuals.com>

TV manuals search

<http://tv.somanuals.com>