

# SKP 500

Instructions for use

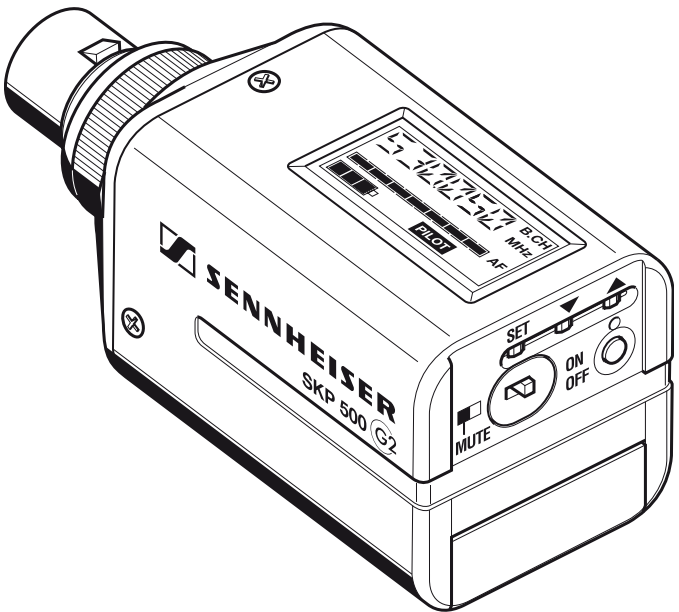



## **Thank you for choosing Sennheiser!**

We have designed this product to give you reliable operation over many years. Over half a century of accumulated expertise in the design and manufacture of high-quality electro-acoustic equipment have made Sennheiser a world-leading company in this field.

Please take a few moments to read these instructions carefully, as we want you to enjoy your new Sennheiser product quickly and to the fullest.

# Contents

The SKP 500 G2 plug-on transmitter .....	4
The channel bank system .....	4
Safety instructions .....	5
Delivery includes .....	5
Areas of application .....	6
The operating controls .....	7
Indications and displays .....	8
Preparing the plug-on transmitter for use .....	10
Inserting and replacing the batteries .....	10
Plugging the plug-on transmitter onto a microphone .....	11
Using the plug-on transmitter .....	12
Switching the plug-on transmitter on/off .....	12
Muting the plug-on transmitter .....	12
Activating/deactivating the lock mode .....	13
The operating menu .....	14
The buttons .....	14
Overview of menus .....	14
Working with the operating menu .....	15
Operating menu of the plug-on transmitter .....	17
Adjustment tips for the operating menu .....	19
Switching between channel banks .....	19
Switching between the channels in a channel bank .	19
Selecting the frequencies to be stored in the channel bank "U" .....	19
Adjusting the sensitivity .....	20
Switching the phantom powering on/off .....	21
Selecting the standard display .....	21
Entering a name .....	21
Loading the factory-preset default settings .....	22
Activating/deactivating the pilot tone transmission	22
Activating/deactivating the lock mode .....	23
Exiting the operating menu .....	23
Troubleshooting .....	24
Error checklist .....	24
Recommendations and tips .....	25
Care and maintenance .....	25
Specifications .....	26
Accessories .....	27
Manufacturer declarations .....	28
Warranty regulations .....	28
CE Declaration of Conformity .....	28
Batteries or rechargeable batteries .....	28
WEEE Declaration .....	28

# The SKP 500 G2 plug-on transmitter

The SKP 500 G2 plug-on transmitter is part of the evolution wireless series ew 500 G2. With this series, Sennheiser offers high-quality state-of-the-art RF transmission systems with a high level of operational reliability and ease of use. Transmitters and receivers permit wireless transmission with studio-quality sound. The excellent transmission reliability of the ew 500 G2 series is based on the use of

- further optimized PLL synthesizer and microprocessor technology,
- the **HDX** noise reduction system,
- and the pilot tone squelch control.

## The channel bank system

The plug-on transmitter is available in five UHF frequency ranges with 1440 transmission frequencies per frequency range. Please note: Frequency usage is different for each country. Your Sennheiser agent will have all the necessary details on the available legal frequencies for your area.

Range A: 518 to 554 MHz  
Range B: 626 to 662 MHz  
Range C: 740 to 776 MHz  
Range D: 786 to 822 MHz  
Range E: 830 to 866 MHz

The plug-on transmitter has nine channel banks with up to 20 switchable channels each.

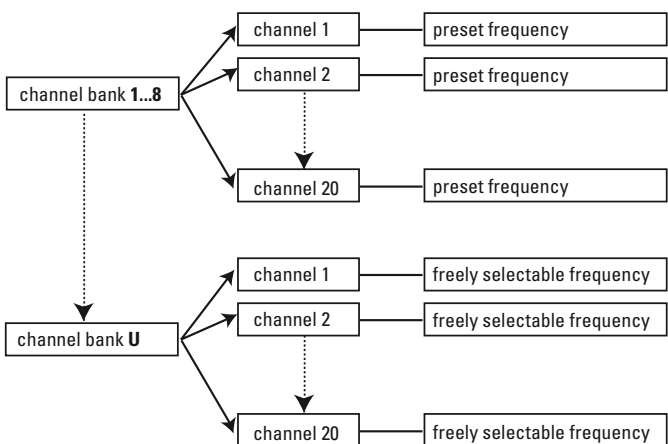

Each of the channels in the channel banks "1" to "8" has been factory-preset to a transmission frequency (see enclosed frequency table). These transmission frequencies cannot be changed but have been preset so that e.g. country-specific regulations on frequency usage are taken into account.

The channel bank "U" (user bank) allows you to store your selection out of 1440 transmission frequencies that are freely selectable within the preset frequency range.

# Safety instructions

Never open an electronic unit! If units are opened by customers in breach of this instruction, the warranty becomes null and void.

Use the unit in dry rooms only.

Use a damp cloth for cleaning the unit. Do not use any cleansing agents or solvents.

## Delivery includes

The packaging contains the following items:

- 1 SKP 500 G2 plug-on transmitter
- 2 batteries
- Instructions for use
- 1 POP 1 Plug-on pouch

Suitable microphones (to be ordered separately) for the plug-on transmitter:



- Dynamic microphones
- Condenser microphones with internal power supply
- Condenser microphones with 48 V phantom powering

# Areas of application

The plug-on transmitter can be combined with receivers of the ew 500 G2 series (EM 500 G2 rack-mount receiver or EK 500 G2 bodypack receiver). The receivers are available in the same five UHF frequency ranges and are equipped with the same channel bank system with factory-preset frequencies. An advantage of the factory-preset frequencies is that

- a transmission system is ready for immediate use after switch-on,
- several transmission systems can be operated simultaneously on the preset frequencies without causing intermodulation interference.

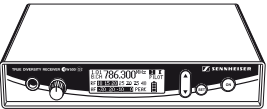
Together with a matching receiver and a microphone, the plug-on transmitter is suitable for the following areas of application:

Transmitter	Receiver (to be ordered separately)	Area of application
SKP 500 G2 	EM 500 G2 	<ul style="list-style-type: none"> <li>• Presentation</li> <li>• Speech</li> <li>• Vocals</li> </ul>
	EK 500 G2 	<ul style="list-style-type: none"> <li>• Presentation</li> <li>• Speech</li> <li>• Vocals</li> <li>• Camera-mounted applications</li> </ul>

# The operating controls

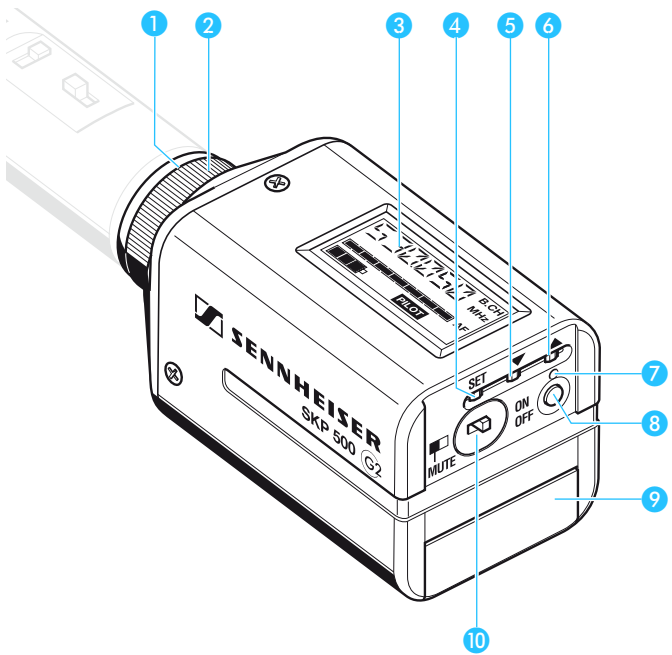

- 1 Microphone input, XLR-3F socket (unbalanced)
- 2 Mechanical locking ring of XLR-3 socket
- 3 LC display
- 4 SET button
- 5 ▼ button (DOWN)
- 6 ▲ button (UP)
- 7 Red LED for operation and battery status indication (ON/LOW BAT)
- 8 ON/OFF button (serves as the ESC (cancel) key in the operating menu)
- 9 Battery compartment cover
- 10 MUTE switch

# Indications and displays

## LC display panel

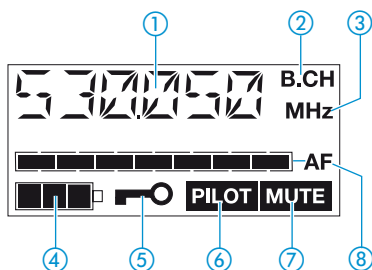

- ① Alphanumeric display
- ② "B.CH" – appears when the channel bank and the channel number are displayed
- ③ "MHz" – appears when the frequency is displayed
- ④ 4-step battery status display
- ⑤ Lock mode icon (lock mode is activated)
- ⑥ "PILOT" display (pilot tone transmission is activated)
- ⑦ "MUTE" display (audio input is muted)
- ⑧ 7-step level display for audio signal "AF"

## Operation and battery status indication

The red LED (LOW BAT/ON) ⑦ provides information on the current operating state of the plug-on transmitter:

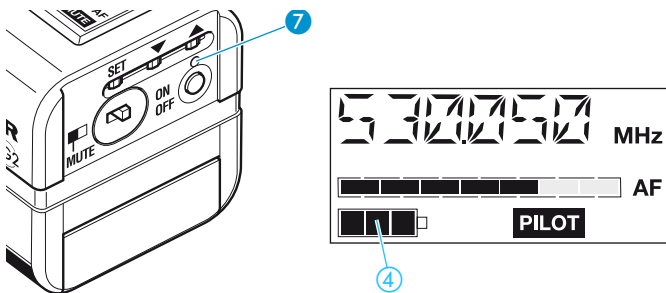

Red LED lit up:

The plug-on transmitter is switched on and the capacity of the batteries/ BA 2015 accupack is sufficient.

Red LED flashing:

The batteries are/the BA 2015 accupack is going flat (LOW BAT)!

In addition, the 4-step battery status display ④ on the display panel provides information on the remaining battery/BA 2015 accupack capacity:

3 segments: capacity approx. 100 %

2 segments: capacity approx. 70 %

1 segment: capacity approx. 30 %

Battery icon flashing: LOW BAT



### “MUTE” display

The “MUTE” display ⑦ appears on the display panel when the plug-on transmitter is muted (see “Muting the plug-on transmitter” on page 12).

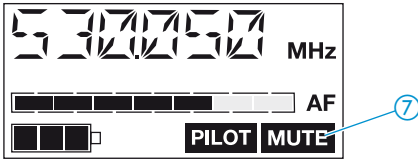

### Modulation display

The level display for audio signal “AF” ⑧ shows the modulation of the plug-on transmitter.

When the audio input level is excessively high, the level display for audio signal “AF” ⑧ shows full deflection for the duration of the overmodulation.

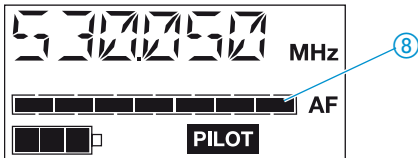

### “PILOT” display

The “PILOT” display ⑥ appears on the display panel when the pilot tone transmission is activated (see “Activating/deactivating the pilot tone transmission” on page 22).

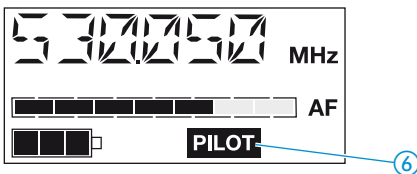

### Display backlighting

After pressing a button, the display remains backlit for approx. 15 seconds.

# Preparing the plug-on transmitter for use

## Inserting and replacing the batteries

For powering the plug-on transmitter, you can either use two 1.5 V AA size batteries or the rechargeable Sennheiser BA 2015 accupack.

- ▶ Slide the battery compartment cover 9 in the direction of the embossed arrow until it clicks audibly and open the cover.

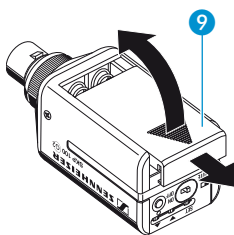

- ▶ Insert the two batteries or the BA 2015 accupack as shown below. Please observe correct polarity when inserting the batteries/accupack.

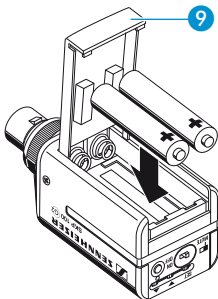

- ▶ Close the battery compartment. The battery compartment cover 9 locks into place with an audible click.

### Note:

For accupack operation of the transmitter, only use the BA 2015 accupack in order to ensure optimum operational reliability. For charging the accupack, only use the L 2015 charger. Both the accupack and the charger are available as accessories.

The accupack is fitted with an integrated sensor which is – via a third contact – monitored by the electronics of the plug-on transmitter and the charger. The sensor is necessary for the following control purposes:

- The taking into account of the different voltage characteristics of primary cells (batteries) and accupacks. The battery status indications on the displays, the transmission of transmitter battery status information to the rack-mount receivers and the switch-off thresholds at the end of the operating

time are corrected correspondingly. Due to the missing sensor, individual rechargeable battery cells will not be identified as accupacks.

- The monitoring of the accupack temperature during charging in the L 2015 charger.

## Plugging the plug-on transmitter onto a microphone

- ▶ Plug the transmitter's XLR-3F socket **1** onto the microphone's XLR-3M socket.

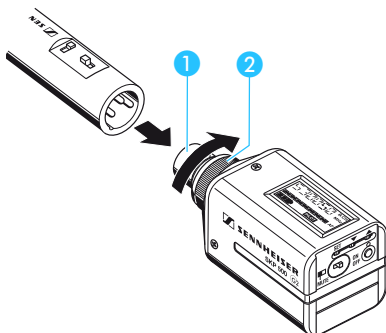

- ▶ Tighten the locking ring **2** as shown.

### Note:

The transmitter uses the microphone body as an antenna – therefore only microphones with a metal casing should be used for best signal transmission.

# Using the plug-on transmitter

## Switching the plug-on transmitter on/off

The transmitter can only be switched off when the standard display is shown on the display panel. When in the operating menu, briefly pressing the **ON/OFF** button will cancel your entry (ESC function) and return you to the standard display with the last stored settings.

### Note:

Remove the batteries or the accupack when the transmitter will not be used for extended periods of time.

- ▶ Press the **ON/OFF** button **8** to switch the transmitter on. The red LED **7** lights up.

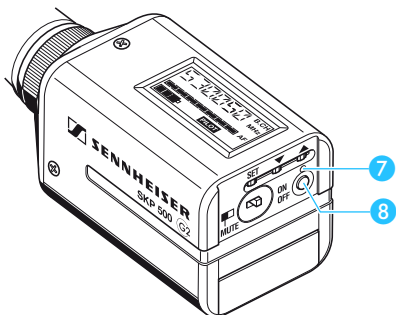

- ▶ To switch the transmitter off, press the **ON/OFF** button **8** until "OFF" appears on the display. The red LED **7** goes off.

## Muting the plug-on transmitter

The transmitter has a **MUTE** switch that noiselessly mutes the audio signal without switching the transmitter off.

- ▶ Set the **MUTE** switch **10** to the position 'MUTE'. The "MUTE" display appears on the display panel. Provided that the pilot tone function is activated on both the transmitter and the receiver, the "MUTE" display also appears on the receiver display panel.

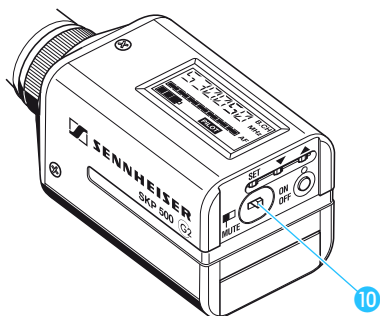

- ▶ Set the **MUTE** switch ⑩ back to the original position to retransmit the audio signal.

## Activating/deactivating the lock mode

The transmitter has a lock mode that can be activated or deactivated via the operating menu (see “Activating/deactivating the lock mode” on page 23). The lock mode prevents that the transmitter is accidentally programmed or switched off during operation.

# The operating menu

A special feature of the Sennheiser ew 500 G2 series is the similar, intuitive operation of transmitters and receivers. As a result, adjustments to the settings can be made quickly and “without looking” – even in stressful situations, for example on stage or during a live show or presentation.

## The buttons

Buttons	Mode	To...
ON/OFF	Standard display	switch the transmitter on and off
	Operating menu	cancel the entry and return to the standard display
	Setting mode	cancel the entry and return to the standard display
SET	Standard display	get into the operating menu
	Operating menu	get into the setting mode of the selected menu
	Setting mode	store the settings and return to the top menu level
▲/▼	Standard display	without function
	Operating menu	change to the previous menu (▲) or change to the next menu (▼)
	Setting mode	adjust the setting of the selected menu: option (▲/▼)

## Overview of menus

Display	Function of the menu
BANK	Switching between channel banks
CHAN	Switching between the channels in a channel bank
TUNE	Setting a transmission frequency for the channel bank “U” (user bank)
SENSIT	Adjusting the sensitivity (AF)
DISPLY	Selecting the standard display
PHANTO	Switching the phantom powering on/off
NAME	Entering a name
RESET	Loading the factory-preset default settings
PILOT	Activating/deactivating the pilot tone transmission
LOCK	Activating/deactivating the lock mode
EXIT	Exiting the operating menu and returning to the standard display

## Working with the operating menu

By way of example of the "TUNE" menu, this section describes how to use the operating menu.

After switching the transmitter on, the standard display is shown on the display panel.

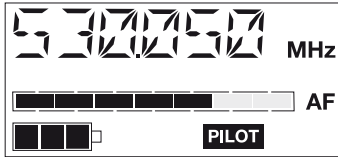

### Getting into the operating menu

- ▶ Press the **SET** button to get from the standard display into the operating menu. The last selected menu flashes on the display.

### Selecting a menu

- ▶ Press the **▲/▼** buttons to select a menu.



- ▶ Press the **SET** button to get into the setting mode of the selected menu. The current setting that can be adjusted flashes on the display.

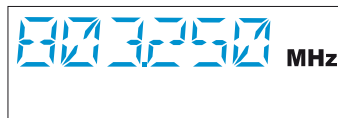

### Adjusting a setting

- ▶ Press the **▲/▼** buttons to adjust the setting.



By briefly pressing the **▲/▼** buttons, the display jumps either forwards or backwards to the next setting. In the "CHAN", "TUNE" and "NAME" menu, the **▲/▼** buttons feature a "fast search" function. If you hold down a button, the display cycles continuously, allowing you to get fast and easily to your desired setting.

## Storing a setting

- ▶ Press the **SET** button to store the setting. "STORED" appears on the display, indicating that the setting has been stored. The display then returns to the top menu level.



With most menus, new settings become effective immediately without having to be stored. An exception are the "BANK", "CHAN", "TUNE" and "RESET" menus. With these menus, new settings only become effective after they have been stored ("STORED" appears on the display, indicating that the setting has been stored).

## Exiting the operating menu

- ▶ Select the "EXIT" menu to exit the operating menu and to return to the standard display.



When in the operating menu, briefly pressing the **ON/OFF** button will cancel your entry (ESC function) and return you to the standard display with the last stored settings.



# Operating menu of the plug-on transmitter

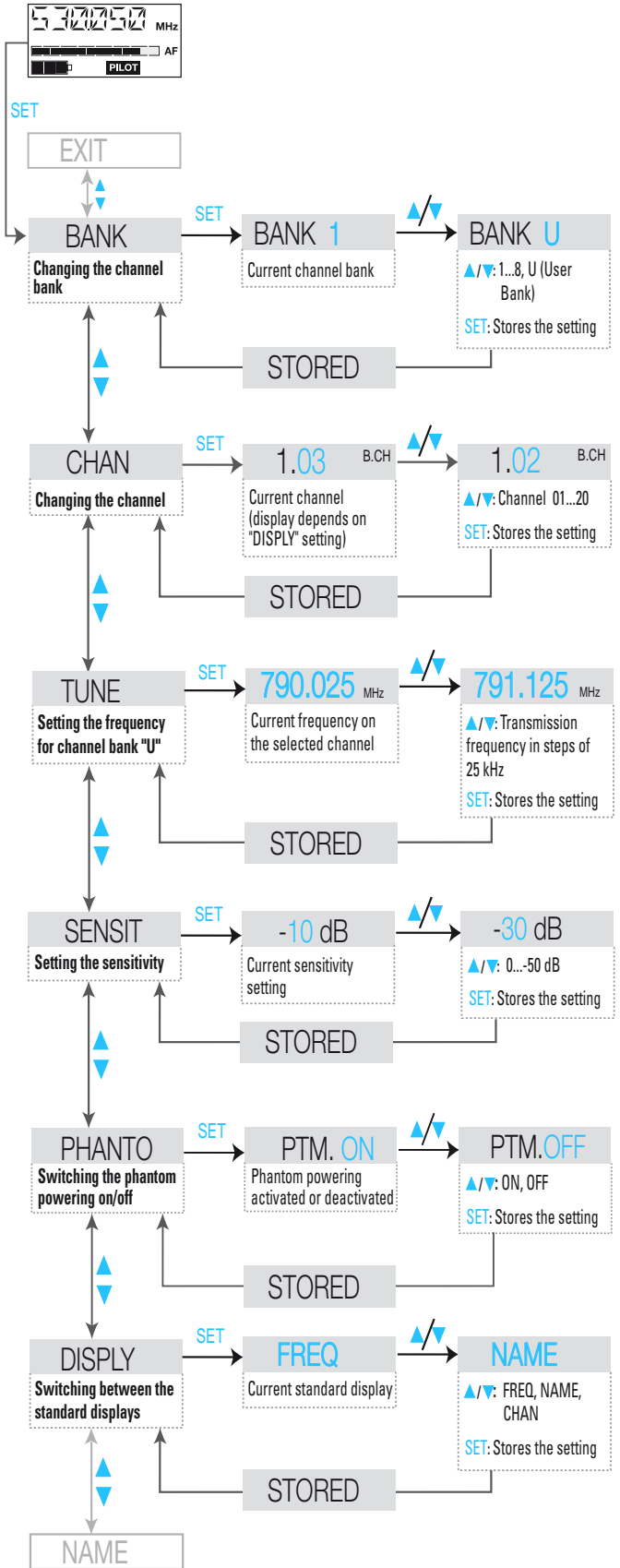

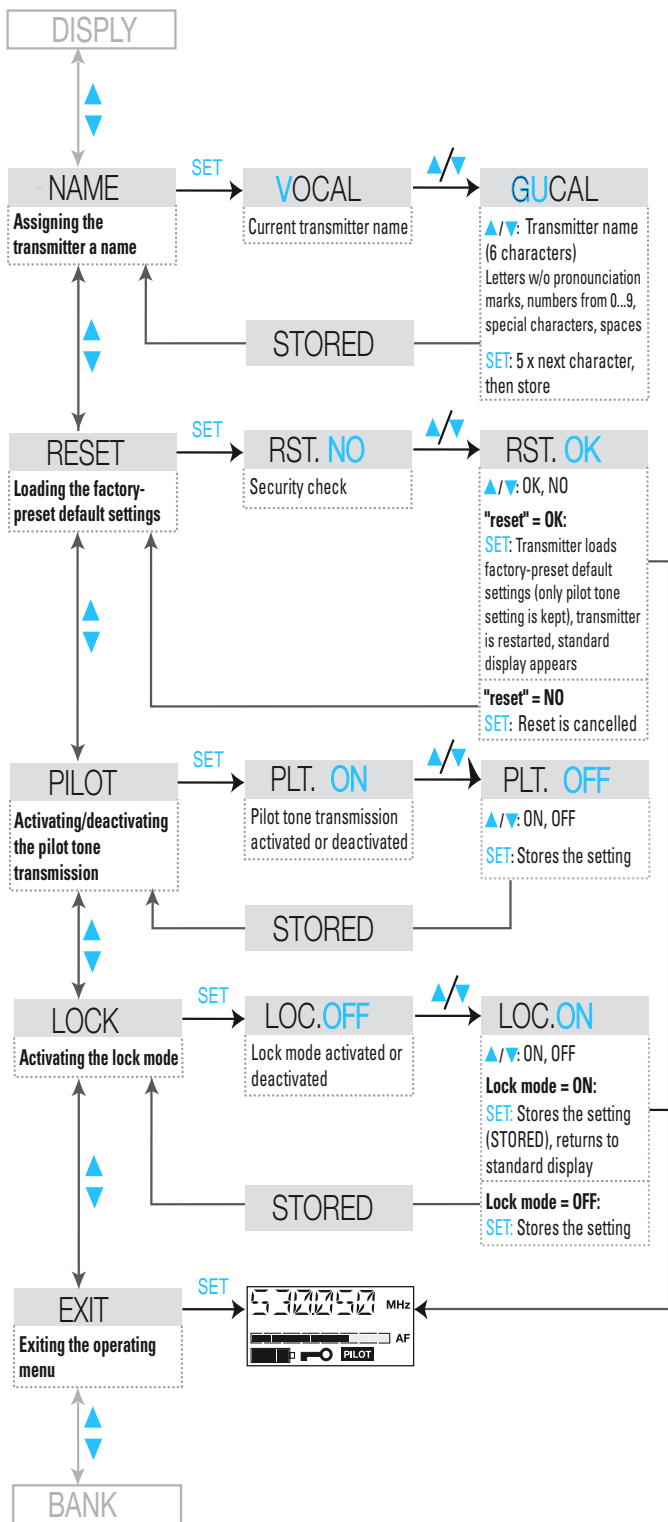

# Adjustment tips for the operating menu

## Switching between channel banks – **BANK**

Via the "**BANK**" menu, you can switch between the transmitter's nine channel banks. Each of the channel banks "1" to "8" has up to 20 switchable channels that are factory-preset to a transmission frequency (see "The channel bank system" on page 4). The channel bank "U" (user bank) has up to 20 switchable channels to store your selection out of 1440 transmission frequencies that are freely selectable within the preset frequency range.

When switching from one channel bank to another, the channel with the lowest channel number is automatically displayed.

## Switching between the channels in a channel bank – **CHAN**

Via the "**CHAN**" menu, you can switch between the different channels in a channel bank. When switching between the channels, please observe the following:

Always set the transmitter and the receiver of a transmission link to the same channel.

### Multi-channel operation

Combined with ew 500 G2 receivers, the transmitter can form transmission links that can be used in multi-channel systems. For multi-channel operation, only use the free channels in a channel bank.

Before putting the transmission links into operation, we recommend performing an auto scan (see operating manual of the receiver).

## Selecting the frequencies to be stored in the channel bank "U" – **TUNE**

Via the "**TUNE**" menu, you can select the frequencies to be stored in the channel bank "U" (user bank).

When you have selected one of the channel banks "1" to "8" and then select the "**TUNE**" menu, the transmitter automatically switches to channel 01 of the channel bank "U". In this case, "U.01" briefly appears on the display.



- ▶ Use the ▲/▼ buttons to select the desired transmission frequency. Transmission frequencies are tunable in 25-kHz steps within a switching bandwidth of 36 MHz max. For intermodulation-free frequencies, please refer to the enclosed frequency table.

## Adjusting the sensitivity – SENSIT

Via the “SENSIT” menu, you can adjust the transmitter’s input sensitivity.

The input sensitivity is adjusted too high when close talking distances, speakers with loud voices or loud music passages cause overmodulation in the transmission link. When the audio input level is excessively high (AF peak), the level display for audio signal “AF” ⑧ shows full deflection.

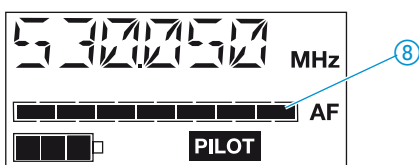

If, on the other hand, the sensitivity is adjusted too low, the transmission link will be undermodulated, which would result in a signal with high background noise.

The sensitivity is correctly adjusted when the level display for audio signal “AF” ⑧ shows full deflection only during the loudest passages.

### Note:

For monitoring the adjusted sensitivity, the transmitter’s level display for audio signal “AF” always indicates the audio level – even if the transmitter is muted.

The following figures are a guide to the best settings:

- Loud music/vocals: –30 to –20 dB
- Presentations: –20 to –10 dB
- Interviews: –10 to 0 dB

In order to be able to use highly sensitive directional condenser microphones, the plug-on transmitter offers a sensitivity range extended by 20 dB.

With the transmitter plugged onto a directional condenser microphone, the following figures are a guide to the best settings:



- Loud music/vocals: –50 to –40 dB
- Presentations: –40 to –30 dB
- Interviews: –30 to –20 dB

## Switching the phantom powering on/off – PHANTO

The plug-on transmitter can supply condenser microphones without internal power supply with 48 V phantom powering (P 48). The phantom powering can be switched on or off via the “PHANTO” menu. Please note: Dynamic microphones can be operated in phantom powering mode without harm. However, if no condenser microphone module is being used, you should switch off the phantom powering. With the phantom powering switched on, the operating time of the batteries or the BA 2015 accupack will be reduced.

## Selecting the standard display – DISPLY

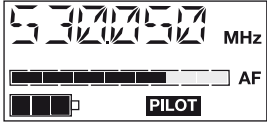
Via the “DISPLY” menu, you can select the standard display:

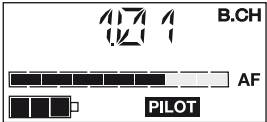
Selectable standard display	Contents of standard display
“FREQ”	
“NAME”	
“CHAN”	

## Entering a name – NAME

Via the “NAME” menu, you can enter a freely selectable name for the transmitter. You can, for example, enter the name of the performer for whom the adjustments have been made.

The name can be displayed on the standard display and can consist of up to six characters such as:

- letters (without pronunciation marks),
- numbers from 0 to 9,
- special characters e.g. ( ) - . \_ and spaces.

To enter a name, proceed as follows:

- ▶ Press the **SET** button to get into the setting mode of the “NAME” menu. The first segment starts flashing on the display.
- ▶ With the **▲/▼** buttons you can now select a character. By briefly pressing a button, the display jumps either forwards or backwards to the next character. If you hold down a button, the display starts cycling continuously.

- ▶ Press the **SET** button to change to the next segment and select the next character.
- ▶ Have you entered the name completely? Press the **SET** button to store your setting and to return to the top menu level.

## Loading the factory-preset default settings – **RESET**

Via the “**RESET**” menu, you can load the factory-preset default settings. Only the selected setting for the pilot tone remains unchanged. After the reset, the transmitter is restarted and the standard display is shown on the display panel.

## Activating/deactivating the pilot tone transmission – **PILOT**

Via the “**PILOT**” menu, you can activate or deactivate the pilot tone transmission.

The pilot tone supports the receiver’s squelch function (Squelch) and protects against interference due to RF signals from other units. The transmitter adds an inaudible signal, known as the pilot tone, to the transmitted signal. The receiver detects and evaluates the pilot tone, and is thus able to identify the signal of the matching transmitter and mute all others.

Transmitters of the ew 500 series (first generation) do not transmit a pilot tone and the receivers of the ew 500 series (first generation) cannot evaluate the pilot tone. Nevertheless, you can combine the plug-on transmitter with a receiver of the first generation. However, when combining units, please observe the following:

- With the ew 500 G2 plug-on transmitter and an ew 500 G2 receiver:  
Activate the pilot tone function with both transmitter and receiver.
- With the ew 500 G2 plug-on transmitter and an ew 500 receiver or vice versa:  
Deactivate the pilot tone function with the ew 500 G2 transmitter or receiver.

## Activating/deactivating the lock mode – LOCK

Via the “**LOCK**” menu, you can activate or deactivate the lock mode.

The lock mode prevents that the transmitter is accidentally programmed or switched off during operation. The lock mode icon ⑦ on the display indicates that the lock mode is activated.

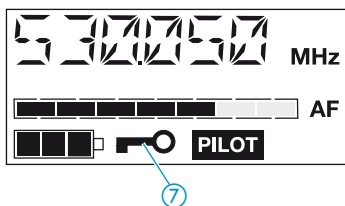

To deactivate the lock mode, first press the **SET** button and then press the **▲/▼** buttons to select “**LOC.OFF**”. If you confirm your selection by pressing the **SET** button, the buttons can be operated as usual.

## Exiting the operating menu – EXIT

Via the “**EXIT**” menu, you can exit the operating menu and return to the standard display.

# Troubleshooting

## Error checklist

Problem	Possible cause	Possible solution
No operation indication	Batteries are flat or accupack is flat	Replace the batteries or recharge the accupack
No RF signal	Transmitter and receiver are not on the same channel	Set transmitter and receiver to the same channel
	Transmitter is out of range	Check the squelch threshold setting or reduce the distance between transmitter and receiving antenna
RF signal available, no audio signal, "MUTE" display appears on the display panel	Transmitter is muted (MUTE)	Deactivate the muting function
	Receiver's squelch threshold is adjusted too high	Reduce the squelch threshold
	Transmitter doesn't transmit a pilot tone	Activate the pilot tone transmission
Audio signal has a high level of background noise	Transmitter sensitivity is adjusted too low	See "Adjusting the sensitivity" on page 20
	Receiver's AF output level is adjusted too low	Increase the audio output level
Audio signal is distorted	Transmitter sensitivity is adjusted too high	See "Adjusting the sensitivity" on page 20
	Receiver's AF output level is adjusted too high	Reduce the AF output level

If problems occur that are not listed in the above table or if the problems cannot be solved with the proposed solutions, please contact your local Sennheiser agent for assistance.



## Recommendations and tips

### ... for the plug-on transmitter

- Use microphones with a metal casing, since the transmitter uses the microphone body as an antenna.
- You can vary the bass reproduction by increasing/decreasing the talking distance.
- For best results, make sure that the transmitter sensitivity is correctly adjusted.

### ... for optimum reception

- Transmission range depends to a large extent on location and can vary from about 10 m to about 150 m. There should be a "free line of sight" between transmitting and receiving antennas.
- To avoid overmodulating the receiver, observe a minimum distance of 5 m between transmitting and receiving antennas.

### ... for multi-channel operation

- For multi-channel operation, you can only use the channels in a channel bank. Each of the channel banks "1" to "8" accommodates up to 20 factory-preset frequencies which are intermodulation-free. For alternative frequency combinations, please refer to the enclosed frequency table. The freely selectable frequencies can be selected via the "TUNE" menu and can be stored in the channel bank "U".
- When using several transmitters simultaneously, interference can be avoided by maintaining a minimum distance of 20 cm between two transmitters.

## Care and maintenance

Use a slightly damp cloth to clean the transmitter from time to time.

### Note:

Do not use any cleansing agents or solvents.

# Specifications

## RF characteristics

Modulation	wideband FM
Frequency ranges	518–554, 626–662, 740–776, 786–822, 830–866 MHz
Transmission frequencies	8 channel banks with up to 20 factory-preset channels each  1 channel bank with up to 20 freely selectable channels (1440 frequencies, tunable in steps of 25 kHz)
Switching bandwidth	36 MHz
Nominal/peak deviation	$\pm 24$ kHz / $\pm 48$ kHz
Frequency stability	$\leq \pm 15$ ppm
RF output power at 50 $\Omega$	typ. 30 mW

## AF characteristics

Noise reduction system	Sennheiser <a href="#">HDX</a>
AF frequency response	40–18,000 Hz
S/N ratio (at 1 mV and peak deviation)	$\geq 110$ dB(A)
THD (at nominal deviation and 1 kHz)	$\leq 0.9$ %
Max. input voltage (at peak deviation)	2.8 V <sub>rms</sub> (unbalanced)

## Overall unit

Power supply	2 AA size batteries, 1.5 V or BA 2015 accupack
Nominal voltage	2.4 V
Microphone phantom powering	48 V $\pm$ 4 V (at 2 mA)
Max. power consumption:	
• at nominal voltage	$\leq 170$ mA
• with switched-on phantom powering	$\leq 290$ mA
• with switched-off transmitter	$\leq 250$ $\mu$ A
Operating time:	
• with batteries	> 8 h
• with batteries and switched-on phantom powering	> 5 h
• with BA 2015 accupack	> 8 h
• with accupack and switched-on phantom powering	> 5 h
Temperature range	–10 °C to +55 °C
Dimensions [mm]	105 x 43 x 43
Weight (incl. batteries)	approx. 195 g

# Accessories

BA 2015

Accupack

L 2015

Charger for BA 2015 accupack

POP 1

Plug-on pouch

CC 2

Carrying case for ew 500 G2 system

# Manufacturer declarations

## Warranty regulations

The guarantee period for this Sennheiser product is 24 months from the date of purchase. Excluded are accessory items, rechargeable or disposable batteries that are delivered with the product; due to their characteristics these products have a shorter service life that is principally dependent on the individual frequency of use.

The guarantee period starts from the date of original purchase. For this reason, we recommend that the sales receipt be retained as proof of purchase. Without this proof (which is checked by the responsible Sennheiser service partner) you will not be reimbursed for any repairs that are carried out.

Depending on our choice, guarantee service comprises, free of charge, the removal of material and manufacturing defects through repair or replacement of either individual parts or the entire device. Inappropriate usage (e.g. operating faults, mechanical damages, incorrect operating voltage), wear and tear, force majeure and defects which were known at the time of purchase are excluded from guarantee claims. The guarantee is void if the product is manipulated by non-authorized persons or repair stations.

In the case of a claim under the terms of this guarantee, send the device, including accessories and sales receipt, to the responsible service partner. To minimize the risk of transport damage, we recommend that the original packaging is used. Your legal rights against the seller, resulting from the contract of sale, are not affected by this guarantee.

The guarantee can be claimed in all countries outside the U.S. provided that no national law limits our terms of guarantee.

## CE Declaration of Conformity



This equipment is in compliance with the essential requirements and other relevant provisions of Directives 1999/5/EC, 89/336/EC or 73/23/EC. The declaration is available on the internet site at [www.sennheiser.com](http://www.sennheiser.com).

Before putting the device into operation, please observe the respective country-specific regulations!

## Batteries or rechargeable batteries



The supplied batteries or rechargeable batteries can be recycled. Please dispose of them as special waste or return them to your specialist dealer. In order to protect the environment, only dispose of exhausted batteries.

## WEEE Declaration



Your Sennheiser product was developed and manufactured with high-quality materials and components which can be recycled and/or reused. This symbol indicates that electrical and electronic equipment must be disposed of separately from normal waste at the end of its operational lifetime.

Please dispose of this product by bringing it to your local collection point or recycling centre for such equipment. This will help to protect the environment in which we all live.



Sennheiser electronic GmbH & Co. KG  
30900 Wedemark, Germany  
Phone +49 (5130) 600 0  
Fax +49 (5130) 600 300  
[www.sennheiser.com](http://www.sennheiser.com)

Printed in Germany

Publ. 02/06

090661/A2

Download from [Www.Somanuals.com](http://Www.Somanuals.com). All Manuals Search And Download.

## Free Manuals Download Website

<http://myh66.com>

<http://usermanuals.us>

<http://www.somanuals.com>

<http://www.4manuals.cc>

<http://www.manual-lib.com>

<http://www.404manual.com>

<http://www.luxmanual.com>

<http://aubethermostatmanual.com>

Golf course search by state

<http://golfingnear.com>

Email search by domain

<http://emailbydomain.com>

Auto manuals search

<http://auto.somanuals.com>

TV manuals search

<http://tv.somanuals.com>