

ADN-W AM

Antenna Module



Instruction manual

Contents

- For your safety 1
- The ADN-W AM antenna module 1
- Package contents 2
- Components required for wireless operation 3
- Product overview ADN-W AM 4
- Preparing the antenna module for operation 5
 - Connecting the antennas 5
 - Connecting the antenna module to the mains power supply 6
- Setting up and positioning the antenna module 7
- Connecting the ADN-W AM antenna module to the ADN CU1 central unit 10
- Switching the antenna module on/off 11
- Configuring the wireless components 12
- Cleaning and maintaining the antenna module 13
- Specifications ADN-W AM 13

For your safety



Please make sure to read the “Safety information” supplement included separately with the ADN CU1 central unit. This supplement contains important information on the safe operation of the ADN conference system as well as the manufacturer’s declaration and warranty notes.



www.sennheiser.com

A detailed instruction manual for the overall ADN conference system can be found

- on the Internet at www.sennheiser.com or
- on the DVD-ROM supplied with the ADN CU1 central unit.

The ADN-W AM antenna module

The ADN-W AM antenna module is part of the Sennheiser ADN conference system.

When connected to the ADN CU1 central unit, the ADN-W AM antenna module controls the RF data transmission to and from the ADN-W D1 and ADN-W C1 wireless conference units.

Package contents

- 1 ADN-W AM antenna module with 3 rod antennas (ADN-W AM or ADN-W AM-US version)
- 1 SDC CBL RJ45-5 system cable, length 5 m
- 1 thread insert (5/8" to 3/8")
- 1 instruction manual

Intended use

Intended use of the products includes

- using the products for professional purposes,
- having read and understood the safety instructions and the ADN system manual,
- using the products within the operating conditions and limitations described in the ADN system manual.

“Improper use” means using the products other than as described in the ADN system manual, or under operating conditions which differ from those described therein.



www.sennheiser.com

All instruction manuals for components of the ADN conference system are also available on the Internet at www.sennheiser.com.

Components required for wireless operation

Central unit

Number	Description	Cat. No.	Function
1	ADN CU1-EU central unit, EU version	505553	Controls the conference (wired and wireless components) and supplies power to the ADN-W AM antenna module
	ADN CU1-UK central unit, UK version	505554	
	ADN CU1-US central unit, US version	505555	

Wireless conference units

Number	Description	Cat. No.	Function
max. 150	ADN-W D1 wireless delegate unit	504748	Allows to make contributions to the conference
1 - 10 (optional)	ADN-W C1 wireless chairperson unit	504745	Allows to manage the conference
depending on the number of wireless conference units	ADN-W BA battery pack	504744	Supplies power to wireless conference units
	ADN-W MIC 15-39	504750	Gooseneck microphones to make contributions
	ADN-W MIC 36-29	504751	
	ADN-W MIC 15-50	504752	
ADN-W MIC 36-50	504753		

Optional power supply



Number	Description	Cat. No.	Function
1 (optional)	NT 12-50C-EU power supply, EU version	505712	Supplies power to the ADN-W AM antenna module if the power supply from the central unit via the system cable is not sufficient
	NT 12-50C-UK power supply, UK version	505713	
	NT 12-50C-US power supply, US version	505714	

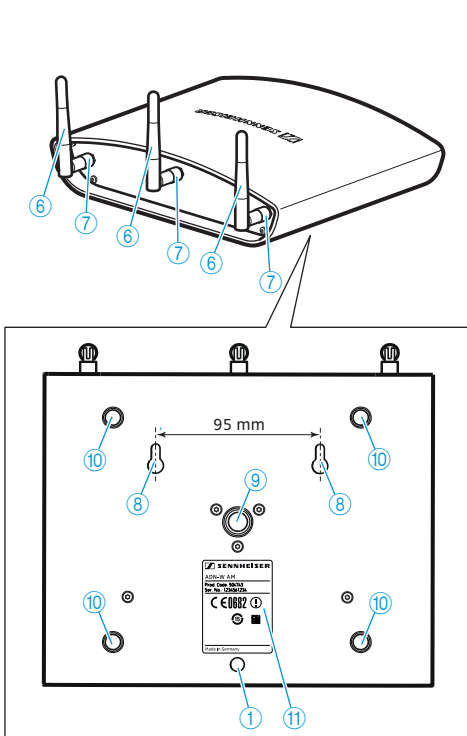
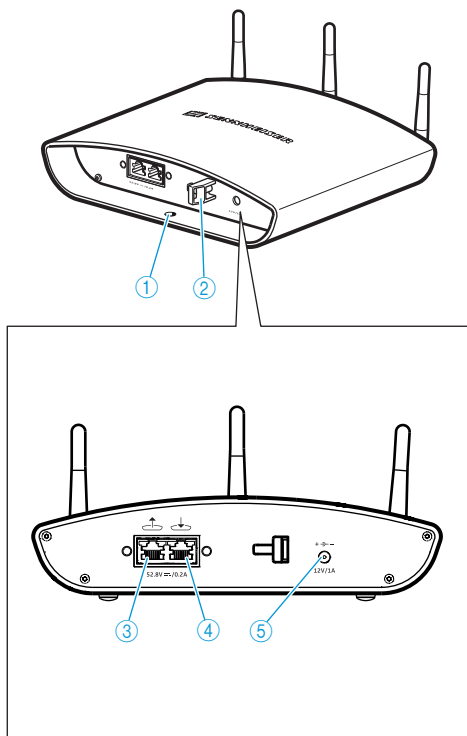

Additional accessories for the ADN conference system can be found at www.sennheiser.com.

Product overview ADN-W AM



- ① Hole for safety wire
- ② Cable grip
- ③ Output socket 
- ④ Input socket 
- ⑤ Hollow jack socket for connection of optional NT 12-50C power supply
- ⑥ Antennas

- ⑦ Antenna coupling ring
- ⑧ Mounting holes for wall mounting
- ⑨ 5/8" mounting thread with 3/8" thread insert
- ⑩ Rubber feet
- ⑪ Type plate

Preparing the antenna module for operation

Connecting the antennas

Always use all 3 antennas to ensure reliable wireless operation. The 3 antennas are connected upon delivery.

CAUTION

Radio communication outside the legal requirements!

When connecting antennas other than the supplied ones, the transmission power of the conference system may not meet the legal requirements and may cause interference to other radio equipment.

▶ Only connect the supplied rod antennas to the antenna module.

-
- ▶ Connect the 3 antennas ⑥ to the 3 antenna sockets.
 - ▶ Screw down the 3 antenna coupling rings ⑦ as shown. The antennas are connected and secured.

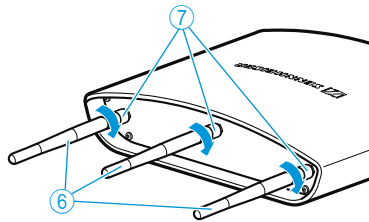

Connecting the antenna module to the mains power supply

The antenna module is powered from the ADN CU1 central unit via the SBC CBL RJ45 system cable.

i If the power supplied via the system cable is not sufficient and if the antenna module is not listed in the central unit's operating menu under "System Menu" > "Versions" > "Hardware Version Info" or "Software Version Info":

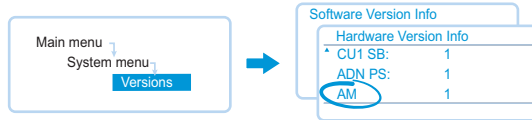

▶ Use the optional NT 12-50C power supply.

CAUTION

Product damage due to an unsuitable power supply!

If you use an unsuitable power supply, this can cause damage to the ADN-W AM antenna module.

- ▶ Only connect the NT 12-50C power supply to the antenna module.
- ▶ Connect the hollow jack plug ② of the NT 12-50C power supply to the hollow jack socket ⑤.

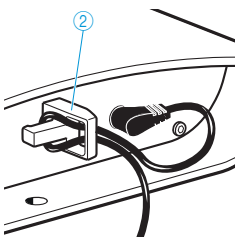
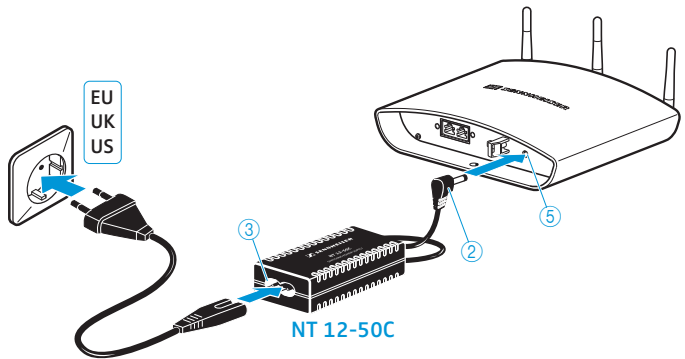

- ▶ Pass the cable through the cable grip ② as shown.
- ▶ Connect the Euro 8 connector of the mains cable to the socket ③ of the NT 12-50C power supply.
- ▶ Connect the mains plug of the mains cable to a wall socket.

Setting up and positioning the antenna module



CAUTION

Danger of injury and material damage!

If improperly installed or insufficiently fixed, the antenna module can fall from the wall, ceiling or stand or tip over and can cause injury or material damage.

- ▶ Protect the antenna module against tipping or dropping by means of a safety wire which is attached to a separate hook.
- ▶ Always have the antenna module mounted by a qualified specialist according to local, national and international regulations and standards.

The antenna module can be:

- mounted to a wall or ceiling by means of a ball joint (optional accessory),
- mounted to a stand or
- placed on a flat surface (e.g. table)

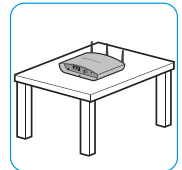
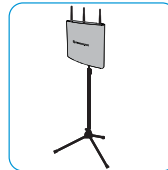
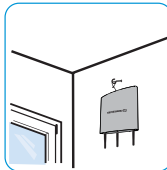
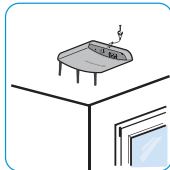

Further information on mounting the antenna module can be found in the ADN system manual.

CAUTION

Danger of intermodulation!

If you set up the antenna module and the wireless conference units too close to one another, intermodulation can occur.

- ▶ Observe a minimum distance:
 - of 1 m between the antenna module and the wireless conference units and
 - of 0.5 m between the wireless conference units.

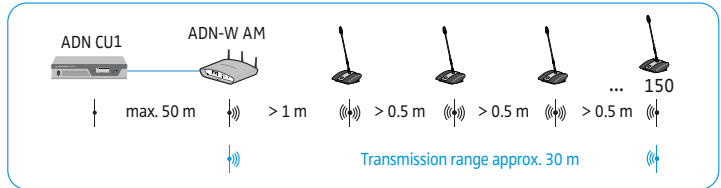

The transmission range of the antenna module and the wireless conference units is approx. 30 m. The transmission range can vary depending on location and environmental conditions such as wall thickness, wall composition etc.

i In some countries/regions (e.g. Canada), the use of wireless components operating in the 5.15 to 5.25 GHz frequency band (channel 5 to 8) is restricted to indoor use.

- ▶ Do not obstruct the antennas of the antenna module and the wireless conference units with any object.
- ▶ Set up the devices so that there is a “free line of sight” between the wireless conference units and the antenna module.
- ▶ Place the antenna module as centrally as possible and above the wireless conference units.
- ▶ Orient the 3 antennas of the antenna module so that they are parallel to each other and are directed at a 90° angle towards the wireless conference units.

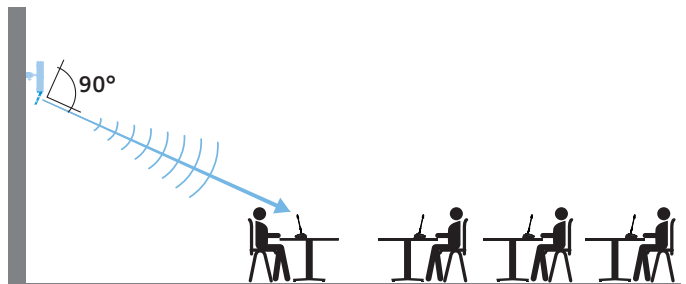
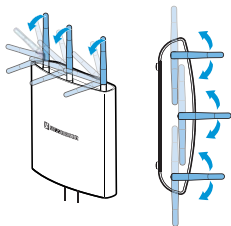

Ceiling mounting is recommended for rooms with a ceiling height of up to approx. 10 m:

- ▶ Mount the antenna module to the center of the ceiling.
- ▶ Orient the antennas horizontally and at a 90° angle with respect to the wireless conference units.

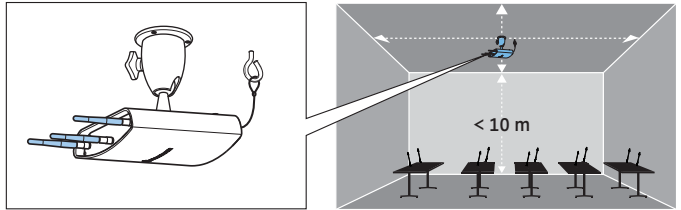

Wall mounting is recommended for rooms with a ceiling height of more than 10 m because the wireless conference units have an omni-directional radiation pattern (approx. 30 m):

- ▶ Mount the antenna module to the wall at a height of max. 10 m from the floor.
- ▶ Attach the antenna module upside down so that the antennas point downwards.
- ▶ Slightly turn the antennas so that they are directed at a 90° angle towards the wireless conference units.

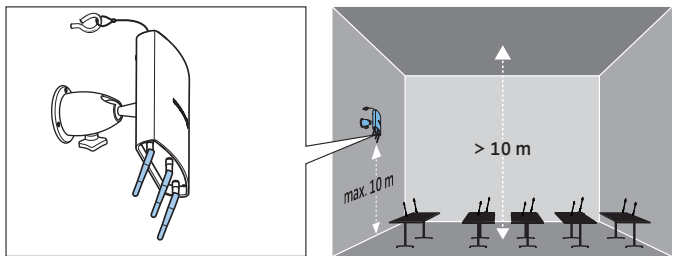

To minimize restrictions in the transmission range:

- ▶ Avoid placing the antenna module outside the conference room, behind support columns or boardings or next to other radio equipment.

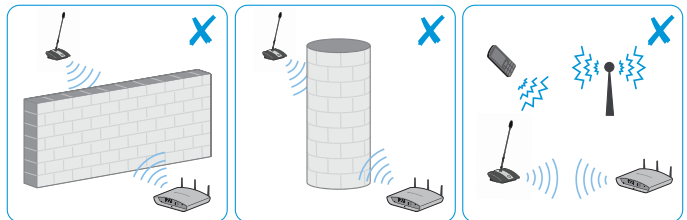

Connecting the ADN-W AM antenna module to the ADN CU1 central unit

- ▶ Use a system cable (supplied with the ADN-W AM; the maximum cable length allowed is 50 m) to connect the **PORT II** socket ⑧ or **PORT I** socket ⑨ of the ADN CU1 central unit to the input socket ④ of the antenna module.

i If the power supplied to the antenna module via the system cable is not sufficient (the antenna module does not switch on), you have to power the antenna module using the NT 12-50C power supply (see page 6).

i Optionally, you can also connect the antenna module to the **PORT** sockets of an ADN PS power supply. It does not matter if you are using a string or ring topology. The antenna module is connected just like a conference unit to the cable string or cable ring.

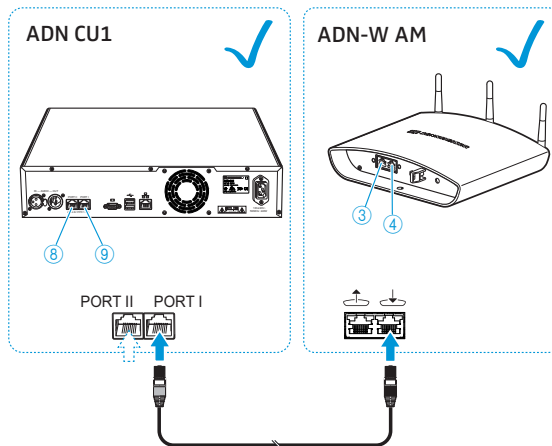

To optionally combine the antenna module with wired conference units, connect the antenna module just like a wired conference unit:

- ▶ Use a system cable to connect the output socket ③ of the antenna module to the **IN** socket of an ADN D1 or ADN C1 wired conference unit.

Or:

- ▶ Use a system cable to connect the **OUT** socket of an ADN D1 or ADN C1 wired conference unit to the input socket ④ of the antenna module.

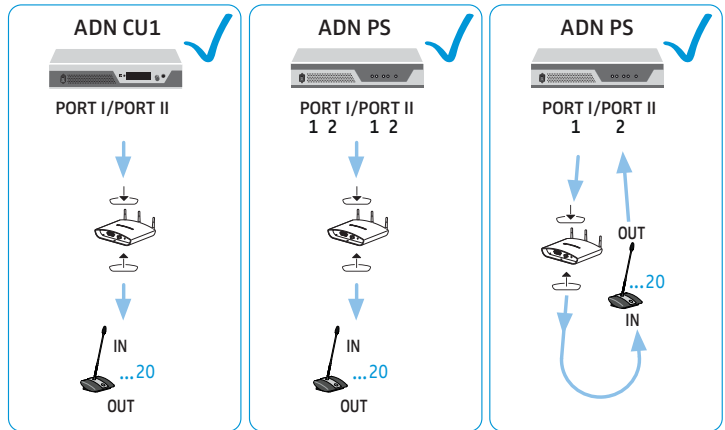

Switching the antenna module on/off

The antenna module is connected to the ADN CU1 central unit and automatically switches on when the central unit is switched on.

To switch the antenna module **on**:

- ▶ Set the on/off switch ① of the ADN CU1 central unit to position "I". The central unit switches on and its display panel lights up. The connected ADN-W AM antenna module is also switched on.



To switch the antenna module **off**:

- ▶ Disconnect the system cable from the input socket ⏴ ④ of the antenna module.

Or:

- ▶ Set the on/off switch ① of the ADN CU1 central unit to position "0". The antenna module is switched off. The wireless conference units try to reconnect to the antenna module and automatically switch off after 5 minutes if no switched-on antenna module can be found.

Configuring the wireless components

CAUTION

Risk of violation of legal requirements!

If you are using radio frequencies and transmission powers that cannot be used license-free in your country, there is a risk of violation of legal requirements.

- ▶ Use only radio frequencies and transmission powers that are approved and legal in your country.
- ▶ In the menu bar of the central unit's operating menu, click "Wireless Menu" > "Country" and select the correct country/region in which the conference system is to be used (see the ADN system manual).

For wireless conferencing, you have to configure the wireless components in order to adapt the radio settings to the legal requirements of your country and to the requirements of your conference.

For configuring the wireless components, you can either use the central unit's operating menu or the "Conference Manager" software. However, the full functionality of a wireless conference system can only be configured using the software in "Live" operating mode.



In some countries/regions (e.g. Canada), the use of wireless components operating in the 5.15 to 5.25 GHz frequency band (channel 5 to 8) is restricted to indoor use.

Adjusting the radio settings

1. Select the country/region in which the conference system is to be used ("Wireless Menu" > "Country").
The conference system only uses the radio settings that are approved and legal in the selected country/region.
2. Select dynamic frequency management ("Wireless Menu" > "Channel Selection" > "Automatic").
All radio settings are made automatically. The conference system automatically detects occupied frequencies and switches to an unused frequency band in case of interference.
3. Select the access mode for the wireless conference units:
 - **Open access mode** ("Wireless Menu" > "Access mode" > "Open")
All ADN-W D1 wireless conference units that are ready for operation automatically connect to the antenna module and can be used instantly. This access mode should be used if only

one wireless conference system is in use and if the default eavesdropping protection is sufficient.

- **Closed access mode** (“Wireless Menu” > “Access Mode” > “Closed”)

Only wireless conference units whose serial numbers are listed in a participant list can be used in the wireless conference. If several wireless conferences are held simultaneously, the closed access mode ensures that the wireless conference units connect to the correct conference system. This access mode increases the protection against eavesdropping because only selected and enabled wireless conference units can be used.



Further information on how to configure the wireless conference components can be found in the ADN system manual.

Cleaning and maintaining the antenna module

- ▶ Only use a dry and soft cloth to clean the product.

Specifications ADN-W AM

RF frequency range	2.4 GHz; 5.1 to 5.9 GHz
RF output power	25 to 100 mW (depending on the selected country/region)
Power supply	12 to 15 V --- alternatively via ADN PORT bus 52.8 V
Power consumption	6 W
Antennas	3 rod antennas with R-SMA connection
Transmission range	typ. 30 m
Mounting thread	5/8" and 3/8" thread insert
Temperature range	operation: +5°C to +45°C storage: -25°C to +70°C
Relative humidity	operation: 20 to 95% storage: 10 to 90%
Dimensions (W x H x D)	approx. 226 x 181 x 58 mm
Weight	approx. 1,660 g

In compliance with

Europe



EMC	EN 301489-1/-17
Radio	EN 300328 EN 301893 EN 300440-1/-2
Safety	EN 60065

Approved by

USA



47 CFR Part 15
FCC ID: DMOADNWAM

Canada

Industry Canada RSS 210
IC: 2099A-ADNWAM

Japan



Japanese Radio Law and Japanese Telecommunications Business Law Compliance

This device is granted pursuant to the Japanese Radio Law (電波法) and the Japanese Telecommunications Business Law (電気通信事業法). This device should not be modified (otherwise the granted designation number will become invalid)

CE Declaration of Conformity

RoHS Directive (2011/65/EU)

R&TTE Directive (1999/5/EC)

The declaration is available at www.sennheiser.com.

Before putting the product into operation, please observe the respective country-specific regulations.



Italy: For private use, a general authorization for the frequency band 5150 - 5725 MHz is required if our wireless system is used outside own premises.

For public use, a general authorization is required.

Statements regarding the FCC and Industry Canada rules

This device complies with part 15 of the FCC rules and RSS-210 of Industry Canada. Operation is subject to the following two conditions: (1) this device may not cause harmful interference, and (2) this device must accept any interference received, including interference that may cause undesired operation.

The device for operation in the band 5150-5250 MHz is only for indoor use to reduce the potential for harmful interference to co-channel mobile satellite systems.

This equipment has been tested and found to comply with the limits for a Class B digital device, pursuant to part 15 of the FCC Rules. These limits are designed to provide reasonable protection against harmful interference in a residential installation. This equipment generates, uses and can radiate radio

frequency energy and, if not installed and used in accordance with the instructions, may cause harmful interference to radio communications. However, there is no guarantee that interference will not occur in a particular installation. If this equipment does cause harmful interference to radio or television reception, which can be determined by turning the equipment off and on, the user is encouraged to try to correct the interference by one or more of the following measures:

- Reorient or relocate the receiving antenna.
- Increase the separation between the equipment and receiver.
- Connect the equipment into an outlet on a circuit different from that to which the receiver is connected.
- Consult the dealer or an experienced radio/ TV technician for help.

Changes or modifications not expressly approved by Sennheiser electronic Corp. could void the user's authority to operate the equipment.

This Class B digital apparatus complies with the Canadian ICES-003.



Sennheiser electronic GmbH & Co. KG

Am Labor 1, 30900 Wedemark, Germany
www.sennheiser.com

Printed in Germany, Publ. 08/13, 546420/A01

Free Manuals Download Website

<http://myh66.com>

<http://usermanuals.us>

<http://www.somanuals.com>

<http://www.4manuals.cc>

<http://www.manual-lib.com>

<http://www.404manual.com>

<http://www.luxmanual.com>

<http://aubethermostatmanual.com>

Golf course search by state

<http://golfingnear.com>

Email search by domain

<http://emailbydomain.com>

Auto manuals search

<http://auto.somanuals.com>

TV manuals search

<http://tv.somanuals.com>