

GP Series

Portable Generator

COMMERCIAL • INDUSTRIAL • RESIDENTIAL

MODELS: 005734-0 (15,000 Watt)

005735-0 (17,500 Watt)

Owner's Manual

- SAFETY
- ASSEMBLY
- OPERATION
- TROUBLESHOOTING
- WARRANTY



AUTHORIZED DEALER SUPPORT:

www.generac.com
or
1-888-436-3722

GENERAC®

OWNER'S MANUAL

Introduction..... 1
Read This Manual Thoroughly 1
Safety Rules 2
 Standards Index 3
Section 1 – General Information..... 4
 1.1 Unpacking..... 4
 1.2 Assembly..... 4
Section 2 – Operation 6
 2.1 Know The Generator 6
 2.2 Hourmeter 7
 2.3 Cord Sets and Connection Plugs 7
 2.4 How To Use The Generator 8
 2.5 Don't Overload The Generator 9
 2.6 Wattage Reference Guide 9
 2.7 Before Starting The Generator 10
 2.8 To Start The Engine..... 10
 2.9 Stopping The Engine 11
 2.10 Automatic Idle Control..... 11
 2.11 Cold Weather Operation/De-Icer 11
 2.12 Low Oil Pressure Shutdown System..... 11
 2.13 Charging a Battery 12
Section 3 – Maintenance 12
 3.1 Maintenance Schedule 12
 3.2 Product Specifications 12
 3.3 General Recommendations 13
 3.4 Service Air Cleaner 14
 3.5 Clean Spark Arrestor Screen 14
 3.6 Adjusting Valve Clearance 15
 3.7 General 15
 3.8 Long Term Storage..... 15
 3.9 Other Storage Tips 16
Section 4 – Troubleshooting 17
 4.1 Troubleshooting Guide..... 17
Section 5 – Warranty 18

MANUAL DEL PROPIETARIO 21

Introducción..... 23
Lea este manual completamente..... 23
Reglas de seguridad 24
 Índice de estándares..... 25
Sección 1 – Información General 26
 1.1 Desempaque 26
 1.2 Ensamble 26
Sección 2 – Operación 28
 2.1 Conozca el generador..... 28
 2.2 Medidor de horas 29
 2.3 Juego de cuerdas y conectores 29
 2.4 Cómo usar el generador 30
 2.5 No sobrecargue el generador 31
 2.6 Guía de referencia de potencias 31
 2.7 Antes de arrancar el generador 32
 2.8 Arranque del motor 33
 2.9 Detener el motor 33
 2.10 Control automático de espera (idle)..... 34

2.11 Operación en clima frío / descongelador 34
 2.12 Sistema de apagado por baja presión de aceite 34
 2.13 Cargar una batería..... 34
Section 3 – Mantenimiento..... 35
 3.1 Programa de mantenimiento 35
 3.2 Especificaciones del producto..... 35
 3.3 Recomendaciones generales..... 35
 3.4 Servicio al limpiador de aire..... 36
 3.5 Limpieza de la pantalla de supresión de chispa 37
 3.6 Ajuste de claridad de la válvula 37
 3.7 General 38
 3.8 Almacenamiento a largo plazo..... 38
 3.9 Otros consejos para almacenamiento..... 38
Sección 4 – Detección de problemas 39
 4.1 Guía de detección de problemas 39
Sección 5 – Garantía..... 40

MANUEL D'ENTRETIEN..... 43

Introduction..... 45
Lire attentivement ce manuel 45
Règles de sécurité 46
 Index des normes 47
Section 1 – Informations générales..... 48
 1.1 Déballage..... 48
 1.2 Montage 48
Section 2 – Fonctionnement 50
 2.1 Bien connaître le générateur 50
 2.2 Horomètre..... 51
 2.3 Cordons et connecteurs 51
 2.4 Utilisation du générateur..... 52
 2.5 Ne pas surcharger le générateur..... 53
 2.6 Guide de référence de wattage 53
 2.7 Avant le démarrage du générateur 54
 2.8 Démarrage du moteur 55
 2.9 Arrêt du moteur..... 55
 2.10 Commande de ralenti automatique 56
 2.11 Fonctionnement par temps froid / dégivreur..... 56
 2.12 Système d'arrêt de basse pression d'huile 56
 2.13 Chargement de la batterie..... 56
Section 3 – Maintenance 57
 3.1 Programme de maintenance..... 57
 3.2 Caractéristiques techniques des produits..... 57
 3.3 Recommandations générales 57
 3.4 Filtre à air..... 58
 3.5 Nettoyage de l'écran pare-étincelles 59
 3.6 Réglage du jeu des soupapes..... 59
 3.7 Généralités..... 60
 3.8 Stockage à long terme 60
 3.9 Autres conseils de stockage..... 60
Section 4 – Dépannage..... 61
 4.1 Guide de dépannage 61
Section 5 – Remarques 62
Section 6 – Garantie 64

INTRODUCTION

Thank you for purchasing this model by Generac Power Systems, Inc.® This model is a compact, high performance, air-cooled, engine driven generator designed to supply electrical power to operate electrical loads where no utility power is available or in place of utility due to a power outage.

READ THIS MANUAL THOROUGHLY

If any portion of this manual is not understood, contact the nearest Authorized Dealer for starting, operating and servicing procedures.

Throughout this publication, and on tags and decals affixed to the generator, DANGER, WARNING, CAUTION and NOTE blocks are used to alert personnel to special instructions about a particular operation that may be hazardous if performed incorrectly or carelessly. Observe them carefully. Their definitions are as follows:

DANGER

After this heading, read instructions that, if not strictly complied with, will result in serious personal injury, including death and/or property damage.

WARNING

After this heading, read instructions that, if not strictly complied with, may result in serious personal injury and/or property damage.

CAUTION

After this heading, read instructions that, if not strictly complied with, could result in damage to equipment and/or property.

NOTE:

After this heading, read explanatory statements that require special emphasis.

These safety warnings cannot eliminate the hazards that they indicate. Common sense and strict compliance with the special instructions while performing the service are essential to preventing accidents.

Four commonly used safety symbols accompany the **DANGER**, **WARNING** and **CAUTION** blocks. The type of information each indicates is as follows:

 This symbol points out important safety information that, if not followed, could endanger personal safety and/or property of others.

 This symbol points out potential explosion hazard.

 This symbol points out potential fire hazard.

 This symbol points out potential electrical shock hazard.







The operator is responsible for proper and safe use of the equipment. We strongly recommend that the operator read this manual and thoroughly understand all instructions before using the equipment.

We also strongly recommend instructing other users to properly start and operate the unit. This prepares them if they need to operate the equipment in an emergency.

DANGER



 **Using a generator indoors WILL KILL YOU IN MINUTES.** Exhaust contains carbon monoxide, a poison gas you cannot see or smell.

 **NEVER use in the home, or in partly enclosed areas such as garages. ONLY use outdoors and far from open windows, doors, vents, and in an area that will not accumulate deadly exhaust gas.**

 DANGER	 DANGER	 PELIGRO
Using a generator indoors CAN KILL YOU IN MINUTES. Generator exhaust contains carbon monoxide. This is a poison you cannot see or smell.	L'utilisation d'une génératrice à l'intérieur peut CAUSER LA MORT EN QUELQUES MINUTES. L'échappement de la génératrice dégage du monoxyde de carbone. Il s'agit d'un gaz toxique que vous ne pouvez ni voir ni sentir.	Utilizar un generador en interiores PUEDE MATARLE EN MINUTOS. El escape del generador genera monóxido de carbono. Este es un veneno que no puede ver ni oler.
		
NEVER use inside a home or garage. EVEN IF doors and windows are open. Only use OUTSIDE and far away from windows, doors, and vents. Ne JAMAIS utiliser à l'intérieur d'une maison ou d'un garage. MÊME SI les portes et les fenêtres sont ouvertes. Utilisez SEULEMENT à l'extérieur et tenir éloigné des fenêtres, portes et prises d'air ouvertes. NUNCA utilice dentro de una vivienda o garage. INCLUSO SI las puertas y ventanas están abiertas. Sólo utilice en EXTERIORES y alejado de ventanas, puertas y conductos de ventilación.		
0H0114 REV. A		

WARNING

 **Always disconnect the spark plug wire and place the wire where they cannot contact the spark plug to prevent accidental starting when setting up, transporting, adjusting or making repairs to the generator.**

- The generator produces dangerously high voltage that can cause extremely hazardous electrical shock. Avoid contact with bare wires, terminals, etc. Never permit any unqualified person to operate or service the generator.
- Never handle any kind of electrical cord or device while standing in water, while barefoot or while hands or feet are wet. Dangerous electrical shock will result.
- The National Electric Code requires the frame and external electrically conductive parts of the generator be properly connected to an approved earth ground. Local electrical codes may also require proper grounding of the generator. Consult with a local electrician for grounding requirements in the area.
- Do not use worn, bare, frayed or otherwise damaged electrical cord sets with the generator.
- Operate generator only on level surfaces and where it will not be exposed to excessive moisture, dirt, dust or corrosive vapors.
- Gasoline is highly **FLAMMABLE** and its vapors are **EXPLOSIVE**. Do not permit smoking, open flames, sparks or heat in the vicinity while handling gasoline. Avoid spilling gasoline on a hot engine. Comply with all laws regulating storage and handling of gasoline.
-  **Never add fuel while unit is running. Allow unit to cool entirely before adding fuel.**
-  **Do not overfill the fuel tank. Always allow room for fuel expansion. If tank is over-filled, fuel can overflow onto a hot engine and cause FIRE or an EXPLOSION.**
- Never store generator with fuel in tank where gasoline vapors might reach an open flame, spark or pilot light (as on a furnace, water heater or clothes dryer). **FIRE** or **EXPLOSION** may result.
- Generator exhaust gases contain **DEADLY** carbon monoxide gas. This dangerous gas, if breathed in sufficient concentrations, can cause unconsciousness or even death. Operate this equipment only in the open air where adequate ventilation is available.



⚠ SAVE THESE INSTRUCTIONS – The manufacturer suggests that these rules for safe operation be copied and posted near the unit's installation site. Safety should be stressed to all operators and potential operators of this equipment.

- Never start or stop the unit with electrical loads connected to receptacles AND with connected devices turned ON. Start the engine and let it stabilize before connecting electrical loads. Disconnect all electrical loads before shutting down the generator.
- Do not insert objects through unit's cooling slots.
- **Never operate generator:** Indoors or in any enclosed compartment; in rain; if connected electrical devices overheat; if electrical output is lost; if engine or generator sparks; if flames or smoke are observed while unit is running; if unit vibrates excessively.

NOTE:

This generator is equipped with a spark arrestor muffler. The spark arrestor must be maintained in effective working order by the owner/operator. In the State of California, a spark arrestor is required by law (Section 4442 of the California Public Resources Code). Other states may have similar laws. Federal laws apply on federal lands.

Study these **SAFETY RULES** carefully before installing, operating or servicing this equipment. Become familiar with this *Owner's Manual* and with the unit. The generator can operate safely, efficiently and reliably only if it is properly installed, operated and maintained. Many accidents are caused by failing to follow simple and fundamental rules or precautions.



WARNING



The engine exhaust from this product contains chemicals known to the state of California to cause cancer, birth defects or other reproductive harm.



WARNING



This product contains or emits chemicals known to the state of California to cause cancer, birth defects or other reproductive harm.

The manufacturer cannot anticipate every possible circumstance that might involve a hazard. The warnings in this manual, and on tags and decals affixed to the unit are, therefore, not all-inclusive. If using a procedure, work method or operating technique the manufacturer does not specifically recommend, satisfy yourself that it is safe for others. Make sure the procedure, work method or operating technique chosen does not render the generator unsafe.

⚠ DANGER ⚠

- ⚠ **Despite the safe design of this generator, operating this equipment imprudently, neglecting its maintenance or being careless can cause possible injury or death. Permit only responsible and capable persons to operate or maintain this equipment.**
- ⚠ **Potentially lethal voltages are generated by these machines. Ensure all steps are taken to render the machine safe before attempting to work on the generator.**
- ⚠ **Parts of the generator are rotating and/or hot during operation. Exercise care near running generators.**

⚠ GENERAL HAZARDS ⚠

- Never operate in an enclosed area or indoors.
- For safety reasons, the manufacturer recommends that the maintenance of this equipment is carried out by an Authorized Dealer.
- The engine exhaust fumes contain carbon monoxide, which can be DEADLY. This dangerous gas, if breathed in sufficient concentrations, can cause unconsciousness or even death. This exhaust system must be properly maintained. Do nothing that might render the exhaust system unsafe or in noncompliance with any local codes and/or standards.
- Keep hands, feet, clothing, etc., away from drive belts, fans, and other moving or hot parts. Never remove any drive belt or fan guard while the unit is operating.
- Adequate, unobstructed flow of cooling and ventilating air is critical to correct generator operation. Do not alter the installation or permit even partial blockage of ventilation provisions, as this can seriously affect safe operation of the generator. The generator **MUST** be operated outdoors.
- When working on this equipment, remain alert at all times. Never work on the equipment when physically or mentally fatigued.
- Inspect the generator regularly, and contact the nearest Authorized Dealer for parts needing repair or replacement.
- Before performing any maintenance on the generator, disconnect its battery cables to prevent accidental start up. Disconnect the cable from the battery post indicated by a NEGATIVE, NEG or (–) first. Reconnect that cable last.
- Never use the generator or any of its parts as a step. Stepping on the unit can stress and break parts, and may result in dangerous operating conditions from leaking exhaust gases, fuel leakage, oil leakage, etc.



ELECTRICAL HAZARDS

- All generators covered by this manual produce dangerous electrical voltages and can cause fatal electrical shock. Utility power delivers extremely high and dangerous voltages as does the generator when it is in operation. Avoid contact with bare wires, terminals, connections, etc., while the unit is running. Ensure all appropriate covers, guards and barriers are in place before operating the generator. If work must be done around an operating unit, stand on an insulated, dry surface to reduce shock hazard.
- Do not handle any kind of electrical device while standing in water, while barefoot, or while hands or feet are wet. **DANGEROUS ELECTRICAL SHOCK MAY RESULT.**
- The National Electrical Code (NEC) requires the frame and external electrically conductive parts of the generator to be connected to an approved earth ground. Local electrical codes also may require proper grounding of the generator electrical system.
- In case of accident caused by electric shock, immediately shut down the source of electrical power. If this is not possible, attempt to free the victim from the live conductor. **AVOID DIRECT CONTACT WITH THE VICTIM.** Use a non-conducting implement, such as a rope or board, to free the victim from the live conductor. If the victim is unconscious, apply first aid and get immediate medical help.
- Never wear jewelry when working on this equipment. Jewelry can conduct electricity resulting in electric shock, or may get caught in moving components causing injury.

FIRE HAZARDS

- For fire safety, the generator must be operated and maintained properly. Operation must always comply with applicable codes, standards, laws and regulations. Adhere strictly to local, state and national electrical and building codes. Comply with regulations the Occupational Safety and Health Administration (OSHA) has established. Also, ensure that the generator is operated in accordance with the manufacturer's instructions and recommendations. Do not alter the construction of the generator or change controls which might create an unsafe operating condition.
- Keep a fire extinguisher near the generator at all times. Extinguishers rated "ABC" by the National Fire Protection Association are appropriate for use on the standby electric system. Keep the extinguisher properly charged and be familiar with its use. If there are any questions pertaining to fire extinguishers, consult the local fire department.
- Avoid spilling gasoline on a hot engine. NEVER add fuel while the unit is running. Allow unit/engine to cool entirely before adding fuel. DO NOT overfill the fuel tank. Always allow room for fuel expansion. NEVER fill fuel tank indoors.

EXPLOSION HAZARDS

- Do not smoke around the generator. Wipe up any fuel or oil spills immediately. Ensure that no combustible materials are left on or near the generator, as FIRE or EXPLOSION may result. Keep the area surrounding the generator clean and free from debris.
- Gasoline is extremely EXPLOSIVE.

STANDARDS INDEX

In the absence of pertinent standards, codes, regulations and laws, the published information listed below may be used as a guideline for operation of this equipment. Always reference the latest revision available for the standards listed.

1. NFPA No. 70, NFPA HANDBOOK OF NATIONAL ELECTRIC CODE.
2. Article X, NATIONAL BUILDING CODE, available from the American Insurance Association, 85 John Street, New York, N.Y. 10038.
3. AGRICULTURAL WIRING HANDBOOK, available from the Food and Energy Council, 909 University Avenue, Columbia, MO 65201.
4. ASAE EP-3634, INSTALLATION AND MAINTENANCE OF FARM STANDBY ELECTRICAL SYSTEMS, available from the American Society of Agricultural Engineers, 2950 Niles Road, St. Joseph, MI 49085.
5. NFPA No. 30, FLAMMABLE AND COMBUSTIBLE LIQUIDS CODE.

1.1 UNPACKING

- Set the palletted carton on a rigid flat surface.
- Remove staples along bottom of carton that fasten carton to pallet. Open carton from top.
- Remove all packaging material.
- Remove separate accessory box.
- Lift carton off the generator.
- Remove generator from shipping pallet by removing bolts through the shipping brackets (Figure 1).

Figure 1 - Bracket Removal

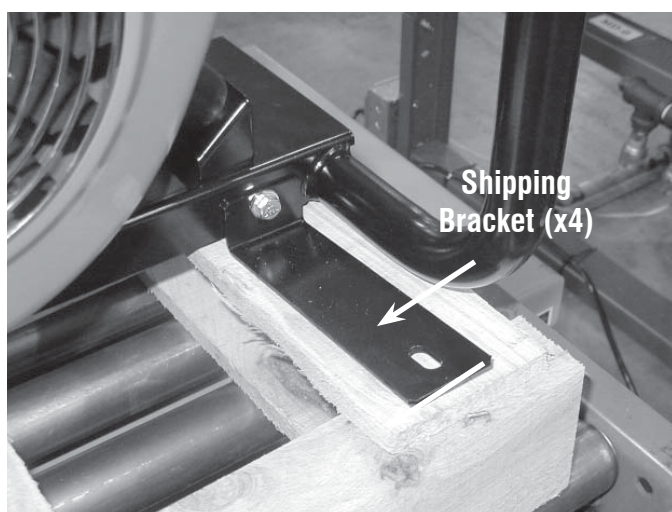

1.1.1 ACCESSORY BOX

Check all contents. If any parts are missing or damaged locate an authorized dealer at 1-888-436-3722.

Contents include:

- | | |
|-------------------------------------|-------------------------------|
| • Wheel Axle | • Bolt-on tubular handle |
| • 2 – Washers | • 2 – Pneumatic Wheels |
| • 2 – Wheel Spacers | • 2 – Axle Bracket Assemblies |
| • 2 – Cotter Pins | • Bolt-on Foot |
| • 2 – Spark Plugs | • Spark Plug Wrench |
| • Air Filter | • Oil Filter |
| • Pre-cleaner | • Battery Charge Cable |
| • 6 – Carriage Bolts, Washers, Nuts | |

1.2 ASSEMBLY

The generator requires some assembly prior to using it. If problems arise when assembling the generator, please call the Generator Helpline at 1-888-436-3722.

1.2.1 ASSEMBLING THE WHEEL KIT

The wheel kit is designed to greatly improve the portability of the generator. A socket wrench with a 9/16" socket, a 1/2" socket, a 1/2" wrench and a pair of pliers are the tools that will be needed for assembly of the wheel kit.

NOTE:

The wheel kit is not intended for over-the-road use.

- Refer to Figure 2 and install the wheel kit as follows:
- Place the generator on a hard flat surface.
- Stand at the engine end of the unit and gently tilt the generator forward, high enough to place wooden blocks beneath the cradle. This will allow space to install the wheel assemblies.
- Attach an axle bracket assembly with attached sleeve to either side of the frame. Ensure the sleeve faces outward.
- Slide the axle through the sleeves on the axle brackets.
- Slide one wheel with flat washer to the outside and a spacer to the inside onto each end of the axle. Make sure the air inflation valve on the wheel is facing outward.
- Insert retaining pins and using pliers, bend out the ends to prevent the pins from falling out of the axle. Remove the wooden blocks.

1.2.2 ASSEMBLING THE HANDLE

- Attach the handle by aligning one side of the handle on the cradle, then spread the handle around the cradle and let it spring into place. Secure the handle to the frame using the 5/16" hex head bolts provided. Check each fastener to ensure that it is secure.
- Using the handle, lift the unit high enough to place wooden blocks under the unit. Attach the front support foot to the underside of the cradle using the 3/8" carriage bolts provided.
- Remove the shipping brackets from the cradle, if it has not already been done.

Figure 2 - Handle Assembly

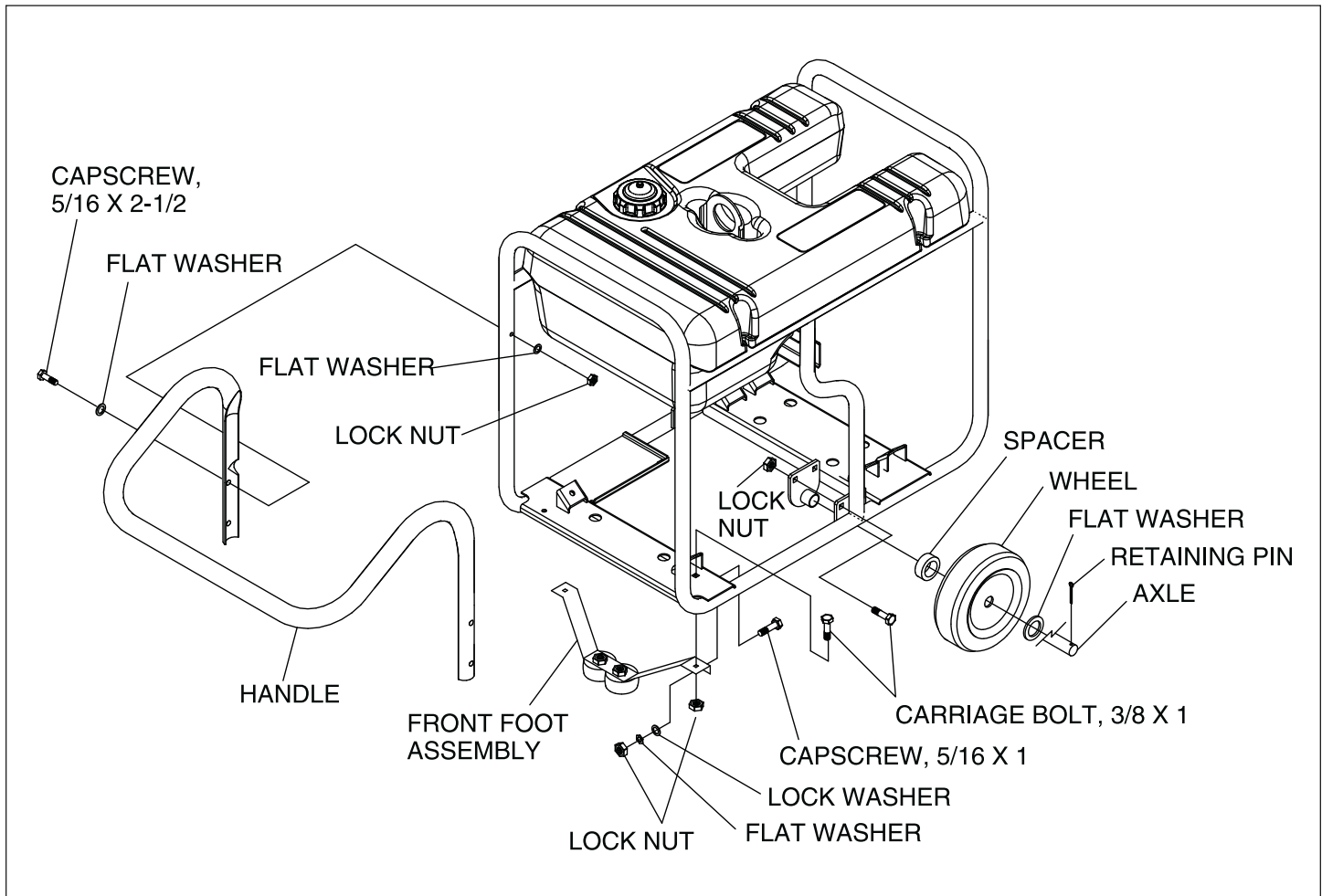

1.2.3 BATTERY CONNECTION

- The battery shipped with the generator has been provided fully charged. Caution must be taken when connecting the battery.

NOTE:

A battery may lose some of its charge when not in use for prolonged periods of time.

- Cut the tie wrap cable holding the RED and BLACK battery cables to the stator.
- Connect the RED battery cable to the battery Positive terminal (+). After making sure that the connection is tight, slip the rubber boot over the terminal connection.
- Connect the BLACK battery cable to the battery Negative terminal (-). Make sure the connection is tight.
- Double check all connections to ensure they are in the correct location and secure. See Figure 3.

Figure 3 - Battery Connections

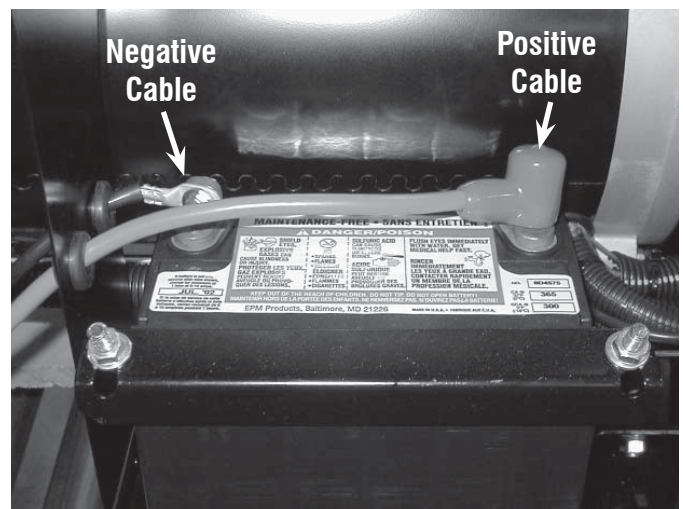

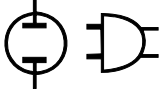

2.1 KNOW THE GENERATOR

Read the Owner's Manual and Safety Rules before operating this generator.

Compare the generator to Figures 4 through 6 to become familiarized with the locations of various controls and adjustments. Save this manual for future reference.

Figure 4 - Control Panel

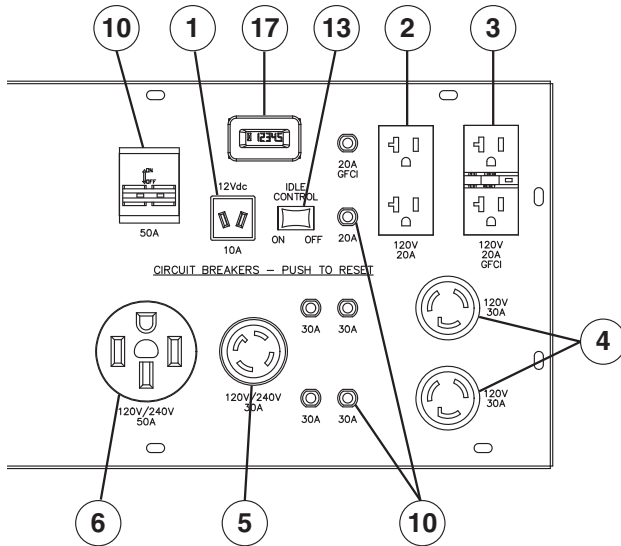

- 12 Volt DC, 10 Amp Receptacle** – This receptacle allows the capability to recharge a 12 volt DC storage battery with provided battery charge cables.
- 120 Volt AC, 20 Amp, Duplex Receptacle** – Supplies electrical power for the operation of 120 Volt AC, 20 Amp, single-phase, 60 Hz electrical lighting, appliance, tool and motor loads.
- 120 Volt AC, 20A Duplex GFCI Receptacle** – Supplies ground fault protected electrical power for operation of 120 volt AC 20 amp, single-phase, 60 Hz electric lighting, appliances, tools and motor loads.
- 120 Volt AC, 30 Amp Locking Receptacle** – Supplies electrical power for the operation of 120 Volt AC, 30 Amp, single-phase, 60 Hz electrical lighting, appliance, tool and motor loads.
- 120/240 Volt AC, 30 Amp Locking Receptacle** – Supplies electrical power for the operation of 120 and/or 240 Volt AC, 30 Amp, single-phase, 60 Hz, electrical lighting, appliance, tool and motor loads.
- 120/240 Volt AC, 50 Amp Receptacle (17.5kW, Located on underside of control panel)**– Supplies electrical power for the operation of 120/240 Volt AC, 50 Amp, single-phase, 60 Hz, welder or motor loads.
- Air Cleaner** – Filters intake air as it is drawn into the engine.
- Choke Knob** – Used when starting a cold engine.
- Winter/Summer Valve** – See “Cold Weather Operation/De-icer” section.
- Circuit Breakers (AC)** – Each receptacle is provided with a push-to-reset circuit breaker to protect the generator against electrical overload. (50 amp uses toggle reset)

Figure 5 - Generator Controls

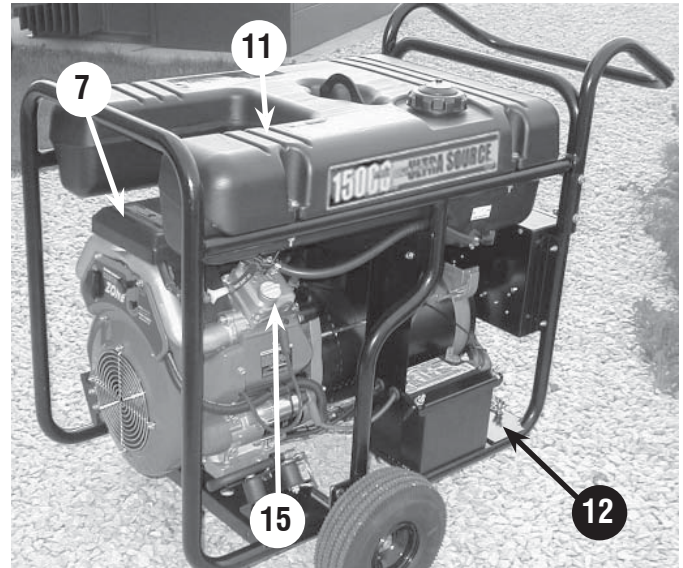

- Fuel Tank** – Tank holds 16 U.S. gallons of fuel.
- Grounding Lug** – Ground the generator to an approved earth ground here. See "Grounding the Generator" for details.
- Idle Control Switch** – The idle control runs the engine at normal (high) speeds when there is an electrical load present and runs the engine at idle (low) speeds when a load is not present.
- Start/Run/Stop Switch** – Controls the operation of the generator.
- Oil Fill** – Use this point to add oil to engine.
- Fuse - 10 Amp (Located at rear of control panel)** – Protects the DC control circuit from overload. If this fuse element has melted open the engine will not be able to crank and start.
- Hourmeter** - Tracks hours of operation.

Figure 6 - Engine Control Panel

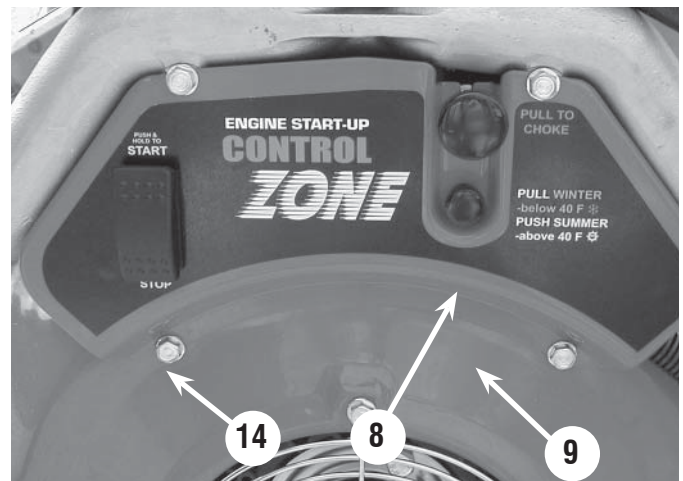

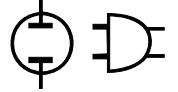

2.2 HOURMETER

The Hourmeter tracks hours of operation for scheduled maintenance:

There will be a one time break in "CHG OIL" message that flashes with the elapsed time in hours and tenths after the first 30 hours of operation.

This message will actually begin flashing at 29 hours and disable itself at 31 hours providing a two hour window to perform the service.

There will be a subsequent "CHG OIL" message every 100 hours. The message will flash one hour before and one hour after each 100 hour interval, again providing a two hour window to perform service.

Every 200 hours the "SVC" icon on the lower left hand corner of the display will flash. The message will flash one hour before and one hour after each 200 hour interval providing a two hour window to perform service.

When the hour meter is in the Flash Alert mode, the maintenance message will always alternate with elapsed time in hours and tenths. The hours will flash four times, then alternate with the maintenance message four times until the meter resets itself.

- 30 hours - CHG OIL — Break-in Interval (First 30 hrs only)
- 100 hours - CHG OIL — Oil Change Interval (Every 100 hrs)
- 200 hours - SVC — Air Filter Interval (Every 200 hrs)

2.3 CORD SETS AND CONNECTION PLUGS

2.3.1 120 VAC, 20 AMP, DUPLEX RECEPTACLE

This is a 120 Volt outlet protected against overload by a 20 Amp push-to-reset circuit breaker (Figure 7). Use each socket to power 120 Volt AC, single phase, 60 Hz electrical loads requiring up to a combined 2400 watts (2.4 kW) or 20 Amps of current. Use only high quality, well-insulated, 3-wire grounded cord sets rated for 125 Volts at 20 Amps (or greater).

Keep extension cords as short as possible, preferably less than 15 feet long, to prevent voltage drop and possible overheating of wires.

Figure 7 - 120 Volt AC, 20 Amp, Duplex Receptacle

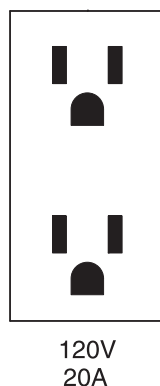

2.3.2 120 VAC, 20 AMP, GFCI RECEPTACLE

This unit is equipped with a ground fault circuit interrupter (GFCI). This device meets applicable federal, state and local codes (Figure 8).

A GFCI receptacle is different from conventional receptacles. In the event of a ground fault, a GFCI will trip and quickly stop the flow of electricity to prevent serious injury.

Definition: Instead of following its normal safe path, electricity passes through a persons body to reach the ground. For example, a defective appliance can cause a ground fault.

A GFCI receptacle does NOT protect against circuit overloads, short circuits, or shocks. For example, electric shock can still occur if a person touches charged electrical wires while standing on a non-conducting surface, such as a wood floor.

Figure 8 - 120 VAC, 20 Amp GFCI Receptacle

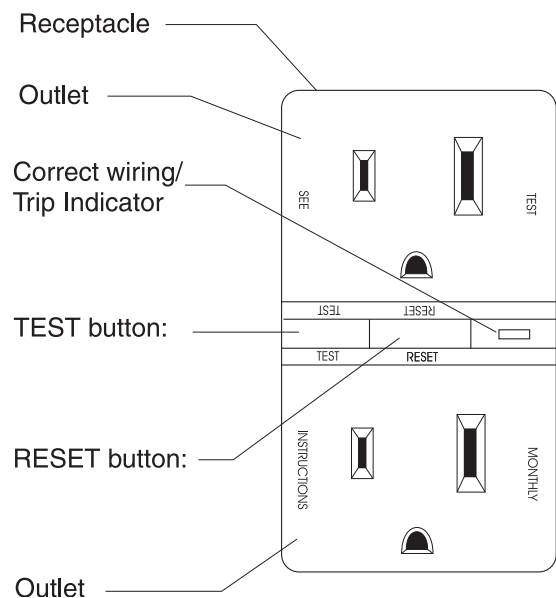

Testing the GFCI: Test the GFCI outlet every month as follows:

- Plug a test lamp into the receptacle.
- Start the generator, the test lamp should be on.
- Press the "Test" button located on the front of the receptacle to trip the device.
- This should stop the flow of electricity making the lamp shut off. The yellow trip indicator should now be on.
- To restore the flow of electricity, press the "Reset" button on the front of the receptacle. If the GFCI does not perform in this manner, do not use the receptacle. Contact a local service dealer.
- This outlet is protected against overload by a 20A push-to-reset circuit breaker. Use the outlet to power 120V AC, single-phase, 60 Hz, electrical loads requiring up to a combined 2400 watts (2.4 kW) or 20 amps of current.

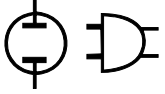

2.3.3 120 VAC, 30 AMP RECEPTACLE

Use a NEMA L5-30 plug with this receptacle. Connect a 3-wire cord set rated for 125 Volts AC at 30 Amps (or greater) to the plug (Figure 9).

Figure 9 - 120 VAC, 30 Amp Receptacle

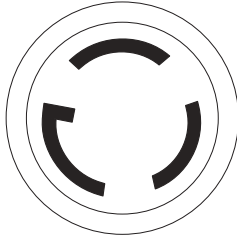

120V
30A

Use this receptacle to operate 120 Volt AC, 60 Hz, single phase loads requiring up to 3600 watts (3.6 kW) of power at 30 Amps. The outlet is protected by a 30 Amp push-to-reset circuit breaker.

2.3.4 120/240 VAC, 30 AMP RECEPTACLE

Use a NEMA L14-30 plug with this receptacle. Connect a suitable 4-wire grounded cord set to the plug and to the desired load. The cord set should be rated for 250 Volts AC at 30 Amps (or greater) (Figure 10).

Figure 10 - 120/240 VAC, 30 Amp Receptacle

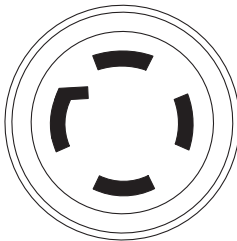

120V/240V
30A

Use this receptacle to operate 120 Volt AC, 60 Hz, single phase loads requiring up to 3600 watts (3.6 kW) of power at 30 Amps or 240 Volt AC, 60 Hz, single phase loads requiring up to 7200 watts (7.2 kW) of power at 30 Amps. The outlet is protected by two 30 Amp push-to-reset circuit breakers.

2.3.5 12 VOLT DC, 10 AMP RECEPTACLE

This receptacle permits recharging a 12-Volt automotive or utility style storage battery with the battery charge cables provided (Figure 11). This receptacle **can not** recharge 6-Volt batteries and **can not** be used to crank an engine having a discharged battery. See the section "Charging a Battery" before attempting to recharge a battery.

Figure 11 - 12 Volt DC, 10 Amp Receptacle

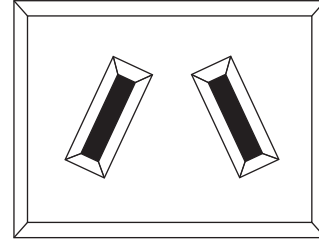

2.3.6 120/240 VAC, 50 AMP RECEPTACLE

Use a NEMA 14-50 plug with this receptacle. Connect a 4-wire cord set rated for 250 Volts AC at 50 Amps to the plug (Figure 12).

Figure 12 - 120/240 VAC, 50 Amp Receptacle

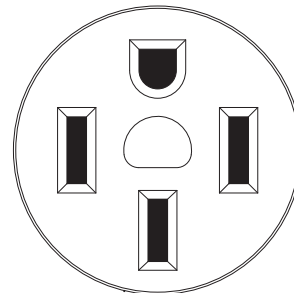

120V/240V
50 A

Use this receptacle to operate 120/240 Volt AC, 60 Hz electrical loads requiring up to 12,000 watts (12.0 kW) of power. This receptacle is protected by a 50 Amp 2-pole circuit breaker.

2.4 HOW TO USE THE GENERATOR

If there are any problems operating the generator, please call the generator helpline at 1-888-436-3722.

2.4.1 GROUNDING THE GENERATOR

The National Electrical Code requires that the frame and external electrically conductive parts of this generator be properly connected to an approved earth ground (Figure 13). Local electrical codes may also require proper grounding of the unit. For that purpose, generally, connecting a No. 10 AWG (American Wire Gauge) stranded copper wire to the grounding wing nut and to an earth-driven copper or brass grounding rod (electrode) provides adequate protection against electrical shock. However, local codes may vary widely. **Consult with a local electrician for grounding requirements in the area.**

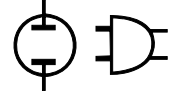
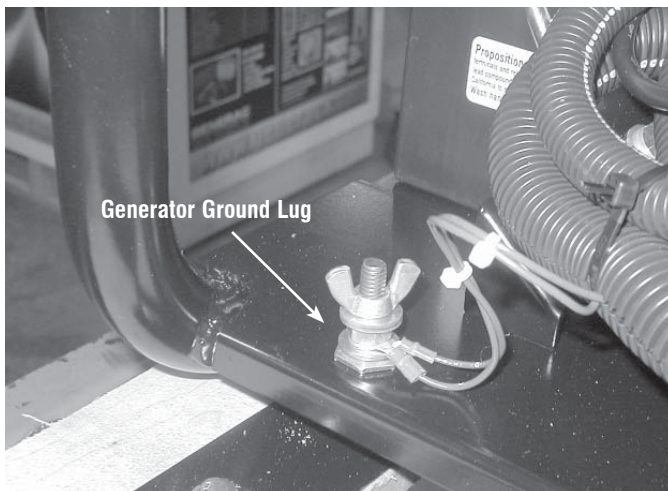

Figure 13 - Grounding the Generator



Proper grounding of the generator will help prevent electrical shock in the event of a ground fault condition in the generator or in connected electrical devices. Proper grounding also helps dissipate static electricity, which often builds up in ungrounded devices.

2.4.2 CONNECTING ELECTRICAL LOADS

DO NOT connect 240 Volt loads to 120 Volt receptacles. **DO NOT** connect 3-phase loads to the generator. **DO NOT** connect 50 Hz loads to the generator.

- Let engine stabilize and warm up for a few minutes after starting.
- Plug in and turn on the desired 120 or 240 Volt AC, single phase, 60 Hz electrical loads.
- Add up the rated watts (or amps) of all loads to be connected at one time. This total should not be greater than (a) the rated wattage/ampere capacity of the generator or (b) circuit breaker rating of the receptacle supplying the power. See "Don't Overload the Generator" below.

2.5 DON'T OVERLOAD THE GENERATOR

Overloading a generator in excess of its rated wattage capacity can result in damage to the generator and to connected electrical devices. Observe the following to prevent overloading the unit:

- Add up the total wattage of all electrical devices to be connected at one time. This total should NOT be greater than the generator's wattage capacity.
- The rated wattage of lights can be taken from light bulbs. The rated wattage of tools, appliances and motors can usually be found on a data label or decal affixed to the device.
- If the appliance, tool or motor does not give wattage, multiply volts times ampere rating to determine watts (volts x amps = watts).
- Some electric motors, such as induction types, require about three times more watts of power for starting than for running. This surge of power lasts only a few seconds when starting such motors. Make sure to allow for high starting wattage when selecting electrical devices to connect to the generator:

1. Figure the watts needed to start the largest motor.
2. Add to that figure the running watts of all other connected loads.

The Wattage Reference Guide is provided to assist in determining how many items the generator can operate at one time.

NOTE:

All figures are approximate. See data label on appliance for wattage requirements.

2.6 WATTAGE REFERENCE GUIDE

Device	Running Watts
*Air Conditioner (12,000 Btu)	1700
*Air Conditioner (24,000 Btu)	3800
*Air Conditioner (40,000 Btu)	6000
Battery Charger (20 Amp)	500
Belt Sander (3")	1000
Chain Saw	1200
Circular Saw (6-1/2")	.800 to 1000
*Clothes Dryer (Electric)	5750
*Clothes Dryer (Gas)	700
*Clothes Washer	1150
Coffee Maker	1750
*Compressor (1 HP)	2000
*Compressor (3/4 HP)	1800
*Compressor (1/2 HP)	1400
Curling Iron	700
*Dehumidifier	650
Disc Sander (9")	1200
Edge Trimmer	500
Electric Blanket	400
Electric Nail Gun	1200
Electric Range (per element)	1500
Electric Skillet	1250
*Freezer	700
*Furnace Fan (3/5 HP)	875
*Garage Door Opener	.500 to 750
Hair Dryer	1200
Hand Drill	.250 to 1100
Hedge Trimmer	450
Impact Wrench	500
Iron	1200
*Jet Pump	800
Lawn Mower	1200
Light Bulb	100
Microwave Oven	.700 to 1000
*Milk Cooler	1100
Oil Burner on Furnace	300
Oil Fired Space Heater (140,000 Btu)	400
Oil Fired Space Heater (85,000 Btu)	225
Oil Fired Space Heater (30,000 Btu)	150
*Paint Sprayer, Airless (1/3 HP)	600
Paint Sprayer, Airless (handheld)	150
Radio	.50 to 200
*Refrigerator	700
Slow Cooker	200
*Submersible Pump (1-1/2 HP)	2800
*Submersible Pump (1 HP)	2000
*Submersible Pump (1/2 HP)	1500
*Sump Pump	.800 to 1050

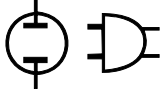

- *Table Saw (10")1750 to 2000
- Television200 to 500
- Toaster1000 to 1650
- Weed Trimmer 500
- * Allow 3 times the listed watts for starting these devices.

2.7 BEFORE STARTING THE GENERATOR

Prior to operating the generator, engine oil and gasoline will need to be added, as follows:

2.7.1 ADDING ENGINE OIL

All oil should meet minimum American Petroleum Institute (API) Service Class SJ, SL or better. Use no special additives. Select the oil's viscosity grade according to the expected operating temperature (also see chart).

- Above 40° F, use SAE 30
- Below 40° F and down to 10° F, use 10W-30
- Below 10° F, use synthetic 5W-30



Any attempt to crank or start the engine before it has been properly serviced with the recommended oil may result in an engine failure.

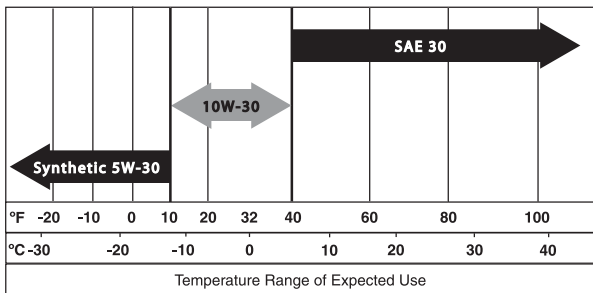

- Place generator on a level surface.
- Clean area around oil fill and remove oil fill cap and dipstick.
- Wipe dipstick clean.
- Slowly fill engine with oil through the oil fill opening until it reaches the full mark. Stop filling occasionally to check oil level. (Engine oil is full when level is up to the threads of the oil fill plug.) **Do not overfill.**
- Install oil fill cap and finger tighten securely.
- Check engine oil level before starting each time thereafter.

2.7.2 ADDING GASOLINE



Never fill fuel tank indoors. Never fill fuel tank when engine is running or hot. Allow unit/engine to cool entirely before adding fuel. DO NOT light a cigarette or smoke when filling the fuel tank.



Do not overfill the fuel tank. Always leave room for fuel expansion.

- To reduce lead and carbon deposits use high quality UNLEADED gasoline with the generator engine. Leaded REGULAR grade gasoline is an acceptable substitute. Do not use premium gasoline. Do not mix oil with gasoline.
- Clean area around fuel fill cap, remove cap.
- Slowly add unleaded regular gasoline to fuel tank. **Be careful not to overfill.** Allow about 1/2" of tank space for fuel expansion, as shown in Figure 14.
- Install fuel cap and wipe up any spilled gasoline.

Figure 14 - Fuel Tank

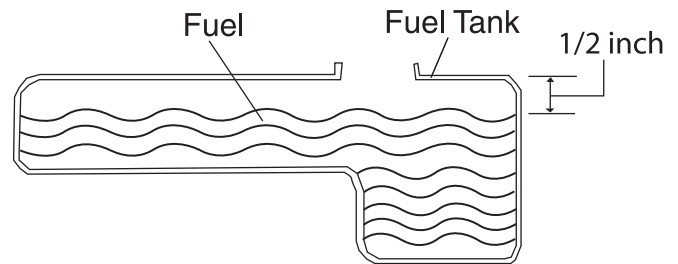

IMPORTANT: It is important to prevent gum deposits from forming in fuel system parts such as the carburetor, fuel hose or tank during storage. Alcohol-blended fuels (called gasohol, ethanol or methanol) can attract moisture, which leads to separation and formation of acids during storage. Acidic gas can damage the fuel system of an engine while in storage. To avoid engine problems, the fuel system should be emptied before storage of 30 days or longer. See the "Storage" section. Never use engine or carburetor cleaner products in the fuel tank as permanent damage may occur.



The manufacturer does not recommend using any gasoline containing alcohol (such as "gasohol"). If using any gasoline containing alcohol, it must not contain more than 10 percent ethanol, and it must be removed from the generator during storage. Do NOT use any gasoline containing methanol. If using gasoline with alcohol, inspect more frequently for fuel leaks and other abnormalities.

2.8 TO START THE ENGINE



Never start or stop engine with electrical devices plugged into the receptacles AND devices turned on.

- Unplug all electrical loads from the unit's receptacles before starting the engine.
- Make sure the unit is in a level position.

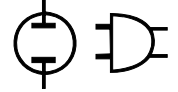

- Open the fuel shut-off valve (Figure 15).

Figure 15 - Fuel Shut-off Valve

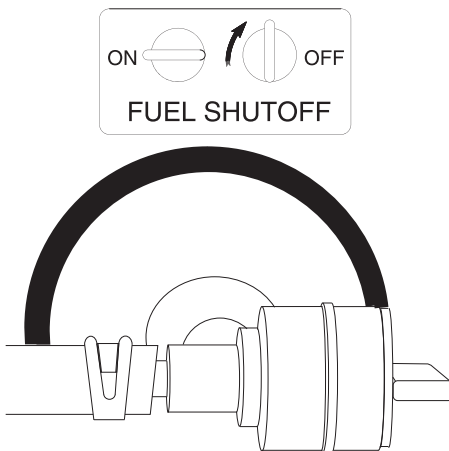

- Locate the Idle Control ON/OFF switch on the control panel and set it to the "OFF" position (Figure 16).

Figure 16 - Idle Control Switch

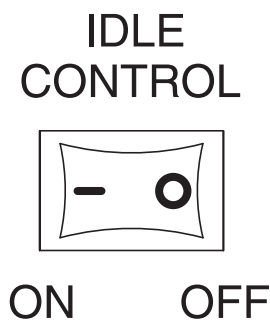

- Move engine CHOKE knob outward to "Full Choke" position (Figure 17).

Figure 17 - Full Choke Position



- To start engine, press and hold the Start/Run/Stop switch in the "Start" position. The engine will crank and attempt to start. When the engine starts, release the switch to the run position.
- When the engine starts, move choke knob to "1/2 Choke" position until the engine runs smoothly and then fully in to the "Run" position. If engine falters, move choke knob back out to "1/2 Choke" position until the engine runs smoothly and then to "Run" position.

NOTE:

If engine fires, but does not continue to run, move choke lever to "Full Choke" and repeat starting instructions.

IMPORTANT: Do not overload the generator. Also, do not overload individual panel receptacles. These outlets are protected against overload with push-to-reset-type circuit breakers. If amperage rating of any circuit breaker is exceeded, that breaker opens and electrical output to that receptacle is lost. Read "Don't Overload the Generator" carefully.

2.9 STOPPING THE ENGINE

- Shut off all loads, then unplug the electrical loads from generator panel receptacles. Never start or stop the engine with electrical devices plugged in and turned on.
- Turn "Off" the Idle Control switch (if on).
- Let engine run at no-load for several minutes to stabilize the internal temperatures of engine and generator.
- Move Start/Run/Stop switch to "Off" position.
- Close fuel valve.

2.10 AUTOMATIC IDLE CONTROL

This feature is designed to greatly improve fuel economy. When this switch is turned "On," the engine will only run at its normal fast governed engine speed when electrical load is connected. When the load is removed, the engine will run at a reduced speed of 2100 RPM. With the switch "Off," the engine runs at the normal fast engine speed all the time. **Always have the switch OFF when starting and stopping the engine.**

2.11 COLD WEATHER OPERATION/ DE-ICER

Under certain weather conditions (temperatures below 40° F (4° C) and a high dew point), the engine may experience icing of the carburetor and/or the crankcase breather system. To eliminate this problem, this generator engine is fitted with a winter/summer valve. This directs hot air into the carburetor during cold weather operation. Always make sure the winter/summer valve is in the correct location relative to the weather conditions.

2.12 LOW OIL PRESSURE SHUTDOWN SYSTEM

The engine is equipped with a low oil pressure sensor that shuts down the engine automatically when the oil pressure drops below 10 psi. If the engine shuts down by itself and the fuel tank has enough gasoline, check engine oil level.

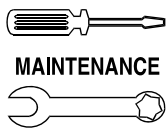

MAINTENANCE

2.12.1 INITIAL START-UP

A delay built into the low oil shutdown system allows oil pressure to build during starting. The delay allows the engine to run for about 10 seconds before sensing oil pressure.

2.12.2 SENSING LOW OIL PRESSURE

If the system senses low oil pressure during operation, the engine shuts down.

2.12.3 RESTARTING

If trying to restart the engine within 10 seconds after it shuts down, the engine may NOT start. The system needs five (5) to 10 seconds to reset.

If the engine is restarted after such a shutdown and the low oil pressure has not been corrected, the engine will run for about 10 seconds as described above and then stop.

2.13 CHARGING A BATTERY



Storage batteries give off explosive hydrogen gas while recharging. An explosive mixture will remain around the battery for a long time after it has been charged. The slightest spark can ignite the hydrogen and cause an explosion. Such an explosion can shatter the battery and cause blindness or other serious injury.



Do not permit smoking, open flame, sparks or any other source of heat around a battery. Wear protective goggles, rubber apron and rubber gloves when working around a battery. Battery electrolyte fluid is an extremely caustic sulfuric acid solution that can cause severe burns. If spill occurs flush area with clear water immediately.

This generator has the capability of recharging a discharged 12 Volt automotive or utility style storage battery. **Do not use the unit to charge any 6 Volt batteries. Do not use the unit to crank an engine having a discharged battery.**

This battery charger is a pulse type designed to provide a quality charge current into the battery. The voltage measured at the outlet should be 8-12 VDC. This is normal and does not indicate a faulty charging system.

To recharge 12 Volt batteries, proceed as follows:

- Check fluid level in all battery cells. If necessary, add ONLY distilled water to cover separators in battery cells. **Do not use tap water.**
- If the battery is equipped with vent caps, make sure they are installed and are tight.
- If necessary, clean battery terminals.
- Connect battery charge cable connector plug to panel receptacle identified by the words "12-VOLT D.C."

- Connect battery charge cable clamp with red handle to the positive (+) battery terminal.
- Connect battery charge cable clamp with black handle to the negative (-) battery terminal.
- Start engine. Let the engine run while battery recharges. Engine idle control switch must be in off position for battery charging.
- When battery has charged, shut down engine.

NOTE:

Use an automotive hydrometer to test battery state of charge and condition. Follow the hydrometer manufacturer's instructions carefully. Generally, a battery is considered to be at 100% state of charge when specific gravity of its fluid (as measured by hydrometer) is 1.260 or higher.

3.1 MAINTENANCE SCHEDULE

Follow the calendar intervals. More frequent service is required when operating in adverse conditions noted below.

Check Oil Level	At Each Use
Change Oil ‡	*Every 100 hours or Every Season
Check Valve Clearance	***Every Season
Service Air Filter	** Every 200 hours or Every Season
Replace Spark Plug	Every Season

- ‡ Change oil after first 30 hours of operation then every season.
- * Change oil and oil filter every month when operating under heavy load or in high temperatures.
- ** Clean more often under dirty or dusty operating conditions. Replace air filter parts if they cannot be adequately cleaned.
- *** Check valve clearance and adjust if necessary after first 50 hours of operation and every 100 hours thereafter.

3.2 PRODUCT SPECIFICATIONS

3.2.1 GENERATOR SPECIFICATIONS

MODEL	15 KW	17.5 KW
Rated Max. Power	15.0 kW	17.5 kW
Surge Power	22.5 kW	26.25 kW
Rated AC Voltage	120/240	120/240
Rated Max AC Load		
Current @ 240V	62.5 Amps	72.9 Amps
Current @ 120V	125.0 Amps	145.8 Amps
Rated Frequency	60 Hz @ 3600 RPM	60 Hz @ 3600 RPM
Phase	Single Phase	Single Phase
Rated DC Voltage	12 Volts	12 Volts
Rated Max DC Load		
Current @ 12 Volts	10 Amperes	10 Amperes
Weight	373 lbs.	400 lbs.

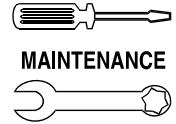

3.2.2 ENGINE SPECIFICATIONS

Rated Horsepower @ 3600 RPM	30
Displacement	992cc
Spark Plug Type	Champion RC14YC or Equivalent
Spark Plug Gap	0.040 inch or (1.01 mm)
Gasoline Capacity	16 U.S. gallons
Oil Type	Summer – SAE 30, Winter – 5W-30 Synthetic or 10W-30
Oil Capacity	w/ Filter Change = 1.7 Qts., w/o Filter Change = 1.4 Qts.
Run Time/Fuel Consumption-1/2 Load	10 Hours / 1.6 gallons per hour

3.3 GENERAL RECOMMENDATIONS

The warranty of the generator does not cover items that have been subjected to operator abuse or negligence. To receive full value from the warranty, the operator must maintain the generator as instructed in this manual.

Some adjustments will need to be made periodically to properly maintain the generator.

All adjustments in the Maintenance section of this manual should be made at least once each season. Follow the requirements in the "Maintenance Schedule" chart.

NOTE:

Once a year, replace the spark plug and replace the air filter. A new spark plug and clean air filter assure proper fuel-air mixture and help the engine run better and last longer.

3.3.1 GENERATOR MAINTENANCE

Generator maintenance consists of keeping the unit clean and dry. Operate and store the unit in a clean dry environment where it will not be exposed to excessive dust, dirt, moisture or any corrosive vapors. Cooling air slots in the generator must not become clogged with snow, leaves, or any other foreign material.

Check the cleanliness of the generator frequently and clean when dust, dirt, oil, moisture or other foreign substances are visible on its exterior surface.



Never insert any object or tool through the air cooling slots, even if the engine is not running.

NOTE:

DO NOT use a garden hose to clean generator. Water can enter the engine fuel system and cause problems. In addition, if water enters the generator through cooling air slots, some water will be retained in voids and crevices of the rotor and stator winding insulation. Water and dirt buildup on the generator internal windings will eventually decrease the insulation resistance of these windings.

3.3.2 TO CLEAN THE GENERATOR

- Use a damp cloth to wipe exterior surfaces clean.
- A soft, bristle brush may be used to loosen caked on dirt, oil, etc.
- A vacuum cleaner may be used to pick up loose dirt and debris.
- Low pressure air (not to exceed 25 psi) may be used to blow away dirt. Inspect cooling air slots and openings on the generator. These openings must be kept clean and unobstructed.

3.3.3 ENGINE MAINTENANCE



When working on the generator, always disconnect negative cable from battery. Also disconnect spark plug wires from spark plugs and keep wire away from spark plugs.

3.3.4 CHECKING OIL LEVEL

See the "BEFORE STARTING THE GENERATOR" section for information on checking the oil level. The oil level should be checked before each use, or at least every eight hours of operation. Keep the oil level maintained.



Hot oil may cause burns. Allow engine to cool before draining oil. Avoid prolonged or repeated skin exposure with used oil. Thoroughly wash exposed areas with soap.

3.3.5 CHANGING THE OIL AND OIL FILTER

Change the oil and filter after the first 30 hours of operation. Change the oil every 100 hours thereafter. If running this unit under dirty or dusty conditions, or in extremely hot weather, change the oil more often.

NOTE:

Whenever possible, run engine for approximately five (5) minutes to get the engine oil hot. This will aid in draining the oil.

Use the following instructions to change the oil while the engine is still warm:

- Clean area around oil drain hose and plug.
- Remove oil drain plug from end of hose and oil fill plug to drain oil completely into a suitable container.
- When oil has completely drained, install oil drain plug and tighten securely.
- Place a suitable container beneath the oil filter and turn filter counterclockwise to remove. Discard according to local regulations.
- Coat gasket of new filter with clean engine oil. Turn filter clockwise until gasket contacts lightly with filter adapter. Then tighten an additional 3/4 turn.
- Fill oil sump with recommended oil. (See "Before Starting the Generator" for oil recommendations).
- Wipe up any spilled oil.
- Dispose of used oil at a proper collection center.

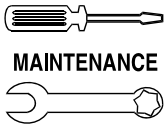

MAINTENANCE

Section 3 — Maintenance

3.3.6 REPLACING THE SPARK PLUGS

Use Champion RC14YC spark plug or equivalent. The correct air gap is 1.01 mm (0.040 in.). **Replace the plugs once each year.** This will help the engine start easier and run better.

1. Stop the engine and pull the spark plug wire off of the spark plug.
2. Clean the area around the spark plug and remove it from the cylinder head.
3. Set the spark plug's gap to 1.01 mm (0.040 in.). Install the correctly gapped spark plug into the cylinder head.

Figure 18 - Spark Plug Gap

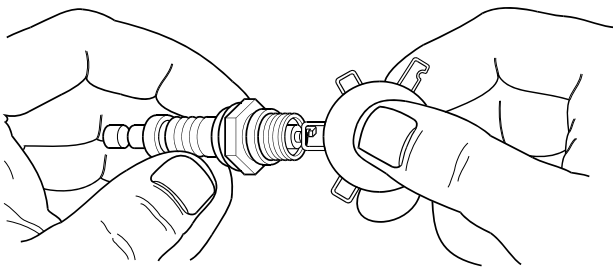

3.4 SERVICE AIR CLEANER

The engine will not run properly and may be damaged if using a dirty air cleaner. Clean or replace the air cleaner paper filter every 200 hours. Clean or replace more often if operating under dusty conditions. Clean foam pre-cleaner every month or more often under dusty conditions.

Figure 19 - Air Cleaner

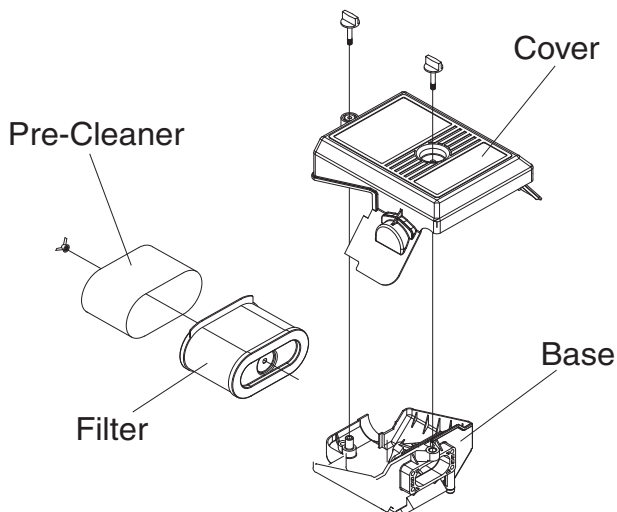

To clean or replace foam pre-cleaner:

- Remove air cleaner cover, then foam pre-filter.
- Wash pre-cleaner in soapy water. Squeeze pre-filter dry in clean cloth (DO NOT TWIST).
- Clean air cleaner cover before re-installing it.

To clean or replace paper air filter:

- Remove air cleaner cover; then remove foam pre-filter (service if necessary) and remove paper filter.
- Clean paper filter by tapping it gently on a solid surface. If the filter is too dirty, replace it with a new one. Dispose of the old filter properly.
- Clean air cleaner cover then slip pre-cleaner over filter. Next insert new paper filter into the base of the air cleaner. Re-install air cleaner cover.

NOTE:

To order a new air filter, please contact the nearest authorized service center at 1-800-333-1322.

3.5 CLEAN SPARK ARRESTOR SCREEN

The engine exhaust muffler has a spark arrestor screen. Inspect and clean the screen at least once each year (Figure 20). If unit is used regularly, inspect and clean more often.

NOTE:

If using the generator on any forest-covered, brush-covered or grass-covered unimproved land, it must be equipped with a spark arrestor. The spark arrestor must be maintained in good condition by the owner/operator.

Clean and inspect the spark arrestor as follows:

- Remove the screen retaining bracket by removing the screw.
- Slide the spark arrestor screen out from the tail pipe.
- Inspect screen and replace if torn, perforated or otherwise damaged. DO NOT USE a defective screen. If screen is not damaged, clean it with commercial solvent.
- Replace the screen and the retaining bracket.

Figure 20 - Spark Arrestor

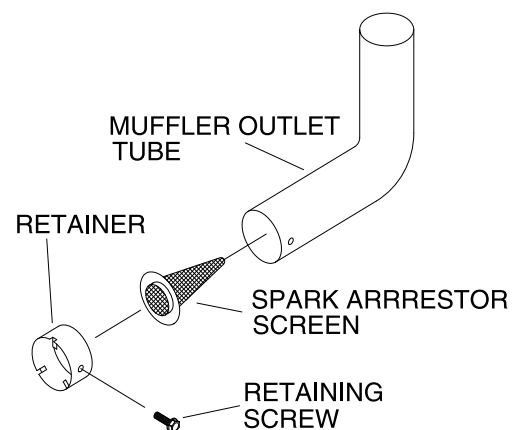

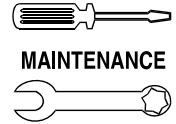

MAINTENANCE

3.6 ADJUSTING VALVE CLEARANCE

After the first 50 hours of operation, check the valve clearance in the engine and adjust if necessary.

Important: If feeling uncomfortable about doing this procedure or the proper tools are not available, please take the generator to the nearest service center to have the valve clearance adjusted. This is a very important step to insure longest life for the engine.

To check valve clearance:

- Make sure the engine is at room temperature (60° - 80° F).
- Make sure that the spark plug wire is removed from the spark plug and out of the way.
- Remove the four screws attaching the valve cover.
- Make sure the piston is at Top Dead Center (TDC) of its compression stroke (both valves closed). To get the piston at TDC, remove the intake screen at the front of the engine to gain access to the flywheel nut. Use a large socket and socket wrench to rotate the nut and hence the engine in a clockwise direction while watching the piston through the spark plug hole. The piston should move up and down. The piston is at TDC when it is up as high as it can go.
- Insert a 0.002 - 0.004 inch (0.05 - 0.1mm) feeler gauge between the rocker arm and valve stem. Correct clearance is when a slight drag is felt when sliding the gauge back and forth. If the clearance is either excessively loose or tight the rocker arms will need adjusting.

To adjust valve clearance:

- Loosen the rocker jam nut (Figure 21). Use an 10mm allen wrench to turn the pivot ball stud while checking clearance between the rocker arm and the valve stem with a feeler gauge. Correct clearance is 0.002-0.004 inch (0.05-0.1 mm).

Figure 21 - Valve Clearance Adjustment

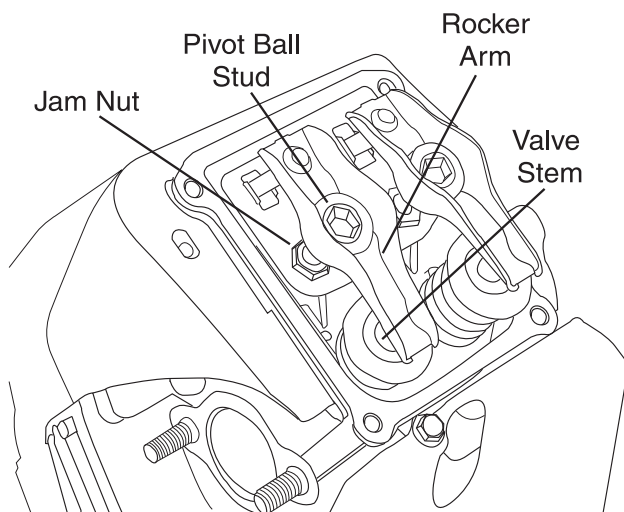

NOTE:

The rocker arm jam nut must be held in place as the pivot ball stud is turned.

When valve clearance is correct, hold the pivot ball stud in place with the allen wrench and tighten the rocker arm jam nut. Tighten the jam nut to 174 in/lbs. torque. After tightening the jam nut, recheck valve clearance to make sure it did not change.

- Install new valve cover gasket.
- Re-attach the valve cover.

NOTE:

Start all four screws before tightening or it will not be possible to get all the screws in place. Make sure the valve cover gasket is in place.

- Re-attach the spark plug wire to the spark plug.
- Repeat the process for the other cylinder.

3.7 GENERAL

The generator should be started at least once every seven days and be allowed to run at least 30 minutes. If this cannot be done and the unit must be stored for more than 30 days, use the following information as a guide to prepare it for storage.



- ⚠ **NEVER store engine with fuel in tank indoors or in enclosed, poorly ventilated areas where fumes may reach an open flame, spark or pilot light as on a furnace, water heater, clothes dryer or other gas appliance.**

3.8 LONG TERM STORAGE

It is important to prevent gum deposits from forming in essential fuel system parts such as the carburetor, fuel hose or tank during storage. Also, experience indicates that alcohol-blended fuels (called gasohol, ethanol or methanol) can attract moisture, which leads to separation and formation of acids during storage. Acidic gas can damage the fuel system of an engine while in storage.

To avoid engine problems, the fuel system should be emptied before storage of 30 days or longer, as follows:

- Remove all gasoline from the fuel tank.



- ⚠ **Drain fuel into approved container outdoors, away from open flame. Be sure engine is cool. Do not smoke.**
- Start and run engine until engine stops from lack of fuel.
- While engine is still warm, drain oil from crankcase. Refill with recommended grade.
- Remove spark plugs and pour about 1/2 ounce (15 ml) of engine oil into the cylinders. Cover spark plug hole with rag. Press the "Start" button and allow engine to crank for 2 seconds. Then press the "Stop" button.

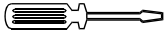

MAINTENANCE

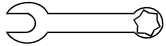

Section 3 — Maintenance

—▲ CAUTION ▲—

▲ Avoid spray from spark plug holes when cranking engine.

- Install and tighten spark plugs. Do not connect spark plug wires.
- Clean the generator outer surfaces. Check that cooling air slots and openings on generator are open and unobstructed.
- Store the unit in a clean, dry place.

3.9 OTHER STORAGE TIPS

- Do not store gasoline from one season to another.
- Replace the gasoline can if it starts to rust. Rust and/or dirt in the gasoline will cause problems with the carburetor and fuel system.
- If possible, store the unit indoors and cover it to give protection from dust and dirt. **BE SURE TO EMPTY THE FUEL TANK.**
- If it is not practical to empty the fuel tank and the unit is to be stored for some time, use a commercially available fuel stabilizer added to the gasoline to increase the life of the gasoline.
- Cover the unit with a suitable protective cover that does not retain moisture.

—▲ DANGER ▲—

- ▲ **NEVER cover the generator while engine and/or exhaust area are warm.**



4.1 TROUBLESHOOTING GUIDE

PROBLEM	CAUSE	CORRECTION
Engine is running, but no AC output is available.	<ol style="list-style-type: none"> 1. Circuit breaker is open. 2. Poor connection or defective cord set. 3. Connected device is bad. 4. Fault in generator. 	<ol style="list-style-type: none"> 1. Reset circuit breaker. 2. Check and repair. 3. Connect another device that is in good condition. 4. Contact Authorized Service Facility.
Engine runs good but bogs down when loads are connected.	<ol style="list-style-type: none"> 1. Short circuit in a connected load. 2. Generator is overloaded. 3. Engine speed is too slow. 4. Shorted generator circuit. 	<ol style="list-style-type: none"> 1. Disconnect shorted electrical load. 2. See "Don't Overload the Generator". 3. Contact Authorized Service Facility. 4. Contact Authorized Service Facility.
Engine will not crank.	<ol style="list-style-type: none"> 1. 10 amp fuse at rear of generator control panel has melted open. 2. Battery weak or dead. 	<ol style="list-style-type: none"> 1. Replace fuse with only an identical 10-amp replacement fuse. 2. Recharge or replace battery.
Engine will not start; or starts and runs rough.	<ol style="list-style-type: none"> 1. Dirty air cleaner. 2. Out of gasoline. 3. Stale gasoline. 4. Spark plug wire not connected to spark plug. 5. Bad spark plug. 6. Water in gasoline. 7. Overchoking. 8. Low oil level. 9. Excessive rich fuel mixture. 10. Intake valve stuck open or closed. 11. Engine has lost compression. 	<ol style="list-style-type: none"> 1. Clean or replace air cleaner. 2. Fill fuel tank. 3. Drain fuel tank and fill with fresh fuel. 4. Connect wire to spark plug. 5. Replace spark plug. 6. Drain fuel tank; fill with fresh fuel. 7. Put choke knob to No Choke position. 8. Fill crankcase to proper level. 9. Contact Authorized Service Facility. 10. Contact Authorized Service Facility. 11. Contact Authorized Service Facility.
Engine shuts down during operation.	<ol style="list-style-type: none"> 1. Out of gasoline. 2. Low oil level. 3. Fault in engine. 	<ol style="list-style-type: none"> 1. Fill fuel tank. 2. Fill crankcase to proper level. 3. Contact Authorized Service Facility.
Engine lacks power.	<ol style="list-style-type: none"> 1. Load is too high. 2. Dirty air filter. 3. Engine needs to be serviced. 	<ol style="list-style-type: none"> 1. See "Don't Overload the Generator". 2. Replace air filter. 3. Contact Authorized Service Facility.
Engine "hunts" or falters.	<ol style="list-style-type: none"> 1. Choke is opened too soon. 2. Carburetor is running too rich or too lean. 	<ol style="list-style-type: none"> 1. Move choke to halfway position until engine runs smoothly. 2. Contact Authorized Service Facility.
No Battery Charge DC output.	<ol style="list-style-type: none"> 1. Battery posts are corroded. 2. Battery cable is bad. 3. Battery is defective. 4. Receptacle is bad. 	<ol style="list-style-type: none"> 1. Clean battery posts. 2. Replace cable. 3. Check battery condition; replace if defective. 4. Contact Authorized Service Facility.



CALIFORNIA EMISSION CONTROL WARRANTY STATEMENT YOUR WARRANTY RIGHTS AND OBLIGATIONS

The California Air Resources Board (CARB) and Generac Power Systems, Inc. (Generac) are pleased to explain the Emission Control System warranty on your new engine. In California, new off-road Large Spark-Ignition (LSI) engines must be designed, built and equipped to meet the state's stringent anti-smog standards. Generac will warrant the emission control system on your engine for the periods of time listed below provided there has been no abuse, neglect, unapproved modification or improper maintenance of your engine.

Your emission control system may include parts such as the carburetor, ignition system, exhaust system and crankcase ventilation system. Generac will repair your engine at no cost to you for diagnosis, replacement parts and labor, should a warrantable condition occur.

MANUFACTURER'S EMISSION CONTROL SYSTEM WARRANTY COVERAGE:

Emissions control systems on 2001 and later model year LSI engines are warranted for two years as hereinafter noted. If, during such warranty period any emission-related component or system on your engine is found to be defective in materials or workmanship, repairs or replacement will be performed by a Generac Authorized Warranty Service Dealer.

PURCHASER'S/OWNER'S WARRANTY RESPONSIBILITIES:

As the engine owner, you are responsible for the completion of all required maintenance as listed in your factory supplied Owner's Manual. For warranty purposes, Generac recommends that you retain all receipts covering maintenance on your engine. However, Generac cannot deny warranty solely due to the lack of receipts or for your failure to ensure the completion of all scheduled maintenance.

As the engine purchaser/owner, you should, however, be aware that Generac may deny any and/or all warranty coverage or responsibility if your engine, or a part/component thereof, has failed due to abuse, neglect, improper maintenance or unapproved modifications, or the use of counterfeit and/or "grey market" parts not made, supplied or approved by Generac.

You are responsible for contacting a Generac Authorized Warranty Dealer as soon as a problem occurs. The warranty repairs should be completed in a reasonable amount of time, not to exceed 30 days.

Warranty service can be arranged by contacting either your selling dealer or a Generac Authorized Warranty Service Dealer. To locate the Generac Authorized Warranty Service Dealer nearest you, call our toll free number:

1-800-333-1322

IMPORTANT NOTE: This warranty statement explains your rights and obligations under the Emission Control System Warranty (ECS Warranty), which is provided to you by Generac pursuant to California law. See also the "Generac Limited Warranties for Generac Power Systems, Inc.," which is enclosed herewith on a separate sheet, also provided to you by Generac. The ECS Warranty applies **only** to the emission control system of your new engine. If there is any conflict in terms between the ECS Warranty and the Generac Warranty, the ECS warranty shall apply except in circumstances where the Generac Warranty may provide a longer warranty period. Both the ECS Warranty and the Generac Warranty describe important rights and obligations with respect to your new engine.

Warranty service can be performed only by a Generac Authorized Warranty Service Facility. When requesting warranty service, evidence must be presented showing the date of the sale to the original purchaser/owner.

If you have any questions regarding your warranty rights and responsibilities, you should contact Generac at one of the following addresses:

**ATTENTION WARRANTY DEPARTMENT
GENERAC POWER SYSTEMS, INC.
P.O. BOX 297 • WHITEWATER, WI 53190**

Part 1



EMISSION CONTROL SYSTEM WARRANTY

Emission Control System Warranty (ECS warranty) for 2001 and later model year LSI engines:

- (a) Applicability: This warranty shall apply to 2001 and later model year engines. The ECS Warranty period shall begin on the date the new engine or equipment is purchased by/delivered to its original, end-use purchaser/owner and shall continue for 24 consecutive months thereafter.
- (b) General Emissions Warranty Coverage: Generac warrants to the original, end-use purchaser/owner of the new engine or equipment and to each subsequent purchaser/owner that each of its engines are:
 - (1) Designed, built and equipped so as to conform with all applicable regulations adopted by the CARB pursuant to its authority, and
 - (2) Free from defects in materials and workmanship which, at any time during the ECS Warranty Period, may cause a warranted emissions-related part to fail to be identical in all material respects to the part as described in the engine manufacturer's application for certification.

The ECS Warranty pertains only to emissions-related parts on your engine, as follows:

- (1) Any warranted, emissions-related parts that are not scheduled for replacement as required maintenance in the *Owner's Manual* shall be warranted for the ECS Warranty Period. If any such part fails during the ECS Warranty Period, it shall be repaired or replaced by Generac according to Subsection (4) below. Any such part repaired or replaced under the ECS Warranty shall be warranted for the remainder of the ECS Warranty Period.
- (2) Any warranted, emissions-related part that is scheduled only for regular inspection as specified in the *Owner's Manual* shall be warranted for the ECS Warranty Period. A statement in such written instructions to the effect of "repair or replace as necessary" shall not reduce the ECS Warranty Period. Any such part repaired or replaced under the ECS Warranty shall be warranted for the remainder of the ECS Warranty Period.
- (3) Any warranted, emissions-related part that is scheduled for replacement as required maintenance in the *Owner's Manual* shall be warranted for the period of time prior to first scheduled replacement point for that part. If the part fails prior to the first scheduled replacement, the part shall be repaired or replaced by Generac according to Subsection (4) below. Any such emissions-related part repaired or replaced under the ECS warranty shall be warranted for the remainder of the ECS Warranty Period prior to the first scheduled replacement point for such emissions-related part.
- (4) Repair or replacement of any warranted, emissions-related part under this ECS Warranty shall be performed at no charge to the owner at a Generac Authorized Warranty Service Facility.
- (5) When the engine is inspected by a Generac Authorized Warranty Service Facility, the purchaser/owner shall not be held responsible for diagnostic costs if the repair is deemed warrantable.
- (6) Generac shall be liable for damages to other original engine components caused by a failure under warranty of any emission-related part covered by the ECS Warranty.
- (7) Throughout the ECS Warranty Period, Generac shall maintain a supply of warranted emission-related parts sufficient to meet the expected demand for such emission-related parts.
- (8) Any Generac authorized and approved emission-related replacement part may be used in the performance of any ECS warranty maintenance or repairs and will be provided without charge to the purchaser/owner. Such use shall not reduce Generac ECS Warranty obligations.
- (9) Unapproved, add-on, modified, counterfeit and/or "grey market" parts may not be used to modify or repair a Generac engine. Such use voids this ECS Warranty and shall be sufficient grounds for disallowing an ECS Warranty claim. Generac shall not be held liable hereunder for failures of any warranted parts of a Generac engine caused by the use of such an unapproved, add-on, modified, counterfeit and/or "grey market" part.

EMISSION RELATED PARTS INCLUDE THE FOLLOWING:

- | | |
|--|---|
| 1) Fuel Metering System: | 3) Ignition System including: |
| 1.2) LPG/Natural Gas carburetion assembly and its internal components. | a) Spark plug |
| a) Fuel controller (if so equipped) | b) Ignition module |
| b) Mixer and its gaskets (if so equipped) | 4) Catalytic Muffler Assembly (if so equipped) including: |
| c) Carburetor and its gaskets (if so equipped) | a) Muffler gasket |
| d) Primary gas regulator (if so equipped) | b) Exhaust manifold |
| e) LP liquid vaporizer (if so equipped) | 5) Crankcase Breather Assembly including: |
| 2) Air Induction System including: | a) Breather connection tube |
| a) Intake pipe/manifold | |
| b) Air cleaner | |

* Generac engine types covered by this warranty statement include the following:

- 1) Prepackaged Standby Generator
- 2) Auxiliary Power Unit (APU) Generator
- 3) Portable Generator
- 4) Standby Generator



Section 5 – Warranty

GENERAC POWER SYSTEMS “TWO YEAR” LIMITED WARRANTY FOR GP SERIES PORTABLE GENERATORS

For a period of two years from the date of original sale, Generac Power Systems, Inc. (Generac) warrants its GP Series generators will be free from defects in materials and workmanship for the items and period set forth below. Generac will, at its option, repair or replace any part which, upon examination, inspection and testing by Generac or a Generac Authorized Warranty Service Dealer, is found to be defective. Any equipment that the purchaser/owner claims to be defective must be returned to and examined by the nearest Generac Authorized Warranty Service Dealer. All transportation costs under the warranty, including return to the factory, are to be borne and prepaid by the purchaser/owner. This warranty applies only to Generac GP Series portable generators and is not transferable from original purchaser. Save your proof-of-purchase receipt. If you do not provide proof of the initial purchase date, the manufacturer's shipping date of the product will be used to determine the warranty period.

WARRANTY SCHEDULE

Consumer applications are warranted for two (2) years. Commercial and Rental applications are warranted for one (1) year or 1000 hours maximum, whichever comes first.

CONSUMER APPLICATION

YEARS ONE and TWO - 100% (one hundred percent) coverage on Labor and Part(s) listed (proof of purchase and maintenance is required):

- Engine- All Components
- Alternator- All Components

COMMERCIAL/RENTAL APPLICATION

YEAR ONE – 100% (one hundred percent) coverage on Labor and Part(s) listed (proof of purchase and maintenance is required):

- Engine- All Components
- Alternator- All Components

NOTE: For the purpose of this warranty “consumer use” means personal residential household or recreational use by original purchaser. This warranty does not apply to units used for Prime Power in place of utility where utility power service is present or where utility power service does not normally exist. Once a generator has experienced commercial or rental use, it shall thereafter be considered a non-consumer use generator for the purpose of this warranty.

All warranty expense allowances are subject to the conditions defined in Generac's Warranty Policies, Procedures and Flat Rate Manual.

THIS WARRANTY SHALL NOT APPLY TO THE FOLLOWING:

- Generac built portable generators built prior to May 2008.
- Generac portable generators that utilize non-Generac replacement parts.
- Costs of normal maintenance and adjustments.
- Failures caused by any contaminated fuels, oils or lack of proper oil levels.
- Repairs or diagnostics performed by individuals other than Guardian/Generac authorized dealers not authorized in writing by Generac Power Systems.
- Failures due, but not limited, to normal wear and tear, accident, misuse, abuse, negligence or improper use. As with all mechanical devices, the Generac engines need periodic part(s) service and replacement to perform as designed. This warranty will not cover repair when normal use has exhausted the life of a part(s) or engine.
- Failures caused by any external cause or act of God, such as collision, theft, vandalism, riot or wars, nuclear holocaust, fire, freezing, lightning, earth-quake, windstorm, hail, volcanic eruption, water or flood, tornado or hurricane.
- Damage related to rodent and/or insect infestation.
- Products that are modified or altered in a manner not authorized by Generac in writing.
- Any incidental, consequential or indirect damages caused by defects in materials or workmanship, or any delay in repair or replacement of the defective part(s).
- Failure due to misapplication.
- Telephone, cellular phone, facsimile, internet access or other communication expenses.
- Living or travel expenses of person(s) performing service, except as specifically included within the terms of a specific unit warranty period.
- Expenses related to “customer instruction” or troubleshooting where no manufacturing defect is found.
- Rental equipment used while warranty repairs are being performed.
- Overnight freight or special shipping costs for replacement part(s).
- Overtime, holiday or emergency labor.
- Starting batteries, fuses, light bulbs and engine fluids.

THIS WARRANTY IS IN PLACE OF ALL OTHER WARRANTIES, EXPRESSED OR IMPLIED. SPECIFICALLY, GENERAC MAKES NO OTHER WARRANTIES AS TO THE MERCHANTABILITY OR FITNESS FOR A PARTICULAR PURPOSE. Some states do not allow limitations on how long an implied warranty lasts, so the above limitation may not apply to you. GENERAC'S ONLY LIABILITY SHALL BE THE REPAIR OR REPLACEMENT OF PART(S) AS STATED ABOVE. IN NO EVENT SHALL GENERAC BE LIABLE FOR ANY INCIDENTAL OR CONSEQUENTIAL DAMAGES, EVEN IF SUCH DAMAGES ARE A DIRECT RESULT OF GENERAC'S NEGLIGENCE. Some states do not allow the exclusion or limitation of incidental or consequential damages, so the above limitation may not apply to you. This warranty gives you specific legal rights. You also have other rights from state to state.

GENERAC POWER SYSTEMS, INC.

P.O. BOX 8 • Waukesha, WI 53187

Ph: (888) GENERAC (436-3722) • Fax: (262) 544-4851

To locate the nearest Authorized Dealer visit our website www.generac.com

Free Manuals Download Website

<http://myh66.com>

<http://usermanuals.us>

<http://www.somanuals.com>

<http://www.4manuals.cc>

<http://www.manual-lib.com>

<http://www.404manual.com>

<http://www.luxmanual.com>

<http://aubethermostatmanual.com>

Golf course search by state

<http://golfingnear.com>

Email search by domain

<http://emailbydomain.com>

Auto manuals search

<http://auto.somanuals.com>

TV manuals search

<http://tv.somanuals.com>