

Scientific-Atlanta

Bringing the Interactive Experience Home™



Explorer® 3170HD

High Definition Digital Interactive Set-Top User's Guide



IMPORTANT RULES SAFE OPERATION

Note to CATV System Installer (USA/Canada Only)

This reminder is provided to call the CATV system installer's attention to Article 820-40 of the NEC (Section 54, Part I of the Canadian Electrical Code), that provides guidelines for proper grounding and, in particular, specifies that the CATV cable ground shall be connected to the grounding system of the building, as close to the point of cable entry as practical.

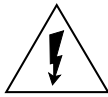

This symbol is intended to alert you that uninsulated voltage within this product may have sufficient magnitude to cause electric shock. Therefore, it is dangerous to make any kind of contact with any inside part of this product.

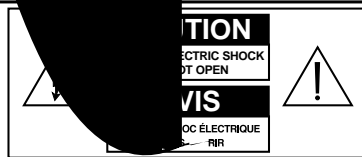

CAUTION: To reduce the risk of electric shock, do not remove cover (or back). No user-serviceable parts inside. Refer servicing to qualified service personnel.

WARNING
**TO PREVENT FIRE OR ELECTRIC SHOCK,
DO NOT EXPOSE THIS UNIT TO RAIN OR
MOISTURE.**



This symbol is intended to alert you of the presence of important operating and maintenance (servicing) instructions in the literature accompanying this product.

Read and Retain These Instructions

- Read all of the instructions before you operate this set-top. Give particular attention to all safety precautions. Retain the instructions for future reference.
- Comply with all warning and caution statements in the instructions. Observe all warning and caution symbols that are affixed to this set-top.
- Comply with all instructions that accompany this set-top.

Placement

Place this set-top in a location that is close enough to an electrical outlet to accommodate the length of the power cord. Place this set-top on a stable surface. The surface must support the size and weight of this set-top.

 **WARNING:**
Avoid personal injury and damage to this set-top. An unstable surface may cause this set-top to fall.

Ventilation

This set-top has openings for ventilation that protect it from overheating. To ensure the reliability of this set-top, follow these guidelines to avoid obstructing the openings:

- Do not place other equipment, lamps, books, or any other object on the top of this set-top.
- Do not place this set-top in any of the following locations:
 - On a bed, sofa, rug, or similar surface
 - Over a radiator or a heat register
 - In an enclosure, such as a bookcase or equipment rack, unless the installation provides proper ventilation

Cleaning the Set-Top

Before cleaning this set-top, unplug it from the electrical outlet. Use a damp cloth to clean this set-top. Do not use a liquid cleaner or an aerosol cleaner. Do not use a magnetic/static cleaning device (dust remover) to clean this set-top.

Object and Liquid Entry

Never push objects of any kind into this product through openings as they may touch dangerous voltage points or short out parts that could result in a fire or electric shock. Do not expose this set-top to liquid or moisture. Do not place this set-top on a wet surface. Do not spill liquids on or near this set-top.

Accessories

Do not use accessories with this set-top unless recommended by Scientific-Atlanta.

Overloading

Do not overload electrical outlets, extension cords, or integral convenience receptacles, as this can result in a risk of fire or electric shock. For equipment that requires battery power or other sources to operate, refer to the operating instructions for that equipment.

Lightning and Power Surges

Ground (earth) your cable system to provide some protection against voltage surges and built-up static charges. Plug your set-top into a surge protector to reduce the risk of damage from lightning strikes and power surges. If you have questions, call your cable service provider.

Power Cord Protection

Arrange all power cords so that people cannot walk on the cords, place objects on the cords, or place objects against the cords, which can damage the cords. Give particular attention to the cords at the point at which the cord connects to the plug, at electrical outlets, and at the places where the cords exit the set-top.

Power Sources

A label on this set-top indicates the correct power source for this set-top. Operate this set-top only from an electrical outlet that has the voltage and frequency that the label indicates.

If you are unsure of the type of power supply to your residence, consult your cable service provider or your local power company.

Grounding

This set-top has a two-prong plug. Properly ground (earth) this set-top by inserting the plug into a grounded electrical, two-socket outlet. If this plug is polarized, it has one wide prong and one narrow prong. This plug fits only one way.



CAUTION:

To prevent electric shock, match wide blade of plug to the wide slot, and then fully insert.

If you are unable to insert this plug fully into the outlet, contact an electrician to replace your obsolete outlet.

Servicing

Do not open the cover of this set-top. If you open the cover, your warranty will be void. Refer all servicing to qualified personnel only.

Damage that Requires Service

For damage that requires service, unplug this set-top from the electrical outlet. Refer to the “Limited Warranty” at the end of this guide if your set-top does not operate when plugged into your electrical outlet and connected to the cable television outlet.

Screen Burn-In Warning

Please refer to the user’s guide that came with your high-definition television (HDTV) for an important message regarding images being permanently “burned in” to your HDTV screen.

In This Guide

Welcome!	5
Before You Begin	8
Connecting the Set-Top	9
Setting Up Your Remote	15
TV Codes for the Remote	18
VCR Codes for the Remote	20
AUX Codes for the Remote	22
CBL Codes for the Remote	23
Setting Up Advanced Features for the Remote	24
Using the Explorer 3170HD Set-Top	27
Setting Up the VCR Commander Service	29
VCR Commander Service Codes	33
Scheduling a VCR Recording	36
Troubleshooting	38
Index	43

Welcome!

Congratulations! You are now the owner of one of the most advanced set-top boxes on the market. Scientific-Atlanta's Explorer® 3170HD Set-Top represents the latest in technical innovation allowing you the ability to view cable television programming for high-definition television (HDTV) as well as standard-definition television (SDTV). The Explorer 3170HD Set-Top also provides you with the ability to experience the fullest television experience including video-on-demand (VOD), if offered by your cable service provider. Just ask your cable service provider if these exciting services are available in your area.

To start enjoying the most advanced television picture available, first read the important information contained in this user's guide. It is filled with information that will allow you to enjoy your Explorer 3170HD Set-Top for years to come.

Once you've read the user's guide, call your cable service provider. To activate your service, you must provide them with the serial number of your set-top. You can locate this number on the back of your set-top, or on the outside carton label. This number is very important so you will want to be sure to jot it down with the other information requested on page 7.

Contents

The Explorer 3170HD Set-Top carton contains the following items:



an Explorer 3170HD Set-Top



an AllTouch 2400 remote control, including batteries



a 10-ft YPbPr (component video) cable



an IR Blaster, for use with the VCR Commander™ Service*



a 10-ft audio/video cable



a power cord

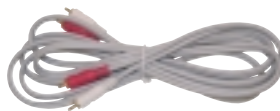

a 10-ft audio cable



this User's Guide



two "Y" cables
(one white, one red)



a warranty card

*Contact your cable service provider to see if this service is available in your area.

Serial Number and MAC Address

You must know your serial number in order to receive digital cable services. In addition, Scientific-Atlanta may need to know your serial number to provide technical assistance.

Use the space provided here to record your

set-top serial number and MAC address:
Serial Number (from the label on the back of the set-top): _____

MAC Address (from the label on the back of the set-top): _____

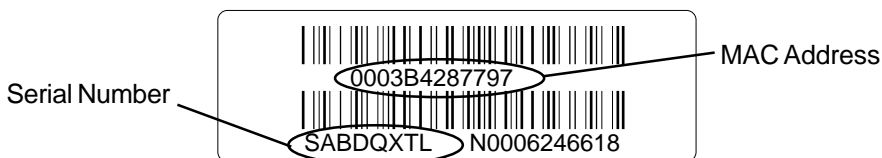

Device Codes

Your IR Blaster and your remote control use codes to operate various other devices, such as a TV, VCR, or DVD player. After you program these codes (later in this guide), you should record the codes here for future reference.

VCR Commander Service code: _____

Remote Control codes:

AUX: _____ VCR: _____

TV: _____ CBL: _____

Important Phone Numbers

Before you connect your set-top to your HDTV, you must contact your cable service provider and ask them to turn on cable services for your set-top. In addition, you may need to contact your cable service provider for troubleshooting or other issues. Record the phone number for your

cable service provider here:

If you believe that your equipment needs repair or replacement, contact Scientific-Atlanta at 1-866-212-2141.

Explorer eClub

For additional information about your set-top, Scientific-Atlanta invites you to join the Explorer eClub. This online club provides news and “what’s up” information about the Explorer 3170HD Set-Top and offers you a chance to win prizes.

To join the Explorer eClub, you must know the serial number of your set-top. You can access the Explorer eClub on the Internet at the following web address:
www.scientificatlanta.com/explorerclub

Before You Begin

- Read the IMPORTANT RULES FOR SAFE OPERATION section of this guide.
- Locate the serial number for your set-top, which is on a bar code on the back panel of the set-top. You will need this serial number to join the Explorer eClub. Also, if your system requires troubleshooting in the future, your cable service provider or Scientific-Atlanta may ask for the serial number.
- If you plug the set-top into an outlet that is controlled by a wall switch, keep the switch in the ON position. The on-screen guide is updated nightly. If the wall switch is in the OFF position, your set-top will not receive the latest programming updates.
- Keep the top of the set-top free of all objects and electronic devices, including your TV.
- It is recommended that you connect a surge protector to your cable equipment and electronic devices.

Back Panel Connectors

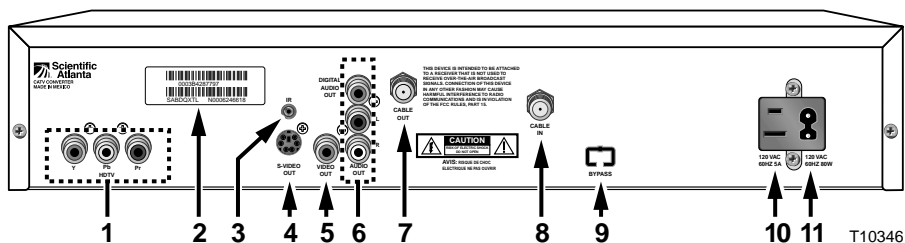

- 1 Connect the HDTV (Y, Pb, and Pr) output ports to the HDTV input on your HDTV. You must use these ports to provide HDTV signals to your HDTV.
- 2 Record your serial number and MAC address shown on this label in the Reference Numbers section of this guide. These numbers provide information about your set-top.
- 3 Attach the IR Blaster cable to use with the optional VCR Commander Service. See **Setting Up the VCR Commander Service** later in this guide.
- 4 Connect an S-Video cable to send an S-Video signal to your TV or VCR. This signal is SDTV but higher-quality than other SDTV connections.
- 5 Connect an RCA cable to Digital Audio Out to send a digital audio signal to a surround-sound receiver or other digital audio device.
- 6 Connect an RCA cable to Video Out to send a regular video signal to your TV or VCR. This signal is SDTV.
- 7 Connect RCA cables to Audio Out to send analog audio signals (left and right) to a stereo receiver or a TV with stereo inputs.
- 8 Connect a coaxial cable to Cable Out to send analog audio and video signals to a TV or VCR. These signals are SDTV video with mono audio.
- 9 Connect the coaxial cable that delivers the signal from your cable service provider.
- 10 Connect an optional RF Bypass module to your set-top. This module allows you to view one channel while recording another. Contact your cable service provider to see if this service is available.
- 11 Connect the power cord for another device to deliver power to that device.
- 12 Connect the power cord provided to deliver power to the set-top.

Connecting the Set-Top

Now that you've unpacked the Explorer 3170HD Set-Top from its carton, you're ready to connect it to your HDTV and other electronic devices. Follow these steps and use the connection diagrams on the following pages to connect the set-top to your HDTV and other devices.



WARNING:
Electric shock hazard! Unplug all electronic devices before connecting or disconnecting any device cables.

1. Unplug all electronic devices before connecting the set-top.
2. Contact your cable service provider and ask them to turn on cable services for your set-top. Be prepared to give them the serial number from the back panel of your set-top. You should have written this number down on page 7 of this guide.
Note: If you do not contact your cable service provider, your set-top will not be able to receive some or all of the available services.
3. Connect the set-top to your HDTV, VCR, and other devices as shown in the diagrams later in this guide. (The diagrams in this guide do not cover every possible wiring combination.)
4. Connect the set-top to the coaxial cable coming from the wall.
5. Plug the set-top and the TV into an AC power source, but do not turn on your set-top or HDTV yet.
6. Wait for the front of your set-top to display one of the following:
 - Current time
 - Four dashes (- - - -)**Important:** It may take several minutes for the set-top to receive the latest software, programming, and service information. When the front panel displays the time or four dashes, the update is complete.
7. After the update is complete, press **POWER** to turn on your set-top.
8. Turn on the power to your HDTV.

Wiring Diagrams

The diagrams on the following pages show examples of common ways to connect your set-top to your HDTV, VCR, and home theater receiver. However, these diagrams do not show every possible combination of devices. Please consult the user's guides that came with your other devices for further information.

Some of the cables shown in the diagrams may not be included with your Explorer Set-Top.

Important: Be sure to follow the steps listed in **Connecting the Set-Top**. If you do not do so, your set-top will not be authorized to receive digital services.

HDTV Formats

Most HDTVs include YPbPr connectors for component video inputs, and your Explorer 3170HD Set-Top includes a YPbPr cable for these inputs.

However, some HDTVs only have RGB inputs. If you have one of these HDTVs, you may need a connection converter.

Check with the store where you purchased your set-top, or contact Scientific-Atlanta toll-free at 866-212-2141.

Also, some SDTVs include YPbPr inputs. Your set-top will *not* function correctly with these inputs.

Audio Output

To hear stereo sound, you must do one of the following:

- Connect stereo audio cables from the AUDIO OUT LEFT and RIGHT connectors on the set-top to the AUDIO IN LEFT and RIGHT connectors on your HDTV
- Connect an RCA cable from the DIGITAL AUDIO OUT on your set-top to the DIGITAL AUDIO IN on your HDTV (if equipped) or stereo receiver

In addition, you may also connect an S-Video cable from the S-VIDEO OUT connector on the set-top to the S-VIDEO connector on the HDTV or VCR. However, the S-Video connection does not supply audio. You must also use audio cables with the S-Video cable.

If you connect the set-top to your HDTV using only the coaxial cable at the CABLE OUT connection, your HDTV will not receive stereo sound from your set-top.

Note: S-Video and coaxial cables only deliver SDTV programming. They do not deliver HDTV programming.

Set-Top Connected to HDTV Using Component Video Cable

This diagram shows an Explorer 3170HD Set-Top connected to an HDTV using the component video cable (YPbPr). This setup provides all programming content—both HDTV and SDTV programming—through the HDTV inputs on the HDTV.

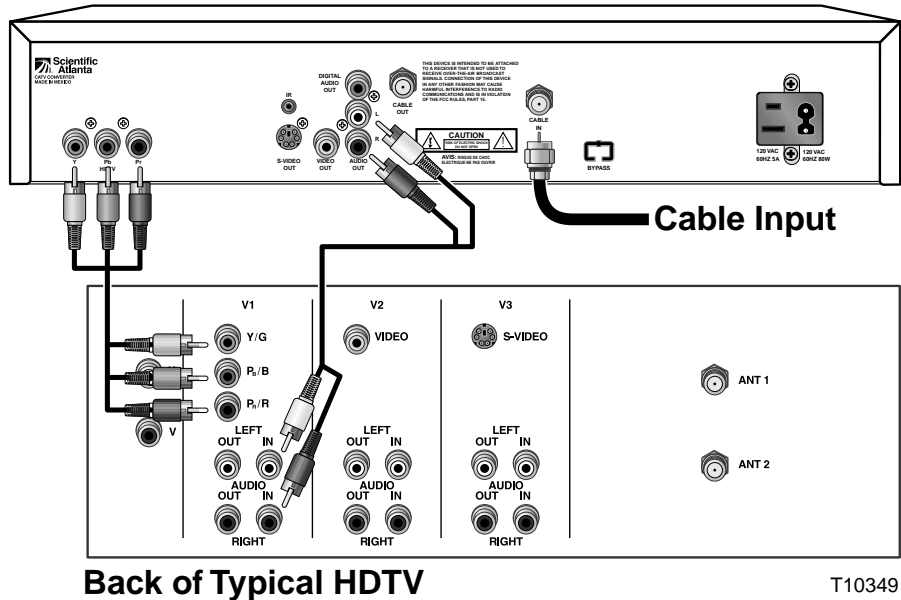

Set-Top Connected to HDTV Using Component Video Cable and SDTV Video Cable

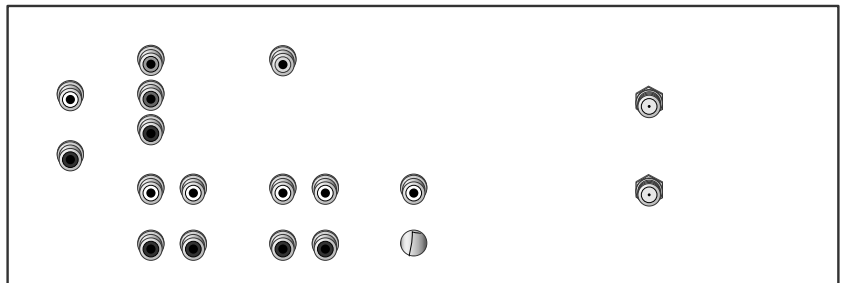
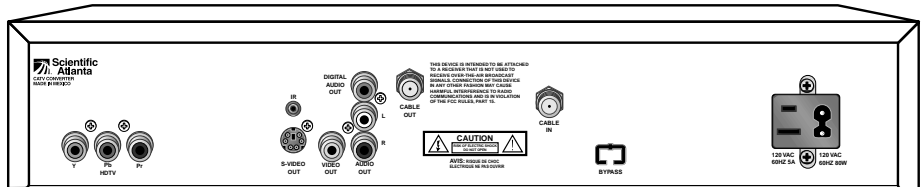



13

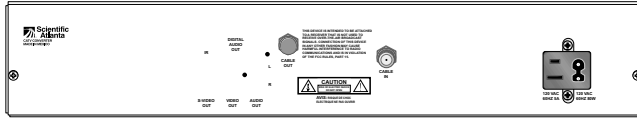

Setting Up Your Remote

Your universal remote is configured from the factory to control your set-top. In addition, you can program your remote to control most TV and VCR models, as well as various additional devices.

Your remote requires two AA batteries (included). Alkaline batteries are recommended. If the light on the remote flashes twice whenever you press a key, the batteries are weak and should be replaced.

Use the following procedure to replace the batteries.

 **CAUTION:**

Make sure you correctly align the positive (+) and negative (-) terminals on the batteries to the corresponding terminals in the remote control.

1. Press forward and lift the lever on the back cover of the remote control. The battery cover releases, and then you can pull up the cover to remove it.

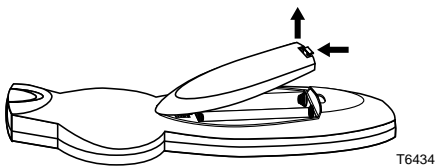

2. Remove and safely dispose of the old batteries.
3. Insert and firmly seat two new AA batteries (alkaline recommended) into the battery compartment.

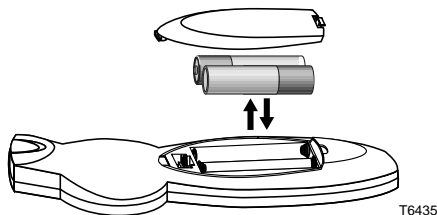

4. Slide the battery cover back onto the remote control, and snap the cover into place.

Programming the Mode Keys

The mode keys are the four buttons arched across the top of the remote. These buttons are labeled AUX, VCR, TV, and CBL and let you specify the device you want to control when you are using the remote. For example, to turn on your HDTV, you would press TV and then press POWER.

Your remote control arrives from the factory already programmed with the following codes:

TV 0068

VCR 0095

CBL 0458

AUX 1037

These codes operate many popular brands of electronic devices. Before you program any new codes into your remote, you should check to see if the remote already controls your devices.

To test a mode key, turn on a device, press the mode key for that device, and then press POWER on the remote.

- If the device turns off, then the mode key is probably programmed correctly. You should not need to program a new code for that mode key.
- If the device does not turn off, you must program a new code for this mode key.

Follow these steps to program a mode key:

1. Find the code for your brand of device in one of the code lists in this guide. The code lists begin on page 18.



2. Make sure that the device is turned on.
 3. Press **SELECT** and a mode key (AUX, VCR, TV or CBL) at the same time until the light at the top of the remote blinks twice. For example, to set up the TV key, press **SELECT** and **TV** at the same time.
 4. Enter the code for the device. For example, if you have a Sony TV, enter 0 0 1 4.
 5. Point the remote toward the device.
 6. Press **POWER**, **PLAY**, or **CH+** to test the device.
 7. Did the device operate correctly?
 - If **yes**, this mode key is programmed correctly. Write down these numbers on page 7 of this guide. You're ready to use the same steps for the other mode keys.
 - If **no**, repeat these steps using a different code.
- Note:** If all of the codes listed for your brand of device fail to operate your device properly, go to the **Finding More Codes** section of this guide for instructions.

Unlocking the CBL Mode Key

Your remote control is already set up to operate your set-top. The CBL mode key is locked to keep you from changing this setting accidentally. If you need to change this setting to operate another device, you must "unlock" the CBL mode key.

1. Press the **SELECT** key and the **CBL** key at the same time until the LED blinks twice.
2. Press **9 9 6**.
3. Press **CH-** to unlock the remote.

Result: You can now set up your CBL key with a different cable code.

Finding More Codes

If none of the codes listed for your device work, you can search through the code library for a valid code.

1. Turn on the device.
2. Press **SELECT** and a mode key (**AUX**, **VCR**, **TV**, or **CBL**) at the same time until the light blinks twice. For example, to search for a TV code, press **SELECT** and **TV** at the same time.
3. Using the keypad on the remote, press **9 9 1**. The light blinks once.
4. Point the remote toward the device, and press **POWER**.

5. Did the device turn off?
 - If **no**, press **▲** to go to the next code, and then press **POWER** to try again.
 - If **yes**, press **SELECT** to confirm the code.

Note: Each code library contains the following number of codes:

- TV: 51 codes
- VCR: 56 codes
- AUX: 57 codes
- CBL: 10 codes

What Code Did I Find?

You can find out which code you used to program your remote by using the following procedure.

1. Press **SELECT** and a mode key (**AUX**, **VCR**, **TV**, or **CBL**) at the same time until the light blinks twice.
2. Using the keypad on the remote, press **9 9 0**. The light blinks twice.
3. Press **1**; then, count the light blinks. The number of light blinks indicates the first digit in the code. For example, four blinks indicates the first digit in the code is 4. If the light does not blink, the digit is 0.
4. Press **2**; then, count the light blinks. The number of blinks indicates the second digit in the code.
5. Press **3**; then, count the light blinks. The number of blinks indicates the third digit in the code.
6. Press **4**; then, count the light blinks. The number of blinks indicates the fourth digit in the code.
7. Write down your codes on page 7 of this guide.

TV Codes for the Remote

The default code for your TV mode key is **0068**.

Brand	Code
AOC	0033, 0044
Admiral	0107, 0477
Aiko	0106
Aiwa	0715
Akai	0044
Alaron	0193
America Action	0194
Ampro	0765
Anam	0194
Audiovox	0106, 0194, 0465, 0637
Baysonic	0194
Belcor	0033
Bell & Howell	0030, 0168
Bradford	0194
Brockwood	0033
Broksonic	0250, 0477
CXC	0194
Candle	0044, 0070
Carnivale	0044
Carver	0068
Celebrity	0014
Cineral	0465, 0106
Citizen	0070, 0044, 0074, 0106
Concerto	0070
Contec	0194
Craig	0194
Crosley	0068
Crown	0194
Curtis Mathes	0074, 0044, 0030, 0061, 0065, 0068, 0070, 0107, 0159, 0168, 0180, 0465, 0761, 1161, 1361
Daewoo	0106, 0637, 0033, 0638, 0465
Daytron	0033
Denon	0159
Dumont	0031, 0033
Dwin	0788
Electroband	0014
Emerson	0250, 0194, 0192, 0193, 0477, 0638, 0637, 0033, 0168
Envision	0044
Fisher	0168
Fujitsu	0193
Funai	0194, 0185, 0193
Futuretech	0194
GE	0035, 0061, 1361, 0065, 0192, 0465, 1161, 0107, 0761
Gibraltar	0031, 0033, 0044
GoldStar	0192, 0033, 0044, 0070
Gradiente	0070, 0067
Grunpy	0193, 0194
Hallmark	0192
Harley Davidson	0193
Harman/Kardon	0068
Harvard	0194
Hitachi	0159, 0070, 0030
Infinity	0068
Inteq	0031
JBL	0068
JCB	0014
JVC	0067
KEC	0194
KTV	0194, 0044
Kenwood	0044, 0033
Konka	0721, 0646, 0642, 0652, 0717
LG	0070
LXI	0168, 0061, 0068, 0170, 0192, 0761
Logik	0030
Luxman	0070
MGA	0164, 0033, 0044, 0192
MTC	0074, 0044, 0033, 0070
Magnavox	0068, 0044, 0193, 1268
Majestic	0030
Marantz	0068, 0044
Matsushita	0264
Megatron	0159, 0192
Memorex	0193, 0477, 0192, 0030, 0070, 0164, 0168, 0264
Midland	0031, 0061, 0065, 0761
Minutiz	0035
Mitsubishi	0164, 0192, 0033, 0107

VCR Codes for the Remote

Your VCR mode key can control a VCR or a DVD player. Use these codes to choose one of those devices.

The default code for your VCR mode key is **0095**.

VCR Codes

Brand	Code
Admiral	0062, 0223
Adventura	0014
Aiwa	0014, 0051
Akai	0055
American High	0049
Asha	0254
Audiovox	0051
Beaumarck	0254
Bell & Howell	0118
Broksonic	0135, 0198, 0223, 0493
CCE	0086
Calix	0051
Canon	0049
Carver	0095
Citizen	0051
Colt	0086
Craig	0051, 0086, 0061, 0254
Curtis Mathes	0049, 0055, 0074, 0176, 0774
Cybernex	0254
Daewoo	0059
Denon	0056
Dynatech	0014
Electrohome	0051
Electroponic	0051
Emerex	0046
Emerson	0198, 0223, 0135, 0493, 0014, 0051, 0057
Fisher	0061, 0118
Fuji	0047, 0049
Funai	0014
GE	0049, 0074, 0062, 0254, 0774
Garrard	0014
GoldStar	0051
Gradiente	0014
HI-Q	0061

Harley Davidson	0014
Harman/Kardon	0095
Harwood	0086
Hitachi	0056, 0014, 0055
Hughes Network Systems	0056
JVC	0081, 0055
Jensen	0055
KEC	0051
KLH	0086
Kenwood	0055, 0081
Kodak	0049, 0051
LXI	0051
Lloyd's	0014
Logik	0086
MEI	0049
MGA	0057, 0254
MGN Technology	0254
MTC	0014, 0254
Magnavox	0049, 0095, 0014, 0053
Magnin	0254
Marantz	0095, 0049
Marta	0051
Matsushita	0049, 0176
Memorex	0118, 0061, 0493, 0014, 0051, 0062, 0049, 0254, 1051, 0053, 0176, 0223, 1176, 1276
Minolta	0056
Mitsubishi	0057, 0062, 0081
Motorola	0049, 0062
Multitech	0014, 0086
NEC	0055, 0081, 0118
Nikko	0051
Noblex	0254
Olympus	0049
Optimus	0176, 1076, 1176, 0062, 1276, 0051, 1062, 0118
Orion	0493, 0198, 0223
Panasonic	0049, 0176, 1176, 1276, 0239, 0630, 1076
Penney	0049, 0254, 0051, 0056
Pentax	0056
Philco	0049, 0223, 0493

VCR Codes for the Remote

Philips	0095, 0049, 0632
Pilot	0051
Pioneer	0081
Polk Audio	0095
Profitronic	0254
Proscan	0074, 0774
Protec	0086
Pulsar	0053
Quasar	0049, 0176, 1176
RCA	0074, 0056, 0049, 0062, 0254, 0774
Radio Shack	0014, 1051
Radix	0051
Randex	0051
Realistic	0014, 0118, 0061, 0062, 0051, 0049
ReplayTV	0628, 0630
Runco	0053
STS	0056
Samsung	0059, 0254
Sanky	0053, 0062
Sansui	0055, 0493, 0014, 0081, 0223
Sanyo	0061, 0118, 0254
Scott	0198, 0135, 0057, 0059
Sears	0051, 0056, 0014, 0049, 0061, 0118
Semp	0059
Sharp	0062
Shintom	0086
Shogun	0254
Singer	0086
Sony	0047, 0046, 0014, 0049, 0650, 1046
Sylvania	0049, 0095, 0014, 0057
Symphonic	0014
TMK	0254
Tatung	0055
Teac	0014, 0055
Technics	0049, 0176
Teknika	0014, 0049, 0051
Thomas	0014
Tivo	0632, 0650
Toshiba	0059, 0057

Totevision	0051, 0254
Unitech	0254
Vector	0059
Video Concepts	0059
Videosonic	0254
Wards	0049, 0074, 0014, 0061, 0254, 0056, 0062, 0086, 0095, 0774
White Westinghouse	0086, 0223
XR-1000	0086, 0014, 0049
Zenith	0053, 0014, 0047, 0223, 0493

DVD Codes

Brand	Code
Apex	0686
Denon	0504
Fisher	0684
GE	0536
Gradiente	0665
Hitachi	0587, 0678
Hiteker	0686
JVC	0637, 0572
Kenwood	0548
Magnavox	0517, 0689
Marantz	0553
Mitsubishi	0535
Onkyo	0517
Optimus	0585
Oritron	0665
Panasonic	0504, 0646
Philips	0553, 0517
Pioneer	0585, 0539, 0646
Proscan	0536
RCA	0536, 0585
Samsung	0587
Sharp	0644
Sony	0547
Technics	0504
Theta Digital	0585
Toshiba	0517
Yamaha	0504, 0559
Zenith	0605, 0517

AUX Codes for the Remote

Your AUX mode key can control a CD player, receiver, amplifier, or additional audio devices. Use these codes to choose one of those devices. The default code for your TV mode key is **1037**.

CD Codes

Brand	Code
Aiwa	0171
California Audio Labs	0043
Carver	0171, 0193
DKK	0014
Denon	0887
Fisher	0193
Genexxa	0046
Harman/Kardon	0171, 0187
Hitachi	0046
JVC	0086
Kenwood	0042, 0840, 0051, 0640, 0695
Krell	0171
Linn	0171
MCS	0043
Magnavox	0171
Marantz	0171, 0640, 0043
Mission	0171
NSM	0171
Onkyo	0882
Optimus	0046, 0193, 1077, 0014, 0051
Panasonic	0043
Philips	0171, 0640
Pioneer	0046, 1076, 1077
Polk Audio	0171
Proton	0171
QED	0171
Quasar	0043
RCA	0046, 1076, 0193
Realistic	0193
Rotel	0171
SAE	0171
Sansui	0171
Sanyo	0193
Sharp	0051, 0875
Sherwood	1081

Sonic Frontiers	0171
Sony	0014, 0504
Technics	0043
Victor	0086
Wards	0171
Yamaha	0902

Receiver Codes

Brand	Code
ADC	0545
Aiwa	1419, 0172, 1103
Capetronic	0545
Carver	1103, 1203
Denon	1174, 1118
JVC	0088
Kenwood	0041, 1041, 1327, 1583, 1584
MCS	0053
Magnavox	1103, 0545, 1203
Marantz	1203, 1103, 0053
Onkyo	0149
Optimus	1037, 0545
Panasonic	0053, 1532
Philips	1103, 1203, 1283
Pioneer	0545, 1037
Proscan	1268
Quasar	0053
RCA	1268, 0545, 1037
Sansui	1103
Sony	0172, 1172, 1072, 1272
Sunfire	1327
Technics	0053, 1322, 1532, 1323
Thorens	1203
Victor	0088
Wards	0172
Yamaha	0190, 1190

Additional Audio Codes

These codes allow you to program your remote to control cable radio set-top devices.

Brand	Code
Jerrold	0473, 0534
Scientific Atlanta	0474
Starcom	0473

AUX Codes for the Remote

Amplifier Codes

Brand	Code
GE	0092
Harman/Kardon	0906
JVC	0345
Luxman	0179
Marantz	0335, 0906
Nakamichi	0335
Optimus	0409

Philips	0906
Polk Audio	0906
Realistic	0409
Sansui	0335
Sony	0703
Soundesign	0092
Victor	0345
Wards	0092
Yamaha	0368

CBL Codes for the Remote

The default code for your CBL mode key is **0458**.

Brand	Code
General Instrument	0290, 0490, 0824
Jerrold	0290, 0490, 0824
Motorola	1120
Panasonic	0121
Pioneer	0547, 0891, 1891
Scientific-Atlanta	0458, 0491, 0891, 1891

Setting Up Advanced Features for the Remote

This section lists advanced features that you may or may not choose to set up. None of these features are required. If you

just want to watch TV, go to **Using the Explorer 3170HD Set-Top**, later in this guide.

Setting Up Volume Control

You can program your Volume and Mute keys to function in one of two ways:

- To control the volume on a single device all the time
- To control the volume on each device, depending on the mode key that you press

Note: The default setting is to control volume through your TV all the time.

Follow these steps to change the way your Volume and Mute keys function.

1. Turn on the appropriate device.
2. Press **SETTINGS** to access the General Settings on-screen menu, and verify that the Audio: Volume Control setting is set to "Variable."

3. Press **SELECT** and the appropriate mode key (AUX, VCR, TV, or CBL) at the same time until the light blinks twice.
4. Using the keypad on the remote, press **9 9 3**. The light blinks twice.
5. Do you want the Volume and Mute keys to operate a single device all the time?
 - If **yes**, press the mode key for the device that you want to control the volume.
 - If **no**, press **VOL** - to control the volume through various devices based on the mode key.
6. Point the remote *toward* the device and confirm that Volume and Mute function as expected.

Reassigning Mode Keys

You can program the TV, VCR, and AUX mode keys on your remote to control other devices. For example, you can program the AUX mode key to control a second VCR device, such as a DVD player.

1. Turn on the device.
2. Press **SELECT** and **CBL** at the same time until the light blinks twice.
3. Using the remote control keypad, press **9 9 2**. The mode keys blink twice.

4. Press the mode key that identifies the kind of the device you want to control, and then press the mode key that you want to change. For example, to program the AUX key to operate a television, press VCR and then AUX.

If you want to reassign a key to its original mode, you must repeat this procedure. Instead of pressing two keys in step 4, press the key that you want to reassign twice:

- to identify the kind of device you want to control
- to identify the mode key that you want to change

Setting Up Channel Control

By default, the channel keys on your remote (CH+, CH-, digits 0-9 and Last) allow you to change channels on the set-top, the TV, or a VCR, depending on the current mode. You can disable or enable channel control for the TV or VCR mode. Also, if you have reassigned your AUX key to control a second TV or VCR, you can disable or enable channel control for that device as well. See **Reassigning Mode Keys** earlier in this section for more information.

If you disable the channel control for a TV or VCR, then the channel keys in that mode will control channels on the set-top.

To disable channel controls in a mode (so that the channel keys always control the set-top):

1. Press one of the following key combinations until the light blinks twice:
 - To disable channel controls for a TV, press **SELECT** and **TV** at the same time.
 - To disable channel controls for a VCR, press **SELECT** and **VCR** at the same time.
 - To disable channel controls for both the TV and the VCR, press **SELECT** and **CBL** at the same time.
 - To disable channel controls for a TV or a VCR that is assigned to the AUX mode key, press **SELECT** and **AUX** at the same time.
2. Using the keypad on the remote, press **9 9 7**.
3. Press **CH -**. The light blinks twice to confirm the change.

To enable channel controls in a mode (so that the channel keys in that mode control the appropriate device):

1. Press one of the following key combinations until the light blinks twice:
 - To enable channel controls for a TV, press **SELECT** and **TV** at the same time.
 - To enable channel controls for a VCR, press **SELECT** and **VCR** at the same time.
 - To enable channel controls for both the TV and the VCR, press **SELECT** and **CBL** at the same time.
 - To enable channel controls for a TV or a VCR that is assigned to the AUX mode key, press **SELECT** and **AUX** at the same time.
2. Using the keypad on the remote, press **9 9 7**.
3. Press **CH +**. The light blinks twice to confirm the change.

Setting Up Power Control

By default, the power key on your remote operates the appropriate device for the current mode. You can choose to set up this key to operate multiple devices each time it is pressed, regardless of the current mode.

To change your power control:

1. Press **SELECT** and **CBL** at the same time until the light blinks twice.
2. Using the keypad on the remote, press **9 9 8**.
3. Press one of the following keys to choose the way the Power key should operate:
 - Press **TV** to turn on the set-top and then the TV.
 - Press **VCR** to turn on the set-top, followed by the TV and the VCR.
 - Press **AUX** to turn on the set-top, followed by the TV and the auxiliary device.
 - Press **CBL** to turn on the set-top, followed by the TV, the VCR, and the auxiliary device.
 - Press **POWER** to control all devices individually. This is the default setting.

The light blinks twice to indicate that the change was accepted.

If your remote is set to control power on more than one device, the remote always defaults to CBL mode after you turn the devices on or off. Also, if you press Power within three seconds of pressing any mode key (VCR, TV, AUX, or CBL), the power key only affects the associated device. For example, if you press the VCR key and then press the Power key within three seconds, the remote control only turns on the VCR, regardless of the power control setting.

Note: Your cable service provider will send nightly programming updates to your set-top (such as program guide information). You should leave your set-top on at all times so that it can receive these updates.

Putting It Back the Way I Got It

To reset all of the advanced features to the default settings, except the codes you have programmed (TV, VCR, AUX, and CBL) and any mode keys that you may have reassigned, follow these steps.

1. Press **SELECT** and **CBL** at the same time until the light blinks twice.
2. Using the keypad, press **9 8 0**. The light blinks four times.

That's it! All of the advanced features have been reset to their factory defaults.

Using the Explorer 3170HD Set-Top

After you set up your Explorer 3170HD Set-Top, and the front panel displays the current time, you can turn on the set-top and begin watching TV. Press the **POWER** button on the front of the set-top to turn it on.

Your cable service provider will send nightly programming updates to your set-top (such as program guide information). You should leave your set-top on at all times so that it can receive these updates.

Using the Mode Keys

Your remote can operate your set-top and your HDTV, plus two other devices that you have set up with your remote. The mode keys across the top of your remote let you specify the device you want to control:

- **AUX** controls a CD player, receiver, amplifier, or other audio devices.
- **VCR** controls a VCR or DVD player.
- **TV** controls a television.
- **CBL** controls your set-top.

If you prefer, you can set up some of these mode keys to operate other devices. For example, you can set up your **AUX** key to operate a second VCR. See **Setting Up Advanced Features for the Remote** earlier in this guide.

Note: Some of the remote keys may be disabled in various modes. For example, **Play**, **Fast Forward**, and **Rewind** do not function in TV mode.

Watching TV

The following keys provide basic control for your set-top and remote:

- To turn your set-top on, press **TV** and then **POWER** on the remote control.
- To change the channel, use **CH+** and **CH-** on the remote control.
- To adjust the volume, use **VOL+** and **VOL-** on the remote control.
- To view more information about the current program, press **INFO**.

Using the IPG

Your set-top may provide an Interactive Program Guide (IPG) which organizes programs and events into listings by channel, theme, or title. Your cable service provider should offer a user's guide for this service, if it is available in your area.

The current channel continues to display in the upper right corner of the IPG. The upper left corner displays information about the highlighted program.

- To view or hide the IPG, press **Guide**.
- To view information about a program, use the arrow keys on the remote (▲ ▼ ◀ ▶) to highlight the program.
- To view more detailed information about the highlighted program, press **INFO**.

- To view the highlighted program, press **SELECT**. If you select a program that is scheduled to occur in the future, the set-top sets a timer to record the program automatically. (You must have the IR Blaster installed to use this option. See **Attaching the IR Blaster Cable Connector**, later in this guide.)
- The **A** **B** **C** keys provide additional functions that vary, based on the current IPG screen. For example, in many screens you can use the **A** key to change the sort order of programs in the guide. The IPG screen shows the functions that are assigned to each of these keys.

Changing Your Set-Top Settings

The Explorer 3170HD Set-Top offers two menus of settings that you can use to configure your set-top features, based on your preferences:

The Quick Settings menu gives you quick access to some of the more commonly used settings such as parental control, favorite channel lists, and sleep timers.

The General Settings menu gives you access to all of the quick settings plus more advanced settings, such as on-screen languages and Personal Identification Numbers (PINs).

- Press **SETTINGS** once to view the Quick Settings menu. Press **SETTINGS** again to view the General settings menu. Press **SETTINGS** a third time to hide both settings menus.
- Use the arrow keys to scroll through the settings options.
- Press **SELECT** to change the highlighted setting.
- Press **INFO** to learn more about the highlighted setting.

Setting Up the VCR Commander Service

Your cable service provider may offer a VCR Commander™ Service. This service gives you a quick and easy way to record the program you are currently watching or any program in the future.

Your set-top includes a device called an IR Blaster, which enables your set-top to control your VCR.

To use the VCR Commander service:

- Your cable service provider must offer the service.
- You must attach the IR Blaster (included) to your set-top, and set up your set-top to recognize your VCR.

This section explains how to set up and use the VCR Commander service.

Attaching the IR Blaster Cable Connector

 **WARNING:**
Electric shock hazard! Unplug all electronic devices before connecting or disconnecting any device cables.

To attach the IR Blaster cable to your set-top, follow these steps:

1. Make sure that the set-top is not connected to the AC power outlet.

2. Locate the port labeled **IR** on the back of the set-top.
3. Plug the cable connector into the IR port.
4. Reconnect the set-top to the AC power outlet.

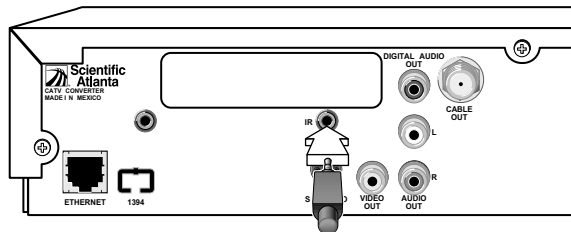

T8941

Attaching the IR Blaster to Your VCR

1. Refer to your VCR user's guide to locate the IR sensor window. (The IR sensor is where the VCR receives the remote control signal.)
2. Remove the covering on the adhesive strip from the loop tape, which is attached to the hook fastener on the IR Blaster.

Notes:

- Attaching the IR Blaster to the VCR may be easier if the loop tape remains attached to the hook fasteners.
- After attaching the IR Blaster to the VCR, the hook and loop fastener allows you to easily remove the IR Blaster for cleaning or to move the VCR.

3. Mount the IR Blaster within 3 inches of the IR sensor on your VCR by pressing the IR Blaster against your VCR to secure it.

Notes:

- Locations A, B, C, and D are the typical places where the IR Blaster can be attached (within 3 inches of the IR sensor on your VCR).
- Do not block the tape insert door on your VCR.

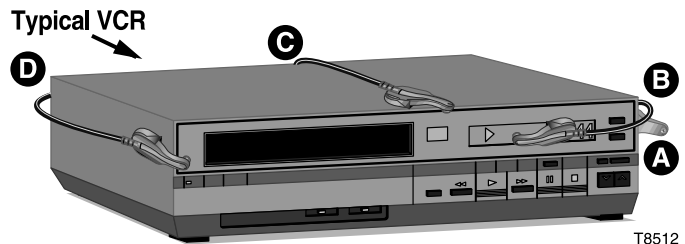

T8512

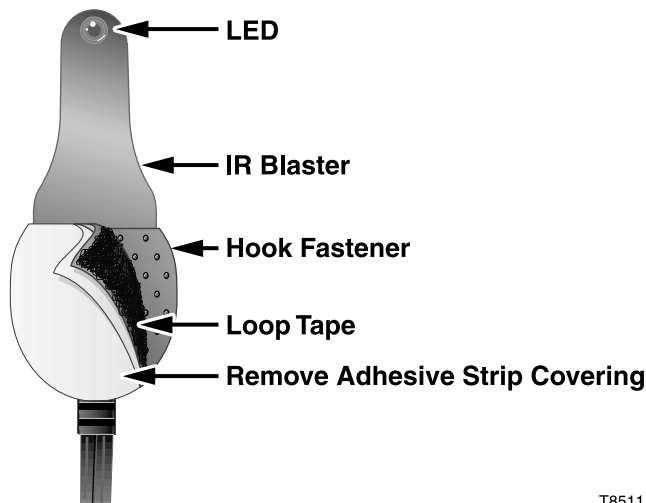

T8511

Setting Up VCR Commander Service

After you connect the IR Blaster, you must program the code for your brand of VCR into the memory of the VCR Commander. Before you begin, make sure that the VCR is turned off.

Note: At any time during this procedure, you can press **C** or **EXIT** to manually record a program on your VCR.

1. Turn on the power to your set-top.
2. Press **SETTINGS** twice to display the General Settings menu.
3. Press **▲** or **▼** to scroll to the **Set: VCR Commander** preference; then, press **SELECT**.

Note: If the menu does not display the VCR Commander option, contact your cable service provider to see if this service is available in your area.

4. Press **▲** or **▼** to scroll to **Setup**, and then press **SELECT**.
5. Scroll to **VCR Input**, and then press **SELECT**.
6. Your VCR is connected to your DHCT by one of the following cable types. Locate your cable type in this step and follow the instructions:

- For RF/coaxial cable, choose **Channel 3/4**, and then press **SELECT**.



- For RCA jacks, choose **Audio-Video**, and then press **SELECT**.



- For S-Video (SVHS), choose **S-Video**, and



then press **SELECT**.

7. Press **SELECT** again to display the **Status** menu.
8. Press **▲** or **▼** to scroll to **Setup** and press **SELECT**.
9. Press **▲** or **▼** to scroll to **VCR Code**, and then press **SELECT** to display the VCR Commander Instructions screen.
10. Turn to **VCR Commander Service Codes** on page 33 of this guide to find the code choice(s) for your brand of VCR that you will use in step 11.
11. Enter the code for your brand of VCR, and then press **SELECT**.

Notes:

- If more than one code is available for your brand of VCR, use the first code listed.
 - If you enter an incorrect number, press **A**, and then reenter the code.
12. Wait for the test process to complete and the power to your VCR to turn on.
 13. Did the power to your VCR turn on?
 - If **yes**, press **A**.
 - If **no**, choose one of the following options:
 - If there are additional code choices for your brand of VCR; press **B** and repeat steps 9 through 12 using the next code in your list of choices.
 - If there are no additional code choices for your brand of VCR, go to **Searching for Your VCR Code** on page 32 of this guide.

Searching for Your VCR Code

If none of the codes listed for your brand of VCR turn on the power to the VCR and start the recording, then follow these steps to scan the entire VCR code library. The scan locates the code that will turn on the power to your VCR and start the recording:

1. Enter code **0000**, and then press **SELECT**.

Note: The system scans the entire VCR code library. This process can take several minutes.

2. Wait for the test process to complete.
3. Press **SELECT** slowly and repeatedly, and wait for the VCR power to turn on.
Note: If the power to the VCR does not turn on, call your cable service provider for help.
4. If the power to your VCR turns on, press **A** and then go to **Setting Up a VCR Recording Test** to test the code you selected.

Setting Up a VCR Recording Test

Before setting your VCR to record a program, complete these steps to verify that the code you selected operates the recording function of your VCR.

1. Insert a blank tape into your VCR and turn the VCR off.
2. Press **SELECT** to begin a recording test.
3. Wait for the recording process to begin.
4. Did the VCR begin recording?
 - If **yes**, the VCR Commander Service setup is complete. Press **SELECT** to return to the General Settings menu, or press **EXIT** to return to watching TV, or go to **Scheduling a VCR Recording** to select a program to record.

- If **no**, press **A** and choose one of the following options:
 - If the code list (starting on page 33) contains additional code choices for your brand of VCR, enter the next code in your list of choices and press **SELECT**. Then, go to step 5.
 - If the code list does not contain additional code choices for your brand of VCR, return to **Searching for Your VCR Code**.
5. Wait for the test process to complete and the power to your VCR to turn on.
 6. Did the power to your VCR turn on?
 - If **yes**, press **A**, and return to **Scheduling a VCR Recording**, later in this guide.
 - If **no**, contact your cable service provider for help.

VCR Commander Service Codes

Find the code for your brand of VCR and use this code in the **Setting Up the VCR Commander Service** section. Start with the first code in the list and continue through the choices. The most common codes are listed first.

VCR Brand Name	Code
Action	0331
Admiral	0062, 0562
Advantz	0370
Adventura	0014
Aiko	0292, 0792
Aiwa	0014, 0051, 0420, 0450, 0482, 0551, 0651, 0751, 0851
Akai	0067, 0055, 0063, 0075, 0120, 0170, 0256, 0555, 0655, 0755
American High	0049
Asha	0254, 0754, 0854
Audiovox	0051, 0551, 0651, 0751, 0851
Beaumarck	0254, 0754, 0854
Bell & Howell	0118, 0618, 0718
Broksonic	0016, 0135, 0198, 0223, 0225, 009, 0375, 0493, 0516, 0635, 0698, 0723, 0893
CCE	0086, 0292, 0586, 0792
Calix	0051, 0551, 0651, 0751, 0851
Canon	0049, 0116, 0181
Capehart	0034, 0534
Carver	0095, 0160
Cineral	0292, 0792
Citizen	0051, 0292, 0551, 0651, 0751, 0792, 0851
Colt	0086, 0586
Craig	0051, 0061, 0086, 0254, 0285, 0551, 0561, 0586, 0651, 0751, 0754, 0851, 0854
Curtis Mathes	0049, 0055, 0069, 0074, 0176, 0555, 0655, 0755
Cybernex	0065, 0254, 0754, 0854
Daewoo	0034, 0031, 0059, 0101, 0292, 0534, 0559, 0792

Daytron	0034, 0534
Denon	0056, 0058, 0556, 0558
Dynatech	0014
Electrohome	0051, 0551, 0651, 0751, 0851
Electroponic	0051, 0551, 0651, 0751, 0851
Emerex	0046, 0546
Emerson	0014, 0016, 0050, 0051, 0057, 0075, 0082, 0102, 0135, 0198, 0222, 0223, 0225, 0226, 0292, 0308, 0309, 0375, 0493, 0516, 0524, 0551, 0557, 0635, 0651, 0657, 0698, 0723, 0751, 0792, 0824, 0851, 0893
Fisher	0061, 0068, 0080, 0118, 0561, 0618, 0718
Fuji	0047, 0049, 0547
Funai	0014
GE	0062, 0049, 0069, 0074, 0079, 0216, 0254, 0562, 0754, 0854
Garrard	0014
Go Video	0246, 0293, 0364, 0446, 0540
GoldStar	0032, 0051, 0052, 0494, 0551, 0651, 0751, 0851, 0894
Gradiente	0014, 0022, 0422, 0522
Grundig	0209
HI-Q	0061, 0561
Harley Davidson	0014
Harman/Kardon	0052, 0089
Harwood	0082, 0086, 0586
Headquarter	0060, 0560
Hitachi	0014, 0055, 0056, 0058, 0079, 0096, 0119, 0180, 0249, 0306, 0555, 0556, 0558, 0596, 0655, 0755
JVC	0081, 0083, 0022, 0055, 0220, 0221, 0398, 0522, 0555, 0581, 0583, 0655, 0720, 0721, 0755, 0898

Jensen	0055, 0555, 0655, 0755	Nikko	0051, 0551, 0651, 0751, 0851
K E C	0051, 0292, 0551, 0651, 0751, 0792, 0851	Nikon	0048, 0267, 0548
KLH	0086, 0586	Noblex	0254, 0754, 0854
Kenwood	0081, 0083, 0052, 0055, 0398, 0555, 0581, 0583, 0655, 0755, 0898	Olympus	0240, 0049
Kodak	0049, 0051, 0551, 0651, 0751, 0851	Optimus	0072, 0062, 0051, 0118, 0176, 0446, 0551, 0562, 0618, 0651, 0718, 0751, 0851
LXI	0051, 0551, 0651, 0751, 0851	Optonica	0076
Lloyd's	0014, 0222	Orion	0016, 0198, 0309, 0493, 0516, 0698, 0893
Logik	0086, 0586	Panasonic	0240, 0049, 0091, 0116, 0176, 0239, 0241, 0260, 0392
MEI	0049	Penney	0049, 0051, 0052, 0054, 0056, 0058, 0068, 0254, 0551, 0556, 0558, 0651, 0751, 0754, 0851, 0854
MGA	0057, 0075, 0254, 0557, 0657, 0754, 0854	Pentax	0056, 0058, 0079, 0119, 0556, 0558
MGN Technology	0254, 0754, 0854	Philco	0049, 0223, 0493, 0723, 0893
MTC	0014, 0254, 0754, 0854	Philips	0049, 0076, 0095, 0417
Magnasonic	0292, 0792	Pilot	0051, 0551, 0651, 0751, 0851
Magnavox	0014, 0049, 0053, 0095, 0117, 0163, 0553	Pioneer	0081, 0072, 0083, 0176, 0182, 0581, 0583
Magnin	0254, 0754, 0854	Portland	0034, 0534
Marantz	0049, 0095, 0160, 0175	Profitronic	0254, 0754, 0854
Marta	0051, 0551, 0651, 0751, 0851	Proscan	0069, 0074, 0216
Matsushita	0049, 0176	Protec	0086, 0586
Memorex	0060, 0062, 0014, 0049, 0051, 0053, 0061, 0118, 0176, 0254, 0282, 0313, 0551, 0553, 0560, 0561, 0562, 0618, 0651, 0718, 0751, 0754, 0851, 0854	Pulsar	0053, 0065, 0553
Minolta	0056, 0119, 0058, 0556, 0558	Quarter	0060, 0560
Mitsubishi	0081, 0083, 0062, 0057, 0075, 0089, 0187, 0228, 0256, 0457, 0557, 0562, 0581, 0583, 0657, 0687	Quartz	0060, 0169, 0560, 0669
Motorola	0062, 0049, 0562	Quasar	0049, 0091, 0176
Multitech	0014, 0086, 0586	RCA	0062, 0049, 0056, 0058, 0069, 0074, 0079, 0091, 0119, 0120, 0163, 0216, 0254, 0291, 0467, 0556, 0558, 0562, 0754, 0854
NAD	0072	Radio Shack	0014, 0051, 0551, 0651, 0751, 0851
NEC	0081, 0083, 0052, 0054, 0055, 0064, 0096, 0118, 0471, 0555, 0581, 0583, 0596, 0618, 0655, 0718, 0755	Radix	0051, 0551, 0651, 0751, 0851
		Randex	0051, 0551, 0651, 0751, 0851

Realistic	0060, 0062, 0014, 0049, 0051, 0061, 0076, 0080, 0118, 0551, 0560, 0561, 0562, 0618, 0651, 0718, 0751, 0851
Ricoh	0048, 0267, 0548
Runco	0053, 0553
STS	0056, 0058, 0556, 0558
Salora	0089
Samsung	0067, 0059, 0065, 0254, 0559, 0754, 0854
Sanky	0062, 0053, 0553, 0562
Sansui	0081, 0083, 0014, 0055, 0096, 0285, 0493, 0555, 0581, 0583, 0596, 0655, 0755, 0893
Sanyo	0060, 0061, 0118, 0254, 0282, 0386, 0560, 0561, 0618, 0718, 0754, 0854
Scott	0057, 0059, 0135, 0198, 0224, 0225, 0226, 0559, 0635, 0698
Sears	0060, 0014, 0049, 0051, 0056, 0058, 0061, 0068, 0071, 0080, 0118, 0119, 0551, 0556, 0557, 0558, 0560, 0561, 0618, 0651, 0657, 0718, 0751, 0851
Semp	0059, 0559
Sharp	0062, 0076, 0562
Shintom	0086, 0586
Shogun	0065, 0254, 0754, 0854
Singer	0086, 0586
Sony	0048, 0047, 0014, 0025, 0036, 0046, 0049, 0267, 0289, 0546, 0547, 0548
Sunpak	0267
Sylvania	0014, 0049, 0057, 0095, 0117, 0557, 0657
Symphonic	0014
TMK	0050, 0222, 0254, 0754, 0854
Tatung	0055, 0555, 0655, 0755
Teac	0014, 0055, 0555, 0655, 0755
Technics	0049, 0176, 0260

Teknika	0014, 0049, 0051, 0066, 0551, 0651, 0751, 0851
Thomas	0014
Toshiba	0057, 0059, 0071, 0080, 0224, 0226, 0380, 0557, 0559, 0657
Totevision	0051, 0254, 0551, 0651, 0751, 0754, 0851, 0854
Unitech	0254, 0754, 0854
Vector	0059, 0559
Vector Research	0052, 0054
Video Concepts	0054, 0059, 0075, 0235, 0559
Videosonic	0254, 0754, 0854
Wards	0062, 0014, 0049, 0056, 0058, 0061, 0069, 0074, 0076, 0086, 0095, 0163, 0175, 0226, 0254, 0556, 0558, 0561, 0562, 0586, 0754, 0854
White Westinghouse	0292, 0792
XR-1000	0014, 0049, 0086, 0586
Yamaha	0052
Zenith	0048, 0047, 0014, 0053, 0547, 0548, 0553

Scheduling a VCR Recording

If you are using the VCR Commander Service, your set-top can help you schedule programs that you want to record. VCR Commander automatically starts and stops at the correct time to record programs you

select. You can record the program you are currently watching, or you can schedule to record a future program from the IPG or by setting a timer.

Recording the Current Program

You can record the program you are currently watching using your remote control.

1. Verify that the power to your set-top is turned on.
2. Press **SETTINGS** once while viewing a full-screen TV program.
3. Press **▲** or **▼** to scroll to the **Start Recording...Now** option.
4. Press **SELECT** to set up the recording process. A screen appears with instructions for selecting the Input option of your VCR.

5. Put a blank tape in your VCR.
6. Turn off the power to your VCR.
7. Press **SELECT** to start recording the program. The set-top displays **rEc**, which indicates that recording is in process.

Note: Most of the keys on the remote control will not function while recording is in process. This ensures that the recording will not be interrupted accidentally, even if you turn off the power to the set-top.

8. Press **EXIT** to stop recording.

Recording Future Programs Using the IPG

You can program your VCR to record future TV programs, directly from the IPG. You can select up to eight programs to record.

1. Turn on the power to your set-top and TV.
2. Press **GUIDE**. The IPG appears.
3. Press the arrow keys to locate and highlight the future program you want to record, and then press **SELECT**.
4. Press **▲** or **▼** to scroll to **Set a VCR Timer for...**, and then press **SELECT** to set the timer. The programs that you have selected to record now appear in red, and the red REC icon indicates that a VCR timer is set.

5. Press **EXIT** to return to the TV program.
6. Put a blank tape in your VCR.
7. Turn off the power to the VCR.

Note: When you set a timer from the IPG, you are setting a one-time only timer for that program. See **Using the VCR Timer** for information about setting 7-day, weekday only, weekend only, or single-day timers.

The volume on the set-top will automatically adjust to the maximum level when the recording begins.

Using the VCR Timer

The VCR Timer sets your VCR Commander Service to record programs at specific days and times. Use your remote control to set the channel, day, start time, and stop time of the programs you want to record. You can set up to eight timers, including the timers set from the IPG.

Important: Do not overlap program times when setting up the VCR timer. A program that you set to record will not begin recording until the previous VCR timer event has stopped.

1. Turn on the power to your set-top.
2. Press **SETTINGS** twice while viewing a full-screen TV program.
3. Press **▲** or **▼** to scroll to the **Timer: VCR New** option, and then press **SELECT**.
4. Follow the on-screen instructions to set the recording time. Refer to the user's guide that was provided by your cable service provider for detailed instructions to set the VCR Timer. Contact your cable service provider if you do not have a copy of this guide.
5. Press **▲** to accept the timer settings.
6. Put a blank tape in your VCR, and then set the Input option you selected on your VCR.
7. Turn off the VCR.
8. Press **SELECT** to set the timer, and then press **EXIT** to return to the TV program.

Cancelling a Future Recording

You can clear (or delete) a scheduled VCR Timer program from the VCR Timer.

1. Turn on the power to your set-top.
2. Press **SETTINGS** twice while viewing a full-screen TV program.
3. Press **▲** or **▼** to scroll to the **Timer: VCR ...** preference number for the VCR Timer program you want to clear, and then press **SELECT**.
4. Press **ⓐ** to clear (cancel) the timer, and then press **EXIT** to return to the TV program.

Note: The program name appears in the current CHAN column.

Troubleshooting

If your set-top, remote, or IR Blaster do not function as expected, read the following conditions and suggestions. If the situation persists, contact your cable service provider.

If you believe that your equipment needs repair or replacement, call Scientific-Atlanta at 1-866-212-2141.

Questions about Your Set-Top

If your set-top does not perform as expected, check the following conditions:

- Verify that the power to your TV is turned on.
- If plugged into a wall switch, verify the switch is in the ON position.
- Verify that all cables are properly connected.
- Verify that your TV is connected to the proper TV input port.

If your set-top does not perform as expected after checking the power, the cables, and the output channel, check the following conditions:

No picture

- If your system includes a VCR or stereo, verify that you have properly connected them to the set-top.
- Verify that the set-top Power light is on and the Bypass light is off.

No color

- Verify that the current TV program is broadcast in color.
- Adjust the TV color controls.

No sound

- If your setup includes a VCR or stereo, verify that you have properly connected them to the set-top.
- Verify that the volume is turned up.
- Verify that the Bypass feature is disabled.

The TV screen displays a message indicating that the set-top is automatically updating its software.

Wait for the time to display on the front panel of your set-top before continuing with the installation process. When the front panel displays the time, the update is complete.

Questions about Your Remote Control

The light flashes twice whenever you press a key.

The batteries are weak and should be replaced. Use two AA alkaline batteries.

The remote control keys do not function as expected.

Make sure that you press the appropriate mode key for the device you want to control.

Questions about Your VCR Commander Service

The VCR Commander Service does not turn on the power to the VCR for the scheduled recording or did not begin recording.

- Make sure that there is a blank tape in the VCR.
- Turn off the power to the VCR.
- Make sure that the IR Blaster is in front of or within 3 inches of the sensor window on the VCR.
- Make sure that the VCR timer is properly set. See **Using the VCR Timer** in the **Scheduling a VCR Recording** section of this guide.
- Try another VCR code for your VCR brand, or enter 0000. See the instructions in the **Setting Up VCR Commander Service** section of this guide.

The VCR Commander Menu option does not appear on the screen.

Your set-top is not authorized for VCR Commander Service, or your cable service provider does not offer VCR Commander Service. Call your cable service provider.

After entering your VCR code, the VCR will not turn on.

Try another VCR code for your brand, or enter **0000**. See the instructions in the **Setting Up the VCR Commander Service** section of this guide.

You recorded an on-screen message (blocked barker), which states that the channel was not authorized.

The channel, time, or rating was blocked after the program was set. Verify that Parental Control is turned off before setting this recording.

LIMITED WARRANTY

Explorer ® 3170HD Set-top (for the United States)

Scientific-Atlanta®, Inc.'s ("S-A's") Explorer 3170HD set-top enables you to access cable television programming (including programs in high definition formatting) from your cable operator. Should you experience problems, always consult with your local cable company first to determine whether the problem is related to the cable network or your Explorer 3170HD set-top.

What does your warranty cover?

- Any defect in materials or workmanship that arises during the duration of this warranty.
- This limited warranty applies only to the S-A Explorer 3170HD set-top, remote control, and included cabling and accessories.
- This limited warranty extends to the original consumer purchaser, or any person receiving this product as a gift from the original consumer purchaser, and to no other purchaser or transferee.
- This limited warranty applies only to products purchased from an S-A authorized retailer and operated within the U.S.A.

What is the duration of your warranty?

- 12 months from purchase date, for labor and parts.
- All warranty claims must be made during the 12 month warranty period.

What will we do?

- S-A will, at its option, either repair or replace, within a reasonable time, a defective set-top. S-A may choose to replace a defective set-top at S-A's option with either a new or reconditioned set-top. A repaired or replacement set-top will be at least equivalent in performance to the original set-top. Any repaired or replacement set-top is warranted under the same terms as this Limited Warranty for a period of 90 days after the date of replacement, or for the remainder of the initial warranty period, whichever is longer.

How do you obtain warranty service?

1. First, call your cable operator to verify the problem exists with your set-top and not with your cable operator's network or your in-home wiring. Most service related problems are due to network related issues and not the set-top.
2. Once your cable operator has verified that a problem exists with the set-top, call Scientific-Atlanta at the phone number listed below to get a Return Material Authorization (RMA) number.
3. You will be asked to provide the following information:
 - a. Your name, address, and phone number.
 - b. Your set-top model and serial number. Your warranty is void if the model and/or serial number tag is missing, altered, defaced, or otherwise rendered illegible.
 - c. Your set-top purchase date. You will be required to include a copy of a valid proof of purchase from an S-A authorized retailer with your returned set-top.
 - d. A brief description of the problem.
 - e. If you want an immediate replacement set-top, then provide a Discover, MasterCard or Visa credit card number and expiration date. Your credit card will not be charged unless certain conditions are met as described below.
4. If you provided a credit card number, S-A will ship a replacement set-top to you, less cabling, power cord, remote, and accessories as an "advance exchange." Return shipping instructions will be included in your replacement set-top carton along with your RMA number. If you choose to ship the set-top back to S-A in other packaging, you will be required to pay both shipping costs as well as insurance charges. S-A will not be liable for set-tops lost, stolen, or damaged in shipment to S-A when packaged in alternative packaging.
5. If you did not provide a credit card number, S-A will repair or replace your set-top within a reasonable time period after you return it to S-A. You will be responsible for providing all return documentation described below as well as paying for both shipping and insurance charges. Do not include your cabling, power cord, remote, or accessories with your returned set-top. S-A will not be liable for set-tops lost, stolen, or damaged in shipment to S-A.
6. You will need to include the following documentation with your returned set-top shipment to S-A:
 - a. Your name, address and phone number.
 - b. Proof of purchase from an S-A authorized retailer, such as a copy of a receipt.
 - c. A brief description of the problem.
7. For advance exchanges:
 - a. If you return your defective set-top to S-A along with all of the required documentation within 14 days from the date you receive your replacement set-top, only items not covered under your warranty will be charged to your credit card.
 - b. If your set-top is not received by S-A within 14 days, the full retail value of the set-top will be charged to your credit card. If the unit is subsequently received within 30 days, charged amounts will be credited, less a \$10 handling fee.
 - c. If S-A receives the set-top without valid proof of purchase from an S-A authorized retailer, S-A will charge the credit card for required set-top repairs. Charged amounts will be credited, less a \$10 handling fee, if the required documentation is subsequently received within 30 days.

What is not covered by your warranty?

- Costs associated with diagnosing the problem. S-A will not pay cable operator or other service-related expenses or reimburse the customer for expenses pertaining to the diagnosis of the set-top or network related problems.
- Customer instruction. (Your User's Guide clearly describes how to install, adjust, and operate your set-top.)
- Signal reception problems not caused by your set-top.
- Improper installation, maintenance or handling, storage, transportation, testing, repair or related adjustments. (Do not open the cover of this set-top. If you open the cover, your warranty will be void.)
- Damage from misuse or neglect.
- A set-top with a trade name or logo other than S-A's.
- A set-top that has been modified or incorporated into other products.
- A set-top that has been used for institutional, rental, or other commercial purposes.
- A set-top purchased, serviced, or operated outside the U.S.A.
- Cosmetic problems or defects resulting from normal wear and tear under ordinary use, which do not affect the performance or use of the set-top.
- Acts of God, such as, but not limited to, lightning damage.
- Damage caused by external electrical fault or electrical surges.
- Damage to or loss of any programs or data, or the costs of recovering such programs or data.
- Repairs that do not involve defective materials or workmanship are not covered by this warranty.
- Costs for the removal, installation, and/or re-installation of any equipment on a customer's premise.
- Accessories not originally included with the Explorer 3170HD set-top.
- Units or parts which have been lost or discarded by you.
- Batteries for remote control units.
- Loss of programming.
- A set-top that does not work with your local cable operator's network
- Any other cause outside of normal usage parameters.

What additional provisions should I be aware of?

- Because it is impossible for us to know the purposes for which you acquired this set-top or the uses to which you will put this set-top, you assume full responsibility for the selection of the set-top and for its installation and use. While every reasonable effort has been made to ensure that you will receive a set-top that you can use and enjoy, S-A does not warrant that the functions of the set-top will meet your requirements or that the operation of the set-top will be uninterrupted or error-free. S-A is not responsible for problems caused by changes in the operating characteristics of the software you are using, or for problems in the interaction of the set-top with any other software or hardware, including your TV. Your local cable company may download software onto your set-top. S-A does not license or warrant such software to you.

How does state law relate to this warranty?

- This warranty gives you specific legal rights, and you may also have other rights which vary from state to state.

Disclaimer and Limitation of Remedy

- ANY IMPLIED WARRANTIES THAT MAY BE IMPOSED BY LAW ARE LIMITED IN DURATION TO THE DURATION OF THIS LIMITED WARRANTY. NO PERSON, AGENT, DISTRIBUTOR, DEALER OR COMPANY IS AUTHORIZED TO CHANGE, MODIFY OR EXTEND THE TERMS OF THESE WARRANTIES IN ANY MANNER WHATSOEVER. SOME STATES DO NOT ALLOW LIMITATIONS ON HOW LONG AN IMPLIED WARRANTY MAY LAST, SO THE ABOVE LIMITATION MAY NOT APPLY TO YOU.
- IF THE PRODUCT DOES NOT PERFORM AS WARRANTED, YOUR SOLE AND EXCLUSIVE REMEDY SHALL BE REPAIR OR REPLACEMENT. IN NO EVENT SHALL S-A, OR ANY DEALER, DISTRIBUTOR OR AUTHORIZED SERVICE PROVIDER BE LIABLE FOR ANY DAMAGES IN EXCESS OF THE PURCHASE PRICE OF THE SET-TOP. THIS LIMITATION APPLIES TO DAMAGES OF ANY KIND, INCLUDING BUT NOT LIMITED TO DIRECT OR INDIRECT DAMAGES, LOST PROFITS, LOST SAVINGS, LOST DATA, OR OTHER SPECIAL, INCIDENTAL, EXEMPLARY OR CONSEQUENTIAL DAMAGES, WHETHER FOR BREACH OF CONTRACT, TORT OR OTHERWISE, OR WHETHER ARISING OUT OF THE USE OF OR INABILITY TO USE THE PRODUCT, EVEN IF S-A, OR ANY DEALER, DISTRIBUTOR OR AUTHORIZED SERVICE PROVIDER HAS BEEN ADVISED OF THE POSSIBILITY OF SUCH DAMAGES, OR OF ANY CLAIM BY ANY OTHER PARTY. SOME STATES DO NOT ALLOW THE EXCLUSION OR LIMITATION OF INCIDENTAL OR CONSEQUENTIAL DAMAGES, SO THE ABOVE LIMITATION OR EXCLUSION MAY NOT APPLY TO YOU.

THIS WARRANTY IS GOVERNED BY THE LAWS OF THE STATE OF GEORGIA, EXCLUDING ITS CONFLICT OF LAWS RULES.

SCIENTIFIC-ATLANTA, INC.

5030 Sugarloaf Parkway
Lawrenceville, Georgia 30044
USA

Toll-Free Phone number: 1-866-212-2141

United States FCC Compliance

This equipment has been tested and found to comply with the applicable limits of Part 15 of FCC Rules. These limits are designed to provide reasonable protection against harmful interference in a residential installation. This equipment generates, uses, and can radiate radio frequency energy and, if not installed and used in accordance with the instructions, may cause harmful interference to radio or TV reception, which can be determined by turning the equipment off and on. The user is encouraged to try to correct the interference by one or more of the following measures:

- Increase the separation between the equipment and receiver
- Connect the equipment into an outlet on a circuit different from that to which the receiver is connected
- Consult your cable company or an experienced radio/TV technician for help

Any changes or modifications not expressly approved by Scientific-Atlanta could void the user's authority to operate the equipment.

Important: The information shown in the FCC Declaration of Conformity paragraph below is a requirement of the FCC and is intended to supply you with information regarding the FCC approval of this device. *The phone numbers listed are for FCC-related questions only and not intended for questions regarding the connection or operation for this device. Please contact your cable service provider for any questions you may have regarding the operation or installation of this device.*

FCC Declaration of Conformity

This device complies with *Part 15 of FCC Rules*. Operation is subject to the following two conditions: 1) the device may not cause harmful interference, and 2) the device must accept any interference received, including interference that may cause undesired operation.

EXPLORER® Digital Interactive Set-Top model:
Model 3170HD

Manufactured by: Scientific-Atlanta, Inc.;
5030 Sugarloaf Parkway;
Lawrenceville, Georgia 30042; USA
Telephone **770-236-1077**

Canada EMI Regulation

This Class B digital apparatus meets all requirements of the Canadian Interference Causing Equipment Regulations.

Cet appareil numérique de la classe B respecte toutes les exigences du Règlement sur le matériel brouilleur du Canada.

Software and Firmware Use

Scientific-Atlanta, Inc. owns copyrights to the software included in your set-top and furnishes the software to your cable service provider under a license agreement. You may only use or copy this software in accordance with the terms of your cable service provider.

Scientific-Atlanta, Inc. owns copyrights to the firmware in this equipment. You may only use the firmware in the equipment in which it is provided. Any reproduction or distribution of this firmware, or any portion of it, without the express written consent of Scientific-Atlanta, Inc. is prohibited.

Trademarks

Explorer, Scientific-Atlanta, and the Scientific-Atlanta logo are registered trademarks of Scientific-Atlanta, Inc. VCR Commander and "Bringing the Interactive Experience Home" are trademarks of Scientific-Atlanta, Inc.

Index

A

additional audio codes 22
advanced features 24
amplifier codes 23
AUX codes 22

C

cancelling a future recording 37
CBL codes 23
CD codes 22
channel control 25
codes
 additional audio 22
 amplifier 23
 AUX 22
 CBL 23
 CD 22
 DVD 21
 receiver 22
 TV 18
 VCR 20
connecting your set-top 8
connections
 back panel 8

D

DVD codes 21

E

Explorer 3170HD Set-Top
 using 27
Explorer eClub 7

I

IPG 28
 selecting a program to record
 36
IR Blaster
 attaching to the set-top 29
 attaching to the VCR 30
 testing 32

M

MAC address 7
mode keys
 reassigning 24
 using 27

P

power control 26
programming guide 28

R

reassigning mode keys 24
receiver codes 22
recording
 cancelling a recording 37
 scheduling 36
recording the current program
 36
remote
 additional audio codes 22
 amplifier codes 23
 AUX codes 22
 CBL codes 23
 CD codes 22
 channel control 25
 DVD codes 21
 mode keys 27
 power control 26
 reassigning mode keys 24
 receiver codes 22
 setting up 15
 troubleshooting 39
 TV codes 18
 VCR codes 20
 volume control 24

S

serial number 7

T

troubleshooting 38
 remote 39
 VCR Commander Service 39
TV codes 18

V

VCR codes
 for remote control 20
 for VCR Commander Service
 32, 33
VCR Commander Service 39
 cancelling a future recording
 37
 entering your VCR code 31
 record the current program
 36
 recording a program from
 the IPG 36
 scheduling a recording 36
 searching for your VCR code
 32
 setting a timer to record 37
 setting up 31
 testing 32
VCR timer
 setting 37
volume control 24

W

warranty 40
watching TV 27
wiring diagrams 10

Auxiliary VCR TV Cable

Settings

arrows

Next Previous

Mute

Volume

numbers

Rewind Play

Pause, Stop

Power

Guide

Select

Exit

Favorite

Last Information

Channel

A B C

Fast-Forward

Record



Free Manuals Download Website

<http://myh66.com>

<http://usermanuals.us>

<http://www.somanuals.com>

<http://www.4manuals.cc>

<http://www.manual-lib.com>

<http://www.404manual.com>

<http://www.luxmanual.com>

<http://aubethermostatmanual.com>

Golf course search by state

<http://golfingnear.com>

Email search by domain

<http://emailbydomain.com>

Auto manuals search

<http://auto.somanuals.com>

TV manuals search

<http://tv.somanuals.com>