

Register your product and get support at

www.philips.com/welcome

CAM110



User manual

PHILIPS

Contents

1	Important	2
	Safety	2
	Notice	2

2	Your camcorder	4
	Introduction	4
	What's in the box	4
	Functional overview	5

3	Get started	7
	Load the Micro SD card	7
	Turn on	7
	First-time setup	7
	Charge the built-in battery	8

4	Use your camcorder	9
	Record video	9
	Take pictures	9
	Play	9
	Options during video play	10
	Adjust settings	10

5	Use more of your camcorder	12
	View video or pictures on TV	12
	Install and use the camcorder software	12

6	Technical specifications	14
----------	---------------------------------	-----------

7	Frequently asked questions (FAQ)	15
----------	-----------------------------------------	-----------

1 Important

Safety

- ① Read these instructions.
- ② Keep these instructions.
- ③ Heed all warnings.
- ④ Follow all instructions.
- ⑤ Do not use this apparatus near water.
- ⑥ Clean only with dry cloth.
- ⑦ Do not block any ventilation openings. Install in accordance with the manufacturer's instructions.
- ⑧ Do not install near any heat sources such as radiators, heat registers, stoves, or other apparatus (including amplifiers) that produce heat.
- ⑨ Only use attachments/accessories specified by the manufacturer.
- ⑩ Refer all servicing to qualified service personnel. Servicing is required when the apparatus has been damaged in any way, such as power-supply cord or plug is damaged, liquid has been spilled or objects have fallen into the apparatus, the apparatus has been exposed to rain or moisture, does not operate normally, or has been dropped.
- ⑪ Apparatus shall not be exposed to dripping or splashing.
- ⑫ Do not place any sources of danger on the apparatus (e.g. liquid filled objects, lighted candles).

Any changes or modifications made to this device that are not expressly approved by Philips Consumer Lifestyle may void the user's authority to operate the equipment.

Notice

This digital apparatus does not exceed the Class B limits for radio noise emissions from digital apparatus as set out in the Radio Interference Regulations of the Canadian Department of Communications. This Class B digital apparatus complies with Canadian ICES-003.

The set complies with the FCC-Rules, Part 15 and with 21 CFR 1040.10. Operation is subject to the following two conditions:

1. This device may not cause harmful interference, and
2. This device must accept any interference received, including interference that may cause undesired operation.

Disposal of your old product and batteries

Your product is designed and manufactured with high quality materials and components, which can be recycled and reused. Never dispose of your product with other household waste. Please inform yourself about the local rules on the separate collection of electrical and electronic products and batteries. The correct disposal of these products helps prevent potentially negative consequences on the environment and human health. Please visit for additional information on a recycling center in your area.



Caution

- Removal of the built-in battery invalidates the warranty and may destroy the product.

Always bring your product to a professional to remove the built-in battery.

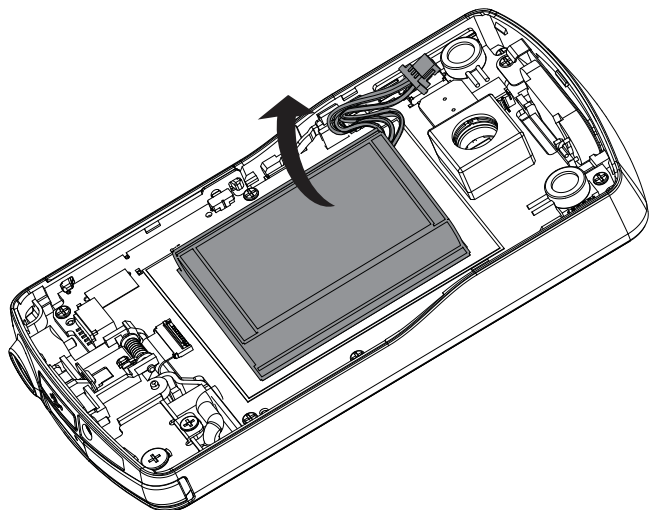

Note

- The safety logo and power rating information are located at the USB arm of the camcorder.

2 Your camcorder

Introduction

With this portable camcorder, you can:

- take full HD (1080P) or VGA movies
- take pictures
- play recorded movies or pictures either directly or on the large screen of a connected TV
- upload the recorded movies or pictures to the Internet directly via your PC/Mac

What's in the box

Make sure that the following items are packed in the box:

- Camcorder
- Quick start guide
- Pouch
- Hand strap

Functional overview

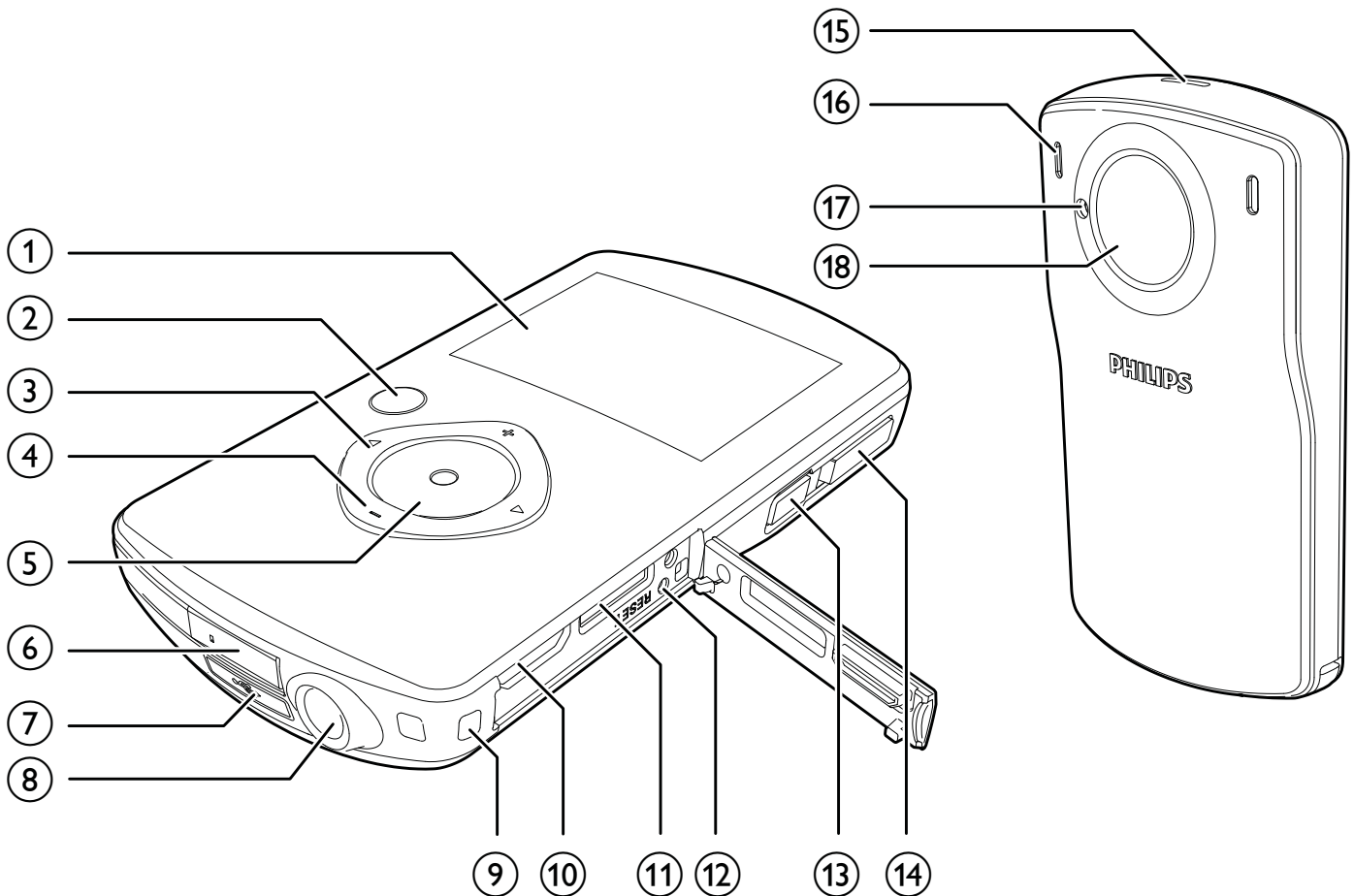

① Display panel



- In viewfinder mode, switch to play mode.
- In play mode, play a selected video clip.
- Confirm settings.



- Navigate left/right in a menu.
- Select a menu option.
- In play mode, turn to the previous/next picture/video clip.
- (◀) In viewfinder mode, switch to the scene selection window.
- (▶) In viewfinder mode, switch to the settings menu.

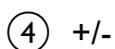

- In viewfinder mode, zoom in/out.
- Navigate up/down in a menu.
- Change a value in the settings menu.

- During video play, change the volume.
- Perform the specific function as shown on the display panel.

⑤ Shutter button

- In viewfinder mode, take a picture or start/stop video recording.
- In play mode, switch to viewfinder mode.

⑥ USB connector

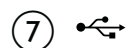

- Eject the USB connector.

⑧ Tripod socket

⑨ Hand strap hole

⑩ HDMI

- Connect to a TV through an HDMI cable with a mini HDMI connector (type C).

- ⑪ **MICRO SD**
 - Connect a Micro SD card.
- ⑫ **RESET**
 - Restore default settings.
- ⑬ **⏻**
 - Turn on/off the camcorder.
- ⑭ **Mode switch button**
 - Switch between picture and video recording modes.
- ⑮ **Built-in speaker**
- ⑯ **Built-in microphones**
- ⑰ **Flashlight**
- ⑱ **Lens**

3 Get started

Load the Micro SD card

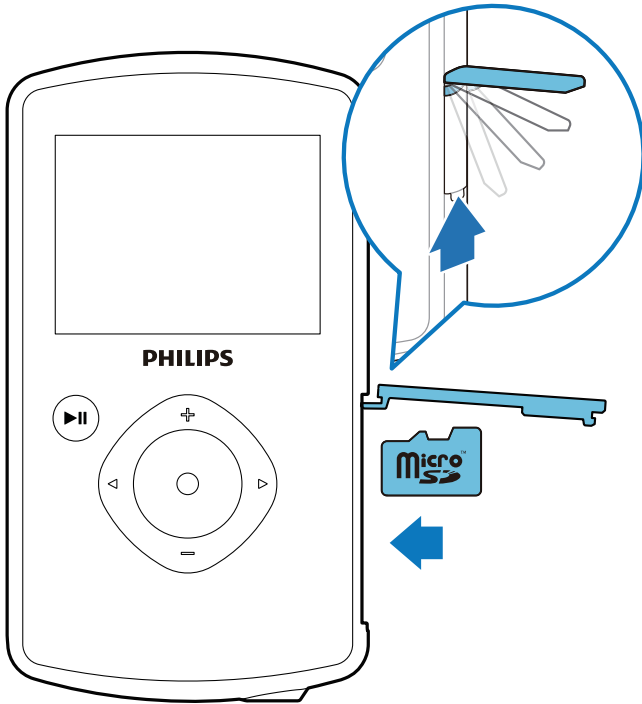

- 1 Flap open the protective cover on the Micro SD card socket.
- 2 Insert a Micro SD card (not supplied) into the socket.
 - Make sure that the the Micro SD card is not write-protected.
 - Make sure that the metal contact of the card faces down.
- 3 Close the protective cover securely.

Turn on

- Press .
 - ↳ For first-time users, a menu for OSD language selection is displayed (See "Get started - Set the OSD language").
 - ↳ The camcorder switches to viewfinder mode.

To turn off the camcorder:

- Press and hold .
 - ↳ The backlight on the display panel turns off.

Tip

- To save energy, the camcorder turns off automatically after being idle for 3 minutes.

First-time setup

When you turn on the camcorder for the first time, a menu for OSD language selection is displayed.

- 1 Press to select a language.
- 2 Press to confirm.
 - ↳ A welcome message is displayed briefly.
 - ↳ An inquiry box for date and time setting is displayed.
- 3 Press to highlight [Yes].
 - ↳ A date setting menu is displayed.
- 4 Press to select the day, month and year fields successively.
- 5 Press to change the value of each field.
- 6 Press to confirm the date setting.
 - ↳ A time setting menu is displayed.
- 7 Press to select the hour and minute fields successively.
- 8 Press to change the value of each field.
- 9 Press to confirm the time setting.
 - ↳ The first-time setup is complete.
 - ↳ The camcorder enters viewfinder mode.

Tip

- See 'Use your camcorder - Adjust settings' for more settings.

Select a special effect

- 1 In viewfinder mode, press ◀ to enter special effect setting.
- 2 Press +/- to select a special effect.
- 3 Press ▶ || to confirm and go back to viewfinder mode.
 - Or press ▶ to cancel and go back to viewfinder mode.

Charge the built-in battery

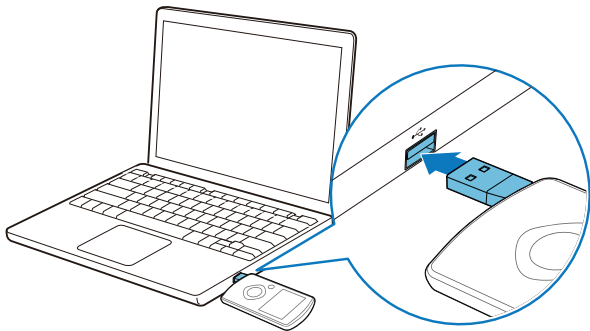

- 1 Press  at the bottom of the camcorder to eject the USB connector.
- 2 Connect the USB connector to a USB socket on a PC.
 - ↳ The status indicator on the shutter button starts flashing in orange.
- 3 Wait until the status indicator stops flashing and turns to green steadily.
 - ↳ The built-in battery is fully charged.

Tip

- The camcorder is fully charged for first-time use.
- It takes about 3 hours to fully charge the built-in battery via the PC.

You can also charge the camcorder via a USB adaptor (not supplied) connected to mains power. The charge time is about 2 hours.

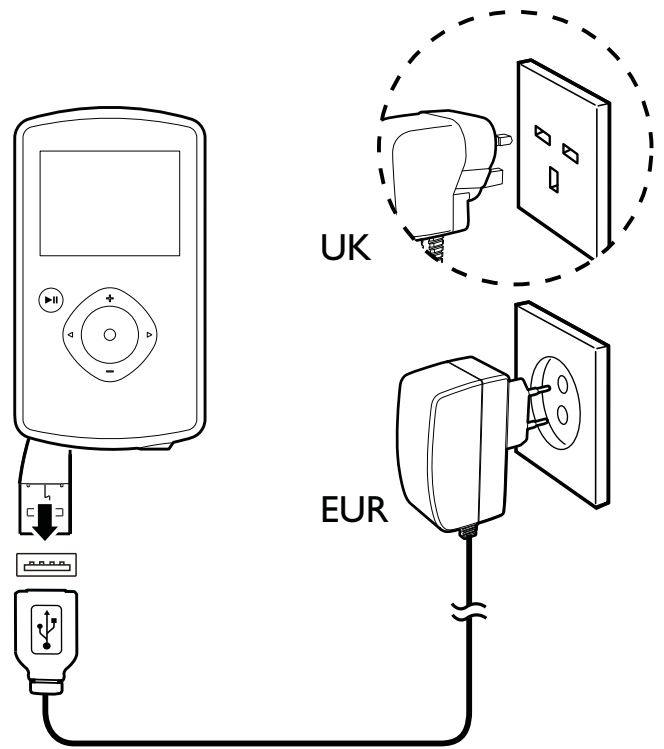

4 Use your camcorder







Record video

- 1 Switch the mode switch button to .
 - ↳ The selected resolution and remaining recording time are displayed on the display panel.
- 2 Hold the camcorder steadily and aim the lens as needed.
- 3 Press the shutter button to start recording.
 - ↳ A red time indicator is displayed on the display panel.
 - ↳ The status indicator on the shutter button starts flashing in red.
- 4 Press the shutter button again to end recording.
 - ↳ **[Recording saved!]** is displayed briefly.





Take pictures

- 1 Switch the mode switch button to .
 - ↳ The file size and remaining number of pictures that can be taken are displayed on the display panel.
- 2 Hold the camcorder steadily and aim the lens as needed.
- 3 Press the shutter button down halfway to adjust the focus.
- 4 Press the shutter button down completely to take a picture.
 - ↳ **[Picture saved!]** is displayed briefly.







Play

- 1 In viewfinder mode, press   to enter play mode.
 - ↳ The last recorded media is played automatically.
- 2 Press  /  to select a picture or video clip for play.
- 3 If the selected file is a video clip, press   to start play.

Delete a file

- 1 In play mode, press  /  to select a file.
- 2 Press **+** to enter the edit window.
- 3 Press **+** again to enter the window for deletion confirmation.
- 4 Press  to highlight **[Yes]** and confirm the deletion operation.
 - ↳ **[Deleted!]** is displayed briefly.
 - To exit the operation, press  to highlight **[No]**.

Zoom in a picture

- 1 In play mode, press  /  to select a picture.
- 2 Press **+** to enter the edit window.
- 3 Press  to zoom in the picture.
- 4 Press **+/-**  /  to pan through the enlarged picture.
 - To return to normal view, press  .

Trim a video clip

Note

- Only video files not recorded with 'Dual recording' can be edited (trimmed) on the camcorder.

- 1 In play mode, press ◀/▶ to select a recorded video clip.
- 2 Press + to enter the edit window.
- 3 Press ◀ to enter the trim window.
↳ A bar for video trimming is displayed at the top of the window.
- 4 Press ▶ to set the starting point you want.
- 5 Press ▶|| to confirm.
- 6 Press ◀ to set the ending point you want.
- 7 Press ▶|| to confirm.
↳ A video trim menu is displayed.
- 8 Press +/- to select an option, then press ▶|| to confirm.

Menu option	Description
[Go back]	Go back to the trim window.
[Preview edit]	Preview the trimmed video clip.
[Save as new file]	Save the trimmed video clip as a new file.
[Cancel and exit]	Cancel the trim operation and exit.

Tag a file

- 1 In play mode, press ◀/▶ to select a file.
- 2 Press + to enter the edit window.
- 3 Press - to tag the file.
 - To untag the file, press - again.
- 4 Repeat steps 1 to 3 to tag other files.

Preview

- In play mode, press -.
↳ The thumbnails of 6 files are displayed on each page.
- To select a file, press +/- ◀/▶.

Play tagged files

- 1 During preview, hold ▶||.
↳ A tag operation menu is displayed.
- 2 Press +/- to select an option, then press ◀/▶ to highlight [Yes] for confirmation.

Menu option	Description
[Play all]	Play all files.
[Play tagged]	Play tagged files only.
[Quick impression]	Play excerpts of tagged files.
[Clear all tags]	Untag all files.

Options during video play

Fast forward/reverse

- During video play, press and hold ◀/▶.
 - To return to the normal speed, release ◀/▶.

Adjust volume level

- During video play, press +/-.

Adjust settings

- 1 In viewfinder mode, press ▶.
↳ A settings menu is displayed.
- 2 Press +/- to highlight an option.
- 3 Press ◀/▶ to select a setting.

- 4 Press ►|| to confirm the setting and return to viewfinder mode.

Settings menu option	Description
[Flash]	Select a flashlight mode: [On], [Off] or [Auto].
[Resolution]	Select a video resolution: [Full HD] (for best video quality), [Sports HD] (for filming of fast moving objects), or [Standard] (for reduced video file size).
[Photo Size]	Select the size of the photos to be saved (the higher the photo size, the higher the resolution).
[Scene]	Select an automatic exposure mode that matches your shot for easy shooting.
[F/S Detect]	Enable/disable face smile detection.
[Dual recording]	Record full HD and compressed QVGA videos at the same time.
[Autoplay]	Start automatic play when the camcorder is connected to a PC.
[Pre-record]	Enable/disable 3-second pre-record mode.
[Capture sound]	Turn on/off the capture sound.
[Date]	Set the date.
[Time]	Set the time.
[Language]	Select your desired menu language.
[Format SD card]	Clear contents from the micro SD card.
[TV system]	Change this setting if the output video does not appear correctly on your TV.

5 Use more of your camcorder

View video or pictures on TV

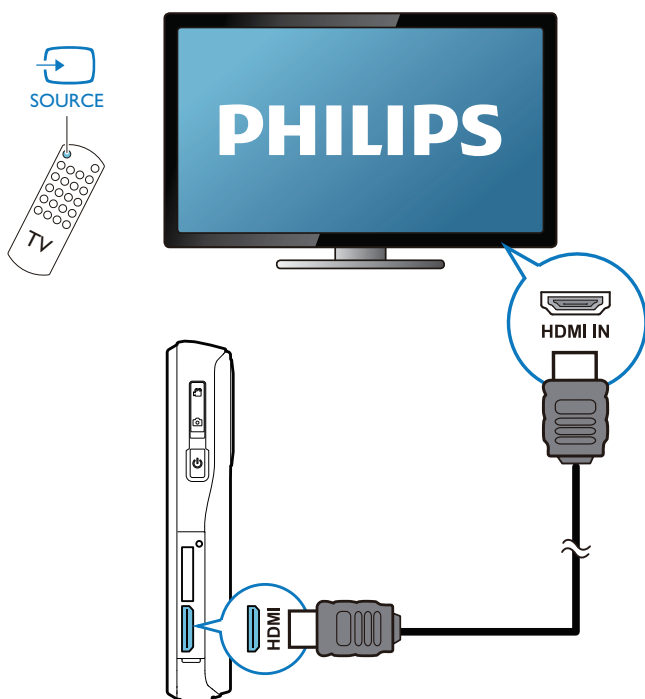

- 1 Connect an HDMI cable (not supplied) to:
 - the **HDMI** socket on the camcorder (requiring a mini HDMI connector)
 - the HDMI input socket on an HDTV

↳ An inquiry box for output mode selection is displayed.
- 2 To output the exact camcorder display with menu options to the TV screen, select **[TV]**.
 - To output the camcorder display without menu options to the TV screen, select **[Live CAM]**.
- 3 On the camcorder, select a file and start play.

Install and use the camcorder software

With the software (ArcSoft MediaImpression HD Edition) available in the internal memory of the camcorder, you can import, edit, archive or upload your pictures/videos to the Internet easily.

Note

- The software supplied only works on PCs that operate Microsoft® Windows® XP, Vista and Windows 7.
- When you connect the camcorder to a Mac, use the iMovie software to import and edit your pictures/videos directly.

Install the camcorder software

- 1 Connect the camcorder to a PC (see 'Get started' > 'Charge the built-in battery').
- 2 If the software does not install automatically, find and click the **Setup** icon at **My Computer\CAM110**.
- 3 Follow the on-screen instructions to finish installation of the software.

Install and use the camcorder software

- 1 On your PC, click **Start\ (All) Programs\ ArcSoft MediaImpression HD Edition**.
↳ The main screen of the software is displayed.



- 2 Click an option to select the corresponding operation.
- 3 Follow the on-screen instructions to complete the operation.

Transfer video/pictures to a PC/Mac

- 1 Connect the camcorder to a PC/Mac (see 'Get started' > 'Charge the built-in battery').
↳ It may take some time for the PC/Mac to recognize the camcorder.
- 2 Find your video/pictures at **My Computer\CAM110\DCIM\100MEDIA** or **My Computer\CAM110 SD\DCIM\100MEDIA**.
- 3 Copy any video/pictures you want to your designated folder in the PC/Mac.

Tip

- You can also import the video/picture files with the camcorder software (for PC) or iMovie (for Mac).

6 Technical specifications

Product information is subject to change without prior notice.

Image sensor	1/3.2" 8MP CMOS sensor
Operation modes	Movie record, picture record
Lens (focusing)	Auto focus f=4.76mm
Focus mode	Auto focus
Focus range	0.1m to Infinity
Aperture	F4.8
Digital zoom	5X
Exposure control	Auto
Exposure compensation	-2.0~2.0EV
White balance	Auto
Auto power off	3 minutes
Memory	64MB (512Mbit) DDR2 + 128MB SLC (96MB for AP) + Micro-SD card Slot
Shutter type	Electronic
Shutter speed	1/2~1/4000 second
Picture file format	JPEG
Video compression format	*.MP4 (H.264)
Video resolution	Full HD (1080p 30) 1920 X1080 (30fps) Sports HD (720p 60) 1280X720 (60fps) VGA (4:3) 640X480 (30fps)
Audio file format	AAC
Battery	1100mAh Li-ion (built-in); 120-minute battery life time based on 720P recording
PC interface	Mini USB 2.0 port

System support	Windows XP/Vista/ Windows 7, Mac (mass storage only)
TV out	NTSC/PAL selectable, Mini HDMI (type C)
Power rating	DC 5V, 500mA
Weight	0.06kg
Dimensions (W x H x D)	55.5 x 99.5 x 19 mm

7 Frequently asked questions (FAQ)

Why is there no response when I use the camcorder?

- The camcorder is in power-off mode. Turn on the camcorder (see 'Get started' > 'Turn on').
- The built-in battery may be drained. Charge the battery (see 'Get started' > 'Charge the built-in battery').

Why is [Memory full!] displayed when I try to record?

- Ensure that the Micro SD card has been inserted correctly (see 'Get started' > 'Load the Micro SD card').
- The memory is used up. Save your video/pictures to a computer (see 'Use more of your camcorder' > 'Transfer video/pictures to a PC/Mac'). Then delete files from your camcorder or clear the memory.

Why do I have no access to folders on the camcorder from my computer?

- Ensure that the USB connection is correct.
- The camcorder turns off automatically 15 minutes after it is connected to a computer. You can press ►|| to turn it on again.

Why do my video/pictures look blurry?

- Hold the camcorder steady in your hands during shooting.
- During video capture, do not move the camcorder too fast.
- Use a tripod (not supplied) if necessary.

Why do my video/pictures look distorted on a TV screen?

- Select the correct TV system.

How do I charge the camcorder?

- You can charge the camcorder via the USB pop-out connector. When you connect it to your PC/laptop it will automatically charge. You can also plug the camcorder via the pop-out USB into a USB charger.

How long do I have to charge the camcorder?

- The camcorder is fully charged for first usage. The camcorder charge time when connected to your PC/laptop is 3 hours. When you charge it via USB adaptor, the charge time is 2 hours.

How do I fast-forward or rewind on the camcorder?

- You can fast-forward during play of a movie by pressing the right-button for 2 seconds. You can rewind during play of a movie by pressing the left-button for 2 seconds.

Camcorder stopped responding?

- In the unlikely event that your camcorder stops responding, you can manually reset it. The reset button is located under the HDMI cover. There you see a small opening above the HDMI connection. Please use a small prying object (like a pen) to insert and press gently for resetting. After you have reset the camcorder, please turn on the camcorder again, and set-up will start again.

Why does the camcorder sometimes not record the right color?

- To record both indoors and outdoors, and not having to change any settings, the camcorder has an automatic white-balance correction. This enables you to record both indoors and outdoors where the amount of light in the environment changes. If you move fast from outdoors to indoors, the camcorder might need some time to correct that, and in extreme cases the colors might seem a bit unnatural. However, after a few seconds this will be corrected automatically by the camcorder.

Can I connect the camcorder directly to TV, DVD/Blu-ray player or Home Cinema set via their USB-port?

- The USB plug is designed to share your videos/pictures to your PC or Laptop. You can plug the CAM110 directly into your TV, DVD/Blu-ray player or Home cinema set (called the host from this point on), and it will play the pictures that are stored on the CAM110. To play the videos from the CAM110, it depends if your host supports the file format H.264 of the CAM110. Most Blu-ray enabled players are able to play this format.

How do I connect it to a Windows PC/laptop?

- Connect the camcorder to your PC/laptop via USB. The USB pop-out connector is strong enough to support the camcorder when it is plugged into the PC's USB port. For easy sharing and editing, install the software program (Media Impression HD) that comes with the camcorder.

How do I connect it to a Mac?

- The camcorder works with the Mac via USB. The USB pop-out connector is strong enough to support the camcorder when it is plugged into the USB port. The camcorder works great with the iMovie software, which is part of the iLife package that comes with your Mac. To transfer videos using iMovie, simply connect the camcorder to your Mac via USB, launch iMovie and start importing by clicking the camcorder icon. Select 'Use original quality' to ensure the best quality, and to maintain file sizes at an optimum.

What is HD?

- HD stands for High Definition. The camcorder captures videos in high definition (720p), which is also the resolution that HD TV programs are broadcast in. "720" refers to the display resolution, in terms of the number of horizontal lines onscreen. "p" stands for progressive scan, or the sequential

appearance of the lines in each frame. HD 720p gives video quality that is superior to that found in typical mobile phones and digital cameras.

How do I play my videos on TV?

- To play back on TV, please use an HDMI connector (mini HDMI to standard HDMI) if your TV accepts HDMI input, or use the video-out cable provided.

Why is there no lens cover?

- The camcorder comes without a lens cover, keeping it simple to use and fuss-free. It is made of robust material that doesn't scratch under normal usage. A travel pouch and a lens cloth are provided, allowing you to keep the camcorder clean.

What format does the camcorder record in?

- The camcorder uses the same video format as Blu-ray players and discs – H.264. This highly sophisticated format delivers superb HD picture quality.

What does pre-record mean that is in the setting?

- The pre-record button is designed to let you never miss a moment. When you enable the pre-record function, the camcorder will record video 3 seconds before you have pressed the record button. So when you play-back the recorded film, you will automatically see the first 3 seconds before you have pressed the record button. This can be useful when filming unexpected moments. The pre-record function will not drain battery life, it will operate as normal.

Some video files cannot be edited. Why is that?

- Video files recorded with dual recording cannot be edited. To edit video files on the camcorder, set **[Dual recording]** to **[Off]** before you record video (see 'Use your camcorder' > 'Adjust settings').

Tips on video making

- You can easily look back on fun moments and relive them with the camcorder. To enjoy these memories to the fullest, here are some simple video tips:
 - When capturing videos, hold your camcorder steady in your hand
 - Don't move too fast when panning (i.e. moving the camera horizontally) as it will be hard to follow what is captured when you review the video
 - Try shooting from different angles – for example, from the side, from the front, or even from below. You can easily join the different video segments together with the PC software included

Register online at www.philips.com/welcome today to
get the very most from your purchase.

Registering your model with PHILIPS makes you eligible for all of the valuable benefits listed below, so don't miss out. Register online at www.philips.com/welcome to ensure:

*Product Safety Notification

By registering your product, you'll receive notification - directly from the manufacturer.

*Additional Benefits

Registering your product guarantees that you'll receive all of the privileges to which you're entitled, including special money-saving offers.

PHILIPS

*Congratulations on your purchase,
and welcome to the "family!"*

Dear PHILIPS product owner:

Thank you for your confidence in PHILIPS. You've selected one of the best-built, best-backed products available today. We'll do everything in our power to keep you happy with your purchase for many years to come.

As a member of the PHILIPS "family," you're entitled to protection by one of the most comprehensive warranties in the industry. What's more, your purchase guarantees you'll receive all the information and special offers for which you qualify, plus easy access to accessories from our convenient home shopping network.

Most importantly, you can count on our uncompromising commitment to your total satisfaction.

All of this is our way of saying welcome - and thanks for investing in a PHILIPS product.

P.S. To get the most from your PHILIPS purchase, be sure to register online at:

www.philips.com/welcome

Know these
safety symbols



This "bolt of lightning" indicates uninsulated material within your unit may cause an electrical shock. For the safety of everyone in your household, please do not remove product covering.

The "exclamation point" calls attention to features for which you should read the enclosed literature closely to prevent operating and maintenance problems.

WARNING: To reduce the risk of fire or electric shock, this apparatus should not be exposed to rain or moisture and objects filled with liquids, such as vases, should not be placed on this apparatus.

CAUTION: To prevent electric shock, match wide blade of plug to wide slot, fully insert.

ATTENTION: Pour éviter les choc électriques, introduire la lame la plus large de la fiche dans la borne correspondante de la prise et pousser jusqu'au fond.

For Customer Use

Enter below the Serial No. which is located on the rear of the cabinet. Retain this information for future reference.

Model No. _____
Serial No. _____

PHILIPS

Visit our World Wide Web Site at <http://www.philips.com/welcome>

PHILIPS LIMITED WARRANTY

ONE (1) YEAR

WARRANTY COVERAGE:

PHILIPS warranty obligation is limited to the terms set forth below.

WHO IS COVERED:

Philips warrants the product to the original purchaser or the person receiving the product as a gift against defects in materials and workmanship as based on the date of original purchase ("Warranty Period") from an Authorized Dealer. The original sales receipt showing the product name and the purchase date from an authorized retailer is considered such proof.

WHAT IS COVERED:

The Philips warranty covers new products if a defect in material or workmanship occurs and a valid claim is received by Philips within the Warranty Period. At its option, Philips will either (1) repair the product at no charge, using new or refurbished replacement parts, or (2) exchange the product with a product that is new or which has been manufactured from new, or serviceable used parts and is at least functionally equivalent or most comparable to the original product in Philips current inventory, or (3) refund the original purchase price of the product. Philips warrants replacement products or parts provided under this warranty against defects in materials and workmanship from the date of the replacement or repair for ninety (90) days or for the remaining portion of the original product's warranty, whichever provides longer coverage for you. When a product or part is exchanged, any replacement item becomes your property and the replaced item becomes Philips' property. When a refund is given, your product becomes Philips' property.

Note: Any product sold and identified as refurbished or renewed carries a ninety (90) day limited warranty.

Replacement product can only be sent if all warranty requirements are met. Failure to follow all requirements can result in delay.

WHAT IS NOT COVERED - EXCLUSIONS AND LIMITATIONS:

This Limited Warranty applies only to the new products manufactured by or for Philips that can be identified by the trademark, trade name, or logo affixed to it. This Limited Warranty does not apply to any non-Philips hardware product or any software, even if packaged or sold with the product. Non-Philips manufacturers, suppliers, or publishers may provide a separate warranty for their own products packaged with the bundled product.

Philips is not liable for any damage to or loss of any programs, data, or other information stored on any media contained within the product, or any non-Philips product or part not covered by this warranty. Recovery or reinstallation of programs, data or other information is not covered under this Limited Warranty.

This warranty does not apply (a) to damage caused by accident, abuse, misuse, neglect, misapplication, or non-Philips product, (b) to damage caused by service performed by anyone other than Philips or Philips Authorized Service Location, (c) to a product or a part that has been modified without the written permission of

Philips, or (d) if any Philips serial number has been removed or defaced, or (e) product, accessories or consumables sold "AS IS" without warranty of any kind by including refurbished Philips product sold "AS IS" by some retailers.

This Limited Warranty does not cover:

- Shipping charges to return defective product to Philips.
- Labor charges for installation or setup of the product, adjustment of customer controls on the product, and installation or repair of antenna/signal source systems outside of the product.
- Product repair and/or part replacement because of improper installation or maintenance, connections to improper voltage supply, power line surge, lightning damage, retained images or screen markings resulting from viewing fixed stationary content for extended periods, product cosmetic appearance items due to normal wear and tear, unauthorized repair or other cause not within the control of Philips.
- Damage or claims for products not being available for use, or for lost data or lost software.
- Damage from mishandled shipments or transit accidents when returning product to Philips.
- A product that requires modification or adaptation to enable it to operate in any country other than the country for which it was designed, manufactured, approved and/or authorized, or repair of products damaged by these modifications.
- A product used for commercial or institutional purposes (including but not limited to rental purposes).
- Product lost in shipment and no signature verification receipt can be provided.
- Failure to operate per Owner's Manual.

TO OBTAIN ASSISTANCE IN THE U.S.A., PUERTO RICO, OR U.S. VIRGIN ISLANDS...

Contact Philips Customer Care Center at:
1-888-PHILIPS (1-888-744-5477)

TO OBTAIN ASSISTANCE IN CANADA...

1-800-661-6162 (French Speaking)
1-888-PHILIPS (1-888-744-5477) - (English or Spanish Speaking)

REPAIR OR REPLACEMENT AS PROVIDED UNDER THIS WARRANTY IS THE EXCLUSIVE REMEDY FOR THE CONSUMER. PHILIPS SHALL NOT BE LIABLE FOR ANY INCIDENTAL OR CONSEQUENTIAL DAMAGES FOR BREACH OF ANY EXPRESS OR IMPLIED WARRANTY ON THIS PRODUCT. EXCEPT TO THE EXTENT PROHIBITED BY APPLICABLE LAW, ANY IMPLIED WARRANTY OF MERCHANTABILITY OR FITNESS FOR A PARTICULAR PURPOSE ON THIS PRODUCT IS LIMITED IN DURATION TO THE DURATION OF THIS WARRANTY.

Some states do not allow the exclusions or limitation of incidental or consequential damages, or allow limitations on how long an implied warranty lasts, so the above limitations or exclusions may not apply to you.

This warranty gives you specific legal rights. You may have other rights which vary from state/province to state/province.

Philips, P.O. Box 10313 Stamford, CT 06904

3140 035 50201



Specifications are subject to change without notice
© 2011 Koninklijke Philips Electronics N.V.
All rights reserved.

CAM110_37_UM_V1.0



Free Manuals Download Website

<http://myh66.com>

<http://usermanuals.us>

<http://www.somanuals.com>

<http://www.4manuals.cc>

<http://www.manual-lib.com>

<http://www.404manual.com>

<http://www.luxmanual.com>

<http://aubethermostatmanual.com>

Golf course search by state

<http://golfingnear.com>

Email search by domain

<http://emailbydomain.com>

Auto manuals search

<http://auto.somanuals.com>

TV manuals search

<http://tv.somanuals.com>