

## Technical data proCOM family

	proCOM21VU		proCOM31VUS		
	VHF/FM port	UHF port	VHF/FM port	UHF port	SAT port
Operating frequency range	87.5 .. 108 MHz	470 .. 862 MHz	87.5 .. 108 MHz	470 .. 862 MHz	950 .. 2300 MHz
Insertion loss	≤ 1.0 dB	≤ 1.0 dB	≤ 1.2 dB	≤ 1.8 dB <sup>1</sup>	≤ 2.5 dB <sup>2</sup>
Isolation in FM band	—	≥ 30 dB	—	≥ 30 dB	≥ 50dB
Isolation in UHF band	≥ 30 dB	—	≥ 30 dB	—	≥ 48 dB
Isolation in SAT band	—	—	≥ 40 dB	≥ 36 dB <sup>3</sup>	—
Line-power pass from common port	No	Yes	No	No	Yes
Line-power pass ratings	20 V max. at 400 mA max.				
Signal connector type	Type-F (IEC 60169-24)				
Operating temperature range	-20 .. +50 °C				
EMC standard	BS EN 50083-2: 2001 (Class A)				

### Notes

1. ≤ 2.7 dB in band edge region 780 .. 862 MHz
2. ≤ 5.5 dB in band edge region 950 .. 1100 MHz
3. ≥ 23 dB in band edge region 950 .. 1100 MHz

## 2-Year Guarantee

This guarantee covers failure of your PROception product resulting from manufacturing defect within a period of 2 years from the date of supply to the end-user.

This guarantee does not cover damage to the product caused by abuse, tampering, defective installation or natural causes such as lightning discharge. Repair or attempted repair, other than by the manufacturer, will render this guarantee void.

This guarantee does not affect a consumer's statutory rights.

Performance data given are typical unless otherwise stated. Proception Limited reserves the right to change product designs and specifications without prior notice.

**Proception Limited,**  
177-187 Rutland Road  
SHEFFIELD  
S3 9PT  
United Kingdom

Web: <http://www.proception.co.uk/>  
e-mail: [support@proception.co.uk](mailto:support@proception.co.uk)



PD2011-9015-01

# PROception

# proCOM Band-Selective Combiner/Splitters

## INSTALLATION INSTRUCTIONS

These masthead and general-purpose passive products are used for combining or splitting signals in the VHF/FM, UHF and satellite IF frequency bands with a minimum of insertion loss. The units are fully-screened and are easy to install, both indoors and outdoors. The use of 'F' connectors allows their use with a wide range of cable sizes.

### Features

- Low in-band insertion loss.
- High rejection of unwanted bands.
- Ideal for both digital and analogue applications.
- Power-pass to the higher or highest frequency band input.
- Robust diecast housings, suitable for outdoor (masthead) and indoor use.

### Application examples

**proCOM21VU** is a two-band passive combiner/splitter (diplexer) for combining or splitting signals in Band II (VHF/FM) and Bands IV-V (UHF). Typical applications include combining signals from VHF/FM and UHF antennas onto a single download cable – Fig. 1 – or splitting a combined feed from a distribution amplifier or system to feed separate outlets – Fig. 2. This unit will pass line-power between the common and UHF ports, allowing a masthead preamplifier to be used on the UHF antenna if necessary – Fig. 3.

**proCOM31VUS** is a 3-band passive combiner/splitter (triplexer) for combining or splitting signals in Band II (VHF/FM), Bands IV-V (UHF) and the satellite IF band (SAT). The very high rejection on the SAT port in the FM and UHF bands allows this unit to be used to combine the output of a satellite LNB with VHF and UHF terrestrial antennas – Fig. 4. High isolation is required in this application to prevent wideband amplified noise present on the output of the LNB from degrading the VHF and UHF signals. The proCOM31VUS passes line-power between the common and SAT ports, allowing LNB power and 22 kHz tone or DiSEqC controls to function normally.

Fig.1 – combining antennas

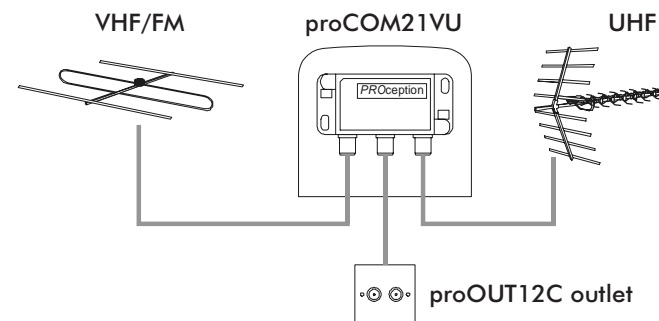

Fig.2 – splitting a distribution system feed to separate outlets

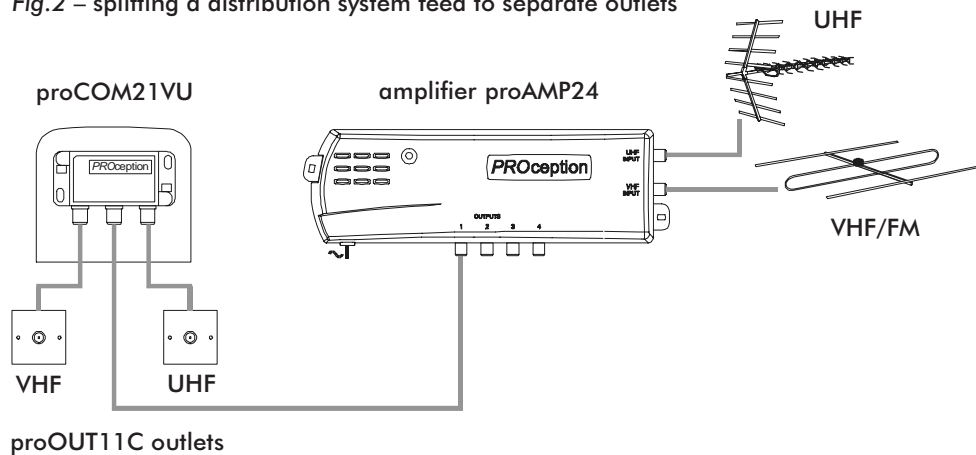
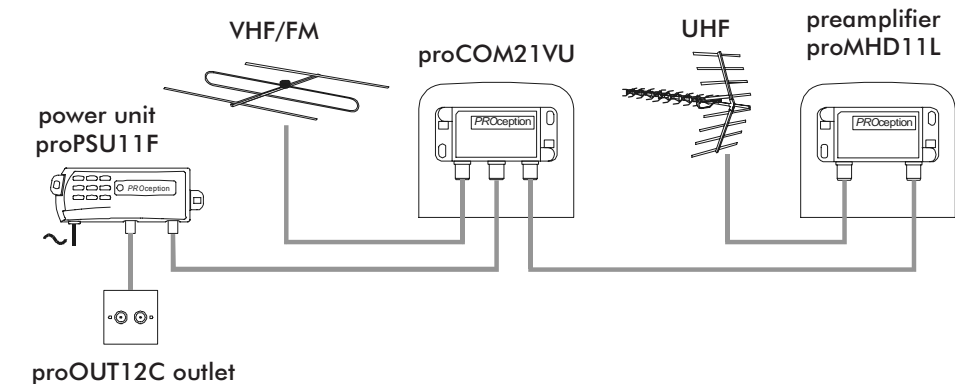
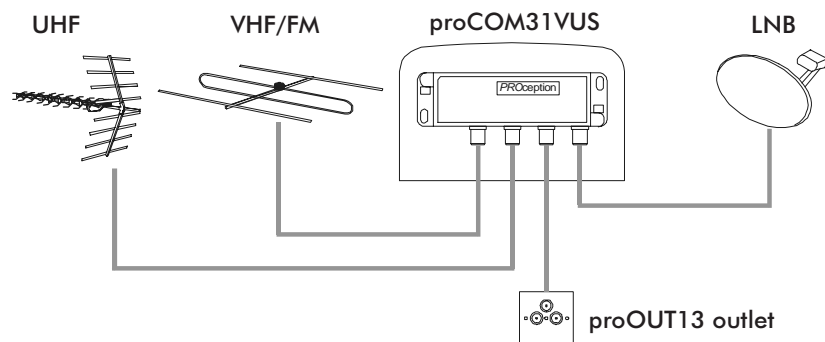

Fig.3 – using a UHF preamplifier



Note: a preamplifier cannot be powered via the proCOM31VUS since there is no line-power pass to the UHF port.

Fig.4 – combining antennas and LNB



## Fixing

Methods for mounting the amplifier are illustrated in Figs. 5 to 7. The cable tie fixing is intended to support the weight of the amplifier only. Cables should be taped to the mast at intervals of approximately 400 mm to ensure that their weight is adequately supported. Being fully screened, these amplifiers will not be affected by proximity to antennas. However clearance of not less than 300 mm from the nearest part of an antenna should be observed to avoid degrading the antenna's performance.

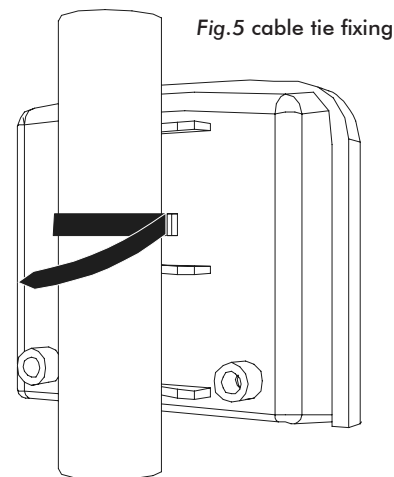

Fig.6 fixing to flat surface

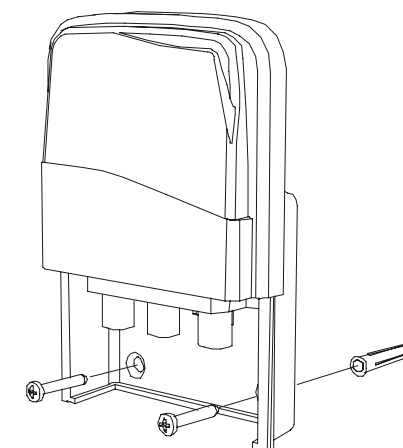
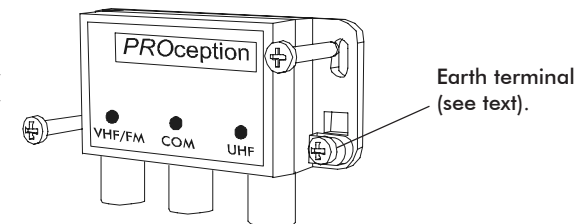

Fig.7 Fixing the amplifier module directly (indoor application only, discard mouldings).



## Signal connections

To preserve RF screening integrity the signal connections to the amplifier should be made using good quality coaxial cable and connectors. This is particularly important with DTT to minimise the ingress of impulsive electrical interference. The use of cable 'benchmarked' under the CAI scheme is recommended.

Crimp 'F' connectors, used in accordance with the manufacturer's instructions, will give the best results. The importance of achieving sound braid connections cannot be over-stressed.

## System earth bonding

Earth bonding terminals are provided on the amplifier castings for use where necessary. Distribution systems supplying signals to more than one household should comply with the safety requirements of BS EN 50083-1. This effectively requires the system to be earth bonded. (The use of isolated outlet plates is no longer recommended since they compromise screening integrity and allow ingress of interference.)

## Free Manuals Download Website

<http://myh66.com>

<http://usermanuals.us>

<http://www.somanuals.com>

<http://www.4manuals.cc>

<http://www.manual-lib.com>

<http://www.404manual.com>

<http://www.luxmanual.com>

<http://aubethermostatmanual.com>

Golf course search by state

<http://golfingnear.com>

Email search by domain

<http://emailbydomain.com>

Auto manuals search

<http://auto.somanuals.com>

TV manuals search

<http://tv.somanuals.com>