

RCA

RLDEDV2813-A-B

TV USER'S MANUAL



LED TV
28" Wide Screen Digital LED TV

Index

- 1. INTRODUCTION 2
 - 1.1. Safety Information 2
 - 1.2. TV Base Stand assemble 7
 - 1.3. General View 9
 - 1.3.1. Front and Back 9
 - 1.3.2. Connection Panel 10
 - 1.3.3. Remote Control 11
- 2. INSTALLATION 13
 - 2.1. Power Supply Connection 13
 - 2.2. RF Antenna Connection 13
 - 2.3. Connecting via Composite Video 14
 - 2.4. Connecting via Component Video 14
 - 2.5. Connect to Digital Audio Amplifier 15
 - 2.6. Connecting via HDMI 15
 - 2.7. Connecting to a PC 16
 - 2.8. Connecting Headphones 16
- 3. Initial Setup 17
 - 3.1. Initial Installation 17
 - 3.2. Audio/Video Source Selection 17
 - 3.3. DTV Mode Operations 17
- 4. SETTINGS 18
 - 4.1. Customizing the PICTUERE Settings 18
 - 4.2. Customizing the Audio Settings 19
 - 4.3. Customizing the TIME Settings 20
 - 4.4. Customizing the SETUP Settings 21
 - 4.5. Customizing the Patental Settings 24
 - 4.6. Customizing the TV Settings 27
- 5. PC Mode 30
- 6. DVD MENU 31
- 7. TROUBLE SHOOTING 39
- 8. SPECIFICATIONS 41

1. INTRODUCTION

1.1. Safety Information

To ensure reliable and safe operation of this equipment, please read carefully all the instructions in this user guide, especially the safety information below.



CAUTION: TO REDUCE THE RISK OF ELECTRIC SHOCK, DO NOT REMOVE COVER (OR BACK). NO USER-SERVICEABLE PARTS INSIDE. REFER SERVICING TO QUALIFIED SERVICE PERSONNEL.



The lightening flash with arrowhead symbol, within an equilateral triangle is intended to alert the user to the presence of un-insulated "dangerous voltage" within the products enclosure that may be of sufficient magnitude to constitute a risk of electric shock to the persons.

The exclamation point within an equilateral triangle is intended to alert the user to the presence of important operating and maintenance (servicing) instructions in the literature accompanying the appliance.



WARNING: TO REDUCE THE RISK OF FIRE OR ELECTRIC SHOCK, DO NOT EXPOSE THIS APPLIANCE TO RAIN OR MOISTURE.

CAUTION: Use of controls or adjustments or performance of procedures other than those specified herein may result in hazardous radiation exposure.

Please, carefully study this manual and always keep it available. There are, however, some installation and operation precautions which you should be aware of:

1. READ INSTRUCTIONS: All the safety and operating instructions should be read before the product is operated.

2. RETAIN INSTRUCTIONS: The safety and operating instructions should be retained for future reference.

3. HEED WARNINGS: All warnings on the product and in the operating instructions should be adhered to.

4. FOLLOW INSTRUCTIONS: All operating and use instructions should be followed.

5. CLEANING: Unplug this product from the wall outlet before cleaning. Do not use liquid cleaners or aerosol cleaners. Use a damp cloth for cleaning.

6. ATTACHMENTS: Do not use attachments not recommended by the product manufacturer as they may cause hazards.

7. WATER AND MOISTURE: Do not use this product near water – for example, near a bath tub, wash bowl, kitchen sink, or laundry tub - in a wet basement or near a swimming pool and the like.

8. ACCESSORIES: Do not place this product on an unstable cart, stand, tripod, bracket or table. The product may fall, causing serious injury to a child or adult and serious damage to the product. Use only with a cart, stand, tripod, bracket or table recommended by the manufacturer or sold with the product. Any mounting of the product should follow the manufacturer's instructions and should use a mounting accessory recommended by the manufacturer. A product and cart combination should be moved with care: Quick steps, excessive force and uneven surfaces may cause the product and cart combination to overturn.



9. VENTILATION: Slots and openings in the cabinet are provided for ventilation and to ensure reliable operation of the product and to protect it from overheating, and these openings must not be blocked or covered. The openings should never be blocked by placing the product on a bed, sofa, rug, or other similar surface. This product should not be placed in a built-in installation such as a bookcase or rack unless proper ventilation is provided or the manufacturer's instructions have been adhered to.

10. POWER SOURCES: This product should be operated only from the type of power source indicated on the marking label. If you are not sure of the type of power supply to your home, consult your product dealer or local power company.

11. GROUNDING OR POLARIZATION: This product may be equipped with a polarized alternating-current line plug (a plug having one blade wider than the other). This plug will fit into the power outlet only one way. This is a safety feature. If you are unable to insert the plug fully into the outlet, try reversing the plug. If the plug should still fail to fit, contact your electrician to replace your obsolete outlet. Do not defeat the safety purpose of the polarized plug.

12. POWER-CORD PROTECTION: Power-supply cords should be routed so that they are not likely to be walked on or pinched by items placed upon or against them, paying particular attention to cords at plugs, convenience receptacles, and the point where they exit from the product.

13. OUTDOOR ANTENNA GROUNDING: If an outside antenna or cable system is connected to the product, be sure the antenna or cable system is grounded so as to provide some protection against voltage surges and built-up static charges. Article 810 of the National Electrical Code, ANSI/NFPA 70, provides information with regard to proper grounding of the mast and supporting structure, grounding of the lead-in wire to an antenna discharge unit, size of grounding conductors, location of antenna-discharge unit, connection to grounding electrodes, and requirements for the grounding electrode.

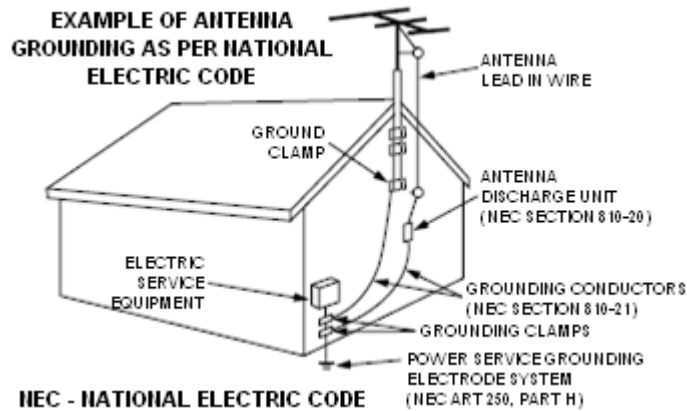

14. LIGHTNING: For added protection for this product during a lightning storm, or when it is left unattended and unused for long periods of time, unplug it from the wall outlet and disconnect the antenna or cable system. This will prevent damage to the product due to lightning and power-line surges.

15. POWER LINES: An outside antenna system should not be located in the vicinity of overhead power lines or other electric light or power circuits, or where it can fall into such power lines or circuits. When installing an outside antenna system, extreme care should be taken to keep from touching such power lines or circuits as contact with them might be fatal.

16. OVERLOADING: Do not overload wall outlets, extension cords, or integral convenience receptacles as this can result in a risk of fire or electric shock.

17. OBJECT AND LIQUID ENTRY: Never push objects of any kind into this product through openings as they may touch dangerous voltage points or short-out parts that could result in a fire or electric shock. Never spill liquid of any kind on the product.

18. SERVICING: Do not attempt to service this product yourself as opening or removing covers may expose you to dangerous voltage or other hazards. Refer all servicing to qualified service personnel.

19. DAMAGE REQUIRING SERVICE: Unplug this product from the wall outlet and refer servicing to qualified service personnel under the following conditions:

- When the power-supply cord or plug is damaged.
- If liquid has been spilled, or objects have fallen into the product.
- If the product has been exposed to rain or water.
- If the product does not operate normally by following the operating instructions. Adjust only those controls that are covered by the operating instructions as an improper adjustment of other controls may result in damage and will often require extensive work by a qualified technician to restore the product to its normal operation.
- If the product has been dropped or damaged in any way.
- When the product exhibits a distinct change in performance – this indicates a need for service.

20. REPLACEMENT PARTS: When replacement parts are required, be sure the service technician has used replacement parts specified by the manufacturer or have the same characteristics as the original part. Unauthorized substitutions may result in fire, electric shock, or other hazards.

21. SAFETY CHECK: Upon completion of any service or repairs to this product, ask the service technician to perform safety checks to determine that the product is in proper operating condition.

22. WALL OR CEILING MOUNTING: The product should be mounted to a wall or ceiling only as recommended by the manufacturer.

23. HEAT: The product should be situated away from heat sources such as radiators, heat registers, stoves, or other products (including amplifiers) that produce heat.

24. MAINS PLUG: Is used as the disconnect device. It shall remain readily operable, and should not be obstructed during intended use.

Wall Mounting

1. Ensure that the selected wall is made of appropriate material and can support the weight of the TV. Make sure there are no pipes or cables inside the wall on your chosen position.
2. Obtain a suitable wall mounting bracket and mounting eyebolts (thread size M6x10) and screws from your local hardware store.
3. Place the unit face down on a soft surface.
4. Remove the attached leg at the bottom of the TV by removing the 4 screws on the leg cover.
5. Refit the cover securely by replacing the 4 screws into their original positions.

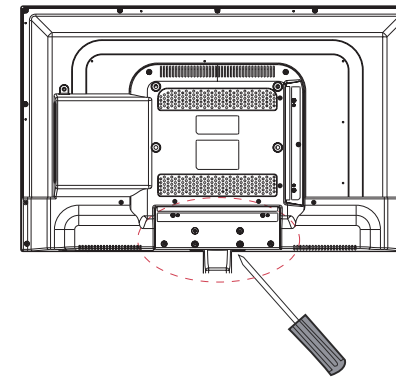

6. Fasten 4 eyebolts into the four screw holes on the TV's rear panel according to the diagram.
7. Fasten the wall mounting bracket using screws onto the wall.
8. Connect the eyebolts and the wall bracket securely with strong rope
9. Carefully check that all fastenings are secure before releasing the TV.

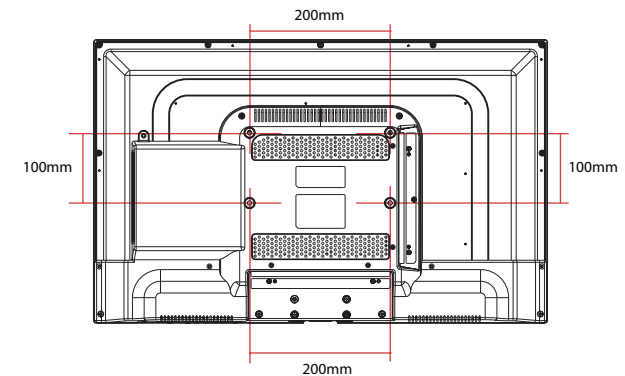

✦ Thread hole size – M6 x 10 depth (TV Mounting Screw Size) on the TV.

1.2. TV PLACEMENT SETUP

TV Stand Installation/Removal

1. Place the unit face down on a soft surface.
2. Gently position the glass base to the leg at the bottom of the TV.
3. Insert the column corresponding position with the threaded screw size M4 * 20(up*2pcs) and M4*25(down*2pcs) fixed.
4. Fasten the 4 provided screws (screw size B4x14) to secure the stand to the TV according to the diagram.

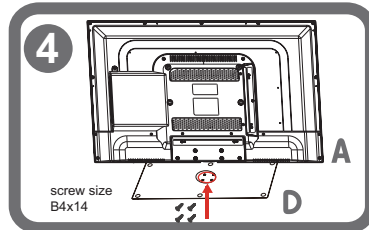
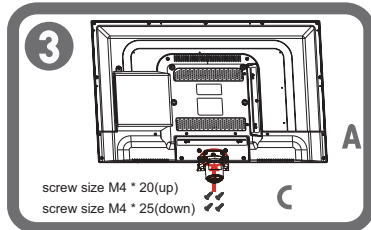
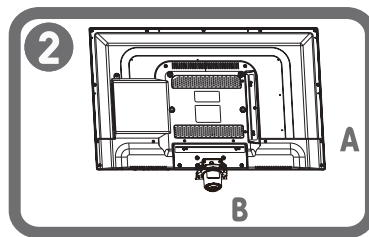
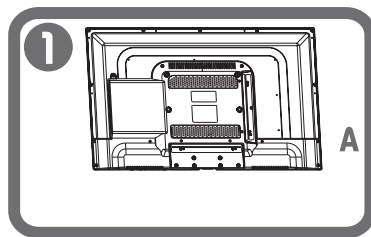

1.3. General View

1.3.1. Front and Back

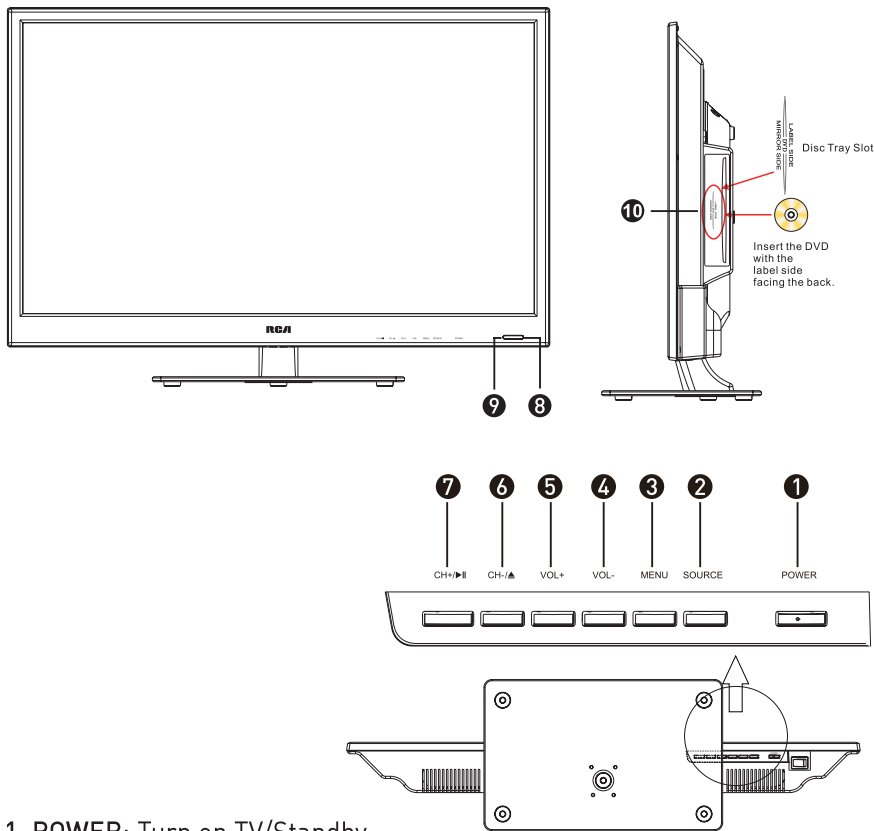

1. **POWER:** Turn on TV/Standby
2. **SOURCE:** Audio/video input source selection
3. **MENU:** Open settings menu
4. **VOL-:** Decrease volume
5. **VOL+:** Increase volume
6. **CH-:** Previous channel ▲ : Eject disc
7. **CH+:** Next channel ►|| : play/pause picture
8. **IR RECEIVER:** Receives infrared signals from the remote control
9. **INDICATOR LED:** Status indicator (Power On: Green / Standby: Red)
10. **DVD**

1.3.2. Connection Panel

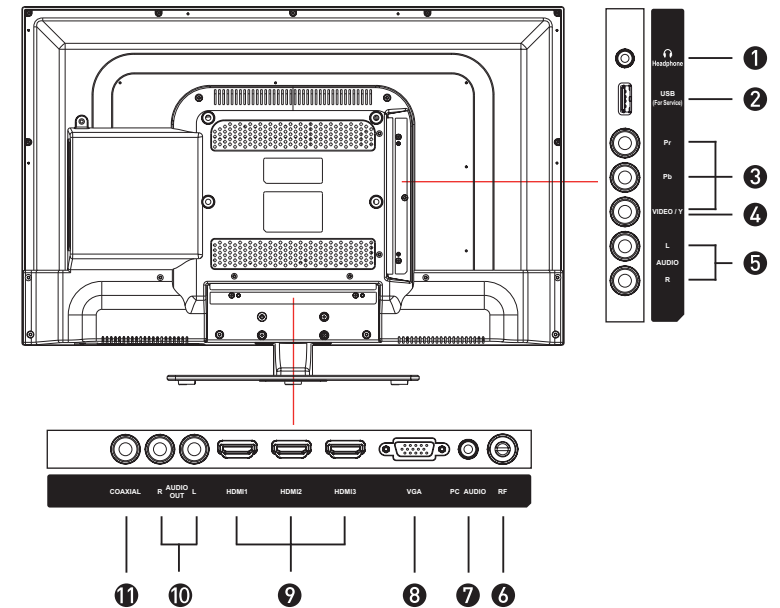

1. **Headphones**
2. **USB Host port**
3. **YPbPr:** Connect to the YPbPr video output terminal of DVD
4. **Video:** Video input
5. **AUDIO IN R/L:** Stereo audio input
6. **RF:** Antenna connection
7. **PC AUDIO:** Connect it to the audio output terminal of PC
8. **VGA:** PC video input
9. **HDMI**
10. **AUDIO OUT R / L:** Output Audio L / R (left / right)
11. **Coaxial:** Digital audio output

1.3.3. Remote Control

BASIC OPERATIONS

- POWER** (⏻): Turn on the TV/Standby
MUTE (🔇): Mute the sound from speakers
SOURCE (📺): Show input the source Menu
P.MODE: Output image mode
S.MODE: Setting audio options
SLEEP: Auto Power Off Timer
ASPECT: Selects the screen size
NUMBER KEYS: Change the channel directly
EPG: Shows Electronic Program Guide
INFO: Show information about the current programme
RETURN (↶): Returns to the previous channel tuned
MENU: Show Menu
“-”: Select channel with two digits
EXIT: Exit the Menu
D.SETUP: In DVD mode, press to enter/exit DVD setting menu
(Up, Down, Left, Right, OK): To move in the menus and confirm settings
“+” “-”: Increase and decrease volume
“∨” “∧”: Next and Previous Channel
ZOOM: Zoom the screen size (DVD or multimedia).
FAV: Show the list of favorite channels
FAV -: Previous favorite channel
FAV +: Next favorite channel
CC: CC mode
SUBT.: Select sub-title of DVD or media video file (needs the support of disk or flie)
MTS: Audio language selection



Universal Remote Code:08F7
 (Universal Rmote Control is not included)

- AUDIO**: Switch the audio channel when DVD or multimedia playing
FREEZE: Freeze the image
A-B: Repeat play point A and B
CHLIST: Displays channel lists on the screen
GOTO: Go to a specific point in the playback
D.MENU: Display the menu of the DVD
“▲”: Eject disc **“■”**: Stop playback **“▶▶”**: Play/Pause picture
“◀◀”: Fast rewind playback **“▶▶”**: Fast forward playback
“◀”: Previous file or chapter **“▶”**: Next file or chapter
TITLE: Go to the title page of DVD disk
PROGRAM: Set a programming playing list (DVD)
ANGLE: Select DVD playing angle (needs support of DVD disk)
REPEAT: Set a repeating mode

Install the Batteries

If the remote control fails to operate the TV functions, replace the batteries in the remote control.

- 1 Open the battery cover.
- 2 Insert two size-AAA batteries.(Place the batteries with their terminals corresponding to the (+) and (-) indications in the battery compartment.)
- 3 Replace the cover.

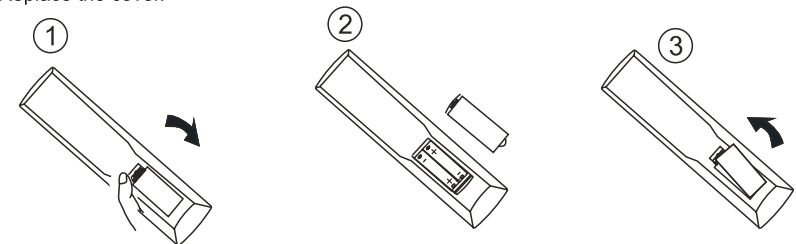

Precaution on battery use

- Improper use of batteries can result in a leakage of chemicals and/or explosion. Be sure to follow the instructions below.
- * Place batteries with their terminals corresponding to the (+) and (-) indications.
 - * Different types of batteries have different characteristics. Do not mix batteries of different types.
 - * Do not mix old and new batteries. Mixing old and new batteries can shorten the life of new batteries and/or cause old batteries to leak chemicals.
 - * Remove batteries as soon as they are non-operable. Chemicals that leak from batteries can cause a rash. If chemical leakage is found, wipe with a cloth.
 - * If the remote control is not used for an extended period of time, remove the batteries from the remote control.
 - * The batteries (battery pack of batteries installed) shall not be exposed to excessive heat such as sunshine, fire or the like.

2. INSTALLATION

2.1. Power Supply Connection

Connect the power adaptor to a home power outlet.



2.2. RF Antenna Connection

Connect the antenna as shown in the figure to receive the analog or digital (DTT) TV signal.

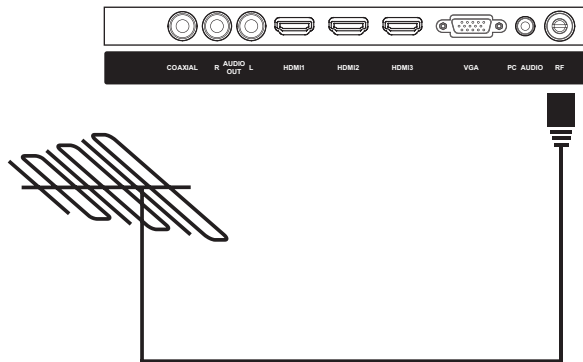

2.3. Connecting via Composite Video

Connect your video player, decoder, DVD or similar with the corresponding tri-color RCA cable, from the AV output (audio/video) of your video equipment to the video and audio input to your TV by the cable, as shown in the figure.

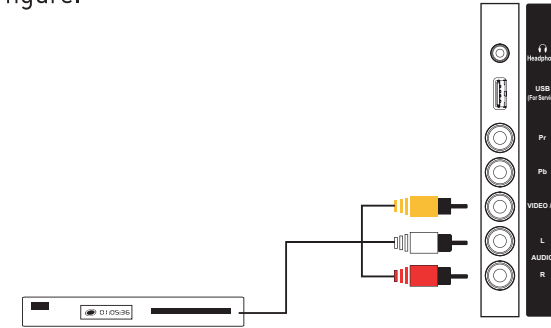

2.4. Connecting via Component Video

Connect your video player, decoder, DVD or similar with an RCA cable, from the YPbPr video output of the device to the video input on your TV by the cable, as shown in figure. Through this entry you can get HD video. Use a second RCA cable to connect the audio to AUDIO IN R/L.

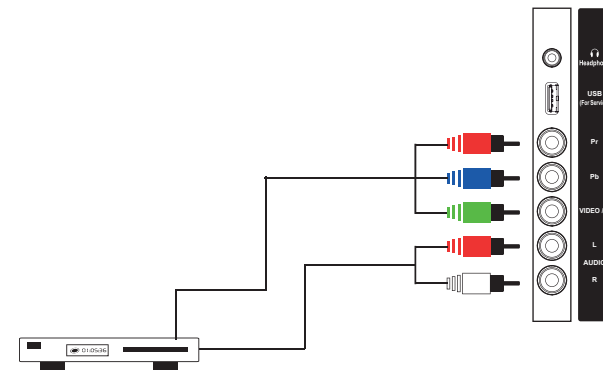

2.5. Connect to Digital Audio Amplifier

Take the coaxial digital audio output of your TV to connect to a hifi system you have, and improve your sound experience.

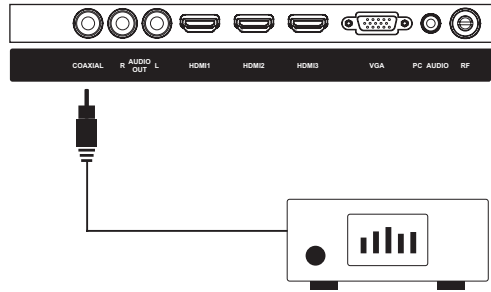

Note:Coaxial output

2.6. Connecting via HDMI

Connect your video player, decoder, DVD or similar, with the corresponding HDMI cable from the HDMI output of your video equipment to one of the HDMI input on your TV, as shown in figure. This cable transfers HD video and audio.

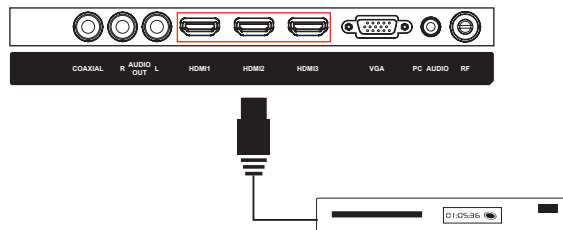

2.7. Connecting to a PC

Connect the VGA output (RGB) from your PC to the corresponding input on your TV, and the audio output from your computer to the PC AUDIO input of your television.

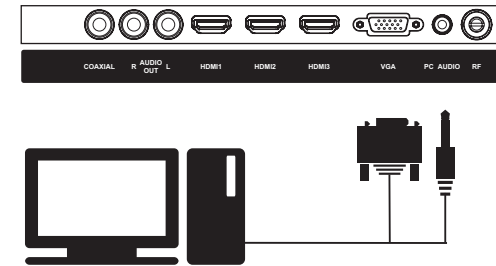

2.8. Connecting Headphones

Use the HEADPHONES output of your TV set to listen the audio of the unit through your own stereo headphones. When you connect headphones to the unit, the main speakers will be silenced.

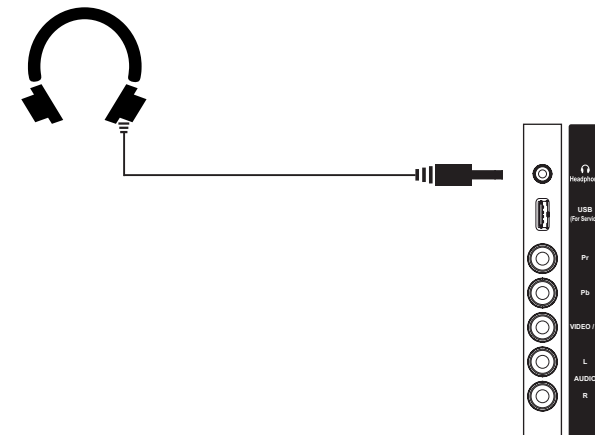

3. Initial Setup

3.1. Initial Installation

The first time the unit is turned on or anytime the system is restored to the defaulted settings, the Initial Installation wizard will be displayed on the screen.

Connect the antenna cable to the RF connector at the connections panel and follow the steps displayed on the screen to set up the system basic settings (Language, Cable, etc.) and start an auto search of TV channels.

3.2. Audio/Video Source Selection

Turn on the TV by pressing the **POWER** button on TV or on the remote control, press **SOURCE** and use the direction buttons **▲** / **▼** to select the desired source depending on the equipment you have connected (AV, HDMI, VGA) or choose TV to enter these mode.

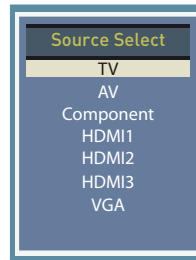

3.3. DTT Mode Operations

Use **CH+** or **CH-** buttons to tune the desired channel, or enter the channel number directly using the numeric keypad. Press **OK** to display on screen the list of TV and radio channels (press the **◀/▶** buttons to sort by group and show only the DTV, the analog TV channels, Radio channels, etc.).

Use **MTS** button to select the audio language broadcasting, **CC** button to show or hide subtitles on screen and **FAV** button to see a list of your favorite channels.

4. SETTINGS

4.1. Customizing the PICTURE Settings

Select TV source for example. (Press **SOURCE** button to select TV mode)

1. Press the **POWER** button to turn the LED TV on.
2. Press the **MENU** button on the remote control to display the Main menu, and use the **◀/▶** buttons to select the **PICTURE**.
3. Use the **▲/▼** buttons to highlight an individual **PICTURE** option, use the **◀/▶** buttons to change the setting, and press the **MENU** button to exit the menu.

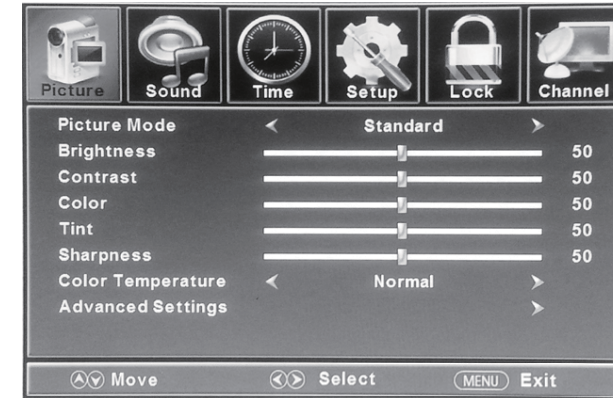

The PICTURE menu includes the following options:

Picture Mode Cycle among picture display modes: Standard, Dynamic, Mild, user.

Brightness Control the overall brightness of the picture.

Contrast Control the difference between the brightness and darkest regions of the picture.

Color Control the color.

Tint Controls the tint.

Sharpness Increase this setting to see crisp edges in the picture; decrease it for soft edges.

Color Temp. Cycles among color modes: Normal, Warm, Cool.

Advanced Settings
 1) **ASPECT RATIO** This feature changes the various aspects of the TV's video. (Aspects include wide, zoom, cinema, normal).
 2) **NOISE REDUCTION** This feature reduces general pixilation by blurring them.
 3) **DYNAMIC CONTRAST** This feature allows the TV to automatically adjust the contrast of the TV depending on the picture you are viewing.

4.2. Customizing the Audio Settings

Select TV source for example. (Press SOURCE button to select TV mode)

1. Press the POWER button to turn the LED TV on.
2. Press the MENU button on the remote control to display the Main menu, and use the ◀/▶ buttons to select the AUDIO.
3. Use the ▲/▼ buttons to highlight an individual AUDIO option, use the ◀/▶ buttons to change the setting, and press the MENU button to exit the menu.



The AUDIO menu includes the following options:

Equalizer Settings Allow you to select among: Standard, Music, Movie and User.

MTS This feature adjusts the second audio programming in analog channels.

Audio Language Allow you to select audio language among: English, French and Spanish.

Digital Audio Output Allow you to select between PCM, RAW and OFF.

Surround Allow you to select between Off and On.

AVL This feature adjusts the auto volume leveler enabling volume protection from overly loud commercials.

4.3. Customizing the TIMER Settings

Select TV source for example. (Press SOURCE button to select TV mode)

1. Press the POWER button to turn the LED TV on.
2. Press the MENU button on the remote control to display the Main menu, and use the ◀/▶ buttons to select the TIMER.
3. Use the ▲/▼ buttons to highlight an individual TIMER option, use the ◀/▶ buttons to change the setting, and press the MENU button to exit.



The TIMER menu includes the following options:

Sleep Timer Allow you to set up the sleep timer among: 5min, 10min, 15min, 30min, 60min, 90min, 120min, 180min, 240min and off.

Time Zone Allow you to set up the sleep timer among: Pacific, Alaska, Hawaii, Eastern, Samoa, Atlantic, Newfoundland, Central and Mountain.

Daylight Saving Time Allow you to turn on or off the daylight saving time.

Time Format This option adjusts the display format for the time.

Auto Clock This option enables the TV to sync time with the antenna. (Put it on AUTO if you have an antenna attached to the TV. If you have CABLE or SATELLITE of anything else please use make sure AUTO CLOCK is turned off.)

Clock This option adjusts the time and date of the TV. You need to disable AUTO CLOCK in order to use this function.

Please Note:

The TIME function will only keep accurate time if the TV is plugged into a power source. If the TV is unplugged or the power strip is turned off, the TV's time will not be accurate.

4.4. Customizing the SETUP Settings

Select TV source for example. (Press SOURCE button to select TV mode)

1. Press the POWER button to turn the LED TV on.
2. Press the MENU button on the remote control to display the Main menu, and use the ◀/▶ buttons to select the SETUP.
3. Use the ▲/▼ buttons to highlight an individual SETUP option, use the ◀/▶ buttons to change the setting, and press the MENU button to exit.



The TIMER menu includes the following options:

- Menu Language** Allow you to select menu language among: English, Français and Español.
- Transparent** This option changes the transparency of the menu allowing background TV images to show through.
- OSD Timeout** This option changes the time which the TV's OSD menu automatically goes off.
- Input Label** This option changes the source names to your personal preference
- Other Settings** Input PC signal first, then press SOURCE button to select PC mode, press ▶ button to confirm.



- H-Position** Allow you to use the ◀/▶ buttons to adjust the H Position.
- V-Position** Allow you to use the ◀/▶ buttons to adjust the V Position.
- Clock** Allow you to prolong the image.
- Phase** Allow you to adjust the definition.
- Auto** Select "Auto" and press the ▶ button, the unit will automatically adjust all items to achieve a best effect.

Close Caption

Use the ▼ button to highlight the Close Caption item, then press the ▶ button to enter into the following menu.



- CC Mode** Allow you to select the CC Mode among: Off, On and CC on Mute.
- Analog CC** Allow you to select the basic selection among: CC1, CC2, CC3, CC4, Text1, Text2, Text3 and Text4.
- Digital CC** Allow you to select the advanced selection among: Service1, Service2, Service3, Service4, Service 5 and Service6.
- Option** Use the ▼ button to highlight the "Option" item, then press the ▶ button to enter into the following menu.



Use the ▲/▼ buttons to highlight the desired item, and use the ◀/▶ buttons to select.

4.5. Customizing the LOCK Settings

Select TV source for example. (Press SOURCE button to select TV mode)

1. Press the POWER button to turn the LED TV on.
2. Press the MENU button on the remote control to display the Main menu, and use the ◀/▶ buttons to select the LOCK.
3. Use the ▼ button to highlight “Enter Password” item, use the numeric keys to input 4-digital password. After you that, the screen will display the junior menu. After settings, press menu button to exit.

NOTE: The factory password is 0000. The supervision password is 8899.

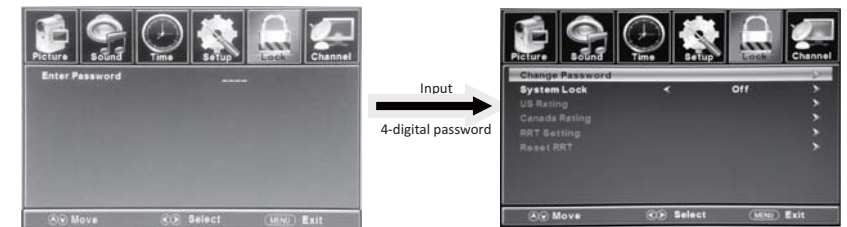

The LOCK menu includes the following options:

Change Password

Use the ▼ button to select the “Change Password” item, then press the ▶ button to enter into the following menu.

Restore Default Restore all settings in SETUP menu to factory settings.



Setup Wizard

This option enables the TV to show you the setup wizard of the TV again.

Please Note:

Closed captioning is only available under AV and TV ports.

Closed captioning depends on your TV program’s support. Sometimes due to the TV channel or the signal, Closed captioning will no



Input the new 4-digital password and input it again to confirm.

System Lock

Allow you to turn on or off the system lock.

If you turn off the system lock, then the following items (US, Canada, RRT Setting and Reset RRT) will unable to use.

US

Use the ▼ button to highlight the “US” item, then press the ► button to enter into the following menu.



TV Use the ▼ button to highlight the “TV” item, then press ► button to enter into the following menu.



Use the ▲/▼ buttons to select the desired rating and press the ► button to block or unblock rating.

MPAA The Movie rating (MPAA) is used for original movies rated by the Motion Picture Association (MPAA) as broadcasted on cable TV and not edited for television. Use the ▲/▼ buttons to select N/A, G, PG, PG-13, R, NC-17 or X.

RATING	DESCRIPTION
G	General Audiences. Movie is appropriate for all ages.
PG	Parental Guidance Suggested. May contain material not suited for younger viewers
PG-13	Contains content that may not be appropriate for viewers under the age of 13.
R	Restricted. Contains adult content, no one under 17 admitted without parent.
NC-17	No one 17 and under admitted.
X	Adults only.

Canada

Use the ▼ button to highlight the “Canada” item, then press ► button to enter into the following menu.



Canada Eng Use the ◀/▶ buttons to select among: OFF, C, C8+, G, PG, 14+ and 18+.

Canada Fre Use the ◀/▶ buttons to select among: OFF, G, 8ans+, 13ans+, 16ans+ and 18ans+.

RRT Setting

This feature is a downloadable rating filter based on TV broadcasts. With the transition of TV broadcasts to digital, future changes, and enhancements in how TV shows are rated for content are possible.

Reset RRT

Allow you to reset the RRT setting.

4.6. Customizing the CHANNEL Settings

Select TV source for example. (Press SOURCE button to select TV mode)

1. Press the POWER button to turn the LED TV on.
2. Press the MENU button on the remote control to display the Main menu, and use the ◀/▶ buttons to select the CHANNEL.
3. Use the ▲/▼ buttons to highlight an individual CHANNEL option, use the ◀/▶ buttons to change the setting, and press the MENU button to exit.



The CHANNEL menu includes the following options:

Air/Cable

Allows you to select antenna between Air and Cable. If you select "Cable", the following items (Favorite, Show/Hide, Channel NO., Channel Label and DTV Signal) are unable to use.

Auto Scan

Use the ▼ button to highlight the "Auto Scan" item, then press ► button to enter into the following menu.



If you select "Air" as input signal in Antenna item, you can press the ► button to search the channels automatically.



The receivable channels will be stored automatically. When searching channels, press MENU to stop.

Use the ▼ button to highlight the "Auto Scan", then press the ► button to search the channels automatically.

The receivable channels will be stored automatically. When searching channels, press MENU to stop.

Favorite

Allow you to add these channels which you desired as the favorite channels. Use the ▲/▼ buttons to highlight the "Favorite" item, then press the ► button to enter into the following menu.



Use the ▲/▼ buttons to highlight the desired item, then press OK button to add or remove the highlighted channel as favorite.

Channel list

This feature shows the list of stored channels.

Show/Hide

Allow you to show or hide the channels. Use the ▲/▼ buttons to highlight the "Show/Hide" item, then press the ► button to enter into the following menu.



Use the ▲/▼ buttons to highlight the desired item, then press OK button to show or hide the highlighted channel.

Channel No.	Display the number of current channel.
Channel Label	Display the lable of current channel.

5. PC Mode

Setting up your PC software (based on Windows XP)

The Windows display-settings for a typical computer are shown below. But the actual screen on your PC will probably be different, depending upon your particular version of Windows and your particular video card. But even if your actual screen looks different, the same, basic set-up information will apply in almost all cases.

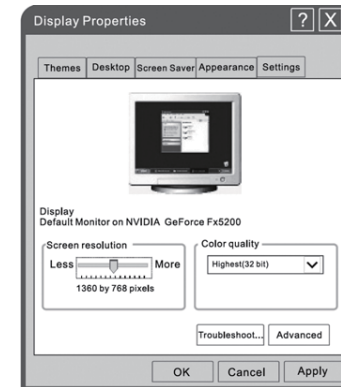

1. First, click on "Control Panel" on the Windows start menu.
2. When the control panel window appears, click on "Appearance and Themes" and a display dialog-box will appear.
3. When the control panel window appears, click on "Display" and a display dialog-box will appear.
4. Navigate to the "Setting" tab on the display dialog-box. The correct size setting (resolution) Optimum: 1360x768.

If a vertical-frequency option exists on your display settings dialog box, the correct value is "60Hz". Otherwise, just click "Enter" and exit the dialog box.

Resolution	Horizontal Frequency (KHz)	Vertical Frequency (Hz)	Standard Mode
720x400	31.47	70	DOS
640x480	37.9	60	VGA
800x600	37.9	60	SVGA
1024x768	48.4	60	XVGA
1366x768	64	60	SXVGA

6.DVD MENU

BASIC OPERATION

1.
Turn the DVD function ON and OFF Turn on the LED TV and then press **Source** repeatedly to select DVD mode.

2.
Insert Disc to DVD Insert the disc in the disc slot (Data side of the disc has to face towards the front of the unit). The player will load the disc automatically and there will be an on screen indication “**Close**” then “**Reading**”. After loading the disc content, it will switch to play mode automatically. If the disc is already placed inside, the disc will be read automatically.

NOTE: For some discs, after loading the content of the disc, you need to press **▶||** or select from the disc menu to start. Please make sure when inserting the disc that the Data side of the disc should be facing you. Inserting the disc incorrectly may damage the DVD mechanism.

3.
Play the DVD According to the disc content, the disc menu will be displayed for your selection. When playing the disc, you may use **▶||** button to toggle between Play and Pause mode. This product also supports Menu, Title, Sequential and Program playback.

4.
Menu playback (for DVD/super VCD and VCD2.0 discs) Press **MENU** button for DVD discs, the screen will display the DVD Disc Menu (Root Menu) for Super VCD & VCD2.0 discs, the screen will display the Super VCD, VCD2.0 Disc Menu (PBC: [OFF]) (Press the **D.MENU** button to display the PBC status). Playback the Super VCD & VCD2.0 discs, the default PBC status is ON. For DVD discs, use the navigation buttons to select and play the highlighted contents; for Super VCD & VCD2.0 discs, use the numeric buttons to select and play your favorite content directly. **NOTE:** PBC should be OFF.

Press **OK** or **▶||** button to start from the highlighted content. Return to the Root Menu when playing the disc. For DVD discs, press **D.MENU** to display the Disc Menu. For Super VCD & VCD2.0 discs, when PBC is ON, press **D.MENU** to display the Disc Menu.

Stop Press **■** button once to stop. Press **▶||** button to resume from where you stopped. Press **■** button twice to stop. Press **▶||** button to start from beginning. In order to protect the disc, press **■** button then press **EJECT** button to take the disc out. When the disc is ejected, handle the disc by the edge only and take it from the eject direction to prevent scratches. When not using the DVD function (in stand-by mode or using other modes for a long time), please take out the disc to protect the DVD loader and the disc.

5.
Title playback (for DVD disc only) Press **Title** button, there will be an on screen indication “**Title**”. Press the direction or numeric buttons to select your favorite title. Then it will play from the first chapter of the selected title

User Manual

SUPPORTING DVD FORMAT

This product can play the following formats of DVD discs.

Disc Type	Disc Size (Diameter)	Recorded Time	Recorded Content	Remarks
DVD	12 cm	Single side: 120 mins. approx	DVD format: Compressed digital audio and video	
		Double side: 240 mins. approx		
Super VCD	12 cm	45 mins. approx	MPEG2 Compressed digital audio and video	Include SVCD
VCD	12 cm	74 mins. approx	PEG1 Compressed digital audio and video	Include: VCD2.0/ VCD1.1 VCD1.0/ DVCD
CD	12 cm	74 mins. approx	CD-DA: Digital audio	
HD-CD	12 cm	74 mins. approx	HD-DA: Digital audio	
MP3/ JPEG	12 cm	600 mins. approx	Digital audio	

NOTE: Also supports DVD-R, CD-R, CD-RW playback.



Warning! Do not insert or play 8cm Disc, they will get stuck.

As it is usual for DVD movies to be released at different times in different regions of the world, all players have region codes and discs can have an optional region code. If you load a disc of a different region code into your player you will see the region code notice on the screen. The disc will not playback and should be unloaded. The region code for this player is 2 (refer to the symbols below).



DVD FUNCTIONS OPERATING INSTRUCTIONS

1. Play (for DVD/Super VCD/CD/CD-G/HD-CD and Mp3/JPEG discs) For DVD disc, press ►|| button from root or title menu; while playing the DVD, you may play your favorite title directly with title selection by pressing the **Title** button. For Super VCD & VCD discs, while playing the disc, you may play your favorite tracks by numeric buttons. For CD, CD-G & HD-CD discs, while playing the disc, you may play your favorite tracks by numeric buttons from the content menu. If input track number is not valid, it will not function. **NOTE:** From track 1-10, use numeric buttons directly; For tracks over 10, e.g. 15, press button **first** and then **5**.
2. Previous/Next (for DVD / Super VCD/VCD/CD/CD-G/HD-CD and Mp3/JEPG discs) While playing the disc; Press ◀◀ button to play to the last Title / Chapter / Track. Press ▶▶ button to play to next Title / Chapter / Track. For super VCD & VCD discs, in PBC OFF status; If the current track is the first one, pressing the ◀◀ button will stop the playback. If the current track is the last one, pressing the ▶▶ button will stop the playback. For DVD discs, the above functions may vary due to different DVD disc structures.
3. Forward/Backward (for DVD/Super VCD/VCD/CD/CD-G/HD-CD and Mp3) While playing the disc, you may use forward or backward function. There are 4 speeds for forward. Press ▶▶▶▶ button to toggle between different speeds in sequence. (FORWARDx2 / FORWARDx8 /FORWARDx20 / Play). While in backward, you may ►|| press to resume normal speed. For CD, HD-CD, Mp3, backward also has audio output (only for BACKWARDx2). For DVD discs, backward to the first title / chapter will start from the beginning. For Super VCD & VCD discs, in PBC ON status, backward to the first track will start from the beginning. **NOTE:** During Forward or Backward, the sound will be off.
4. Pause (for DVD/Super VCD/VCD/CD/CD-G/HD-CD and Mp3/JPEG discs) For CD, CD-G, HD-CD & Mp3/JPEG discs, press ►|| button to pause; press ►|| button to resume. For DVD, Super VCD, VCD discs, press ►|| button to pause; press ►|| button to resume.
5. Repeat (for DVD/Super VCD/VCD/CD/CD-G/HD-CD and Mp3/JPEG discs) Press **Repeat** button once to display the current repeat mode. For Super VCD, VCD, CD, CD-G, HD-CD, discs, while playing in sequence, you may use the repeat playback. There are 2 repeat modes; press **Repeat** to toggle between different modes in sequence. (Repeat (OFF)/Repeat (1)/Repeat (ALL). For DVD discs, you may set up the repeat playback mode. There are 3 repeat modes; press **REPEAT** to toggle between different modes in sequence. (REP: (OFF)/REP:(CHAPTER)/REP:(TITLE)/REP:(ALL). For Mp3 / JPEG discs, while playing the disc, you may use the repeat playback. There are 3 repeat modes; press **REPEAT** to toggle between different modes in sequence. (REPEAT(OFF)/ REPEAT(1)/ REPEAT(DIR)/ REPEAT(ALL).

6. INFO (for DVD/Super VCD/VCD/CD/CD-G/HD-CD and Mp3/JPEG discs) Press **INFO** button to activate the on screen roll-down menu for the current Title, Chapter, time and other information. For DVD discs, (2 pages). Press **INFO** button once to display first page as shown below:

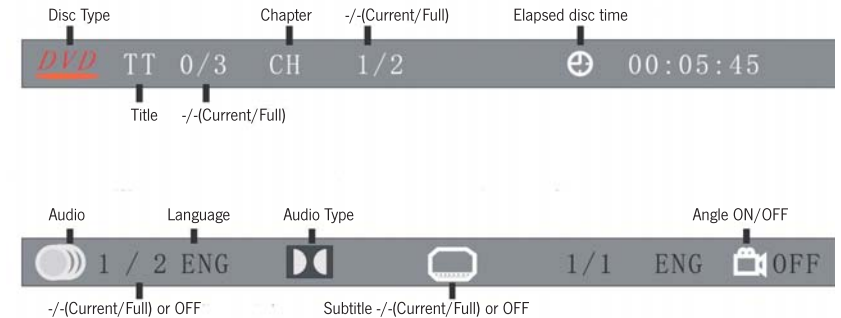

Press the **INFO** button again to turn off the on screen display.

For Super VCD discs, (2 pages). Press **INFO** button once to display first page: Disc type, Track -/-(Current/Full), Mute status, PBC status, Repeat mode status, Current track time. Press **INFO** button again to display second page: Audio -/-(Current/Full) or OFF, Audio type, Language, Subtitle-/(Current/Full) or OFF. Press **INFO** button again to turn off the on screen display.

For CD, CD-G, HD-G, MP3 / JPEG discs, press **INFO** button once to display first page: Disc type, Track -/-(Current / Full), Mute status, Repeat mode statue, Current track time. Press **INFO** button again to turn off the on Screen display.

7. Goto (for DVD/Super VCD/VCD/CD/CD-G/HD-CD and Mp3 discs) This function allows you to play your favorite Title / Chapter / Track. Press **Goto** button to activate the on screen scroll-down menu for editing. According to the highlighted area, input your favorite Title / Chapter / Track number by numeric buttons or input the playback time. After editing, press **OK** to start. If the input is invalid, it will not function. **NOTE:** While editing, the Goto button does not function. If it is in PBC ON status, this function will switch it to OFF.
8. Audio (For VCD/CD/CD-G/HD-CD and Mp3 JPEG discs) Press **Audio** button once to display current audio mode. Press again to toggle between different audio modes in sequence. For CD/VCD/Mp3/HD-CD discs: (stereo/monoL/monoR)
Note: Switching to Auto L / R audio channel may be varied due to different disc contents. Bilingual VCD discs can use **Audio** button to switch between different languages.
9. Mute (for DVD/Super VCD/VCD/CD/CD-G/HD-CD and Mp3/JPEG discs) Press **MUTE** button to mute the audio output. There will be an on screen symbol to indicate "**MUTE**". Press again to cancel, or Press **VOL+** to cancel and adjust the volume. In case there is no audio output, try to press **MUTE** button to cancel mute.

10. Repeat A-B (for DVD/Super VCD/VCD/CD/CD-G/HD-CD and Mp3 discs) When playing DVD, VCD, CD disc, press the **A-B** button to repeat a certain content. Press the **A-B** button at the starting point (A) and the ending point (B) to select the repeat part. Press the **A-B** button a third time to cancel the A-B repeat function and return to normal play.

11. Volume (for DVD/Super VCD/VCD/CD/CD-G/HD-CD and Mp3/JPEG discs) Press **VOL+** / **VOL-** buttons to adjust the output volume.

MP3/JPEG Playback

After loading the Mp3 /JPEG disc, it will start to scan for the stored Mp3/JPEG folders. Then it will firstly display the Mp3 contents automatically and start to play the first file (highlighted file). Screen as follows

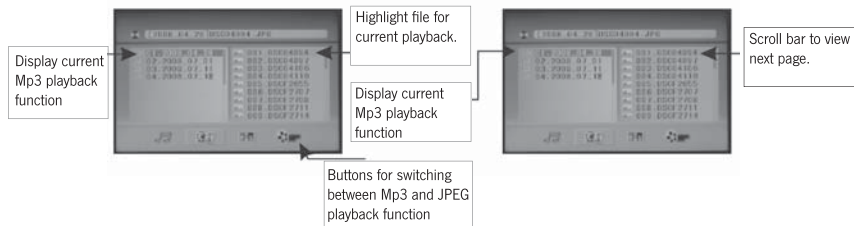

Use the navigation buttons to check your favorite folder and playback the first file or move to your favorite file.

Note: Press buttons to move the highlight to folders, documents or mode selection. Press numeric buttons to select the contents directly. For numbers over 10, e.g. 15, press button 1 and then 5. When playing Mp3 files, there is no picture display, only audio output.

When playing or pausing with picture playback, you may use navigation buttons to flip / rotate the picture.

- ▲ Button to flip horizontally.
- ▼ Button to flip vertically.
- ◀ Button to rotate left 90°.
- ▶ Button to rotate right 90°.

When playing or pausing with picture playback, you may use **D.MENU** button to enter preview mode to display 12 pictures. Press **◀◀◀** / **▶▶▶** button to select next / previous page or press numeric buttons to view the corresponding pictures.

The maximum JPEG image size that can be displayed is 1280 x 1024.

GENERAL SETUP PAGE:

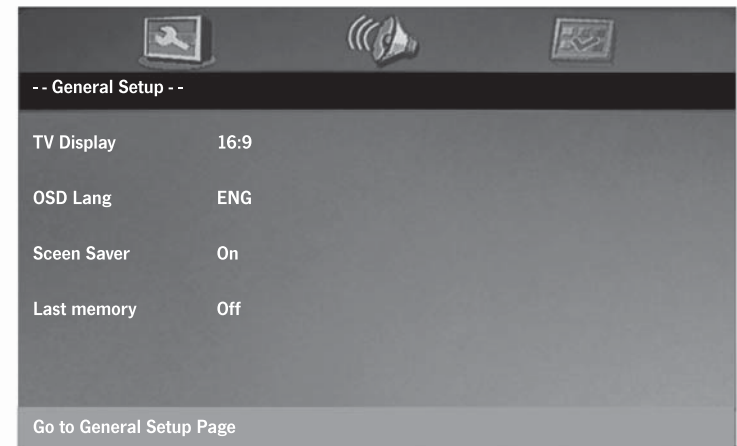

1. If TV Display is selected, press the Navigator **▶** button to enter. Press the Navigator **▲** or **▼** button to set the aspect ratio to 4:3/PS; 4:3/LB or 16:9 to match the aspect ratio of the playing movie or external connected TV.
2. If OSD Lang (On Screen Display) is selected, press the Navigator **▶** button to enter. Press the Navigator **▲** or **▼** button to set the OSD language as desired.
3. If Screen Saver is selected, press the Navigator **▶** button to enter. Press the Navigator **▲** or **▼** button to turn it On or Off.
4. If Last Memory is selected, press the Navigator **▶** button to enter. Press the Navigator **▲** or **▼** button to turn it On or Off.

AUDIO SETUP PAGE:



1. If Speaker Setup is selected, press the Navigator ► button to enter. Press the Navigator ▲ or ▼ button to set the Speaker Setup. Select Downmix level as desired.
2. If Dual Mono is selected, press the Navigator ► button to enter. Press the Navigator ▲ or ▼ button to set the Dual Mono level as desired. You can select four different audio outputs, Stereo, Mono L, Mono R, Mix Mono.
3. If Dynamic is selected, press the Navigator ► button to enter. Press the Navigator ▲ or ▼ button to set the dynamic level as desired.

NOTE: If confirmed, press the OK button to save

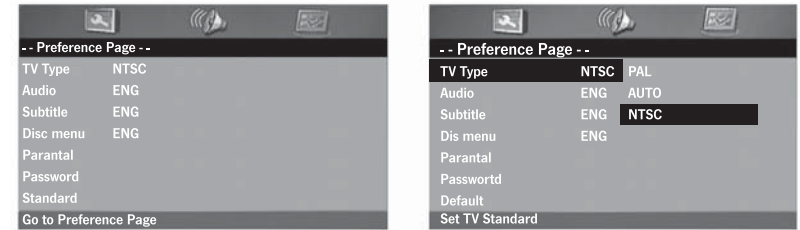

PREFERENCE PAGE::



1. If TV Type is selected, press the Navigator ► button to enter. Press the Navigator ▲ or ▼ button to set the TV Type level as desired.
 - PAL
This is the format used in Europe and the default setting.
 - AUTO
This format can be used if your TV/DVD is capable of both PAL and NTSC formats.
 - NTSC
This format is used by some other countries, e.g. USA
 2. If Audio, Subtitle or Disc Menu is selected, press the Navigator ► button to enter. Press the Navigator ▲ or ▼ button to select and set the language as desired.
 3. If Parental is selected, press the Navigator E button to enter. Press the Navigator ▲ or ▼ button to select the desired level, then press the "OK" button. The Password window will appear on the screen. Enter the four (4) digit password by pressing the numeric buttons (default password is 6090) then press the "OK" button to confirm the selection and exit.
 4. If Password is selected, press the Navigator ► button to enter, then press the "OK" button. The sub-setting menu will appear on the screen. Follow the on screen instructions to set up the new password then press "OK" button to save the settings and exit.
- NOTE: If the new password was forgotten, use the super password 6090 to reset a new password.**
5. If default is selected, press the Navigator ► button to enter. Press the "OK" button to reset all settings to factory default settings or press the **D.SETUP** button to exit without change.

7. TROUBLE SHOOTING

If the device performance fails, check whether the detected problem is in the following table. If your device still fails, contact the customer service.

TV no display, and prompt no signal input, red indicator LED twinkling	- Signal cable is loose or fallen off.	- Check signal cable whether or not loose, fall off, reconnect again.
Remote control distance is short, lose control	- Receive window of remote control was covered by objects. - The battery energy of remote control is too low.	- Remove objects obstructing the receiver window of remote control. - Change battery.
TV display is faint	- Adjustment is incorrect. - Display mode is incorrect.	- Use auto-adjustment function. - Use recommended mode.
TV display image does not fill the screen	- Adjustment is incorrect. - Display mode is incorrect.	- Use auto-adjustment function. - Enter PICTURE to adjust horizontal or vertical position. - Use recommended mode.
Can not operate this machine	- Exterior influence, for example lightning, static electricity and so on, which are possibly to disturb the normal operation of this machine.	- Press  button to turn off electrical source, then press  button to turn on the TV again after 1-2 minutes.

User Manual

Snowflake speckle and sound noise	- Antenna cable connector is loose, cable is damaged. - Antenna cable type is not matching. - Direction or position of antenna is incorrect. - Signal is weak.	- Check the antenna cable connector plug whether or not loose, cable whether or not perfect. - Check antenna cable type (VHF/UHF). - Adjust direction or position of antenna. - Attempt to use signal amplifier.
TV image is better, but has noise	- Antenna cable connector is loose, cable is damaged.	- Check the antenna cable connector plug whether or not loose, check cable condition.
No image. No sound	- Power plug is loose, power cord don't connect well.	- Check power cord whether or not connect well. - Press POWER on panel or remote control. - Check if the  button is on.
TV image has stripes	- Signal is exposed to interference, such as car, neon light, electric blower, etc.	- Don't use electric blower around machine, adjust antenna cable direction to reduce interference.
TV image has shadows	- TV signal is reflected by valley or building. - Direction of antenna is incorrect.	- Use high directional antenna. - Adjust direction of antenna.
TV no sound	- Volume setting is too low. - Sound is muted.	- Adjust volume to proper value. - Press MUTE to eliminate mute.

CAUTION: Don't let your machine display the same picture for a long time, please set up a screen protection procedure. If a high contrast picture remains for a long time, this picture will bring a "leave shadow" in screen. Usually the "leave shadow" will disappear gradually when you turn off the machine power. However, this trouble can't be repaired, which isn't in range of warranty.

8. SPECIFICATIONS

Screen

Model	RLDEDV2813-A-B
TV System	ATSC/NTSC
Maximum Resolution	1366x768
Brightness	200cd/m ²
Static Contrast	3000:1
Response Time	6.5ms
Consumption	<65W
Power Supply	AC 100-120V~ 50/60Hz
Connectivity	Composite Video Input Component Video Input YPbPr PC Video Input (VGA) PC Audio Input HDMI Input RF Antenna Input
	Audio output Stereo R / L Headphones Audio Output Coaxial Digital Audio Output
Data Interface	USB(For service)
Supported System Files	FAT32 and FAT16
Panel	A type

Remote Control

Signal Type	Infrared
Control Distance	8 meters
Control Angle	30° (Horizontal)
Power Supply	AAA 1.5Vx2



Free Manuals Download Website

<http://myh66.com>

<http://usermanuals.us>

<http://www.somanuals.com>

<http://www.4manuals.cc>

<http://www.manual-lib.com>

<http://www.404manual.com>

<http://www.luxmanual.com>

<http://aubethermostatmanual.com>

Golf course search by state

<http://golfingnear.com>

Email search by domain

<http://emailbydomain.com>

Auto manuals search

<http://auto.somanuals.com>

TV manuals search

<http://tv.somanuals.com>