

# PROSCAN

## INSTRUCTION MANUAL

---

Before using the TV, please read this manual thoroughly, and retain it for future reference.



**Model: PLDV321300**



## CONTENTS

1	<b>SAFETY PRECAUTION</b>		1
2	<b>IMPORTANT SAFETY INSTRUCTION</b>		2
3	<b>ACCESSORIES</b>		3
4	<b>GETTING STARTED</b>		3
5	<b>CONTROL REFERENCE GUIDE</b>	Remote Control	4
		Front View	6
		Back View	6
		Side View	7
6	<b>CONNECTIONS</b>	Antenna Connection	8
		AV Connection	8
		YPbPr Connection	9
		HDMI Connection	9
		VGA Connection	10
		Headphone Connection	10
		Power Cord Connection	10
		Coax(SPDIIF) Connection	11
7	<b>WALL MOUNT INSTALLATION</b>		12
8	<b>INITIAL SETUP</b>	Putting The Unit On A Proper Place	13
		Turning The Unit On For The First Time	13
		Source Selection	13
9	<b>TV SETUP</b>	Picture Menu	15
		Audio Menu	17
		Time Menu	19
		Setup Menu	20
		LOCK(Parental) Menu	23
		TV(CHANNEL) Menu	26
		Zoom Function (For DVD)	27

# CONTENTS

10	<b>DISC FORMATS</b>		28
11	<b>CD / DVD OPERATION</b>	Basic Operations Special Functions Mp3 / JPEG Playback	29 32 34
12	<b>CUSTOMIZING THE DVD FUNCTION SETTINGS</b>	DVD Menu	35
13	<b>MAINTENANCE</b>		37
14	<b>DISPLAY MODE</b>	PC Formats Video Formats	38 38
15	<b>SPECIFICATION</b>		40
16	<b>TROUBLE-SHOOTING GUIDE</b>	DVD Symptom TV Symptom	41 42

**SAFETY CLASS :** This is an IEC safety class I product and it must be grounded for safety.

# SAFETY PRECAUTION

\* CAUTION MARKING WAS LOCATED AT THE REAR OF THE APPARATUS. **PLACEMENT INFORMATION**



WARNING: TO REDUCE THE RISK OF ELECTRIC SHOCK, DO NOT REMOVE COVER (OR BACK) NO USER SERVICEABLE PARTS INSIDE. REFER SERVICING TO QUALIFIED SERVICE PERSONNEL.

 The lightning flash with arrowhead symbol, within an equilateral triangle, is intended to alert the user to the presence of uninsulated "dangerous voltage" within the product's enclosure that may be of sufficient magnitude to constitute a risk of electric shock to persons.

 The exclamation point within an equilateral triangle is intended to alert the user to the presence of important operating and maintenance (servicing) instructions in the literature accompanying the appliance.

CAUTION  
INVISIBLE LASER RADIATION WHEN OPEN AND INTERLOCKS DEFEATED  
AVOID EXPOSURE TO BEAM



This product  
Contains a low  
power laser device.

CLASS 1 LASER  
PRODUCT

 **CAUTION**

• DANGER OF EXPLOSION IF BATTERY IS INCORRECTLY REPLACED. REPLACE ONLY WITH THE SAME OR EQUIVALENT TYPE.

• USE OF CONTROLS OR ADJUSTMENTS OR PERFORMANCE OF PROCEDURES OTHER THAN THOSE SPECIFIED MAY RESULT IN HAZARDOUS RADIATION EXPOSURE.

 **WARNING:**

- TO REDUCE THE RISK OF FIRE OR ELECTRIC SHOCK, DO NOT EXPOSE THIS APPLIANCE TO RAIN OR MOISTURE.
- TO REVENT FIRE OR SHOCK HAZARD, DO NOT EXPOSE THIS UNIT TO RAIN OR MOISTURE. DO NOT PLACE OBJECTS FILLED WITH LIQUIDS ON OR NEAR THIS UNIT.
- SHOULD ANY TROUBLE OCCUR, DISCONNECT THE AC POWER CORD AND REFER SERVICING TO A QUALIFIED TECHNICIAN.

- Do not use this unit in places that are extremely hot, cold, dusty or humid.
- Do not restrict the airflow of this unit by placing it somewhere with poor airflow, by covering it with a cloth, by placing it on bedding or carpeting.

## SAFETY INFORMATION

- When connecting or disconnecting the AC power cord, grip the plug and not the cord itself. Pulling the cord may damage it and create a hazard.
- When you are not going to use the unit for a long period of time, disconnect the AC power cord.

## CONDENSATION INFORMATION

- When left in a heated room where it is warm and damp, water droplets or condensation may form inside the equipment. When there is condensation inside the unit, the unit may not function normally. Let the unit stand for 1-2 hours before turning the power on or gradually heat the room and let the unit dry before use.

## RATING PLATE LOCATION

The rating plate is located on the rear of the unit.

## FCC STATEMENTS

NOTE: This unit has been tested and found to comply with the limits for a Class B digital device, pursuant to Part 15 of the FCC Rules. These limits are designed to provide reasonable protection against harmful interference in a residential installation.

This unit generates, uses and can radiate radio frequency energy and, if not installed and used in accordance with the instructions, may cause harmful interference to radio communication. However, there is no guarantee that interference will not occur in a particular installation. If this unit does cause harmful interference to radio or television reception, which can be determined by turning the unit off and on, the user is encouraged to try to correct the interference by one or more of the following measures:

- Reorient or relocate the receiving antenna.
- Increase the separation between the unit and receiver.
- Connect the unit into an outlet on a circuit different from that to which the receiver is connected.
- Consult the dealer or an experienced radio/TV technician for help.



**WARNING:**

Changes or modifications to this unit not expressly approved by the party responsible for compliance could void the user authority to operate the unit.

## IMPORTANT SAFETY INSTRUCTIONS

- 1) Read these instructions.
- 2) Keep these instructions.
- 3) Heed all warnings.
- 4) Follow all instructions.
- 5) Do not use this apparatus near water.
- 6) Clean only with a dry cloth.
- 7) Do not block any ventilation openings.  
Install in accordance with the manufacturer's instructions.
- 8) Do not install near any heat sources such as radiators, heat registers, stoves, or other apparatus (including amplifiers) that produce heat.
- 9) Do not defeat the safety purpose of the polarized or grounding-type plug.  
A polarized plug has two blades with one wider than the other.  
A grounding type plug has two blades and a third grounding prong.  
The wide blade or the third prong is provided for your safety.  
If the provided plug does not fit into your wall outlet, consult an electrician for replacement of the obsolete outlet.
- 10) Protect the power cord from being walked on or pinched particularly at plugs, convenience receptacles, and the point where they exit from the apparatus.
- 11) Only use attachments / accessories specified by the manufacturer.
- 12) Use only with the cart, stand, tripod, bracket, or table specified by the manufacturer, or sold with the apparatus.  
When a cart is used, use caution when moving the cart / apparatus combination to avoid injury from tip-over.
- 13) Unplug this apparatus during lightning Storms or when unused for long periods of time.
- 14) Refer all servicing to qualified service personnel. Servicing is required when the apparatus has been damaged in any way, such as the power cord or plug is damaged, liquid has been spilled or objects have fallen into the apparatus, the apparatus has been exposed to rain or moisture, does not operate normally, or has been dropped.
- 15) To prevent electric shock, ensure the grounding pin on the AC cord power plug is securely connected.



# ACCESSORIES

Please check and identify the supplied accessories.

Remote control .....	x 1
Battery(AA) .....	x 2
Warranty Card .....	x 1
Instruction Manual.....	x 1
Base stand and 5 screws .....	x 1
Screw driver .....	x 1

# GETTING STARTED

## USING THE REMOTE CONTROL

- Point the remote control at the remote sensor located on the unit.
- When there is a strong ambient light source, the performance of the infrared remote sensor may be degraded, causing unreliable operation.
- The recommended effective distance for remote operation is about 16 feet (5 meters).

## TO INSTALL THE BATTERIES

1. Open the battery door.



2. Insert 2 "AA" batteries

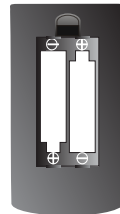

## BATTERY REPLACEMENT

When the batteries become weak, the operating distance of the remote control is greatly reduced and you will need to replace the batteries.

**CAUTION** : Danger of explosion if battery is incorrectly replaced.

## NOTES

- If the remote control is not going to be used for a long time, remove the batteries to avoid damage caused by battery leakage corrosion.
- Do not mix old and new batteries. Do not mix ALKALINE, standard (CARBON-ZINC) or rechargeable (NICKEL-CADMIUM) batteries.
- Always remove batteries as soon as they become weak.
- Weak batteries can leak and severely damage the remote control.

**WARNING** :  
Do not dispose batteries in a fire. Batteries may explode or leak.  
Batteries shall not be exposed to excessive heat such as sunshine, fire or the like.

# CONTROL REFERENCE GUIDE

## REMOTE CONTROL

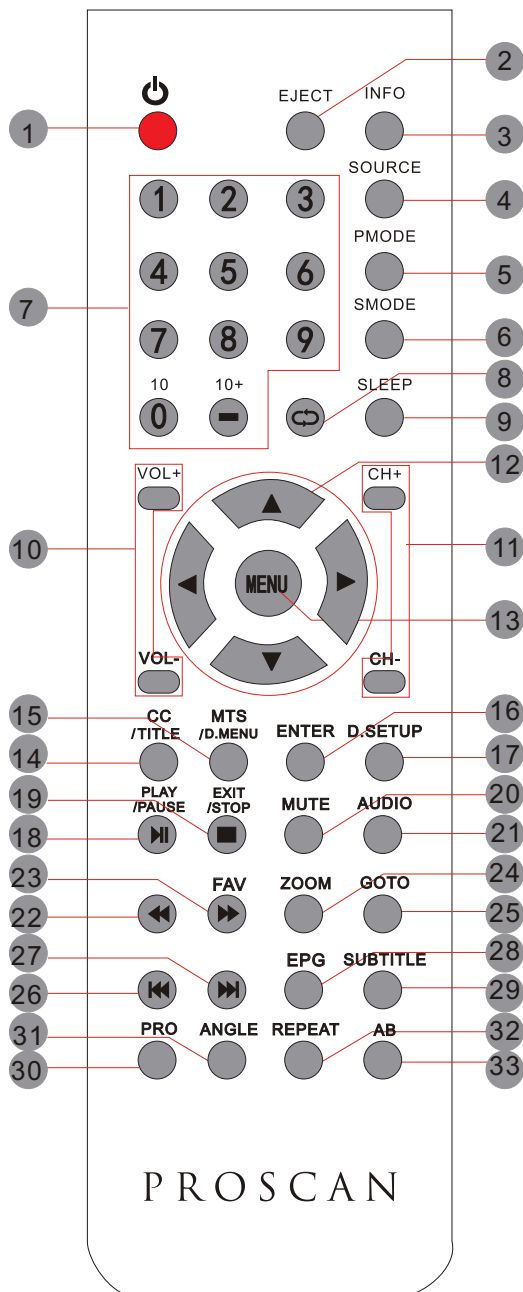

Universal Remote Code: 1218  
(Universal Remote Control is not included)

### 1. STANDBY

To switch on the TV or make the TV into standby mode.

### 2. EJECT

To eject a disc.

### 3. INFO

Show the information of the program you are watching.

### 4. SOURCE

Press this button to select an input source.

### 5. P.MODE

Press this button to select a picture mode for different picture qualities.

### 6. S.MODE

Press this button to select sound setting for different sound effects.

### 7. 0-9

Allows you to change the channel of the TV.

### 8. ↺

Switches back and forth between the current and previous channels.

### 9. SLEEP

To select the amount of time before your TV turns Off automatically.

### 10. VOL+/VOL-

Increases/Decreases the Volume control.

### 11. CH+/CH-

Skips to the next/previous channel on TV mode.

### 12. UP/DOWN/LEFT/RIGHT

Moves the cursor upward/downward/to the left/to the right when making a selection.

### 13. MENU

Displays the OSD Menu of the TV.

### 14. CC

Press the button to enter into the CC mode.

### TITLE

To goto the title menu if the DVD disc has a title page.

### 15. MTS

To change among STEREO, MONO and SAP. If there is no second language available for the signal received, LED Display audio will output to mono.

### D. MENU

To show the menu of the DVD disc.

# CONTROL REFERENCE GUIDE

## REMOTE CONTROL

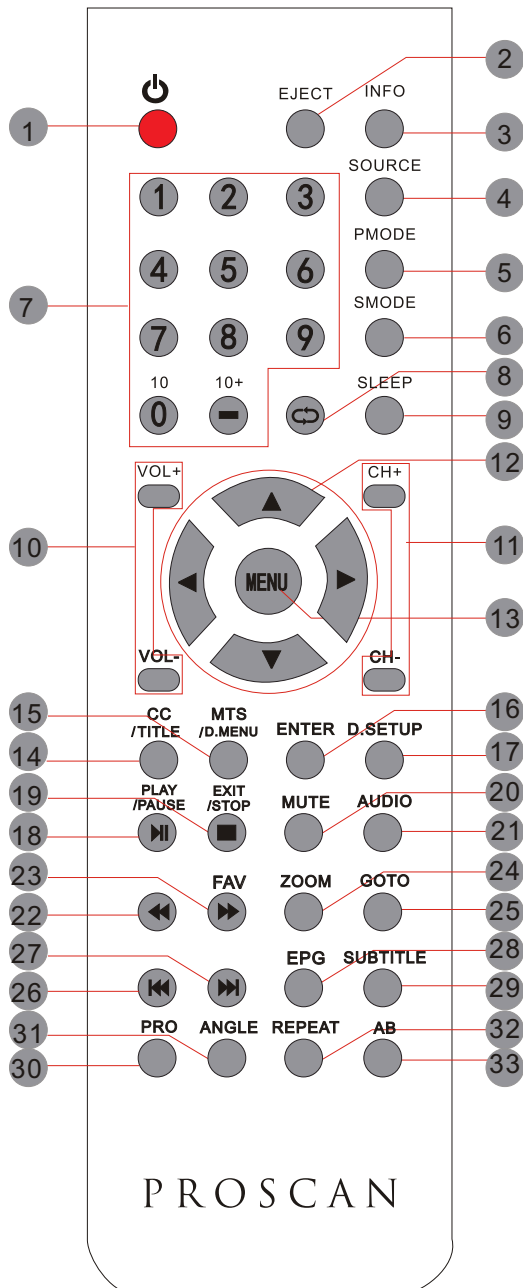

Universal Remote Code: 1218  
(Universal Remote Control is not included)

- 16. ENTER  
Press to confirm selections on a menu screen.
- 17. D.SETUP  
Press this button to show the DVD SETUP menu.
- 18. Play/Pause  
Press this button to play or pause the DVD you're watching.
- 19. Exit  
Press this button to exit the on screen display.
- Stop  
Press this button to stop playing the DVD you're watching.
- 20. MUTE  
Press this button to mute or restore sound.
- 21. AUDIO  
Press this button to change the audio language of the DVD.
- 22. ⏮  
Fast reverse in DVD mode.
- 23. ⏭  
Fast forward in DVD mode.
- FAV  
Press this button enter the favourite list.
- 24. ZOOM  
To select a screen display size on your TV in DVD mode.
- 25. GOTO  
Press this button to start playing the disc program from the time you want.
- 26. ⏪  
Previous chapter in DVD mode.
- 27. ⏩  
Next chapter in DVD mode.
- 28. EPG  
Press this button to select the electronic programme guide.
- 29. SUBTITLE  
To show the subtitle for the program you're watching.
- 30. PRO  
To edit the program list of your DVD disc in DVD mode.
- 31. ANGLE  
To select different angles to which the picture suits your preference.
- 32. REPEAT  
Press this button for repeat the program.
- 33. AB  
Press this button for repeat play point A and B.



# CONTROL REFERENCE GUIDE

## FRONT VIEW

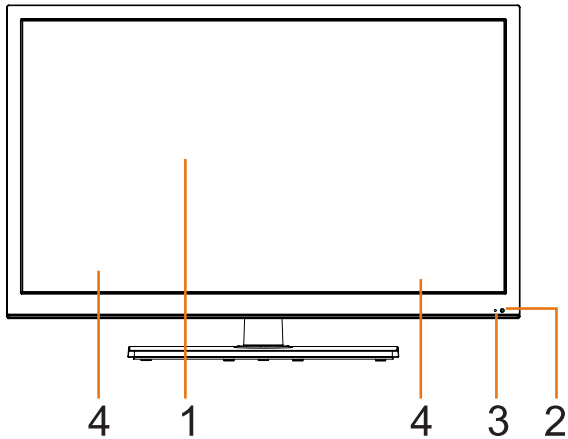

1. Color Screen
2. Remote Sensor  
Do not block this sensor or the remote control will not work.
3. Standby Indicator  
Indicates whether the unit is ON or in STANDBY (OFF) mode.  
Light in red: The unit is in STANDBY.  
Light in blue: The unit is turned ON.
4. Speakers

## BACK VIEW

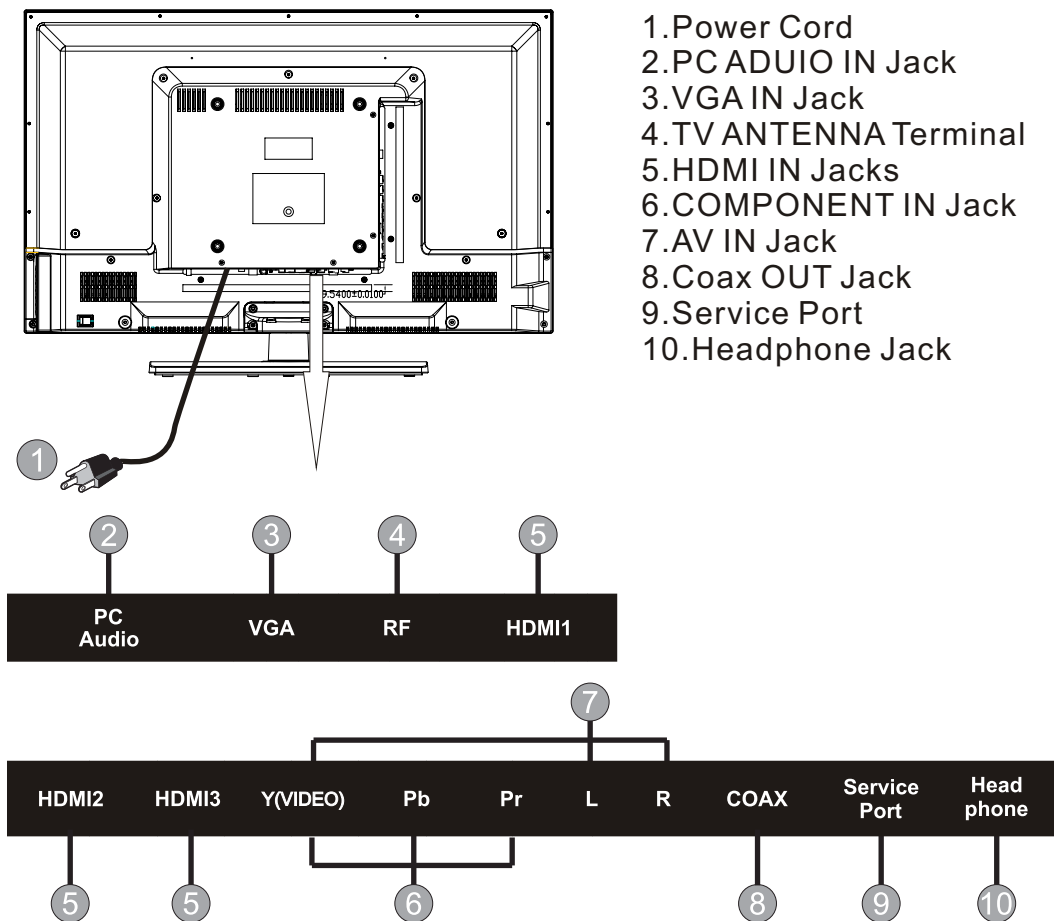

# CONTROL REFERENCE GUIDE

## SIDE VIEW

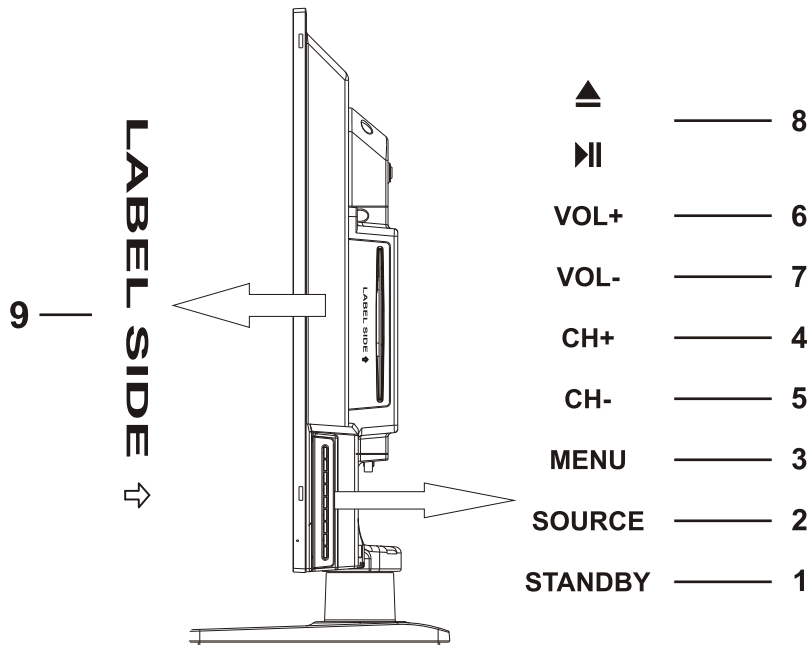

### 1. STANDBY Button

Press to turn the unit on and off.

### 2. SOURCE Button

Press to select the input source of the TV.

### 3. MENU Button

Press to display the on-screen TV menu.

### 4. CH- Button

Press to change the TV channels and down highlight selections on the menu screen.

### 5. CH+ Button

Press to change the TV channels and up highlight selections on the menu screen.

### 6. VOL- Button

Press to adjust the volume down.

### 7. VOL+ Button

Press to adjust the volume up.

### 8.



Press to eject a disc.



Press this start pause or resume playback of a disc.

### 9. Disc Slot

Insert discs to disc slot

Note: When inserting a disc, please take note of the indication of direction around the disc slot for operation.

(Right direction: put the mirror side of the disc facing yourself)

# CONNECTIONS

## CONNECTING A TV ANTENNA / CABLE / SATELLITE

To view television channels correctly, a signal must be received from one of the following sources:

- An indoor or outdoor aerial antenna
- A cable system
- A satellite system

### NOTE

For receiving over-the-air TV broadcasts, we recommend that you use an external fixed antenna. Should you require the use of a temporary antenna, please ensure that you purchase an antenna with sufficient ability to receive in weak signal areas. Only when you are in close proximity to a transmitter will a temporary antenna reproduce a signal as strongly as a fixed antenna.

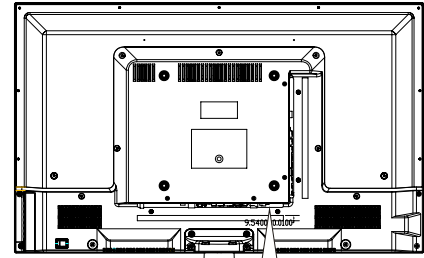

Satellite, cable or TV antenna cable to TV ANTENNA terminal (cable not included)

## CONNECTING AN A/V DEVICE

To connect to other equipment such as a VCR, camcorder, satellite system or cable, etc.

## CONNECTING DEVICES WITH A COMPOSITE (YELLOW RCA-TYPE) VIDEO OUTPUT

To connect A/V devices such as a VCR, video game system or camcorder.

### Connecting to a VCR / Video Game System / Camcorder

Connect the AUDIO / VIDEO cable (not included) as shown.

Make sure you connect the cable from the other equipment ( **AUDIO** and **VIDEO OUT** ) to this unit (AV in)

### NOTE

Please refer to the user manual for the other equipment for more information.

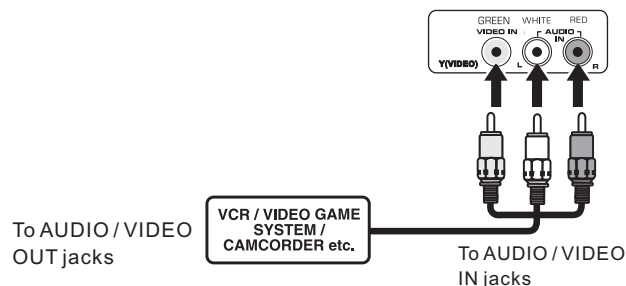
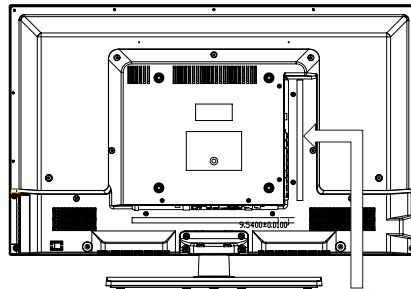

# CONNECTIONS

## CONNECTING A HIGH-DEFINITION (HD) SOURCE USING COMPONENT CONNECTION

High-Definition (HD) Devices with component video output must be connected to the YPbPr input.

Connect the component video cable and audio cable (not included) as shown.

Make sure you connect the component video cable and audio cable from the other equipment (COMPONENT OUT and AUDIO OUT) to the unit COMPONENT IN.

### NOTE

When connecting a DVD player to the television, the picture resolution is solely dependent upon the resolution supported by the DVD player attached. DVD player resolutions vary from 480i to 1080i, and this television can support DVD players up to a maximum resolution of 1080i.

\* May require a subscription for receiving HD channels, check with your cable/satellite service provider for details.

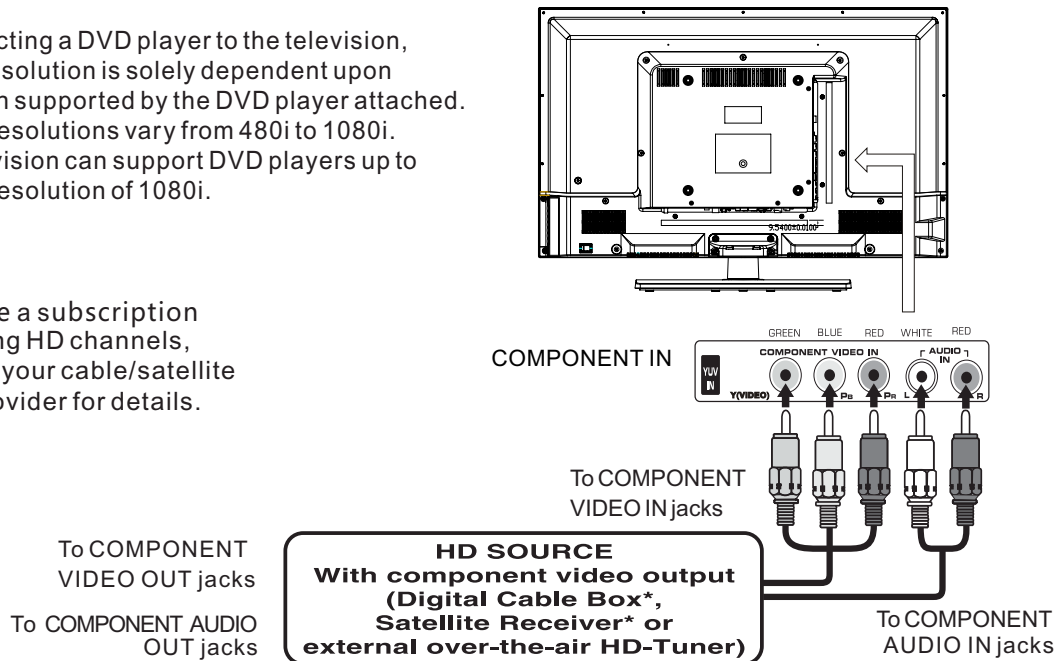

## CONNECTING A HIGH-DEFINITION (HD) SOURCE USING HDMI CONNECTION

HDMI (High Definition Multimedia Interface) supports both video and audio on a single digital connection for use with DVD players, DTV, set-top boxes and other digital AV devices. HDMI was developed to provide the technologies of High Bandwidth Digital Content Protection (HDCP) as well as Digital Visual Interface (DVI) in one specification. HDCP is used to protect digital content transmitted and received by DVI-compliant or HDMI-compliant displays.

HDMI has the capability to support standard, enhanced or high-definition video plus standard to multi-channel surround-sound audio. HDMI features include uncompressed digital video, a bandwidth of up to 2.2 gigabytes per second (with HDTV signals), one connector (instead of several cables and connectors), and communication between the AV source and AV devices such as DTVs.

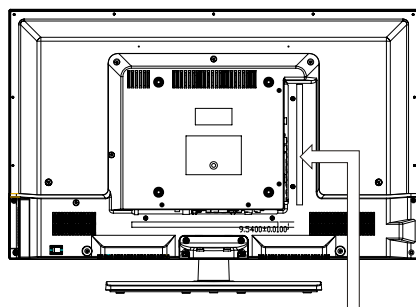

Connect the HDMI cable (not included) as shown:

Make sure you connect the cable from the source equipment (HDMI OUT) to this unit (HDMI IN).

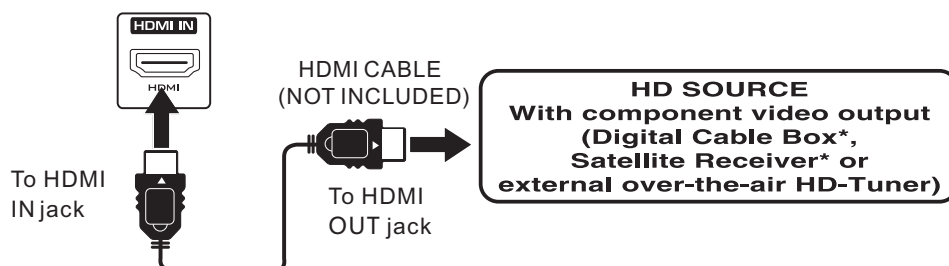

# CONNECTIONS

## CONNECTING A PC

Connect the 15-pin D-SUB PC/VGA connector from your computer to the 15-pin D-SUB PC/VGA input on this unit using a monitor cable and an audio cable (not included) as shown.

Make sure you connect the cable from the computer (VGA and AUDIO - PC OUT ) to this unit (VGA and AUDIO - PC IN ).

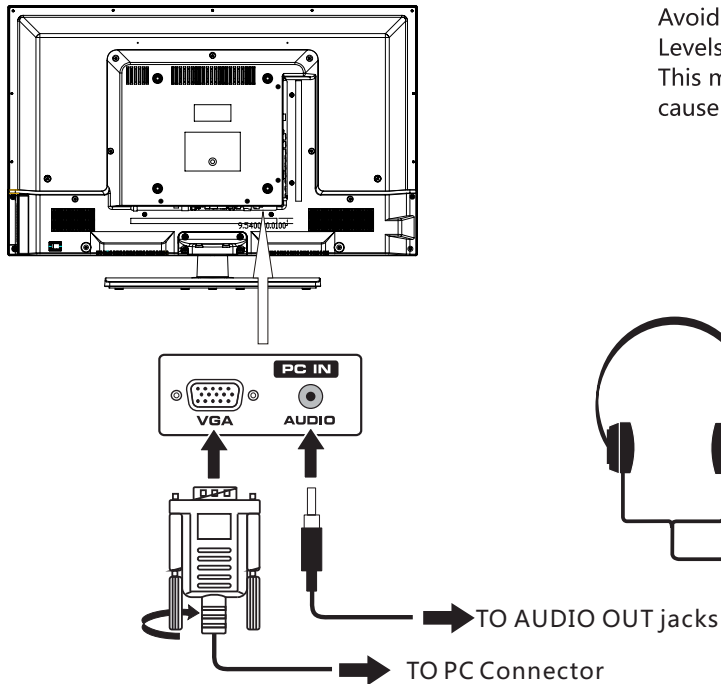

## CONNECTING HEADPHONES

- Turn down the volume before connecting headphones to the unit, then adjust the volume to your desired level.
- When headphones are connected, no sound will come from the front speakers.

### NOTE

Avoiding listening to sound at high Levels for prolonged period of time. This may be harmful to you and may cause hearing loss.

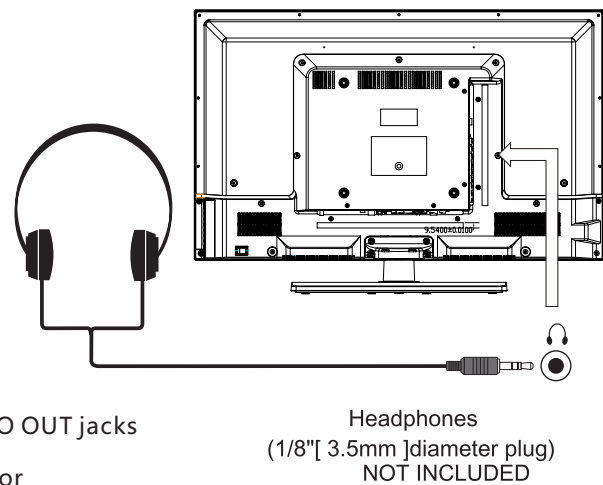

## CONNECTING THE POWER CORD

You can power on your TV unit before you make sure the power cord is inserted well. At the same time, please check that the rated voltage of your unit matches your local Voltage.

### NOTE

- Insert the power plug fully into the socket outlet. (If the power plug is loose, it could generate heat and cause fire.)
- Ensure that the power plug is easily accessible.
- Ensure the earth pin on the power plug is securely connected to prevent electrical shock.
- Do not touch the power plug with a wet hand. (This may cause electrical shock.)
- Do not use any power cord other than that provided with this TV. (This may cause fire or electrical shock.)
- Do not damage the power cord. (A damaged cord may cause fire or electrical shock.)
- Do not move the TV with the cord plugged in the socket outlet.
- Do not place a heavy object on the cord or place the cord near a high-temperature object.
- Do not twist the cord, bend it excessively, or stretch it.
- Do not pull on the cord. Hold onto the power plug body when disconnecting cord.
- Do not use a damaged power plug or socket outlet.

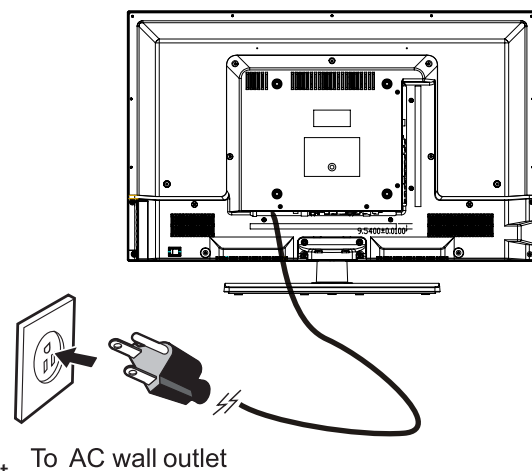

# CONNECTIONS

## Connection to a Home Theater Audio System

### For BEST audio performance

Connecting to a Home Theater System  
Dolby Digital can deliver optimal 2 channel stereo or surround sound with five discrete full range channels plus a sixth channel for a subwoofer.

Enjoy optimal sound reproduction from your system with a Dolby Digital amplifier that incorporates a digital coaxial input. Connect an optional digital cable directly to the television's Coax audio output to listen through all inputs except VGA.  
(The VGA does not support digital audio)

### How To Setup Digital Output

Press the MENU button on the remote control  
Press the right ► arrow button to select AUDIO  
Press the down ▼ arrow button to highlight SPDIF type right ► Raw or PCM

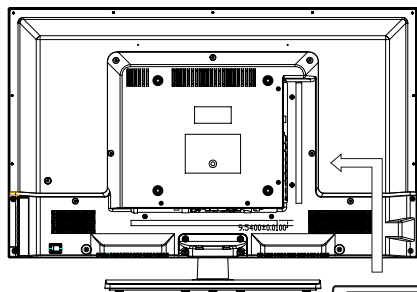

optional digital cable

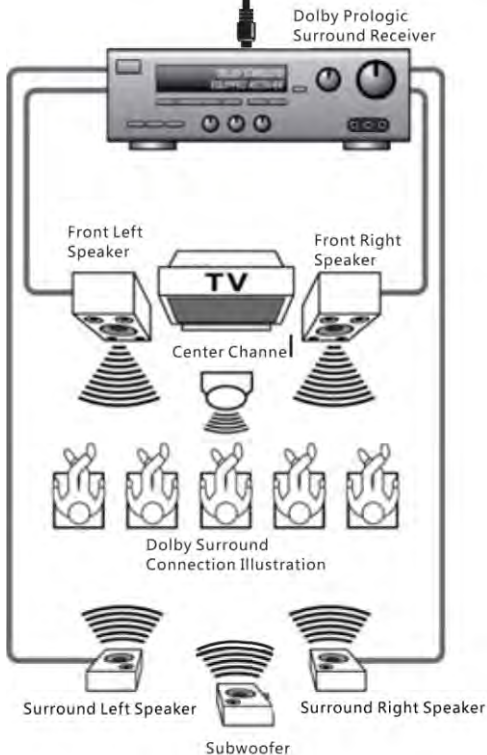

\*NOTE: Refer to the User Manual from your home theater equipment for recommended audio settings.

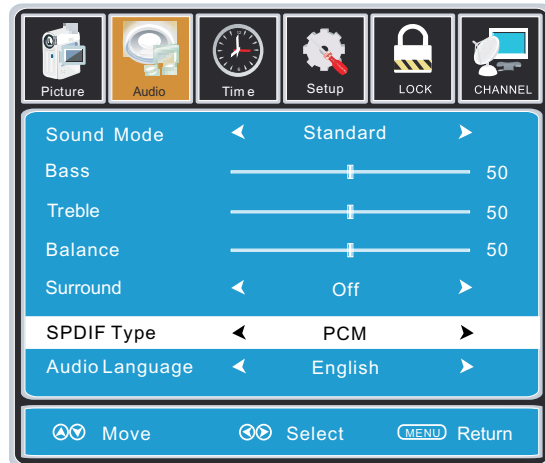

# WALL MOUNT INSTALLATION

## INSTALLING / REMOVING THE BASE STAND

**WARNING :** The TV Display is very fragile and must be protected at all times when removing the base Stand.

Be sure that no hard or sharp object or anything that could scratch or damage the TV display comes into contact with it. Do NOT exert pressure on the front of the unit at any time because the screen could crack.

- 1 Disconnect all cables or cords connected to the unit.
- 2 Lay the unit down on a flat surface with the back side facing up. Please make sure to place a soft cushioned material( such as a pillow or thick piece of foam )beneath the screen.
3. To remove the base stand , loosen screws off the holes then pull downwards to release the base stand.

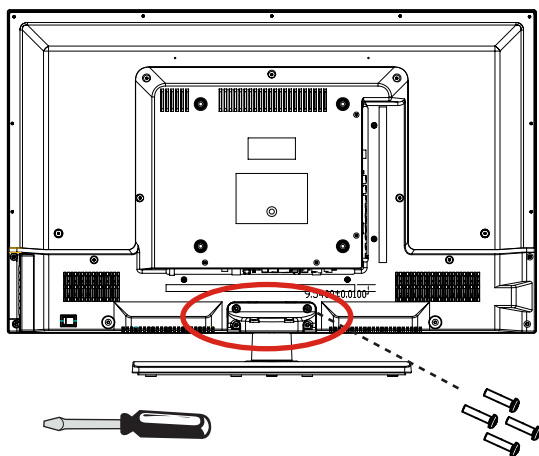

## MOUNTING ON THE WALL

This unit is VESA-compliant, and is designed to be wall-mounted with a VESA-compliant 8" x 8" (200mm x 200mm) mounting kit designed for flat-panel TV's (not supplied). Mount this unit according to the instructions included in the mounting kit. Length of screw should not exceed 8 mm.

## NOTE

Remove the base stand before mounting the unit on the wall.

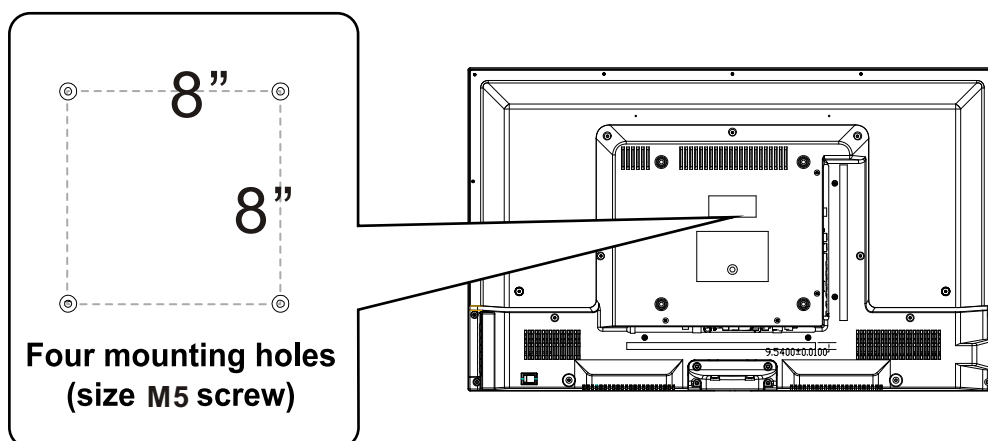

# INITIAL SETUP

## PUTTING THE UNIT ON A PROPER PLACE

When you turn on your television set for the first time, be sure to place it on a solid stable surface.

To avoid danger, do not expose the TV to water, or a heat source (e.g. lamp, candle, radiator).

Do not obstruct the ventilation grid at the rear and be sure to leave sufficient gaps around the unit.



## TURNING THE UNIT ON FOR THE FIRST TIME

After you have initially connected your TV antenna or cable, turn the television ON.

A screen will display asking you to run a **Channel Auto Scan** to search and receive available local digital channels.

It is here where you will select antenna options and run **Channel Auto Scan**.

Channels will be stored in the TV tuner.

Press the **MENU** button on the remote control. Using the ◀▶ buttons, scroll to highlight channel mode. Press the ▼ button to highlight AIR/CABLE.

Please run  
**Channel Auto Scan**

## SOURCE SELECTION

1. Press the **SOURCE** button on the remote control.
2. Use the ▲ or ▼ button to select the options (TV, YPbPr/AV, DVD, HDMI1, HDMI2, HDMI3, VGA)

and select any of them using the ▶ button or the **ENTER** button.  
(The screen will change to your desired source).

Note:

Before watching please make sure all necessary cables and devices are connected.

INPUT SOURCE

TV  
YPbPr/AV  
DVD  
HDMI1  
HDMI2  
HDMI3  
VGA



# INITIAL SETUP

## How to Navigate

**Air Mode:** Select **AIR** when connected to an indoor/outdoor antenna.



Press the ▼ button to highlight **AIR**.

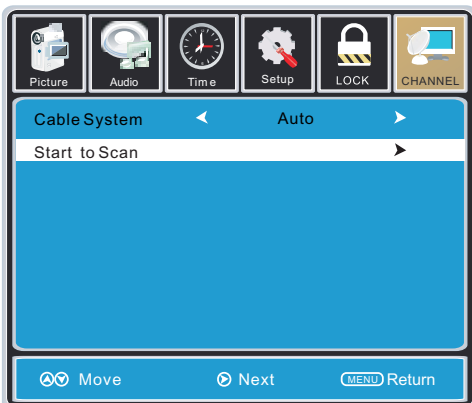

Press the ▼ button to select **AUTO SCAN** then press the ► button to enter the submenu and press the ► button to start Channel Auto Scan.

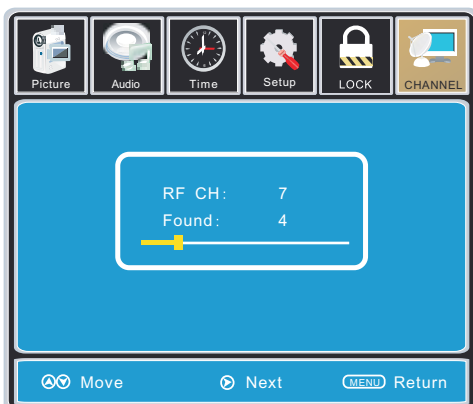

Channel Auto Scan may take several minutes to complete.

**NOTE:** For cable or satellite users with no TV antenna, there no need to run Channel Auto Scan. Connect your cable or satellite set top box to one of the available inputs on the TV for viewing.

**Cable Mode:** Select **CABLE** if you subscribe to a pay television service including satellite.

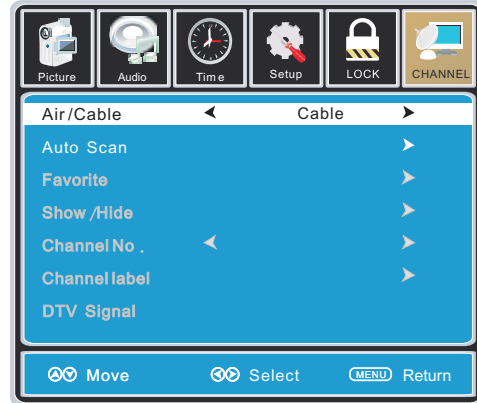

Using the ◀▶ button to highlight **CABLE**.

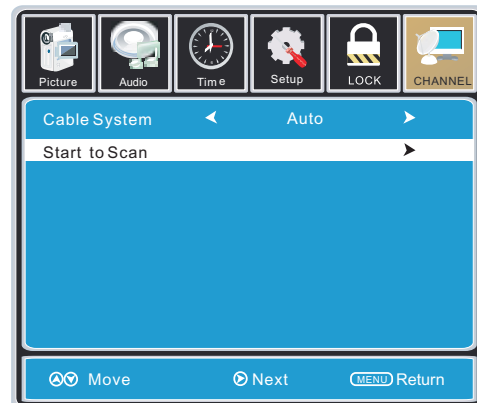

Press the ▼ button to select **AUTOSCAN**. Press the ENTER button and the cursor will move up and **CABLE SYSTEM** will be displayed next. Press ► the button to select **STD > IRC > HRC > Auto** (Auto is recommended). Press the ▼ button to select **Start to Scan** and press ENTER to start Channel Auto Scan.

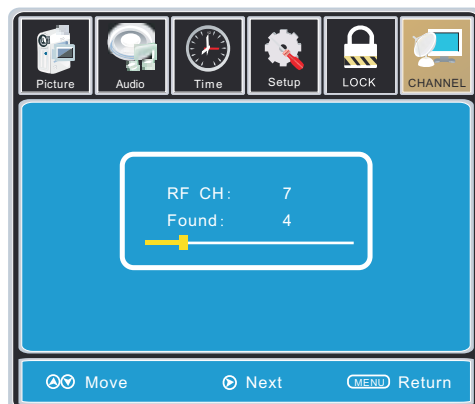

Channel Auto Scan may take several minutes to complete.

# TV SETUP



## PICTURE MENU

The **PICTURE** menu offers options to enhance and refine the picture displayed on your TV based on ambient room light and personal preferences. Adjustment options include contrast, brightness, color, tint, sharpness and Color Temp.

### How to Navigate:

Press the MENU button on the remote control. Navigate using the ◀▶ buttons to select PICTURE.

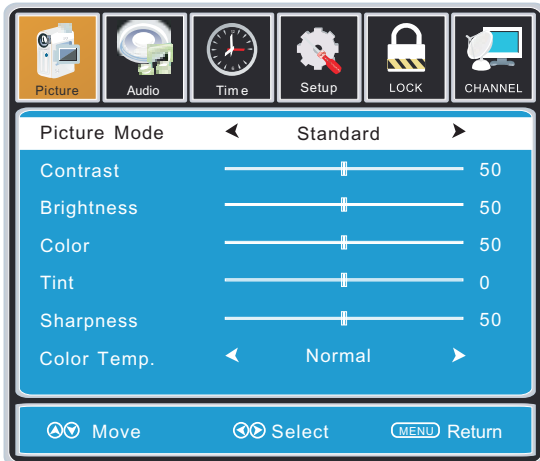

Press the ▼ button to highlight, then press the ▶ button to select your viewing preference from 4 factory options: STANDARD > DYNAMIC > MILD > USER.

The STANDARD setting is recommended for most viewing environments.

Depending on the ambient light level in the room, you may find one of the other options more pleasing.

### To make more critical picture adjustments based on your own preferences in USER:

Use the ▼ button to highlight Contrast. Navigate using the ◀▶ buttons to increase or decrease contrast intensity.



Use the ▼ button to highlight Brightness. Navigate using the ◀▶ buttons to increase or decrease overall brightness.

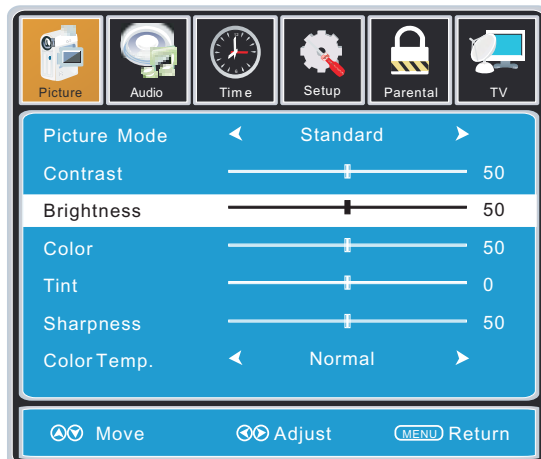

# TV SETUP



## PICTURE MENU

The **PICTURE** menu offers options to enhance and refine the picture displayed on your TV based on ambient room light and personal preferences. Adjustment options include contrast, brightness, color, tint, sharpness and color temp.

Press the MENU button on the remote control. Navigate using the ◀▶ buttons to select PICTURE.

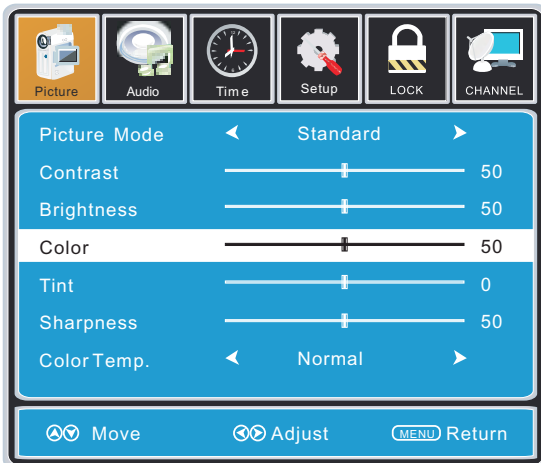

Use the ▼ button to highlight Color. Navigate using the ◀▶ buttons to increase or decrease color intensity.

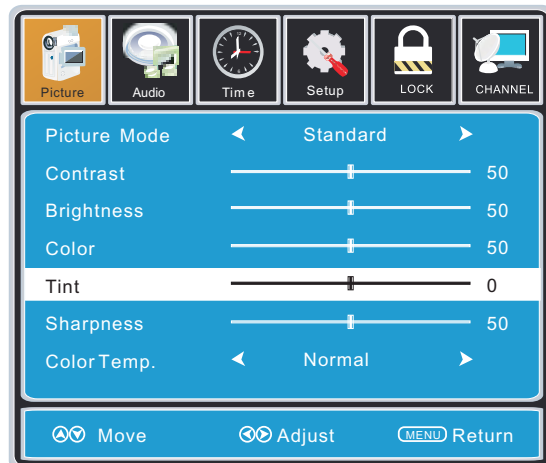

Use the ▼ button to highlight Tint. Navigate using the ◀▶ buttons to adjust colors toward green or reddish tint.

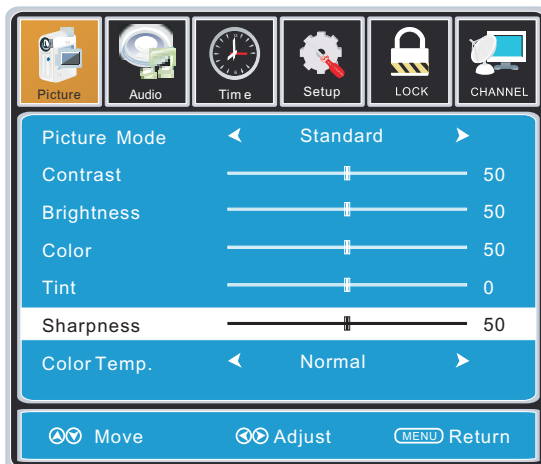

Use the ▼ button to highlight Sharpness. Navigate using the ◀▶ buttons to soften or view crisper edges in the picture.

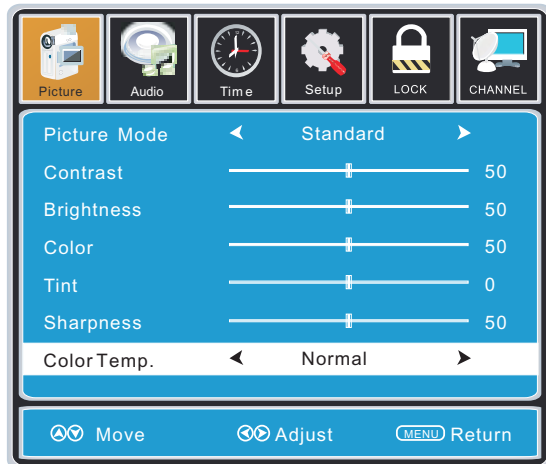

Use the ▼ button to highlight Color Temp. Navigate using the ◀▶ buttons to select COOL (more bluish tone), NORMAL or WARM. The default setting is NORMAL. WARM mode will provide color that is calibrated to D6500° Kelvin, the standard color that broadcast stations and the Motion Picture industry consider as the most accurate to view programming.

### Note:

When adjustments are completed, you may select another menu by pressing the Menu button.

# TV SETUP



## AUDIO MENU

The **AUDIO** menu offers options to make sound enhancements while listening through the built-in speakers and personal preferences. Adjustment options include bass, treble, balance, surround, SPDIF Type and audio language.

### How to Navigate:

Press the MENU button on the remote control. Navigate using the ◀▶ buttons to select AUDIO.



Press the ▼ button to highlight SoundMode, then press the ▶ button to select your sound preference from 4 factory options: STANDARD > MUSIC > MOVIE > USER.

The STANDARD setting is recommended for most sound environments.

Depending on the surroundings in the room, you may find one of the other options more pleasing.

### To make more critical audio adjustments based on your own preferences in USER:

Use the ▼ button to highlight Bass. Navigate using the ◀▶ buttons to increase or decrease low frequency intensity.

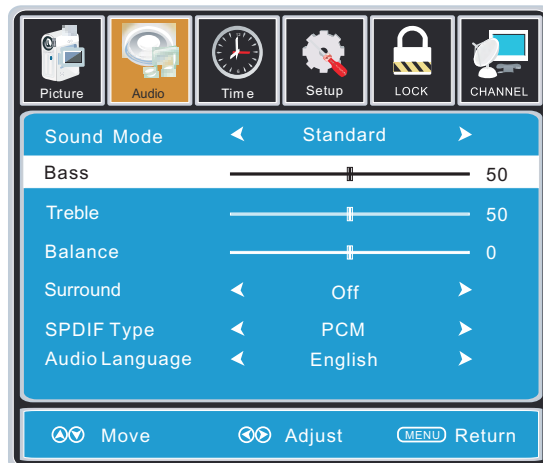

Use the ▼ button to highlight Treble. Navigate using the ◀▶ buttons to increase or decrease high frequency intensity.

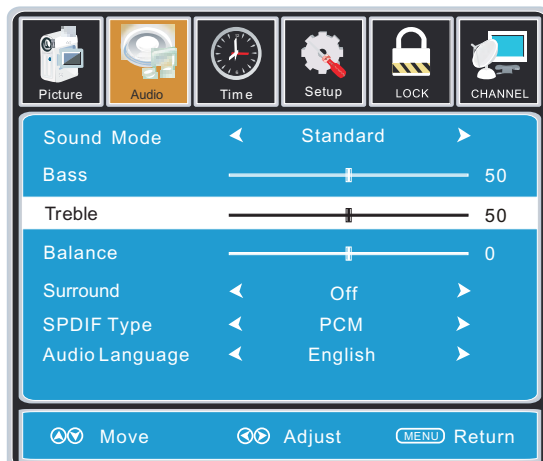

# TV SETUP



## AUDIO MENU

The **AUDIO** menu offers options to make sound enhancements while listening through the built-in speakers and personal preferences.

Adjustment options include bass, treble, balance, surround, SPDIF Type and audio language.

### How to Navigate:

Press the MENU button on the remote control. Navigate using the ◀▶ buttons to select AUDIO.

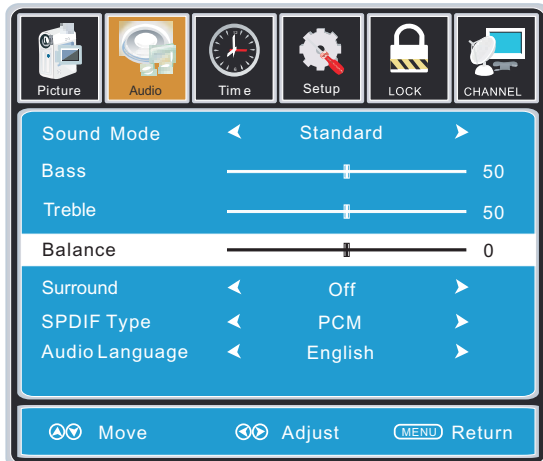

Use the ▼ button to highlight Balance. Navigate using the ◀▶ buttons to adjust sound towards the right or left speaker.



Use the ▼ button to highlight Surround. Navigate using the ▶ button to turn the dimensional surround effect ON or OFF. (for built-in speakers only).

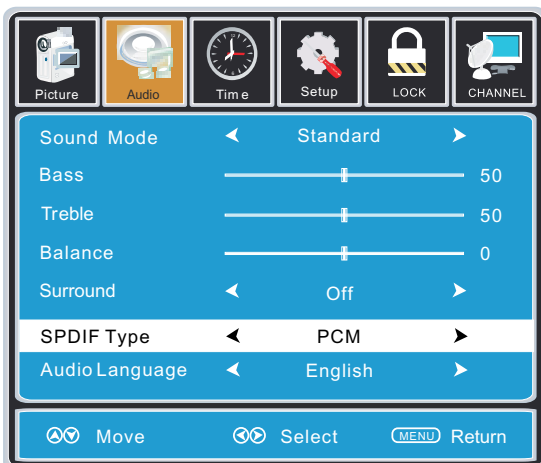

Use the ▼ button to highlight SPDIF Type. Navigate using the ▶ button to adjust.

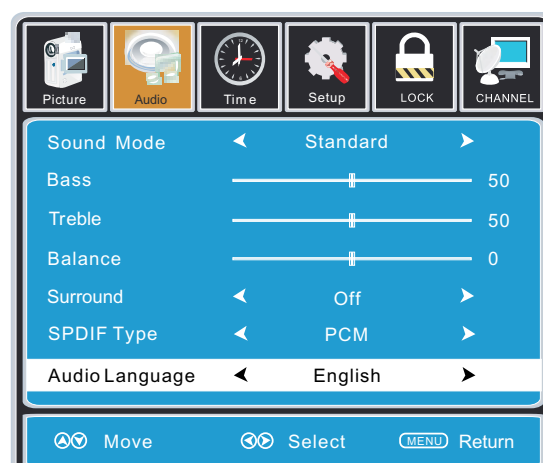

Use the ▼ button to highlight Audio Language. Navigate using the ◀▶ buttons to select to an alternative language broadcast (if available) English > French > Spanish. You may select an alternative language using the remote control by pressing MTS)

### Note:

When adjustments are completed, you may select another menu by pressing the Menu button.

# TV SETUP

## TIME MENU

The **TIME** menu includes adjustment of settings for your local time zone and daylight savings time. The clock will adjust automatically after the initial Channel Auto Scan of available broadcast channels in your area.

### How to Navigate:

Press the MENU button on the remote control. Navigate using the ◀▶ buttons to select TIME.

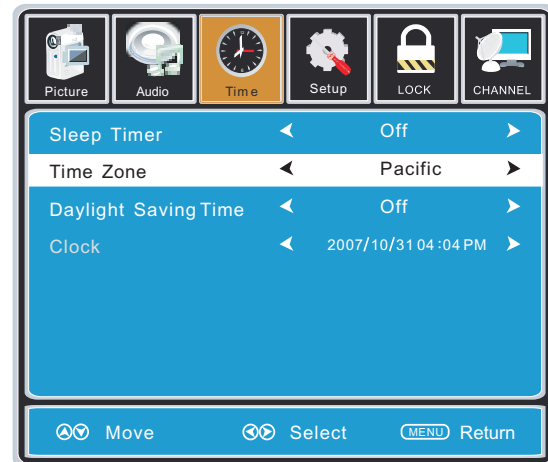
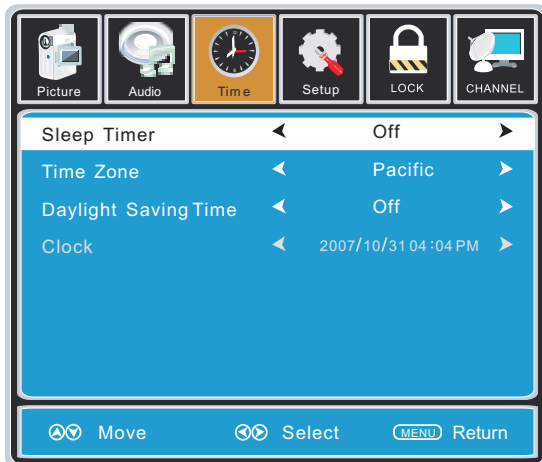

Use the ▼ button to highlight SleepTimer, then press the ▶ button to select among: 5min, 10min, 15min, 30min, 45min, 60min, 90min, 120min, 180min, 240min and off.

Use the ▼ button to highlight TimeZone, then press the ▶ button to select among: EASTERN > CENTRAL > MOUNTAIN > PACIFIC > ALASKA > HAWAII.

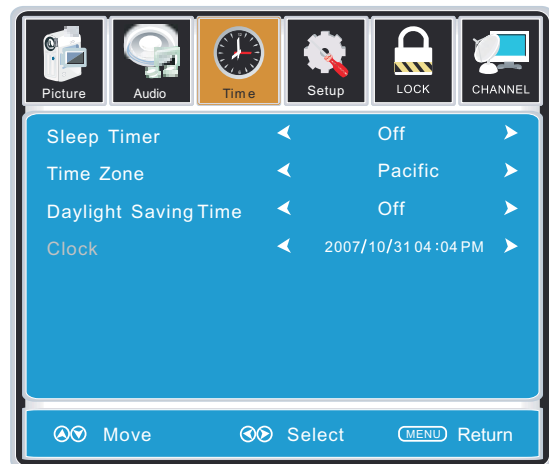
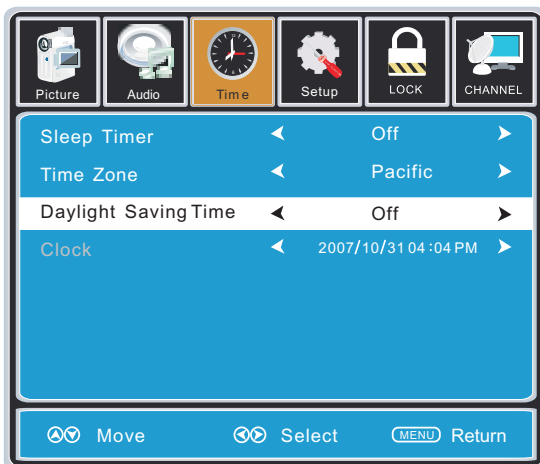

Use the ▼ button to highlight Daylight Saving Time. Navigate using the ◀▶ buttons to turn this feature on or off.

Clock: Display the time at present.

### Note:

When adjustments are completed, you may select another menu by pressing the **Menu** button.

# TV SETUP



## SETUP MENU

In the **SETUP** menu you may change the initial set up of preferences that include settings for language, menu display, computer monitoring, closed captions, enhancement of black detail in the picture and resetting your TV back to its factory default status.

### How to Navigate:

Press the MENU button on the remote control. Navigate using the ◀▶ buttons to select **SETUP**.

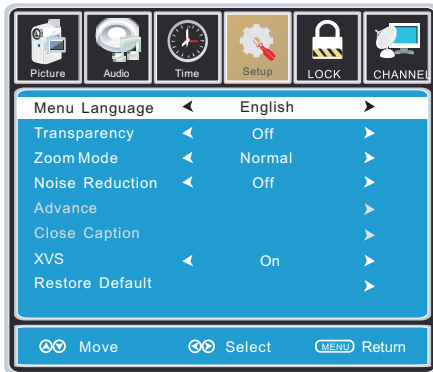

Use the ▼ button to highlight Menu Language. Press the ▶ button to select the language you prefer among English, French and Spanish.

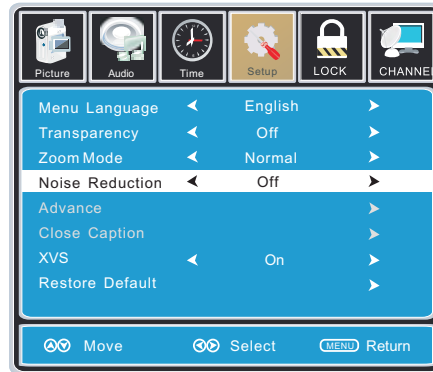

Use the ▼ button to highlight Noise Reduction. Navigate using the ◀▶ buttons to reduce video noise: Middle > Strong > Off > Weak (Default setting: Middle)

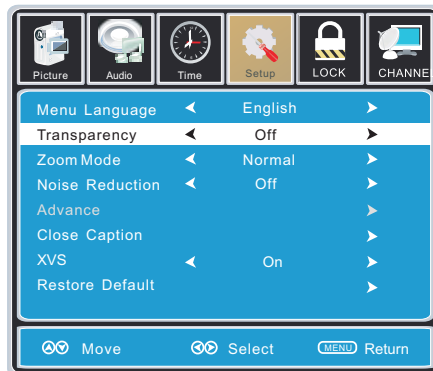

Use the ▼ button to highlight Transparency. Navigate using the ◀▶ buttons to turn Off or On the translucent effect of the OSD.

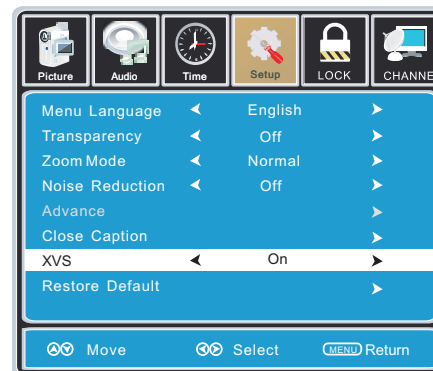

Use the ▼ button to highlight XVS. Navigate using the ◀▶ buttons to select: Off > On. XVS provides noticeable black detail enhancement that may be preferred.

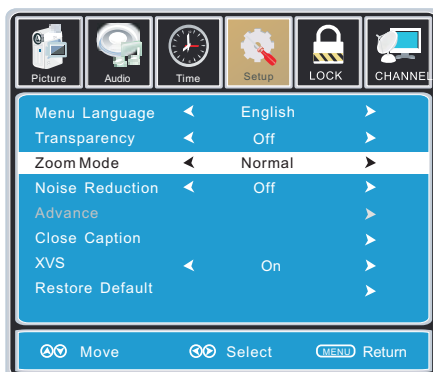

Use the ▼ button to highlight Zoom Mode. Navigate using the ◀▶ buttons to select the viewing mode: Normal > Wide > Zoom > Cinema.

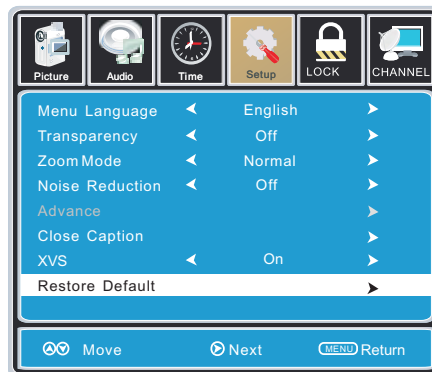

Use the ▼ button to highlight Restore Default. Press the ▶ button to automatically set all adjustments back to their original settings.



When prompted, Select "Yes" to confirm.

# TV SETUP



## SETUP MENU

The **SETUP** menu includes adjustments for activating the **Closed Caption** feature for display on the television and customizing CC display types and font styles.

### How to Navigate:

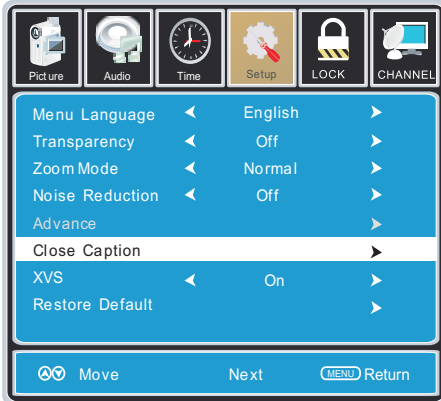

Press the MENU button on the remote control. Navigate using the ◀▶ buttons to select SETUP. Press the ▼ button to highlight Closed Caption then press the ▶ button to select from the following options.

Use the ▼ button to highlight Advance Selection. Navigate using the ◀▶ buttons to select Service 1 - 6.

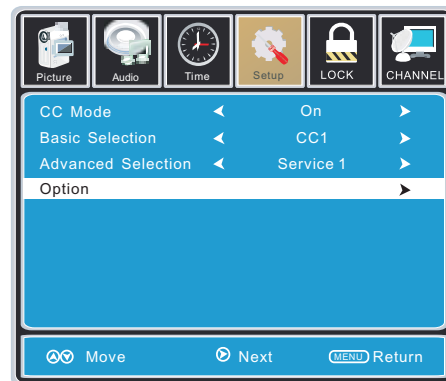
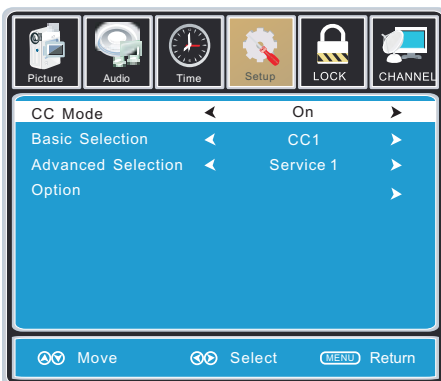

Use the ▼ button to highlight CC Mode. Navigate using the ◀▶ buttons to select Off > On > CC on Mute.

Use the ▼ button to highlight Option. Press the ▶ button to enter a menu with options to customize text fonts, colors and opacities.

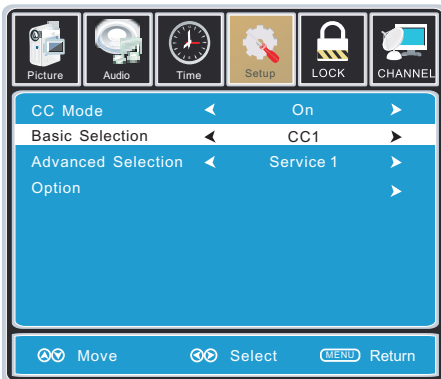

Use the ▼ button to highlight Basic Selection. Navigate using the ◀▶ buttons to select CC 1-4, Text 1-4.

### Note:

When adjustments are completed, you may select another menu by pressing the **Menu** button.



# TV SETUP



## SETUP MENU

In the **SETUP** menu you may adjust the position of images displayed on screen once you connect an input signal from your PC.

If your PC system uses a standard signal mode, the screen will adjust automatically.

Connect an optional 3.5mm audio cable for stereo sound.

### How to Navigate:

After connecting to a **PC**, press the **SOURCE** button and highlight **VGA**, then press the **ENTER** button.

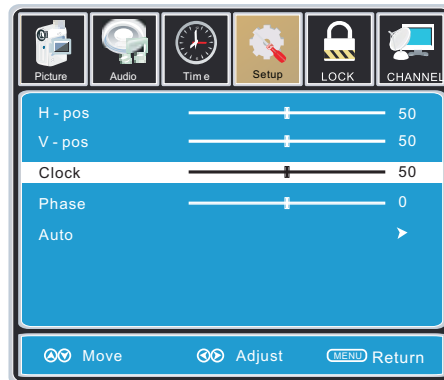
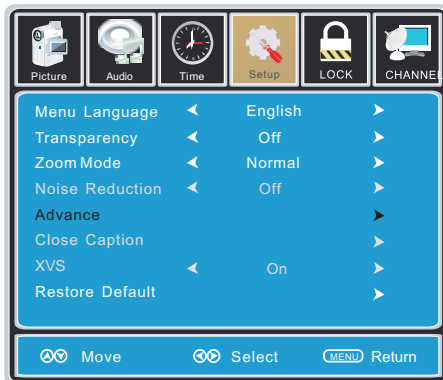

Press the **MENU** button on the remote control and navigate using the **◀▶** buttons to select **SETUP**. Press the **▼** button to highlight **Advanced**, then press the **▶** button to select from the following options.

Use the **▼** button to highlight **Clock**. Navigate using the **◀▶** buttons to control the width of the image.

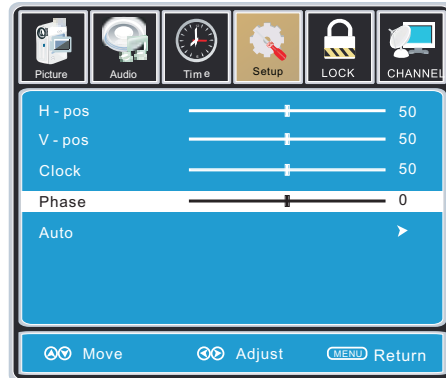
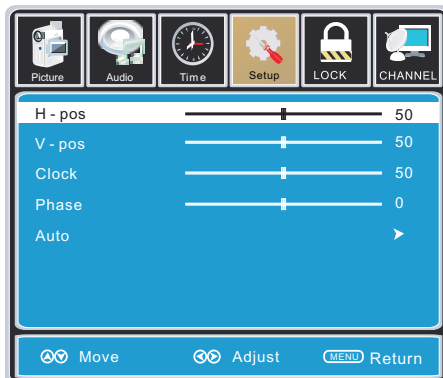

Use the **▼** button to highlight **H-POS**. Navigate using the **◀▶** buttons to adjust the position of images displayed from side to side.

Use the **▼** button to highlight **Phase**. Navigate using the **◀▶** buttons to improve focus and image stability.

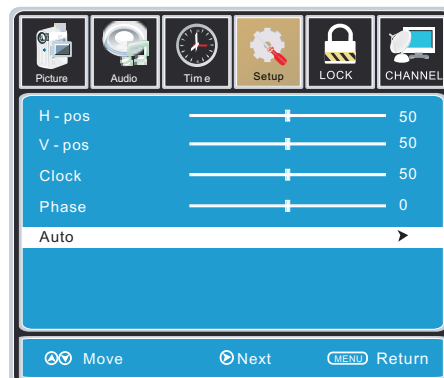
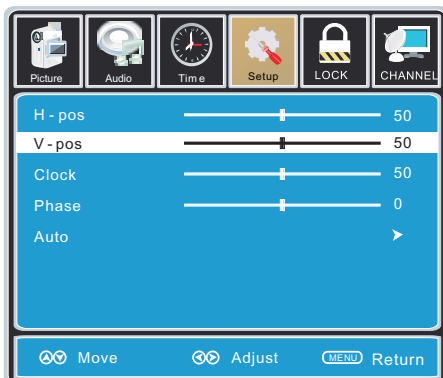

Use the **▼** button to highlight **V-POS**. Navigate using the **◀▶** buttons to adjust the position of images displayed up and down.

Use the **▼** button to highlight **AUTO**. Press the **▶** button to automatically adjust the display to the best setting.

# TV SETUP



## LOCK(PARENTAL) MENU

In the LOCK(PARENTAL) menu you may block television by inputting passwords. To gain access and select your preferences within the LOCK(Parental) menu make certain your input is set to TV.

### How to Navigate:

Press the MENU button on the remote control. Navigate using the ◀▶ buttons to select **Parental**.



Press the ▼ button to highlight Enter Password. Enter your 4 digit code (factory default code is "0000") unless previously changed.

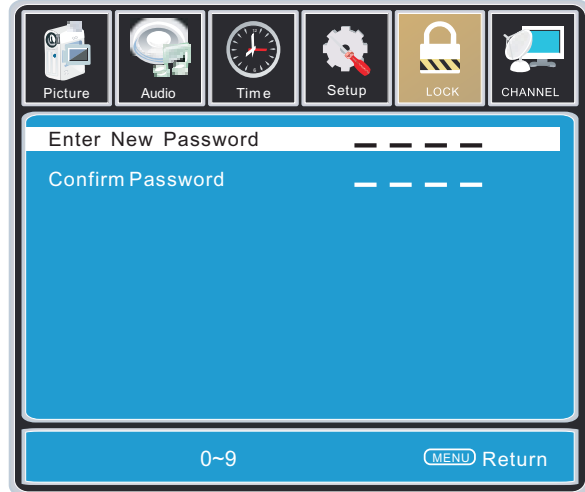

Use the numeric buttons to input a new 4 digit code by two times.



To change the password, press the ▶ button to display a screen to enter your new password, then confirm again.

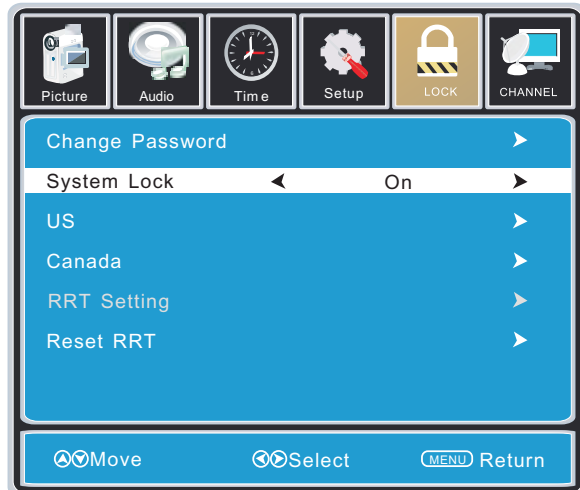

To make changes to PARENTAL controls, Highlight SYSTEM LOCK then press the ▶ button to ON.

### NOTE:

RRT Setting and Reset RRT are not user's adjustable settings.

# TV SETUP



## LOCK(PARENTAL) MENU

In the LOCK(PARENTAL) menu you may block television and movie programming based on U.S TV and movie rating guidelines. To gain access and select your preferences within the LOCK(Parental) menu make certain your input is set to TV.

### How to Navigate:

Press the MENU button on the remote control. Navigate using the ◀▶ buttons to select LOCK (Parental).

Press the ▼ button to highlight ENTER PASSWORD. Enter your 4 digit code (factory default code is "0000") unless previously changed.

To set parental controls for television programming or DVD movies, press the ▲▼ buttons to highlight US. Navigate using the ◀▶ buttons to highlight TV/MPAA menu.

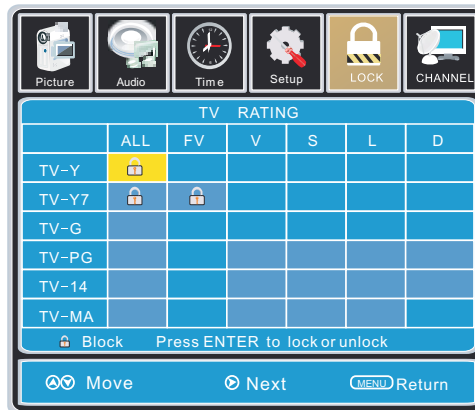
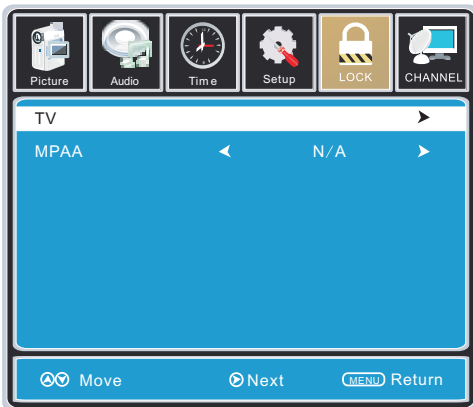

Highlight TV, then press the ▶ button to enter the TV Ratings menu to select your preference.

Age	Defined as
TV-Y	Recommended for all children.
TV-Y7	Directed to older children.
TV-G	General Audience.
TV-PG	Parental Guidance Suggested.
TV-14	Parental Strongly Cautioned.
TV-MA	Mature Audience only.

Contents	Defined as
FV	Fantasy Violence
D	Suggestive Dialogue
L	Strong Language
S	Sexual Situations
V	Violence

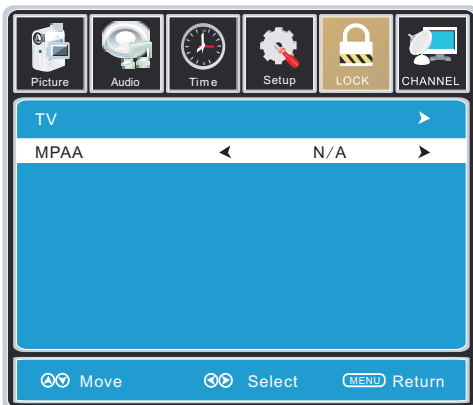

Rating	Defined as
N/A	Not rated.
G	GENERAL AUDIENCES, Suitable for all ages.
PG	PARENTAL GUIDANCE SUGGESTED - Some material may not be suitable for children.
PG-13	PARENTS STRONGLY CAUTIONED - Some material may be inappropriate for children under 13.
R	RESTRICTED, Under 17 requires accompanying parent or adult guardian for viewing in movie theaters.
NC-17	No one 17 or under admitted in movie theater.
X	Adult audience only.

Highlight MPAA then press the ▶ button repeatedly to select your movie rating preference.

# TV SETUP



## LOCK(PARENTAL) MENU

In the LOCK(PARENTAL) menu you may block television and movie programming based on Canadian TV and movie rating guidelines. To gain access and select your preferences within the LOCK(Parental) menu make certain your input is set to TV.

### How to Navigate:

Press the MENU button on the remote control. Navigate using the ◀▶ buttons to select Parental. Press the button to highlight ENTER PASSWORD. Enter your 4 digit code (factory default code is "0000") unless previously changed.

To set parental controls for television programming or DVD movies, press the ▲▼ buttons to highlight Canada. Navigate using the ◀▶ buttons to highlight Canada English/Canada French menu.



Rating	Description
E	Exempt.
C	Children.
C8 +	Recommended for children age 8 and older.
G	GENERAL AUDIENCES, Suitable for all ages
PG	PARENTAL GUIDANCE SUGGESTED -Some material may not be suitable for children.
14 +	Viewers 14 years and older
18 +	Adult Programming.

Navigate using the ▼ button to highlight CANADA ENGLISH, then press the ▶ button repeatedly to select your ratings preference.

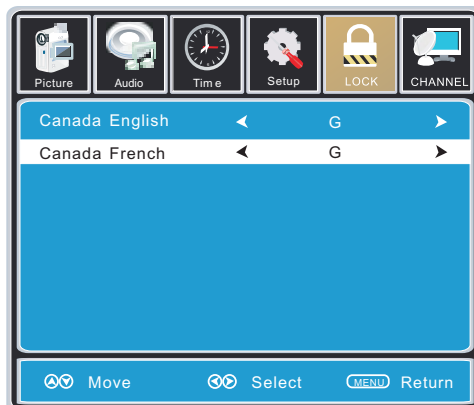

Rating	Description
E	Exempt.
G	GENERAL AUDIENCES, Suitable for all ages.
8 ans+	Not recommended for young children.
13 ans+	Not suitable for children under the age of 13.
16 ans+	Not suitable for children under the age of 16.
18 ans+	Adult Programming.

Navigate using the ▼ button to highlight CANADA FRENCH, then press the ▶ button repeatedly to select your ratings preference.

### NOTE:

When adjustments are completed, you may select another menu by pressing the **Menu** button.

# TV SETUP

## TV(CHANNEL) MENU

The TV(CHANNEL) menu provides for the setup of your television to receive TV channels, store your favorites, add or skip channels and label them by their call letters.

### How to Navigate:

Press the MENU button on the remote control. Navigate using the ◀▶ buttons to select TV. Press the ▼ button to highlight your preferences.

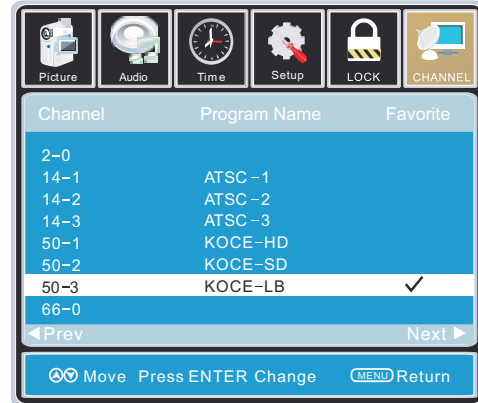
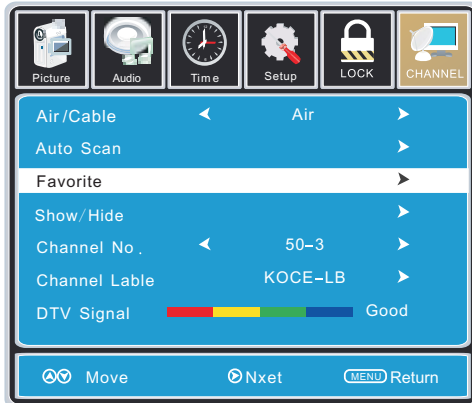

Highlight FAVORITE to add channels to your Favorites List. Navigate using the ▲▼◀▶ buttons to select channels to be added or deleted from your list. Press the ENTER button to add or delete a channel. A checkmark indicates a channel has been added. You may also display your favourite list from the remote control by pressing FAV.

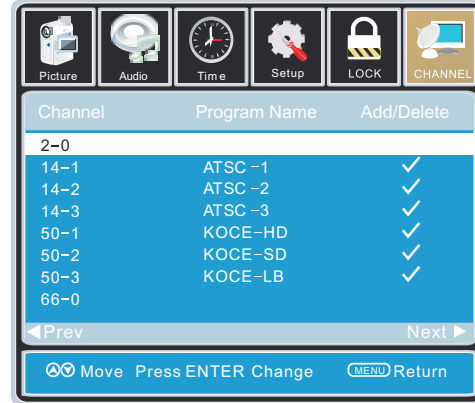
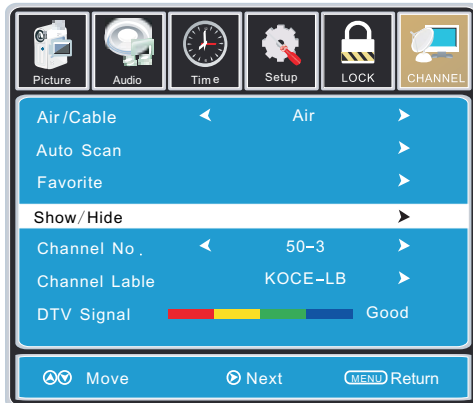

Highlight to select Show/Hide or skip channels already in memory. Navigate using the ▲▼◀▶ buttons to access the list of available channels. Press the ENTER button to change the channels status. A checkmark indicates a channel has been added.

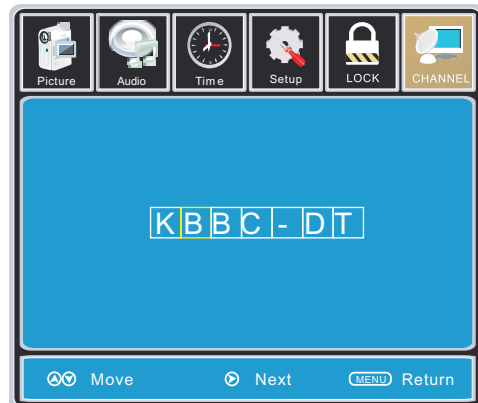
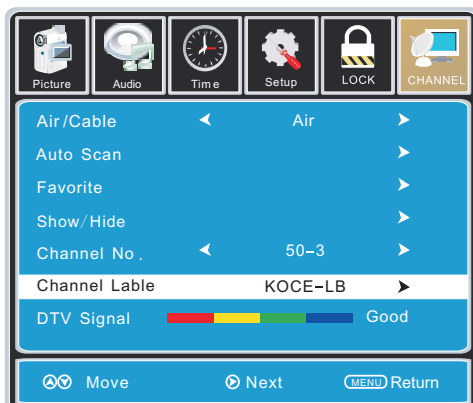

Highlight CHANNEL LABEL to name or rename a broadcast channel. Navigate using the ▶ button to enter the screen menu to re-label a channel. Use the ▲▼ buttons to spell out each letter, number or character. Use the ◀▶ buttons to advance to the next space.

# TV SETUP

## ZOOM MODE

Press the MENU button on the remote control.  
Navigate using the ◀▶ buttons to select **SETUP**.  
Use the ▼ button to highlight Zoom Mode.  
Navigate using the ◀▶ buttons to select the viewing mode: Normal > Wide > Zoom > Cinema.

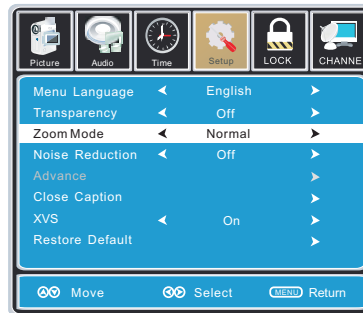

### 1. NORMAL

Recommended for viewing native widescreen content and undistorted 4:3 images. (With Black Bars)



### 2. WIDE

Stretches certain 4:3 content and may reduce the black bars.



### 3. ZOOM

Stretches the image both vertically and horizontally to fill the screen when viewing widescreen content. The zoom effect will crop images somewhat.



### 4. CINEMA

When viewing 4:3 content, Cinema mode will fill the entire screen eliminating the side black bars. It may also eliminate or reduce black bars on certain widescreen movies.

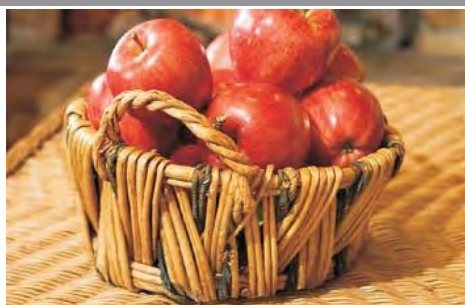

# DISC FORMATS

## NOTES ON COPYRIGHT

It is forbidden by law to copy, broadcast, show, broadcast on cable, play in public or rent copyrighted material without permission. Apparatus Claims of U.S. Patent Nos. 6,836,549; 6,381,747; 7,050,698; 6,516,132; and 5,583,936 licensed for limited viewing uses only. DVDs are copy protected, and any recordings made from these discs will be distorted. This product incorporates copyright protection technology that is protected by method claims of certain U.S. patents and other intellectual property rights owned by Macrovision Corporation and other rights owners. Use of this copyright protection technology must be authorized by Macrovision Corporation, and is intended for home and other limited viewing uses only, unless otherwise authorized by Macrovision Corporation. Reverse engineering or disassembly is prohibited.

The unit can play:



DVDs  
[8cm/12cm disc]



Audio CDs  
[8cm/12cm disc]

CD-R CD-RW  
Compatible

## REGION MANAGEMENT INFORMATION

Region Management Information: This unit is designed and manufactured to respond to the Region Management Information that is encoded on DVDs. If the region number printed on the DVD does not correspond to the region number of this unit, this unit cannot play that disc.

The region number of this equipment is



## DISC FUNCTION OR OPERATION THAT IS NOT AVAILABLE

When the "INVALID KEY" symbol appears on the screen, it indicates that the function or operation attempted is not available at that time. This occurs because the DVD manufacturer determines the specific functions. Certain functions may not be available on some discs. Be sure to read the documentation provided with the DVD.

## ICONS USED ON DVDs

Sample Icons

	1. English 2. French	Language selections for audio
	1. English 2. French	Language selections for subtitles
		Screen aspect ratio
		Multiple camera angles
		Region code indicator

## NOTE

When playing back a CD-G (Graphics) or CD EXTRA disc, the audio portion will be played, but the graphic images may not be shown.

## TITLES, CHAPTERS AND TRACKS

- DVDs are divided into "TITLES" and "CHAPTERS". If the disc has more than one movie on it, each movie would be a separate "TITLE". "CHAPTERS" are sections of titles.

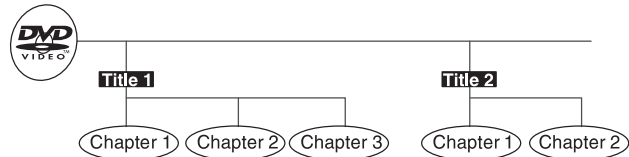

- Audio CDs are divided into "TRACKS". A "TRACK" is usually one song on an Audio CD.

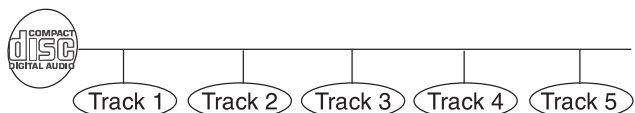

## NOTE

Numbers identify each title, chapter and track on a disc. Most discs have these numbers record on them, but some do not.

## NOTES ON UNAUTHORIZED DISCS

You may not be able to playback some DVDs on this equipment if they were purchased from outside your geographic area or made for business purposes.



# CD/DVD OPERATION

This owner's manual explains the basic instructions of this unit. Some DVDs are produced with limited operation during playback. For example, many DVDs do not allow users to skip government warnings, or in some cases previews or other features. This is not a defect in the unit. Refer to the instruction notes of discs.

"INVALID KEY" may appear on the screen during operation. "INVALID KEY" means that the desired operation is not permitted by the unit or disc.

## BASIC OPERATIONS

### TURN ON AND OFF THE DVD FUNCTION

Turn on the LCD TV and then press the SOURCE button repeatedly to select DVD mode.

### INSERT DISC TO DVD

Insert the disc to the disc slot (mirror side of the disc has to face yourself), the player will load the disc automatically. There will have an on screen indication "CLOSE" then "READ". After loading the disc content, it will switch to play mode automatically. If the disc is already placed inside, the disc will be read automatically.

**NOTE:** For some discs, after loading the content of the disc, need to press the ►|| or select from the disc menu to start.

Please make sure when inserting the Disc, the label side of the disc should be facing yourself when inserting the Disc incorrectly, you may damage the DVD mechanism.

### PLAYING A PICTURE FILE DISC

This unit can play JPG files recorded on CD-R and CD-RW discs.

1. Hold the disc by its edge and gently push it into the door, with the label side facing yourself.
2. The unit will load the disc and automatically display the contents of the disc on the screen, while also beginning to play the picture file. These files will then be played back one by one.
3. Press the ■ button to go to the folder list.
4. Press the ▲ or ▼ button to highlight a file to play. Press the ►|| button to start playback.

### PAUSING /PLAYING PLAYBACK

Press the ►|| button to switch between pausing and playing.

### STOPPING PLAYBACK

Press the button ■ at the location where you want to interrupt playback. To resume playback at the position where the disc was stopped, press the button ►||.

If you press the button ■ twice, the unit's memory will be cleared and pressing the button ►|| will reset the disc to the beginning.

### SKIP (PREVIOUS/NEXT)

Press the ◀◀PREV button to go back to previous chapters/tracks.

Press the ▶▶NEXT button to advance chapters/tracks.

For an Audio CD, use the number buttons (remote control only) to jump directly to that track number.

### TITLE (for DVD disc only)

Press the TITLE button, there will have an on screen indication "TITLE".

Press the direction or numeric buttons to select your favorite title.



# CD/ DVD OPERATION

## VOLUME

- Press the VOL - / VOL + buttons to adjust the output volume.

NOTE: Playback DVD discs in original code, is not adjustable.

## MUTE

- Press the MUTE button to mute the audio output. There will have an on screen symbol indicate "MUTE" .
- Press again to cancel, or Press the VOL + button to cancel and adjust the volume.
- In case there is no audiooutput, try to press the MUTE button to cancel mute.

## ZOOM

- Press the ZOOM button to zoom in the picture.
- There are 6 zoom modes, press the ZOOM button to toggle between different zoom modes in sequent. (Zoom2 - Zoom3 - Zoom4 )
- In Zoom2-4, you may use the ▲ ▼ ◀ ▶ buttons to pan the picture for your favorite portion.

## PROGRAM

- Press the PROGRAM button to display the program menu as shown:

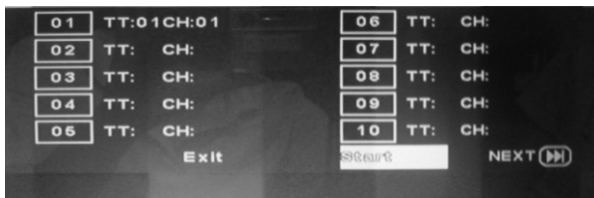

- Using numeric keys to set the TT and CH, then move to the START button, press ENTER button to start.
- While playing the program, you may press the PROGRAM button to display the program menu for edit. To stop the program by moving to STOP button, then press ENTER button to end the program.

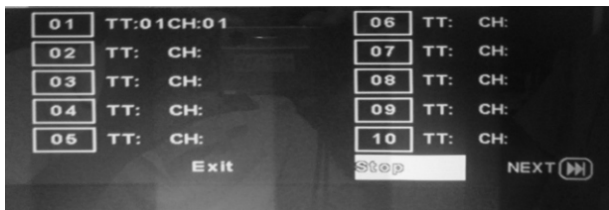

# CD/DVD OPERATION

## FAST FORWARD / FAST REVERSE

1. Press the ◀◀ or ▶▶ button when a disc is playing.

Each time the ◀◀ or ▶▶ button is pressed, the speed of fast scan changes in the following sequence:

FORWARD X 2 ---> FORWARD X 4 ---> FORWARD X 8 ---> FORWARD X 16 ---> FORWARD X 32 ---> PLAY

BACKWARD X 2 ---> BACKWARD X 4 ---> BACKWARD X 8 ---> BACKWARD X 16 ---> BACKWARD X 32 ---> PLAY

2. Press the ▶|| button to play when you reach the desired point to resume playback at normal speed.

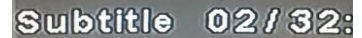

## SUBTITLE SELECTION (DVD)

1. While a DVD is playing, press the SUBTITLE button to display the current the language setting, as shown in the example.

2. Press the SUBTITLE button repeatedly to select the desired subtitle language.

### NOTE

- If only one language is recorded, the language does not change.
- About two seconds later, playback continues with the new subtitle you selected.
- If no button is pressed within a few seconds, playback continues without changing the current subtitle.
- The number of languages recorded differs depending on the disc.
- This function can only be used for discs on which subtitles have been recorded in multiple languages.

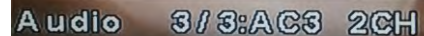

## AUDIO SELECTION (DVD)

On some discs, the sound is recorded in two or more formats. Follow the directions below to select the preferred language and sound system.

1. While a disc is playing, press the AUDIO button to show the current audio format number.

2. Press the AUDIO button repeatedly to select the desired audio format.

### Note

- If only one audio format is recorded, the number does not change.
- About two seconds later, playback continues in the new audio format.

## ANGLE SELECTION (DVD)

Some DVDs contain scenes which have been shot from a number of different angles. For these discs, the same scene can be viewed from each of these different angles.

1. While you are playing a DVD with different angles recorded, press the ANGLE button to view the number of the current angle available.

2. Press the ANGLE button repeatedly to change the scene to the next angle in those recorded.

- About two seconds later, playback continues from the new angle you selected.
- If no button is pressed within 10 seconds, playback continues without changing the current angle.

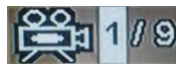

Sequence of angle shots  
(Example)

### NOTE

This function can only be used for discs on which scenes shot from multiple angles have been recorded .

# CD/DVD OPERATION

## SPECIAL FUNCTIONS

### DISPLAY function (DVD) INFO Button

Using INFO button, you can check the current settings of the following items: ANGLE, AUDIO and SUBTITLE.

**While the disc is playing, press the INFO button repeatedly to display information on operation status.**

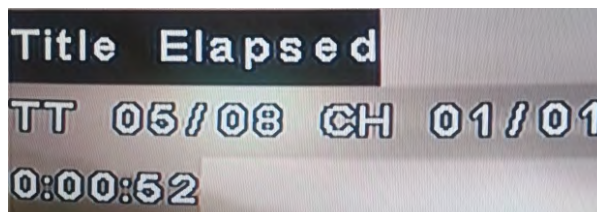

### LOCATING A SPECIFIC TITLE (DVD)

If a DVD contains title numbers, you can locate a specific title by directly selecting a title number.

1. Press the GOTO button.
2. Press the ◀ or ▶ button to highlight a specific field and press the corresponding number button(s) for the title you want.
3. Press the ENTER button to confirm. The Unit will start playback about 3 seconds later.

A screenshot of a DVD player's display. The text is white on a dark background. It shows 'TT: 06/08 Time 1:11:1'.

### LOCATING A SPECIFIC CHAPTER / TRACK

If you know the chapter / track number you want to play, you can locate a specific chapter / track by directly selecting a chapter / track number.

1. Press the GOTO button to search for your desired chapter / track.
2. You can directly press 0-9 number button to highlight a chapter/track. If you want the chapters / tracks greater than 10, you can press the 10+ button and press the corresponding number button(s) for the chapter/track you want.
3. Press the ENTER button to confirm. Playback starts from the selected chapter / track.

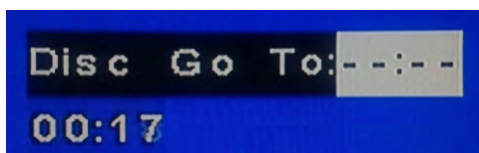

### LOCATING A SPECIFIC TIME

You can move to a specific location by entering its corresponding time (hours, minutes, seconds)

1. Press the GOTO button.
2. Press the ◀ or ▶ button to highlight time.
3. Press the corresponding number buttons for the setting point you want.
4. Press the ENTER button to confirm. The Unit will start playback about 3 seconds later.

#### NOTE

- Some discs may not respond to this process.
- Some scenes may not be located as precisely as specified.
- This method for accessing specific locations is available only within the current title of the DVD.

A screenshot of a DVD player's display. The text is white on a dark background. It shows 'TT: 06/08 Time 1:11:1'.

# CD/DVD OPERATION

## DVD REPEATING

You can play a specific title or chapter repeatedly. (Title repeat, chapter repeat, A-B repeat)

### REPEATING A CHAPTER

You can play the same chapter repeatedly.

1. While the disc is playing, press the REPEAT button until the  indicator displays on the screen.

The current chapter is played repeatedly.

### REPEATING A TITLE

You can play the same title repeatedly.

2. While the disc is playing, press the REPEAT button until the  indicator displays on the screen.  
The current title is played repeatedly.

### REPEATING ALL

3. While the disc is playing, press the REPEAT button until the  indicator displays on the screen.

## CD REPEATING

You can play a single track and whole disc repeatedly.

### REPEATING A SINGLE TRACK

You can play the same track repeatedly.

1. While the disc is playing, press the REPEAT button until the  indicator displays on the screen.  
The current track is played repeatedly.

### REPEATING A WHOLE DISC

2. While the disc is playing, press the REPEAT button until the  indicator displays on the screen.  
The whole disc is played repeatedly.

### REPEATING A SPECIFIC SECTION (DVD) (CD)

You can play a specific section repeatedly.

1. While the disc is playing, press the A-B button at the beginning of the section (  A is displayed) you want to play repeatedly.

2. Press the A-B button again at the end of the section (  AB is displayed).

3. The Unit will immediately begin replaying your selection.

### REPEATING A SINGLE TRACK

4. While the disc is playing, press the A-B button until the  indicator displays on the screen.

## NOTE

- A-B repeat can only be used within the same title. If the start and end of the section to be repeated are in different titles, A-B repeat is cancelled.
- The A-B repeat function does not operate in scenes where different camera angles are recorded.

## CD/ DVD OPERATION

### MP3/JPEG PLAYBACK

After loading the MP3 / JPEG disc, it will start to scan for the stored MP3 / JPEG folders. Then it will firstly display the MP3 contents automatically and start to play the first file (highlighted file). Screen as follows:

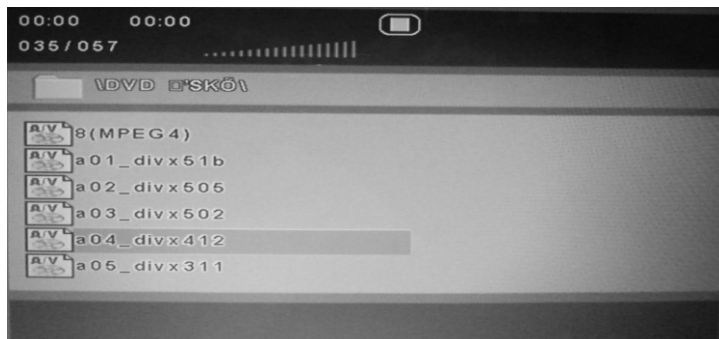

Use the ▲/▼ buttons to select the folder you want to play.

#### NOTE:

When playing MP3 files, there is no picture display, only audio output.

Playing the JPEG discs, press the PROGRAM button to select slide effects. There are 16 slide modes, press the PROGRAM button to toggle among different modes in sequence.

(Wipe top, Wipe bottom, Wipe left, Wipe right, Diagonal wipe lefttop, Diagonal wipe right top, Diagonal wipe left bottom, Diagonal wipe right bottom, Extend from center H, Extend from center V, Compress to center H, Compress to center V, Window H, Window V, Wipe from else to center Random, None )

When play or pause with picture playback, you may use the navigation buttons to flip / rotate the picture.

- ▲ button to flip horizontally.
- ▼ button to flip vertically.
- ◀ button to rotate left 90°.
- ▶ button to rotate right 90°.

Press the ◀◀ / ▶▶ buttons to select next / previous page or press numeric buttons to view the corresponding pictures.

# CUSTOMIZING THE DVD FUNCTION SETTINGS

## 1. General Setup Page

Press the D.SETUP button and then press the ◀/▶ to display the system setup menu page when in DVD mode.

Press the ▲/▼ button to move the highlight to select the following option.

Press the ▶ button to enter the following menu and use the ▲/▼ button to select a menu item.

Press the ENTER button to confirm, press the ◀ button to return to sub-menu.

Press the D.SETUP to exit the DVD setup menu.

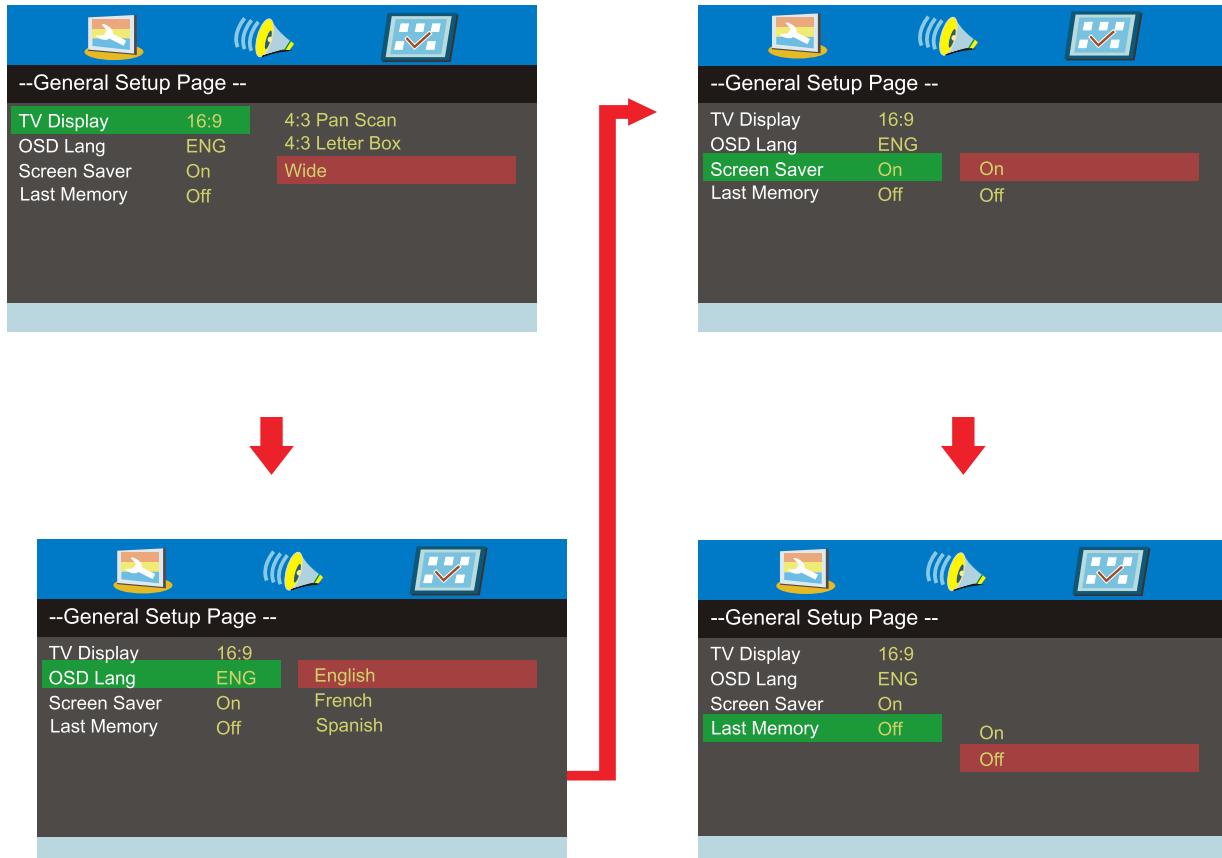

# CUSTOMIZING THE DVD FUNCTION SETTINGS

## 2. Audio Setup Page

Press the D.SETUP button and then press the ◀/▶ to display the audio menu page when in DVD mode.

Press the ▲/▼ button to move the highlight to select the following option.

Press the ▶ button to enter the following menu and use the ▲/▼ button to select a menu item.

Press the ENTER button to confirm, press the ◀ button to return to sub-menu.

Press the D.SETUP to exit the DVD setup menu.

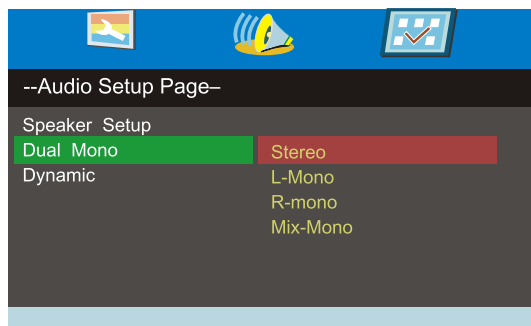
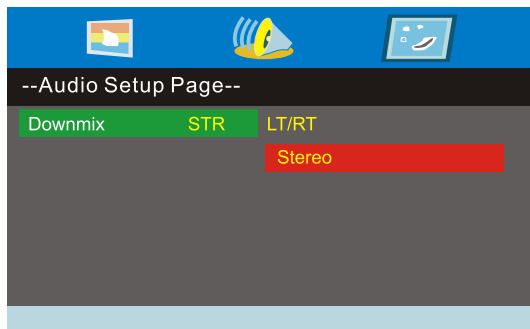
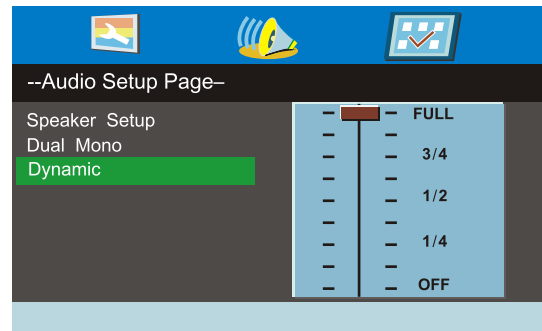
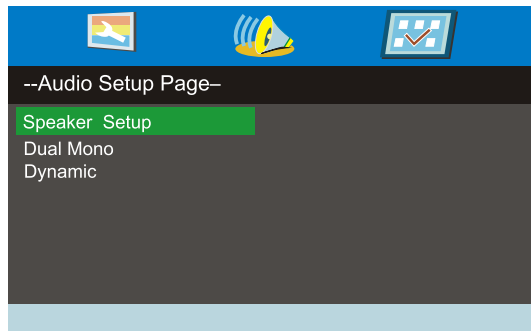

# CUSTOMIZING THE DVD FUNCTION SETTINGS

## 3.Preference Page

Press the D.SETUP button and then press the ◀/▶ to display the preference page when in DVD mode.

Press the ▲/▼ button to move the highlight to select the following option.

Press the ▶ button to enter the following menu and use the ▲/▼ button to select a menu item.

Press the ENTER button to confirm,press the ◀ button to return to sub-menu.

Press the D.SETUP to exit the DVD setup menu.

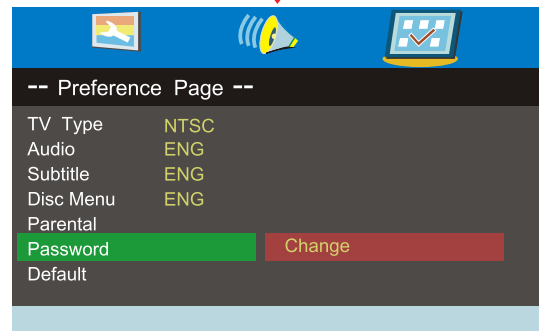
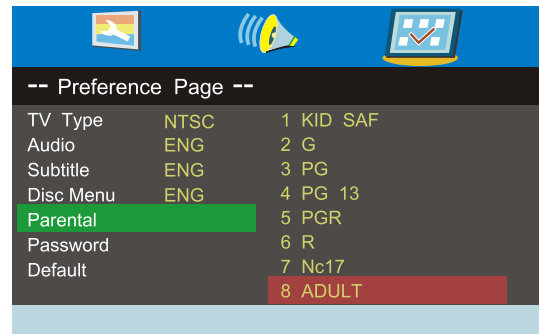
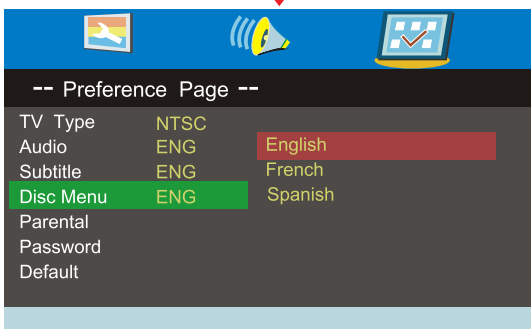
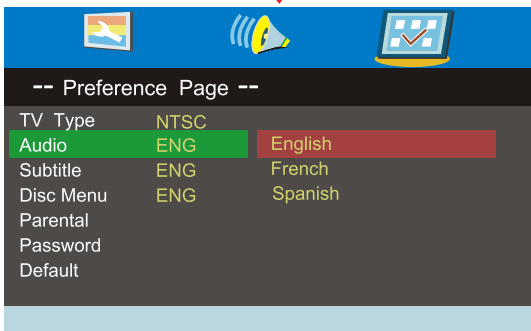
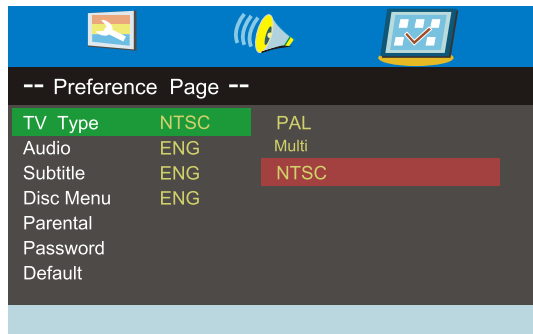

(The default password:123456)

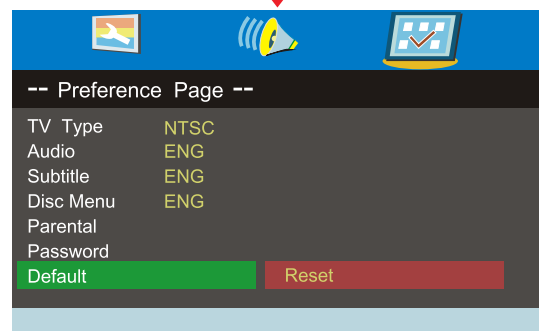



## DISPLAY MODE

### PC FORMATS

SUPPORTED PC INPUT MODE			
Resolution	Horizontal Scanning Frequency (KHz)	Vertical Scanning Frequency (Hz)	Format
640 X 480	31.5	60.0	DOS
800 X 600	35.1	56.2	VESA
800 X 600	37.9	60.0	VESA
1024 X 768	48.4	60.0	VESA
1360 X 768	47.7	60.0	VESA

**NOTE:**

This product does not support the display mode not listed above. In order to achieve the best display effect, please select the above-listed 5 display modes input signal.

Because of the difference of display drivers output signal (especially non-standard signal output), the display image may appear little disturbance which can be adjusted on the PC menu.

To prolong this unit's service life, please set your computer to power management mode.

## DISPLAY MODE

### VIDEO FORMATS

SUPPORTED COMPONENT / HDMI INPUT MODE			
Resolution	Horizontal Scanning Frequency ( KHz )	Vertical Scanning Frequency (Hz)	Format
720 X 480	31. 47	59. 94	480 i
720 X 480	15. 734	59. 94	480 p
1280 X 720	37. 5	50	720 p
1280 X 720	45	60	720 p
1920 X 1080	31. 25	50	1080 i
1920 X 1080	33. 75	60	1080 i
1920 X 1080	27	24	1080 p
1920 X 1080	56. 25	50	1080 p
1920 X 1080	67. 50	60	1080 p

**NOTE:**

The above listed formats are also related to the AV devices you are about to connect. Before you connect this unit with others please read all instructions carefully and make sure all necessary cables are connected.

This unit may be incompatible with some other formats which are not meet the above conditions.

# SPECIFICATION

Model Description		32"LED TV / DVD COMBO
Panel	Panel Type	LED Panel
	Diagonal Size	32 inches
	Screen Format	16:9
	Resolution	1366 x 768
	Brightness	400cd/m <sup>2</sup>
	Contrast	3000: 1
	View Angle	178(H)/178V)
	Response Time	6.5 ms
	Maximum Color	16.7M colors
Systems	Color System	ATSC/QAM/NTSC
	Sound System	M
	Audio System	BTSC
	Sound Output	L/R Speaker: 10 W + 10 W
Input / Output Jacks	RF Input	75 ohm external terminal
	HDMI Input	Video: 480i, 480p, 720p, 1080i, 1080p. Audio: Two channel linear PCM 32, 44.1 and 48kHz, 16, 20 and 24 bits
	PC-RGB Input	D-sub 15pin G: 0.7Vp-p, 75ohms B: 0.7Vp-p, 75ohms R: 0.7Vp-p, 75ohms
	Composite Video Input	1.0 Vp-p, 75ohms RCA
	Component/Y Pb Pr Input	RCA Y: 1.0 Vp-p, 75ohms, 0.3V negative sync Pb: 0.7Vp-p, 75ohms Pr: 0.7Vp-p, 75ohms
	Sound Input	Component AUDIO: For Component Audio input AV AUDIO: For CVBS PC AUDIO: For PC RGB Audio input 500mV rms, Impedance: 20k ohms
DVD	Region Code	1
	Disc Size	12cm disc
	Compatible Disc Type	DVD, DVD-R/+R, DVD-RW /+RW, VCD, CD, CD-R, CD-RW
Power	Power Requirement	AC100-240V~ 50/60Hz
	Rated power consumption	80 W

This manual is only for your reference.  
Specifications are subject to update without prior notice.

## TROUBLESHOOTING GUIDE

SYMPTOM	CAUSE (AND REMEDY )
No power.	<ul style="list-style-type: none"> <li>• Make sure the power cord is connected.</li> <li>• Turn on the unit.</li> </ul>
The remote does not function.	<ul style="list-style-type: none"> <li>• Remove any obstacles between the remote and the unit.</li> <li>• Use the remote near the unit.</li> <li>• Point the remote at the remote sensor on the unit.</li> <li>• Replace the batteries in the remote with new ones.</li> </ul>
<b>DVD</b>	
No sound or only a very low-level sound is heard.	<ul style="list-style-type: none"> <li>• Make sure that you've selected DVD mode.</li> <li>• The system is in pause mode. Press the ► button to return to normal play mode.</li> <li>• Fast forward or fast reverse is performed. Press the ► button to return to normal play mode.</li> <li>• Make sure the AUDIO / VIDEO output and AV IN input connections are correct.</li> <li>• This unit is too hot. Power off the unit for 30 minutes to cool down.</li> </ul>
No picture	<ul style="list-style-type: none"> <li>• The region number of the disc doesn't match the region number of this unit.</li> </ul> <div style="text-align: center;">  </div>
The picture is not clear	<ul style="list-style-type: none"> <li>• Clean the disc.</li> <li>• The disc is scratched</li> </ul>
Severe hum or noises heard.	<ul style="list-style-type: none"> <li>• The plugs and jacks are dirty. Wipe them with a cloth slightly moistened with alcohol.</li> <li>• Clean the disc</li> </ul>
The disc does not play.	<ul style="list-style-type: none"> <li>• There is no disc inside ("No Disc" appears on the screen).</li> <li>• Insert the disc correctly with the label side facing yourself.</li> <li>• Clean the disc.</li> <li>• A non-NTSC disc has been inserted. The unit and disc region number are incompatible.</li> <li>• Condensation may have formed inside the unit due to a sudden change in temperature. Wait about an hour for it to clean and try again.</li> </ul>

## TROUBLESHOOTING GUIDE

SYMPTOM	CAUSE (AND REMEDY )
TV	
Bad Picture (snow, multiple images distortion, blurry)	<ul style="list-style-type: none"> <li>• Check the location of the antenna and adjust it if necessary.</li> <li>• Make sure the antenna cable is firmly connected.</li> <li>• Make sure all input cables are firmly connected.</li> </ul>
No sound.	<ul style="list-style-type: none"> <li>• Increase the volume.</li> <li>• Check whether the mute function has been activated on the Remote Control.</li> </ul>
Black and White picture.	<ul style="list-style-type: none"> <li>• Check the PICTURE setting within the PICTURE menu.</li> <li>• Check to make sure the program you are watching is broadcast in Color and not Black &amp; White.</li> </ul>
No picture or sound.	<ul style="list-style-type: none"> <li>• Make sure the unit is plugged in and turned on.</li> <li>• Make sure that the ATV mode is selected.</li> <li>• Try a new channel to check for possible station trouble.</li> <li>• Make sure the antenna is connected properly.</li> <li>• Increase the volume.</li> <li>• Make sure the antenna or audio/video source device is working properly.</li> <li>• Make sure all cables are firmly connected.</li> <li>• Check for local interference.</li> </ul>
Colored patches of picture.	<ul style="list-style-type: none"> <li>• Make sure there are no unshielded electrical devices nearby that are causing interference.</li> <li>• Turn the TV off for 30 minutes, then try it again.</li> </ul>
Panel function key does not respond correctly.	<ul style="list-style-type: none"> <li>• Under the influence of electrostatic phenomenon, the product may malfunction and require user power reset.</li> <li>• Unplug and re-plug the power cord.</li> </ul>
The display monitor's panel goes hot.	<ul style="list-style-type: none"> <li>• LED TV takes inside light phosphor. It may increase the temperature of the screen in some occasions. It's not a defect.</li> </ul>
Unusual dots	<ul style="list-style-type: none"> <li>• Black dots and Bright points may appear on the LED screen. This is a structural property of the LED panel and is not a defect.</li> </ul>
Stripes on screen	<ul style="list-style-type: none"> <li>• Adjust the impulse phase may decrease stripes. RGB in</li> </ul>
The top of the monitor gets hot.	<ul style="list-style-type: none"> <li>• It may occur during long-time working. It's not a defect.</li> </ul>
Unable to select a certain channel.	<ul style="list-style-type: none"> <li>• The channel may be skipped. Choose this channel by directly selecting the buttons from the remote control.</li> </ul>
Disorder display at power on.	<ul style="list-style-type: none"> <li>• This may be caused because of a very short interval between STANDBY OFF and ON.</li> <li>• Unplug the power and restart.</li> </ul>

## Free Manuals Download Website

<http://myh66.com>

<http://usermanuals.us>

<http://www.somanuals.com>

<http://www.4manuals.cc>

<http://www.manual-lib.com>

<http://www.404manual.com>

<http://www.luxmanual.com>

<http://aubethermostatmanual.com>

Golf course search by state

<http://golfingnear.com>

Email search by domain

<http://emailbydomain.com>

Auto manuals search

<http://auto.somanuals.com>

TV manuals search

<http://tv.somanuals.com>