

Panasonic®

Operating Instructions **Vol.1**

Memory Card Camera-Recorder

Model No. **AG-AC90P**
AG-AC90PJ
AG-AC90PX

 **Register now!!**
This product is eligible for the AVCCAM 3 Year Warranty Repair Program.
For details, see page 10.
http://panasonic.biz/sav/pass_e/

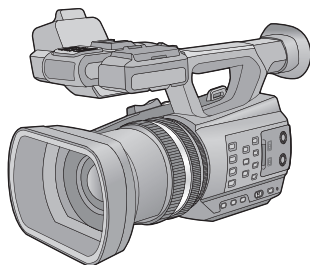

Vol.1

Please read first

This document explains basic operations of the unit. For more detailed explanation, please refer to "Operating Instructions Vol.2" (PDF file) which is recorded in the enclosed CD-ROM.

Please read these instructions carefully before using this product, and save this manual for future use.

AVCCAM

AVCHD™
Progressive

HDMI

SD™
XC

DOLBY
DIGITAL
5.1 CREATOR

ENGLISH

F0912YK0 (1700 (A))

Printed in Japan

VQT4M90

Download from www.Somanuals.com. All Manuals Search And Download.

Information for Your Safety

WARNING:

To reduce the risk of fire, electric shock or product damage,

- Do not expose this unit to rain, moisture, dripping or splashing.
- Do not place objects filled with liquids, such as vases, on this unit.
- Use only the recommended accessories.
- Do not remove covers.
- Do not repair this unit by yourself. Refer servicing to qualified service personnel.



CAUTION!

To reduce the risk of fire, electric shock or product damage,

- Do not install or place this unit in a bookcase, built-in cabinet or in another confined space. Ensure this unit is well ventilated.
- Do not obstruct this unit's ventilation openings with newspapers, tablecloths, curtains, and similar items.
- Do not place sources of naked flames, such as lighted candles, on this unit.

THE FOLLOWING APPLIES ONLY IN THE U.S.A. and CANADA.

The following mark and symbols are located on bottom of units.

	CAUTION RISK OF ELECTRIC SHOCK DO NOT OPEN		
CAUTION: TO REDUCE THE RISK OF ELECTRIC SHOCK, DO NOT REMOVE SCREWS. NO USER-SERVICEABLE PARTS INSIDE. REFER SERVICING TO QUALIFIED SERVICE PERSONNEL.			<p>The lightning flash with arrowhead symbol, within an equilateral triangle, is intended to alert the user to the presence of uninsulated "dangerous voltage" within the product's enclosure that may be of sufficient magnitude to constitute a risk of electric shock to persons.</p>
			<p>The exclamation point within an equilateral triangle is intended to alert the user to the presence of important operating and maintenance (servicing) instructions in the literature accompanying the appliance.</p>

FCC NOTICE (USA)

Declaration of Conformity

Model Number: AG-AC90PJ
Trade Name: Panasonic
Responsible Party: Panasonic Corporation of North America
One Panasonic Way, Secaucus, NJ 07094
Support contact: 1-800-524-1448

This device complies with Part 15 of the FCC Rules.

Operation is subject to the following two conditions:

(1) This device may not cause harmful interference, and (2) this device must accept any interference received, including interference that may cause undesired operation.

To assure continued compliance, follow the attached installation instructions and do not make any unauthorized modifications.

CAUTION:

This equipment has been tested and found to comply with the limits for a Class B digital device, pursuant to Part 15 of the FCC Rules. These limits are designed to provide reasonable protection against harmful interference in a residential installation. This equipment generates, uses and can radiate radio frequency energy and, if not installed and used in accordance with the instructions, may cause harmful interference to radio communications. However, there is no guarantee that interference will not occur in a particular installation. If this equipment does cause harmful interference to radio or television reception, which can be determined by turning the equipment off and on, the user is encouraged to try to correct the interference by one of the following measures:

- Reorient or relocate the receiving antenna.
- Increase the separation between the equipment and receiver.
- Connect the equipment into an outlet on a circuit different from that to which the receiver is connected.
- Consult the dealer or an experienced radio/TV technician for help.

The user may find the booklet "Something About Interference" available from FCC local regional offices helpful.

FCC Warning:

To assure continued FCC emission limit compliance, follow the attached installation instructions and the user must use only shielded interface cables with ferrite core when connecting to host computer or peripheral devices. Also, any unauthorized changes or modifications to this equipment could void the user's authority to operate this device.

NOTIFICATION (Canada)

This Class B digital apparatus complies with Canadian ICES-003.

 indicates safety information.

THE FOLLOWING APPLIES ONLY IN THE U.S.A.

 **Panasonic**
AG-AC90PJ

AC adaptor

This AC adaptor operates on AC between 110 V and 240 V.

But

- In the U.S.A. and Canada, the AC adaptor must be connected to a 120 V AC power supply only.
- When connecting to an AC supply outside of the U.S.A. or Canada, use a plug adaptor to suit the AC outlet configuration.
- When connecting to a supply of greater than AC 125 V, ensure the cord you use is suited to the voltage of the AC supply and the rated current of the AC adaptor.
- Contact an electrical parts distributor for assistance in selecting a suitable AC plug adaptor or AC cord set.

Battery charger

This battery charger operates on AC between 100 V and 240 V.

But

- In the U.S.A. and Canada, the battery charger must be connected to a 120 V AC power supply only.
- When connecting to an AC supply outside of the U.S.A. or Canada, use a plug adaptor to suit the AC outlet configuration.
- When connecting to a supply of greater than AC 125 V, ensure the cord you use is suited to the voltage of the AC supply and the rated current of the battery charger.
- Contact an electrical parts distributor for assistance in selecting a suitable AC plug adaptor or AC cord set.

Install this unit so that the power cord can be unplugged from the socket outlet immediately if any problem occurs.

■ Concerning the battery

Batteries

1 Battery pack (Lithium ion battery pack)

- Use the specified unit to recharge the battery pack.
- Do not use the battery pack with equipment other than the specified unit.
- Do not get dirt, sand, liquids, or other foreign matter on the terminals.
- Do not touch the plug terminals (+ and -) with metal objects.
- Do not disassemble, remodel, heat or throw into fire.

2 Button-type battery (Lithium battery)

- Insert with poles aligned.
- Do not touch the terminals (+ and -) with metal objects.
- Do not recharge, disassemble, remodel, heat or throw into fire.
- Keep out of reach of children.

If any electrolyte should come into contact with your hands or clothes, wash it off thoroughly with water.

If any electrolyte should come into contact with your eyes, never rub the eyes. Rinse eyes thoroughly with water, and then consult a doctor.

Warning

Risk of fire, explosion and burns. Do not disassemble.

Do not heat the batteries above the following temperatures or incinerate.

Button-type battery **60 °C (140 °F)**

Battery pack **60 °C (140 °F)**

CAUTION

- Danger of explosion if battery is incorrectly replaced. Replace only with the type recommended by the manufacturer.
- When disposing the batteries, please contact your local authorities or dealer and ask for the correct method of disposal.

Warning

Keep the Button-Type battery out of the reach of children. Never put Button-Type battery in mouth. If swallowed call your doctor.

Button-type battery: CR2025

■ Product identification marking

Product	Location
Memory Card Camera-Recorder	Bottom
Battery charger	Bottom
AC adaptor	Bottom

U.S.A./CANADA CONSUMERS: ATTENTION:



A lithium ion battery that is recyclable powers the product you have purchased. Please call 1-800-8-BATTERY for information on how to recycle this battery.

<For USA-California only>

This product contains a CR Coin Cell Lithium Battery which contains Perchlorate Material – special handling may apply.

See www.dtsc.ca.gov/hazardouswaste/perchlorate.

-If you see this symbol-

Information on Disposal in other Countries outside the European Union

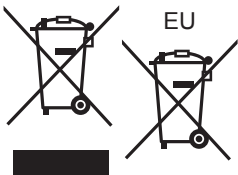

This symbol is only valid in the European Union. If you wish to discard this product, please contact your local authorities or dealer and ask for the correct method of disposal.

IMPORTANT SAFETY INSTRUCTIONS

Read these operating instructions carefully before using the unit. Follow the safety instructions on the unit and the applicable safety instructions listed below. Keep these operating instructions handy for future reference.

- 1) Read these instructions.
- 2) Keep these instructions.
- 3) Heed all warnings.
- 4) Follow all instructions.
- 5) Do not use this apparatus near water.
- 6) Clean only with dry cloth.
- 7) Do not block any ventilation openings. Install in accordance with the manufacturer's instructions.
- 8) Do not install near any heat sources such as radiators, heat registers, stoves, or other apparatus (including amplifiers) that produce heat.
- 9) Do not defeat the safety purpose of the polarized or grounding-type plug. A polarized plug has two blades with one wider than the other. A grounding-type plug has two blades and a third grounding prong. The wide blade or the third prong are provided for your safety. If the provided plug does not fit into your outlet, consult an electrician for replacement of the obsolete outlet.
- 10) Protect the power cord from being walked on or pinched particularly at plugs, convenience receptacles, and the point where they exit from the apparatus.
- 11) Only use attachments/accessories specified by the manufacturer.
- 12) Use only with the cart, stand, tripod, bracket, or table specified by the manufacturer, or sold with the apparatus. When a cart is used, use caution when moving the cart/apparatus combination to avoid injury from tip-over.
- 13) Unplug this apparatus during lightning storms or when unused for long periods of time.
- 14) Refer all servicing to qualified service personnel. Servicing is required when the apparatus has been damaged in any way, such as power-supply cord or plug is damaged, liquid has been spilled or objects have fallen into the apparatus, the apparatus has been exposed to rain or moisture, does not operate normally, or has been dropped.



Brazil Only

Brasil Apenas

<Manuseio de baterias usadas>



BRASIL

Após o uso, as pilhas e/ou baterias poderão ser entregues ao estabelecimento comercial ou rede de assistência técnica autorizada.

Cobrir os terminais positivo (+) e negativo (-) com uma fita isolante adesiva, antes de depositar numa caixa destinada para o recolhimento. O contato entre partes metálicas pode causar vazamentos, gerar calor, romper a blindagem e produzir fogo.

Não desmonte, não remova o invólucro, nem amasse a bateria. O gás liberado pela bateria pode irritar a garganta, danificar o lacre do invólucro ou o vazamento provocar calor, ruptura da blindagem e produzir fogo devido ao curto circuito dos terminais. Não incinere nem aqueça as baterias, elas não podem ficar expostas a temperaturas superiores a 100°C (212°F). O gás liberado pela bateria pode irritar a garganta, danificar o lacre do invólucro ou o vazamento provocar calor, ruptura da blindagem e produzir fogo devido ao curto circuito dos terminais provocado internamente.

Evite o contato com o líquido que vazará das baterias. Caso isto ocorra, lave bem a parte afetada com bastante água. Caso haja irritação, consulte um médico.

Para remover a bateria

Bateria Principal de Energia

Pressione o botão para liberar a bateria.

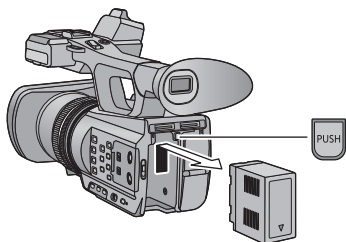

Bateria do Controle Remoto

- 1) Empurre a trava na direção exibida pela seta **A** para remover o suporte.

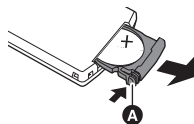

- 2) Remova a bateria tipo botão do suporte da bateria.



■ Cautions for use

Keep this unit as far away as possible from electromagnetic equipment (such as microwave ovens, TVs, video games etc.).

- If you use this unit on top of or near a TV, the pictures and/or sound on this unit may be disrupted by electromagnetic wave radiation.
- Do not use this unit near cell phones because doing so may result in noise adversely affecting the pictures and/or sound.
- Recorded data may be damaged, or pictures may be distorted, by strong magnetic fields created by speakers or large motors.
- Electromagnetic wave radiation generated by microprocessors may adversely affect this unit, disturbing the pictures and/or sound.
- If this unit is adversely affected by electromagnetic equipment and stops functioning properly, turn this unit off and remove the battery or disconnect AC adaptor. Then reinsert the battery or reconnect AC adaptor and turn this unit on.

Do not use this unit near radio transmitters or high-voltage lines.

- If you record near radio transmitters or high-voltage lines, the recorded pictures and/or sound may be adversely affected.

About connecting to a PC

- Do not use any other USB cables except the supplied one.

About using a headphone

- Excessive sound pressure from earphones and headphones can cause hearing loss.
- Listening at full volume for long periods may damage the user's ears.

About using external microphones

- Keep the microphone holder screw, microphone holder adaptor and INPUT terminal cap out of reach of children to prevent swallowing.

About using wireless remote control

- Keep the button-type battery out of reach of children to prevent swallowing.

■ About the recording format for recording motion pictures

You can record motion pictures with AVCHD recording formats using this unit. (→ 30)

- AVCHD Progressive (1080/60p) supported.

AVCHD Progressive:

It is possible to record video with highest quality (1080/60p) possible with this unit.

■ Indemnity about recorded content

Panasonic does not accept any responsibility for damages directly or indirectly due to any type of problems that result in loss of recording or edited content, and does not guarantee any content if recording or editing does not work properly. Likewise, the above also applies in a case where any type of repair is made to the unit.

■ About Condensation (When the lens or the LCD monitor is fogged up)

Condensation occurs when there is a change in temperature or humidity, such as when the unit is taken from outside or a cold room to a warm room. Please be careful, as it may cause the lens or LCD monitor to become soiled, moldy, or damaged.

When taking the unit to a place which has a different temperature, if the unit is accustomed to the room temperature of the destination for about one hour, condensation can be prevented. (When the difference in temperature is severe, place the unit in a plastic bag or the like, remove air from the bag, and seal the bag.) When condensation has occurred, remove the battery and/or the AC adapter and leave the unit like that for about one hour. When the unit becomes accustomed to the surrounding temperature, fogginess will disappear naturally.

■ Caution regarding laser beams



- The lens may suffer damage if struck by a laser beam. Make sure that laser beams do not strike the lens when shooting in an environment where laser devices are used.

■ Cards that you can use with this unit

SD Memory Card, SDHC Memory Card and SDXC Memory Card

- 4 GB or more Memory Cards that do not have the SDHC logo or 48 GB or more Memory Cards that do not have the SDXC logo are not based on SD Memory Card Specifications.
- Refer to page 23 for more details on SD cards.

■ For the purposes of these operating instructions

- The battery pack is referred to as the "Battery".
- SD Memory Card, SDHC Memory Card and SDXC Memory Card are referred to as the "SD card".
- Function that can be used for Recording Mode: 
- Function that can be used for Playback Mode: 
- Pages for reference are indicated by an arrow, for example: → 00

AVCCAM 3 Year Warranty Repair Program*1

Thank you for purchasing this Panasonic AVCCAM device.

Register as a user for this device to receive a special service warranty up to three years of free warranty repairs.



Customers who register as users on the website will receive an extended warranty repair valid for up to three years.

	1 st year	2 nd year	3 rd year
AVCCAM device*2	Basic warranty*3	Extended warranty repair*4	

*1: Please note that this extended warranty is not available in some countries/regions.

*2: Not all models eligible for extended warranty coverage. *3: The basic warranty period may vary depending on the country/region. *4: Not all repair work is covered by this extended warranty.



Details about user registration and the extended warranty:

 http://panasonic.biz/sav/pass_e

Please note, this is a site that is not maintained by Panasonic Canada Inc. The Panasonic Canada Inc. privacy policy does not apply and is not applicable in relation to any information submitted. This link is provided to you for convenience.

Contents

■ How to open the Operating Instructions PDF file

When you insert the CD-ROM and open the [INDEX.pdf] in the CD-ROM, the Operating Instructions list will be displayed. Click the document name of the Operating Instructions you would like to open.

- Adobe Reader is required to view the PDF file. Please download it from the homepage of Adobe Systems Incorporated.

Information for Your Safety	2
Accessories	12
Optional accessories.....	13

Preparation

Names and Functions of Main Parts	14
Power supply	19
Charging the battery	19
Inserting/removing the battery.....	20
Charging and recording time.....	21
Connecting to the AC outlet	22
Preparation of SD cards	23
Cards that you can use with this unit.....	23
Inserting/removing an SD card.....	23
Turning the unit on/off	24
Selecting a mode	24
Using the LCD monitor/Viewfinder	25
Using the LCD monitor.....	25
How to use the touch screen	26
Viewfinder adjustment.....	26
Setting date and time	27
Using the menu screen	28
Formatting cards	29
Language Selection	29

Recording

Selecting a media to record	29
Recording motion pictures	30
Recording still pictures	30
Using the zoom	31
Intelligent Auto Mode/Manual Mode	31
Manual Recording	32
Focus	32
White Balance.....	32
Iris adjustment	32
Manual shutter speed	33
USER button	33
Setting the USER button.....	33
Using the USER button.....	34
Functions of the USER button	34

Playback

Motion picture/Still picture playback	35
Watching Video/ Pictures on your TV	36

Others

Specification	37
About copyright	39

Accessories

Check the accessories before using this unit.

Keep the accessories out of reach of children to prevent swallowing.

Battery pack



Battery charger

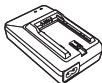

AC adaptor



AC cable

(AG-AC90P/PJ)

Ⓐ for AC adaptor

Ⓑ for Battery charger

• U.S.A

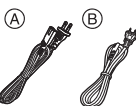

(AG-AC90PX)

2 cables

• Taiwan



Eye cup



Remote control (Battery built-in)



CD-ROM

Operating Instructions



USB cable

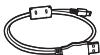

AV multi cable



Lens cap



Shoulder strap



Microphone holder



INPUT terminal cap (2 caps)



Microphone holder adaptor



Microphone holder screws

6 mm (0.24 ") length
(2 screws)



12 mm (0.47 ") length
(2 screws)



Optional accessories

Some optional accessories may not be available in some countries.

XLR microphone (AG-MC200G)
HDMI cable (RP-CHES15)
SD/SDHC/SDXC Memory Card (Refer to page 23)
(AG-AC90P/PJ)
Battery pack (lithium/CGA-D54)
Wide conversion lens (VW-W4907H)*
Filter kit (VW-LF49N)*
(AG-AC90PX)
Battery pack (lithium/CGA-D54s)

* Remove the lens cap (supplied).

Product numbers correct as of Oct. 2012.

These may be subject to change.

(AG-AC90P/PJ)

■ Attaching the wide conversion lens/filter kit

Attach the wide conversion lens (VW-W4907H; optional), ND filter or MC protector of the Filter kit (VW-LF49N; optional) in front of the lens.

- It is not possible to attach it to the front of the lens hood.

Be careful about the following.

When 2 lens accessories, such as the ND filter and wide conversion lens, are fitted and the zoom lever is pressed toward the W side, the 4 corners of an image will be darkened. (Vignetting)

Attaching the lens cap of the Filter Kit (VW-LF49N; optional)

- When the filter kit (VW-LF49N; optional) is used, protect the lens surface while the unit is not used with the lens cap supplied with the filter kit.

Names and Functions of Main Parts

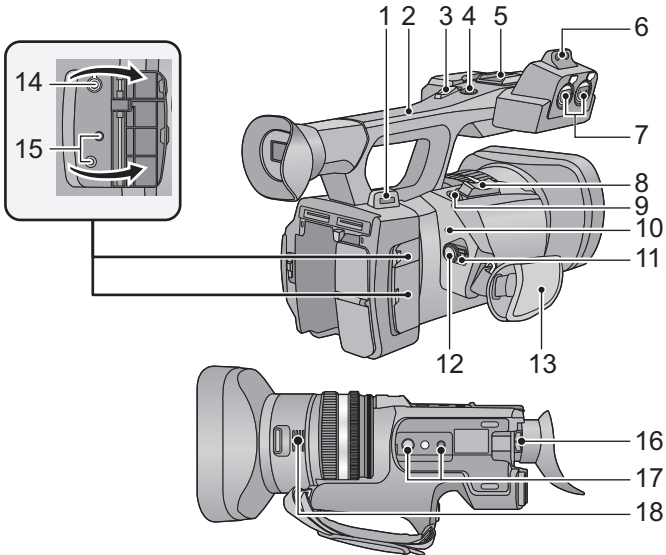

- 1 Shoulder strap fixture (→ 17)
- 2 Handle
- 3 Sub zoom lever (→ 31)
 - This lever functions in the same manner as the zoom lever.
- 4 Sub recording start/stop button
 - This button functions in the same manner as the recording start/stop button.
- 5 Accessory shoe
- 6 Microphone holder attachment part
- 7 Audio input terminals 1, 2 (XLR 3 pin) [AUDIO INPUT1, 2]
- 8 Zoom lever [T/W] (In Recording Mode) (→ 31)
 - Volume lever [+VOL-]/Thumbnail display switch [Q/] (In Playback Mode)
- 9 Photoshot button [] (→ 30)
- 10 Status indicator (→ 24)
- 11 Power switch (→ 24)
- 12 Recording start/stop button (→ 30)
- 13 Grip belt (→ 17)
- 14 Headphone terminal []

- 15 Camera remote jack [CAM REMOTE] [CAM REMOTE] (3.5 mm (0.14 ") mini jack)
 - It is possible to adjust the focus or iris connecting with the remote control (optional).
 - It is not possible to use the remote control (optional) in the Intelligent Auto Mode.
- [ZOOM S/S] (2.5 mm (0.1 ") super mini jack)
 - It is possible to operate zoom operation or recording start/stop connecting with the remote control (optional).
 - Do not connect any equipment except the remote control (optional) to the camera remote jack. Brightness of the image may change or it may not focus when an equipment other than the remote control (optional) is connected.
- 16 Eyepiece corrector lever (→ 26)
- 17 Tripod receptacle
- 18 Inlet (cooling fan)

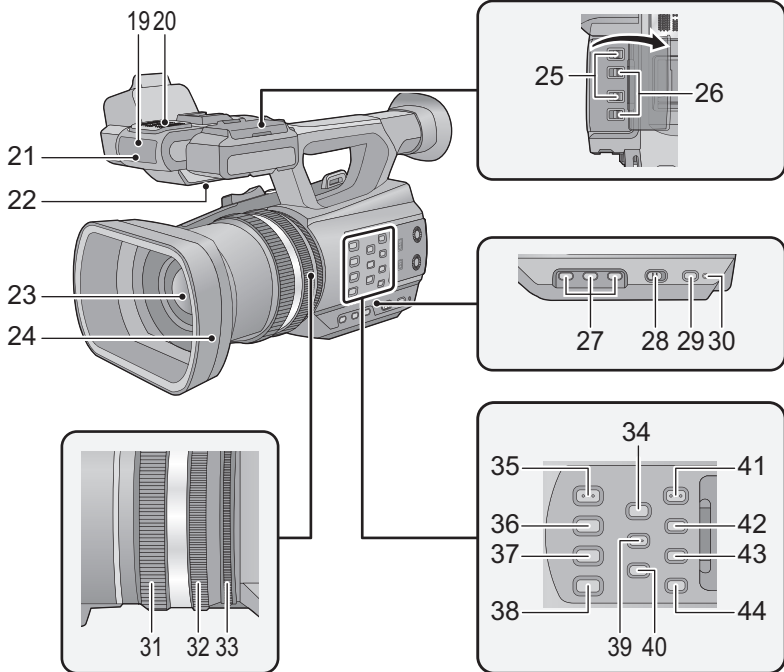

- 19 Wireless remote control sensor
- 20 Internal microphones
- 21 Recording lamp
- 22 Speaker
- 23 Lens (→ 18)
- 24 Lens hood
- 25 INPUT 1, 2 (LINE/MIC) switches
- 26 INPUT 1, 2 (+48V) switches
- 27 User 1, 2, 3 buttons [USER1, USER2, USER3] (→ 33)
- 28 Intelligent auto/Manual switch [i/MANU] (→ 31)
- 29 Quick start button [QUICK START]
- 30 Quick start lamp
- 31 Focus ring (→ 32)
- 32 Zoom ring (→ 31)
- 33 Iris ring (→ 32)
- 34 Focus assist button [FOCUS ASSIST]
- 35 Iris auto/Manual button [IRIS A/M] (→ 32)
- 36 Focus auto/Manual/∞ button [FOCUS A/M/∞] (→ 32)
- 37 Optical image stabilizer button [O.I.S.]
- 38 White balance button [W.B.] (→ 32)
- 39 Zebra button [ZEBRA]
- 40 Color Bar Screen button [BARS]
- 41 Menu button [MENU] (→ 28)
- 42 Display/Mode check button [DISP/ MODE CHK]
- 43 Counter button [COUNTER]
- 44 Counter reset button [RESET]

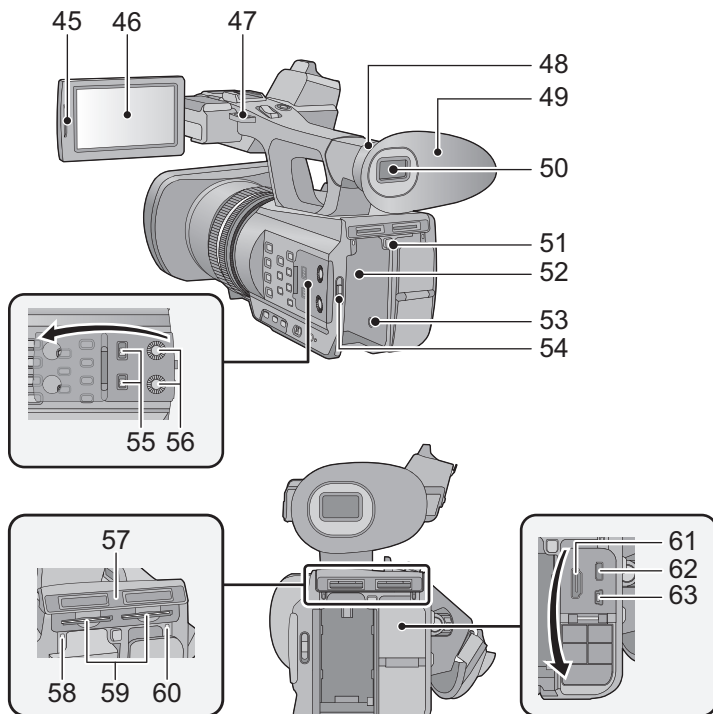

45 LCD monitor extract part [PULL] (→ 25)

46 LCD monitor (Touch screen) (→ 26)

47 Shoulder strap fixture (→ 17)

48 Eye cup attachment part (→ 17)

49 Eye cup (→ 17)

50 Viewfinder (→ 26)

51 Battery release button [PUSH] (→ 20)

52 Battery holder (→ 20)

53 DC input terminal [DC IN] (→ 22)

• Do not use any other AC adaptors except the supplied one.

54 Mode switch (→ 24)

55 CH1, CH2 switches [CH1, CH2]

56 Audio control knobs [CH1, CH2]

57 SD Card slot cover (→ 23)

58 Access lamp (card 1) (→ 23)

59 Card slot 1 (left)
Card slot 2 (right) (→ 23)

60 Access lamp (card 2) (→ 23)

61 HDMI connector [HDMI] (→ 36)

62 AV multi connector [AV MULTI] (→ 36)

• Use the AV multi cable (only the supplied cable).

63 USB terminal [USB 2.0]

■ Adjust the length of the grip belt so that it fits your hand.

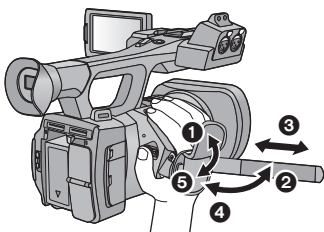

- 1, 2 Flip the belt cover and the belt.
- 3 Adjust the length.
- 4, 5 Replace the belt.

■ Attaching the eye cup

Attach by aligning the notch of the eye cup attachment part with the protrusion at the inside of the eye cup.

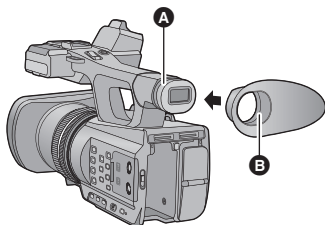

- A Notch
- B Protrusion

■ Attaching the Shoulder strap

We recommend that you attach the shoulder strap (supplied) before going out of doors to record so as to avoid dropping this unit.

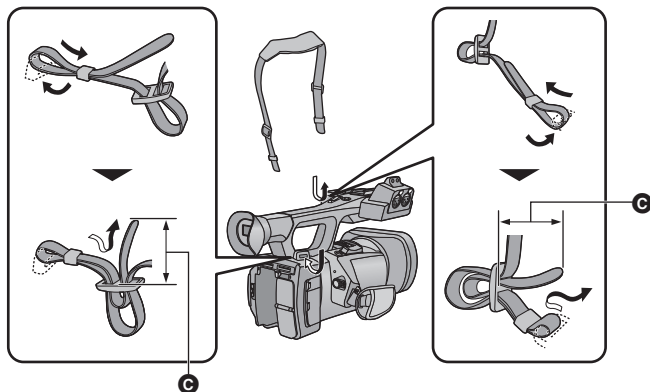

- C 20 mm (0.8 ") or longer

■ Attaching the lens cap

Protect the lens surface with the lens cap while the unit is not used.

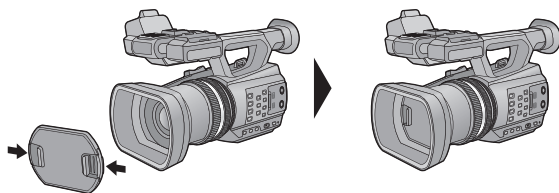

Attach or remove it by pinching on it.

Power supply

■ About batteries that you can use with this unit

(AG-AC90P/PJ)

The battery that can be used with this unit is CGA-D54.

(AG-AC90PX)

The battery that can be used with this unit is CGA-D54s.

It has been found that counterfeit battery packs which look very similar to the genuine product are made available to purchase in some markets. Some of these battery packs are not adequately protected with internal protection to meet the requirements of appropriate safety standards. There is a possibility that these battery packs may lead to fire or explosion. Please be advised that we are not liable for any accident or failure occurring as a result of use of a counterfeit battery pack. To ensure that safe products are used we would recommend that a genuine Panasonic battery pack is used.

Charging the battery

When this unit is purchased, the battery is not charged. Charge the battery fully before using this unit for the first time.

Important:

- Do not use the AC cable with any other equipment as it is designed only for this unit. Also, do not use the AC cable from other equipment with this unit.
- It is recommended to charge the battery in a temperature between 10 °C and 30 °C (50 °F to 86 °F).

(The battery temperature should also be the same.)

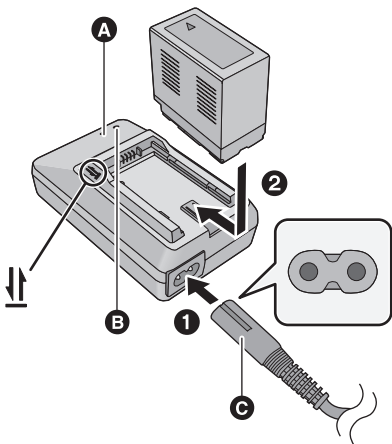

Charging lamp [CHARGE] **A**

Lights up:

Charging (Battery charging time: → 21)

Goes off:

Charging completed

Flashing:

Be sure to connect the unit correctly

Power lamp **B**

- This will light up when the AC cable is connected.

C AG-AC90P/PJ: AC cable (K2CA2CA00025; supplied)

AG-AC90PX: AC cable (K2CA2YY00129; supplied)

- Insert the plugs as far as they will go.

1 Connect the AC cable to the battery charger and the AC outlet.

(AG-AC90P/PJ only)

- Use the AC cable (K2CA2CA00025; supplied) dedicated for the battery charger.

2 Insert the battery into the battery charger by aligning the arrows.

- We recommend using Panasonic batteries (→ 13, 19).
- If you use other batteries, we cannot guarantee the quality of this product.
- Do not heat or expose to flame.
- Do not leave the battery(ies) in a car exposed to direct sunlight for a long period of time with doors and windows closed.

Inserting/removing the battery

Install the battery by inserting it in the direction shown in the figure.

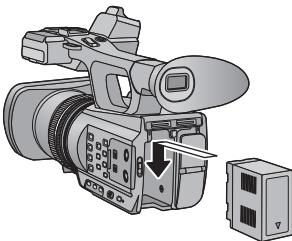

Insert the battery until it clicks and locks.

Removing the battery

Make sure that the power switch is set to OFF and the status indicator is turned off, and then remove by holding onto it taking care not to drop. (→ 24)

While pressing the battery release button, remove the battery.

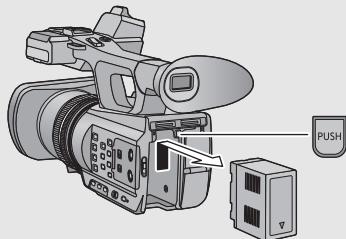

Charging and recording time

■ Charging/Recording time



- Temperature: 25 °C (77 °F)/humidity: 60%RH
- When using the viewfinder (times in parentheses are when using the LCD monitor)

Battery model number [Voltage/Capacity (minimum)]	Charging time	Recording format	Maximum continuously recordable time	Actual recordable time
Supplied battery/CGA-D54 and CGA-D54s (optional) [7.2 V/5400 mAh]	6 h	PS 1080/60p	6 h 25 min (5 h 45 min)	4 h (3 h 35 min)
		PH 1080/60i	6 h 45 min (6 h)	4 h 10 min (3 h 40 min)
		PH 1080/30p	6 h 50 min (6 h 5 min)	4 h 15 min (3 h 45 min)
		PH 1080/24p	7 h 10 min (6 h 20 min)	4 h 25 min (3 h 55 min)
		HA 1080/60i	6 h 45 min (6 h)	4 h 10 min (3 h 45 min)
		HE 1080/60i	6 h 55 min (6 h 5 min)	4 h 15 min (3 h 45 min)
		SA 480/60i	7 h 5 min (6 h 15 min)	4 h 20 min (3 h 50 min)

- These times are approximations.
- **The indicated charging time is for when the battery has been discharged completely. Charging time and recordable time vary depending on the usage conditions such as high/low temperature.**

- The actual recordable time refers to the recordable time when repeatedly starting/stopping recording, turning the unit on/off, moving the zoom lever etc.
- The batteries heat up after use or charging. This is not a malfunction.

Battery capacity indication

- The display changes as the battery capacity reduces.  →  will flash red.

Connecting to the AC outlet

The unit is in the standby condition when the AC adaptor is connected. The primary circuit is always "live" as long as the AC adaptor is connected to an electrical outlet.

Important:

- Use the supplied AC adaptor. Do not use the AC adaptor of another device.
- Do not use the AC cable with any other equipment as it is designed only for this unit. Also, do not use the AC cable from other equipment with this unit.

(AG-AC90P/PJ)

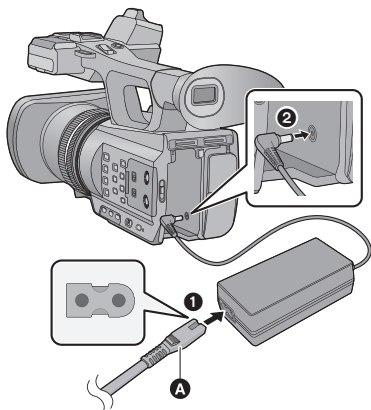

(AG-AC90PX)

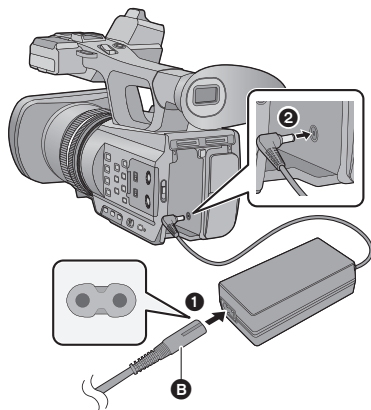

A AC cable (K2CB2CB00022; supplied)

- Insert the plugs as far as they will go.

B AC cable (K2CA2YY00129; supplied)

1 Connect the AC cable to the AC adaptor and the AC outlet.

(AG-AC90P/PJ only)

- Use the AC cable (K2CB2CB00022; supplied) dedicated for the AC adaptor.

2 Connect the AC adaptor to the DC input terminal [DC IN].

■ Removing the AC adaptor

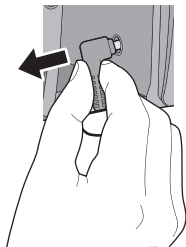

- Make sure to set the power switch to OFF and the status indicator is turned off when disconnecting the AC adaptor.

Preparation of SD cards

The unit can record motion pictures or still pictures to an SD card.

This unit (an SDXC compatible device) is compatible with SD Memory Cards, SDHC Memory Cards and SDXC Memory Cards. When using an SDHC Memory Card/SDXC Memory Card with other equipment, check the equipment is compatible with these Memory Cards.

Cards that you can use with this unit

Use SD cards conforming to Class 4 or higher of the SD Speed Class Rating for motion picture recording.

- Please check the latest information on the support website below.
<http://pro-av.panasonic.net>
- Keep the Memory Card out of reach of children to prevent swallowing.

Inserting/removing an SD card

When using a non Panasonic SD card for the first time, or one which was previously used on another equipment, it is necessary to format the SD card. (→ 29) When the SD card is formatted, all of the recorded data is deleted. Once the data is deleted, it cannot be restored.

Caution:

Check that the access lamp has gone off.

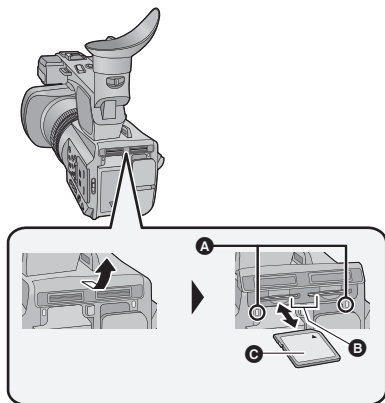

Access lamp **A**

- When this unit is accessing the SD card, the access lamp lights up.

1 Open the SD card slot cover and insert (remove) the SD card into (from) the card slot **B**.

- One SD card can be inserted into each of the card slot 1 and the card slot 2.
- Face the label side **C** in the direction shown in the illustration and press it straight in as far as it will go.
- Press the center of the SD card and then pull it straight out.

2 Securely close the SD card slot cover.

- Securely close it until it clicks.

Turning the unit on/off

Set the power switch to ON while pressing the lock release button **B** to turn on the unit.

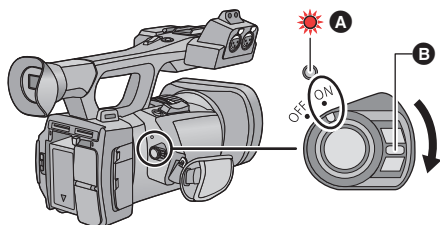

To turn off the unit

Set the power switch to OFF while pressing the lock release button. The status indicator goes off.

A The status indicator lights on.



- To turn on the unit again after the [ECONOMY (BATT)] or [ECONOMY (AC)] is activated, set the power switch to OFF once, and then to ON again.

Selecting a mode

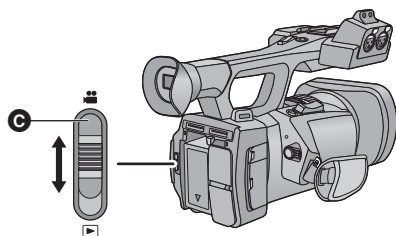
Operate the mode switch to change the mode to  or .



C Mode switch

	Recording Mode (→ 30)
	Playback Mode (→ 35)

Using the LCD monitor/Viewfinder

The viewfinder is turned off and the LCD monitor is turned on when the LCD monitor is extracted. The viewfinder is turned on when the LCD monitor is retracted.

Using the LCD monitor

1 Extract the LCD monitor in the direction as indicated in the figure.

- Hold the LCD monitor extract part **A** when pulling out.

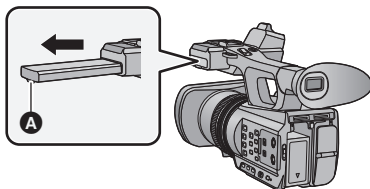

2 Rotate to the position that is easy to view.

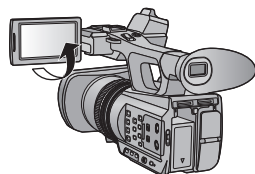

To retract the LCD monitor

Retract as shown in the figure with the LCD facing downward.

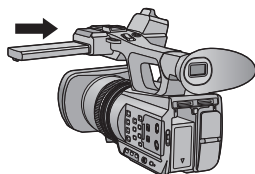

Range of rotation of the LCD monitor

- It can rotate up to 270° **B** towards the lens.

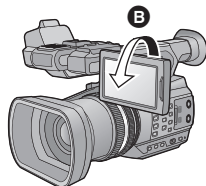

How to use the touch screen

You can operate by directly touching the LCD monitor (touch screen) with your finger.

■ Touch

Touch and release the touch screen to select icon or picture.

- Touch the center of the icon.
- Touching the touch screen will not operate while you are touching another part of the touch screen.

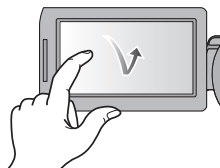

■ Slide while touching

Move your finger while pressing on the touch screen.

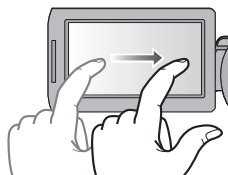

■ About the operation icons



Touch when changing a page or performing settings.



Touch to return to the previous screen.



- Do not touch the LCD monitor with hard pointed tips, such as ball point pens.

Viewfinder adjustment

- These settings will not affect the images actually recorded.

Adjusting the field of view

It adjusts the field of view to show the image on the viewfinder clearly.

1 Adjust the viewfinder to suit your vision so that you can see the display images clearly.

- Be careful not to trap your fingers when moving the viewfinder.
- The viewfinder can be lifted vertically up to approximately 90°.
- Retract the LCD monitor and turn on the viewfinder.

2 Adjust the focus by rotating the eyepiece corrector lever.

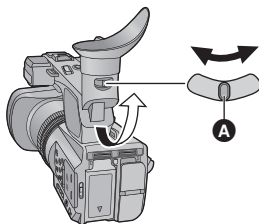

A Eyepiece corrector lever

Setting date and time

When the unit is turned on for the first time, a message asking you to set the date and time will appear.

Select [YES] and perform steps 2 to 3 below to set the date and time.

1 Select the menu. (→ 28)

MENU



[OTHER FUNCTION] → [CLOCK SET]

2 Touch the date or time to be set, then set the desired value using ▲/▼.

- The year can be set between 2000 and 2039.

Example: AG-AC90PJ



3 Touch [ENTER].

- The screen may switch to the setting screen for the [TIME ZONE]. Touch the screen and set the [TIME ZONE].
 - Touch [EXIT] to complete the setting.
-
- The date and time function is driven by a built-in lithium battery.
 - If the time display becomes [- -], the built-in lithium battery needs to be charged. To recharge the built-in lithium battery, connect the AC adaptor or attach a charged battery to this unit. Leave the unit as it is for approx. 24 hours and the battery will maintain the date and time for approx. 6 months. (The battery is still being recharged even if the unit is off.)
 - The way that time is displayed can be changed in the menu settings. [SW & DISP SETUP] → [DATE/TIME] or [DATE FORMAT]

Using the menu screen

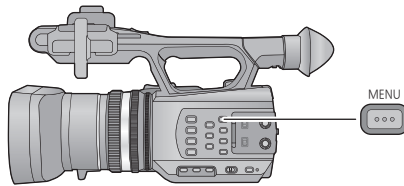

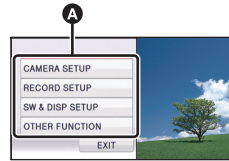

1 Press the MENU button .

2 Touch the top menu **A**.



3 Touch the submenu **B**.

- Next (Previous) page can be displayed by touching  / .

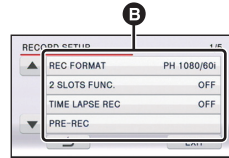

4 Touch the desired item to enter the setting.

5 Touch [EXIT] to exit the menu setting.

Formatting cards

If you use the SD cards for the first time for recording with this unit, format the cards. Please be aware that if a medium is formatted, then all the data recorded on the medium will be erased and cannot be restored. Back up important data on a PC, disc etc.

- When using two SD cards, format both SD cards.

Select the menu.

MENU : [OTHER FUNCTION] → [FORMAT CARD] → [SD CARD 1] or [SD CARD 2]

Language Selection

You can select the language on the screen display and the menu screen.

1 Select the menu.

MENU : [OTHER FUNCTION] → [LANGUAGE]

2 Touch the desired setting language.

Recording



Selecting a media to record

[SD CARD 1] and [SD CARD 2] can be selected separately to record motion pictures or still pictures.

1 Select the menu.

MENU : [SW & DISP SETUP] → [MEDIA SELECT]

2 Touch the media to record motion pictures or still pictures.

- The media is selected separately for motion pictures or still pictures and is then highlighted in yellow.

3 Touch [ENTER].

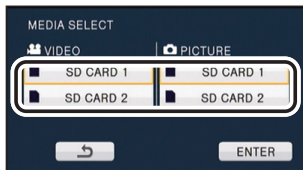



Recording motion pictures



1 Change the mode to .

- Extract the LCD monitor.

2 Press the recording start/stop button to start recording.

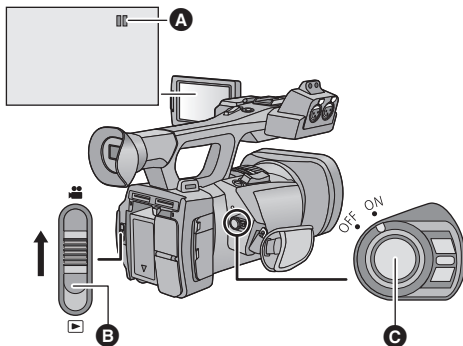
- Recording will stop when you press the recording start/stop button again.



- A** When you begin recording,  changes to .
- B** Mode switch



Recording still pictures

1 Change the mode to .

- Extract the LCD monitor.

2 Press the button.

- When photos are being recorded, the remaining recordable number of photos and the photo operation display  are displayed.

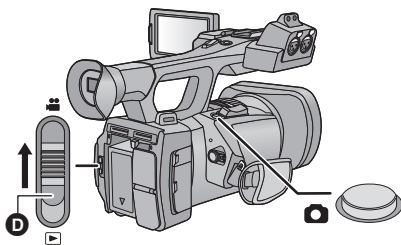

- D** Mode switch



Using the zoom

It can be zoomed up to 12×.

- It can zoom up to 25× when the [i.Zoom] is set to [ON].
- Zoom magnification can be checked in the screen display of Z00 to Z99. The value gets larger when zoomed in, and the value gets smaller when zoomed out. **Z99** is displayed during the i.Zoom.

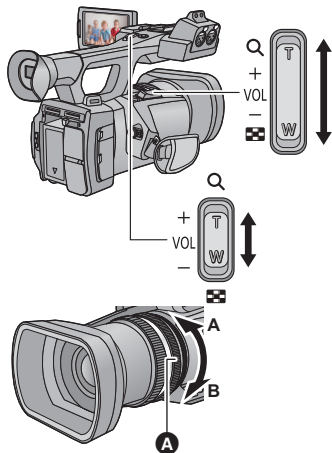

Zoom lever/Sub zoom lever

T side:

Close-up recording (zoom in)

W side:

Wide-angle recording (zoom out)

Ring Zoom

Zoom by rotating the ring.

A side:

Wide-angle recording (zoom out)

B side:

Close-up recording (zoom in)

A Zoom ring



Intelligent Auto Mode/Manual Mode

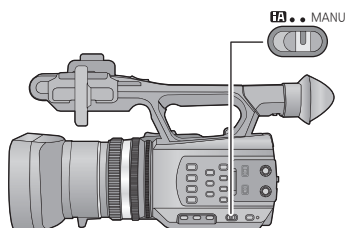

iA/MANU switch

Slide the switch to change the Intelligent Auto Mode/Manual Mode.

- **MNL** is displayed in the Manual Mode.
- The modes appropriate for the condition are set just by pointing the unit to what you want to record in the Intelligent Auto Mode.



Manual Recording

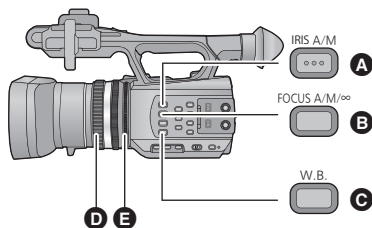

- A** IRIS A/M button
- B** FOCUS A/M/∞ button
- C** W.B. button
- D** Focus ring
- E** Iris ring

Focus

Perform focus adjustments using the focus ring. If auto focusing is difficult due to the conditions, then use Manual Focus.

- Switch to Manual Mode. (→ 31)

1 Press the FOCUS A/M/∞ button to switch to Manual Focus.

- It will switch to MF from AF.

2 Adjust the focus by rotating the focus ring.

White Balance

Automatic White Balance function may not reproduce natural colors depending on the scenes or lighting conditions. If so, you can adjust the White Balance manually.

Switch the modes of White Balance by pressing the W.B. button.

Iris adjustment

Perform Iris/Gain adjustments using the iris ring. Adjust it when the screen is too bright or too dark.

- Switch to Manual Mode. (→ 31)

1 Press the IRIS A/M button to switch to Manual Iris Mode.

- **STD** disappears.
- The gain is displayed in dB.

2 Adjust the iris by rotating the iris ring.

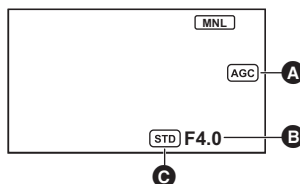

- A** Gain value
 - B** Iris value
 - C** Auto iris icon*
- * It is displayed in Auto Iris Mode.

Manual shutter speed

Adjust the shutter speed when recording fast-moving subjects.

- Switch to Manual Mode. (→ 31)

1 Touch the LCD monitor to display the operation icons and touch .

2 Touch  /  to adjust settings.

- When [AUTO] is touched, the shutter speed is set automatically.
- Touch  to complete the adjustment.

Recording



USER button

Each of the USER button can register one function from the 12 available functions.

- There are three USER buttons (USER1 to USER3) on the main body and four USER button icons (USER4 to USER7) displayed on the LCD monitor.

Setting the USER button

1 Select the menu.

 : [SW & DISP SETUP] → [USER BUTTON SETUP]

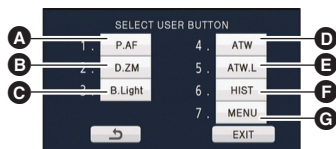

2 Touch the USER button you wish to set.



- A** USER1 button
- B** USER2 button
- C** USER3 button
- D** USER4 button
- E** USER5 button
- F** USER6 button
- G** USER7 button

- The USER button number and currently set function name are displayed. (For example, a display of 1. [P.AF] means that Push AF has been assigned to USER1 button.)

3 Touch the item to register.

- For the functions of the USER button that can be registered, refer to page 34.
- Touch [INH] (Inhibit) if not registering.
- Next (Previous) page can be displayed by touching  / .
- To continuously set other USER buttons, repeat steps 2-3.

4 Touch [EXIT] to complete the setting.

Using the USER button

To use the set USER button, press USER1 to USER3 button or touch the USER4 to USER7 button icon displayed when you touch the LCD monitor.

(When you use the USER1 to USER3)

(When you use the USER4 to USER7)

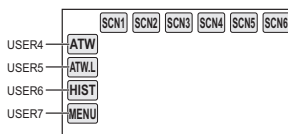
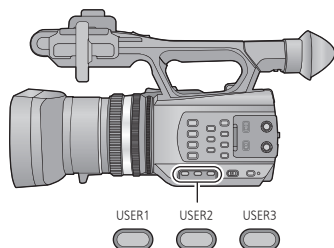

Functions of the USER button

■ List of USER button function

Icon	Item	Function
[P.AF]	[PUSH AF]	Push AF
[B.Light]	[BACKLIGHT]	Backlight Compensation
[S.Light]	[SPOTLIGHT]	Spotlight
[B.FD]	[BLACK FADE]	Black Fade
[W.FD]	[WHITE FADE]	White Fade
[ATW]	[ATW]	ATW
[ATW.L]	[ATW LOCK]	ATW Lock
[D.ZM]	[D.ZOOM]	Digital Zoom
[HIST]	[HISTOGRAM]	Histogram
[REC.C]	[REC CHECK]	Recording Check
[LstDel]	[LAST SCN DEL]	Last Scene Delete
[MENU]	[MENU]	Menu



Motion picture/Still picture playback



- 1** Change the mode to .
- 2** Touch the play mode select icon **A**.
- 3** Select the [MEDIA] and [VIDEO/PICTURE] you wish to play back.
 - Touch [ENTER].
- 4** Touch the scene or the still picture to be played back.
 - The recording format is displayed in the thumbnail display of the motion pictures. (PH, PS, etc.)
 - Next (Previous) page can be displayed by touching / .
- 5** Select the playback operation by touching the operation icon.

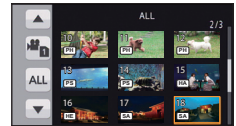

B Operation icon

- To play or pause a video, touch .
- If you touch the screen while an operation icon is being displayed or do not touch the icon for a certain period, it will disappear. To display again, touch the screen.

Watching Video/Pictures on your TV

Connect this unit to a TV.

- A** HDMI connector
- B** AV multi connector
- Please use "High Speed HDMI Cables" that have the HDMI logo (as shown on the cover). Cables not conforming to the HDMI standard will not work. Panasonic HDMI cable is recommended. Part No.: RP-CHES15 (1.5 m) (4.9 feet)
- Do not use any other AV multi cables except the supplied one.
- Use the AV multi cable (supplied) or HDMI cable (optional) and check the output settings.

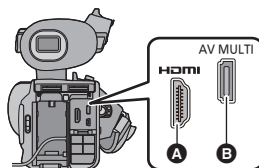

Specification

Memory Card Camera-Recorder

Information for your safety

Power source: DC 12 V (When using AC adaptor)
DC 7.2 V (When using battery)

Power consumption: 12.9 W

Recording format:

AVCHD format version 2.0 compliant
(AVCHD Progressive)

Motion picture compression:

MPEG-4 AVC/H.264

Audio compression:

Dolby® Digital (5.1 ch/2 ch)

Recording mode and transfer rate:

[PS 1080/60p]; Approx. 25 Mbps (VBR)

[PH 1080/60i]; Approx. 21 Mbps (VBR)

[PH 1080/30p]; Approx. 21 Mbps (VBR)

[PH 1080/24p]; Approx. 21 Mbps (VBR)

[HA 1080/60i]; Approx. 17 Mbps (VBR)

[HE 1080/60i]; Approx. 6 Mbps (VBR)

[SA 480/60i]; Approx. 9 Mbps (VBR)

Refer to the operating instructions Vol.2 for the recordable time and picture size.

Still picture recording format:

JPEG corresponding (Design rule for Camera File system, based on Exif 2.2 standard)

Refer to the operating instructions Vol.2 for the picture size and number of recordable pictures.

Recording media:

SD Memory Card

SDHC Memory Card

SDXC Memory Card

Refer to page 23 for details on SD cards usable in this unit.

Image sensor:

1/4.7" 3MOS image sensor

Approx. 8040 K (2680 K×3)

Lens:

Auto Iris optical zoom (Full range AF)

F value (focal length)

F1.5 to F2.8 (Focal length; 2.84 mm to 34.1 mm)

35 mm equivalent;

Motion picture/Still picture; 29.8 mm to 383.7 mm (16:9)

Minimum focus distance;

Approx. 3.5 cm (1.4") (Wide/

Approx. 1.2 m (3.9 feet) (Tele)

Filter diameter:

49 mm

Zoom:

12× optical zoom, 25× i.Zoom,

2×/5×/10× digital zoom

Image stabilizer function:

Optical (Hybrid Optical Image Stabilizer, Active Mode)

Monitor:

3.5" wide LCD monitor (Approx. 1152 K dots)

Viewfinder:

0.24" wide EVF

(Approx. 263 K dots equivalent)

Microphone:

5.1 channel surround microphone (with a zoom microphone/focus microphone function)/stereo microphone

Minimum required illumination:

Approx. 3 lx (1/30 with [AUTO SLOW SHTR] is set to [ON], Intelligent Auto Mode)

AV multi connector video output level:

Component video output level;

Y; 1.0 Vp-p, 75 Ω

Pb; 0.7 Vp-p, 75 Ω

Pr; 0.7 Vp-p, 75 Ω

AV video output level;

1.0 Vp-p, 75 Ω

HDMI connector video output level:

HDMI™ 1080p/1080i/480p

AV multi connector audio output level

(Line):

2 ch

HDMI connector audio output level:

Dolby Digital/Linear PCM

Headphone output:

3.5 mm stereo mini jack

Camera remote terminal:

2.5 mm super mini jack \times 1 (ZOOM S/S)

3.5 mm mini jack \times 1 (FOCUS/IRIS)

XLR audio input terminals:

XLR (3 pin) \times 2 (INPUT1/INPUT2)

LINE; 0 dBu

MIC; -50 dBu/ -60 dBu (switch with the menu)

USB:

Reader function (No copyright protection support),

Hi-Speed USB (USB 2.0), USB terminal Type Mini B

Dimensions:

160 mm (W) \times 195 mm (H) \times 350 mm (D)

[6.30 " (W) \times 7.68 " (H) \times 13.8 " (D)]

(including projecting parts)

Mass (Weight):

Approx. 1500 g (Approx. 3.30 lbs.)

[without battery (supplied) and an SD card (optional)]

Mass (Weight) in operation:

Approx. 1780 g (Approx. 3.90 lbs.)

[with battery (supplied) and an SD card (optional)]

Operating temperature:

0 °C to 40 °C (32 °F to 104 °F)

Operating humidity:

10%RH to 80%RH

Battery operation time:

See page 21

AC adaptor

Information for your safety

Power source:	AC 110 V to 240 V, 50/60 Hz
----------------------	--------------------------------

Power consumption:	42 W
DC output:	DC 12 V, 2.5 A

Dimensions:

115 mm (W) \times 37 mm (H) \times 57 mm (D)

[4.53 " (W) \times 1.46 " (H) \times 2.24 " (D)]

Mass (Weight):

Approx. 210 g (Approx. 0.46 lbs.)

Battery charger

Information for your safety

Power source:	AC 100 V to 240 V, 50/60 Hz
----------------------	--------------------------------

Power consumption:	0.4 A
DC output:	DC 8.4 V, 1.2 A

Dimensions:

70 mm (W) \times 44.5 mm (H) \times 116 mm (D)

[2.76 " (W) \times 1.75 " (H) \times 4.57 " (D)]

Mass (Weight):

Approx. 160 g (Approx. 0.35 lbs.)

About copyright

■ Carefully observe copyright laws

IMPORTANT

“Unauthorized recording of copyrighted television programs, video tapes and other materials may infringe the right of copyright owners and be contrary to copyright laws.”

■ Licenses

- SDXC Logo is a trademark of SD-3C, LLC.
 - “AVCHD”, “AVCHD Progressive” and the “AVCHD Progressive” logo are trademarks of Panasonic Corporation and Sony Corporation.
 - Manufactured under license from Dolby Laboratories. Dolby and the double-D symbol are trademarks of Dolby Laboratories.
 - HDMI, the HDMI Logo, and High-Definition Multimedia Interface are trademarks or registered trademarks of HDMI Licensing LLC in the United States and other countries.
 - Microsoft®, Windows® and Windows Vista® are either registered trademarks or trademarks of Microsoft Corporation in the United States and/or other countries.
 - Mac and Mac OS are trademarks of Apple Inc., registered in the U.S. and other countries.
 - Other names of systems and products mentioned in these instructions are usually the registered trademarks or trademarks of the manufacturers who developed the system or product concerned.
- This product is licensed under the AVC patent portfolio license for the personal and non-commercial use of a consumer to (i) encode video in compliance with the AVC Standard (“AVC Video”) and/or (ii) decode AVC Video that was encoded by a consumer engaged in a personal and non-commercial activity and/or was obtained from a video provider licensed to provide AVC Video. No license is granted or shall be implied for any other use. Additional information may be obtained from MPEG LA, LLC. See <http://www.mpegla.com>.
- Separate license contracts must be obtained from MPEG LA where SD Memory Cards containing information recorded with this product are to be distributed to end users for commercial purposes. “End user” refers to persons or organizations handling such contents for personal use.

Panasonic Corporation

Web Site: <http://panasonic.net>

© Panasonic Corporation 2012

Download from [Www.Somanuals.com](http://www.Somanuals.com). All Manuals Search And Download.

Free Manuals Download Website

<http://myh66.com>

<http://usermanuals.us>

<http://www.somanuals.com>

<http://www.4manuals.cc>

<http://www.manual-lib.com>

<http://www.404manual.com>

<http://www.luxmanual.com>

<http://aubethermostatmanual.com>

Golf course search by state

<http://golfingnear.com>

Email search by domain

<http://emailbydomain.com>

Auto manuals search

<http://auto.somanuals.com>

TV manuals search

<http://tv.somanuals.com>