



STARCK

WITH



OREGON SCIENTIFIC

**Full Weather Station with Radio Controlled
Clock and Projection
(Model #: PS-M02 / PS-M02U)**

User Manual



EN

TABLE OF CONTENTS

About this guide	2
Product overview	3
Getting started	8
Batteries	8
AC power adapter	8
Switch between modes	8
Change settings	9
Remote unit setup	9
Clock	10
Alarm	11
Calendar	12
Moon phase	12
Barometer	13
Weather forecast	14
Temperature & humidity	14
Backlight	17

Projector	18
Reset system	19
Safety and care	20
Warnings	20
Troubleshooting	21
Specifications	22
Additional resources	25

ABOUT THIS GUIDE

Congratulations on your selection of the Philippe Starck with Oregon Scientific Full Weather Station with Radio Controlled Clock and Projection (PS-M02 / PS-M02U). This powerful device bundles time keeping, alarm, indoor and wireless outdoor temperature and humidity monitoring, weather forecasting, and projection features into a single tool you can use from the convenience of your home.

Keep this manual handy as you use your new product. It contains practical step-by-step instructions, as well as technical specifications and warnings you should know.

In this box, you will find:

- Main unit
- Remote sensor
- Batteries
- AC/DC power adapter

PRODUCT OVERVIEW

TOP VIEW

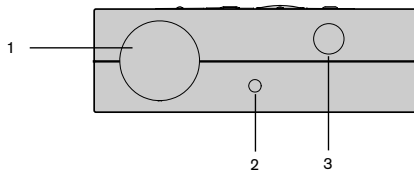

DESCRIPTIONS

1. Snooze / Light button
2. Light sensor
3. Projection lens

EN

LCD DISPLAY

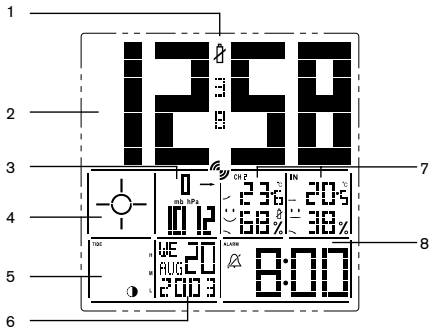

DESCRIPTIONS

1. Low battery icon
2. Clock
3. Barometer
4. Weather forecast
5. Moon phase
6. Calendar
7. Temperature and humidity
8. Alarm



EN

BACK VIEW

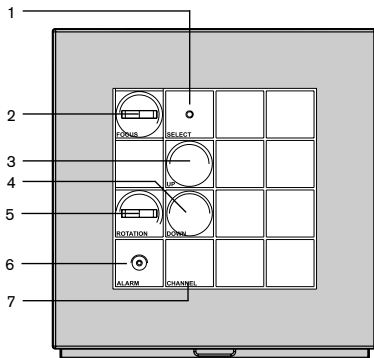

BUTTON DESCRIPTIONS

1. Select - switch modes / change settings
2. Focus - focus projector
3. Up - increase setting / activate auto-synch
4. Down - decrease setting / deactivate auto-synch
5. Rotation - rotate projector
6. Alarm - activate / deactivate alarm
7. Channel - switch remote unit

EN

BOTTOM AND SIDE VIEW

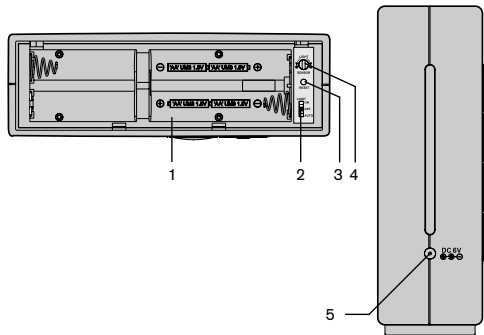

DESCRIPTIONS

1. Battery compartment
2. Backlight switch
3. Reset button
4. Light sensitivity knob
5. DC power input jack

NOTE AC power adapter not shown.

6



EN

REMOTE UNIT

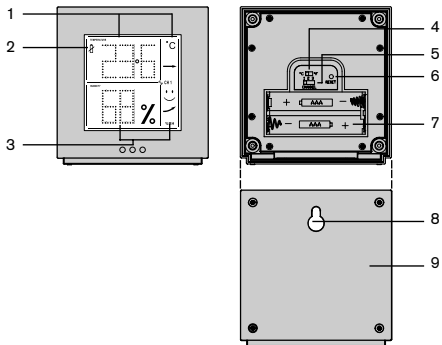

DESCRIPTIONS

1. Temperature / Trend display
2. Low battery icon
3. Humidity / Trend / Comfort Level display
4. °C/°F switch
5. Channel switch
6. Reset button
7. Battery compartment
8. Wall-mount hole
9. Battery compartment lid

GETTING STARTED

BATTERIES

Batteries for the remote and main units are supplied with this product. Replace them whenever the low battery signal () displays. Remove the battery compartment lid on the bottom of the main unit, and insert the batteries. You will need a small Phillips screwdriver to remove the remote unit compartment lid. Be sure to match the correct polarity, as shown in the battery compartment. Before you close the lid, press the **RESET** button with the point of a blunt object (such as a ball point pen).

NOTE Insert the batteries in the remote unit before you set up the main unit. Do not use rechargeable batteries.

AC POWER ADAPTER

An AC power adapter is supplied for use with the main unit. You must connect the power adapter if you wish to use the continuous projection or backlight features. The jack is located on the side of the unit.

NOTE If the AC power becomes unavailable, the unit will automatically switch to battery power.

SWITCH BETWEEN MODES

Press **SELECT**. The selected mode will flash. The display will stop flashing if no key is pressed within 5 seconds.



CHANGE SETTINGS

Press and hold **SELECT** for 2 seconds. Then, press **UP** or **DOWN** to change each setting. Press **SELECT** to switch options.

REMOTE UNIT SET UP



Up to 3 remote units can be used with this product to monitor outdoor temperature and humidity. The measurement unit ($^{\circ}\text{C}$ or $^{\circ}\text{F}$) and channel number (1, 2, or 3) switches are located in the battery compartment, and should be set prior to installation.

NOTE Additional remote units sold separately. If you are using more than one remote unit, be sure to select a different channel number for each unit.

INSTALLATION

Mount the remote unit on a flat surface using the recess holes on the back of the unit.

For best results:

- Before you insert the batteries, select the measurement unit and channel number first.
- Place the unit out of direct sunlight and moisture.
- Do not place the remote unit more than 20 - 30 meters (60 - 90 feet) from the main (indoor) unit.
- Position the unit so that it faces the main (indoor) unit. Minimize obstructions such as doors, walls, and furniture.

You may need to experiment with various locations to get the best reception.



EN

CLOCK

This product can automatically synchronize the date and time with official time-keeping organizations in Frankfurt, Germany (PS-M02) or Rugby, England (PS-M02U). When the unit is within 1500 km (932 miles) of a RF signal, the reception icon will blink during reception.

RECEPTION

Reception takes 2 - 10 minutes to complete. Once complete, the icon will stop blinking.

Strong signal	Weak signal	No signal
		

NOTE For best results, place the unit away from metal or electrical objects, and near a window with a clear view to the sky.

TO DISABLE OR ENABLE AUTO-SYNCHRONIZATION

In Clock mode, press **DOWN** for 2 seconds to disable the auto-synchronization. The unit will not respond to radio signals until you reactivate the synchronization.

To enable auto-reception, press **UP** for 2 seconds.



SET OR CHANGE THE CLOCK

1. Press **SELECT** to switch to the Clock Mode. The time will flash.
2. Press and hold **SELECT** for 2 seconds to enter the setting mode.
3. Select the 12/24-hour format, hour, and minute. Press **UP** or **DOWN** to change the setting. Press **SELECT** to confirm.



ALARM

When activated, the Melody Alarm starts quietly, then gradually becomes louder. It shuts off after two minutes. The LCD display lights up for the first 8 seconds.

SET ALARM

1. Press **SELECT** several times until the Alarm area flashes.
2. Press and hold **SELECT** for 2 seconds to enter the setting mode.
3. Select the hour, minute, melody (1 - 7) and volume level (Lo or Hi). Press **UP** or **DOWN** to change the setting. Press **SELECT** to confirm.
4. Press **SELECT** again when you are finished.



SNOOZE

Press the **SNOOZE/LIGHT** button the top of the unit to temporarily disable the alarm for 8 minutes. The alarm icon will blink while Snooze is activated.



TO TURN THE ALARM OFF OR ON

Press any button to stop the alarm.

To turn the alarm off completely (deactivate it for the next day), press **ALARM**.

CALENDAR

SET DATE

Clock auto-synchronization must be deactivated before you manually set the date. (→ 10)

1. Press **SELECT** several times until the calendar area flashes.
2. Press and hold **SELECT** for 2 seconds to enter the calendar setting mode.

3. Select the year, month, date, and language.
Press **UP** or **DOWN** to change the setting.
Press **SELECT** to confirm.

NOTE The language options are (E) English, (F) French, (D) German, (I) Italian, and (S) Spanish.

MOON PHASE

Press **SELECT** until the Calendar Area flashes. Then, press **UP** or **DOWN** to change the date and view the corresponding moon phase.



EN

BAROMETER

This product tracks barometric pressure changes over the past 24 hours to provide the weather forecast (→ 14) and a trend line showing the direction of barometric change. Barometric changes are measured by the main (indoor) unit.

BAROMETRIC TREND

The barometric trend arrow for the last 30 minutes is always displayed.

Trend	Description	Pressure change (mb/hPa)	
		1 hr	6 hrs
	Rising	+1	+3
	Steady	Steady	Steady
	Falling	-1	-3

VIEW THE LAST 24 HOURS

Press **SELECT** 2 times until the Barometer Area flashes. Then, press **UP** or **DOWN** to view the last 24 hours history.





SET UNIT AND ALTITUDE

You can set the unit of measurement (mb/hPa or inHg) and altitude. Setting the altitude allows the product to take more accurate barometric measurements.

1. Press **SELECT** 2 times until the Barometer Area flashes.
2. Press and hold **SELECT** for 2 seconds.
3. Select altitude (-100 meters to 2500 meters in increments of 10) and the unit of measurement (mb/hPa or inHg). Press **UP** or **DOWN** to change the setting. Press **SELECT** to confirm.

WEATHER FORECAST

This product forecasts the next 12 to 24 hours of weather within a 30 to 50 km (19 - 31 mile) radius with 70 to 75 percent accuracy. The weather forecast is always displayed.

Clear	Partly Cloudy	Cloudy	Rainy
			

TEMPERATURE AND HUMIDITY

With the press of a button, you can check the current indoor or outdoor temperature, humidity percentage, comfort level, trend, and record measurements. Outdoor measurements are collected by the remote unit.



EN

Temperature is given at the top; humidity is below.

VIEW MIN / MAX / CURRENT MEASUREMENTS

Press **SELECT** 3 times until the Temperature and Humidity Areas flash. Press **UP** or **DOWN** to scan the readings.

CLEAR MIN / MAX RECORDS

While viewing Min/Max records, press and hold **UP** or **DOWN** for 2 seconds until a beep sounds. This clears the previous measurements from the memory.

SELECT REMOTE UNIT CHANNEL

While in the Temperature / Humidity Mode, press **CHANNEL** to switch between CH 1, 2, or 3, or press

and hold **CHANNEL** for 2 seconds to enter Auto scan mode. If only 1 remote unit is in use, you will not be able to change channels or select Auto. If you select "Auto", the channel will change every 3 seconds. To deactivate, press and hold **CHANNEL** for 2 seconds again.

SENSOR SEARCHING



If there is no remote unit signal, the temperature and humidity measurements will be blank. Check the remote unit batteries, or press and hold **UP** and **DOWN** for 2 seconds to search for the remote unit(s).

Searching	No sensor	Sensor found

NOTE Signals from household electrical appliances such as doorbells and home security systems can cause temporary reception failures between the indoor and outdoor units. This is normal and does not affect the general performance of the product. Reception will automatically resume once the interference ends.



COMFORT ZONE

The indoor and outdoor comfort zones are shown for the following conditions.

Zone	Temperature	RelativeHumidity
 Wet	Any	>70%
 Dry	Any	<40%
 Comfort	20 - 25 °C (68 - 77 °F)	40 - 70%

TRENDS

The trend arrow for the last 30 minutes always displays. Indoor and outdoor temperature and humidity trends are shown separately.

Trend	Temperature	Relative Humidity
	+0.5 °C	+3%
	Steady	Steady
	-0.5 °C	-3%

SET UNIT

While in Temperature / Humidity Mode, press **SELECT** for 2 seconds. Press **UP** or **DOWN** to switch between °C and °F. Press **SELECT** to confirm.

BACKLIGHT

Press **SNOOZE/LIGHT** to illuminate the backlight for 5 seconds.

CONTINUOUS BACKLIGHT

The AC power adapter must be plugged in to use this feature (→ 8).

1. The **BACKLIGHT** switch is located in the battery compartment. Move it to the "ON" position to enable the continuous backlight. Move it to the "OFF" position to disable.



EN

2. Move it to the "AUTO" position to enable continuous backlight controlled by light intensity. When activated, the backlight will be on whenever the unit perceives that the room is dark.
3. The **Light Sensitivity knob** switch is located in the battery compartment. Rotate to adjust.

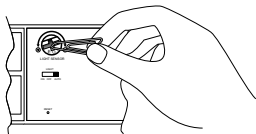

4. When activated, the continuous backlight will be half as bright as usual. To achieve full brightness, press **SNOOZE/LIGHT**.

PROJECTOR

This product has a built-in projector for viewing time and alarm status at night.

NOTE The maximum projection range is 2 meters (6 feet). The image gets larger the farther you display it.

PROJECT TIME / ALARM STATUS

In a darkened room, press **SNOOZE/LIGHT** to display the time and alarm status for 5 seconds.

FLIP IMAGE

Press **SNOOZE/LIGHT** again while the projector is on.

ROTATE IMAGE

The **ROTATION** switch is located on the back of the unit. Rotate to adjust.



FOCUS IMAGE

The **FOCUS** switch is located on the back of the unit. Rotate to adjust.

CONTINUOUS PROJECTION

The AC power adapter must be plugged in to use this feature (→ 8),



Press and hold **SNOOZE/LIGHT** for 2 seconds when the projection is on. When activated, the time and alarm status will project continuously.

Press and hold **SNOOZE/LIGHT** for 2 seconds again to deactivate.

RESET SYSTEM

The **RESET** buttons are located in the battery compartments for the main and remote units. Press these buttons with the tip of a blunt object (such as a ball point pen) whenever you change the batteries, or whenever performance is not behaving as expected (e.g., unable to establish radio frequency link with remote unit or automatic clock, etc.) This will return all settings to default value, and you will lose all stored information (minimum / maximum temperature and humidity, etc.).



SAFETY AND CARE

Wash the unit with a slightly damp cloth and mild detergent. Avoid dropping the unit or placing it in a location where the AC power adapter will be stepped on.

WARNINGS

This product is designed to give you years of service if handled properly. Observe the following guidelines:

- Never immerse the unit in water. This can cause electrical shock and damage the unit.
- Do not subject the main unit to extreme force, shock, or fluctuations in temperature or humidity.
- Do not tamper with the internal components.
- Do not mix new and old batteries or batteries of different types.

- Do not use rechargeable batteries with this product.
- Remove the batteries if storing this product for a long period of time.
- Do not scratch the LCD display.
- Do not make any changes or modifications to this product. Unauthorized changes may void your right to use the product.
- The contents of this user manual are subject to change without notice.
- Images not drawn to scale.



TROUBLESHOOTING

Check here before contacting our customer service department.

Problem	Symptom	Remedy
Temp	Shows "LLL" or "HHH"	Temperature is out-of-range.
Calendar	Strange date / month	Change language (→ 12)
Backlight	No continuous backlight	Plug in AC power adapter. Check the BACKLIGHT switch. (→ 8, 17)
Projector	No continuous projection	Plug in AC power adapter (→ 8, 18, 19)

Problem	Symptom	Remedy
Remote unit	Cannot locate remote unit	Check batteries (→ 8)
		Check location (→ 9)
	Cannot change channel	Check sensors. Only one sensor is working (→ 15)
Clock	Cannot auto-synchronize	<ol style="list-style-type: none"> 1. Remove batteries. 2. Press RESET. All memory items will return to default. 3. Replace batteries.

Problem	Symptom	Remedy
		<p>4. Place clock near window / away from electrical devices, and wait 10 - 20 minutes.</p> <p>If it still fails, you may be too far from a signal.</p>
	Cannot change clock	Disable auto-synchronization (→ 10)
Baro	Strange reading	Set altitude / unit (→ 14)

SPECIFICATIONS

Main unit dimensions

L x W x H	129 x 43 x 133.3 mm (5.1 x 1.7 x 5.3 inches)
Weight	471 grams with batteries

Remote unit dimensions

L x W x H	75 x 35 x 78.3 mm (3 x 1.4 x 3.1 inches)
Weight	136 grams with battery

Temperature

Unit	°C or °F
Range	Main unit: -5 °C to 50 °C (23 °F to 122 °F)



EN

Resolution Remote Unit: -20 °C to 60 °C
 (-4 °F to 140 °F)
 Comfort 0.1 °C (0.2 °F)
 20 °C to 25 °C (68 °F to 77 °F)
 (see also, Relative humidity)

Memory Minimum / maximum
 Trend +/- 0.5 °C (+/- 0.9 °F) change

Relative humidity

Range Main & Remote Unit 25% to 95%
 Resolution 1%
 Comfort 40% to 70%
 (see also, Temperature)

Memory Minimum / maximum
 Trend 3% change

Barometer

Unit mb/hPa or inHg

Range 500 to 1050 mb
 (14.77 to 31.01 inHg)
 Resolution 1 mb (0.03 inHg)
 Altitude -100 to 2500 meters
 (-328 to 8202 feet)

Display Rainy, cloudy, partly cloudy, sunny
 Memory 24 hour
 Trend 1mb change in 1 hour or 3mb
 change in 6 hours

Remote unit

RF frequency 433 MHz
 Range 30 meters (98 feet) with no
 obstructions
 Transmission approximately every 40 seconds
 Channel No. 1, 2, or 3
 Unit °C or °F



EN

Radio-controlled clock

Synchronization	Auto or disabled
Clock display	HH:MM:SS
Hour format	12hr AM/PM (MSF format) 24hr (DCF format)
Calendar	DD/MMM; weekday selection in 5 languages (E, D, F, I, S)
Moon phase	High, medium, and low tide
Alarm	7 melody; 2 minute crescendo
Snooze	8 minutes

Projector

Display	Current time / alarm status
Rotation	180° and image flip
Focusing	Manual
Projection	5-second or continuous

Power

Main unit	4 x UM-3 (AA) 1.5V alkaline batteries (back-up) AC/DC 6V power adapter (for normal operation and continuous backlight and projector)
Remote unit	2 x UM-4 (AAA) 1.5V alkaline batteries



EN

ADDITIONAL RESOURCES

Visit our website (www.oregonscientific.com) to learn more about your new product and other Oregon Scientific products such as digital cameras, hand-held organizers, health and fitness gear, and weather stations. The website also includes contact information for our customer service department, in case you need to reach us.



EC-DECLARATION OF CONFORMITY

This product contains the approved transmitter module **TX 07** and complies with the essential requirements of Article 3 of the R&TTE 1999/5/EC Directives, if used for its intended use and that the following standard(s) has/have been applied:

Radio frequency spectrum (Article 3.2 of the R&TTE Directive)

applied standard(s) **ETSI EN 300 220-3 (Ver.1.1.1):2000-09**

Electromagnetic compatibility (Article 3.1.b of the R&TTE Directive)

applied standard(s) **ETSI EN 301 489-1-3 (Ver.1.4.1):2002-08**

Safety of information technology equipment (Article 3.1.a of the R&TTE directive)

applied standard(s) **EN 60950:2000**

Additional information:

The product is therefore conform with the Low Voltage Directive 73/23/EC, the EMC Directive 89/336/EC and R&TTE Directive 1999/5/EC (appendix II) and carries the respective CE marking.

VS-Villingen / Germany August 2003

Gerhard Preis

R&TTE Representative of manufacturer

CE 0682 

RTT&E Compliant Countries:

All EC Countries, Switzerland **(CH)**,
and Norway **(N)**

©2003 Oregon Scientific. All rights reserved.

Free Manuals Download Website

<http://myh66.com>

<http://usermanuals.us>

<http://www.somanuals.com>

<http://www.4manuals.cc>

<http://www.manual-lib.com>

<http://www.404manual.com>

<http://www.luxmanual.com>

<http://aubethermostatmanual.com>

Golf course search by state

<http://golfingnear.com>

Email search by domain

<http://emailbydomain.com>

Auto manuals search

<http://auto.somanuals.com>

TV manuals search

<http://tv.somanuals.com>