

LONG-RANGE WIRELESS WEATHER STATION WITH IN-OUT THERMO-HYGROMETER AND RF CLOCK

MODEL : BAR898HGA

USER'S MANUAL

INTRODUCTION

Congratulations on your purchase of the BAR898HGA Long-Range Wireless Weather Station with In-Out Thermo-Hygrometer and RF Clock. This unit is an all-in-one weather forecasting device which has multiple weather-related functions. Also, with an internal antenna the reception range of this unit can be up to 100 meters.

The BAR898HGA, a weather forecasting device, has several weather related functions. The main feature is that it takes and records temperatures and humidities in more than one location. Using a wireless remote thermo-hygro sensor, it can simultaneously monitor temperatures and humidities in three remote locations. The unit will show temperature and humidity trends as well as record maximum and minimum temperature and humidity readings. BAR898HGA is able to receive and display readings from up to 3 remote sensors.

As part of the weather forecasting function, the unit has a built-in barometer that displays atmospheric pressure. Using kinetic-movement graphic illustrations the unit displays atmospheric pressure trends and displays forecasts as sunny, partly cloudy, cloudy, rainy and snowy.

This unit also has a Radio Frequency (RF) controlled clock. It can automatically synchronize its current time and date when it is brought within range of the radio signal generated from the U.S. Atomic Clock.

Other features of BAR898HGA include LCD and key-panel backlight, rotatable display unit for multi-angle viewing and a Daily crescendo alarm with an eight-minute snooze function.

No wire installation is required between the main and remote units as this unit operates at 433 MHz.

However, please note that the Atomic Clock cannot be used outside the U.S.

FEATURES : MAIN UNIT

A. LCD DISPLAY

A1. WEATHER FORECAST WINDOW

- Graphically illustrates the weather forecast
- Indicates trends in atmospheric pressure
- Indicates when main unit battery is low

A2. TEMPERATURE WINDOW

- Displays current, minimum or maximum indoor and remote temperature
- Indicates the temperature trend

A3. HUMIDITY WINDOW

- Displays current, minimum or maximum indoor and remote humidity
- Indicates the humidity trend
- Displays the Comfort Level
- Indicates when the battery of the remote sensor is low

A4. ATMOSPHERIC PRESSURE WINDOW

- Displays the current or historical (last 24 hours) barometric reading

A5. TIME / DATE / ALARM WINDOW

- Displays the current time, date (month/day), daily alarm function
- Radio Frequency (RF) status indicator []

B. CONTROL BUTTONS - FRONT PANEL

B1. [MODE] BUTTON

- Changes the display mode of the clock, and alters time/date setting

B2. [] BUTTON

- Displays the daily alarm time or changes the corresponding alarm time

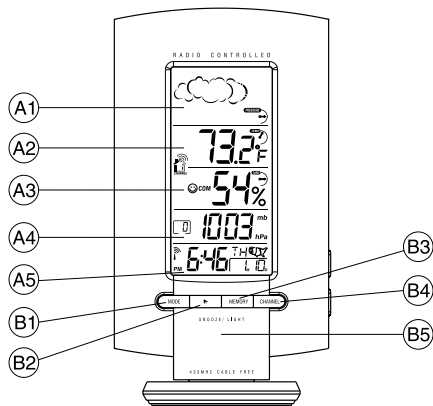

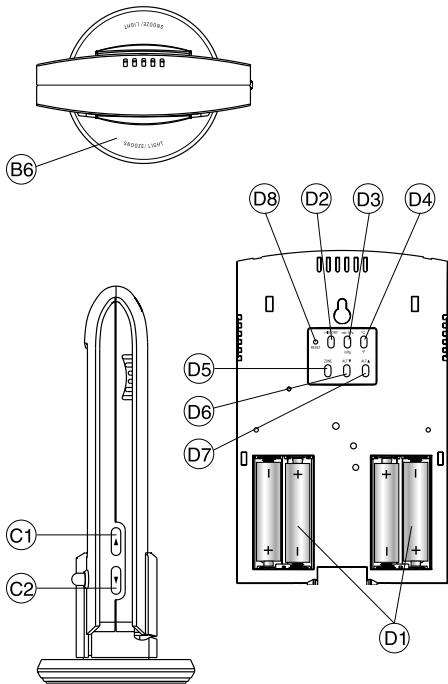

B3. [MEMORY] BUTTON

- Displays minimum and maximum temperature and humidity readings, and erases memory data

B4. [CHANNEL] BUTTON

- Displays the temperature and humidity readings of the indoor or remote sensor

B5. [SNOOZE / LIGHT] BUTTON

- Activates the snooze function or turn on the backlight

B6. DETACHABLE TABLE-STAND ([SNOOZE / LIGHT] STAND - BUTTON)

- Acts as the [SNOOZE / LIGHT] BUTTON when attached to the display unit

C. CONTROL BUTTONS - SIDE PANEL

C1 & C2. UP [▲] & DOWN [▼] BUTTONS

- Increases or decreases the value of a setting

D. CONTROL BUTTONS - BACK PANEL

D1. BATTERY COMPARTMENT

- Accommodates four (4) pieces of UM-3 or "AA" size batteries

D2. [HISTORY] BUTTON

- Displays the barometric reading for the last 24 hours, or enter the altitude compensation setting

D3. [mb / hPa - inHg] SLIDE SWITCH

- Selects between "mb / hPa" or "inHg" pressure unit display

D4. [°C / °F] SLIDE SWITCH

- Selects between Centigrade (°C) or Fahrenheit (°F) temperature unit display

D5. [ZONE] BUTTON

Press to select among the 4 U.S. time-zones: Pacific(P), Mountain(M), Central (C) or Eastern (E)

D6 & D7. ALT (▲) or ALT (▼) BUTTON

Increases or decreases the value in compensational altitude setting respectively

D8. [RESET] BUTTON

- Resets the unit by returning all settings to their default values

FEATURES : REMOTE THERMO-HYGRO SENSOR

a. Two-line LCD

Displays the current temperature and humidity monitored by the remote unit

b. LED indicator

Flashes when the remote unit transmits a reading

c. °C/°F slide switch

Selects between Centigrade (°C) and Fahrenheit (°F)

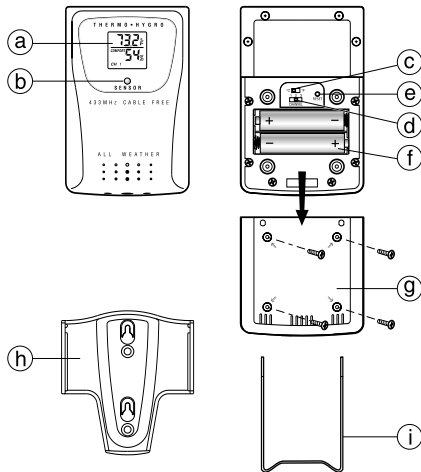
**d. Channel slide switch**

Designates the remote unit Channel 1, Channel 2 or Channel 3

e. RESET

Returns all settings to default values

f. Battery compartment

Accommodates two (2) pieces of UM-3 or AA-size batteries

g. Battery door

h. Wall-mount holder

Supports the remote unit in wall-mounting

i. Removable table stand

For standing the remote unit on a flat surface

BEFORE YOU BEGIN - INSTALLING THE TABLE STAND

Before operation, plug the detachable table stand into the display unit as shown.

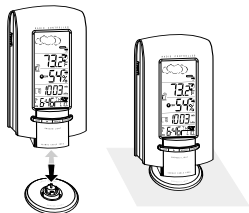

You can rotate the display unit freely by moving the unit around.

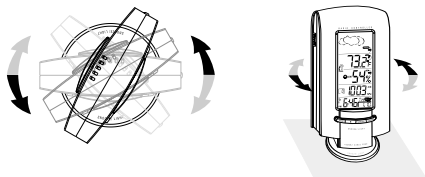

NOTES ON OPERATION

For best operation:

1. Insert batteries for the main unit first. Then proceed with inserting the batteries for the remote unit.
2. Position the remote unit and the main unit within effective transmission range. In usual circumstances, the effective range is up to 100 meters or 300 feet.
3. Though the remote unit is weather resistant, it should be placed away from direct sunlight, rain or snow.

BATTERY INSTALLATION: MAIN UNIT

1. Gently open the battery compartment door as shown.

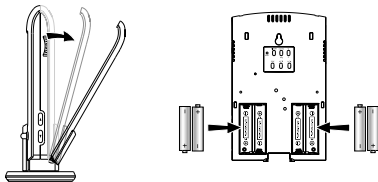

2. Insert four (4) pieces of UM-3 or "AA" size batteries in accordance with the polarities shown.
3. Close the battery compartment door.

BATTERY AND CHANNEL INSTALLATION: REMOTE UNIT

The remote thermo-hygro sensor unit uses two (2) UM-3 or "AA" size batteries.

Follow these steps to install / replace batteries:

1. Remove the screws on the battery compartment.
2. Select the channel number on the **CHANNEL** slide switch.
3. Select the temperature display unit on the **°C/°F** slide switch.

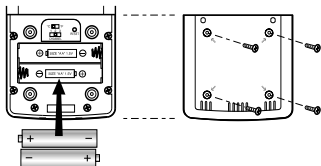

4. Insert the batteries strictly according to the polarities shown therein.
5. Replace the battery compartment door and secure its screws.

Replace the batteries when the low-battery indicator of the particular channel lights up on the main unit.

Note that once a channel is assigned to a remote unit, you can only change it by removing the batteries or resetting the unit.

LCD AND KEY-PANEL BACKLIGHT

For easy viewing in the dark this unit is featured with backlight function on the LCD display as well as on the front key-panel.

The unit is designed such that you can conveniently use the backlight feature irrespective of whether the unit is wall-mounted or free standing on the table.

Wall-Mount

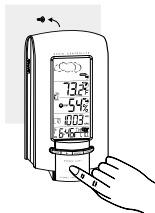
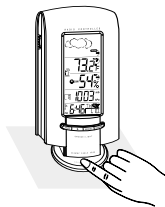

Table-Stand



Press the corresponding [**SNOOZE / LIGHT**] button or the button on the stand. The backlight will be activated for 5 seconds.

ABOUT RADIO RECEPTION

The BAR898HGA is designed to automatically synchronize its calendar clock once it is brought within range of the US Atomic Clock radio signal.

When the BAR898HGA is within range, its radio-control mechanism will override all manual settings unless the auto-reception function is manually disabled.

When the unit is receiving radio signal, the RADIO RECEPTION signal will start to blink. A complete reception generally takes about 2 to 10 minutes, depending on the strength of the radio signal.



When the reception is complete, the RADIO RECEPTION signal will stop blinking. The strength of the reception for the last full hour will be indicated.

For better reception, place the clock away from metal objects and electrical appliances to minimize interference.

Should you wish to deactivate the RF controlled function, press and hold the [ZONE] button.

To reactivate the RF control function, press and hold the UP [▲] button.

Chart Indicating Radio Signal Strength

		
Good	No signal	Receiving

HOW TO MANUALLY SET THE CLOCK

Press [MODE] and hold for three seconds.

The hour will flash. Use the UP [▲] or DOWN [▼] button to enter the hours. Holding down either the up or down button will increase or decrease the value rapidly.

Press [MODE] again, the minute will flash. Again, use the UP [▲] or DOWN [▼] button to change the minutes.

Note: When changes are made to this setting, the seconds will start from zero.

Press [MODE] again, the calendar settings are displayed and the year is flashing. Use the UP [▲] or DOWN [▼] button to change the year.

Press [MODE] button and the month will flash. Enter the appropriate month using the UP [▲] or DOWN [▼] button.

Press [MODE] button and the day settings will flash. Enter the appropriate day using the UP [▲] or DOWN [▼] button.

Press [MODE] again and the language setting will flash. Use the UP [▲] or DOWN [▼] button to select E for English, F for French or S for Spanish.

Press [MODE] to complete and exit the setting.

The weekday can be expressed as an abbreviation in three different languages. The languages and their selected abbreviations for each day of the week are shown in the language chart below.

Language	Day-of-the-week						
	Monday	Tuesday	Wed.	Thursday	Friday	Saturday	Sunday
English	Mo	Tu	We	Th	Fr	Sa	Su
French	Lu	Ma	Me	Je	Ve	Sa	Di
Spanish	Lu	Ma	Mi	Ju	Vi	Sa	Do

To toggle among the 4 U.S. time-zones, press the [ZONE] button.

HOW TO SET AND ACTIVATE THE ALARM

To set the Alarm

Press [**ALARM**] button to display the daily alarm time (the icon " (••) " will be displayed)

Press [**ALARM**] and hold for three seconds, the value for the hour will flash.

Press **UP** [▲] or **DOWN** [▼] buttons to make changes to the alarm hour setting.

Press [**ALARM**] and the minute digits will flash. Enter the value for the minute by using **UP** [▲] or **DOWN** [▼] buttons.

Press [**ALARM**] to exit.

The alarm is automatically activated. The **ALARM ON** icon [▶] is visible and the alarm will be activated at the specified time.

To deactivate the daily alarm function, press the [**ALARM**] button when the alarm time is displayed. The **ALARM ON** icon will disappear.

To activate, press the [**ALARM**] button again.

ALARM AND SNOOZE FUNCTION

When the daily alarm goes off, the backlight will be on for five seconds and the **ALARM ON** icon [▶] will flash.

The alarm function has a built in crescendo type alarm system. Initially, the active alarm will have a gentle sound. The intensity will increase in three stages. Without interruption, the unit will alarm for two minutes.

To stop the alarm, press the [**ALARM**] button. However, if [**SNOOZE / LIGHT**] is pressed, the **SNOOZE** function will be triggered. The alarm will stop and the **ALARM ON** icon blinks for eight minutes. After that the alarm will go off again.

To deactivate the **SNOOZE** function, press the [**ALARM**] button.

CHECKING INDOOR AND REMOTE TEMPERATURES & HUMIDITIES

To display the indoor and outdoor temperature and humidity readings, press the [**CHANNEL**] button to toggle among the indoor, Channel 1, 2 and 3 displays.

The temperature can be shown in Centigrade (°C) or Fahrenheit (°F). Select the appropriate reading by using the °C/°F slide switch (located in the battery compartment). Slide the switch to °C for Centigrade or °F for Fahrenheit.

This unit has an auto-scan function that can sequentially display the indoor and remote readings.

To activate this function, press and hold the [**CHANNEL**] button for 3 seconds. To deactivate press the [**CHANNEL**] button again.

If the reading goes above or below the specified amounts, the display will show a flashing "HHH" or "LLL".

NOTE ON REMOTE READINGS

Once batteries are in place in the remote unit, it will start transmitting samplings at 40 second intervals.

If no signals are received when the remote sensor display is selected, " - - - " will be displayed. To initiate the main unit

search for remote sensor signals, press [**MEMORY**] and [**CHANNEL**] simultaneously.

If that fails, check if the remote sensor is still in place. Make sure the transmission is within range and the path is clear of obstacles and interference.

Repeat this procedure whenever you find discrepancies between the display on the main unit and the display on the remote sensor.

NOTE ON °C AND °F

The outdoor temperature display on the main unit is dominated by the selection on the °C/°F slide switch of the main unit. Whatever the display unit of the remote sensor is, it will only apply to the remote sensor itself and the temperature will be automatically converted to the chosen one of the main unit.



MAXIMUM AND MINIMUM TEMPERATURES & HUMIDITIES



The maximum and minimum recorded temperatures and humidities will be automatically stored in memory. To display them, press [**MEMORY**]. Press [**MEMORY**] again to alternate between the maximum, minimum and current readings. The respective **MAX** or **MIN** indicator will be displayed.

To clear the memory, press [**MEMORY**] and hold for three seconds. The maximum and minimum recorded readings will be erased. Subsequently, if you press [**MEMORY**] after the memory has been erased, the maximum and minimum readings will have the same values as the current ones.

TEMPERATURE & HUMIDITY TREND



The temperature and humidity trend indicator shows the trend of temperatures and humidities collected at that particular sensor. Three trends: rising, steady, and falling will be shown.

Arrow indicator			
Temperature Trend	Rising	Steady	Falling

Arrow indicator			
Humidity Trend	Rising	Steady	Falling





ATMOSPHERIC PRESSURE

The atmospheric pressure arrow indicator will indicate if the atmospheric pressure is increasing, remaining stable, or decreasing.

Arrow indicator			
Pressure Trend	Rising	Steady	Falling

WEATHER FORECAST

The unit is capable of detecting atmospheric pressure changes. Based on collected data, it can predict the weather for the forthcoming 12 to 24 hours. The effective range covers an area of 30 to 50 km or 18 to 35 miles.

				
Sunny	Partly cloudy	Cloudy	Rainy	Snow



NOTE:

1. The accuracy of a general pressure-based weather forecast is about 70% to 75%.
2. The weather forecasts from this unit are predictions that cover the next 12 to 24 hours. It may not necessarily reflect the current situation.
3. The "Sunny" icon, as applies to night time, implies clear weather.

COMFORT LEVEL INDICATORS

The comfort level indicators COM, WET or DRY will tell you if the current environment is comfortable, too wet or too dry.

The comfort indicator will appear on the display when the following conditions are satisfied:

Indicator displays on the unit	Temperature Range	Humidity Range	Shows that the Current Environment
 COM	20°C to 25°C (68°F to 77°F)	40%RH- 70%RH	Ideal range for both relative humidity and temperature
 WET	-5°C + 50°C (23°F - 122°F)	OVER- 70%RH	Contains excess moisture
 DRY	-5°C + 50°C (23°F - 122°F)	Below 40%RH	Contains inadequate moisture
No Indicator	Less than 20°C (68°F) or More than 25°C (77°F)	40%RH to 70%RH	No comment

HOW TO CHECK THE BAROMETRIC PRESSURE

The current and historical barometric pressure is shown on the atmospheric pressure window.

For users staying at a higher altitude such as in the mountain area, sea-level barometric pressure applies. In this case, press and hold [**HISTORY**] button to enter the altitude compensation setting mode. Use the **ALT** (▲) or **ALT** (▼) button to select from -328 to 8200 feet (whichever appropriate). Press [**HISTORY**] button to confirm and exit.

The BAR898HGA requires entry of elevation in meters not feet. To convert feet to meters multiply feet by .30.

To determine your location elevation, please either contact your local library, TV/radio weather forecaster, or via Internet at <http://www.worldatlas.com/aatlas/infopage/elvation.htm>.

The atmospheric pressure can be displayed in mb/hPa or inHg. The pressure unit is selected on the atmospheric pressure slide switch inside the battery compartment.

If you want to check the pressure history for a particular hour during the past 24 hours, press the **[HISTORY]** button. Each press on the button will go back by an hour. Holding down the button will increase the value rapidly.

LOW BATTERY INDICATION

When it is time to replace batteries, the respective low battery indicator [] will show up when the corresponding channel is selected. The battery level of the main unit is shown on the Weather Forecast Window when it is running low.

HOW TO WALL MOUNT OR USE THE TABLE STAND (REMOTE UNIT)

As for the remote unit, it comes with a wall-mount holder and a removable stand. Use either to hold the unit in place.

Wall-Mount:



Table-Stand:

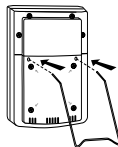

HOW TO WALL MOUNT OR USE THE TABLE STAND (MAIN UNIT)

The unit can be wall-mounted using its recessed screw holes or placed on a flat surface using the detachable table stand.

Wall-Mount:

Table-Stand:

Gently plug in the table stand as shown:

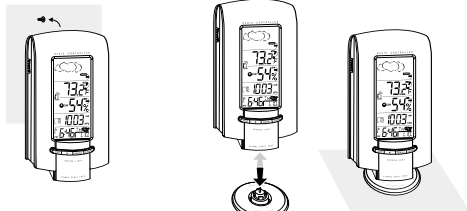

HOW TO RESET THE UNIT

The [**RESET**] button allows you to return all settings to factory values. Accessing the slot is required only when the unit is not operating in a favorable way such as in the rare case of a malfunction.

The [**RESET**] slot is located inside the battery compartment door. To use the button:

1. Open the battery compartment door.
2. Place a blunt stylus into the hole and press.
3. Close the battery compartment door.

MAINTENANCE

When handled properly, this unit is engineered to give you years of satisfactory service. Here are a few product care instructions:

1. Do not immerse the unit in water. If the unit comes in contact with water, dry it immediately with a soft lint-free cloth.
2. Do not clean the unit with alcohol containing detergent, abrasive or corrosive materials. Abrasive cleaning agents may scratch the plastic parts and corrode the electronic circuit.
3. Do not subject the unit to excessive: force, shock, dust, temperature, or humidity. Such treatment may result in malfunction, a shorter electronic life span, damaged batteries, or distorted parts.
4. Do not tamper with the unit's internal components. Doing so will terminate the unit's warranty and may cause damage. The unit contains no user-serviceable parts.

5. Only use new batteries as specified in this instruction manual. Do not mix new and old batteries as the old batteries may leak.
6. Read this instruction manual thoroughly before operating the unit.

SPECIFICATIONS

Main unit

Indoor Temperature measurement

Proposed operating range : -5.0°C to +50.0°C
(23.0°F to 122.0°F)

Temperature resolution : 0.1°C (0.2°F)

Relative Humidity measurement

Measuring Range : 25% RH to 95% RH
at 25°C (77°F)

Humidity Resolution : 1% RH

Remote unit

RF Transmission Frequency : 433 MHz

No. of Remote unit : Up to 3 units

RF Transmission Range : Up to 100 meters or 300 feet

Data sensing cycle : around 40 seconds

Temperature measurement

Display range	: -20.0°C to +60.0°C (-4.0°F to 140.0°F)
Proposed operating range	: -5.0°C to +60.0°C (23.0°F to 140.0°F)
Temperature resolution	: 0.1°C (0.2°F)

Relative Humidity measurement

Measuring Range	: 25 to 90%RH at 25°C (77°F)
Humidity Resolution	: 1% RH

Barometric Pressure measurement

Pressure measuring range	: 795 to 1050mb / hPa (23.48 to 31.01 inHg)
--------------------------	--

Power

Main unit	: uses four (4) UM-3 or "AA" 1.5V batteries
Remote sensing unit	: uses two (2) UM-3 or "AA" 1.5V batteries

Weight

Main unit	: 300gm or 10.58 ounces (without battery)
Remote sensing unit	: 80gm or 2.82 ounces (without battery)

Dimensions

Main unit	: 195 (L) x 105 (W) x 77 (T) mm or 7.68 x 4.13 x 3.03 inches
Remote sensing unit	: 105 (L) x 70 (W) x 21 (T) mm or 4.13 x 2.76 x .83 inches

CAUTION

- The content of this manual is subject to change without further notice.
- The technical specifications of this product are subject to change without notice.
- Due to printing limitation, the displays shown in this manual may differ from the actual display.
- The contents of this manual may not be reproduced without the permission of the manufacturer.

NOTE ON COMPLIANCE

This device complies with Part 15 of the FCC Rules. Operation is subject to the following two conditions: (1) This device may not cause harmful interference, and (2) This device must accept any interference received, including interference that may cause undesired operations.

Warning: Changes or modifications to this unit not expressly approved by the party responsible for compliance could void the user's authority to operate the equipment.

FCC:

NOTE: This equipment has been tested and found to comply with the limits for a Class B digital device, pursuant to Part 15 of the FCC Rules. These limits are designed to provide reasonable protection against harmful interference in a residential installation. This equipment generates, uses and can radiate radio frequency energy and, if not installed and used in accordance with the instructions, may cause harmful interference to radio communications.

However, there is no guarantee that interference will not occur in a particular installation. If this equipment does cause harmful interference to radio or television reception, which can be determined by turning the equipment off and on, the user is encouraged to try to correct the interference by one or more of the following measures:

- Reorient or relocate the receiving unit.
- Increase the separation between the equipment.
- Connect the equipment into an outlet on a circuit different from that to which the receiver is connected.
- Consult the dealer of an experienced radio/TV technician for help.

Company Name : Oregon Scientific, Inc.

Address : 19861 SW 95th Place, Tualatin, Oregon 97062, USA

Telephone Number : 503-639-8883

Website address : www.oregonscientific.com

Name and model number of the product : Baro w/Remote Thermo Hygro BAR898HGA

CUSTOMER ASSISTANCE

Should you require assistance regarding this product and its operation, please contact our customer care department at 800-853-8883 or via email at helpme@oscientific.com.

WARRANTY

This product is warranted to be free of manufacturing defects for a period of 90 days from date of retail purchase. Defective product should be directed to the place of retail purchase for exchange.

Should this not be possible, contact our customer care department for assistance and a return material authorization. No returns may be made without a return authorization. Warranty exchanges require proof of date of purchase (purchase receipt showing date, place and product purchased).

This warranty does not cover product subjected to abuse, misuse, accidental damage or tampering.

Free Manuals Download Website

<http://myh66.com>

<http://usermanuals.us>

<http://www.somanuals.com>

<http://www.4manuals.cc>

<http://www.manual-lib.com>

<http://www.404manual.com>

<http://www.luxmanual.com>

<http://aubethermostatmanual.com>

Golf course search by state

<http://golfingnear.com>

Email search by domain

<http://emailbydomain.com>

Auto manuals search

<http://auto.somanuals.com>

TV manuals search

<http://tv.somanuals.com>