



Jumbo Weather Station with Remote Control
Model: BAR289
User Manual

Jumbo Weather Station with Remote Control Model: BAR289

User Manual

CONTENTS

Contents	1
Introduction	1
Product Overview	2
Front View	2
Back View	2
LCD Display	3
Remote Control (RE289) - Front View	3
Remote Control (RE289) - Back View	4
Remote Sensor (RTHR328N) - Front View	4
Remote Sensor (RTHR328N) - Back View	4
Remote Sensor (RTHR328N) - LCD Display	4
Getting Started	5
Batteries	5
Remote Sensor (RTHR328N)	5
Sensor Set Up	5
Sensor Data Transmission	6
Select Sensor Channel	6
Search for Sensor	6
Clock and Calendar	6
Radio-Controlled Clock	6
Turn Radio-Controlled Clock ON / OFF	6
Set Clock	6
Switch Clock Display	7
Hourly Chime	7
Alarm	7
View Alarm Settings	7
Set Alarm	7
Activate Alarm	7
Silence Alarm	7
Weather Forecast	8
Weather Forecast Icons	8
Temperature	8
Maximum / Minimum Records	8
Select Measurement Unit	8
Backlight	8
Reset System	8
Remote Control (RE289)	8
Safety and Care	9
Warnings	9
Troubleshooting	9
Specifications	9
About Oregon Scientific	10
EC-Declaration of Conformity	10

INTRODUCTION

Thank you for selecting the Oregon Scientific™ Jumbo Weather Station with Remote Control (BAR289). This powerful device bundles time keeping, weather forecast, indoor and outdoor temperature, with remote control facility, into a single tool you can use from the convenience of your home.

In this box, you will find:

- Main unit (BAR289)
- Remote control (RE289)
- Remote sensor (RTHR328N)
- Main unit batteries, 4 x UM-3 (AA) 1.5V
- Remote control batteries, 2 x UM-4 (AAA) 1.5V
- Remote sensor batteries, 2 x UM-3 (AA) 1.5V

NOTE The THGR328N (5-Channel) and THR228N (3-Channel) remote sensors are also compatible with this weather station. If you purchase the THGR328N sensor, the humidity reading will not show on the BAR289. Additional sensors are sold separately. Please contact your local stockist for more information.

Keep this manual handy as you use your new product. It contains practical step-by-step instructions, as well as technical specifications and warnings you should know.

PRODUCT OVERVIEW

FRONT VIEW



1. **CHANNEL:** Switch remote sensor display
2. **MEMORY:** View current, maximum and minimum temperature readings
3. **MODE / LIGHT:** Change settings / display; activate backlight
4. LCD display
5. Infrared window
6. **ALARM:** View alarm status; set alarm
7. **UP / DOWN:** Increase / decrease setting; activate / deactivate radio-controlled clock

BACK VIEW

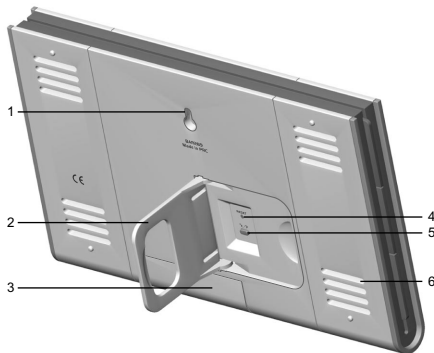

1. Wall mount
2. Table stand
3. Battery compartment: Uses 4 x UM-3 (AA) 1.5V
4. **RESET** hole
5. °C / °F button
6. Ventilation holes

LCD DISPLAY

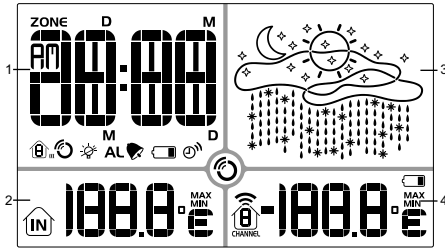

- Clock / Alarm / Calendar Area:** Radio-controlled clock; alarm; calendar
- Indoor Temperature Area:** Maximum, minimum, and current readings
- Weather Forecast Area:** Animated weather forecast
- Outdoor Temperature Area:** Maximum, minimum, and current readings; sensor channel number

Clock / Alarm / Calendar Area

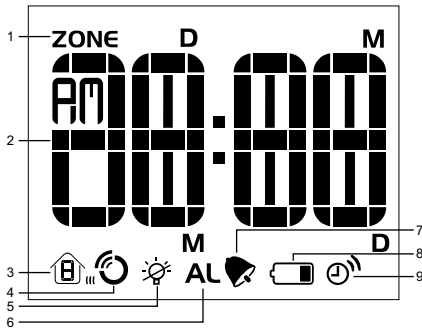

- Time Zone Hour Offset
- Time / date / calendar
- Channel number 1-5
- RF clock reception
- Backlight function is deactivated (under low battery condition)
- Alarm setting display
- Alarm is activated
- Low battery icon for main unit
- Hourly chime icon

Indoor Temperature Area



- Indoor temperature - °C / °F
- Indoor icon
- MAX / MIN temperature

Outdoor Temperature Area

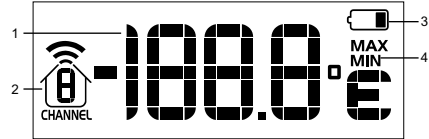

- Outdoor temperature - °C / °F
- Channel number (1-5) / reception status
- Low battery icon for remote sensor
- MAX / MIN temperature

REMOTE CONTROL (RE289) - FRONT VIEW

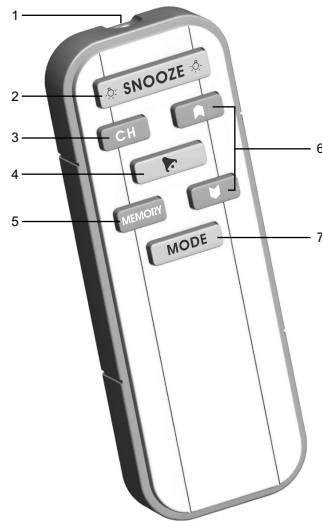

- Infrared signal transmitter
- SNOOZE**: Activates snooze and backlight on the main unit
- CHANNEL**: Switch remote sensor display
- ↑ / ↓**: View alarm status; set alarm
- MEMORY**: View current, maximum and minimum temperature readings
- ▲ / ▼**: Increase / decrease setting; activate / deactivate radio-controlled clock
- MODE**: Change settings / display

REMOTE CONTROL (RE289) - BACK VIEW

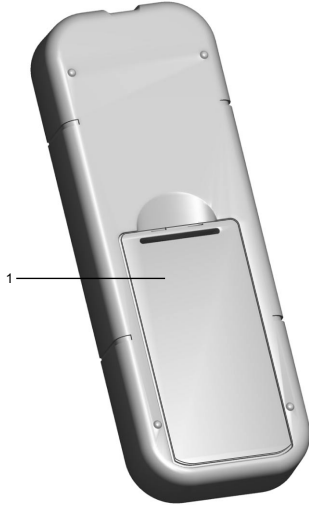

1. Battery compartment: Uses 2 x UM-4 (AAA) 1.5V

REMOTE SENSOR (RTHR328N) - FRONT VIEW

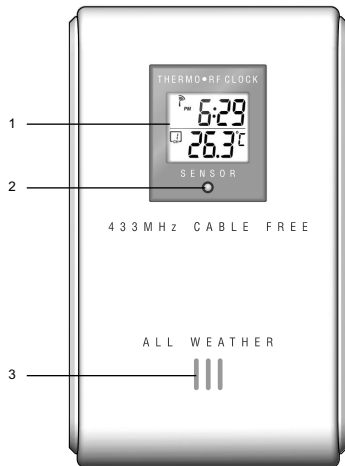

1. LCD display
2. LED status indicator
3. Ventilation duct

REMOTE SENSOR (RTHR328N) - BACK VIEW

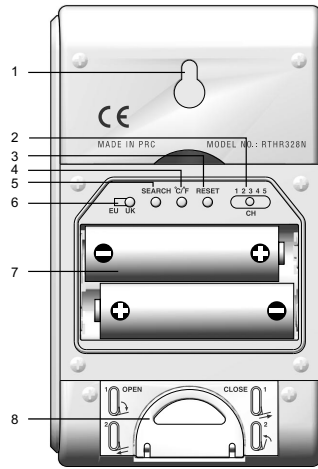

1. Wall mount
2. **CHANNEL** switch (1-5)
3. **RESET**
4. °C / °F
5. **SEARCH**
6. **EU / UK** radio signal format switch
7. Battery compartment
8. Fold-out stand

REMOTE SENSOR (RTHR328N) - LCD DISPLAY

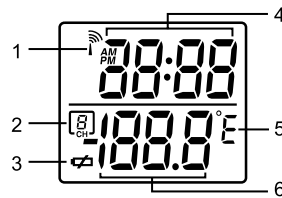

1. Reception
2. Channel number (1-5)
3. Low battery indicator
4. Time
5. Temperature - °C or °F
6. Temperature reading

GETTING STARTED

BATTERIES

Batteries are supplied with this product:

- Main unit 4 x UM-3 (AA) 1.5V
- Remote control 2 x UM-4 (AAA) 1.5V
- Remote sensor 2 x UM-3 (AA) 1.5V

Insert batteries before first use, matching the polarity as shown in the battery compartment. For best results, install batteries in the remote sensor before the main unit. Press **RESET** after each battery change.

To install the main unit batteries:

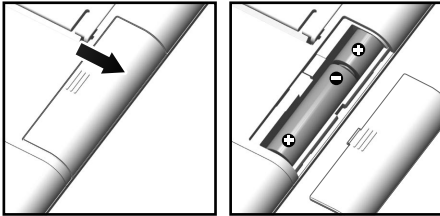

To install the remote control batteries:

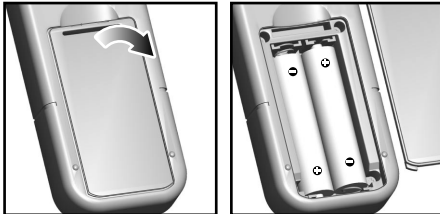

NOTE Do not use rechargeable batteries.

 shows when batteries are low.

UNIT	 LOCATION
Main	Clock / Alarm / Calendar Area
Remote Sensor	Outdoor Temperature Area

NOTE It is recommended that you use alkaline batteries with this product for longer performance.

REMOTE SENSOR (RTHR328N)

This product is shipped with the RTHR328N Remote Sensor. The main unit can collect data from up to 5 sensors.

The THGR328N and THR228N sensors are also compatible with this weather station. (Additional sensors are sold separately. Contact your local stockist for more information.)

The RTHR328N sensor collects temperature readings and signals from official time-keeping organizations for the radio-controlled clock.

SENSOR SET UP

1. Open the battery compartment with a small Phillips screwdriver and insert the batteries matching the polarity (+ and -) as shown below.

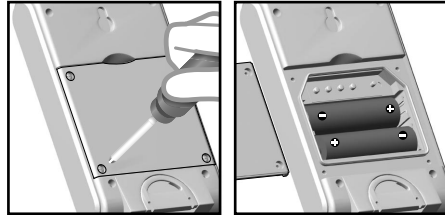

2. Set the channel by pressing the **CHANNEL** button to the required number. If you are using more than one sensor, select a different channel for each sensor.
3. Slide the **EU / UK** switch to the setting which best suits your location.
4. Press **RESET**.
5. Place the sensor near the main unit.
6. Press **SEARCH** to manually initiate signal sending between the sensor and the main unit. The reception icon on the main unit will blink for approximately 3 minutes while it is searching for the sensor. (Refer to the "Sensor Data Transmission" section for more information.)
7. Press the **°C / °F** button to select the setting you want.
8. Close the remote sensor battery compartment.
9. Secure the sensor in the desired location using the wall mount or table stand.

To fold out the stand:

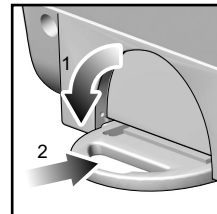

For best results:

- Insert the batteries and select the unit, channel, and radio signal format before you mount the sensor.
- Place the sensor out of direct sunlight and moisture.
- Do not place the sensor more than 30 metres (100 feet) from the main (indoor) unit.
- Position the sensor so that it faces the main (indoor) unit, minimizing obstructions such as doors, walls, and furniture.
- Place the sensor in a location with a clear view to the sky, away from metallic or electronic objects.
- Position the sensor close to the main unit during cold winter months as below-freezing temperatures may affect battery performance and signal transmission.

NOTE The transmission range may vary and is subject to the receiving range of the main unit.

You may need to experiment with various locations to get the best results.

SENSOR DATA TRANSMISSION

Data is sent from the sensor(s) every 60 Seconds. The reception icon shown in the Outdoor Temperature Area indicates the status.

ICON	DESCRIPTION
	Main unit is searching for sensors.
	At least 1 channel has been found.
	Sensor 1 is sending data. (The number shows which sensor is selected.)
--- shows in Temp Area	The selected sensor cannot be found. Search for the sensor or check batteries.

SELECT SENSOR CHANNEL

Press **CHANNEL** on the main unit, to switch between sensors 1-5.



The house icon shows the selected remote sensor.

To auto-scan between sensors, press and hold **CHANNEL** for 2 seconds. Each sensor's data will be displayed for 3 seconds.

To end auto-scan, press **CHANNEL** or **MEMORY**.

SEARCH FOR SENSOR

To search for a Thermo sensor, simultaneously press and hold **CHANNEL** and **MEMORY** for 2 seconds.

NOTE If the sensor is still not found, check the batteries.

CLOCK AND CALENDAR

This product tracks the time and date based on radio-controlled signals from the RTHR328N remote sensor, or manual settings that you enter.

RADIO-CONTROLLED CLOCK

The time and date are automatically updated by radio-controlled clock signals from official time-keeping organizations in Frankfurt (Germany) and Rugby (England) unless you disable this feature. The signals are collected by the remote sensor (RTHR328N) whenever it is within 1500 km (932 miles) of a signal.

Initial reception takes 2-10 minutes, and is initiated when you first set up the unit, and whenever you press **RESET**. Once complete, the reception icon will stop blinking.

The reception icon shown in the Clock Area indicates 2 factors:

- Connection between the main unit and the sensor that collects RF signals ()



- RF signal reception ()

How these signals work together:

ICON	MEANING
	The unit has contact with the remote sensor and has synchronized the time.
	The unit has contact with the remote sensor but the time has not been synchronized.
	The unit has lost contact with the remote sensor but the time is synchronized.
	The unit has lost contact with the remote sensor and the time is not synchronized.
	The unit cannot reach the remote sensor.

NOTE To force a manual search for the RF clock reception, press and hold **SEARCH** on the sensor (RTHR328N).

TURN RADIO-CONTROLLED CLOCK ON / OFF

If you wish to manually set the clock, you must first disable the radio-controlled feature. To do this, make sure you are not in Setting Mode, then press and hold **DOWN** on the main unit for 2 seconds. To enable it, hold **UP** for 2 seconds.

- When the RF clock is enabled this icon will appear on the display.
- When the RF clock is disabled this icon will NOT appear on the display.

SET CLOCK

You only need to do this if you have disabled the radio-controlled clock, or if you are too far from a RF signal.

1. Press and hold **MODE / LIGHT** for 2 seconds to enter Setting Mode.

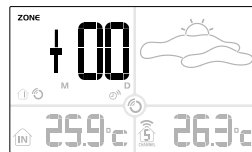

2. The setting will blink to indicate it can now be changed.
3. Press **UP** or **DOWN** to change the setting.
4. Press **MODE / LIGHT** to confirm the setting and move to the next one. The order of the settings is: time zone hour offset (+ / -23 hours), 12 / 24 hour format, hour, minute, year, date / month format, month, date, display language and hourly chime (**ON / OFF**).

You can select 1 of the 5 following languages:

SYMBOL	LANGUAGE
E	English
O	German
F	French
I	Italian
S	Spanish

SWITCH CLOCK DISPLAY

Press **MODE / LIGHT** to toggle between the following clock displays:

- **RF time with hour-offset time (HH:MM)**

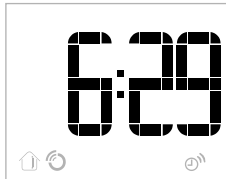

- **Day of the week**



- **Calendar**

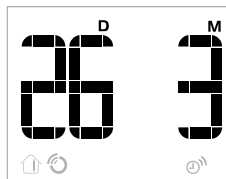

- **RF time without offset**



- **Time-zone hour-offset setting**

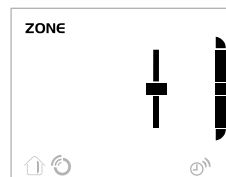

Each display will be backlit for 5 seconds and will return to the main screen display after 10 seconds.

HOURLY CHIME

The hourly chime function when set to ON will beep once at the beginning of every hour, and the chime icon  will show on the display.

ALARM

This product is equipped with a 2-minute crescendo alarm.

VIEW ALARM SETTINGS

Press **ALARM**. The alarm time and status will show in the Clock Area.

SET ALARM

1. Press **ALARM** to switch to alarm display.

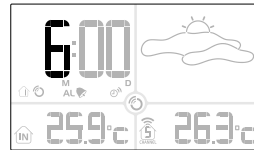

2. Press and hold **ALARM** again, for 2 seconds. The alarm settings will blink.
3. Select the hour and minute. Press **UP** or **DOWN** to change settings. Press **ALARM** to confirm. The alarm will be activated automatically.

ACTIVATE ALARM



Press **ALARM** twice to start toggling between alarm ON and alarm OFF.

 shows in the Clock / Alarm Area when the alarm is activated.



NOTE Press **MODE**, or wait 1 minute to return to clock display.

SILENCE ALARM

When the alarm time is reached, the crescendo alarm will sound for 2 minutes and the backlight will turn on for 5 seconds. To silence the alarm:

- Press  **SNOOZE**  on the remote control to silence it for 8 minutes.

OR

- Press any key on the main unit or remote control except  **SNOOZE**  to mute the alarm and activate it again after 24 hours.

If no button is pressed, the alarm will automatically silence after 2 minutes.

WEATHER FORECAST

This product forecasts the next 12 to 24 hours of weather within a 30-50 km (19-31 mile) radius. The forecast is based on barometric pressure trend readings.



The LCD display shows an animated icon indicating the forecasted weather.

WEATHER FORECAST ICONS

ICON	DESCRIPTION
 Day / Night	Clear
 Day / Night	Partly cloudy
	Cloudy
	Rainy
	Snowy

NOTE The night time icon displays from 6 PM to 6 AM.

TEMPERATURE

This product can display maximum, minimum and current temperatures collected by the remote sensors and main (indoor) unit.

MAXIMUM / MINIMUM RECORDS

- Press **MEMORY** to toggle between maximum (MAX), minimum (MIN) and current records.
- To clear the records, press and hold **MEMORY** for 2 seconds. A beep will sound to confirm that the memory has been cleared.

SELECT MEASUREMENT UNIT

Press the °C / °F button to choose the setting you want.

The display can show indoor temperatures ranging from -5°C to +50°C (23°F to +122°F).

BACKLIGHT

To turn on the backlight for 5 seconds:

- Press **MODE / LIGHT** on the main unit.

OR

- Press **SNOOZE** on the remote control.

NOTE When  appears, the backlight function is deactivated due to low-battery power. Replace with new batteries to operate this function again.

RESET SYSTEM

Insert a thin blunt instrument into the hole below **RESET** to return to the default settings.

NOTE When you press **RESET**, all settings will return to default value, and you will lose all stored information.

REMOTE CONTROL (RE289)

The remote control interacts with the main unit using infrared technology.

The buttons on the remote control complete the same functions as the buttons on the front of the main unit. Refer to the following list of functions and see the relevant section headings for further information:

- Manually view 1 of 5 sensor channel's data or view each channel for 3 seconds using auto-scan - see "Select Sensor Channel".
- Force a manual search for the RF clock reception - see "Radio-Controlled Clock".
- Enable / disable the radio-controlled clock - see "Turn Radio-Controlled Clock On / Off".
- Manually set the clock, calendar and day of the week language - see "Set Clock".
- View the 5 different clock displays - see "Switch Clock Display".
- View the alarm settings, set the alarm, activate the alarm and silence the alarm - see all of "Alarm" section.
- View temperature records - see "Maximum / Minimum Records".

NOTE The sensor auto-search function cannot be operated by the remote control.

NOTE The main unit must be no more than 4 metres (13 feet) from the remote control for a successful connection to take place. Point the remote control directly at the infrared window on the main unit for optimal performance. The remote control cannot perform when there is an obstacle between the 2 units.

SAFETY AND CARE

Clean the product with a slightly damp cloth and alcohol-free, mild detergent. Avoid dropping the product or placing it in a high-traffic location.

WARNINGS

This product is designed to give you years of service if handled properly. Oregon Scientific will not be responsible for any deviations in the usage of the device from those specified in the user instructions or any unapproved alterations or repairs of the product. Observe the following guidelines:

- Never immerse the product in water. This can cause electrical shock and damage the product.
- Do not subject the main unit to extreme force, shock, or fluctuations in temperature or humidity.
- Do not tamper with the internal components.
- Do not mix new and old batteries or batteries of different types.
- Do not use rechargeable batteries with this product.
- Remove the batteries if storing this product for a long period of time.
- Do not scratch the LCD display.

NOTE The technical specification of this product and contents of this user manual are subject to change without notice. Images not drawn to scale.

TROUBLESHOOTING

PROBLEM	SYMPTOM	REMEDY
Calendar	Strange date / month	Change language (→ 6)
Clock	Cannot adjust clock	Disable radio-controlled clock (→ 6)
	Cannot auto-synch	1. Adjust batteries (→ 5) 2. Press RESET (→ 8) 3. Manually activate radio-controlled clock (→ 6)
Temp	Shows "LLL" or "HHH"	Temperature is out-of-range
Remote sensor	Cannot locate remote sensor	Check batteries (→ 5)

SPECIFICATIONS

Main Unit Dimensions

L x W x H	225 x 24 x 141 mm (8.86 x 0.94 x 5.55 inches)
Weight	542 grams (1.19 lbs) without battery

Remote Control Dimensions

L x W x H	108 x 17 x 39 mm (4.25 x 0.67 x 1.54 inches)
Weight	34 grams (0.08 lbs) without battery

Remote Sensor Dimensions

L x W x H	70 x 24.5 x 116 mm (2.76 x 0.96 x 4.57 inches)
Weight	108 grams (0.24 lbs) without battery

Temperature

Unit	°C or °F
Indoor Range	-5°C to 50°C (23°F to 122°F)
Outdoor Range	-20°C to 60°C (-4°F to 140°F)
Resolution	0.1°C (0.2°F)
Memory	Min / Max

Weather Forecast

Display	Sunny (day / night), partly cloudy (day / night), cloudy, rainy, snowy
---------	---

Remote Unit (RTHR328N)

RF frequency	433 MHz
Range	Up to 30 metres (100 feet) with no obstructions
Transmission	Approx. every 1 minute
Channel No.	1, 2, 3, 4 or 5
Unit	°C or °F

Radio-Controlled Clock

Synchronization	Auto or disabled
Clock display	HH:MM
Hour format	12hr AM / PM (MSF format) 24hr (DCF format)
Calendar	DD / MM or MM / DD; Day of the week in 1 of 5 languages (E, G, F, I, S)
Alarm	Daily with 2-minute crescendo
Snooze	8-minute snooze (operated by remote control only)

Power

Main unit

Batteries	4 x UM-3 (AA) 1.5V
-----------	--------------------

Remote Control

Batteries	2 x UM-4 (AAA) 1.5V
-----------	---------------------

Remote Sensor

Batteries	2 x UM-3 (AA) 1.5V
-----------	--------------------

NOTE It is recommended that you use alkaline batteries with this product for longer performance.

ABOUT OREGON SCIENTIFIC

Visit our website (www.oregonscientific.com) to learn more about Oregon Scientific products such as digital cameras; MP3 players; children's electronic learning products and games; projection clocks; health and fitness gear; weather stations; and digital and conference phones. The website also includes contact information for our customer care department in case you need to reach us, as well as frequently asked questions and customer downloads.

We hope you will find all the information you need on our website, however if you'd like to contact the Oregon Scientific Customer Care department directly, please visit: www2.oregonscientific.com/service/support

OR

Call 949-608-2848 in the US.

For international enquiries, please visit: www2.oregonscientific.com/about/international/default.asp

EC-DECLARATION OF CONFORMITY

This product contains the approved transmitter module that complies with the essential requirements of Article 3 of the R&TTE 1999 / 5 / EC Directive, if used as intended and the following standards have been applied:

Safety of information technology equipment

(Article 3.1.a of the R&TTE Directive)

Applied Standard **EN 60950: 2000**

Electromagnetic compatibility

(Article 3.1.b of the R&TTE Directive)

Applied Standards

ETSI EN 301 489-1-3 (Ver.1.4.1): 2002-08

Efficient use of radio frequency spectrum

(Article 3.2 of the R&TTE Directive)

Applied Standards

ETSI EN 300 220-3 (Ver1.1.1): 2000-09

Additional information:

The product herewith complies with the requirements of the Low Voltage Directive 73 / 23 / EC, the EMC Directive 89 / 336 / EC and carries the CE marking accordingly.



Carmelo Cubito
Agrate Brianza (MI) / Italy January 2004
Manufacturer's EU R&TTE Representative

CE

COUNTRIES RTTE APPROVAL COMPLIED

All EC countries, Switzerland **(CH)**

and Norway **(N)**



© 2004 Oregon Scientific. All Rights Reserved.
P/N.: 086-003572-012



Free Manuals Download Website

<http://myh66.com>

<http://usermanuals.us>

<http://www.somanuals.com>

<http://www.4manuals.cc>

<http://www.manual-lib.com>

<http://www.404manual.com>

<http://www.luxmanual.com>

<http://aubethermostatmanual.com>

Golf course search by state

<http://golfingnear.com>

Email search by domain

<http://emailbydomain.com>

Auto manuals search

<http://auto.somanuals.com>

TV manuals search

<http://tv.somanuals.com>