



**Advanced Weather Station
with Atomic Time
Model: BAR208HG**

USER MANUAL

Advanced Weather Station with Atomic Time Model: BAR208HG USER MANUAL

Weather Trends	7
Moon Phase	7
Backlight	7
Reset.....	7
Precautions	7
Specifications	8
About Oregon Scientific	8
EU-Declaration of Conformity	8

CONTENTS

Overview.....	2
Front View	2
Back View	3
Remote Sensor	3
Getting Started.....	3
Insert Batteries	3
Remote Sensor	4
Sensor Data Transmission	4
Clock.....	5
Clock Reception	5
Manually Set Clock	5
Weather Forecast	6
Weather Warning Message.....	6
Temperature and Humidity	6
Ice Warning	6

OVERVIEW

FRONT VIEW (FIG 1)

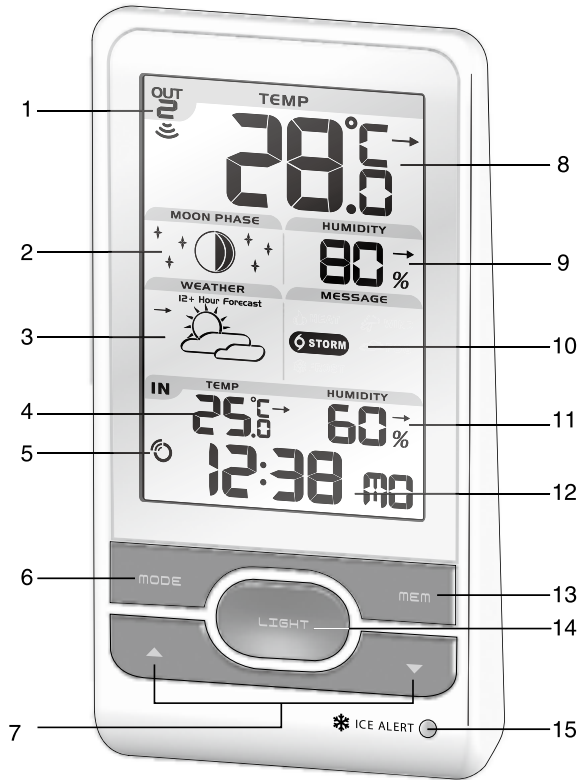

1. Remote sensor reception indicator
2. Moon phase reading
3. Weather forecast
4. Indoor temperature with temperature trend
5. Clock signal reception indicator
6. **MODE**: Change settings / display
7. ▲ / ▼ : Increase / decrease settings; activate / deactivate clock reception signal
8. Outdoor temperature with temperature trend
9. Outdoor humidity with humidity trend
10. Weather warning message
11. Indoor humidity with humidity trend
12. Clock with weekday
13. **MEM**: View current, maximum and minimum temperature / humidity
14. **LIGHT**: Activate backlight for 5 seconds
15. Ice alert LED indicator

BACK VIEW (FIG 2)

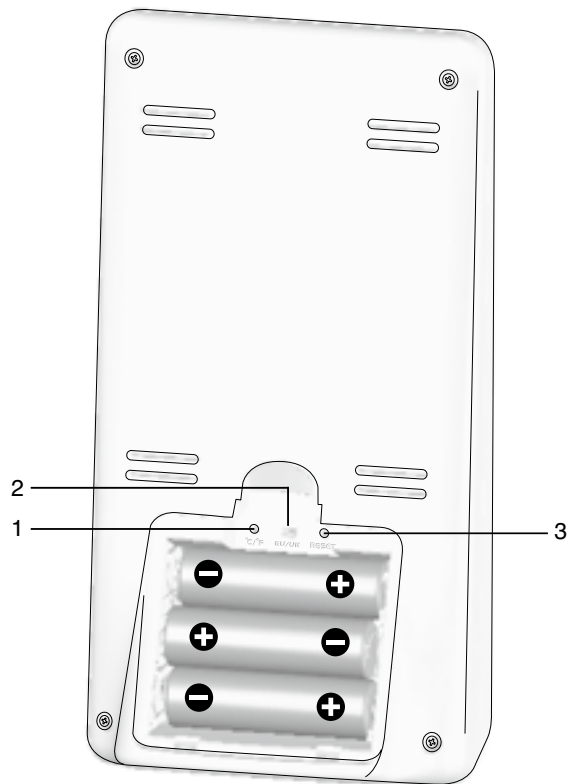

1. °C / °F: Select temperature unit
2. EU / UK: Select the nearest radio signal
3. **RESET**: Reset unit to default settings

REMOTE SENSOR (FIG 3)

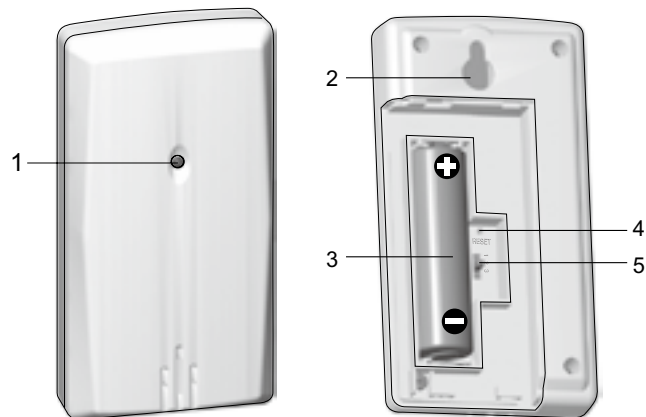

1. LED status indicator
2. Wall mount hole
3. Battery compartment
4. **RESET** hole
5. **CHANNEL** switch

GETTING STARTED

INSERT BATTERIES

1. Remove the battery compartment.
2. Insert the batteries, matching the polarities (see FIG 2).
3. Press **RESET** after each battery change.

 LOCATION	MEANING
Clock / alarm and Indoor temperature area	Main unit batteries low
Outdoor temperature area	Sensor batteries low

REMOTE SENSOR

The main unit can collect data from up to 3 sensors.

To set up the sensor:

1. Open the battery compartment (see FIG 3).
2. Select a channel then press **RESET**.
3. Close the battery door.
4. Place the sensor within 30 m (98 ft) of the main unit using the table stand or wall mount.

TIP Ideal placements for the sensor would be in any location on the exterior of the home at a height of not more than 1.5 m (5 ft) and which can shield it from direct sunlight or wet conditions for an accurate reading.

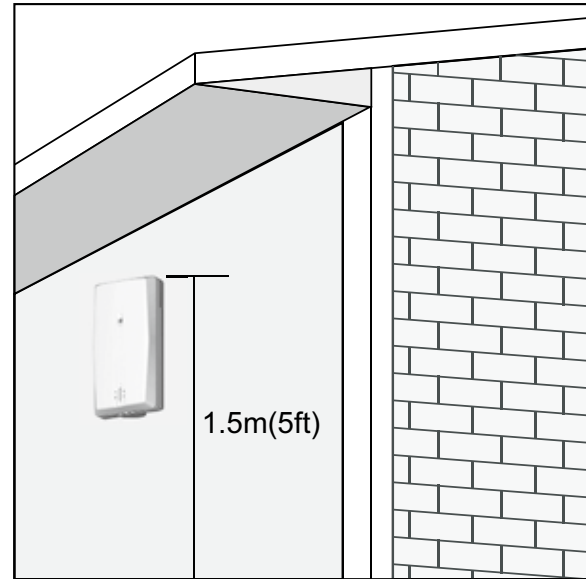



NOTE Use alkaline batteries for longer usage and consumer grade lithium batteries in temperatures below freezing.

SENSOR DATA TRANSMISSION

To search for a sensor:

Press and hold **▲ + MODE**.

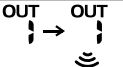
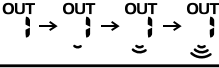
The sensor reception icon in the remote sensor area shows the status:

ICON	DESCRIPTION
	Main unit is searching for sensor(s).
	A channel has been found.
	The sensor cannot be found.

TIP The transmission range may vary depending on many factors. You may need to experiment with various locations to get the best results.

CLOCK

CLOCK RECEPTION

This product is designed to synchronize its clock automatically with a clock signal.

Slide **EU / UK** to select the signal received.

- EU: DCF-77 signal: within 1500 km (932 miles) of Frankfurt, Germany.
- UK: MSF-60 signal: within 1500 km (932 miles) of Anthorn, England.



To enable / disable signal reception:

Press and hold **▲** to enable or **▼** to disable signal reception.

NOTE Reception takes 2-10 minutes. If the signal is weak, it can take up to 24 hours to get a valid signal. If signal

reception is unsuccessful, place your unit next to a window, press and hold **▲** to force another signal search.

Clock signal reception indicator:

STRONG SIGNAL	WEAK SIGNAL	NO SIGNAL
		

MANUALLY SET CLOCK

To set the clock manually, disable the signal reception first.

1. Press and hold **MODE**.
2. Press **▲** or **▼** to change the settings.
3. Press **MODE** to confirm.
4. The settings order is: time zone, 12/24 hr format, hour, minute, year, calendar mode (day – month / month – day), month, day and language.

Time zone offset sets the clock +/- 23 hours from the received clock signal time.





NOTE The language options are English (E), German (D), French (F), Italian (I), and Spanish (S).

To select display mode:

Press **MODE** to choose between clock with seconds / weekday / calendar / moon phase.



WEATHER FORECAST



This product forecasts the next 12 to 24 hours of weather within a 30-50 km (19-31 mile) radius with a 75% accuracy.

	Sunny
	Partially Cloudy
	Cloudy
	Rainy
	Snowy

WEATHER WARNING MESSAGE

The weather warning messages provide indications of probable circumstances that may arise based on the weather station's calculations. The meanings for the warnings are illustrated below:

Warning	Meaning
	Risk of high temperatures
	Risk of fast wind speeds
	Risk of a storm

	Risk of foggy conditions
	Risk of icy conditions

TEMPERATURE AND HUMIDITY

To toggle temperature unit:

Press °C / °F.

To auto-scan between sensors:

Press and hold ▼ + **MEM** to display each sensor's data for 3 seconds.

To end press ▲ .

To toggle between current, minimum and maximum records for the selected sensor:

Press **MEM** repeatedly.

To clear the records:



Press and hold **MEM**.

ICE WARNING

If the channel 1 sensor falls between 3°C to -2 °C (37°F to 28°F), LED indicator will flash, and will stop flashing once the temperature is out of this range.









WEATHER TRENDS

The temperature, humidity and pressure trend icons are based on recent sensor readings.

RISE	STEADY	FALL
		

MOON PHASE

In moon phase mode, press ▲ or ▼ to scan through the years (2001 to 2099).

	New Moon		Full Moon
	Waxing Crescent		Waning Gibbous
	First quarter		Last quarter
	Waxing Gibbous		Waning Crescent

NOTE Star icons around the moon phase will be displayed from 6 o'clock in the evening to 6 o'clock the next morning.

BACKLIGHT

Press **LIGHT** to activate backlight for 5 seconds.

RESET

Press **RESET** to return to the default settings.

PRECAUTIONS

- Do not subject the unit to excessive force, shock, dust, temperature or humidity.
- Do not cover the ventilation holes with any items such as newspapers, curtains etc.
- Do not immerse the unit in water. If you spill liquid over it, dry it immediately with a soft, lint-free cloth.
- Do not clean the unit with abrasive or corrosive materials.
- Do not tamper with the unit's internal components. This invalidates the warranty.
- Only use fresh batteries. Do not mix new and old batteries.
- Images shown in this manual may differ from the actual display.
- When disposing of this product, ensure it is collected separately for special treatment.
- Placement of this product on certain types of wood may result in damage to its finish for which Oregon Scientific will not be responsible. Consult the furniture manufacturer's care instructions for information.
- The contents of this manual may not be reproduced without the permission of the manufacturer.
- Do not dispose old batteries as unsorted municipal waste. Collection of such waste separately for special treatment is necessary.
- Please note that some units are equipped with a battery safety strip. Remove the strip from the battery compartment before first use.

NOTE The technical specifications for this product and the contents of the user manual are subject to change without notice.

SPECIFICATIONS

TYPE	DESCRIPTION
MAIN UNIT	
L x W x H	94 x 51 x 182.5 mm (3.70 x 2.01 x 7.19 in)
Weight	241 g (8.5 oz) without battery
Temperature range	-5°C to 50°C (23°F to 122°F)
Resolution	0.1°C (0.2°F)
Signal frequency	433 MHz
Humidity range	25% - 95%
Humidity resolution	1%
Power	3 x UM-3 (AA) 1.5 V batteries
REMOTE UNIT (THGN132N)	
L x W x H	50 x 22 x 96 mm (1.97 x 0.87 x 3.78 in)
Weight	62 g (2.22 ounces) without battery
Transmission range	30 m (98 ft) unobstructed
Temperature range	-20°C to 60°C (-4°F to 140°F)
Humidity range	25% - 95%
Power	1 x UM-3 (AA) 1.5 V battery

ABOUT OREGON SCIENTIFIC

Visit our website (www.oregonscientific.com) to learn more about Oregon Scientific products. If you're in the US and would like to contact our Customer Care department directly, please visit: www2.oregonscientific.com/service/support.

OR

Call 1-800-853-8883.

For international inquiries, please visit:



www2.oregonscientific.com/about/international

EU-DECLARATION OF CONFORMITY

Hereby, Oregon Scientific, declares that this Advanced Weather Station with Atomic Time (Model: BAR208HG) is in compliance with the essential requirements and other relevant provisions of Directive 1999/5/EC. A copy of the signed and dated Declaration of Conformity is available on request via our Oregon Scientific Customer Service.



COUNTRIES RTTE APPROVAL COMPLIED

All EC countries, Switzerland 
and Norway 

**Estación de previsión
meteorológica avanzada con hora
atómica
Modelo BAR208HG
MANUAL DE USUARIO**

Tendencias meteorológicas 7
Fase de la luna 7
Iluminación..... 7
Reinicio..... 7
Precauciones 7
Ficha Técnica 8
Sobre Oregon Scientific 9
Declaración de conformidad EU 9

CONTENIDOS

Resumen 2
 Vista Frontal 2
 Vista Trasera 3
 Sensor Remoto 3
Para Empezar 4
 Cómo Introducir Las Pilas 4
Sensor Remoto 4
 Transmisión de datos del sensor 5
Reloj..... 5
 Recepción del reloj 5
 Ajuste Manual Del Reloj 5
Previsión meteorológica..... 6
Mensaje de aviso meteorológico 6
Temperatura y humedad 6
 Aviso De Hielo..... 7

RESUMEN

VISTA FRONTAL (FIG 1)

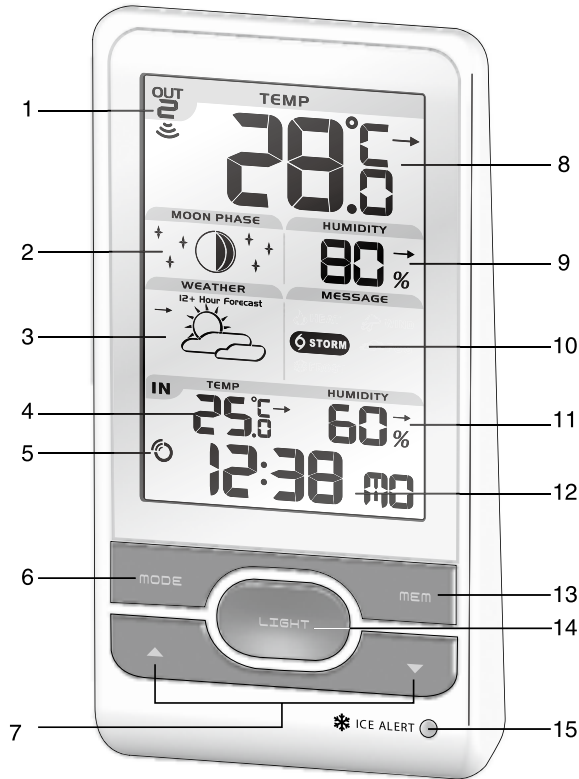

1. Indicador de recepción del sensor remoto
2. Lectura de la fase de la luna
3. Previsión meteorológica
4. Temperatura interior con tendencia de temperatura
5. Indicador de recepción de la señal del reloj
6. **MODE**: Cambiar configuración / pantalla
7. **▲ / ▼** : Subir o bajar ajuste; activar o desactivar la señal de recepción del reloj
8. Temperatura exterior con tendencia de temperatura
9. Humedad exterior con tendencia de humedad
10. Mensaje de aviso meteorológico
11. Humedad interior con tendencia de humedad
12. Reloj con día de la semana
13. **MEM**: Visualizar temperatura / humedad máxima, mínima y actuales
14. **LIGHT**: Activa retroiluminación durante 5 segundos
15. Indicador de alerta de hielo LED

VISTA TRASERA (FIG 2)

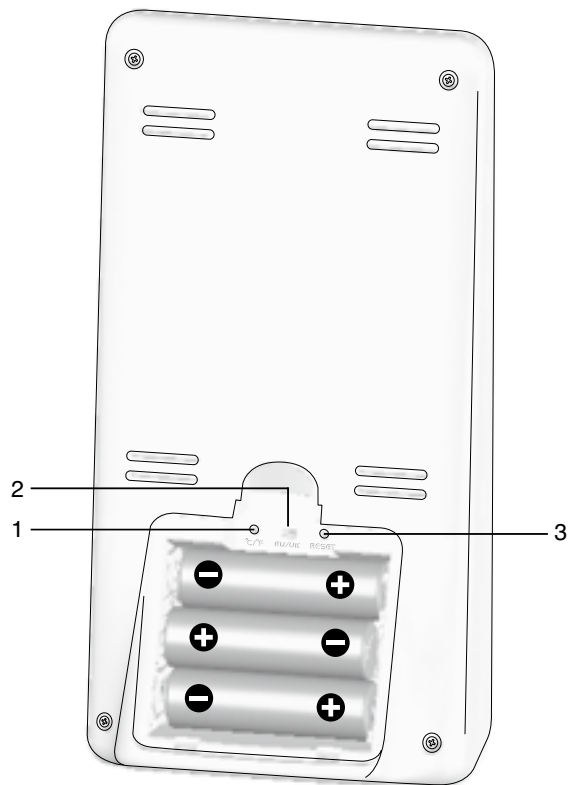

1. °C / °F: Selección de unidad de temperatura
2. **EU / UK**: Seleccionar la señal de radio más cercana

3. **RESET**: La unidad vuelve a los ajustes predeterminados

SENSOR REMOTO (FIG 3)

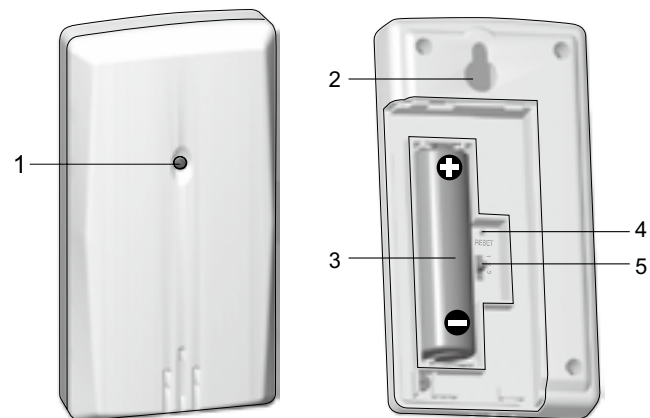

1. Indicador LED de estado
2. Orificio para montaje en pared
3. Compartimento para las pilas
4. Orificio de **RESET**
5. Cambio de **CANAL**

PARA EMPEZAR

CÓMO INTRODUCIR LAS PILAS

1. Abra el compartimento de las pilas.
2. Introduzca las pilas haciendo coincidir la polaridad (véase FIG 2).
3. Pulse **RESET** cada vez que cambie las pilas.

 UBICACIÓN	SIGNIFICADO
Área de reloj / alarma y temperatura interior	Las pilas de la unidad principal están casi gastadas
Área de Temperatura Exterior	Pilas del sensor casi agotadas

SENSOR REMOTO

La unidad principal puede recoger datos de hasta 3 sensores.

Para configurar el sensor:

1. Abra el compartimento para pilas (véase FIG 3).
2. Seleccione un número de canal y pulse **RESET**.
3. Cierre el compartimento de las pilas.
4. Coloque el sensor en un radio de 30 m (98 pies) de la unidad principal usando el montaje en pared o el soporte para mesa.

CONSEJO El lugar ideal para colocar el sensor sería al exterior de la casa a una altura inferior a 1.5 m, en un lugar resguardado de la luz directa del sol y de la lluvia para que las lecturas sean correctas.

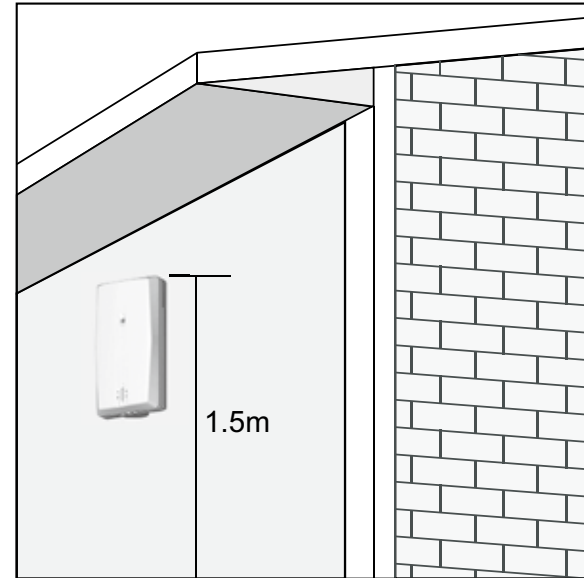



NOTA Recomendamos utilizar pilas alcalinas para que funcione durante más tiempo, y pilas de litio en temperaturas bajo cero.

TRANSMISIÓN DE DATOS DEL SENSOR

Para buscar un sensor:

Pulse **▲** + **MODE** y manténgalos pulsados.

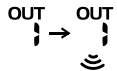
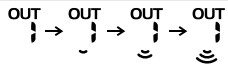
El icono de recepción del Área del sensor remoto muestra el estado:

ICONO	DESCRIPCIÓN
	La unidad principal está buscando sensor(es).
	Se ha encontrado un canal.
	No se encuentra el sensor.

NOTA El alcance de transmisión puede variar debido a muchos factores. Es posible que tenga que probar varias ubicaciones para obtener los mejores resultados.

RELOJ

RECEPCIÓN DEL RELOJ

Este producto ha sido diseñado para sincronizar automáticamente su reloj con una señal de reloj.

Deslice el interruptor **EU** / **UK** para elegir la señal.

- UE: señal DCF-77: a 1500 km (932 millas) de Frankfurt, Alemania.



- Reino Unido: señal MSF-60: a 1500 km (932 millas) de Anthorn, Inglaterra.

Para activar la señal de recepción de la señal:

Pulse **▲** o **▼** y manténgalo pulsado para desactivar la recepción de la señal.

NOTA La recepción tarda entre 2 y 10 minutos. Si la señal de radio es débil, puede tardarse hasta 24 horas en conseguir una señal válida. Si no se encuentra señal, coloque la unidad cerca de una ventana, pulse **▲** y manténgalo pulsado para forzar una búsqueda de señal.

Recepción del indicador de la señal del reloj:

SEÑAL FUERTE	SEÑAL DÉBIL	NO SE RECIBE SEÑAL
		

AJUSTE MANUAL DEL RELOJ

Para configurar manualmente el reloj, primero deberá desactivar la señal de recepción del reloj.

1. Pulse **MODE** y manténgalo pulsado.
2. Pulse **▲** / **▼** para modificar la configuración.
3. Pulse **MODE** para confirmar.

4. La secuencia de configuración es: zona horaria, formato de 12 ó 24 horas, hora, minuto, año, modo de calendario (día – mes / mes – día), mes, día e idioma.

La zona horaria ajusta el reloj a + / -23 horas de la hora recibida por la señal del reloj.





NOTA Las opciones de idioma son inglés (E), alemán (D), francés (F), italiano (I) y español (S).

Cómo seleccionar el modo de pantalla:

Pulse **MODE** para alternar entre reloj con segundos, reloj con día de la semana o con calendario.

PREVISIÓN METEOROLÓGICA

Este producto predice el tiempo de las próximas 12 a 24 horas en un radio de 30 a 50 (19-31 millas) km con un 75% de precisión.

	Soleado
	Parcialmente nublado
	Nublado
	Lluvia
	Nieve

MENSAJE DE AVISO METEOROLÓGICO

Los mensajes de aviso meteorológico ofrecen indicaciones de circunstancias probables que puedan producirse a partir de que los cálculos de la estación meteorológica. Los significados de los avisos se indican a continuación:

Advertencia	SIGNIFICADO
	Riesgo de temperaturas elevadas
	Riesgo de ráfagas de viento
	Riesgo de tormenta
	Riesgo de niebla
	Riesgo de hielo

TEMPERATURA Y HUMEDAD

Selección de unidad de temperatura:

Pulse °C / °F.

Para escanear automáticamente entre sensores:

Pulse ▼ + MEM y manténgalo pulsado para mostrar los datos de CADA sensor durante 3 segundos.

Para acabar pulse ▲.

Para alternar entre registros actuales, mínimos y máximos del sensor seleccionado:

Pulse **MEM** repetidamente.

Para borrar los registros:



Pulse **MEM** y manténgalo pulsado.

AVISO DE HIELO

Si el canal del sensor 1 baja a una temperatura entre 3°C y -2°C (37°F a 28°F), el indicador LED parpadeará, y dejará de parpadear en cuanto la temperatura esté fuera de su alcance.







TENDENCIAS METEOROLÓGICAS

Las tendencias de temperatura, humedad y presión se basan en lecturas recientes de los sensores.

SUBIENDO	ESTABLE	BAJANDO
		

FASE DE LA LUNA

En modo de fase de la luna, pulse ▲ o ▼ y manténgalo pulsado para desplazarse rápidamente por los años (2001 a 2099).

	Luna nueva		Luna llena
	Creciente		Inicio de menguante
	Cuarto creciente		Cuarto menguante
	Casi llena		Menguante

NOTA De las 6 de la tarde a las 6 de la mañana se mostrarán iconos de estrellas alrededor del icono de fase de la luna.

ILUMINACIÓN

Pulse **LIGHT** para iluminar la pantalla durante 5 segundos.

REINICIO

Pulse **RESET** para volver a la configuración predeterminada.

PRECAUCIÓN

- No exponga el producto a fuerza extrema, descargas, polvo, fluctuaciones de temperatura o humedad.

- No cubra los orificios de ventilación con objetos como periódicos, cortinas, etc.
- No sumerja el dispositivo en agua. Si se vertiera líquido en la unidad, límpiela con un paño suave y sin electricidad estática.
- No limpie la unidad con materiales abrasivos o corrosivos.
- No manipule los componentes internos. De hacerlo se invalidaría la garantía.
- Use siempre pilas nuevas. No mezcle pilas viejas con pilas nuevas.
- Las imágenes de esta guía para el usuario puede ser distintas al producto en sí.
- Cuando elimine este producto, asegúrese de que no vaya a parar a la basura general, sino separadamente para recibir un tratamiento especial.
- La colocación de este producto encima de ciertos tipos de madera puede provocar daños a sus acabados. Oregon Scientific no se responsabilizará de dichos daños. Consulte las instrucciones de cuidado del fabricante para obtener más información.
- Los contenidos de este manual no pueden reproducirse sin permiso del fabricante.
- No elimine las pilas gastadas con la basura normal. Es necesario desecharlo separadamente para poder tratarlo.

- Tenga en cuenta que algunas unidades disponen de una cinta de seguridad para las pilas. Retire la cinta del compartimento para pilas antes de usarlo por primera vez.

NOTA La ficha técnica de este producto y los contenidos de este manual de usuario pueden cambiarse sin aviso.

FICHA TÉCNICA

TIPO	DESCRIPTION
UNIDAD PRINCIPAL	
L X A X X A	94 x 51 x 182,5 mm (3,70 x 2,01 x 7,19 pulgadas)
Peso	241 g (8,5 onzas) sin pila
Rango de temperatura	-5°C a 50 °C (23 °F a 122 °F)
Resolución	0,1 °C (0,2 °F)
Frecuencia de la señal	433 MHz
Escala de humedad	25% - 95%
Resolución de la humedad	1%
Alimentación	3 pilas UM-3 (AA) de 1.5V

UNIDAD REMOTA (THGN132N)	
L X A X A	50 x 22 x 96 mm (1,97 x 0,87 x 3,78 pulgadas)
Peso	62 g (2,22 onzas) sin pila
Cobertura de transmisión	30 m (98 pies) sin obstáculos
Rango de temperatura	-20 °C a 60 °C (-4 °F a 140 °F)
Escala de humedad	25% - 95%
Alimentación	1 pilas UM-3 (AA) de 1,5V

SOBRE OREGON SCIENTIFIC

Visite nuestra página web (www.oregonscientific.com) para conocer más sobre los productos de Oregon Scientific.

Si está en EE.UU y quiere contactar directamente con nuestro Departamento de Atención al Cliente, por favor visite www2.oregonscientific.com/service/support.asp o llame al 1-800-853-8883.

Si está en España y quiere contactar directamente con nuestro Departamento de Atención al Cliente, por favor visite www.oregonscientific.es o llame al 902 338 368



Para consultas internacionales, por favor visite www2.oregonscientific.com/about/international.asp.

DECLARACIÓN DE CONFORMIDAD EU

Por medio de la presente Oregon Scientific declara que el [Modelo: BAR208HG] cumple con los requisitos esenciales y cualesquiera otras disposiciones aplicables o exigibles de la Directiva 1999/5/CE. Tiene a su disposición una copia firmada y sellada de la Declaración de Conformidad, solicítela al Departamento de Atención al Cliente de Oregon Scientific.



PAÍSES SUJEITOS A NORMA R&TTE

Todos os países da União Européia, Suíça 
e Noruega 

Funkwetterstation mit Funkuhr und Wetterwarnmeldung Modell BAR 208HG

BEDIENUNGSANLEITUNG

INHALT

Übersicht	2
Vorderansicht	2
Rückansicht	3
Funksendeeinheit	3
Erste Schritte	3
Batterien einlegen	3
Funksendeeinheit	4
Datenübertragung der Sendeeinheit	5
Uhr	5
Zeitsignalempfang	5
Die Uhr manuell einstellen	5
Wettervorhersage	6
Wetterwarnmeldung	6
Temperatur und Luftfeuchtigkeit	7
Frostwarnung	7

Wettertrends	7
Mondphase	7
Hintergrundbeleuchtung	8
Reset	8
Vorsichtsmaßnahmen	8
Technische Daten	9
Über Oregon Scientific	9
EU-Konformitätserklärung	9

ÜBERSICHT

VORDERANSICHT (ABB. 1)

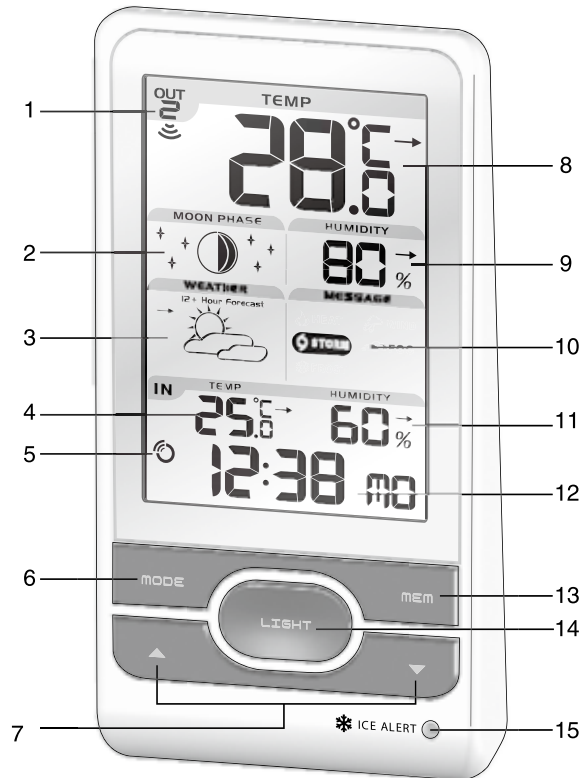

1. Empfangsanzeige für Funksendeeinheit
2. Anzeige der Mondphase
3. Wettervorhersage
4. Innentemperatur mit Temperaturtrend
5. Indikator für Zeitsignalempfang
6. **MODE:** Einstellungen / Anzeige ändern
7. ▲ / ▼ : Einstellung erhöhen / verringern; Zeitsignalsignal aktivieren / deaktivieren
8. Außentemperatur mit Temperaturtrend
9. Außen-Luftfeuchtigkeit mit Luftfeuchtigkeitstrend
10. Wetterwarnmeldung
11. Innen-Luftfeuchtigkeit mit Luftfeuchtigkeitstrend
12. Uhrzeit mit Wochentag
13. **MEM:** Aktuelle, maximale und minimale Temperatur / Luftfeuchtigkeit anzeigen
14. **LIGHT:** Hintergrundbeleuchtung 5 Sekunden lang aktivieren
15. LED-Anzeige für Frostwarnung

RÜCKANSICHT (ABB. 2)

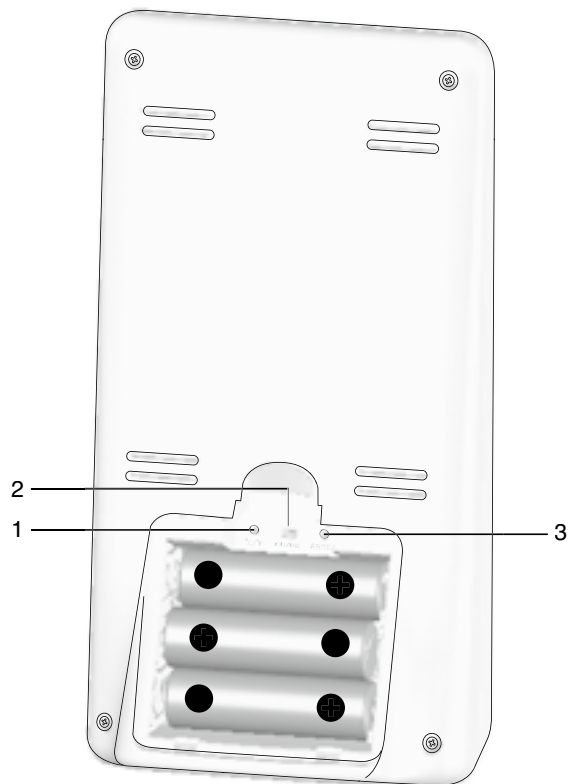

1. °C / °F: Temperatureinheit auswählen
2. **EU / UK**: Das nächstgelegene Funksignal auswählen

3. **RESET**: Gerät auf Standardeinstellungen zurücksetzen

FUNKSENDEEINHEIT (ABB. 3)

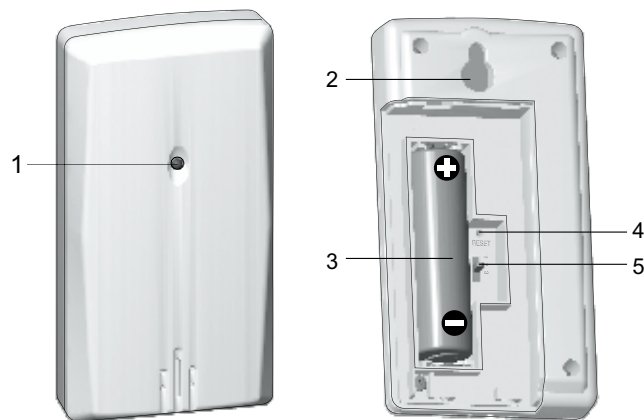

1. LED-Statusindikator
2. Öffnung für Wandmontage
3. Batteriefach
4. **RESET**-Öffnung
5. **CHANNEL**-Schalter

ERSTE SCHRITTE

BATTERIEN EINLEGEN

1. Öffnen Sie das Batteriefach.

- Legen Sie die Batterien ein und achten Sie auf die Übereinstimmung der Polaritäten. (siehe ABB. 2)
- Nach jedem Batteriewechsel auf **RESET** drücken.

 STELLE	BEDEUTUNG
Bereich für Uhr / Alarm und Innentemperatur	Batterien der Basiseinheit sind schwach
Bereich für Außentemperatur	Batterien der Sendeeinheit sind schwach

FUNKSENDEEINHEIT

Die Basiseinheit kann Daten von bis zu 3 Sendeeinheiten empfangen.

So richten Sie die Sendeeinheit ein:

- Öffnen Sie das Batteriefach (siehe ABB. 3).
- Wählen Sie einen Kanal und drücken Sie auf **RESET**.
- Schließen Sie die Batterieklappe.
- Platzieren Sie die Sendeeinheit mit dem Tischaufsteller oder der Wandaufhängung innerhalb von 30 m von der Basiseinheit entfernt.

TIPP Die ideale Platzierung der Sendeeinheit wäre

eine beliebige Stelle an der Außenseite Ihres Hauses in einer Höhe von etwa 150 cm, die vor direkter Sonnenbestrahlung und Feuchtigkeit geschützt ist, um präzise Messwerte zu gewährleisten.

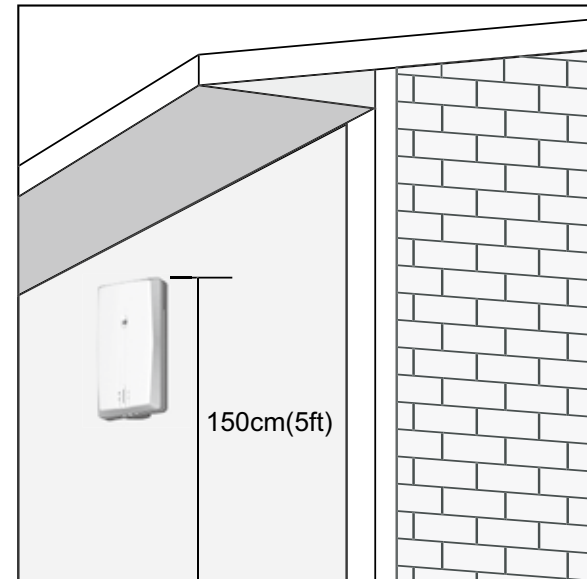



HINWEIS Verwenden Sie Alkaline-Batterien für längere Betriebsdauer sowie Lithium-Batterien für Gebrauch bei Temperaturen unter dem Gefrierpunkt.

DATENÜBERTRAGUNG DER SENDEEINHEIT

So suchen Sie nach einer Sendeeinheit:

Halten Sie **▲ + MODE** gedrückt.

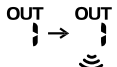
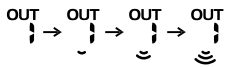
Das Sensor-Empfangssymbol im Bereich der Funksendeeinheit zeigt den Status an:

SYMBOL	BESCHREIBUNG
	Basiseinheit sucht nach Sendeeinheit(en).
	Ein Kanal wurde gefunden.
	Die Sendeeinheit konnte nicht gefunden werden.

TIPP Die Übertragungreichweite kann von mehreren Faktoren abhängen. Sie müssen eventuell mehrere Standorte testen, um optimale Ergebnisse zu erzielen.

UHR

ZEITSIGNALEMPFANG

Dieses Produkt synchronisiert seine Uhr automatisch mit einem Zeitsignal.

Verschieben Sie **EU / UK**, um das Empfangssignal auszuwählen.

- EU: Signal DCF-77: innerhalb von 1500 km (932 Meilen) von Frankfurt, Deutschland.



- UK: Signal MSF-60: innerhalb von 1500 km (932 Meilen) von Anthorn, England.

So aktivieren / deaktivieren Sie den Signalempfang:

Halten Sie **▲** gedrückt, um den Signalempfang zu aktivieren, oder **▼**, um diesen zu deaktivieren.

HINWEIS Der Empfang nimmt etwa 2-10 Minuten in Anspruch. Wenn das Signal schwach ist, kann es bis zu 24 Stunden dauern, bis ein gültiges Signal empfangen wird. Sollte der Signalempfang nicht erfolgreich sein, platzieren Sie Ihr Gerät in der Nähe eines Fensters und halten Sie **▲** gedrückt, um eine weitere Signalsuche zu veranlassen.

Indikator für Zeitsignalempfang:

STARKES SIGNAL	SCHWACHES SIGNAL	KEIN SIGNAL
		

DIE UHR MANUELL EINSTELLEN

Um die Uhr manuell einzustellen, müssen Sie zuerst den Signalempfang deaktivieren.

1. Halten Sie **MODE** gedrückt.

2. Drücken Sie auf ▲ oder ▼, um die Einstellungen zu ändern.
3. Drücken Sie zur Bestätigung auf **MODE**.
4. Die Reihenfolge der Einstellungen lautet: Zeitzone, 12-/24-Stundenformat, Stunde, Minute, Jahr, Kalendermodus (Tag – Monat / Monat – Tag), Monat, Tag und Sprache.

Der Zeitzonenausgleich stellt die Uhr auf bis zu +/- 23 Stunden von der empfangenen Signalzeit ein





HINWEIS Die Sprachoptionen sind Englisch (E), Deutsch (D), Französisch (F), Italienisch (I) und Spanisch (S).

So wählen Sie den Anzeigemodus aus:

Drücken Sie auf **MODE**, um zwischen Uhrzeit mit Sekunden / Wochentag / Kalender auszuwählen.

WETTERVORHERSAGE

Dieses Produkt erstellt eine Wettervorhersage der nächsten 12 bis 24 Stunden innerhalb eines Radius von 30-50 km (19-31 Meilen), mit einer Genauigkeit von 75 %.

	Sonnig
	Teilweise bewölkt
	Bewölkt
	Regnerisch
	Verschneit

WETTERWARNMELDUNG

Die Wetterwarnmeldung liefert Hinweise auf voraussichtliche Ereignisse, die eintreten können und auf den Berechnungen der Wetterstation basieren. Die Bedeutung der Warnhinweise wird nachstehend erläutert:

Warnhinweis	Bedeutung
	Risiko für hohe Temperaturen
	Risiko für hohe Windgeschwindigkeiten
	Risiko für Sturm
	Risiko für Nebel
	Risiko für Frost

TEMPERATUR UND LUFTFEUCHTIGKEIT

So wechseln Sie die Temperatureinheit:

Drücken Sie auf °C / °F.

So veranlassen Sie eine automatische Abfrage (Auto-Scan) aller Sendeeinheiten:

Halten Sie ▼ + MEM gedrückt, um die Daten jeder Sendeeinheit 3 Sekunden lang anzuzeigen.

Um die Abfrage zu beenden, drücken Sie auf ▲.

So wechseln Sie zwischen den aktuellen, minimalen und maximalen Speicherdaten für die gewählte Sendeeinheit:

Drücken Sie wiederholt auf MEM.

So löschen Sie die Daten:

Halten Sie MEM gedrückt.

FROSTWARNUNG

Wenn die Sendeeinheit des Kanals 1 auf einen Wert zwischen 3 °C und -2 °C (37 °F bis 28 °F) abfällt, blinkt der LED-Indikator; er hört auf zu blinken, wenn sich die Temperaturwerte wieder außerhalb dieses Bereichs befinden.

WETTERTRENDS

Die Symbole der Temperatur-, Luftfeuchtigkeits- und Luftdrucktrends basieren auf den letzten Messwerten der Sendeeinheit.

STEIGEND	KONSTANT	FALLEND
		

MONDPHASE

Drücken Sie im Mondphasen-Modus auf ▲ oder ▼, um die einzelnen Jahre abzufragen (2001 bis 2099).

	Neumond		Vollmond
	Zunehmende Sichel		Abnehmender Dreiviertelmond
	Erstes Viertel (zunehmender Halbmond)		Letztes Viertel (Abnehmender Halbmond)
	Zunehmender Dreiviertelmond		Abnehmende Sichel

HINWEIS Die Sternsymbole, die die Mondphase umringen, werden von 18 Uhr abends bis 6 Uhr früh angezeigt.

HINTERGRUNDBELEUCHTUNG

Drücken Sie auf **LIGHT**, um die Hintergrundbeleuchtung 5 Sekunden lang zu aktivieren.

RESET

Drücken Sie auf **RESET**, um das Gerät auf die Standardeinstellungen zurückzusetzen.

VORSICHTSMASSNAHMEN

- Setzen Sie das Gerät keiner extremen Gewalteinwirkung und keinen Stößen aus, und halten Sie es von übermäßigem Staub, Hitze oder Feuchtigkeit fern.
- Sie dürfen die Belüftungsöffnungen nicht mit Gegenständen abdecken, wie z.B. Zeitungen, Vorhänge, usw.
- Tauchen Sie das Gerät niemals in Wasser. Falls Sie eine Flüssigkeit über das Gerät verschütten, trocknen Sie es sofort mit einem weichen, faserfreien Tuch.
- Reinigen Sie das Gerät keinesfalls mit scheuernden oder ätzenden Mitteln.
- Machen Sie sich nicht an den internen Komponenten des Geräts zu schaffen, da dies zu einem Verlust der Garantie führen kann.
- Verwenden Sie nur neue Batterien. Verwenden Sie keinesfalls neue und alte Batterien gemeinsam.
- Die in dieser Anleitung dargestellten Abbildungen können sich vom Original unterscheiden.
- Entsorgen Sie das Gerät ausschließlich in den dafür vorgesehenen, kommunalen Sammelstellen, die Sie bei Ihrer Gemeinde erfragen können.
- Wenn dieses Produkt auf bestimmte Holzflächen gestellt wird, kann die Oberfläche beschädigt werden. Oregon Scientific ist nicht haftbar für solche Beschädigungen. Entsprechende Hinweise entnehmen Sie bitte der Pflegeanleitung Ihres Möbelherstellers.
- Der Inhalt dieser Anleitung darf ohne Genehmigung des Herstellers nicht vervielfältigt werden.
- Verbrauchte Batterien gehören nicht in den Hausmüll. Bitte geben Sie sie bei einer Sammelstelle für Altbatterien bzw. Sondermüll ab.
- Bitte beachten Sie, dass manche Geräte mit einem Batterieunterbrechungstreifen bestückt sind. Vor dem ersten Gebrauch müssen Sie den Streifen aus dem Batteriefach ziehen.

HINWEIS Die technischen Daten für dieses Produkt und der Inhalt der Bedienungsanleitung können ohne Benachrichtigung geändert werden.

TECHNISCHE DATEN

TYP	BESCHREIBUNG
BASISEINHEIT	
L x B x H	94 x 51 x 182,5 mm
Gewicht	241 g ohne Batterie
Temperaturbereich	-5°C bis 50 °C (23 °F bis 122 °F)
Auflösung	0,1 °C (0,2 °F)
Signalfrequenz	433 MHz
Luftfeuchtigkeitsbereich	25% - 95%
Luftfeuchtigkeits- auflösung	1%
Stromversorgung	3 Batterien UM-3 (AA) 1,5V
FUNKSENDEEINHEIT (THGN132N)	
L X B X H	50 x 22 x 96 mm (1.97 x 0.87 x 3.78 in)
Gewicht	62 g ohne Batterie
Übertragungsreichweite	30 m ohne Hindernisse
Temperaturbereich	-20 °C bis 60 °C (-4 °F bis 140 °F)
Luftfeuchtigkeitsbereich	25% - 95%
Stromversorgung	1 Batterie UM-3 (AA) 1,5 V

ÜBER OREGON SCIENTIFIC

Besuchen Sie unsere Website www.oregonscientific.de und erfahren Sie mehr über unsere Oregon Scientific-Produkte. Auf der Website finden Sie auch Informationen, wie Sie im Bedarfsfall unseren Kundendienst erreichen und Daten herunterladen können.

Für internationale Anfragen besuchen Sie bitte unsere Website:

www2.oregonscientific.com/about/international.asp.

EU-KONFORMITÄTSERKLÄRUNG

Hiermit erklärt Oregon Scientific, dass die Funkwetterstation mit Funkuhr und Wetterwarnmeldung (Modell: BAR208HG) mit den grundlegenden Anforderungen und anderen relevanten Vorschriften der Richtlinie 1999/5/EG übereinstimmt. Eine Kopie der unterschriebenen und mit Datum versehenen Konformitätserklärung erhalten Sie auf Anfrage über unseren Oregon Scientific Kundendienst.



KONFORM IN FOLGENDEN LÄNDERN

Alle EG Staaten, die Schweiz (CH)
und Norwegen (N)

Station Météorologique Pro avec horloge radio pilotée Modèle BAR208HG

MANUEL DE L'UTILISATEUR

TABLE DES MATIERES

Vue D'ensemble	2
Face Avant	2
Face Arrière	3
Sonde sans fil.....	3
Pour Commencer	3
Insérez les Piles	3
Sonde sans fil	4
Transmission Des Données Du Capteur	4
Horloge	5
Réception de l'horloge	5
Régler Manuellement L'horloge	5
Prévision Météo	6
Messages d'avertissement météo	6
Température et Humidité	6
Avertisseur De Gel	7

Changements climatiques.....	7
Cycle lunaire	7
Rétro-éclairage	7
Reinitialiser (reset)	7
Précautions	7
Caracteristiques	8
À Propos de Oregon Scientific	9
Déclaration de Conformité EU	9

VUE D'ENSEMBLE

FACE AVANT (FIG 1)

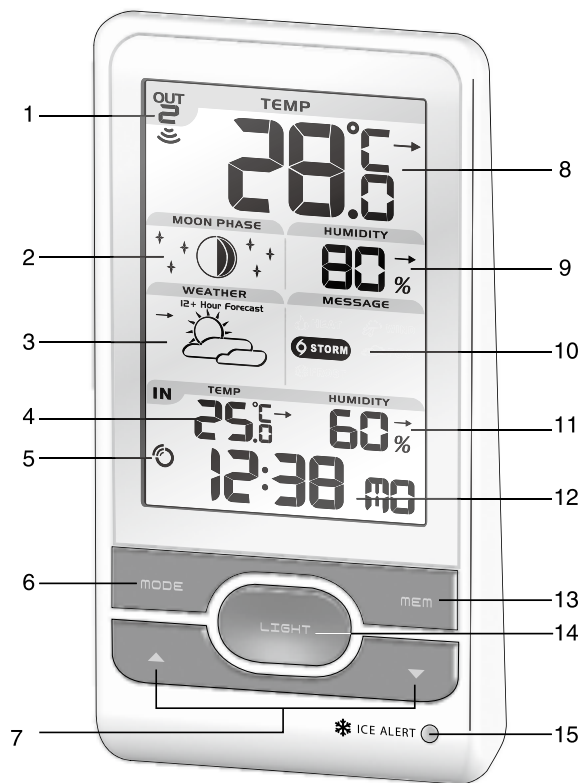

1. Indicateur de réception de la sonde à distance
2. Lecture du cycle lunaire
3. Prévision météorologique
4. Température intérieure avec variation de température
5. Indicateur de réception du signal de l'horloge
6. **MODE** : Changez les réglages / l'affichage
7. ▲ / ▼ : Augmente / diminue les réglages ; active / désactive le signal de réception de l'horloge
8. Température extérieure avec variation de température
9. Humidité extérieure avec variation de l'humidité
10. Message d'avertissement météo
11. Humidité intérieure avec variation de l'humidité
12. Horloge avec les jours de la semaine
13. **MEM**: Affichage de la température et de l'humidité actuelle/maximum/minimum
14. **LIGHT** : Permet d'activer le rétro-éclairage pendant 5 secondes
15. Indicateur LED d'alarme de gel

FACE ARRIERE (FIG 2)

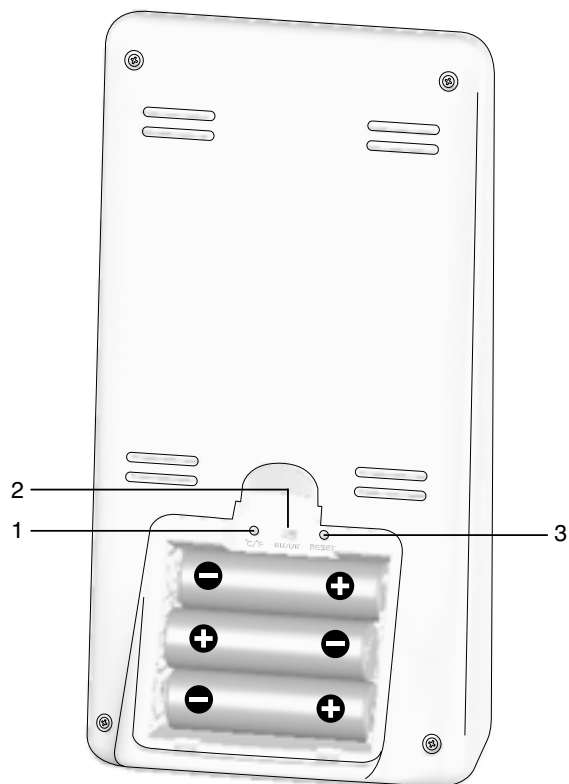

1. °C / °F: Sélectionner l'unité de mesure de température
2. EU / UK : Sélectionne le signal radio le plus proche

3. **REINITIALISER (RESET)**: Réinitialiser l'appareil aux réglages par défaut

SONDE SANS FIL (FIG 3)

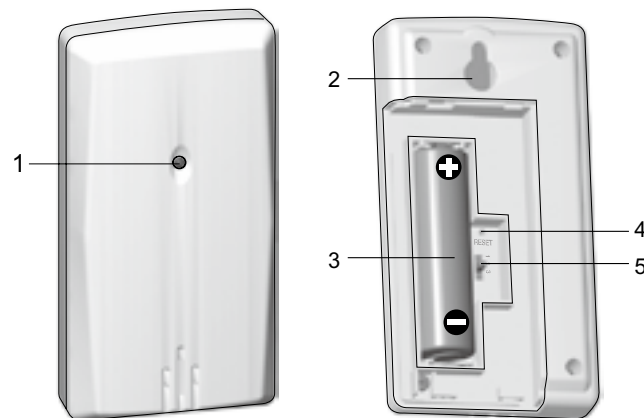

1. Indicateur d'état LED
2. Trou de fixation murale
3. Compartiment des piles
4. Fente **REINITIALISER (reset)**
5. Bouton **CANAL (channel)**

POUR COMMENCER

INSÉREZ LES PILES

1. Retirez le couvercle du compartiment des piles.

2. Insérez les piles en respectant les polarités (voir FIG 2).
3. Appuyez sur **REINITIALISER (RESET)** après chaque changement de piles.

 EMPLACEMENT	SIGNIFICATION
Zone horloge / alarme et température intérieure	Piles faibles de l'appareil principal
Zone de température extérieure	Piles faibles du capteur

SONDE

L'appareil principal est à même de collecter les données de 3 sondes maximum.

Pour installer le capteur :

1. Ouvrez le couvercle du compartiment des piles (voir FIG 3).
2. Sélectionnez un canal puis appuyez sur **RESET**.
3. Fermez le couvercle du compartiment des piles.
4. Installez le capteur à 30 m maximum (98 pieds) de l'appareil principal à l'aide du support de table ou de la fixation murale.

CONSEIL Les emplacements idéaux pour le capteur sont dans tout endroit extérieur à l'habitat, à une hauteur ne dépassant pas les 1.5m (5 pieds) et permettant de le protéger contre la lumière directe du soleil ou de conditions humides, afin d'obtenir une lecture précise.

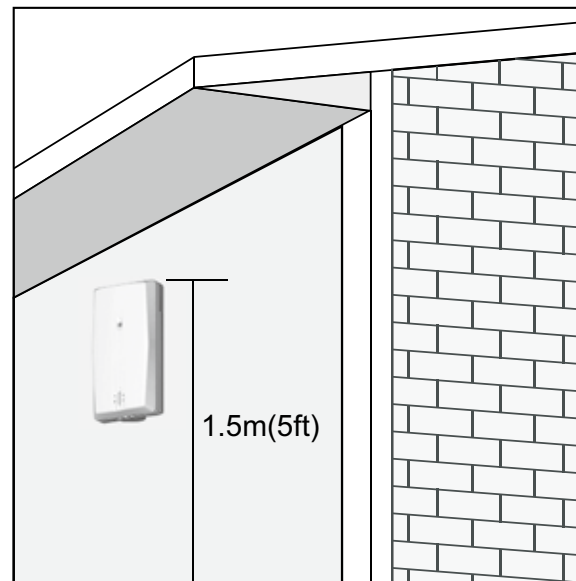



REMARQUE Utilisez des piles alcalines pour un usage prolongé et des piles au lithium pour la consommation lors de basses températures (gel).

TRANSMISSION DES DONNEES DU CAPTEUR

Pour rechercher un capteur :

Appuyez et maintenez la touche **▲ + MODE**.

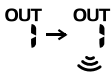
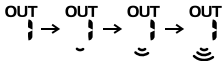
L'icône de réception du capteur située dans la zone de la sonde à distance, indique l'état :

ICONE	DESCRIPTION
	L'appareil principal est à la recherche du/des capteur(s).
	Un canal a été trouvé.
	Le capteur est introuvable.

CONSEIL La portée de transmission peut varier en fonction de plusieurs facteurs. Vous pouvez essayer plusieurs emplacements, afin d'obtenir les meilleurs résultats possibles.

HORLOGE

RECEPTION DE L'HORLOGE

Ce produit est conçu pour synchroniser automatiquement l'horloge avec le signal radio.

Positionnez l'encoche **EU / UK** pour sélectionner le signal à recevoir.



- EU : Signal DCF-77 : dans un rayon de 1500 Km (932 miles) depuis Frankfort, Allemagne.
- UK : Signal MSF-60 : dans un rayon de 1500 Km (932 miles) depuis Anthorn, Angleterre.

Pour activer / désactiver le signal de réception :

Appuyez et maintenez ▲ pour activer ou ▼ pour désactiver la réception du signal.

REMARQUE La réception prend entre 2 et 10 minutes. Si le signal est faible, 24 heures peuvent être nécessaires pour obtenir un signal valide. Si la réception échoue, positionnez votre appareil à proximité d'une fenêtre, appuyez et maintenez ▲ pour forcer la recherche de signal.

Indicateur de réception du signal de l'Horloge :

SIGNAL FORT	SIGNAL FAIBLE	AUCUN SIGNAL
		

RÉGLER MANUELLEMENT L'HORLOGE

Pour régler manuellement l'horloge, vous devez, tout d'abord, désactiver la réception du signal.

1. Appuyez et maintenez la touche **MODE**.
2. Appuyez sur ▲ ou ▼ pour modifier les réglages.
3. Appuyez sur **MODE** pour confirmer.
4. Les réglages s'effectuent dans l'ordre suivant : fuseau horaire, format 12/24 heures, heure, minute, année, mode calendrier mois/jour, jour/mois, mois et langue.

La fonction fuseau horaire règle l'horloge à +/- 23 heures de l'heure du signal reçu.





REMARQUE Les langues disponibles sont l'anglais (E), l'allemand (D), le français (F), l'italien (I) et l'espagnol (S).

Pour sélectionner le mode d'affichage :

Appuyez sur **MODE** pour choisir l'affichage de l'horloge avec les secondes / jours de la semaine / calendrier.





PRÉVISION MÉTÉO

Ce produit vous permet de savoir les prévisions météorologiques pour les 12 à 24 heures dans un rayon de 30 à 50 Km (19-31 miles) avec un taux de fiabilité de 75 %.

	Ensoleillé
	Partiellement nuageux
	Nuageux
	Pluvieux
	Neige

MESSAGE D'AVERTISSEMENT METEO

Les messages d'avertissement météo vous fournissent des indications de circonstances probables pouvant survenir sur la base des calculs des stations météorologiques. Veuillez trouver ci-dessous la signification de chaque avertissement :

Avertissement	Signification
	Risque de hautes températures
	Risques de vent fort
	Risque de tempête
	Risque de brouillard
	Risque de gel

TEMPÉRATURE ET HUMIDIT

Pour sélectionner l'unité de température :

Appuyez sur °C / °F.

Pour activer l'auto balayage entre les sondes sans fil :

Appuyez et maintenez ▼ + MEM pour afficher les données relatives à chaque sonde pendant 3 secondes.

Pour terminer, appuyez sur ▲.

Pour alterner entre les relevés actuels, maximum et minimum de la sonde sans fil sélectionnée :

Appuyez plusieurs fois sur **MEM**.

Pour effacer les relevés :



Appuyez et maintenez **MEM**.

AVERTISSEUR DE GEL

Si le canal 1 du capteur chute dans une température entre 3°C à -2°C (37°F à 28°F), l'indicateur LED clignotera et s'arrêtera de clignoter une fois que la température sera hors de cette plage de températures.









CHANGEMENTS CLIMATIQUES

Les changements de températures et les variations de pression et d'humidité sont basés sur les lectures récentes du capteur.

AUGMENTATION	STABLE	DIMINUTION
		

CYCLE LUNAIRE

En mode de cycle lunaire, appuyez et maintenez les touches ▲ et ▼ pour faire défiler rapidement les années (2001 à 2099).

	Nouvelle lune		Pleine lune
	Premier croissant		Lune gibbeuse décroissante
	Premier quartier		Dernier quartier
	Lune gibbeuse croissante		Dernier croissant

REMARQUE Les icônes représentant des étoiles autour du cycle lunaire s'afficheront de 18 heures à 6 heures le lendemain matin.

RÉTRO-ÉCLAIRAGE

Appuyez sur **LIGHT** pour activer le rétro-éclairage pendant 5 secondes.

REINITIALISER (RESET)

Appuyez sur **REINITIALISER (reset)** pour que l'appareil revienne aux réglages par défaut.

PRÉCAUTIONS

- Ne pas soumettre le produit à une force excessive, au choc, à la poussière, aux changements de température ou à l'humidité.

- Ne pas couvrir les trous de ventilation avec des journaux, rideaux etc...
- Ne pas immerger le produit dans l'eau. Si vous renversez du liquide sur l'appareil, séchez-le immédiatement avec un tissu doux.
- Ne pas nettoyer l'appareil avec des matériaux corrosifs ou abrasifs.
- Ne pas trafiquer les composants internes. Cela invalidera votre garantie.
- N'utilisez que des piles neuves. Ne pas mélanger des piles neuves et usagées.
- Les images de ce manuel peuvent différer de l'aspect réel du produit.
- Lorsque vous désirez vous débarrasser de ce produit, assurez-vous qu'il soit collecté séparément pour un traitement adapté.
- Le poser sur certaines surfaces en bois peut endommager la finition du meuble, et Oregon Scientific ne peut en être tenu responsable. Consultez les mises en garde du fabricant du meuble pour de plus amples informations.
- Le contenu du présent manuel ne peut être reproduit sans la permission du fabricant.
- Ne pas jeter les piles usagées dans les containers municipaux non adaptés. Veuillez effectuer le tri de ces ordures pour un traitement adapté si nécessaire.

- Veuillez remarquer que certains appareils sont équipés d'une bande de sécurité. Retirez la bande du compartiment des piles avant la première utilisation.

REMARQUE Les caractéristiques techniques de ce produit et le contenu de ce manuel peuvent être soumis à modifications sans préavis.

CARACTERISTIQUES

TYPE	DESCRIPTION
APPAREIL PRINCIPAL	
L x l x H	94 x 51 x 182,5 mm (3,70 x 2,01 x 7,19 pouces)
Poids	241 g (8,5 onces) sans les piles
Plage de mesure de température	-5°C à 50 °C (23 °F à 122 °F)
Résolution	0,1 °C (0,2 °F)
Fréquence du signal	433 MHz
Plage d'humidité	25% - 95%
Définition de l'humidité	1%
Alimentation	3 Piles UM-3 (AA) 1,5V

CAPTEUR THERMO-HYGRO (THGN132N)

L X l x H	50 x 22 x 96 mm (1,97 x 0,87 x 3,78 in)
Poids	62 g (2,22 onces) sans les piles
Distance de transmission	30 m (98 pieds) sans obstruction
Plage de mesure de température	-20°C à 60°C (-4°F à 140 °F)
Plage d'humidité	25% - 95%
Alimentation	1 pile UM 3 (AA) 1,5 V

PROPOS D'OREGON SCIENTIFIC

Pour plus d'informations sur les produits Oregon Scientific France, rendez-vous sur notre site www.oregonscientific.fr.

Si vous êtes aux Etats-Unis, vous pouvez contacter notre support consommateur directement : sur le site www2.oregonscientific.com/service/support.asp

OU

par téléphone au: 1-800-853-8883



Pour des renseignements internationaux, rendez vous sur le site: www2.oregonscientific.com/about/international.asp.

DÉCLARATION DE CONFORMITÉ

Par la présente Oregon Scientific déclare que l'appareil [modèle: BAR208HG] est conforme aux exigences essentielles et aux autres dispositions pertinentes de la directive 1999/5/CE. Une copie signée et datée de la déclaration de conformité est disponible sur demande auprès de notre Service Client.



PAYS CONCERNES RTT&E

Tous les pays de l'UE, Suisse 
et Norvège 

Stazione meteorologica con orario radiocontrollato Modello: BAR208HG

MANUALE PER L'UTENTE

INDICE

Panoramica	2
Vista Anteriore	2
Vista Posteriore	3
Sensore Remoto	3
Operazioni Preliminari	4
Inserimento Delle Batterie	4
Sensore Remoto	4
Trasmissione Dei Dati Del Sensore	5
Orologio.....	5
Ricezione dell'ora	5
Impostazione Manuale Dell'ora.....	5
Previsioni meteorologiche.....	6
Messaggio di allerta meteorologica.....	6
Temperatura e umidità.....	6
Allarme Rischio Gelate	7

Tendenze meteorologiche	7
Fasi lunari.....	7
Retroilluminazione	7
Reset.....	7
Avvertenze	7
Specifiche Tecniche	8
Informazioni su Oregon Scientific	9
Dichiarazione di Conformità EU.....	9

PANORAMICA

VISTA ANTERIORE (FIG 1)

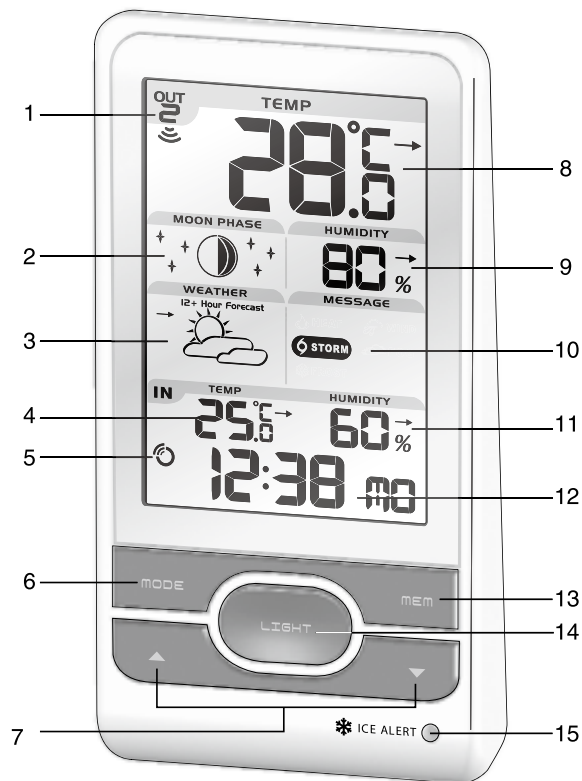

1. Indicatore della ricezione del sensore remoto
2. Indicazione delle fasi lunari
3. Previsioni meteorologiche
4. Temperatura interna con indicazione della tendenza
5. Indicatore della ricezione del segnale orario
6. **MODE**: consente di modificare le impostazioni / la visualizzazione
7. **▲ / ▼** : consente di aumentare o diminuire l'impostazione e di attivare o disattivare il segnale di ricezione dell'ora
8. Temperatura esterna con indicazione della tendenza
9. Umidità esterna con indicazione della tendenza
10. Messaggio di allerta meteorologica
11. Umidità interna con indicazione della tendenza
12. Orologio con giorno della settimana
13. **MEM**: consente di visualizzare temperatura e umidità attuali, massime e minime
14. **LIGHT**: consente di attivare la retroilluminazione per 5 secondi
15. Indicatore LED allarme rischio gelate

VISTA POSTERIORE (FIG 2)

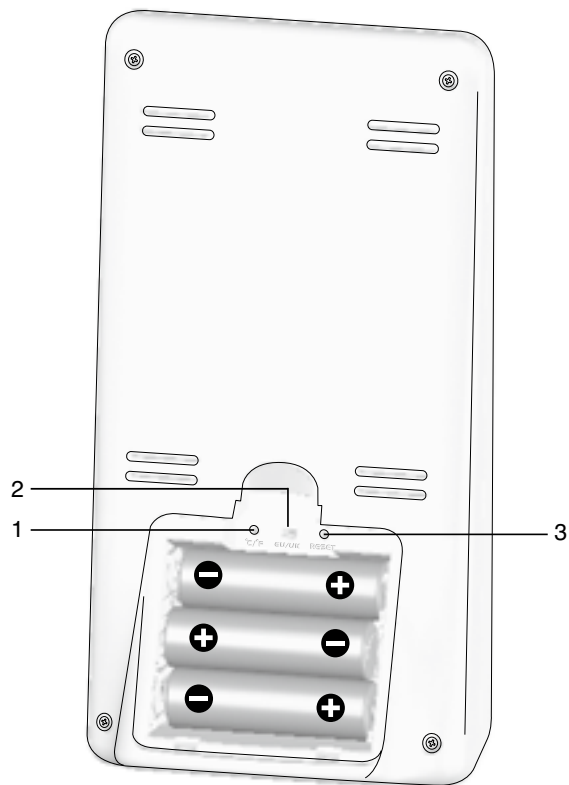

1. °C / °F: consente di selezionare l'unità di misura della temperatura

2. **EU / UK**: consente di selezionare il segnale radio più vicino
3. **RESET**: consente di ripristinare i valori predefiniti dell'unità

SENSORE REMOTO (FIG 3)

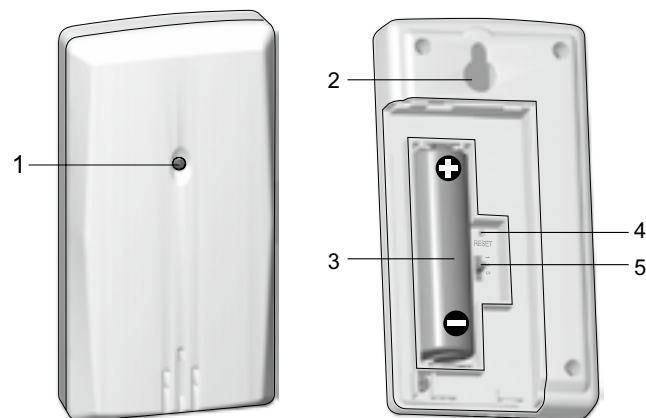

1. Indicatore LED di stato
2. Foro per fissaggio a parete
3. Vano batterie
4. Foro **RESET**
5. Selettore **CHANNEL**

OPERAZIONI PRELIMINARI

INSERIMENTO DELLE BATTERIE

1. Togliere il coperchio del vano batterie.
2. Inserire le batterie, rispettando la polarità indicata (FIG 2).
3. Premere **RESET** dopo ogni sostituzione di batteria.

 POSIZIONE	SIGNIFICATO
Area orologio / sveglia e temperatura interna	Batterie dell'unità principale in esaurimento
Area temperatura esterna	Batterie del sensore in esaurimento

SENSORE REMOTO

L'unità principale è in grado di ricevere dati da un numero massimo di 3 sensori.

Installazione del sensore:

1. Aprire il vano batterie (see FIG 3).
2. Selezionare un canale, quindi premere **RESET**.
3. Chiudere il vano batterie.
4. Posizionare il sensore entro 30 m dall'unità principale utilizzando il supporto da tavolo o il foro per il montaggio a parete.

SUGGERIMENTO La collocazione ideale del sensore è un luogo all'esterno dell'abitazione ad un'altezza non superiore a 1½ metro, dove possa essere protetto da luce solare diretta o umidità per garantire la precisione delle rilevazioni.

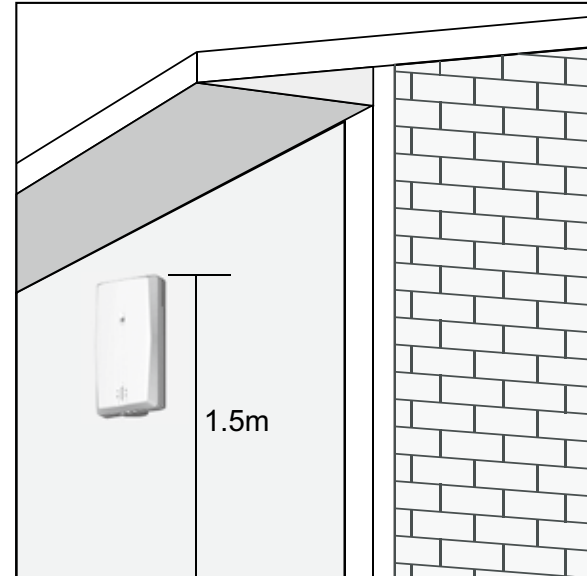



NOTA Si consiglia di batterie alcaline in caso di uso prolungato e batterie al litio in ambienti con temperature inferiori allo 0.

TRASMISSIONE DEI DATI DEL SENSORE

Ricerca di un sensore:

Tenere premuto ▲ + **MODE**.

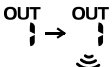
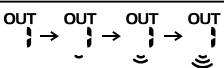
L'icona di ricezione del sensore nell'area relativa al sensore remoto ne indica lo stato:

ICONA	DESCRIZIONE
	L'unità principale è alla ricerca del/i sensore/i.
	È stato rilevato un canale.
	Impossibile trovare il sensore.

SUGGERIMENTO Il campo di trasmissione può variare in base a molti fattori. È possibile dover provare diverse posizioni prima di ottenere i risultati migliori.

OROLOGIO

RICEZIONE DELL'ORA

Questo prodotto è progettato per sincronizzare automaticamente il proprio orologio con un segnale orario.

Spostare la levetta **EU / UK** per selezionare il segnale da ricevere.

- EU: segnale DCF-77: entro 1500 km da Francoforte, Germania.

- UK: segnale MSF-60: entro 1500 km da Anthorn, Inghilterra.

Attivazione / disattivazione della ricezione del segnale:

Per attivare la ricezione del segnale, tenere premuto ▲, per disattivarla tenere premuto ▼.

NOTA Per la ricezione sono necessari dai 2 ai 10 minuti. Se il segnale è debole, possono occorrere fino a 24 ore per riceverne uno valido. Se la ricezione non riesce, posizionare l'unità vicino a una finestra, tenere premuto ▲ per forzare la ricerca di un altro segnale.

Indicatore della ricezione del segnale dell'ora:

SEGNALE FORTE	SEGNALE DEBOLE	NESSUN SEGNALE
		

IMPOSTAZIONE MANUALE DELL'ORA

Per impostare l'ora manualmente, disattivare prima la ricezione del segnale.

1. Tenere premuto **MODE**.
2. Premere ▲ o ▼ per modificare le impostazioni.
3. Premere **MODE** per confermare.

4. L'ordine delle impostazioni è: time zone, formato ora 12 / 24, ora, minuto, anno, modalità calendario (giorno – mese / mese – giorno), mese, giorno e lingua.

La differenza di fuso orario imposta l'orologio a + / - 23 ore dall'ora del segnale ricevuto.





NOTA Le opzioni della lingua sono inglese (E), tedesco (D), francese (F), italiano (I) e spagnolo (S).

Selezione della modalità di visualizzazione:

Premere **MODE** per scegliere tra ora con secondi / giorno della settimana / calendario.





PREVISIONI METEOROLOGICHE

Questo prodotto è in grado di mostrare le previsioni meteorologiche per le successive 12-24 ore entro un raggio di 30-50 km con una precisione del 75%.

	Sereno
	Parzialmente nuvoloso
	Nuvoloso
	Pioggia
	Neve

MESSAGGI DI ALLERTA METEOROLOGICA

I messaggi di allerta meteorologica forniscono indicazioni di probabili situazioni che possono verificarsi in base ai calcoli della stazione meteorologica. Il significato delle icone è illustrato qui sotto:

Icona	Rischio
	Nebbia
	Gelo
	Temperature elevate
	Vento a forte velocità
	Temporale

TEMPERATURA E UMIDITÀ

Selezione delle unità di misura della temperatura:

Premere °C / °F.

Attivazione della ricerca automatica tra i sensori:

Tenere premuto ▲ + **MEM** per visualizzare i dati di ciascun sensore per 3 secondi.

Per terminare, premere ▼.

Allernanza delle rilevazioni attuale, minima e massima del sensore selezionato:

Premere ripetutamente **MEM**.

Cancellazione delle rilevazioni:



Tenere premuto **MEM**.

ALLARME RISCHIO GELATE

Se il sensore del canale 1 scende tra i 3°C e i -2°C, l'indicatore LED lampeggia e smetterà di lampeggiare quando la temperatura sarà uscita da questa fascia.

TENDENZE METEOROLOGICHE

Le icone relative alla tendenza barometrica, a quella della temperatura e a quella dell'umidità si basano sulle recenti rilevazioni del sensore.

IN AUMENTO	STABILE	IN DIMINUZIONE
		

FASI LUNARI

In modalità fasi lunari, premere ▲ o ▼ per selezionare gli anni (dal 2001 al 2099).

	Luna nuova		Luna piena
	Falce di luna crescente		Luna calante
	Primo quarto		Ultimo quarto
	Luna crescente		Falce di luna calante

NOTA Le icone delle stelle intorno alla fase lunare vengono visualizzate dalle ore 18 alle ore 6 del giorno successivo.

RETROILLUMINAZIONE

Premere **LIGHT** per attivare la retroilluminazione per 5 secondi.

RESET

Premere **RESET** per ripristinare le impostazioni predefinite dell'unità.

AVVERTENZE

- Non sottoporre il prodotto a forza eccessiva, urti, polvere, temperatura o umidità.
- Non otturare i fori di aerazione con oggetti come giornali, tende, etc.

- Non immergere l'unità in acqua. Se si versa del liquido sul prodotto, asciugarlo immediatamente con un panno morbido e liscio.
- Non pulire l'unità con materiali abrasivi o corrosivi.
- Non manomettere i componenti interni. In questo modo si invalida la garanzia.
- Utilizzare solo batterie nuove. Non mescolare batterie nuove con batterie vecchie.
- Le immagini del manuale possono differire dalla realtà.
- Al momento dello smaltimento del prodotto, utilizzare la raccolta differenziata.
- Oregon Scientific declina ogni responsabilità per eventuali danni alle finiture causati dal posizionamento del prodotto su determinati tipi di legno. Consultare le istruzioni fornite dal fabbricante del mobile per ulteriori informazioni.
- Il contenuto di questo manuale non può essere ristampato senza l'autorizzazione del fabbricante.
- Non smaltire le batterie vecchie come rifiuto non differenziato. È necessario che questo rifiuto venga smaltito mediante raccolta differenziata per essere trattato in modo particolare.
- Alcune unità sono dotate di una striscia di sicurezza per le batterie. Rimuovere la striscia dal vano batterie prima del primo utilizzo.

NOTA Le specifiche tecniche del prodotto e il contenuto del manuale per l'utente possono essere modificati senza preavviso.

SPECIFICHE TECNICHE

TIPO	DESCRIZIONE
UNITÀ PRINCIPALE	
L x P x H	94 x 51 x 182,5 mm
Peso	241 g senza batteria
Campo di misurazione della temperatura	da -5°C a 50 °C
Risoluzione	0,1 °C (0,2 °F)
Frequenza segnale	433 MHz
Campo di misurazione umidità	25% - 95%
Risoluzione umidità	1%
Alimentazione	3 batterie UM-3 (AA) da 1.5V
UNITÀ REMOTA (THGN132N)	
L x P x H	50 x 22 x 96 mm
Peso	62 g senza batteria
Campo di trasmissione	30 m senza ostruzioni
Campo di misurazione della temperatura	da -20°C a 60°C
Campo di misurazione umidità	25% - 95%
Alimentazione	1 batteria UM-3 (AA) da 1,5 V

INFORMAZIONI SU OREGON SCIENTIFIC

Per avere maggiori informazioni sui nuovi prodotti Oregon Scientific visita il nostro sito internet www.oregonscientific.it, dove potrai trovare tutte le informazioni di cui hai bisogno.

Per ricerche di tipo internazionale puoi visitare invece il sito www2.oregonscientific.com/about/international.asp.

DICHIARAZIONE DI CONFORMITA' EU

Con la presente Oregon Scientific dichiara che questo prodotto (Modello: BAR208HG) è conforme ai requisiti essenziali ed alle altre disposizioni pertinenti stabilite dalla direttiva 1999/5/CE. Una copia firmata e datata della Dichiarazione di Conformità è disponibile, su richiesta, tramite il servizio clienti della Oregon Scientific.



PAESI CONFORMI ALLA DIRETTIVA R&TTE

Tutti i Paesi Europei, Svizzera (CH)

E Norvegia (N)

Geavanceerd Weerstation met Atoomtijd Modèle BAR208HG HANDLEIDING

Weertrends	7
Maanstand	7
Schermverlichting	7
Reset	7
Waarschuwingen	8
Specificaties	8
Over Oregon Scientific	9
EU-Verklaring van Conformiteit	9

INHOUD

Overzicht	2
Voor kant	2
Achterkant	3
Buitensensor	3
Starten	4
Plaats De Battierijen.....	4
Buitensensor	4
Sensor Gegevens Verzending	5
Klok	5
Klok ontvangst	5
Klok Handmatig Instellen	5
Weersverwachting	6
Weerwaarschuwingen	6
Temperatuur en Vochtigheid	6
Vorstwaarschuwing	7

OVERZICHT

VOORKANT (FIG 1)

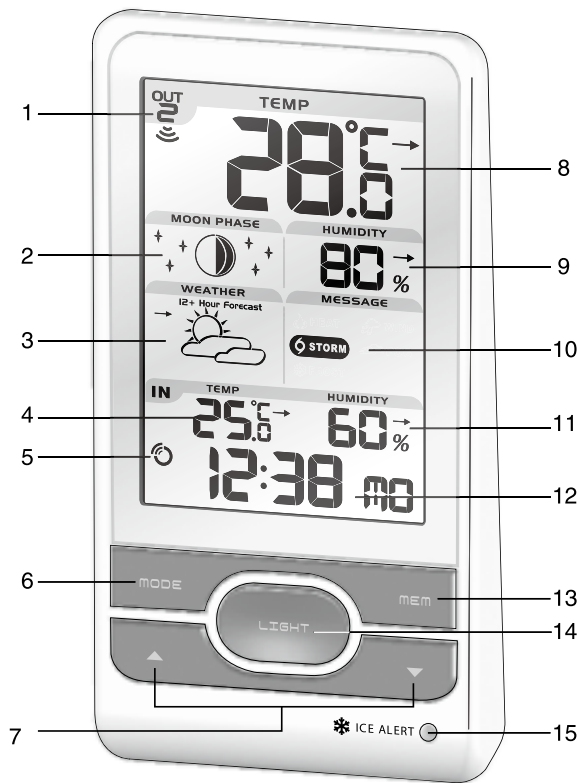

1. Ontvangstindicator buitensensor
2. Gegevens maanstand
3. Weersverwachting
4. Binnentemperatuur met temperatuurtrend
5. Ontvangstindicator van kloksignaal
6. **MODE**: Instellingen / Scherm Aanpassen
7. ▲ / ▼: Verhogen / verlagen instelling; aanzetten / uitzetten klok ontvangtsignaal
8. Buitentemperatuur met temperatuurtrend
9. Buitenvochtigheid met vochtigheidstrend
10. Weerwaarschuwing
11. Binnenvochtigheid met vochtigheidstrend
12. Klok met dag van de week
13. **MEM**: Bekijk huidige maximum en minimum temperatuur / vochtigheid
14. **LIGHT**: Activeer schermverlichting voor 5 seconden.
15. Indicator-LED vorstwaarschuwing

ACHTERKANT (FIG 2)

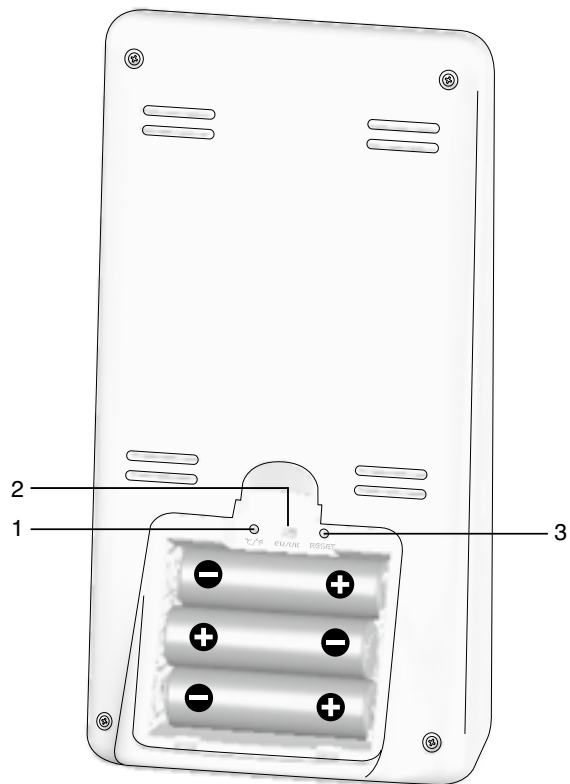

1. °C / °F: Temperatureenheid Selecteren
2. EU / UK: Selecteer dichtstbijzijnde kloksignaal

3. **RESET**: Het apparaat terugzetten op standaardinstellingen

BUITENSOROR (FIG 3)

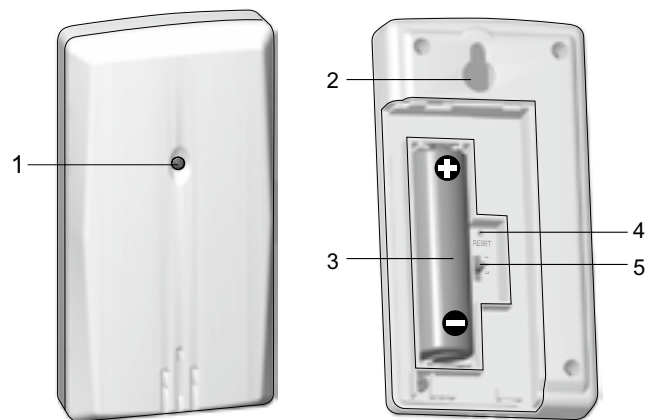

1. Statusindicator LED
2. Muurbevestigingsgat
3. Batterijvak
4. **RESET** gat
5. **KANAAL** schakelaar

STARTEN

PLAATS DE BATTERIJEN

1. Verwijder het klepje van het batterijvak.
2. Plaats de batterijen volgens de aangegeven polariteit. (Zie FIG 2).
3. Druk altijd op **RESET** wanneer u de batterijen vervangen heeft.

 LOCATIE	BETEKENIS
Klok / Alarm	Batterij van het apparaat zwak
Buitentemperatuur- en -vochtigheidsvak	Batterij sensor zwak

BUITENSENSOR

Het apparaat kan gegevens verzamelen van tot 3 sensoren.

Om de sensor in te stellen:

1. Open het batterijvak (Zie FIG 3).
2. Selecteer een kanaal en druk op **RESET**.
3. Sluit het batterijvak.
4. Plaats de sensor binnen 30m (98 ft) van het basisstation door middel van tafelstandaard of muurbevestiging.

TIP De ideale plek voor nauwkeurige metingen van de sensor zou een locatie buitenshuis, op een hoogte van niet meer dan anderhalve meter zijn, waar geen negatieve invloed van direct zonlicht of overvloedige vochtigheid is.

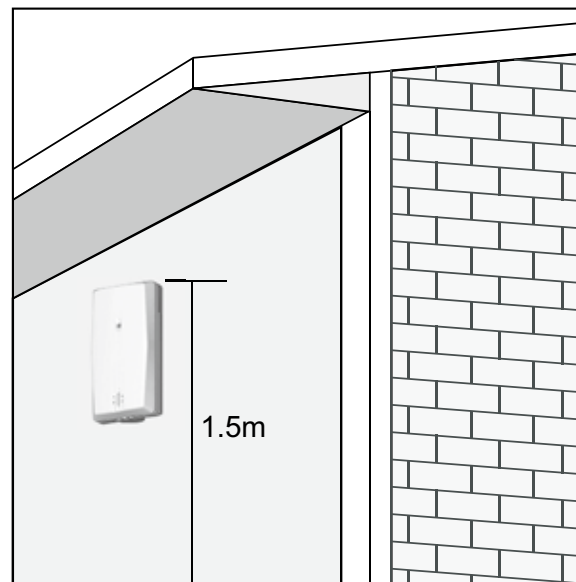



NB Wij raden u aan alkalinebatterijen te gebruiken voor langdurig gebruik en lithium batterijen bij temperaturen onder het vriespunt.

SENSOR GEGEVENS VERZENDING

Om een sensor te zoeken:

Houd **▲** + **MODE** ingedrukt.

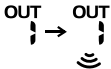
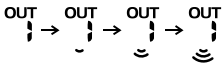
Het sensorontvangsticoon in het buitensensorvak geeft de status weer:

ICOON	BESCHRIJVING
	Het apparaat zoekt sensor(en).
	Kanaal gevonden.
	De sensor kan niet gevonden worden.

TIP Het zendbereik kan variëren, afhankelijk van allerlei factoren. U kunt het best verschillende plekken uitproberen om de beste voor uw sensor te vinden.

KLOK

KLOK ONTVANGST

Dit product is ontworpen om zijn klok automatisch te synchroniseren door middel van een kloksignaal.

Schuif de **EU** / **UK** schakelaar naar het te ontvangen signaal.

- EU: DCF-77 signaal: binnen 1500 km (932 mijl) van Frankfurt, Duitsland.
- UK: MSF-60 signaal: binnen 1500 km (932 mijl) van Anthorn, Engeland.

Om signaalontvangst aan/uit te zetten:

Houd **▲** ingedrukt om signaalontvangst aan te zetten of **▼** om het uit te zetten.

NB Synchronisatie kan 2-10 minuten duren. Als het signaal zwak is, kan het tot 24 uur duren om een geldig signaal te ontvangen. Indien geen signaal gevonden wordt, zet het apparaat dan bij een raam en houd **▲** ingedrukt om het zoeken naar een signaal te forceren.

Ontvangstindicator van kloksignaal:

STERK SIGNAAL	ZWAK SIGNAAL	GEEN SIGNAAL
		

KLOK HANDMATIG INSTELLEN

Om de klok handmatig in te stellen, moet u eerst signaalontvangst uit zetten.

1. Houd **MODE** ingedrukt.
2. Druk **▲** of **▼** om de instellingen te wijzigen.

3. Druk op **MODE** om te bevestigen.
4. De volgorde van instellingen is: tijdzone, 12 / 24 uur formaat, uren, minuten, jaar, kalendermodus (dag- maand / maand – dag), maand, dag en taal.

De tijdzone stelt de klok in op tot + / -23 uur van het ontvangen kloksignaal.



NB De beschikbare talen zijn Engels (E), Duits (D), Frans (F), Italiaans (I) en Spaans (S).

Om de weergavemodus te selecteren:

Druk **MODE** om te kiezen tussen weergave van klok met seconden / weekdag / kalender.

WEERSVERWACHTING



Dit product voorspelt de volgende 12 tot 24 uur weer in een straal van 30-50 km (19-31 mijl) met een nauwkeurigheid van 75%.

	Zonnig
	Half Bewolkt
	Bewolkt
	Regenachtig

	Sneeuw
--	--------

WEERWAARSCHUWINGEN

Weerwaarschuwingen geven een indicatie van mogelijke weersgesteldheid die kan ontstaan gebaseerd op de berekeningen van het weerstation. De betekenissen van de waarschuwingen staan hier onder aangegeven:

Waarschuwing	Betekenis
	Kans op hoge temperaturen
	Kans op hoge windsnelheden
	Kans op storm
	Kans op mist
	Kans op vorst

TEMPERATUUR EN VOCHTIGHEID

Om de temperatuureenheid in te stellen:

Druk °C / °F.

Om automatisch door de sensoren te schakelen (auto-scan):

Houd ▼ + **MEM** ingedrukt om de gegevens van elke sensor 3 seconden weer te geven.

Houd ▲ ingedrukt om te stoppen.

Om te kiezen tussen huidige, minimum en maximum gegevens van de geselecteerde sensor:

Druk herhaaldelijk op **MEM**.

Om de gegevens te wissen:



Houd **MEM** ingedrukt.

VORSTWAARSCHUWING

Als de sensor op kanaal 1 tussen de 3°C tot -2°C (37°F tot 28°F) komt, zal de indicator-LED gaan knipperen, en hij zal weer stoppen wanneer de temperatuur weer buiten deze zone gaat.









WEERTRENDS

De temperatuur-, vochtigheids- en luchtdruktrendiconen zijn gebaseerd op recente sensormetingen.

STIJGEND	STABIEL	DALEND
		

MAANSTAND

Houd in maanstandmodus ▲ of ▼ ingedrukt om snel door de jaren te zoeken (2001 tot 2099).

	Nieuwe Maan		Volle Maan
	Wassende Halve Maan		Afnemende Volle Maan
	Eerste kwartier		Laatste kwartier
	Wassende Volle Maan		Afnemende Halve Maan

NB Stericonen rond de maandstand worden weergegeven van 6:00 's avonds tot 6:00 's ochtends.

SCHERMVERLICHTING

Druk **LIGHT** om de schermverlichting gedurende 5 seconden te activeren.

RESET

Druk **RESET** om de standaardinstellingen te gebruiken.

WAARSCHUWINGEN

- Stel het apparaat niet bloot aan extreme klappen, schokken, stof, temperatuur of vochtigheid.
- Dek de ventilatiegaten niet af met kranten, gordijnen etc..
- Dompel het product nooit onder in water. Als u water over het apparaat morst, droog het dan onmiddellijk af met een zachte stofvrije doek.
- Reinig het apparaat niet met krassende of bijtende materialen.
- Laat de interne componenten met rust. Anders kan dit de garantie beïnvloeden.
- Gebruik alleen nieuwe batterijen. Gebruik nooit oude en nieuwe batterijen door elkaar.
- De in deze handleiding weergegeven plaatjes kunnen afwijken van de werkelijkheid.
- Wanneer u dit product weg gooit, zorg dan dat het opgehaald wordt door de daarvoor bestemde afvaldienst.
- Dit product kan eventueel schade veroorzaken aan de laklaag van bepaalde houtsoorten. Oregon Scientific is hiervoor niet aansprakelijk. Lees de instructies van de fabrikant van het meubel voor meer informatie.
- De inhoud van deze handleiding mag niet worden vermenigvuldigd zonder toestemming van de fabrikant.
- Gooi lege batterijen niet bij het huisvuil. Dergelijk afval

moet gescheiden verwerkt worden.

- Let op, sommige apparaten zijn voorzien van een batterijstrip. Verwijder deze strip uit het batterijvak alvorens het apparaat te gebruiken.

NB De technische specificaties van dit product en de inhoud van de handleiding zijn zonder voorafgaande waarschuwing aan veranderingen onderhevig.

SPECIFICATIES

TYPE	BESCHRIJVING
BASISSTATION	
L x B x H	94 x 51 x 182,5 mm (3,70 x 2,01 x 7,19 in)
Gewicht	241 g (8,5 oz) zonder batterij
Temperatuurbereik	-5°C tot 50 °C (23 °F tot 122 °F)
Resolutie	0,1 °C (0,2 °F)
Signaalfrequentie	433 MHz
Vochtigheidsbereik	25% - 95%
Resolutie vochtigheid	1%
Voeding	3 x UM-3 (AA) 1,5V batterijen

BUITENSENSOR (THGN132N)	
L x B x H	50 x 22 x 96 mm (1,97 x 0,87 x 3,78 in)
Gewicht	62 g (2,22 oz) zonder batterij
Zendbereik	30 m (98 ft) in open ruimte
Temperatuurbereik	-20 °C tot 60 °C (-4 °F tot 140 °F)
Vochtigheidsbereik	25% - 95%
Voeding	1 x UM-3 (AA) 1,5V batterijen

OVER OREGON SCIENTIFIC

Bezoek onze website (www.oregonscientific.com) om meer te weten over uw nieuwe product en andere Oregon Scientific producten zoals digitale foto toestellen, gezondheids- en fitnessuitrusting en weerstations. Op deze website vindt u tevens de informatie over onze klantendienst, voor het geval u ons wenst te contacteren.

EU-VERKLARING VAN CONFORMITEIT

Bij deze verklaart Oregon Scientific dat deze [Model: BAR208HG] voldoet aan de essentiële eisen en aan de overige relevante bepalingen van Richtlijn 1999/5/EC. Een kopie van de getekende en gedateerde Conformiteitsverklaring is op verzoek beschikbaar via onze Oregon Scientific klanten service.



LANDEN DIE ZIJN ONDERWORPEN AAN RTT&E

Alle EEG-landen, Zwitserland (CH)
en Noorwegen (N)

Meteorológica avançada com relógio rádio-controlado Modèle BAR208HG MANUAL DO USUÁRIO

ÍNDICE

Visão Geral	2
Vista Frontal	2
Vista Traseira	3
Sensor Remoto	3
Primeiros Passos	4
Inserção De Pilhas	4
Sensor Remoto	4
Transmissão De Dados Do Sensor	5
Relógio	5
Recepção do relógio	5
Ajuste Manual Do Relógio.....	5
Previsão do tempo	6
Mensagem de Aviso de Tempo	6
Temperatura e umidade	6
Aviso de Gelo.....	7

Tendências de temperatura	7
Fase da Lua	7
Luz de fundo	7
Reset	7
Precauções	8
Especificações	8
Sobre a Oregon Scientific	9
Declaração de conformidade da UE	9

VISÃO GERAL

VISTA FRONTAL (FIG 1)

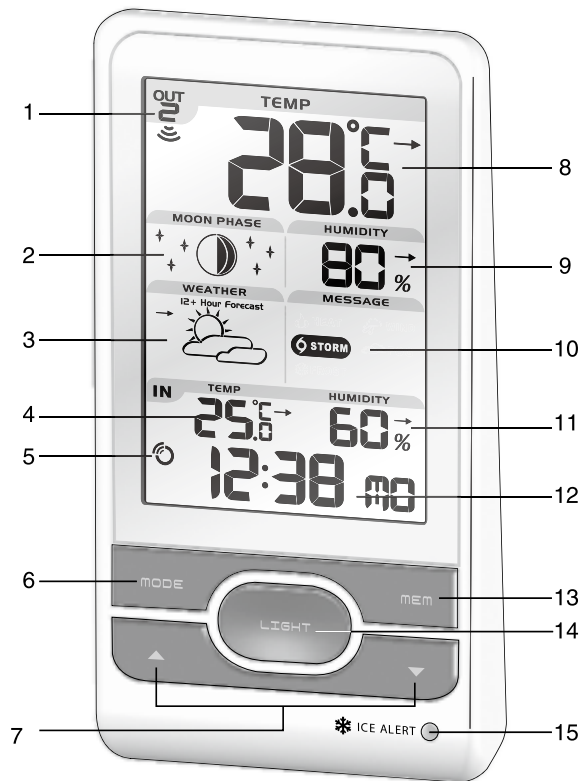

1. Indicador de recepção do sensor remoto
2. Leitura de fase da lua
3. Previsão do tempo
4. Temperatura interna com tendência de temperatura
5. Indicador de recepção do sinal do relógio
6. **MODE**: Altera os ajustes / display
7. ▲ / ▼: Aumenta / diminui o ajuste; ativa / desativa o sinal de recepção do relógio
8. Temperatura externa com tendência de temperatura
9. Umidade externa com tendência de umidade
10. Mensagem de aviso de tempo
11. Umidade interna com tendência de umidade
12. Relógio com dias da semana
13. **MEM**: Exibe a temperatura / umidade atual, máxima e mínima
14. **LIGHT**: Ativa a luz de fundo por 5 segundos
15. Indicador LED de alerta de gelo

VISTA TRASEIRA (FIG 2)

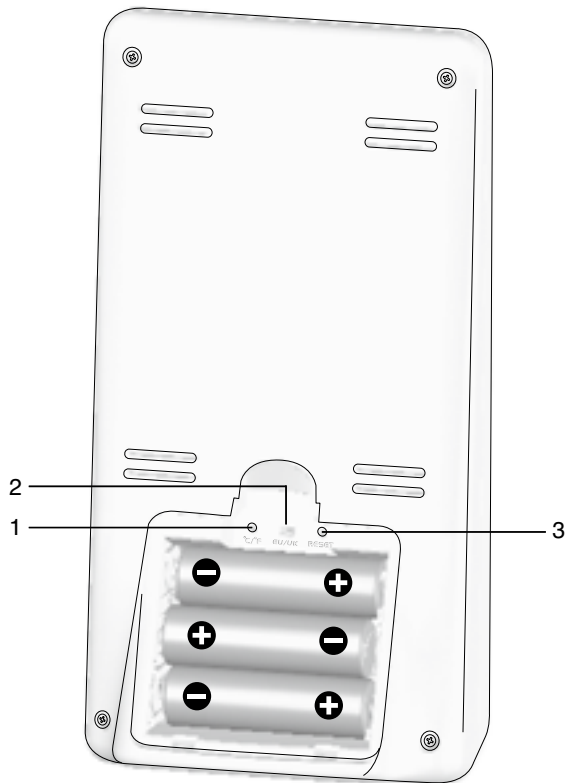

1. °C / °F: seleciona a unidade de temperatura
2. EU / UK: seleciona o sinal de rádio mais próximo

3. **RESET**: retorna a unidade aos valores de ajuste padrão

SENSOR REMOTO (FIG 3)

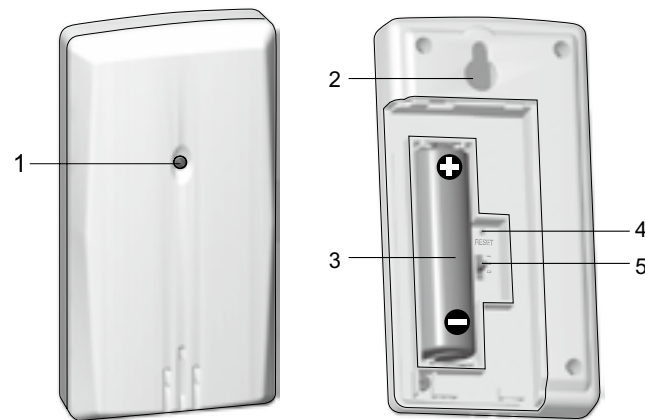

1. Indicador LED de status
2. Orifício para montagem em parede
3. Compartimento de pilhas
4. Orifício de **RESET**
5. Interruptor **CHANNEL**

PRIMEIROS PASSOS

INSERÇÃO DE PILHAS

1. Remova a tampa do compartimento de pilhas.
2. Insira as pilhas, fazendo a correspondência das polaridades. (consulte a FIG 2)
3. Pressione **RESET** após a troca da pilha.

 LOCAL	SIGNIFICADO
Área do relógio / alarme e temperatura interna	Pilhas da unidade principal fracas
Área de temperatura externa	Pilhas do sensor fracas

SENSOR REMOTO

A unidade principal pode coletar dados de até 3 sensores.

Para ajustar o sensor:

1. Abra o compartimento de pilhas (consulte a FIG 3).
2. Selecione um canal e pressione **RESET**.
3. Feche a tampa do compartimento de pilhas.
4. Posicione o sensor a uma distância de 30 m (98 pés) da unidade principal usando a base de mesa ou montagem em parede.

DICA A posição ideal do sensor seria qualquer local no exterior da casa, a uma altura não superior a 1,52 m (5 pés) e que possa ficar protegido da luz direta do sol ou das condições de umidade para uma leitura exata.

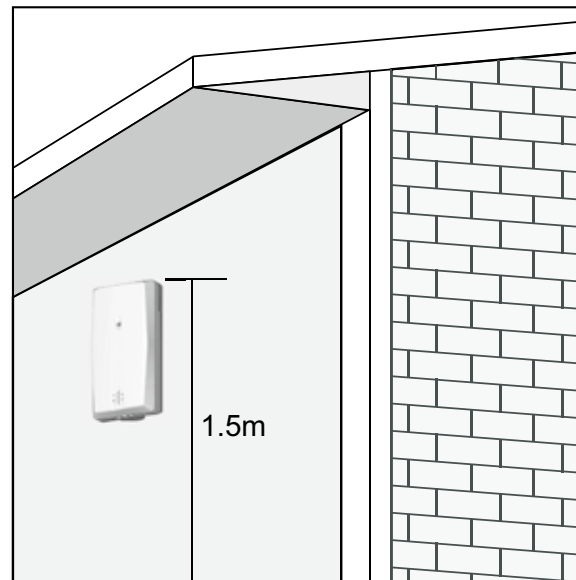

NOTA Use pilhas alcalinas para um maior tempo de uso e baterias de lítio consumíveis em temperaturas abaixo do nível de congelamento.

TRANSMISSÃO DE DADOS DO SENSOR

Para pesquisar um sensor:

Pressione e segure ▲ + MODE.

O ícone de recepção do sensor na área do sensor remoto mostra o status:

ÍCONE	DESCRIÇÃO
	A unidade principal está pesquisando o(s) sensor(es).
	Um canal foi localizado.
	O sensor não pôde ser localizado.

DICA A faixa de transmissão pode variar dependendo de muitos fatores. Você pode precisar testar em vários locais para obter os melhores resultados.

RELÓGIO

RECEPÇÃO DO RELÓGIO

Este produto foi projetado para sincronizar seu relógio automaticamente com um sinal do relógio.

Deslize **EU / UK** para selecionar o sinal recebido.

- EU: Sinal DCF-77: dentro de 1500 km (932 milhas) de Frankfurt, Alemanha.

- UK: Sinal MSF-60: dentro de 1500 km (932 milhas) de Anthorn, Inglaterra.

Para ativar/desativar a recepção do sinal:

Pressione e segure ▲ para ativar ou ▼ para desativar a recepção do sinal.

NOTA A recepção leva de 2 a 10 minutos. Se o sinal estiver fraco, poderá levar até 24 horas para obter um sinal válido. Se a recepção do sinal não for bem sucedida, coloque sua unidade ao lado de uma janela, pressione e segure ▲ para forçar outra busca de sinal.

Indicador de recepção do sinal do relógio:

SINAL FORTE	SINAL FRACO	NENHUM SINAL

AJUSTE MANUAL DO RELÓGIO

Para ajustar o relógio manualmente, desative primeiro a recepção do sinal.

1. Pressione e segure **MODE**.
2. Pressione ▲ ou ▼ para alterar os ajustes.
3. Pressione **MODE** para confirmar.
4. A ordem de ajuste é: fuso horário, formato de 12/24

horas, hora, minuto, ano, modo calendário (dia - mês / mês - dia), mês, dia e idioma.

O deslocamento do fuso horário faz um ajuste em + / - 23 horas com base na hora do sinal do relógio recebido.





NOTA As opções de idioma são Inglês (E), Alemão (D), Francês (F), Italiano (I) e Espanhol (S).

Para selecionar o modo de exibição:

Pressione **MODE** para escolher entre relógio com segundos / dias da semana / calendário.



PREVISÃO DO TEMPO

Este produto faz previsões do tempo para as próximas 12 a 24 horas em um raio de 30 a 50 km (19 a 31 milhas) com uma precisão de 75%.

	Ensolarado
	Parcialmente nublado
	Nublado
	Chuvoso
	Nevoso

MENSAGEM DE AVISO DE TEMPO

As mensagens de aviso de tempo oferecem indicações de prováveis circunstâncias que podem surgir com base nos cálculos da estação climática. Os significados destes avisos são ilustrados abaixo:

Aviso	Significado
	Risco de altas temperaturas
	Risco de altas velocidades de vento
	Risco de tempestade
	Risco de condições de neblina
	Risco de condições de geada

TEMPERATURA E UMIDADE

Para alternar a unidade de temperatura:

Pressione °C / °F.

Para iniciar a pesquisa automática entre sensores:

Pressione e segure ▼ + MEM para exibir os dados do sensor por 3 segundos.

Para finalizar, pressione ▲.

Para alternar entre os registros atual, mínimo e máximo do sensor selecionado:

Pressione **MEM** repetidamente.

Para limpar os registros:

Pressione e segure **MEM**.

AVISO DE GELO

Se a temperatura do sensor do canal 1 cair e ficar entre 3°C e -2 °C (37°F e 28°F), o indicador LED piscará e parará de piscar uma vez que a temperatura ficar fora de faixa.

TENDÊNCIAS DE TEMPERATURA

Os ícones de tendência de temperatura, umidade e pressão são baseados em recentes leituras do sensor.

ASCENSÃO	ESTÁVEL	QUEDA
		

FASE DA LUA

Em modo fase de lua, pressione ▲ ou ▼ para procurar os anos (2001 a 2099).

	Lua Nova		Lua Cheia
	Lua Crescente		Lua Cheia
	Quarto Crescente		Lua Minguante
	Lua Cheia		Lua Minguante

NOTA Os ícones de estrela ao redor da fase de lua serão exibidos a partir das 18:00 até às 6:00 da manhã seguinte.

LUZ DE FUNDO

Pressione **LIGHT** para ativar a luz de fundo por 5 segundos.

RESET

Pressione **RESET** para retornar aos ajustes padrão.

PRECAUÇÕES

- Não submeta a unidade a forças excessivas, impactos, poeiras, oscilações de temperatura ou umidade.
- Não obstrua as aberturas de ventilação com itens como jornais, cortinas, etc.
- Não mergulhe a unidade na água. Se respingar líquido nela, seque-a imediatamente com um pano macio e que não solte fiapos.
- Não limpe a unidade com material abrasivo ou corrosivo.
- Não altere os componentes internos da unidade. Isso invalidará sua garantia.
- Utilize apenas pilhas novas. Não misture pilhas novas e usadas.
- As imagens mostradas neste manual podem diferir da imagem real.
- Ao descartar este produto, certifique-se de que ele seja coletado separadamente para tratamento especial.
- A colocação deste produto sobre certos tipos de madeira pode resultar em danos ao seu acabamento, pelos quais a Oregon Scientific não se responsabilizará. Consulte as instruções de cuidados do fabricante do móvel para obter informações.
- O conteúdo deste manual não pode ser reproduzido sem a permissão do fabricante.

- Não descarte baterias usadas em locais não apropriados. É necessária a coleta do lixo em questão de maneira separada para tratamento especial.
- Observe que algumas unidades estão equipadas com uma tira de segurança da bateria. Remova a tira do compartimento de bateria antes do primeiro uso.

OBSERVAÇÃO As especificações técnicas deste produto e o conteúdo do manual do usuário estão sujeitos a alterações sem aviso prévio.

ESPECIFICAÇÕES

TIPO	DESCRIÇÃO
UNIDADE PRINCIPAL	
C x L x A	94 x 51 x 182,5 mm (3,70 x 2,01 x 7,19 pol)
Peso	241 g (8,5 onças) sem pilhas
Faixa de temperatura	-5°C a 50 °C (23 °F a 122 °F)
Resolução	0,1 °C (0,2 °F)
Frequência do sinal	433 MHz
Faixa de umidade	25% - 95%
Resolução de umidade	1%

Alimentação	3 pilhas UM-3 (AA) de 1,5V
UNIDADE REMOTA (THGN132N)	
C x L x A	50 x 22 x 96 mm (1,97 x 0,87 x 3,78 pol)
Peso	62 g (2,22 onças) sem pilhas
Faixa de transmissão	30 m (98 pés) sem obstrução
Faixa de temperatura	-20 °C a 60 °C (-4 °F a 140 °F)
Faixa de umidade	25% - 95%
Power	1 pilha UM-3 (AA) de 1,5V

SOBRE A OREGON SCIENTIFIC

Visite nosso site (www.oregonscientific.com.br) para saber mais sobre os produtos Oregon Scientific.



Caso você necessite de mais informações ou tenha dúvidas, entre em contato com o nosso Serviço de Atendimento ao Consumidor através do telefone (11) 5095-2329 ou e-mail sac@oregonscientific.com.br.

DECLARAÇÃO DE CONFORMIDADE DA UE

Oregon Scientific declara que este(a) [Modelo: BAR208HG] está conforme com os requisitos essenciais e outras provisões da Diretriz 1999/5/CE. Uma cópia assinada e datada da Declaração de Conformidade está disponível para requisições através do nosso SAC.



PAÍSES SUJEITOS À NORMA R&TTE

Todos os países da União Européia, Suíça 
e Noruega 

Avancerad väderstation med radiokontrollerad klocka Modell: BAR208HG

BRUKSANVISNING

INNEHÅLL

Produktöversikt	2
Vy Framsida	2
Vy Baksida	3
Fjärrsensor	3
Att Komma Igång	3
Sätt i batterier	3
Trådlös Sensor	4
Sensordataöverföring	4
Klocka	5
Klockmottagning.....	5
Manuell Inställning Av Klockan	5
Väderprognos	6
Viktig information om vädret	6
Temperatur och luftfuktighet	6
Frostvarning	7
Vädertrender	7

Månfas	7
Bakgrundsbelysning	7
Reset.....	7
Försiktighetsåtgärder.....	7
Specifikationer	8
OM Oregon Scientific	9
EU-försäkran om Överensstämmelse.....	9

PRODUKTÖVERSIKT

VY FRAMSIDA (FIG 1)

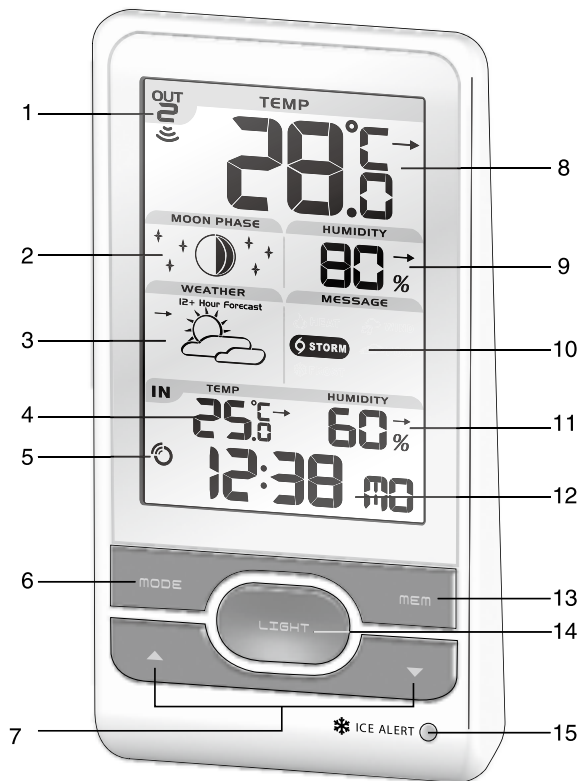

1. Mottagningsindikator för fjärrsensor
2. Visning av månfas
3. Väderprognos
4. Inomhustemperatur med temperaturtrend
5. Indikator för radiomottagningsignal
6. **MODE**: Ändra display / inställningar
7. ▲ / ▼: Öka / minska inställning; aktivera / avaktivera klockmottagning
8. Utomhustemperatur med temperaturtrend
9. Utomhus luftfuktighet med luftfuktighetstrend
10. Viktig information om vädret
11. Inomhus luftfuktighet med luftfuktighetstrend
12. Klocka med veckodag
13. **MEM**: Visa nuvarande, högsta och lägsta temperatur / luftfuktighet
14. **LIGHT**: Aktiverar bakgrundsbelysning i 5 sekunder
15. Frostindikator av LED-typ

VY BAKSIDA (FIG 2)

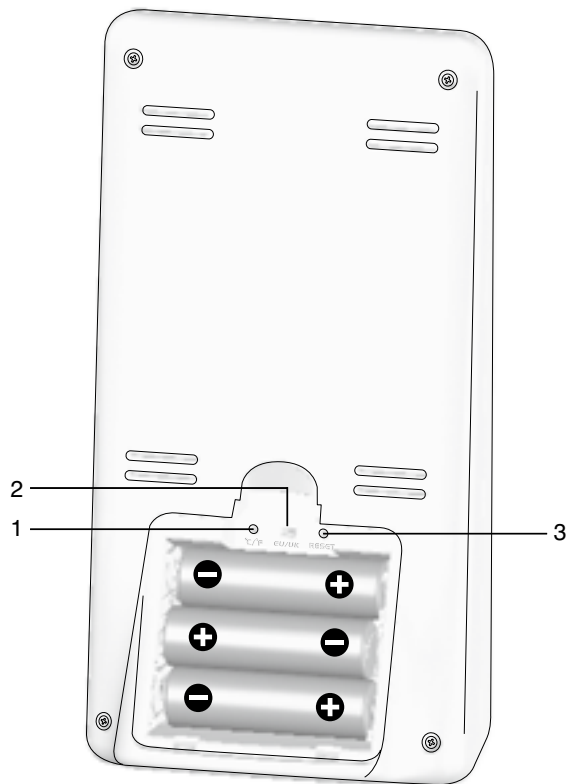

1. °C / °F: Välj temperaturenhet
2. EU / UK: Välj närmsta radiosignal
3. **RESET**: Återställ enheten till fabriksinställning

FJÄRRSENSOR (FIG 3)

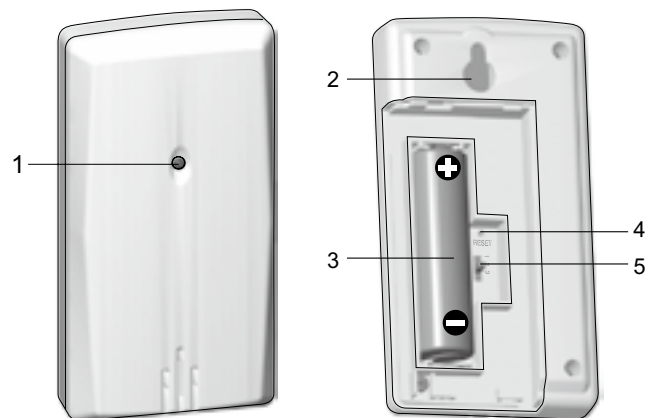

1. LED indikator
2. Väggh monteringshål
3. Batterifack
4. **RESET** knapp
5. Kanalomkopplare

ATT KOMMA IGÅNG

SÄTT I BATTERIER

1. Öppna batteriluckan.
2. Se till att batterierna sätts in med rätt polaritet (se FIG 2).
3. Tryck **RESET** efter varje batteribyte.

 PLATS	FÖRKLARING
Klocka / alarm och Inomhustemperatur område	Låg batterinivå i huvudenheten
Utomhustemperatur område	Låg batterinivå i sensorn

TRÅDLÖS SENSOR

Huvudenheten kan samla in data från upp till 3 sensorer.

Att ställa in sensorn:

1. Öppna batterifacket (se figur. 3).
2. Välj en kanal och tryck sedan **RESET**.
3. Stäng batteriluckan.
4. Placera sensorn på önskat ställe inom 30m från huvudenheten genom att använda väggmontering eller bordsstativ.

TIPS Bästa placering av sensorn är på en höjd ej högre än 1,5m och skyddad från direkt solsken och regn. Detta för att få noggrannast resultat.

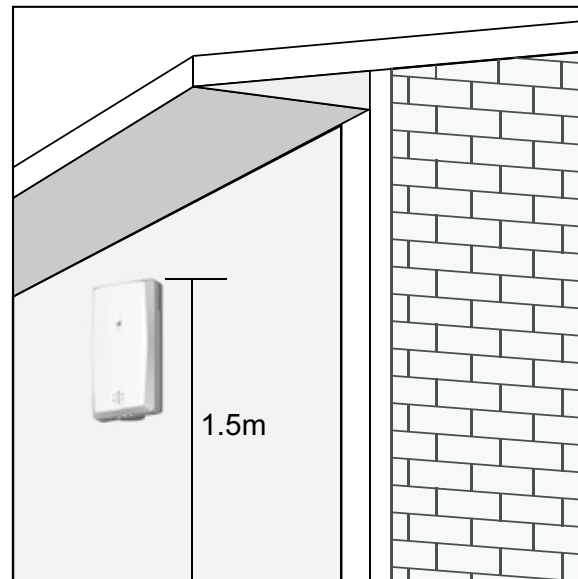



NOTERA Använd alkaliska batterier för längre livslängd och litiumbatterier vid temperaturer under fryspunkten.

SENSORDATAÖVERFÖRING

För att leta efter en sensor:

Tryck och håll inne **▲ + MODE**.

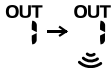
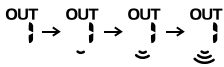
Mottagningsikonen som visas i sensorområdet visar statusen:

IKON	BESKRIVNING
	Huvudenheten söker efter fjärrenhet(er).
	En kanal har hittats.
	Fjärrenheten kan inte hittas.

TIPS Sändningsräckvidden kan variera beroende på många faktorer. Du kan behöva experimentera med olika platser för att erhålla det bästa resultatet.

KLOCKA

KLOCKMOTTAGNING

Denna produkt är gjord för att automatiskt synkronisera klockan när den tar emot en klocksignal.

Ställ **EU / UK** för att välja önskad signal.



- EU: DCF-77 signal: inom 1500 km från Frankfurt, Tyskland.
- UK: MSF-60 signal: inom 1500 km från Anthorn, England.

Att aktivera / avaktivera radiosignalmottagning:

Tryck och håll inne ▲ för att aktivera eller ▼ för att avaktivera signalmottagning.

NOTERA Mottagning tar 2-10 minuter. Om signalen är svag, kan det ta upp till 24 timmar innan en radiosignal kan mottagas. Om signalmottagningen är otillräcklig, placera enheten i närheten av ett fönster, tryck och håll inne ▲ för att framtvinga ytterligare en signalsökning.

Indikator för radiomottagningssignal:

STARK SIGNAL	SVAG SIGNAL	INGEN SIGNAL
		

MANUELL INSTÄLLNING AV KLOCKAN

Avaktivera radiomottagningen innan manuell inställning.

1. Tryck och håll inne **MODE**.
2. Tryck ▲ eller ▼ för att ändra inställningarna.
3. Tryck **MODE** för att bekräfta.
4. Ordningen för inställningarna är: tidszon, 12/24 tim format, timme, minut, år, datum mode (dag – månad / månad - dag) månad, dag och språk.

Tidszonsinställningen kan användas för att ställa klockan upp till + / -23 timmar från den mottagna klocktiden.

NOTERA Tillgängliga språk är Engelska (E), Tyska (D), Franska (F), Italienska (I), och Spanska (S).

Att välja visningsläge:

Tryck **MODE** för att välja mellan klocka med sekunder / veckodag / datum / månfas.





VÄDERPROGNOS

Denna produkt förutspår vädret för de kommande 12 till 24 timmarna inom en 30—50 km (19 —31 miles) radie med 75% noggrannhet.

	Soligt
	Halvklart
	Moln
	Regn
	Snö

VIKTIG INFORMATION OM VÄDRET

Vädermeddelandena påtar indikationer på att speciella förhållanden råder, baserade på väderstationens kalkyler. Betydelse av meddelandena visas nedan:

VARNING	BETYDELSE
	Risk för höga temperaturer
	Risk för höga vindhastigheter
	Risk för storm
	Risk för dimma
	Risk för frost

TEMPERATUR OCH LUFTFUKTIGHET

För att växla temperaturenhet:

Tryck °C / °F.

För att automatiskt växla mellan sensorer:

Tryck och håll inne ▼ för att visa varje sensors data i 3s.

För att avsluta tryck ▲.

För att växla mellan aktuellt, minimum och maximum värde för aktuell sensor:

Tryck **MEM** upprepade gånger.

För att radera minnet:



Tryck och håll inne **MEM**.

FROSTVARNING

Om sensorn för kanal 1 mäter mellan 3°C och -2°C, blinkar LED indikatorn och slutar att blinka när temperaturen är utanför detta område.









VÄDERTRENDER

Temperaturen, luftfuktigheten och lufttryckstrendikonerna baseras på aktuella sensormätningar.

STIGER	STABIL	SJUNKER
		

MÅNFAS

I månfasläget, tryck ▲ eller ▼ för att stega genom åren (2001 till 2099).

	Nymåne		Fullmåne
	Växande måne		Avtag. fullmåne
	Halvmåne		Sista månkvartern
	Växande halvmåne		Avtagande halvmåne

NOTERA Stjärnikoner runt månfasen kommer att visas från kl.18.00 till 06.00.

BAKGRUNDSBELYSNING

Tryck **LIGHT** för att tända bakgrundsbelysningen i 5 sekunder.

RESET

Tryck **RESET** för att återgå till grundinställningarna.

FÖRSIKTIGHETSÅTGÄRDER

- Utsätt inte produkten för extrema krafter, stötar, damm eller kraftiga variationer i temperatur eller luftfuktighet.
- Täck inte ventilationshål med föremål såsom tidningar, gardiner o.d.
- Lägg aldrig ner produkten i vatten. Om du spiller vätska på produkten skall den omedelbart torkas torr med en luddfri trasa.
- Rengör inte produkten med rengöringsmedel som innehåller repande eller korroderande material. ämnen.
- Mixtra inte med interna komponenter. Detta förverkar garantin.
- Använd endast nya batterier. Blanda inte gamla och nya batterier.

- Bilder i manualen kan skilja sig från verkligheten.
- Denna produkt skall vid kassering sorteras som elektronikskrot.
- Placering av denna produkt på speciella träslag kan resultera i skador på finishen för vilka Oregon Scientific ej ansvarar. Konsultera möbeltillverkaren för information.
- Innehållet i denna manual får ej kopieras utan medgivande från tillverkaren.
- Släng inte förbrukade batterier som vanligt restavfall. De bör slängas i avsedd behållare på en återvinningsstation.
- Notera att vissa enheter är försedda med en remsa som förhindrar batteriurladdning. Ta bort plastremsan i batteriluckan innan första användning.

NOTERA De tekniska specifikationerna för denna produkt samt innehållet i denna manual kan komma att ändras utan vidare upplysning.

SPECIFIKATIONER

TYP	BESKRIVNING
HUVUDENHET	
L x B x H	94 x 51 x 182.5 mm (3.70 x 2.01 x 7.19 tum)
Vikt	241 g utan batteri
Temperaturområde	-5°C till 50°C (23°F till 122°F)
Upplösning	0.1°C (0.2°F)
Sändningsfrekvens	433 MHz
Luftfuktighetsområde	25% - 95%
Upplösning luftfuktigh	1%
Drift	3 x UM-3 (AA) 1.5 V batterier

TRÅDLÖS SENSOR (THGN132N)

L x B x H	50 x 22 x 96 mm (1.97 x 0.87 x 3.78 tum)
Vikt	62 g utan batteri
Överföringsavstånd	30 m fri sikt
Temperaturområde	-20°C till 60°C (-4°F till 140°F)
Luftfuktighetsområde	25% - 95%
Drift	1 x UM-3 (AA) 1.5 V batteri

OM OREGON SCIENTIFIC

Besök vår hemsida (www.oregonscientific.se) för att se mer av våra produkter såsom digitalkameror; MP3 spelare; projektionsklockor; hälsoprodukter; väderstationer; DECT-telefoner och konferenstelefoner. Hemsidan innehåller också information för våra kunder i de fall ni behöver ta kontakt med oss eller behöver ladda ner information.

Vi hoppas du hittar all information du behöver på vår hemsida och om du vill komma i kontakt med Oregon Scientific kundkontakt besöker du vår lokala hemsida www.oregonscientific.se eller www.oregonscientific.com för att finna telefonnummer till respektive supportavdelning.

EU-FÖRSÄKRAN OM ÖVERENSSTÄMMELSE

Härmed intygar Oregon Scientific att denna Avancerad väderstation med radiokontrollerad klocka (Modell: BAR208HG) står i överensstämmelse med de väsentliga egenskapskrav och övriga relevanta bestämmelser som framgår av direktiv 1999/5/EG. En signerad kopia av "DECLARATION OF CONFORMITY" kan erhållas vid hänvändelse till OREGON SCIENTIFIC servicecenter.



LÄNDER SOM OMFATTAS RTTE-DIREKTIVET

Alla länder inom EU, Schweiz (CH)
och Norge (N)

© 2007 Oregon Scientific. All rights reserved.

086L005036-017

Free Manuals Download Website

<http://myh66.com>

<http://usermanuals.us>

<http://www.somanuals.com>

<http://www.4manuals.cc>

<http://www.manual-lib.com>

<http://www.404manual.com>

<http://www.luxmanual.com>

<http://aubethermostatmanual.com>

Golf course search by state

<http://golfingnear.com>

Email search by domain

<http://emailbydomain.com>

Auto manuals search

<http://auto.somanuals.com>

TV manuals search

<http://tv.somanuals.com>