

Oregon Scientific™ High Precision Body Weight Monitor with Body Fat Index

Model: GA101

User Manual

TABLE OF CONTENTS

- Introduction** 2
- Warnings** 2
- Key Features** 4
- How the Body Weight Monitor Works** 4
 - Brief Description 4
 - Body Mass Index 5
 - What is Body Mass Index (BMI)? 5
 - How to Interpret BMI 5
 - Body Fat Index 6
 - What is Body Fat Index? 6
 - How Body Fat is Measured 6
 - How to Interpret Body Fat Index 6
 - How to Interpret Body Fat Level Indicator 7
 - How Body Fat Percentage Fluctuates 7
- Safety and Care Instructions** 8
- Getting Started** 9
 - Unpacking the Body Weight Monitor 9
 - Selecting a Location for the Body Weight Monitor 9
 - Setting up for the First Time 9
 - Setting the Height and Age for a User 10
- Taking Measurements** 11
 - Taking Measurements with Stored User Settings 11
 - Taking Measurements as a Guest User 12
 - Taking Weight-Only Measurements 12
- Resetting** 13
- Replacing the Batteries** 13
- Addendum** 13
 - Weight Unit Conversion 13
- Troubleshooting Guide** 14
- Specifications** 15
- Additional Resources** 15

INTRODUCTION

Thank you for selecting the Oregon Scientific™ Body Weight Monitor as your healthcare product of choice. Your Body Weight Monitor is designed to give you many years of reliable service. Some of its features include:

- Automatic calculation of body mass index (BMI) and body fat index.
- User selectable weight measurement in kilograms, pounds, or stone pounds.
- Patented step-on technology that automatically turns on the Monitor whenever you step onto it.
- Storage of height and age information for four different users (guest mode available).

This manual contains important safety and care information, and provides step-by-step instructions for using this product. Read the manual thoroughly, and keep it in a safe place in case you need to later refer to it.

WARNINGS

This product has been engineered and manufactured to the highest safety standards. The product is designed to provide you with many years of reliable service, provided that it is properly used and cared for. To ensure your safety and prolong the life of the product, please observe the following precautions.

ABOUT THE DEVICE

 **WARNING:** It is not recommended for persons with implanted medical equipment such as pacemakers or pregnant women to use the Monitor.

- The Monitor is intended for home use only, not for hospital diagnosis purposes.
- The BMI and Body Fat Index measurements done with the Monitor should only be treated as an approximate indication of your health level. Consult with your physician for a full and thorough evaluation.
- Body Fat Index and Body Mass Index measurements are less accurate for professional athletes, bodybuilders, children, teenagers, and persons over the age of 65 due to the difference in their body compositions. However, this device can still help individuals in the groups above to track their body fat trends over time.

GENERAL WARNINGS

- Read and observe all warnings and instructions – This user manual contains important warnings and instructions that, if properly followed, will help to ensure you use the product safely. Use the manual as you set up and begin to use the Body Weight Monitor, then keep it in a safe place for future reference. Note that the contents of this user manual are subject to change without further notice. Figures and display examples are for reference only, and may slightly differ from the actual product.
- Batteries – Reversing the battery polarity may damage the product. Different types of batteries have different characteristics and should not be mixed. Do not pair old and new batteries together – this can shorten the life of new batteries and cause old batteries to leak harmful chemicals that can corrode the battery compartment and cause a rash on your skin. If the batteries leak, wipe the battery compartment with a clean cloth and wash your hands

with warm soapy water after handling. Remove the batteries if the Body Weight Monitor will be in storage for an extended period of time.

- Liquids, moisture, and foreign objects – Never insert foreign objects in or spill liquids on the product, as this can cause electric shock and damage to the unit. Do not immerse this product in water.

OTHER NOTICES

Disposing of this Product

When disposing of this product, do so in accordance with your local waste disposal regulations.

Statement of Responsibility

Oregon Scientific assumes no responsibility for any incidental losses (such as the costs of recording or the loss of income from recording) incurred as a result of faults with this product.

Oregon Scientific will not be held liable for any bodily injury, death, property damages or any other claims of whatever nature resulting from the misuse or negligence of this product, whether intentional or unintentional. Furthermore, Oregon Scientific will not be responsible for any deviations in the usage of the device from those specified in the user instructions or any unapproved alterations or repairs of the product.

KEY FEATURES

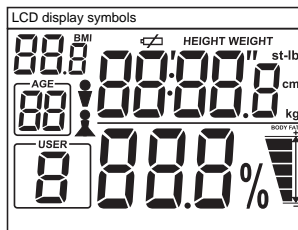
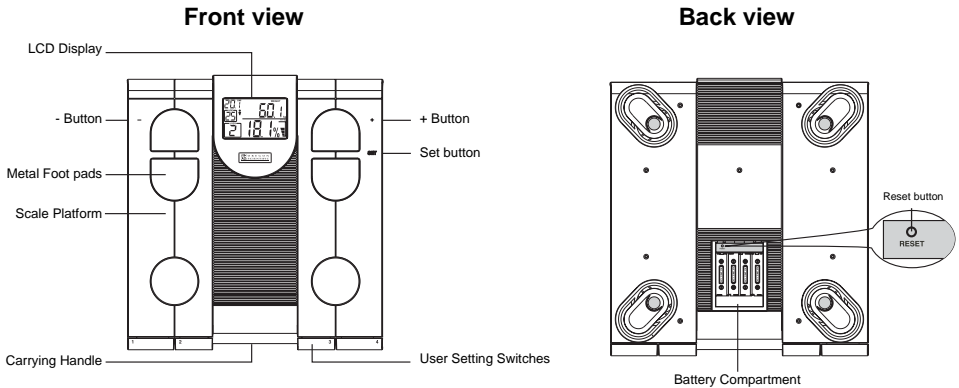

HOW THE BODY WEIGHT MONITOR WORKS

BRIEF DESCRIPTION

When you step on the Monitor, a weight measurement is taken. The Monitor can also help you to automatically calculate your Body mass index (BMI) and Body Fat Index, two internationally accepted indicators of health and obesity levels.

Weight alone is not a good enough indicator of health because it does not differentiate between muscles, tissues, bones, and fat. As such, when a person loses weight, it may be a result of the loss of muscles or body water but not fat. In order to better understand your body composition and current health level, both the BMI and Body Fat Index should be observed.

Neither the BMI nor the Body Fat Index, taken individually, gives the complete picture of your health. For example, bodybuilders often have high BMI (considered obese) but low Body Fat Index (considered healthy). The BMI, in this case, does not take into account that the extra weight is from muscles and water but not fat. Conversely, a very thin person may have low Body Fat Index (considered healthy) but also lower-than-accepted BMI (considered unhealthy). This means that the person is still at risk health-wise, despite the low Body Fat Index.

NOTE Consult your physician before you begin a new diet or exercise program.

BODY MASS INDEX

What is Body Mass Index (BMI)?

Body mass index (BMI) is a widely used international standard that measures weight to height ratio to determine obesity. BMI is expressed by the following terms:

$$\text{BMI} = \frac{\text{Body weight (kg)}}{[\text{Body height (m)}]^2}$$





The BMI is only a general indicator of your health level. As such, accuracies may vary depending on your body type and composition. Consult your physician to find out more about your current health.

NOTE To convert pounds or stone pounds to kilograms, and inches to meters, refer to the conversion reference on page 13.

How to Interpret BMI

Use the resulting BMI value with the chart below to determine your current level of health:

NOTE Asians have a separate BMI range due to their different body composition.

Health Indication	BMI Range	Description
 Underweight	Less than 20.0*	Your body weight is currently lower than average. Work toward healthy, regular food intake and exercise routine to build up your health to recommended levels.
	* Asian BMI: Less than 18.5	
 Recommended	20.0 – 25.0*	Your health is at the recommended level. Maintain a balanced diet and exercise to keep your current level of health.
	* Asian BMI: 18.5 – 23.0	
 Overweight	25.1 – 29.9*	Your body weight may be above normal. Increase your exercise and work out a diet plan to lower your risk for serious illness.
	* Asian BMI: 23.0 – 29.9	
 Obese	30.0 or greater*	At this level, you may be at risk for heart disease, high blood pressure, and other illnesses. Consult with your doctor to develop a proper health and fitness plan.
	* Asian BMI: 30.0 or greater	

NOTE BMI should not be used as a guideline for health risks for the following groups:

Group	Reason
Children and teenagers	BMI ranges are only based on adult heights.
Athletes and bodybuilders	BMI does not differentiate between fat and muscle, thus making it inaccurate for persons with high muscle volumes.
Pregnant or nursing women	This group generates naturally high fat reserves as part of the pregnancy.
People over the age of 65	Fat reserves naturally tend to be higher with older persons.

References:

1. Jequier, E. (1987) Energy, obesity, and body weight standards.
2. American Journal of Clinical Nutrition, 45, 1035-1047
3. Japan Society for the Study of Obesity
4. The Weight Loss Research Center
5. myDr. (www.mydr.com.au)

BODY FAT INDEX

What is Body Fat Index?

Body Fat Index is a measurement of the total percentage of fat in your body. For example, if you weigh 70 kg and your Body Fat Index is 15%, then you are retaining 10.5 kg of fat. The remaining weight is composed of muscles, bones, tissues, and body water.

Among overweight people, it is excess fat and not weight alone that carries health risks. Since the body comprises elements of varying densities, weight or BMI cannot fully measure exactly how much excess fat a person carries. For example, two people of the same weight and BMI may have big differences in body composition. One may carry excess fat while the other carry acceptable level of fat needed to regulate the body. As such, a Body Fat Index measurement is an effective assessment of your current health level.

NOTE Essential fat is necessary for bodily functions, since it helps to maintain body temperature and insulate organs and tissues.

How Body Fat is Measured

The Monitor uses the method of Bioelectrical Impedance Analysis (BIA) to measure body fat. This method gives high precision, is completely safe, and is widely used in the medical field. The principle of BIA is as follows: The Monitor sends a low, harmless electrical signal through your body that flows freely. As such, the machine uses this to calculate the body fat Index (along with the person's age, gender, height, weight, and build).

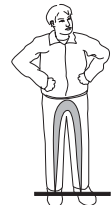

BIA Foot-to-Foot Measuring Diagram

How to Interpret Body Fat Index

Use the resulting Body Fat Index value with the chart below to determine your current level of health:

Gender	Body Fat Standard	Age Group in Years			
		Under 30	30-39	40-49	Over 49
Adult Men	High	>28%	>29%	>30%	>31%
	Moderately High	22-28%	23-29%	24-30%	25-31%
	Optimal Range	11-21%	12-22%	13-23%	14-24%
	Low	6-10%	7-11%	8-12%	9-13%
	Very Low	<6%	<7%	<8%	<9%
Adult Women	High	>32%	>33%	>34%	>35%
	Moderately High	26-32%	27-33%	28-34%	29-35%
	Optimal Range	15-25%	16-26%	17-27%	18-28%
	Low	12-14%	13-15%	14-16%	15-17%
	Very Low	<12%	<13%	<14%	<15%

How to Interpret Body Fat Level Indicator

In addition to displaying your Body Fat Index, the Monitor provides a Body Fat Level Indicator on the LCD screen to help you immediately gauge your level of health without referring to the chart above.

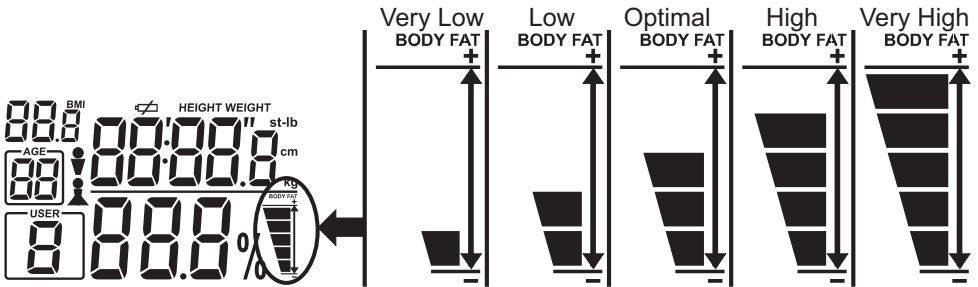

Body Fat Standard	Reason
Very High	Body Fat Index at this level indicates the person is seriously obese to a degree that this can have adverse health consequences. Maintaining this level of fat for a long period of time places the person at risk of hypertension, heart disease, and diabetes. Consult your doctor on a long-term weight loss and exercise program.
High	It is likely that the person is obese. Careful implementation and monitoring of diet and exercise is recommended.
Optimal	This is the ideal level of body fat for the average person.
Low	For athletes, this is a desirable level of body fat. For regular persons, a regular diet should be considered to improve the balance of body composition.
Very Low	The level of body fat is dangerously low. Persons in this level should seek to implement a regular diet. Maintaining this level of body composition can place a person at risk of malnutrition and other health risks.

Reference:

1. **Robert M. Ross, Andrew S. Jackson: Exercise concepts, calculations, and computer applications.**

Carmel, Ind.: Benchmark Press, 1990.





How Body Fat Index Fluctuates

It is recommended that you choose a time slot to measure body fat and then monitor it regularly at the same condition. Ideally, body hydration level is most stable during late afternoon, right before dinner. Please note the many factors may alter an individual's body fat reading, including alcohol consumption, taking a bath or exercising, waking up, eating, fever and illnesses.

SAFETY AND CARE INSTRUCTIONS



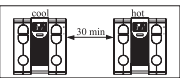

CARING FOR YOUR BODY WEIGHT MONITOR

To ensure you receive the maximum benefit from using this product, please observe the following guidelines.

	Clean with a damp cloth. Do not use abrasive or corrosive cleaning agents.
	Do not attempt to repair the product yourself. This will terminate the warranty and may expose you to dangerously high voltages. Contact the dealer or a qualified repairman if the product requires servicing. Do not store the Monitor in an upright position.
	Do not store the Monitor in an upright position.
	Do not place objects on the Monitor or stand it in an upright position.
	Do not expose the product to excessive force, dust, temperature fluctuations, or humidity.
	Allow the Monitor to settle for at least 30 minutes whenever there is a sudden change in ambient environment (e.g., from an outdoor area to an air conditioned room).

SAFETY PRECAUTIONS





Please observe the following safety precautions when setting up and using your Body Weight Monitor.

	Do not immerse the product in water or place the Monitor on a wet surface.
	Keep the product away from heat sources such as radiators, stoves, and heaters.
	Do not use the Monitor on an uneven surface.
	Use carpet feet (supplied) if you place the Monitor on a carpet.

GETTING STARTED

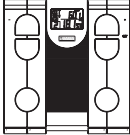
UNPACKING THE BODY WEIGHT MONITOR

When you unpack your Body Weight Monitor, make sure to keep all the packing materials in a safe place, in case you need to later transport or return it for servicing. In the box, you will find:

The Monitor	4x AA 1.5-V Batteries	User Manual	4x Carpet Feet
			

Selecting a Location for the Body Weight Monitor

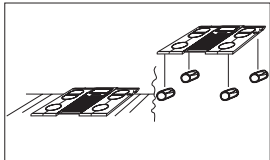
Diagram	Instructions
	Place the body weight Monitor on a hard, even floor surface. Avoid thick carpeting or use the supplied carpet feet.

NOTE Placing the Monitor on the floor will display **CAL** on the LCD. This indicates that it is calibrating. Simply leave the Monitor on the floor for 1-2 seconds to allow self-calibration.

Setting up the First Time

To set up your Body Weight Monitor:

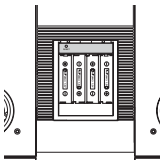
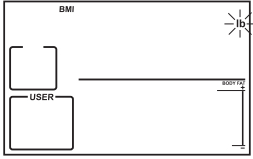
Diagram	Instructions
	1. Remove and discard the clear plastic tab inside the battery compartment.
	2. Set the measurement unit: <ol style="list-style-type: none"> 2.1. Press and hold set until "lb" flashes. 2.2. Press + or - to set unit in lb (pounds), st-lb (stones), or kg (kilograms). 2.3. Press set to confirm the change. <p>NOTE If "lb" or "st-lb" is selected, the unit for your height is defaulted to feet and inches. If "kg" is selected, the unit for height is set to centimeters.</p>

Setting the Height and Age for a User

With this product, you can set and store the age and height for up to four people (users 1 to 4) who regularly use the Body Weight Monitor.

Once you set the height and age for a user, the GA101 can automatically calculate the body mass index (BMI) and Body Fat Index whenever the person uses the Monitor.

NOTE If the batteries are low, you cannot store the height and age to memory.

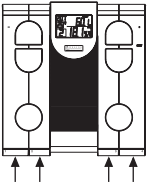
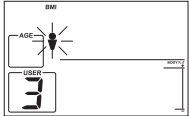
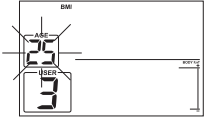
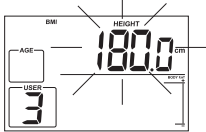
Diagram	Instructions
	<p>1. Each user is represented by the four user setting switches at the edge of the Monitor. Press 1, 2, 3, or 4 to select one of the users.</p> <p>NOTE Make sure not to store your height and age over someone else's existing profile.</p>
	<p>2. Select your gender:</p> <p>2.1 Press and hold ENT until the Male icon flashes.</p> <p>2.2 Press + or - to toggle between genders.</p> <p>2.3 Press ENT to confirm the change.</p>
	<p>3. Enter your current age:</p> <p>3.1 Press + or - to adjust the value.</p> <p>3.2 Press ENT to confirm.</p>
	<p>4. Enter your height</p> <p>4.1 Press + or - to adjust the value.</p> <p>4.2 Press ENT to confirm.</p> <p>NOTE To enter your height in feet and inches, switch the Monitor to "lb" or "st-lb". (Page 9)</p>

TAKING MEASUREMENTS

If you have entered a user setting, you can make use of the saved settings to automatically find out your weight, BMI, and Body Fat Index. For users who do not have settings stored, you can choose to take measurements as a “Guest User”.

NOTE It is necessary that you step onto the Monitor with your bare feet. The electric signal sent from the Monitor cannot give readings if socks or shoes are worn.

TAKING BODY FAT MEASUREMENTS WITH STORED USER SETTINGS

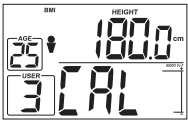
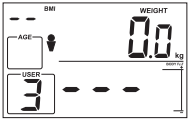
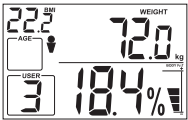
Diagram	Instruction
	<p>1. Press user setting switch 1, 2, 3, or 4 to select the user corresponding to your settings. The LCD will show your height, gender and age.</p>
	<p>2. Wait until your settings disappear and the weight “0.0” is displayed.</p>
	<p>3. Step on the Monitor. Stand still while the measurement is being taken. The Monitor will beep when the measurement is complete. The weight, BMI, and Body Fat Index will display.</p> <p>NOTE If “Err 1” is shown, the Monitor is unstable while measuring your weight. Make sure to remain still and place the Monitor on a flat surface. Use the carpet feet if the ground is uneven. Step off the Monitor and follow the instructions from the beginning.</p> <p>NOTE If “Err 2” is shown, you have stepped on the Monitor too early. Step off the Monitor and follow the instructions from the beginning.</p> <p>NOTE If “oL” is shown, the maximum loading capacity for the Monitor has been exceeded. Step off the Monitor and try again with less than 150kg of weight.</p> <p>NOTE If you wait for too long before stepping on the Monitor, the LCD display will go blank. Step off the Monitor and follow the instructions again from the beginning.</p>

TAKING MEASUREMENTS AS A GUEST USER

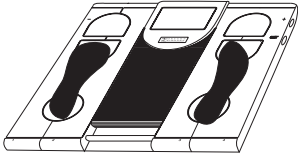
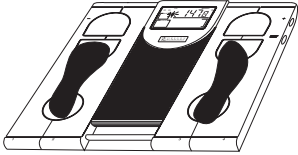
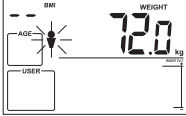
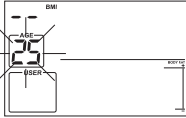
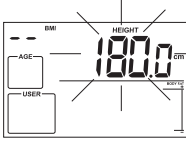
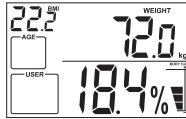
Diagram	Instruction
	<p>1. For users without stored settings, simply step on the Monitor while the LCD screen is blank.</p> <p>NOTE If “Err 1” is shown, the Monitor is unstable while measuring your weight. Make sure to remain still and place the Monitor on a flat surface. Use the carpet feet if the ground is uneven. Step off the Monitor and follow the instructions from the beginning.</p> <p>NOTE If “Err 2” is shown, you have stepped on the Monitor too early. Step off the Monitor and follow the instructions from the beginning.</p>
	<p>2. Stand still while the measurement is being taken. The Monitor will beep and the Male icon will flash.</p> <p>NOTE If “ol” is shown, the maximum loading capacity for the Monitor has been exceeded. Step off the Monitor and try again with less than 150kg of weight.</p>
	<p>3. Step off the Monitor and select your gender:</p> <p>3.1 Press + or - to toggle between genders.</p> <p>3.2 Press SET to confirm.</p>
	<p>4. Enter your current age:</p> <p>4.1 Press + or - to adjust the value.</p> <p>4.2 Press SET to confirm.</p>
	<p>5. Enter your height :</p> <p>5.1 Press + or - to adjust the value.</p> <p>5.2 Press SET to confirm.</p> <p>NOTE To enter your height in feet and inches, switch the Monitor to “lb” or “st-lb”.</p>
	<p>6. Your weight, BMI, and Body Fat Index are then displayed.</p>

TAKING WEIGHT-ONLY MEASUREMENTS

The Body Weight Monitor is equipped with a patented STEP-ON mechanism to help you take Body Weight measurement without switching on the Monitor. You do not need to wait for measurements like the majority of scales in the market.



To measure your body weight only, just step on the Monitor then step off after your body weight is shown. Alternatively, you can tap on your User Setting Switch, then step on the Monitor after “0.0” is shown on the display. Remain on the Monitor until your body weight is shown. After a moment, your BMI will also be calculated.

RESETTING

The reset button is located in the battery compartment on the back of the Monitor. Use a blunt stylus such as a paper clip to press the button.

REPLACING THE BATTERIES

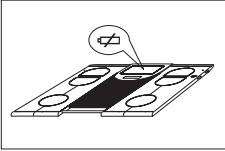
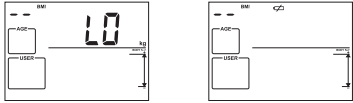
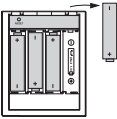
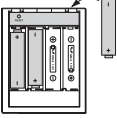
This product requires four (4) 1.5-volt AA batteries to operate (supplied).

Diagram	Instructions
	<p>1. Replace the batteries whenever the display shows one of these signs:</p> 
	<p>2. Remove the old batteries and set aside.</p>
	<p>3. Insert the new batteries. Be sure to match the polarity as shown in the diagram.</p>
	<p>4. Replace the battery compartment lid and close.</p> <p>NOTE The display shows "CAL" once you place the Monitor on a horizontal surface. Just leave the Monitor on the floor for 1-2 seconds to allow self-calibration.</p>

NOTE Batteries can be harmful to the environment. Contact your local waste disposal authority for proper disposal instructions.

ADDENDUM

Weight Unit Conversion

Unit	Description	Geographic application	Conversion
kg	Metric kilogram	Global	1 kg = 2.20 lb 1 kg = 0.16 stone
lb	Imperial pound	United States	1 lb = 0.45 kg 1 lb = 0.07 stone
st-lb	British stone pound	United Kingdom	1 stone = 14.0 lb 1 stone = 6.36 kg

TROUBLESHOOTING GUIDE

This section includes a list of frequently asked questions for problems you may encounter with your Body Weight Monitor. If the product is not operating as you think it should, check here before arranging for servicing.

Problem	Symptom	Check this	Remedy
No power	The display is dim.	The batteries are low.	Replace with new batteries (p.13).
	The display is blank.	Batteries are exhausted.	Replace with new batteries (p.13).
Batteries are inserted incorrectly.		Insert the batteries correctly (p.13).	
Error message	Display shows \varnothing .	Batteries are low.	Replace the batteries.
	Err 1 shown on the display.	The weight on the Monitor is unevenly distributed or unstable.	Make sure to remain still and place the Monitor on a flat surface. Use the carpet feet if the ground is carpeted or uneven.
	Err 2 shown on the display.	You have stepped on the Monitor too early.	For user with saved settings, wait until the display shows the weight as "0.0" before stepping on.
Weight, BMI, and Body Fat Index Display problem	Monitor shows "oL" when weighing.	The Monitor is overloaded.	The maximum weighing capacity is 150kg (330 lb / 23st - 8lb). Remove the weight from the Monitor.
	The measurement is inaccurate.	The Monitor is uneven or on the carpet.	Use the supplied carpet feet or place the Monitor on a flat, even hard surface.
		Socks or shoes are worn.	Remove your socks, shoes, and other heavy accessories before using the Monitor.
		The entered gender, age, or height is wrong.	Re-enter your user settings with the correct values.
	Measurements vary drastically after a short period.	Fluctuations in body fat during the day are normal. Refer to p.7 for information regarding this.	
	Weight does not display	The Monitor needs to be reset.	Reset the Monitor (p.13).

SPECIFICATIONS

Dimensions:

Width x Depth x Height 315(w) x 340(d) x 50(h) mm
 Weight 1.8kg (excluding batteries)

Weight measurement:

Weighing mechanism 4 load cell Strain-gauge System
 Weight units kilogram (kg) / pounds (lb) / stone pounds (st-lb)
 Maximum Weighing Capacity 150kg / 330 lb / 23st-8lb
 Graduation 0.1 kg / 0.2 lb

BMI:

BMI measurement range up to 50 kg/m²

Body Fat measurement:

Measurement mechanism 6 conductive pads BIA technology
 Body fat measurement range 5 – 75%
 Body fat Index display resolution 0.1%
 Gender Male / Female
 Age 7 to 99 years old

Height input:

Height units centimeters (cm) / feet (') and inches (")
 Min / Max height 80 – 230.0 cm / 2' 7.5" – 7' 6.6"
 Height resolution 0.1cm or 0.1"

Power:

Power supply 4xLR6 / AA / UM-3 1.5v batteries
 Power save auto-off after 5 – 10 seconds

Operating environment:

Operation temperature 5° C ... 45° C (41° F...113° F)
 at ≤85% relative humidity
 Storage temperature -5° C60° C (23° F ... 140° F)
 at ≤85% relative humidity

ADDITIONAL RESOURCES

Visit our website (www.oregonscientific.com) to learn more about your Body Weight Monitor and other Oregon Scientific™ products such as digital cameras, telephones, hand-held organizers, alarm clocks, and weather stations. The website also includes contact information for our customer service department, in case you need to reach us.



Help us protect the environment. Recycle the packaging, batteries, and product after you no longer need them.

© 2003 Oregon Scientific. All rights reserved.

Free Manuals Download Website

<http://myh66.com>

<http://usermanuals.us>

<http://www.somanuals.com>

<http://www.4manuals.cc>

<http://www.manual-lib.com>

<http://www.404manual.com>

<http://www.luxmanual.com>

<http://aubethermostatmanual.com>

Golf course search by state

<http://golfingnear.com>

Email search by domain

<http://emailbydomain.com>

Auto manuals search

<http://auto.somanuals.com>

TV manuals search

<http://tv.somanuals.com>