



# Metal Weather Station

## Model: BAR908HG / BAR908HGU / BAR908HGA

### User Manual

#### CONTENTS

<b>Product Overview</b> .....	<b>3</b>
Front View .....	3
Back View .....	4
LCD Display .....	5
Remote Sensor .....	7
<b>Getting Started</b> .....	<b>9</b>
Batteries .....	9
AC Adaptor (Main Unit) .....	9
Change Settings .....	9
<b>Remote Sensor</b> .....	<b>9</b>
Set Up Thermo / Hygro Sensor .....	9
Sensor Data Transmission .....	10
Search for Sensor .....	10
<b>Clock and Calendar</b> .....	<b>11</b>
Radio-Controlled Clock .....	11
Turn Radio-Controlled Clock ON / OFF .....	12
Set Clock .....	12
Switch Clock Display .....	12
<b>Alarms</b> .....	<b>12</b>

Set Daily Alarm .....	12
Set Pre-Alarm .....	13
Activate Alarm .....	13
Snooze .....	13
<b>Barometer</b> .....	<b>13</b>
View Barometer Area .....	13
Select Measurement Unit .....	14
View Barometer History .....	14
Bar Chart Display .....	14
Set Altitude .....	14
<b>Weather Forecast</b> .....	<b>14</b>
Weather Forecast Icons .....	14
<b>UV Measurement</b> .....	<b>15</b>
New Additional UV Features .....	15
<b>Temperature and Humidity</b> .....	<b>16</b>
View Temperature and Humidity Area .....	16
Select Measurement Unit .....	16
Select Sensor Channel .....	16
Minimum / Maximum Records .....	16
Temperature and Humidity Trend .....	16
Comfort Zone .....	17
Heat Index .....	17
<b>Reset System</b> .....	<b>17</b>
<b>Precautions</b> .....	<b>17</b>
<b>Troubleshooting</b> .....	<b>18</b>

<b>Specifications .....</b>	<b>18</b>
<b>About Oregon Scientific .....</b>	<b>20</b>
<b>EU-Declaration of Conformity .....</b>	<b>20</b>
<b>FCC Statement.....</b>	<b>20</b>
Declaration of Conformity .....	21



NE

## PRODUCT OVERVIEW

### FRONT VIEW

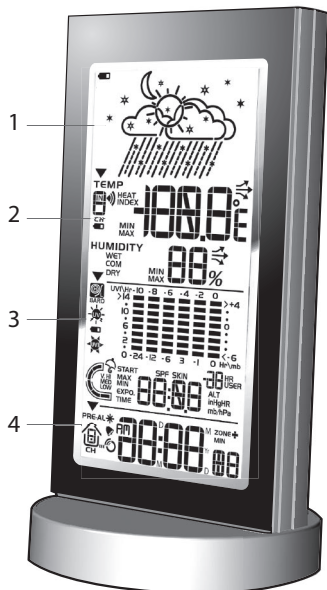

1. **Weather Forecast Area:** Animated weather forecast
2. **Temperature / Humidity / Comfort Zone Area:** Readings and trend lines; comfort zone; sensor channel number
3. **UVI / Barometer Area:** UV level and barometric pressure bar chart; UV Index and barometric readings
4. **Clock / Alarm / Calendar Area:** Radio-controlled clock; alarms; calendar

## BACK VIEW

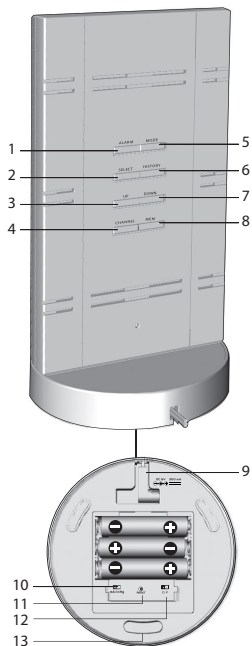

1. **ALARM:** View alarm status; set alarm
2. **SELECT:** Switch Areas
3. **UP:** Increase setting / activate radio-controlled clock
4. **CHANNEL:** Switch remote sensor display
5. **MODE:** Change settings / display
6. **HISTORY:** View historical barometer and UV readings
7. **DOWN:** Decrease setting / deactivate radio-controlled clock
8. **MEM:** View current, maximum and minimum temperature / humidity / UV readings
9. AC adaptor socket
10. **mb / inHg** switch
11. **RESET** button
12. **°C / °F** switch
13. **SNOOZE:** Activate 8-minute snooze



NE

## LCD DISPLAY

### Weather Forecast Area



1. Low battery icon for main unit
2. Weather display

### Temperature / Humidity / Comfort Zone Area

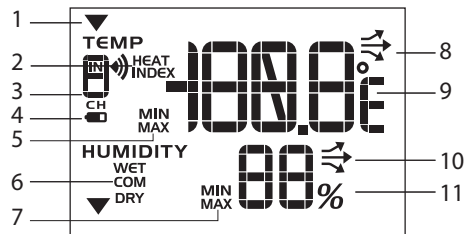

1. Selected Area icon
2. Heat Index
3. Indoor / Outdoor channel number (IN, 1-5) / reception status
4. Low battery icon for remote sensor
5. MAX / MIN temperature
6. Comfort levels
7. MAX / MIN humidity
8. Temperature trend
9. Temperature - °C / °F
10. Humidity trend
11. Humidity

## UVI / Barometer Area

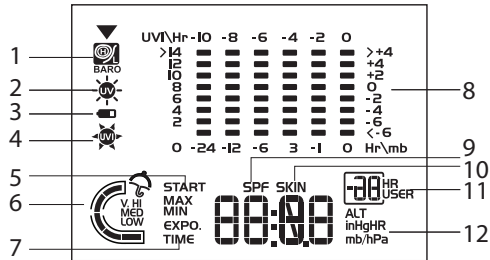

1. Barometric pressure is showing
2. UV is showing
3. Low battery icon for UV sensor
4. UVI value is showing
5. UV exposure time countdown has started
6. UV index level
7. UV exposure time for user
8. Barometer / UV chart
9. SPF applied to user for UV exposure
10. User skin type for UV exposure
11. User number (for UV Mode) or hour history for UV / Barometric pressure reading
12. Altitude / barometric pressure / UVI reading

## Clock / Alarm / Calendar Area



1. Pre-Alarm is set
2. Pre-Alarm display / Pre-Alarm setting
3. Daily Alarm is set
4. Channel with RF clock reception is locked
5. RF clock reception icon
6. Offset time-zone
7. Time / date / calendar



NE

## REMOTE SENSOR

### RTGN318 / RTGN318D

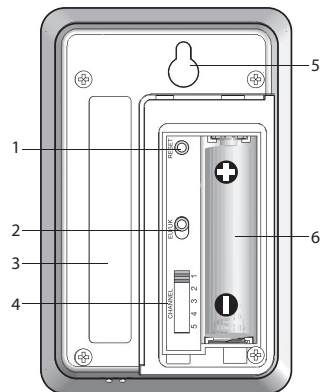
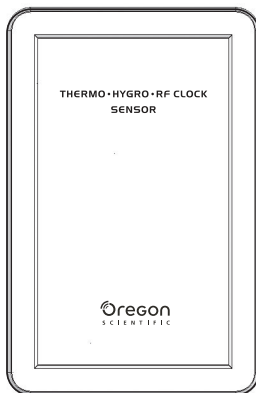

1. **RESET**
2. **EU / UK** radio signal format switch (RTGN318D only)
3. Double sided adhesive tape
4. **CHANNEL** switch (1-5)
5. Wall mount
6. Battery compartment

EN

RTGN318A

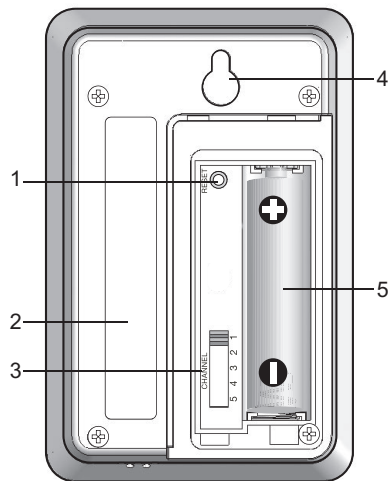
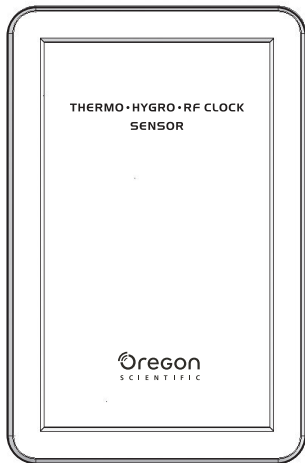

1. **RESET**
2. Double sided adhesive tape
3. **CHANNEL** switch (1-5)
4. Wall mount
5. Battery compartment





## GETTING STARTED

### BATTERIES

Batteries are supplied with this product:

- Main unit            3 x UM-4 (AAA) 1.5V
- Remote unit        1 x UM-3 (AA) 1.5V

Insert batteries before first use, matching the polarity as shown in the battery compartment. For best results, install batteries in the remote sensor before the main unit. Press **RESET** after each battery change.

**NOTE** Do not use rechargeable batteries. Batteries should not be exposed to excessive heat such as sunshine or fire.

 shows when batteries are low.

UNIT	 LOCATION
Main	Weather Forecast Area
Remote	Temperature / Humidity Area
UV Sensor	UVI / Barometric Pressure Area

**NOTE** It is recommended that you use alkaline batteries with this product for longer performance.

### AC ADAPTOR (MAIN UNIT)

The batteries serve as a back-up power supply. For continuous use, please install the AC adaptor at the base of the unit.

Make sure the adaptor is not obstructed and the adaptor socket is easily accessible to the unit.

To be completely disconnected from the power input, the

adaptor should be disconnected from the main unit.

**NOTE** The main unit and adaptor should not be exposed to wet conditions. No objects filled with liquid, such as vases, should be placed on the main unit and adaptor.

### CHANGE SETTINGS

1. Press **SELECT** to switch between Areas.  indicates the selected Area.
2. Most Areas have alternate display options (for example, Clock / Alarm or Barometer / UVI). Press **MODE** to switch options, or **ALARM** to switch between clock and alarm.
3. Press and hold **MODE** for 2 seconds to enter setting mode.
4. Press **UP** or **DOWN** to change settings.
5. Press **MODE** to confirm.

### REMOTE SENSOR

This product is shipped with RTGN318 / RTGN318D / RTGN318A Thermo / Hygro Sensor. The main unit can collect data from up to 6 sensors (5 Thermo / Hygro Sensors and 1 UV Sensor). (Additional sensors are sold separately. Visit [www.oregonscientific.com](http://www.oregonscientific.com) for additional sensors.)

The RTGN318 / RTGN318D / RTGN318A Sensor collects temperature and humidity readings, and signals from official time-keeping organizations for the radio-controlled clock.

### SET UP THERMO / HYGRO SENSOR

1. Open the battery compartment.

- Insert the batteries.
- Set the channel and radio signal format (RTGN318D only). The switches are located in the battery compartment.

SWITCH	OPTION
Channel	If you are using more than one sensor, select a different channel for each sensor.
Radio Signal Format	EU (DCF) / UK (MSF) (RTGN318D only)

- Press **RESET**.
- Close the battery compartment.

#### For best results:

- Insert the batteries and select the unit, channel, and radio signal format before you mount the sensor.
- Place the sensor out of direct sunlight and moisture.
- Do not place the sensor more than 70 metres (230 feet) from the main (indoor) unit.
- Position the sensor so that it faces the main (indoor) unit, minimizing obstructions such as doors, walls, and furniture.
- Place the sensor in a location with a clear view to the sky, away from metallic or electronic objects.
- Position the sensor close to the main unit during cold winter months as below-freezing temperatures may affect battery performance and



signal transmission.

**NOTE** The transmission range may vary and is subject to the receiving range of the main unit.

You may need to experiment with various locations to get the best results.

#### SENSOR DATA TRANSMISSION

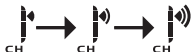
Data is sent from the sensor(s) every 60 Seconds. The reception icon shown in the Temperature / Humidity Area indicates the status.

ICON	DESCRIPTION
	Main unit is searching for sensors.
	At least 1 channel has been found.
	Sensor 1 is sending data. (The number shows which sensor is selected.)
--- shows in Temperature / Humidity Area	The selected sensor cannot be found. Search for the sensor or check batteries.

#### SEARCH FOR SENSOR

To search for a Thermo / Hygro sensor, press **SELECT** to navigate to the Temperature / Humidity Area. ▼ will show



next to the Area. Then, simultaneously press and hold **MEM** and **CHANNEL** for 2 seconds.

**NOTE** If the sensor is still not found, check the batteries.

## CLOCK AND CALENDAR

This product tracks the time and date based on radio-controlled signals from the RTGN318 / RTGN318D / RTGN318A remote sensor, or manual settings that you enter.

### RADIO-CONTROLLED CLOCK

The time and date are automatically updated by radio-controlled clock signals from official time-keeping organizations. The signals are collected by the remote sensor RTGN318 / RTGN318D / RTGN318A.

- **BAR908HG (RTGN318):**

DCF-77 signal: within 1500 km (932 miles) of Frankfurt, Germany.

- **BAR908HGU (RTGN318D):**

Slide **EU / UK** to select the signal received.

EU: DCF-77 signal: within 1500 km (932 miles) of Frankfurt, Germany.

UK: MSF-60 signal: within 1500 km (932 miles) of Anthon, England.



- **BAR908HGA (RTGN318A):**

WWVB-60 signal: within 3200 km (2000 miles) of Fort Collins, Colorado.





Initial reception takes 2-10 minutes, and is initiated when you first set up the unit, and whenever you press **RESET**.

Once complete, the reception icon will stop blinking.

The  icon shown in the Clock Area indicates 2 factors:

- Connection between the main unit and the sensor that collects RF signals (  )
- RF signal reception (  )

### How these signals work together:

ICON	MEANING
	The unit has contact with the sensor and has synchronized the time.
	The unit has contact with the sensor but the time has not been synchronized.
	The unit has lost contact with the remote sensor but the time is synchronized.
	The unit has lost contact with the remote sensor and the time is not synchronized.
	The unit cannot reach the remote sensor.

## TURN RADIO-CONTROLLED CLOCK ON / OFF

If you wish to manually set the clock, you must first disable the radio-controlled feature. To do this, navigate to the Clock / Alarm Area. Then, press and hold **DOWN** on the main unit for 2 seconds. To enable it, navigate to the Clock / Alarm Area, then press and hold **UP** for 2 seconds.

RF clock enabled:



RF clock disabled:



## SET CLOCK

You only need to do this if you have disabled the radio-controlled clock, or if you are too far from a RF signal.

1. Press **SELECT** to navigate to the Clock Area. ▼ will show next to the Area.
2. Press and hold **MODE** for 2 seconds.
3. Select the time zone offset hour (+ / -23 hours), 12 / 24 hour format, hour, minute, year, date / month format, month, date and display language.
4. Press **UP** or **DOWN** to change the setting.
5. Press **MODE** to confirm.

**BAR908HGA:** Select the time zone: (0) Pacific, (+1) Mountain, (+2) Central or (+3) Eastern.

**NOTE** The language options are (E) English, (F) French, (D) German, (I) Italian, and (S) Spanish. The language you select determines the weekday display.

## SWITCH CLOCK DISPLAY

Press **SELECT** to navigate to the Clock Area. ▼ will show next to the Area.

Press **MODE** to toggle between:

- Clock with seconds
- Clock with day
- Clock with time-zone offset
- Calendar

## ALARMS

This product has 2 alarms: The Daily Alarm and a Pre-Alarm for snowy weather. The Daily Alarm can be set to go off at the same time every day. The Pre-Alarm sounds only when the Daily Alarm is activated and the recorded temperature from Channel 1 Sensor falls to 2°C (35.6°F) or below.

## SET DAILY ALARM

1. Press **SELECT** to navigate to the Clock Area. ▼ will show next to the Area.
2. Press **ALARM** to view the alarm. (AL will show at the top.)
3. Press and hold **ALARM** for 2 seconds.



4. Select the hour and minute. Press **UP** or **DOWN** to change settings.
5. Press **ALARM** to confirm.
6. The Daily Alarm icon  will appear when the alarm is set.

### SET PRE-ALARM

The Pre-Alarm can be set to sound 15, 30, 45, or 60 minutes before the Daily Alarm. It will sound whenever the recorded temperature from Channel 1 Sensor falls to 2°C (35.6°F) or below.

For example, if you set the alarm to 7:00 AM, and the Pre-Alarm to 45 minutes, the Pre-Alarm will sound at 6:15 AM provided the outdoor temperature at Channel 1 Sensor is 2°C or below.

1. Set up and activate the Daily Alarm.
2. Press **ALARM** to switch to Pre-Alarm view. (**PRE-AL** will show at the top.)
3. Press and hold **ALARM** for 2 seconds.
4. Press **UP** or **DOWN** to select 15, 30, 45 or 60 minutes. This is the amount of time the Pre-Alarm will sound **BEFORE** the Daily Alarm. The Pre-Alarm is automatically activated when you select a time.
5. Press **ALARM** to confirm.

\* shows when the Pre-Alarm is set.

**NOTE** The Daily Alarm will NOT function until the next day if the Pre-Alarm has been triggered. Also, if you deactivate the Daily Alarm, the Pre-Alarm is automatically deactivated.

### ACTIVATE ALARM

Navigate to the Clock Area, then press **ALARM** to switch to Daily Alarm or Pre-Alarm view. To activate or deactivate the alarm, press **UP** or **DOWN**.

When the alarm time is reached, the backlight will be on for 8 seconds and crescendo alarm will sound for 2 minutes. Press any key (except snooze) to silence the alarm. It will sound at the same time the next day.

### SNOOZE

Press **SNOOZE** to temporarily disable the alarm for 8 minutes.  or \* will blink while snooze is on.

### BAROMETER

This product tracks fluctuations in barometric pressure to provide the weather forecast, and the current and past 24 hours barometric pressure history measurements are recorded by the main (indoor) unit.

### VIEW BAROMETER AREA

Press **SELECT** to navigate to the Barometer Area.

If  is NOT shown, press **MODE**.

Barometric data is shown in 2 areas at the bottom of the display. The upper area shows a 24-hour bar chart. The low area shows current and historical readings.

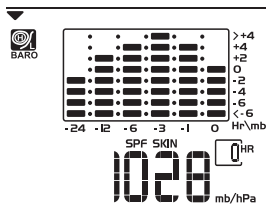

### SELECT MEASUREMENT UNIT

Slide the **mb / inHg** switch (in the clock battery compartment), to change the display unit.

### VIEW BAROMETER HISTORY

Navigate to the Barometer Area. Then press **HISTORY** repeatedly to scroll through the measurements. The number shown in the HR box indicates how long ago each measurement was taken (e.g. 2 hours ago, 3 hours ago, etc.).

### BAR CHART DISPLAY

The bar chart visually shows atmospheric changes from the current hour (0) to 24 hours prior (-24).

### SET ALTITUDE

Set the altitude to match how far above or below sea level you are living. This ensures that the barometric pressure readings are accurate.

1. Navigate to the Barometer Area.

2. Press and hold **HISTORY** for 2 seconds.
3. Press **UP** or **DOWN** to set the altitude in 10-metre increments (-100m to 2500m).
4. Press **HISTORY** to confirm.

### WEATHER FORECAST

This product forecasts the next 12 to 24 hours of weather within a 30-50 km (19-31 mile) radius. The forecast is based on barometric pressure trend readings.

The top area shows an animated icon indicating the forecasted weather.

### WEATHER FORECAST ICONS

ICON	DESCRIPTION
 Day / Night	Clear
 Day / Night	Partly cloudy
	Cloudy
	Rainy
	Snowy



**NOTE** The night time icon displays from 6 PM to 6 AM. When the Channel 1 sensor records a temperature of 2°C (35.6°F) or lower, the RAINY icon becomes SNOWY.

## UV MEASUREMENT

The UVR128 Ultra-Violet Radiation Sensor is available as an optional item for BAR908HG / BAR908HGU / BAR908HGA. The UV sensor gives you the following information at your fingertips:

- 10-hour Ultra-Violet Index (UVI) record.
- Automatic calculation of acceptable UV exposure times based on pre-set user profiles (4 users maximum).
- UVI Danger Alert when UV Index reaches unsafe levels.

UV data is shown in the same area as the Barometer. Press **SELECT** to navigate to the Barometer Area, then press **MODE** to display the UV icon  and data.

## NEW ADDITIONAL UV FEATURES

### UV EXPOSURE TIME COUNTDOWN

To set the exposure time countdown you need to set the Skin Type and Sun Protection Factor (SPF) as follows:

1. Press **SELECT** to navigate to the Barometer Area, then press **MODE** to select the UV display.

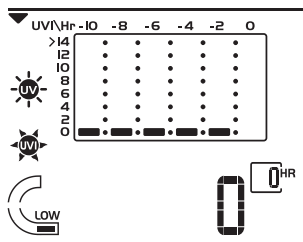

2. Press **CHANNEL** to select user 1-4.
3. Press and hold **MODE** for 2 seconds to enter the Skin Type Setting Mode of the selected user.
4. Press **UP** or **DOWN** to choose 1 of the 4 skin type settings. Then press **MODE** to confirm and enter the SPF Set Up Mode.
5. Press **UP** or **DOWN** to increase or decrease the **SPF** value. Then press **MODE** to confirm and enter the UV Exposure Time Countdown Setting Mode.
6. Press **UP** or **DOWN** to enable or disable countdown. Press **MODE** to exit the UV Exposure Time Countdown Mode and start the exposure time countdown. The remaining user UV exposure time will display and the **START** will flash.
7. When the countdown has reached "0", an alarm will sound for 2 minutes. Press any button to turn the alarm off. The **EXPE TIME** icon will flash for 2 minutes even if you have stopped the alarm sound.

## MAXIMUM / MINIMUM MEMORY FOR UVI

To view the maximum and minimum memory for UVI:

1. Press **SELECT** to navigate to the Barometer Area.
2. Press **MODE** to select the UV display.
3. Press **MEM** to show maximum, minimum and current UVI readings.
4. Press and hold **MEM** for 2 seconds to clear the UVI memory.

**NOTE** The UV sensor must be activated before you try and set the additional features.

## TEMPERATURE AND HUMIDITY

The weather station can display the following information from any of the 5 remote sensors:

- Current, minimum, and maximum temperatures and relative humidity percentages.
- Comfort level indicator and trend line (rising, falling, or steady).

Data is collected and displayed approximately every 60 seconds.

## VIEW TEMPERATURE AND HUMIDITY AREA

Press **SELECT** to navigate to the Temperature and Humidity Areas.

Temperature data is given at the top; Humidity is below.

## SELECT MEASUREMENT UNIT

Slide the °C / °F switch (inside the clock battery compartment), to the setting you want.

## SELECT SENSOR CHANNEL

Press **CHANNEL** to switch between sensors 1-5.

- To auto-scan between sensors, press and hold **CHANNEL** for 2 seconds. Each sensor's data will be displayed for 3 seconds.
- To end auto-scan, press **CHANNEL** or **MEM** with the Temperature / Humidity Area selected.



**NOTE** If you select a sensor that collects only temperature data, the humidity will not be shown.

## MINIMUM / MAXIMUM RECORDS

- Press **MEM** repeatedly to view current, maximum and minimum records for the selected sensor.
- To clear the records, press and hold **MEM** for 2 seconds. A beep will sound to confirm that the memory has been cleared.

## TEMPERATURE AND HUMIDITY TREND

The trend lines are shown next to the temperature and humidity readings.

TREND	RIISING	STEADY	FALLING
TEMPERATURE			
HUMIDITY			





## COMFORT ZONE

The Comfort Zone indicates how comfortable the climate is, based on current temperature and humidity measurements.

ZONE	TEMPERATURE	HUMIDITY
WET	Any	>70%
COM	20-25°C (68-77°F)	40-70%
DRY	Any	<40%

**NOTE** This information is shown in the Humidity Area when the current measurement is displayed.

## HEAT INDEX

The Heat Index advises 4 levels of warning if the temperature is high.

DANGER CATEGORY	TEMPERATURE	
	°C	°F
Extreme Danger	>54.5	>130
Danger	40.5-54.4	105-130
Extreme Caution	32.2-40.5	90-105
Caution	26.6-32.2	80-90

To display the Heat Index:

1. Press **SELECT** to navigate to the Temperature Area. ▼ will show next to the Area.
2. Press **MODE** to reach the Heat Index display.

3. Press **CHANNEL** to select the desired channel.

**NOTE** If the temperature is below 26°C / 80°F, or the desired channel is not working, the Heat Index will display "NA".

## RESET SYSTEM

The **RESET** button is located at the bottom of the unit. Press **RESET** when you change the batteries and whenever performance is not behaving as expected (for example, unable to establish radio frequency link with remote unit or radio-controlled clock).

**NOTE** When you press **RESET**, all settings will return to default value, and you will lose all stored information.

## PRECAUTIONS

- Do not subject the unit to excessive force, shock, dust, temperature or humidity.
- Do not cover the ventilation holes with any items such as newspapers, curtains etc.
- Do not immerse the unit in water. If you spill liquid over it, dry it immediately with a soft, lint-free cloth.
- Do not clean the unit with abrasive or corrosive materials.
- Do not tamper with the unit's internal components. This invalidates the warranty.
- Only use fresh batteries. Do not mix new and old batteries.
- Images shown in this manual may differ from the actual display.
- When disposing of this product, ensure it is collected

separately for special treatment and not as normal household waste.

- Placement of this product on certain types of wood may result in damage to its finish for which Oregon Scientific will not be responsible. Consult the furniture manufacturer's care instructions for information.
- The contents of this manual may not be reproduced without the permission of the manufacturer.
- Do not dispose old batteries as unsorted municipal waste. Collection of such waste separately for special treatment is necessary.
- Please note that some units are equipped with a battery safety strip. Remove the strip from the battery compartment before first use.

**NOTE** The technical specifications for this product and the contents of the user manual are subject to change without notice.

**NOTE** Features and accessories will not be available in all countries. For more information, please contact your local retailer.

## TROUBLESHOOTING

PROBLEM	SYMPTOM	REMEDY
Barometer	Strange readings	Set altitude/unit
Calendar	Strange date / month	Change language
Clock	Cannot adjust clock	Disable radio-controlled clock
	Cannot auto-synch	1. Adjust batteries 2. Press <b>RESET</b> 3. Manually activate radio-controlled clock
Temperature	Shows "LLL" or "HHH"	Temperature is out-of-range
Remote sensor	Cannot locate remote sensor	Check batteries

## SPECIFICATIONS

### Main Unit Dimensions

L x W x H	175 x 93 x 93 mm (6.89 x 3.66 x 3.66 in)
Weight	336 g (11.85 oz) without battery

### Remote Unit Dimensions

L x W x H	117 x 80 x 171 mm
-----------	-------------------

Z  
E

Weight (4.61 x 3.15 x 6.73 in)  
80 g (2.82 oz)  
without battery

partly cloudy (day /  
night), cloudy, rainy,  
snowy

**Temperature**

Unit °C or °F  
Indoor Range -5 °C to 50 °C  
(23 °F to 122 °F)  
Outdoor Range -20 °C to 60 °C  
(-4 °F to 140 °F)  
Resolution 0.1 °C (0.2° F)  
Comfort 20 °C to 25 °C  
(68 °F to 77 °F)  
Memory Min / Max

**Remote Unit**

RF frequency 433 MHz  
Range Up to 70 m (230 ft) with  
no obstructions  
Transmission Approx. every 1 minute  
Channel No. 1, 2, 3, 4 or 5  
Unit °C or °F

**Relative Humidity**

Range 25% to 95%  
Resolution 1%  
Comfort 40% to 70%  
Memory Min / max

**Radio-Controlled Clock**

Synchronization Auto or disabled  
Clock display HH:MM:SS  
Hour format 12hr AM/PM  
24hr  
Calendar DD / MM or MM / DD;  
Day of the week in 1 of  
5 languages (E, G, F, I, S)  
Alarm Daily & Pre-Alarm;  
2-minute crescendo  
Snooze 8-minute snooze

**Barometer**

Unit mb / hPa or inHg  
Resolution 1 mb (0.03 inHg)  
Altitude -100 to 2500 m  
(-328 to 2734 ft)  
Display Sunny (day / night),

**Power**

**Main Unit**  
Power adapter 6V AC adapter

Batteries

3 x UM-4 (AAA) 1.5V

**Thermo / Hygro Remote Unit**

Batteries

1 x UM-3 (AA) 1.5V

**NOTE** It is recommended that you use alkaline batteries with this product for longer performance.

**ABOUT OREGON SCIENTIFIC**

Visit our website ([www.oregonscientific.com](http://www.oregonscientific.com)) to learn more about Oregon Scientific products.

If you're in the US and would like to contact our Customer Care department directly, please visit:

[www2.oregonscientific.com/service/support.asp](http://www2.oregonscientific.com/service/support.asp)

For international inquiries, please visit:

[www2.oregonscientific.com/about/international.asp](http://www2.oregonscientific.com/about/international.asp)

**EU-DECLARATION OF CONFORMITY**

Hereby, Oregon Scientific, declares that this Metal Weather Station (BAR908HG / BAR908HGU / BAR908HGA) is in compliance with the essential requirements and other relevant provisions of Directive 1999/5/EC. A copy of the signed and dated Declaration of Conformity is available on request via our Oregon Scientific Customer Service.

**COUNTRIES RTTE APPROVAL COMPLIED**

All EU countries, Switzerland **CH**  
and Norway **N**

**FCC STATEMENT**

This device complies with Part 15 of the FCC Rules. Operation is subject to the following two conditions: (1) This device may not cause harmful interference, and (2) This device must accept any interference received, including interference that may cause undesired operation.

**WARNING** Changes or modifications not expressly approved by the party responsible for compliance could void the user's authority to operate the equipment.

**NOTE** This equipment has been tested and found to comply with the limits for a Class B digital device, pursuant to Part 15 of the FCC Rules. These limits are designed to provide reasonable protection against harmful interference in a residential installation.



This equipment generates, uses and can radiate radio frequency energy and, if not installed and used in accordance with the instructions, may cause harmful interference to radio communications. However, there is no guarantee that interference will not occur in a particular installation. If this equipment does cause harmful interference to radio or television reception, which can be determined by turning the equipment off and on, the user is encouraged to try to correct the interference by one or more of the following measures:

- Reorient or relocate the receiving antenna.
- Increase the separation between the equipment and receiver.
- Connect the equipment into an outlet on a circuit different from that to which the receiver is connected.
- Consult the dealer or an experienced radio / TV technician for help.

#### DECLARATION OF CONFORMITY

The following information is not to be used as contact for support or sales. Please visit our website at [www2.oregonscientific.com/service](http://www2.oregonscientific.com/service) for all enquiries.

#### We

Name: Oregon Scientific, Inc.  
Address: 19861 SW 95th Ave., Tualatin,  
Oregon 97062 USA  
Telephone No.: 1-800-853-8883

#### declare that the product

Product No.: BAR908HG / BAR908HGU /  
BAR908HGA  
Product Name: Metal Weather Station  
Manufacturer: IDT Technology Limited  
Address: Block C, 9/F, Kaiser Estate,  
Phase 1, 41 Man Yue St., Hung Hom,  
Kowloon,  
Hong Kong

is in conformity with Part 15 of the FCC Rules. Operation is subject to the following two conditions: 1) This device may not cause harmful interference. 2) This device must accept any interference received, including interference that may cause undesired operation.

## Free Manuals Download Website

<http://myh66.com>

<http://usermanuals.us>

<http://www.somanuals.com>

<http://www.4manuals.cc>

<http://www.manual-lib.com>

<http://www.404manual.com>

<http://www.luxmanual.com>

<http://aubethermostatmanual.com>

Golf course search by state

<http://golfingnear.com>

Email search by domain

<http://emailbydomain.com>

Auto manuals search

<http://auto.somanuals.com>

TV manuals search

<http://tv.somanuals.com>