

**OLYMPUS**

# CAMEDIA

**DIGITAL CAMERA**

**D-390**

**C-150**

**REFERENCE MANUAL**

**<Click Here>**

**CAMERA OPERATION MANUAL**

Explanation of digital camera functions and operating instructions.

**DIGITAL CAMERA - PC CONNECTION  
OPERATION MANUAL**

Explanation of how to download images between your digital camera and PC.

# CAMEDIA

# OLYMPUS

DIGITAL CAMERA

## D-390

## C-150

---

### REFERENCE MANUAL

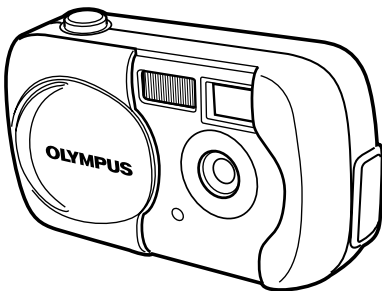

- 
- Thank you for purchasing an Olympus digital camera. Before you start to use your new camera, please read these instructions carefully to enjoy optimum performance and a longer service life. Keep this manual in a safe place for future reference.
  - We recommend that you take test shots to get accustomed to your camera before taking important photographs.
  - In the interest of continually improving products, Olympus reserves the right to update or modify information contained in this manual.

## For customers in North and South America

### For customers in USA

Declaration of Conformity

Model Number : D-390/C-150

Trade Name : OLYMPUS

Responsible Party : Olympus America Inc.

Address : 2 Corporate Center Drive, Melville, New York  
11747-3157 U.S.A.

Telephone Number : 631-844-5000

Tested To Comply With FCC Standards  
FOR HOME OR OFFICE USE

This device complies with Part 15 of the FCC rules. Operation is subject to the following two conditions:

- (1) This device may not cause harmful interference.
- (2) This device must accept any interference received, including interference that may cause undesired operation.

### For customers in Canada

This Class B digital apparatus meets all requirements of the Canadian Interference-Causing Equipment Regulations.

## For customers in Europe





"CE" mark indicates that this product complies with the European requirements for safety, health, environment and customer protection. "CE" mark cameras are intended for sales in Europe.



## Trademarks

- IBM is a registered trademark of International Business Machines Corporation.
- Microsoft and Windows are registered trademarks of Microsoft Corporation.
- Macintosh is a trademark of Apple Computer Inc.
- All other company and product names are registered trademarks and/or trademarks of their respective owners.
- The standards for camera file systems referred to in this manual are the "Design Rule for Camera File System/DCF" standards stipulated by the Japan Electronics and Information Technology Industries Association (JEITA).





	<b>Contents</b>	<b>P. 4</b>	
	<b>Getting started</b>	<b>P. 7</b>	<b>1</b>
Introduction of the camera's functions	Using the menus	P. 29	<b>2</b>
For easily learning the fundamentals of taking pictures	<b>Shooting basics</b>	<b>P. 37</b>	<b>3</b>
For fine-tuning the settings to get that particular shot	Advanced shooting	P. 52	<b>4</b>
For playing back and arranging pictures	<b>Playback</b>	<b>P. 67</b>	<b>5</b>
Settings that make the camera easier to operate	Useful functions	P. 84	<b>6</b>
Printing pictures	<b>Print settings</b>	<b>P. 93</b>	<b>7</b>
Troubleshooting and other information	Miscellaneous	P. 99	<b>8</b>
	<b>Specifications</b>	<b>P. 111</b>	
	<b>Index</b>	<b>P. 113</b>	

# Contents











Contents .....	4
<b>1 Getting started</b>	<b>7</b>
Names of parts .....	7
Monitor indications .....	9
How to use this manual .....	12
Attaching the strap .....	13
Loading batteries .....	14
Selecting batteries or the optional AC adapter .....	16
Inserting/Removing a card .....	18
Card basics .....	18
Power on/off .....	21
If the card is not recognized (card check) .....	23
Selecting a language  .....	24
Setting the date and time  .....	26
Holding the camera .....	28
<b>2 Using the menus</b>	<b>29</b>
Menu items .....	29
How to use the mode menu .....	30
Shortcut menus .....	32
Mode menus .....	34
<b>3 Shooting basics</b>	<b>37</b>
Shooting modes .....	37
Selecting shooting modes .....	38
Taking still pictures  <b>PHOTO</b> .....	40
Taking still pictures using the viewfinder .....	40
Taking still pictures using the monitor .....	41
Comparison of the viewfinder & monitor .....	43
If correct focus cannot be obtained .....	44
How to lock the focus .....	44
Subjects that are difficult to focus on .....	45

Recording movies 	46
Zoom (Digital zoom)	48
Using the flash 	49

## 4 Advanced shooting 52



Macro mode shooting 	52
Self-timer shooting 	53
Selecting the metering area (Spot metering) 	54
PANORAMA - Panorama shooting	55
2 IN 1 - Taking two-in-one pictures <b>2 IN 1</b>	57
Changing the record mode 	59
Varying the image brightness (Exposure compensation) 	63
Adjusting the white balance <b>WB</b>	65

## 5 Playback 67

Viewing still pictures 	67
QUICK VIEW	68
Close-up playback 	69
Index display 	70
Slideshow 	71
Picture Rotation 	72
Playback on a TV	73
MOVIE PLAY - Viewing movies 	74
Protecting pictures 	76
Erasing pictures 	77
Single-frame erase	77
All-frame erase 	78
Editing still pictures	79
Creating black and white pictures	79
Creating sepia-toned pictures	80
Resizing pictures 	80
INDEX - Creating an index	82





## 6 Useful functions 84

---

MODE RESET - Restoring the factory default settings .....	84
ALL RESET - Saving the settings .....	84
CARD SETUP - Formatting cards  .....	85
Displaying shooting information <b>INFO</b> .....	87
REC VIEW - Viewing a picture immediately after shooting .....	88
Adjusting the monitor brightness  .....	88
Turning the beep sound off  .....	89
FILE NAME .....	89
PIXEL MAPPING.....	91
VIDEO OUT - Video output selection .....	92

## 7 Print settings 93

---

How to print pictures  .....	93
All-frame reservation  .....	95
Single-frame reservation  .....	96
Resetting print reservation data  .....	98

## 8 Miscellaneous 99

---

Error codes .....	99
Troubleshooting.....	100
Menu list .....	105
Factory default settings .....	108
List of functions by shooting mode .....	109
Camera maintenance .....	110
Specifications.....	111
Index .....	113

# 1 Getting started

## Names of parts

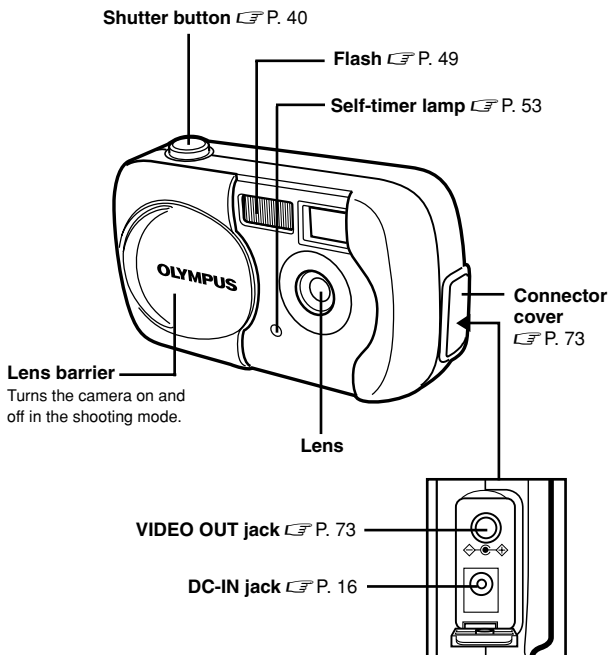



**Arrow pad**

Simply press a button ( $\Delta/\nabla/\triangleleft/\triangleright$ ) to directly select zoom in/out, flash or self-timer. Buttons are also used to navigate the various menu items.

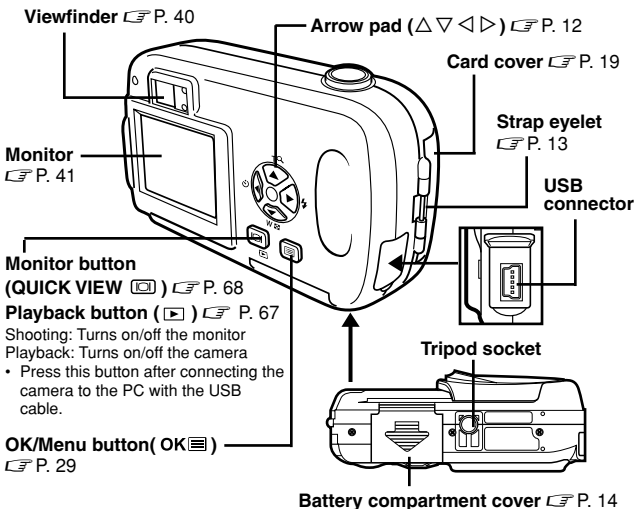
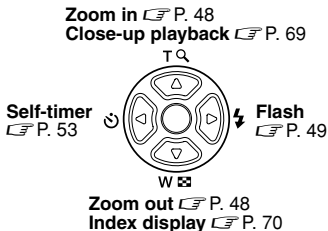
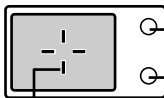
**Viewfinder**AF target mark  P. 40Orange lamp  P. 40, 49Green lamp  P. 40

# Monitor indications

## ● Shooting mode

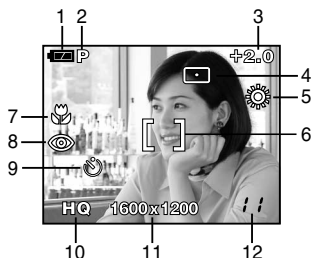







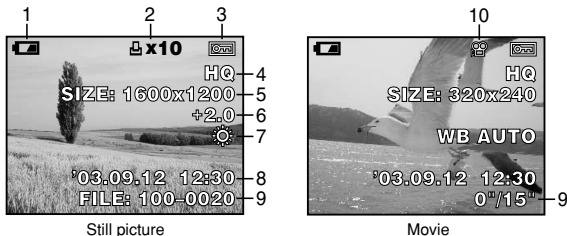

	Items	Indications	Ref. page
1	Battery check		P. 11
2	Shooting mode	<b>P</b> ,	P. 37
3	Exposure compensation	-2.0 - +2.0	P. 63
4	Spot metering mode		P. 54
5	White balance		P. 65
6	AF target mark	[ ]	P. 41
7	Macro		P. 52
8	Flash mode		P. 49
9	Self-timer		P. 53
10	Record mode	SHQ, HQ, SQ1, SQ2	P. 59
11	Resolution (number of pixels)	1600 x 1200, 1024 x 768, 640 x 480, etc.	P. 60
12	Number of storable still pictures	11	P. 41
	Seconds remaining for movies	11"	P. 46

### ● Playback mode

INFO setting allows you to select how much information to display on the monitor. Screens when the information display is set to ON are shown below.  "Displaying shooting information" (P. 87)



	Items	Indications	Ref. page
1	Battery check	 , 	P. 11
2	Print reservation Number of prints	 x10	P. 95 P. 96
3	Protect		P. 76
4	Record mode	SHQ, HQ, SQ1, SQ2	P. 59
5	Number of pixels	1600 x 1200, 1024 x 768, 640 x 480, etc.	P. 60
6	Exposure compensation	-2.0 – +2.0	P. 63
7	White balance	WB AUTO,  ,  ,  , 	P. 65
8	Date and time	'03.09.12 12:30	P. 26
9	File number, Frame number, Playing time /Total recording time	100-0020, 12, 0"/15"	P. 74 P. 87
10	Movie mode		P. 74



Note

- The indications that appear on a movie picture that has been displayed from the index display are different from those that appear when the movie picture is displayed using the movie playback function.

### ●Battery check

If the remaining battery power is low, the battery check indication on the monitor changes as follows when the camera is turned on or while the camera is in use.

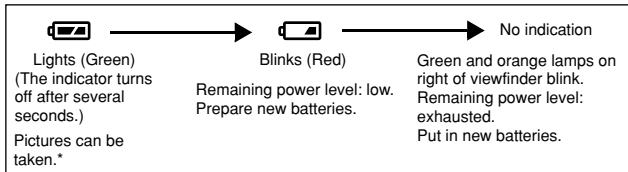

\* The amount of energy the camera uses varies greatly on how the camera is operated. Battery power may finish without displaying any warning, causing the camera to turn off.

# How to use this manual

This sample page is only for your reference. It may differ from the actual instructions in this manual.

Follow the arrows to perform menu operations. For details of operating procedures, see "How to use the mode menu" (P. 30).

The buttons for various functions and their locations are clearly illustrated.

## 1 Getting started

**PANORAMA - Panorama shooting**

You can take advantage of panorama shooting with the Olympus xD-Picture Card. Panorama shooting lets you connect pictures with overlapping edges into a single panoramic picture, using the CAMELIA Master software contained on the CD-ROM provided.

**1** In the shooting mode top menu, select **MODE MENU → CAMERA → PANORAMA**, and press **▷**.

☞ "How to use the mode menu" (P. 30)

- The monitor turns on.
- The PANORAMA mode is set.

**2** On the monitor, use the arrow pad to choose the direction you want the pictures connected.

- ▷ Connects the pictures from left to right.
- ◁ Connects the pictures from right to left.
- △ Connects the pictures from bottom to top.
- ▽ Connects the pictures from top to bottom.

**4** Advanced shooting

Arrow pad (△▽◁▷)



OK

Connects pictures from left to right.

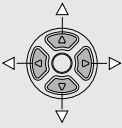
△, ▽, ◁ and ▷ indicate which button to press on the arrow pad.



### ●Indications used in this manual

 Note	Important information on factors which may lead to a malfunction or operational problems. Also warns of operations that should be absolutely avoided.
	Useful information and hints that will help you get the most out of your camera.
	Reference pages describing details or associated information.

# Attaching the strap

- 1 Thread the short end of the strap through the strap eyelet.

- The strap can only enter from the lens side.

- 2 Thread the long end of the strap through the loop that has already gone through the eyelet.

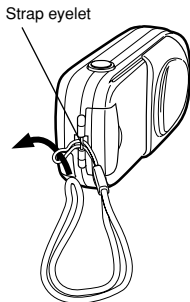

- 3 Pull the strap tight, making sure that it is securely fastened and does not come loose.

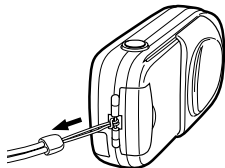

Note

- Be careful with the strap when you carry the camera, as it can easily catch on stray objects, causing injury or damage.
- Attach the strap correctly following the procedure so that the camera does not fall off. If the strap is attached incorrectly and the camera falls off, Olympus is not responsible for any damages.

# Loading batteries

Use one CR-V3 lithium battery pack, or two AA (R6) NiMH batteries or alkaline batteries.

## Important

- CR-V3 lithium battery packs cannot be re-charged.
- Do not peel the label on a CR-V3 lithium battery pack.
- Manganese (zinc-carbon) batteries cannot be used.

1 Getting started

### 1 Make sure that:

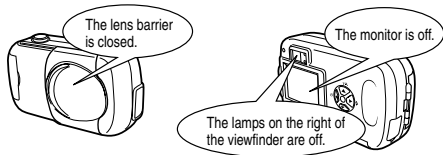

### 2 Slide the battery compartment cover in the direction of (A) (the direction indicated by the mark on the cover), and lift it up in the direction of (B).

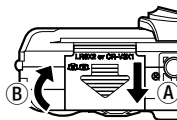



### 3 Insert batteries in the direction shown in the illustration.

When using AA (R6) batteries

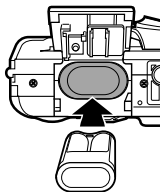
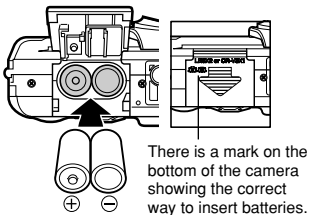
When using a CR-V3 lithium battery pack



- 4** Close the battery compartment cover so that it pushes batteries down inside. While pressing the  mark, slide the cover in the direction of **(C)**.

- If the battery compartment cover seems hard to close, do not force it. With the battery compartment cover shut, press the  mark firmly and push in the direction shown in the illustration.

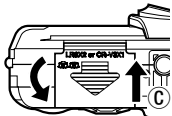

Note

- Some camera settings will return to the factory default settings if the camera is left for about one hour with the battery removed.



## Selecting batteries or the optional AC adapter

In addition to the batteries provided, this camera can also use the following types of batteries or AC adapter. Choose the power source best suited to the situation.

### ●CR-V3 lithium battery packs (Not rechargeable)

Because CR-V3 lithium battery packs have long lives, they are convenient when traveling. Do not peel off their labels.

### ●NiMH batteries (Rechargeable)

Olympus NiMH batteries are rechargeable and economical. If they are often charged without first using all their power, the amount of time they can be used will become gradually shorter.

### ●AA (R6) alkaline batteries

When you need batteries in a hurry, you can use AA (R6) alkaline batteries, which are easy to get anywhere. However, the number of pictures you can store may vary greatly, depending on the battery manufacturer, shooting conditions, etc. To save power, turn off the monitor whenever possible.

### ●AC adapter

Be sure to use the specified AC adapter. An AC adapter is useful for time-consuming tasks such as image downloads.

Use an AC adapter designed to operate on the AC voltage in the area the camera is being used.

Consult your nearest Olympus dealer or service center for details.

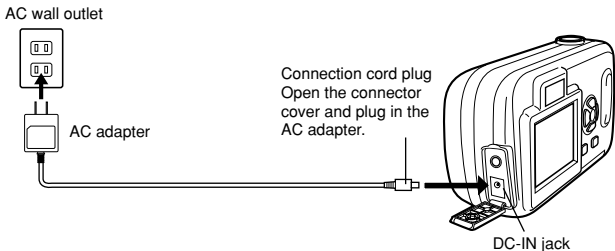



Note

- Manganese (zinc-carbon) batteries cannot be used.
- If the battery power runs out while the camera is connected to a PC, the image data may be lost or damaged. You are recommended to use the AC adapter when transferring images to a PC. Do not connect or disconnect the AC adapter while the camera is communicating with the PC.
- Do not remove or load batteries or connect or disconnect the AC adapter while the camera is turned on. Doing so could affect the camera's internal settings or functions.
- Power is consumed continuously during the conditions described below. This could make batteries run out of power quickly.
  - Turning on the monitor.
  - Repeated auto-focus by depressing the shutter button halfway.
  - When the camera is connected to a PC.
- When using an AC adapter, power is supplied to the camera by the AC adapter even if batteries are loaded in the camera. The AC adapter does not charge batteries in the camera.
- Carefully read the separate-volume Safety Precaution before use.

1

Getting started

# Inserting/Removing a card

"Card" in this manual refers to the xD-Picture Card. The camera uses the card to record pictures.

## Card basics

The card corresponds to normal camera film for recording the pictures you have taken. Pictures recorded and stored on the card can easily be erased, overwritten, and/or edited on a PC.

### 1 Getting started

① **Index area**

You can write down the card's contents.

② **Contact area**

Comes into contact with the camera's signal read contacts.

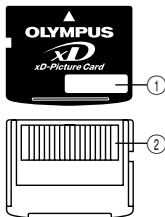

## Compatible cards

- xD-Picture Card (16 to 256 MB)



Note

- This camera may not recognize a non-Olympus card or a card that was formatted on another device (such as a PC, etc.). Before use, be sure to format the card on this camera.  "CARD SETUP - Formatting cards" (P. 85)

## ● Inserting a card

### 1 Make sure that:

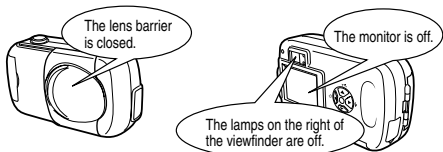

### 2 Open the card cover.

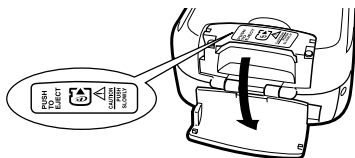

### 3 Face the card the correct way and insert it into the card slot as shown.

- Insert the card while keeping it straight.
- When the card is inserted fully, you will feel it lock into place.
- Inserting the card the wrong way or at an angle could damage the contact area or cause the card to jam.
- If the card is not inserted all the way, data may not be written to the card.

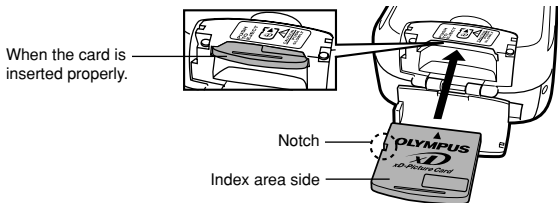

### 4 Close the card cover.

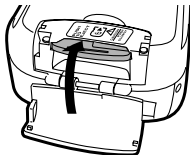

## ● Removing the card

### 1 Make sure that:

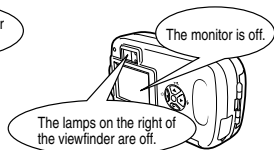
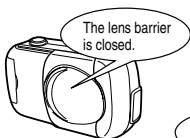

1  
Getting started

### 2 Open the card cover.

### 3 Push the card all the way in to unlock it, then let it return slowly.

- The card is ejected a short way and then stops.

#### Note

Releasing your finger quickly after pushing the card all the way in may cause it to eject forcefully out of the slot.

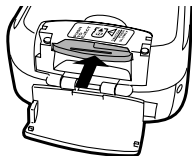

### 4 Hold the card straight and pull it out.

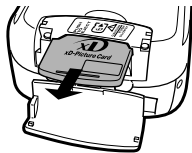

### 5 Close the card cover.



Note

- Do not push in the card with hard or pointed objects, such as a pen.
- Never open the card cover, or remove the card or the battery while the camera is turned on. Doing so could destroy the data on the card. Once destroyed, data cannot be restored.

# Power on/off

## ● When shooting pictures

**Power on: Open the lens barrier.**

The camera turns on in the shooting mode.

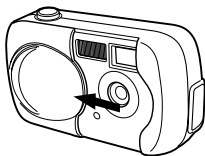

**Power off: Close the lens barrier.**

The camera turns off.

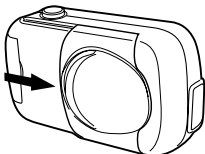

### ● Power on

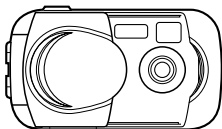

### ● Power off

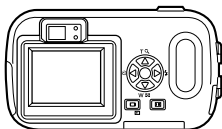
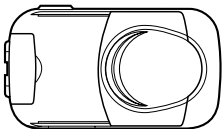

### TIPS

- To save battery power, the camera automatically enters the sleep mode (stops being active) after about 3 minutes of non-operation. The camera activates again as soon as you lightly press the shutter button. Whenever possible, turn the camera off when you do not intend to take any pictures for a while.

**•When playing back pictures**

**Power on:** Press  with the lens barrier closed.

The camera turns on in the playback mode. The monitor turns on and the last picture taken is displayed.

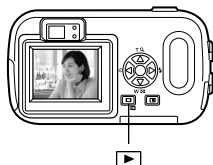
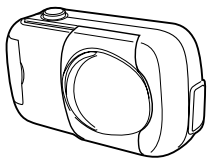

**Power off:** Press  .

The monitor and the camera turn off.

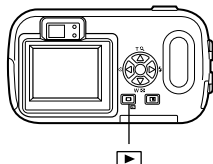
**? TIPS**

- When the camera turns on, the monitor may light up for an instant and a picture appear after a short time. This is not a malfunction.

**! Note**

- Never open the card cover, remove the card or the battery, or connect or disconnect the AC adapter while the camera is turned on. Doing so could destroy all data on the card. Destroyed data cannot be restored. When changing the card, be sure to turn the camera off before opening the card cover.

## If the card is not recognized (card check)

When the power is turned on, the camera checks the card automatically. If there is no card in the camera or a card that is not supported by this camera is inserted, the following screen is displayed.



- All data stored on the card is erased when the card is formatted.

Note

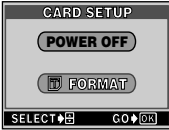
Monitor indication	Corrective action
 NO CARD	<p>There is no card in the camera or the card is not inserted properly.</p> <p>→ Turn off the camera, then insert a card. If a card is already inserted, remove it and insert it again correctly.</p>
	<p>The card cannot record, play back or erase pictures.</p> <p>→ Replace the card with a new one. Press <math>\Delta</math> <math>\nabla</math> to select POWER OFF, then press <b>OK</b>.</p> <p>→ Format the card. Press <math>\Delta</math> <math>\nabla</math> to select <b>FORMAT</b>, then press <b>OK</b> to display the confirmation screen. Select YES and press <b>OK</b>. Formatting starts. If the card was successfully formatted, the camera is ready to take pictures.</p>



# Selecting a language



You can select a language for on-screen display. This reference manual shows the English on-screen display in the illustrations and explanations. Available languages vary depending on the area where you purchased this camera.

1 Getting started

- 1 Open the lens barrier fully.
- 2 Press **OK** .
  - The top menu is displayed.
- 3 Press **▷** on the arrow pad to select **MODE MENU**.

Arrow pad (△▽◀▶)

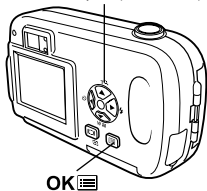

OK 

- 4 Press **△▽** to select the **SETUP** tab, then press **▷**.

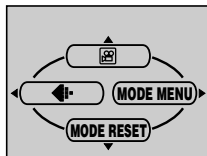

Top menu

SETUP tab



- 5 Press **△▽** to select  , then press **▷**.



6 Press  $\Delta$   $\nabla$  to select a language, then press OK .

7 Press OK  again to exit the menu.

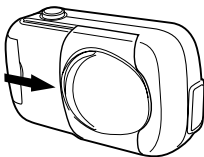

8 Close the lens barrier to turn the camera off.

**TIPS**

- The language can also be set from the playback mode.

# Setting the date and time



## 1 Getting started

1 Open the lens barrier fully.

2 Press OK .

- The top menu is displayed.

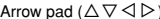

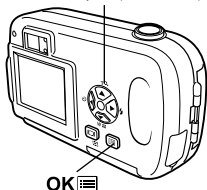
Arrow pad ()

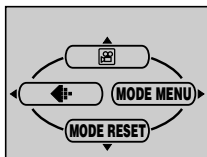

3 Press  on the arrow pad to select MODE MENU.



Top menu

4 Press  to select the SETUP tab, then press .

SETUP tab



5 Press  to select , then press .

- The green frame moves to the selected item.

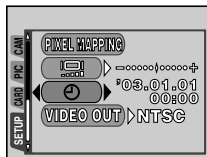

- 6** Press  $\Delta \nabla$  to select one of the following date formats: Y-M-D (Year/Month/Day), M-D-Y (Month/Day/Year), D-M-Y (Day/ Month/ Year). Then press  $\triangleright$ .

- Move to the year setting.
- The following steps show the procedure used when the date and time settings are set to Y-M-D.

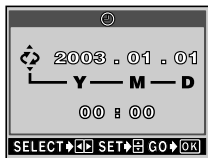

- 7** Press  $\Delta \nabla$  to set the year, then press  $\triangleright$  to move to the month setting.

- To move back to the previous setting, press  $\triangleleft$ .
- The first two digits of the year are fixed.

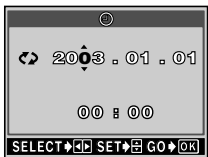

- 8** Repeat this procedure until the date and time are completely set.

- The camera only displays the time in the 24-hour time system. ("2 pm" would be "14:00".)

- 9** Press **OK**.

- For a more accurate setting, press **OK** when the time hits 00 seconds. The clock starts when you press the button.

- 10** Close the lens barrier to turn the camera off.

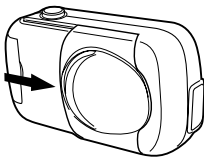

#### TIPS

- The date and time can also be set from the playback mode.



Note

- The current settings are retained even when the power is turned off.
- The date and time settings will be canceled if the camera is left without the battery for approximately 1 hour. The settings will be canceled more quickly if the battery was only loaded in the camera for a short time before being removed. Before taking important pictures, check that the date and time settings are correct.

# Holding the camera

When taking pictures, hold the camera firmly with both hands while keeping your elbows at your sides to prevent the camera from moving. When using a vertical grip, hold the camera so that the flash is higher than the lens.

## Taking pictures using the monitor

1  
Getting started

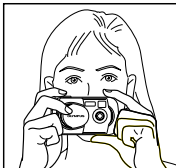

Be sure to hold the camera with both hands to stop it from moving. Keeping your elbows at your sides is very effective for this.

## Taking pictures using the viewfinder

Horizontal grip

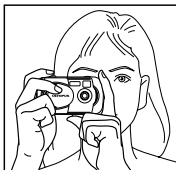

Vertical grip



Incorrect grip



Keep your fingers and the strap away from the lens and flash.



Note

- Clear pictures cannot be obtained if the camera moves as the shutter button is pressed. Hold the camera correctly, and press the shutter button gently.

## 2 Using the menus

### Menu items

When you turn on the camera and press **OK** , the top menu is displayed on the monitor. The functions of this camera are set from the menus. This chapter explains the types of menu items that this camera has and how they work, using shooting mode screens.

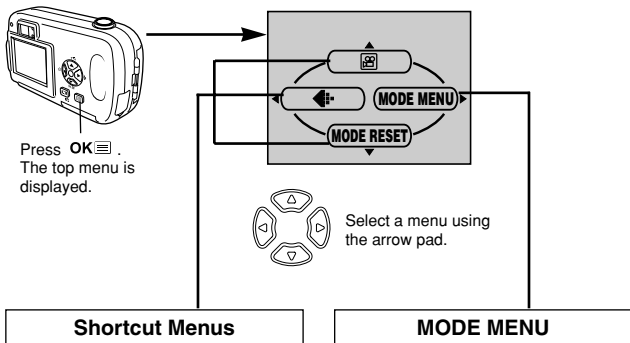

- Takes you directly to the setting screen.
- Display operational buttons at the bottom of the screen.

- Categorizes the settings into tabs.
- Displays the tabs of each menu. Select the desired tab on the left of the screen by pressing  $\Delta$   $\nabla$ .

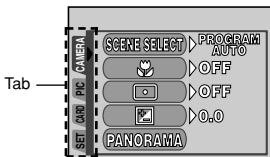
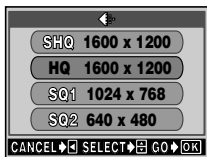

# How to use the mode menu

1 Press **OK**  to display the top menu. Press **▷**.

2 Press **△▽** to select a tab, then press **▷**.

Top menu

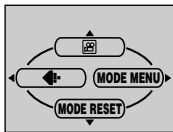

CAMERA tab

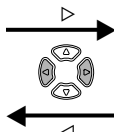

Press **◀** to return to the tab selection screen.

PICTURE tab

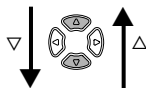

CARD tab

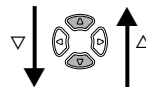

SETUP tab



2 Using the menus

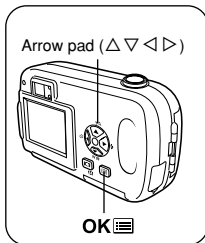

 Continued on next page

- 3 Press  $\Delta$ / $\nabla$  to select an item, then press  $\triangleright$ .

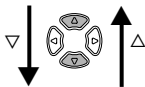
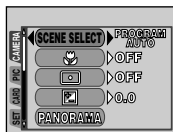

The green frame moves to the selected item.

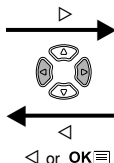

$\triangleleft$  or **OK**

To return to select an item, press  $\triangleleft$  or **OK** .

- 4 Press  $\Delta$ / $\nabla$  to select a setting. Press **OK** to complete setting. Press **OK** again to exit the menu and return to shooting.

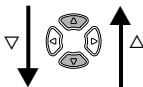
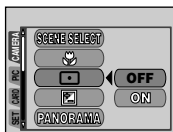

Note

- Items available for selection depends on the camera settings.
- You can take pictures while a menu is displayed in the shooting mode.
- If you want to save the settings after the camera is turned off, set ALL RESET to OFF. "ALL RESET - Saving the settings" (P. 84)



# Shortcut menus

## ●Shooting mode

Shortcut menus are frequently-used menus that can be accessed from the top menu.

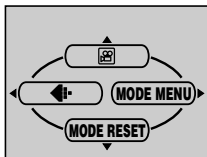

Still picture

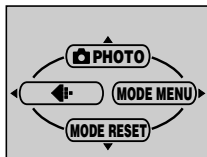

Movie



Records movies. This icon appears when the menu is displayed in the still picture shooting mode.

P. 46



A simple press of the shutter button gives you optimal exposure and focus for general photography. This icon appears when the menu is displayed in the movie recording mode.

P. 37



Sets the image quality and resolution.

Still picture : SHQ, HQ, SQ1, SQ2

Movie : HQ, SQ

P. 59

## MODE RESET

Restores functions (exposure compensation, white balance, etc.) to the factory default settings. MODE RESET is identical to the ALL RESET function included in the MODE MENU.

P. 84

## ●Playback mode

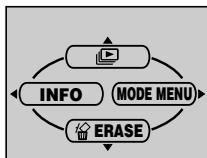

Still picture

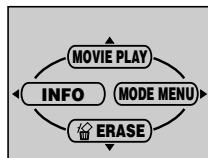

Movie



Runs through all saved pictures one after another as a slide show. This icon appears when the menu is displayed while a still picture is played back.

P. 71

### MOVIE PLAY

Plays back movies. This icon appears when the menu is displayed while a movie frame is played back.

P. 74

### INFO

Displays all the shooting information on the monitor.

P. 87



### ERASE

Erases the selected still picture or movie.

P. 77

# Mode menus

The MODE MENU is divided into tabs. Press  $\Delta$   $\nabla$  to select a tab and display the associated menu items.

## ● Shooting mode

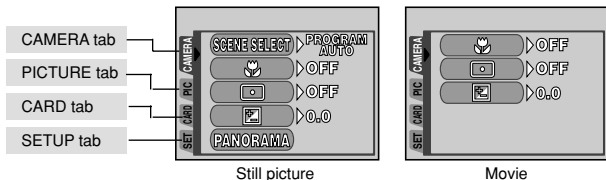





Still picture

Movie

CAMERA tab		
SCENE SELECT	Selects the shooting mode from PROGRAM AUTO (program auto),  (portrait),  (landscape),  (night scene) or  (self portrait).	P. 38
	Allows you to shoot as close as 20 cm (0.7 ft.) to your subject.	P. 52
	Meters light within the AF target mark to determine exposure.	P. 54
	Adjusts the brightness of the picture.	P. 63
PANORAMA	Allows panorama pictures to be taken with Olympus CAMEDIA-brand cards.	P. 55
2 IN 1	Combines two still pictures taken in succession and stores them as a single picture.	P. 57



PICTURE tab		
WB	Sets the appropriate white balance according to the light source.	P. 65

CARD tab		
CARD SETUP	Formats a card.	P. 85

SETUP tab		
ALL RESET	Selects whether to keep the current camera settings when you turn off the power.	P. 84
	Selects a language for on-screen display.	P. 24
	Turns the beep sound (used for warnings, etc.) on and off.	P. 89
REC VIEW	Selects whether to display pictures on the monitor while saving them to a card.	P. 88
FILE NAME	Chooses how to name files and folders of pictures.	P. 89
PIXEL MAPPING	Checks the CCD and image processing functions for errors.	P. 91
	Adjusts the brightness of the monitor.	P. 88
	Sets the date and time.	P. 26
VIDEO OUT	Selects NTSC or PAL according to your TV's video signal type. TV video signal types differ depending on the region.	P. 92

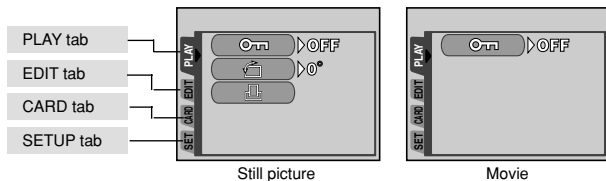



### ● Playback mode



PLAY tab		
	Protects pictures from accidental erasure.	P. 76
	Rotates pictures 90 degrees clockwise or counterclockwise.	P. 72
	Stores print reservation information on the card.	P. 93

EDIT tab		
BLACK&WHITE	Creates a black and white picture and saves it as a new picture.	P. 79
SEPIA	Creates a sepia-toned picture and saves it as a new picture.	P. 80
	Makes the file size smaller and saves it as a new picture.	P. 80
INDEX	Creates an index picture of a movie in 9 frames.	P. 82

CARD tab		
CARD SETUP	Formats the card, erasing all image data stored on it.	P. 23 P. 85

SETUP tab		
ALL RESET	Selects whether to keep the current camera settings when you turn off the power.	P. 84
	Selects a language for on-screen display.	P. 24
	Turns the beep sound (used for warnings, etc.) on and off.	P. 89
	Adjusts the brightness of the monitor.	P. 88
	Sets the date and time.	P. 26
VIDEO OUT	Selects NTSC or PAL according to your TV's video signal type. TV video signal types differ depending on the region.	P. 92
	Selects the number of frames in the index display.	P. 70

# 3 Shooting basics

## Shooting modes

This camera shoots still pictures and movies. In the still picture shooting mode, select a shooting mode from **PHOTO** (P/📷/🌄/🌃/🌃), depending on shooting conditions and the effect you want. The factory default setting is **P** (PROGRAM AUTO). You are able to shoot normally even if you do not select a shooting mode.

### ● 📷 **PHOTO Still picture shooting**

Lets you take still pictures. You can select a more specific shooting mode depending on the scenes you want to shoot.

### ● 🎥 **Movie recording**

Lets you record movies. You cannot record movies with sound. 🗨️  
"Recording movies" (P. 46)

### ■ **Still picture shooting modes**

#### **P PROGRAM AUTO (factory default setting)**

Used for regular photography. The camera automatically makes settings for natural color balance. Other functions, such as the flash mode, can be adjusted manually.

#### 👤 **Portrait shooting**

Suitable for taking a portrait-style shot of a person. The camera automatically sets the optimal shooting conditions.

#### 🌄 **Landscape shooting**

Suitable for taking photos of landscapes and other outdoor scenes. The camera automatically sets the optimal shooting conditions.

#### 🌃 **Night-Scene shooting**

Suitable for taking photos of landscapes and people in the evening or at night. The camera sets a slower shutter speed than is used in normal shooting. If you take a picture of a street at night in any other mode, the lack of brightness will result in a dark picture with the background underexposed and without details. In this mode, the true appearance of the street is captured. The camera automatically sets the optimal shooting conditions. We recommend that you set the flash mode to AUTO.



Normal shooting and flash on



Night-Scene shooting and flash on

### Self Portrait shooting

Enables you to take a picture of yourself while holding the camera. Point the lens towards yourself and the focus will be locked on you. The camera automatically sets the optimal shooting conditions.

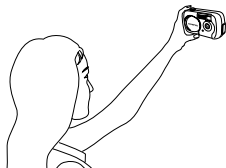

## Selecting shooting modes

### 3

#### Shooting basics

### 1 Open the lens barrier fully.

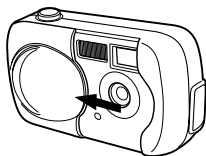

Arrow pad (△▽◀▶)

### 2 Press OK .

- The top menu is displayed.

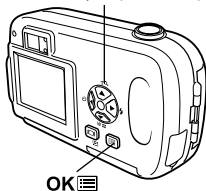





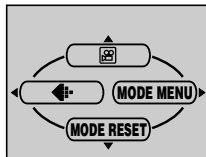

OK 

### 3 In the top menu, press ▶ to select MODE MENU.

- Movie recording: Press △ to select .



- 4 Press  $\Delta$ / $\nabla$  to select the **CAMERA** tab, then press  $\triangleright$ .
- 5 Press  $\Delta$ / $\nabla$  to select **SCENE SELECT**, then press  $\triangleright$ .
- 6 Press  $\Delta$ / $\nabla$  to select a mode from PROGRAM AUTO, , ,  or , then press **OK** .
  - Press **OK**  again to exit the menu.

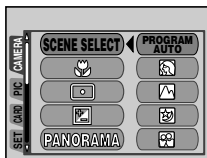

### TIPS

- Refer to “List of functions by shooting mode” (P.109) for details of the functions for each mode.



Note

- Digital zoom and panorama shooting are not available in Self-Portrait mode.



You can take still pictures using either the monitor or the viewfinder. Both methods are easy as all you have to do is to press the shutter button.

## Taking still pictures using the viewfinder

**1** Open the lens barrier fully.

Shutter button

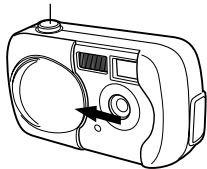

**2** Compose your picture while looking at the image in the viewfinder.

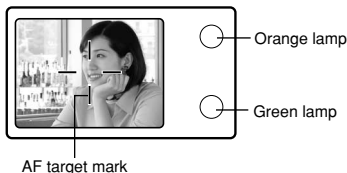

**3** Press the shutter button gently (halfway) to adjust the focus.

- When the focus and exposure are locked, the green lamp lights steadily. (focus lock)
- If the orange lamp lights, the flash fires automatically.

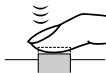

**4** Press the shutter button all the way (fully).

- The camera takes the picture, and a beep sounds.
- When the green lamp stops blinking, you can take the next picture.
- When the orange lamp starts blinking, the pictures are stored on the card.

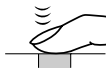

**TIPS**

**It is difficult to focus on the subject.**

→ "If correct focus cannot be obtained" (P. 44)

**The green lamp blinks.**

→ You are too close to the subject. Take the picture at least 50 cm/1.6 ft. away from the subject. When the distance from the camera to the subject is less than 50 cm/1.6 ft, select the macro mode.

"Macro mode shooting" (P. 52)

→ Depending on the subject, the focus may not be locked.

"Subjects that are difficult to focus on" (P. 45)

**The orange lamp blinks.**

→ If the shutter button is being pressed halfway, the flash is charging. Wait until the light turns off.

**To check the picture you have just taken immediately.**

→ Set REC VIEW to ON. "REC VIEW - Viewing a picture immediately after shooting" (P. 88)

**3**

Shooting basics

**Taking still pictures using the monitor****1 Open the lens barrier fully.**

• Slide the lens barrier fully open until it clicks.

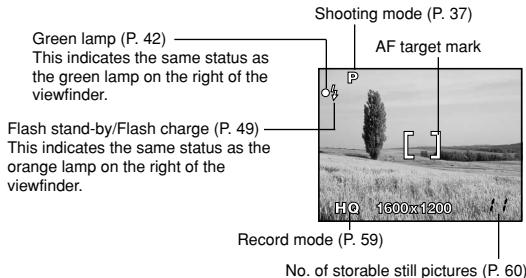
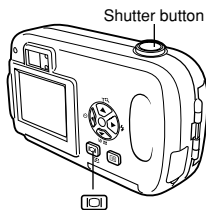
**2 Press to turn on the monitor.****3 Decide the composition of the picture while looking at the image on the monitor.**

- 4** Take a picture by following the same procedure as when shooting with the viewfinder.  "Taking still pictures using the viewfinder" (P. 40)



**TIPS** -----

**The green lamp blinks.**

→ You are too close to the subject. Take the picture at least 50 cm away from the subject. When the distance from the camera to the subject is less than 50 cm/1.6 ft, select the macro mode.

 "Macro mode shooting" (P. 52)

→ Depending on the subject, the focus may not be locked.

 "Subjects that are difficult to focus on" (P. 45)

**The monitor turns off automatically.**

→ If the camera is not used for approximately 3 minutes, the monitor turns off automatically. Touch the shutter button or arrow pad to turn the monitor on again.

**The monitor is hard to see.**

→ Bright light, such as direct sunlight, may cause vertical lines to appear on the monitor screen. In this case, use the viewfinder. This does not affect recorded pictures.



Note

- Press the shutter button gently using the ball of your finger. If it is pressed hard, the camera will move.
- Recorded pictures will be saved on the card regardless of whether the camera is turned off or the battery is changed or removed.
- Never open the card cover, remove the battery or disconnect the AC adapter while the orange lamp is blinking. Doing so could destroy stored pictures and prevent storage of the pictures you have just taken.
- When taking pictures against strong backlight, the area of the picture in shadow may appear colored.

## Comparison of the viewfinder & monitor

	Viewfinder	Monitor
Advantages	Camera movement does not occur easily and subjects can be seen clearly even in bright places. Little battery power is used.	You can check the picture area that the camera actually records more accurately.
Disadvantages	When close to a subject, the image in the viewfinder is a little different from the picture that the camera actually records.	Camera movement can occur easily and subjects may be difficult to see in bright/dark places. The monitor uses more battery power than the viewfinder.
Tips	Use the viewfinder for general snapshots (landscape pictures, casual shots, etc.).	Use the monitor when you want to shoot while checking the picture area that the camera actually records, or to take close-up shots of people, flowers, etc.

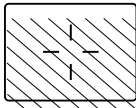

- The camera records a wider area than the image in the viewfinder.
- As you get closer to the subject, the actual image recorded becomes lower than the one in the viewfinder (see left).

# If correct focus cannot be obtained

If the subject is difficult to focus on, lock the focus before shooting as explained below. This is called focus lock.

## How to lock the focus

**1** Open the lens barrier fully.

**2** Position the AF target mark on the subject you want to focus on.

- When shooting a hard-to-focus subject, point the camera at an object about the same distance away as the subject.

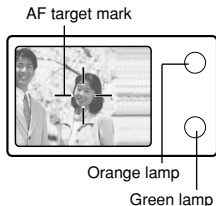

**3** Press the shutter button halfway.

- When the focus and exposure are locked, the green lamp lights.
- When the green lamp blinks, the focus is not locked. Release your finger from the shutter button, re-position your subject and press the shutter button halfway again.

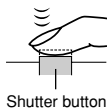

**4** Keeping the shutter button pressed halfway, recompose your shot.



**5** Press the shutter button fully.

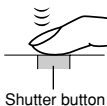

**TIPS****The green lamp blinks.**

→ You are too close to the subject. Take the picture at least 50 cm away from the subject. When the distance from the camera to the subject is less than 50 cm/1.6 ft, select the macro mode.

☞ "Macro mode shooting" (P. 52)

→ Depending on the subject, the focus may not be locked.

☞ "Subjects that are difficult to focus on" (See below.)

**Subjects that are difficult to focus on**

Under certain types of conditions, the auto focus may not work properly. If this happens, focus on an object with high contrast at the same distance as the intended subject (focus lock), recompose your shot and then take the picture. If the subject has no vertical lines, hold the camera vertically and focus the camera using the focus lock function by pressing the shutter button halfway, then return the camera to the horizontal position while keeping the button pressed halfway and take the picture.

The green lamp blinks. The subject cannot be brought into focus.

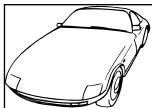

Subject with low contrast



Subject with an extremely bright area in the center of the frame

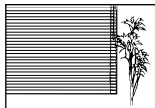

Subject without vertical lines

The green lamp lights, but the subject cannot be brought into focus.

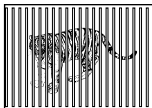

Subjects at different distances

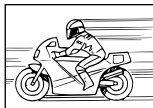

Fast-moving subject



The subject to be focused on is not in the center of the frame





You can record movies with this camera. Recorded movies can be played back or stored as the other still pictures using the index function.

**1 Open the lens barrier fully.**

**2 Press OK** .

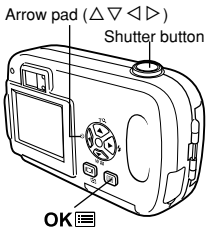
- The top menu is displayed.



**3 Press  $\Delta$  to select** .

- Movie recording is set and the camera returns to the shooting mode.
- The  mark and the total recordable time depending on the card memory capacity are displayed on the monitor.

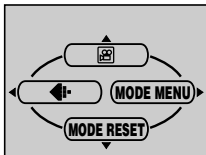

**4 Decide the composition while looking at the image on the monitor.**

**5 Press the shutter button halfway.**

- The focus is locked.

**6 Press the shutter button fully to start recording.**

- The orange lamp on the right of the viewfinder lights.
- The camera always sets the best exposure, even if the subject moves.
- During movie recording,  lights red and the time you can shoot is displayed.





**7 Press the shutter button again to stop recording.**

- The orange lamp blinks while the movie is stored on the card.
- When the remaining recording time has been used up, recording stops automatically.



Note

- Digital zoom does not work in the  (movie) mode.
- The camera enters the still picture shooting mode when the lens barrier is closed.  “ALL RESET - Saving the settings” (P. 84)
- During movie recording, the flash is disabled.
- It takes longer to store movies than still pictures.
- The seconds remaining varies depending on the record mode and the amount of space available on the card.
- You cannot record movies with sound.



# Zoom (Digital zoom)

You can enlarge your subject when shooting by 1.3, 1.6, 2.0 or 2.5 times.

## 1 Open the lens barrier fully.

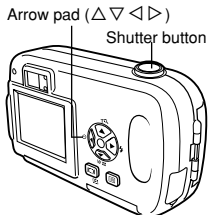
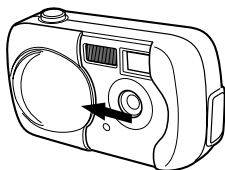

## 2 Press Δ.

- The monitor turns on and the zoom bar appears. The subject is magnified by 1.3 times.



The cursor moves on the zoom indicator according to the zoom magnification.

## 3 Press Δ ∇ while looking at the image on the monitor.

- Each time you press Δ, the zoom magnification changes in the following sequence:  
1 time → 1.3 times → 1.6 times → 2.0 times → 2.5 times.
- Each time you press ∇, the zoom magnification changes in the following sequence:  
2.5 times → 2.0 times → 1.6 times → 1.3 times → 1 time.
- The zoom magnification changes continuously while holding down Δ or ∇.

## 4 Take the picture.



- Pictures taken with the digital zoom may appear grainy.
  - Camera movement is likely to occur at higher magnifications.
- Note
- Turning the monitor off cancels the digital zoom.

# Using the flash



Select the flash mode best suited to the light conditions and the effect you want to achieve.

## 1 Open the lens barrier fully.

## 2 Press $\blacktriangleright$ (⚡).

- The monitor turns on.
- The current flash setting is displayed.

## 3 Press $\blacktriangleright$ again to set the flash mode.

- Each time you press  $\blacktriangleright$ , the flash mode changes in the following sequence:  
"AUTO" – "👁️ Red-eye reduction" – "⚡ Fill-in flash" – "🚫 Flash off".

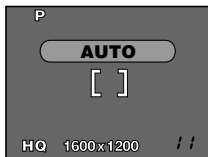
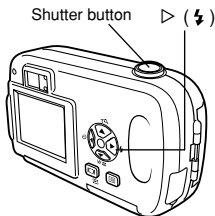

## 4 Press the shutter button halfway.

- When the flash fires, the orange lamp lights steady.

## 5 Press the shutter button fully to take the picture.

**Flash working range: 0.2 - 3.3 m (0.7 - 10.8 ft)**



### TIPS

**The orange lamp blinks.**

→ The flash is charging. Wait until the lamp goes off.



Note

- The flash does not fire in the movie record mode or during Panorama shooting.

3

Shooting basics

### ● **Auto-flash (No indication)**

The flash fires automatically in low light or backlight conditions.

To shoot a subject with backlight, position the AF target mark over the subject.

### ● **Red-eye reduction flash (👁)**

The light from the flash may make the subject's eyes appear red in the picture. The red-eye reduction flash mode reduces this phenomenon by emitting pre-flashes before firing the regular flash. This helps accustom the subject's eyes to the bright light and minimizes the red-eye phenomenon.



The subject's eyes appear red.



Note

- After the pre-flash, it takes about 1 second before the shutter is released. Hold the camera firmly to avoid camera movement.
- Effectiveness may be limited if the subject is not looking directly at the pre-flashes, or if the shooting range is too far. Individual physical characteristics may also limit effectiveness.

### ● **Fill-in flash (⚡)**

The flash fires regardless of the available light. This mode is useful for eliminating shadows on the subject's face (such as shadows from tree leaves), in a backlight situation, or for correcting the color shift produced by artificial lighting (especially fluorescent light).



Note

- The fill-in flash may not have the desired effect under excessively bright light.

## ● Flash off (🚫)

The flash does not fire even in low light conditions. Use this mode in situations where flash photography is not desired or is prohibited, such as in an art museum. You can also use this mode when you want to shoot a natural-looking twilight or night scene.



Note

- Since a slow shutter speed is automatically selected in low light situations when in the flash off mode, the use of a tripod is recommended to prevent your pictures from being blurred by camera movement.

## 4 Advanced shooting

### Macro mode shooting



The macro mode allows you to shoot at a distance of 20 cm to 50 cm (0.7 ft. to 1.6 ft.) from your subject.

You can also shoot subjects which are at a distance of over 50 cm (1.6 ft.). However, compared to shots between 20 cm and 50 cm, the camera may take more time to focus on the subject.





Normal shooting



With the macro mode

4

Advanced shooting

- 1 Open the lens barrier fully.
- 2 In the shooting mode top menu, select **MODE MENU** → **CAMERA** →  → **ON**, and press **OK** .

 "How to use the mode menu" (P. 30)

- Press **OK**  again to exit the menu.

- 3 Take the picture while viewing the monitor.

Arrow pad (△▽◀▶)



Note

- If you are close to a subject, the picture in the viewfinder is different from the area that the camera actually records. For macro mode shooting, we recommend using the monitor.
- If you use the flash in macro shooting, shadows may be conspicuous and the correct exposure may not be achieved. Check the recorded image on the monitor.



This function lets you take pictures using the self-timer. Fix the camera securely on a tripod or set it on a level surface for self-timer shooting. This function is useful for taking pictures where you want to be included in the photograph.

**1** Open the lens barrier fully.

**2** Press  $\triangleleft$  (☺).

- The monitor turns on.

**3** Press  $\triangleleft$  again to set the self-timer mode.

- The setting changes between ☺ OFF and ☺ ON each time  $\triangleleft$  is pressed. When the self-timer mode is selected, ☺ is displayed on the monitor.

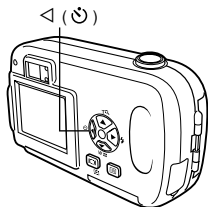

Self-timer mark

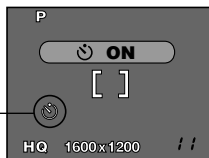

**4** Take the picture. Press the shutter button to start the timer and take the picture.

- The self-timer lamp lights for approximately 10 seconds, then starts blinking. After blinking for approximately 2 seconds, the picture is taken.
- The self-timer mode is automatically canceled after one shot.

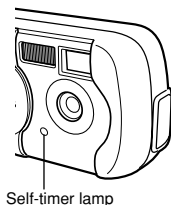

**4**

Advanced shooting

## Selecting the metering area (Spot metering)



In a backlight situation, your subject may appear dark if the picture is taken with the normal metering value (center-weighted average light metering). In this case, by changing the metering area to the center of the viewfinder (spot metering), a subject can be shot with optimal exposure regardless of the background light.

OFF:



Meters the entire viewfinder to obtain the optimum exposure. (No indication is displayed on the monitor.)

ON (spot metering):

Meters only the center of the viewfinder to obtain the appropriate exposure for a subject there.

### 4

### Advanced shooting

- 1 In the shooting mode top menu, select MODE MENU → CAMERA →  → ON, and press OK .**

 "How to use the mode menu" (P. 30)

- Press OK  again to exit the menu.

- 2 Take the picture.**

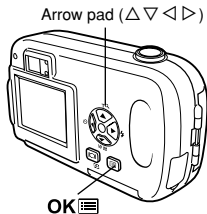

# PANORAMA - Panorama shooting

You can take advantage of panorama shooting with the Olympus xD-Picture Card. Panorama shooting lets you connect pictures with overlapping edges into a single panoramic picture, using the CAMELIA Master software contained on the CD-ROM provided.

- 1** In the shooting mode top menu, select **MODE MENU** → **CAMERA** → **PANORAMA**, and press **▷**.

 "How to use the mode menu" (P. 30)

- The monitor turns on.
- The PANORAMA mode is set.

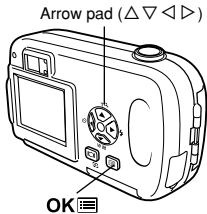

- 2** On the monitor, use the arrow pad to choose the direction you want the pictures connected.

- ▷ : Connects the pictures from left to right.
- ◁ : Connects the pictures from right to left.
- △ : Connects the pictures from bottom to top.
- ▽ : Connects the pictures from top to bottom.

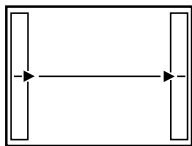

Connects pictures from left to right.

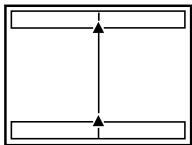

Connects pictures from bottom to top.

4

Advanced shooting



### 3 Make sure that the edges of the pictures overlap, then take your pictures.

- Focus, exposure and white balance are set by the first picture. Do not select an extremely bright subject (such as the sun) for the first picture.
- Panorama shooting is possible for up to 10 pictures.

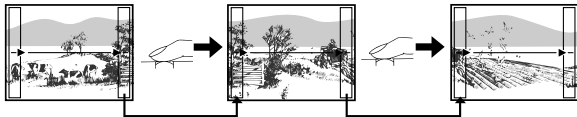

When shooting, make sure that the edges (right/left/top/bottom) of the images overlap, so that the CAMEDIA Master software can correctly connect the pictures.

- When you have taken 10 pictures, a warning mark is displayed.

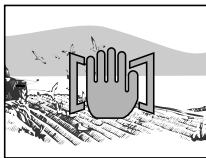

### 4 Press OK to finish panorama shooting.

- The frame on the screen disappears and the camera returns to the normal shooting mode.





- The panorama mode is only available with Olympus xD-Picture Card.
- Note
- Your computer's memory may be insufficient if you take too many panorama pictures in HQ or SHQ mode. You are recommended to use SQ1/SQ2 mode for panorama shooting.
  - During panorama shooting, the flash is not available.
  - The camera itself cannot connect panorama pictures. The CAMEDIA Master software is necessary to connect the pictures.

This function allows you to combine two pictures taken in succession and store them as a single picture. You can combine two different subjects in one picture.







Picture when played back

- 1 In the shooting mode top menu, select MODE MENU → CAMERA → 2 IN 1, and press .**

 "How to use the mode menu" (P. 30)

- The monitor turns on.
- The two-in-one picture mode is set.

Arrow pad (   )



- 2 Take the first shot while observing your subject on the monitor.**

- The subject will be positioned on the left in the combined picture.

- 3 Take the second shot.**

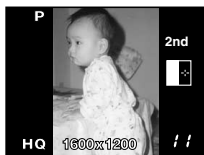
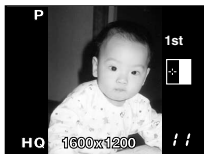

- The subject will be positioned on the right in the combined picture.
- The first and second shots are saved as a single picture.



Picture when shooting



Note

- When the battery power is exhausted (  blinks), the flash automatically turns off.
- The two-in-one picture mode is canceled when **OK**  is pressed or the lens barrier is closed. Press **OK**  to cancel the two-in-one picture mode after the first shot has been taken. The first picture will not be stored.

## 4

### Advanced shooting

# Changing the record mode



You can select a record mode in which to take pictures or shoot movies. Choose the best record mode for your purposes (printing, editing on a PC, website editing, etc.). For details of the different record modes, resolutions and number of pictures storable on the card, refer to the table on the next page.

Record mode	Description	Quality	File size
SHQ	<ul style="list-style-type: none"><li>• A high quality mode.</li><li>• Fewer images can be saved to a card.</li><li>• Takes longer to store the images.</li></ul> <p>Uses</p> <ul style="list-style-type: none"><li>• Good for printing.</li><li>• Can be enlarged to A4 (210mm × 297mm / 8.3" × 11.7") size.</li><li>• Good for processing on a PC.</li></ul>	Clearer ↑ ↓ Normal	Larger ↑ ↓ Smaller
	HQ		
SQ1/SQ2	<ul style="list-style-type: none"><li>• The resolutions are smaller than in SHQ or HQ.</li><li>• A standard quality mode.</li><li>• More images can be saved to a card.</li></ul> <p>Uses</p> <ul style="list-style-type: none"><li>• Attaching images to e-mail or simply viewing them on a PC.</li></ul>		

**Still picture record modes**

Record mode	Resolution (No. of pixels)	Memory capacity in number of shots (using a 16 MB card)
SHQ	1600 x 1200	11
HQ		32
SQ1	1024 x 768	76
SQ2	640 x 480	165

**Movie record modes**

Record mode	Resolution (Frames per second)	Memory capacity in seconds per movie
HQ	320 x 240 (15 frames/sec)	15 seconds
SQ	160 x 120 (15 frames/sec)	60 seconds

**4****Advanced shooting**

- In the  mode, the total recording time is displayed on-screen. Total recording time depends on the memory capacity of the card.

**Note**

- The card memory capacity listed in the table is approximate.
- The number of remaining pictures may change according to the subject or factors like whether print reservations have been made or not. In certain instances, the number of remaining pictures displayed on the monitor may not change even when a picture is taken or a stored image is erased.

- 1** In the shooting mode top menu, press  $\triangleleft$  to select  $\blacktriangleleft$  (P. 29).

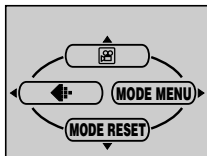
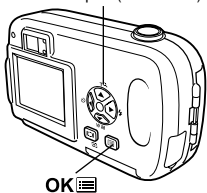
Arrow pad ( $\triangle \nabla \triangleleft \triangleright$ )

- 2** Press  $\triangle \nabla$  to select the desired record mode.

- For still pictures, you can choose from SHQ, HQ, SQ1 and SQ2.

- For movies, you can choose HQ or SQ.

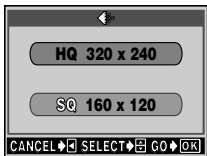
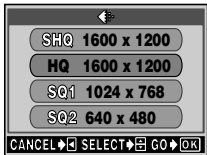

- 3** Press OK  $\equiv$ .

- Press OK  $\equiv$  again to exit the menu.

4

Advanced shooting



## TIPS

- **Resolution**

The number of pixels (horizontal x vertical) used when saving an image. If the image will be printed, higher resolutions (larger numbers) are recommended so that the image will be clearer. However, higher resolutions make the file size (amount of data) larger, so the number of pictures that can be saved will be fewer.

- **Pixels**

A pixel is the smallest unit (dot) used to make up an image. Clear large-sized printed images require millions of pixels.



- **Resolution and picture size on a computer screen**

When a picture is transferred to a computer, the size of the picture on the computer screen varies depending on the computer's monitor setting. For instance, a picture taken in  $1024 \times 768$  resolution is the same size as the screen if you set the picture to  $1 \times$  when the monitor setting is  $1024 \times 768$ . However, if the monitor setting is over  $1024 \times 768$  (such as  $1280 \times 1024$ ), the picture only takes up part of the screen.

## Varying the image brightness (Exposure compensation)





In some situations, you may get better results when the exposure that the camera sets is compensated (adjusted) manually. You can adjust the brightness in the range of  $\pm 2.0$  in  $1/2$  steps.

- 1** In the shooting mode top menu, select **MODE MENU** → **CAMERA** → , then press .

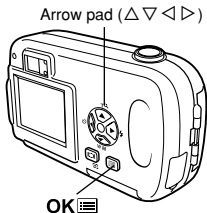
 "How to use the mode menu" (P. 30)



- 2** Press   to select the exposure compensation value.

- Select a [ + ] value to brighten the image or a [ - ] value to darken the image.

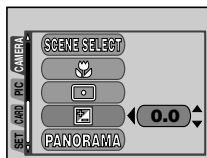

-2.0



0.0



+2.0

- 3** Press **OK** .

- Press **OK**  again to exit the menu.

- 4** Take the picture.

4

Advanced shooting





### TIPS

- Often bright subjects (such as snow) will turn out darker than their natural colors. Adjusting toward + makes these subjects closer to their real shades. For the same reason, adjust toward – when shooting dark subjects.



### Note

- If the flash is used, the image brightness (exposure) may differ from the intended brightness (exposure).
- Exposure compensation cannot correct the image if the surroundings of the subject are extremely bright or dark.

Color reproduction differs depending on the light conditions. For instance, when daylight, the setting sun or tungsten lighting are reflected on white paper, the shade of white produced will be slightly different for each. By setting the WB (white balance), you can achieve more natural-looking colors.

- 1** In the shooting mode top menu, select **MODE MENU** → **PICTURE** → **WB** → **AUTO**, ☀, ☁, 🔦 or 📺.

☞ "How to use the mode menu" (P. 30)

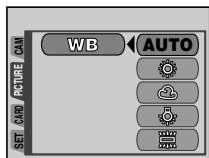
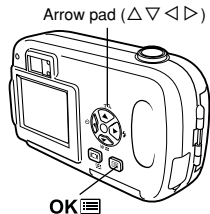

- AUTO (No indication)** : The white balance is adjusted automatically so that colors look natural irrespective of the light source.
- ☀ (**Sunlight**) : For natural colors under a clear sky.
- ☁ (**Overcast**) : For natural colors under a cloudy sky.
- 🔦 (**Tungsten**) : For natural colors under tungsten lighting.
- 📺 (**Fluorescent**) : For natural colors under fluorescent lighting.

- 2** Press **OK** .

  - Press **OK**  again to exit the menu.

- 3** Take the picture.



Note

- White balance may not be effective under some special light sources.
- After setting a white balance mode other than AUTO, play back the picture and check the colors on the monitor.
- When the flash is fired with a white balance setting other than AUTO, colors may appear different in the resulting picture from the colors you see on the monitor.

# 5 Playback

## Viewing still pictures



### 1 Press with the lens barrier closed.

- The monitor turns on and displays the last picture taken. (Single-frame playback)

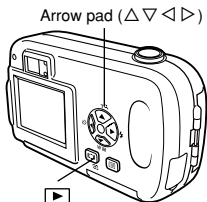

### 2 Use the arrow pad to play back other pictures.

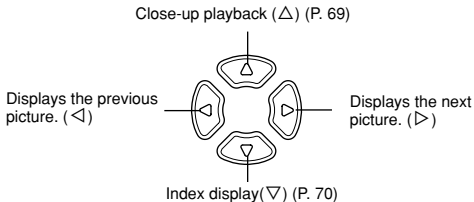

### 3 Press to cancel playback.

- The monitor and camera turn off.



Note

- If the camera is not used for over 3 minutes, it turns off automatically.

## QUICK VIEW

This function lets you play back pictures while the camera is in the shooting mode. This is useful when you want to check shooting results and resume shooting quickly. Every function also can be used like normal playback.

**1 Press  twice quickly (double-click) while in the shooting mode.**

- The camera immediately enters the playback mode and displays the last picture taken. (Single-frame playback)

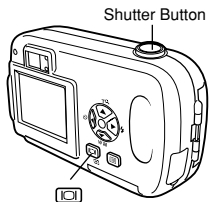

**2 Press the shutter button halfway to return to the shooting mode.**

- The camera returns to shooting mode, and is ready to take pictures.
- If the shutter button is pressed all the way, a picture will be taken.



## Close-up playback

Pictures displayed on the monitor can be enlarged in steps up to 4 times the original size.

### 1 Use the arrow pad ( ) to display the still picture you want to enlarge.

- You cannot enlarge pictures with .

### 2 Press .

- The picture is enlarged.
- Each time you press , the picture is enlarged by the following magnifications: 1.5 X → 2 X → 2.5 X → 3 X → 3.5 X → 4.0 X.
- To return to the original size (1 X), press .

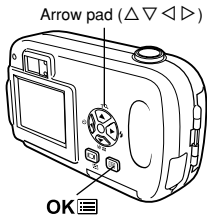

### 3 Press **OK** when the picture is enlarged. The screen enters the scroll mode. By pressing the arrow pad, you can shift the picture in the up, down, left or right direction. To exit the scroll mode, press **OK** again.

### 4 After you exit the scroll mode, press to return to the original size (1 X).

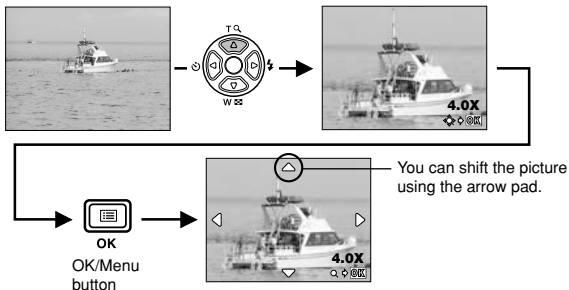





- Pictures cannot be stored in an enlarged state.

## Index display

This function lets you show several pictures at the same time on the monitor. The number of pictures shown can be 4, 9 or 16.

- 1** In the single-frame playback mode, press .

Arrow pad (   )



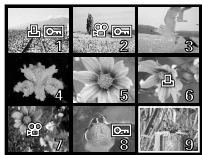

- Use the arrow pad to select the picture.
- ◀ : Moves to the previous frame.
- ▶ : Moves to the next frame.
- To return to single-frame playback, press .





### ● Selecting the number of pictures

This function lets you select the number of pictures in an index display from 4, 9 and 16.

- 1** In the playback mode top menu, select **MODE MENU** → **SETUP** → , and press .

 "How to use the mode menu" (P. 30)

- 2** Press   to choose the number of pictures (4, 9 or 16), then press **OK** .

- Press **OK**  again to exit the menu.

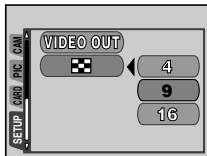



## Slideshow

This function displays still pictures stored on the card one after another. Only the first frame of movies is played back.

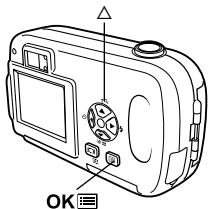
- 1 Display a still picture, then press **OK**  to display the top menu.



- 2 Press **△** () to start the slideshow.

- 3 Press **OK**  to stop the slideshow.

- The slideshow will not stop until you cancel it by pressing **OK** .

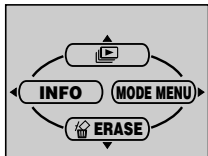

5

Playback





Note

- You are recommended to use the optional AC adapter when running a slideshow for a long period of time. If the battery is used, the camera will stop the slideshow after about 30 minutes and turn off.



## Picture Rotation

Pictures taken with the camera held vertically are displayed horizontally. This function lets you turn such pictures 90 degrees clockwise or counterclockwise so that they are displayed vertically.

**1** In the playback mode top menu, select **MODE MENU** → **PLAY** → , and press .

**2** Press   and select **0°**, **+90°** or **-90°**.

- The picture is rotated and saved that way.
- To close the menu, press **OK**  twice.

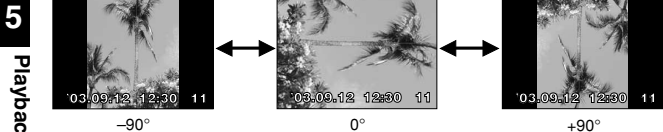
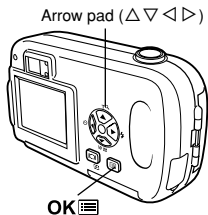

Note

- The following pictures cannot be rotated.  
Movies, protected pictures, pictures edited on a PC, pictures taken with another camera.
- New picture orientations are saved even when the camera is turned off.

# Playback on a TV

Use the Video cable provided with the camera to play back recorded images on your TV.

- 1 Make sure that the camera and the TV are turned off.**  
**Connect the Video cable to the VIDEO OUT jack on the camera and the video input terminal on the TV.**

Connect to the TV's video input (yellow) terminal.

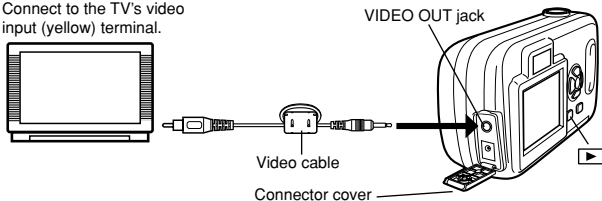

- 2 Turn the TV on and switch to the video input mode.**
  - For details of switching to video input, refer to your TV's instruction manual.
- 3 Press .**
  - The last picture taken is displayed on the TV. Use the arrow pad to select the picture you want to display.
  - The close-up playback, index display and slideshow functions can also be used on a TV screen.



## TIPS

- You are recommended to use the optional AC adapter when using the camera with a TV.



## Note

- Make sure that the camera's video output signal type is the same as the TV's video signal type.  "VIDEO OUT - Video output selection" (P. 92)
- The camera's monitor turns off automatically when the Video cable is connected to the camera.
- Be sure to use the Video cable provided to connect the camera to the TV.
- The picture may appear off-center on the TV screen.
- When pictures are compressed in order to fit the entire picture on the TV screen, a black frame may appear around the picture. If the picture is output to a video printer via the TV, the black frame may be printed.
- When images are played back on a PAL-system TV, their size on the screen will be smaller.



- 1** Press with the lens barrier closed.

• The monitor turns on.

- 2** Use the arrow pad to display the picture with .

"Viewing still pictures" (P. 67)

Arrow pad ( )

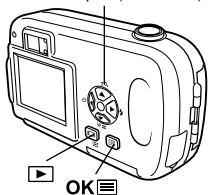

mark



- 3** Press OK .

• The top menu is displayed.

- 4** Press to select MOVIE PLAY.



**5**

Playback

## 5 Press $\Delta$ / $\nabla$ to select **PLAYBACK**, then press **OK**.

- The movie is played back.
- After playback, the menu is displayed.

**PLAYBACK** : Plays back the entire movie again.

### **FRAME BY**

**FRAME** : Plays back the movie manually one frame at a time.

**EXIT** : Leaves the movie playback mode.

Press  $\Delta$ / $\nabla$  to select from **PLAYBACK**, **FRAME BY FRAME** or **EXIT**, then press **OK**.



### ●When **FRAME BY FRAME** is selected

- $\Delta$  : Displays the first frame of the movie.
- $\nabla$  : Displays the last frame of the movie.
- $\triangleright$  : Displays the next frame. The movie can be displayed continuously by holding the button down.
- $\triangleleft$  : Displays the previous frame. The movie can be displayed continuously in reverse by holding the button down.
- OK** : Displays the **MOVIE PLAY** menu.



### TIPS

- Movies can also be played back in the shooting mode using **QUICK VIEW**.  $\leftarrow$  "QUICK VIEW" (P. 68)



Note

- When playing back a movie, the access time will vary depending on the length and record mode of the movie.

You are recommended to protect important pictures to avoid accidentally erasing them. Protected pictures cannot be erased by the single-frame/all-frame erase function.

- 1 Press with the lens barrier closed.**
  - The monitor turns on.
- 2 Use the arrow pad to display the picture you want to protect.**
  - ☞ "Viewing still pictures" (P. 67)
- 3 Press .**
  - The top menu is displayed.
- 4 In the top menu, select MODE MENU → PLAY → , and press .**
  - ☞ "How to use the mode menu" (P. 30)
- 5 Press to select ON, then press .**
  - To cancel protection, select OFF.

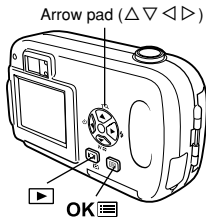

Displayed when a picture is protected.



Note

- Protected pictures cannot be erased by the single-frame/all-frame erase function, but they are all erased by formatting.



Recorded pictures can be erased. There are two types of erase: Single-frame erase, which erases only the picture that is displayed on the monitor, and all-frame erase, which erases all the pictures on the card.



- You cannot erase pictures that are protected. Cancel the protection before erasing such pictures.
- Note
- Once erased, pictures cannot be restored. Check each picture before erasing to avoid accidentally erasing pictures you want to keep. "Protecting pictures" (P. 76)

## Single-frame erase

This function erases the picture that is displayed on the monitor.

- 1 Press .**
  - The monitor turns on.
- 2 Use the arrow pad to display the picture you want to erase.**  
 "Viewing still pictures" (P. 67)
- 3 Press OK .**
  - The top menu is displayed.
- 4 Press to select .**
- 5 Press to select YES, then press OK .**
  - The picture is erased and the menu is closed.

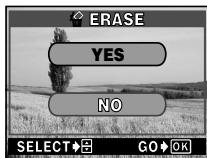
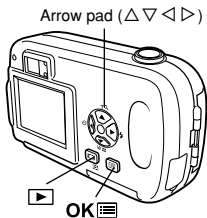





## All-frame erase

This function erases all the pictures on the card.

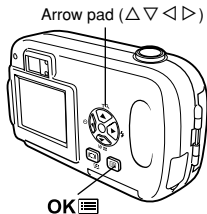

- 1 In the playback mode top menu, select MODE MENU → CARD → CARD SETUP, and press .**

 "How to use the mode menu" (P. 30)

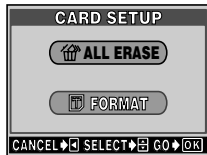

- 2 Press  to select  ALL ERASE, then press OK .**



- 3 Press  to select YES, then press OK .**

- All the pictures are erased. Protected pictures are not erased.



# Editing still pictures

This function lets you edit still pictures and store them as new pictures. The following editing operations are possible.

**BLACK&WHITE** : Converts pictures into black and white pictures and stores them as new pictures.

**SEPIA** : Converts pictures into sepia-toned pictures and stores them as new pictures.

 : Changes the picture size to 640 x 480 or 320 x 240 and stores the picture as a new picture.

**1** Press  with the lens barrier closed.

- The monitor turns on.

**2** Use the arrow pad to display the still picture you want to edit.

- ☞ "Viewing still pictures" (P. 67)

**3** Press **OK** .

- The top menu is displayed.

**4** In the top menu, select **MODE MENU** → **EDIT**, then choose each item.

- ☞ "How to use the mode menu" (P. 30)

- Select **BLACK&WHITE** (See below).
- Select **SEPIA** ☞ P. 80
- Select  ☞ P. 80

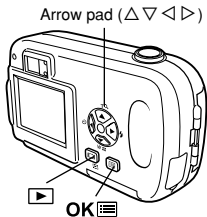

5

Playback

## Creating black and white pictures

**5** Select **BLACK&WHITE**, then press .

**6** Press   to select **BLACK&WHITE**, then press **OK** .

- The **BUSY** bar is displayed, then the camera returns to the playback mode. The black and white picture is stored as a separate picture from the original.
- To cancel the editing, select **CANCEL** and press **OK** .







Note

- You cannot create black and white movies.
- You cannot create a black and white picture if there is insufficient memory space on the card.

## Creating sepia-toned pictures

**5** Select **SEPIA**, then press  $\triangleright$ .

**6** Press  $\triangle \nabla$  to select **SEPIA**, then press **OK** .

- The BUSY bar is displayed, then the camera returns to the playback mode. The sepia-toned picture is stored as a separate picture from the original.
- To cancel the editing, select **CANCEL** and press **OK** .





Note

- You cannot create sepia-toned movies.
- You cannot create a sepia-toned picture if there is insufficient memory space on the card.

## Resizing pictures

**5** Select , then press  $\triangleright$ .

**6** Press  $\triangle \nabla$  to select the new picture size, then press **OK** .

- The BUSY bar is displayed, then the camera returns to the playback mode. The newly created picture is stored as a separate picture from the original.
- To cancel the resizing, select **CANCEL**, and press **OK** .

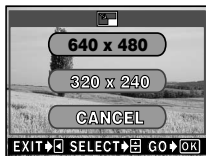



Note

- Resizing is not possible in the following cases.  
Movies, pictures edited on a PC, or when there is insufficient memory space on the card.
- If the size of a picture is 640 x 480 or smaller, you cannot select 640 x 480.
- If the size of a picture is 320 x 240, you cannot select  .

# INDEX - Creating an index

9 frames extracted from the recorded movie are displayed as an index to show the movie at one glance. Indexes can be stored on the card as still pictures.

- 1 Use the arrow pad to select a picture with .

Arrow pad ( $\Delta \nabla \triangleleft \triangleright$ )

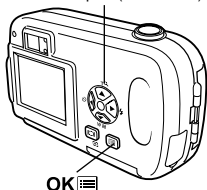

- 2 In the top menu, select **MODE MENU** → **EDIT** → **INDEX**, then press  $\triangleright$ .  
 "How to use the mode menu" (P. 30)

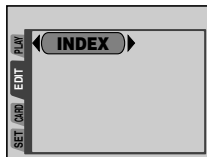

- 3 Press  $\Delta \nabla \triangleleft \triangleright$  to select the first frame for the index, then press **OK** .

Elapsed time/Total time



First-frame selection screen

- 4 Press  $\Delta \nabla \triangleleft \triangleright$  to select the last frame for the index, then press **OK** .





Last-frame selection screen

## 5 Press $\Delta$ / $\nabla$ to select OK, then press

**OK** .

- The 9 frames extracted from the movie appear as an index display, then the camera returns to the playback mode. The index is stored as a new picture.

**RESET** : If you want to choose different frames, select RESET, press **OK** , and then repeat from step 3.

**CANCEL** : To cancel your selections, select CANCEL and press **OK** .

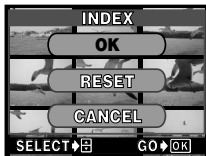

### TIPS

- The index is stored as a still picture in a different record mode from the original movie.

Record mode when the movie was shot	Record mode when stored as an index
HQ	SQ1 (1024 x 768 pixels)
SQ	SQ2 (640 x 480 pixels)



Note





- The interval between the frames that are automatically picked out varies depending on the length of the movie.
- An index consists of 9 frames.
- You cannot create an index if there is insufficient memory space on the card.

5

Playback

## 6 Useful functions

### MODE RESET - Restoring the factory default settings

This function lets you restore functions (exposure compensation, white balance, etc.) to the factory default settings. When MODE RESET is set in the  (movie) mode, the camera returns to the  **PHOTO** (still picture shooting) mode. The following settings are not reset: Settings in the MODE MENU's SETUP tab (ALL RESET, , REC VIEW, , etc.)

**1** In the shooting mode top menu, press  to select **MODE RESET** (P. 29).

**2** Press   to select **ALL RESET**, then press **OK** .

• Press **OK**  again to exit the menu.

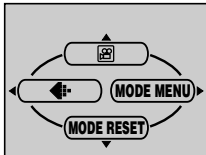

### ALL RESET - Saving the settings

This function lets you choose whether or not to save the current camera settings after the power is turned off. The settings affected by ALL RESET are listed on next page.

ALL RESET is available in both the shooting mode and playback mode.

**ON** : All settings are returned to the factory default settings after the power is turned off.

Example: If ALL RESET is ON, even if the  setting is SQ1 when the camera is turned off, it will be at HQ when the camera is turned on again.

**OFF** : The settings made before the power is turned off are saved.

The ALL RESET setting (ON/OFF) applies to all the modes. If ALL RESET is set to OFF in one shooting mode, this setting applies to all other shooting modes, as well as the playback and  modes.

ALL RESET does not affect items included in the MODE MENU's SETUP tab even when set to ON.

**1** In the top menu, select **MODE MENU** → **SETUP** → **ALL RESET** → **OFF** or **ON**, and press **OK** .

 "How to use the mode menu" (P. 30)

• Press **OK**  again to exit the menu.

## ●Settings that ALL RESET returns to their factory default settings

Function	Factory default setting	Ref. page
Monitor	OFF	P. 41
Shooting mode	PHOTO (still picture shooting mode)	P. 37
SCENE SELECT	P (Program auto)	P. 37
Digital zoom	1X	P. 48
FLASH	AUTO	P. 49
	0.0	P. 63
WB	AUTO	P. 65
	HQ	P. 59
	OFF	P. 52
	OFF	P. 54

## CARD SETUP - Formatting cards



6

Useful functions

This function lets you format a card. Formatting prepares cards to receive data. Before using non-Olympus cards or cards which have been formatted on a PC, you must format the card with this camera.





**All existing data, including protected pictures, are erased when the card is formatted. Make sure that you save or transfer important data to a PC before formatting a used card.**

- 1** In the top menu, select **MODE MENU** → **CARD** → **CARD SETUP**, and press .

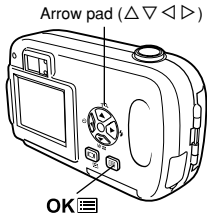
"How to use the mode menu" (P 30)

- Shooting mode  
The **FORMAT** screen is displayed.
- Playback mode  
The **CARD SETUP** screen is displayed.



- 2** If the  **FORMAT** screen is displayed, press  $\triangle \nabla$  to select **YES**.  
If the **CARD SETUP** screen is displayed, press  $\triangle \nabla$  to select  **FORMAT**, then press **OK** .
- When the  **FORMAT** screen appears, press  $\triangle \nabla$  to select **YES**.



- 3** Press **OK** .
- The **BUSY** bar is displayed and the card is formatted.

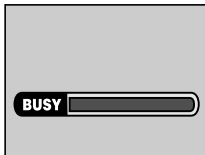

## 6



Never do the following during formatting, as they may cause the card to malfunction.

- Note
- Open the card cover.
  - Open the battery compartment cover.
  - Connect or disconnect the AC adapter.

This function lets you display detailed shooting information on the monitor for 3 seconds in the playback mode. For details of the information displayed, see "Monitor indications" (P. 9).

- 1 Pressing  $\triangleleft$  in the playback mode top menu displays the full amount of shooting information on the monitor (ON) (P. 29).**

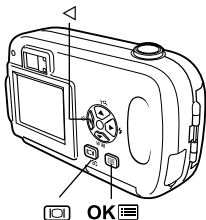

- To turn INFO off, press **OK** to bring up the top menu and press  $\triangleleft$  (OFF).



When INFO is ON



When INFO is OFF



## REC VIEW - Viewing a picture immediately after shooting

You can choose whether or not to display the picture you have just taken on the monitor.

- ON** : The picture being recorded to the card is displayed. This is useful for making a brief check of the picture you have just taken. You can resume shooting anytime during REC VIEW.
- OFF** : The picture being recorded to the card is not displayed. This is useful when you want to prepare for your next shot while the previous picture is being recorded.

- 1** In the shooting mode top menu, select **MODE MENU** → **SETUP** → **REC VIEW** → **OFF** or **ON**, and press **OK**.

☞ "How to use the mode menu" (P. 30)

- Press **OK** again to exit the menu.

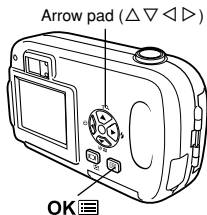

## 6

### Useful functions

## Adjusting the monitor brightness



You can adjust the brightness of the monitor according to the surrounding conditions to make it easier to see.

- 1** In the top menu, select **MODE MENU** → **SETUP** → **!**, and press **▶**.

☞ "How to use the mode menu" (P. 30)

- 2** Press **Δ ∇** to adjust the brightness while observing the monitor. Pressing **Δ** brightens the monitor, and pressing **∇** darkens it. Press **OK**.

- The monitor brightness is set.
- Press **OK** again to exit the menu.

# Turning the beep sound off



This function lets you turn on/off the beep sound used for warnings, etc. The beep sound can be adjusted in either the shooting mode or the playback mode.

ON : There is a beep for warnings.

OFF : There is no beep for warnings.

- 1 In the top menu, select MODE MENU → SETUP → → OFF or ON, and press .**

"How to use the mode menu" (P. 30)

- Press again to exit the menu.

Arrow pad ( )

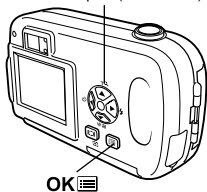

## FILE NAME

The camera automatically creates file names and folder names for images. Examples are shown below.

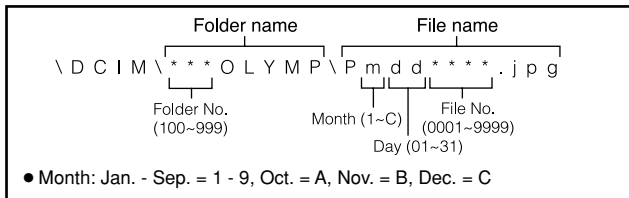

There are two choices here: RESET or AUTO. Choose the one that is best for you when transferring images to a computer.

## ■ RESET

When RESET is selected, the file number and folder number are reset every time a new card is inserted in the camera. The folder number returns to No. 100, and the file number returns to No. 0001. This is useful when grouping files on separate cards.

## ■ AUTO

When AUTO is selected, the same folder number is retained, but the file number continues from the previous card, so that the same file number is not used on different cards. This helps you to manage multiple cards. This is useful when a group of files stretches over more than one card.

- 1 In the shooting mode top menu, select MODE MENU → SETUP → FILE NAME → RESET or AUTO. Press OK.**

☞ "How to use the mode menu" (P. 30)

- Press **OK** again to exit the menu .

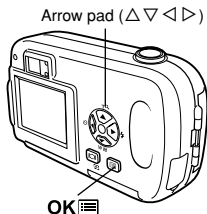

## 6



Note

- After the file number reaches 9999, it returns to 0001, and the folder number also changes (for example, from No. 100 to No. 101).
- When both the folder and file numbers reach their maximum (999/9999), you cannot store any more pictures, even if the card is not full yet. Insert a different card.

# PIXEL MAPPING

The Pixel Mapping feature allows the camera to check and adjust the CCD and image processing functions. It is not necessary to operate this function frequently. Approximately once a year is recommended. Wait a few minutes after the monitor is used or continuous shots are taken to allow for proper performance of the Pixel Mapping function.

**1 In the shooting mode top menu, select MODE MENU → SETUP → PIXEL MAPPING, and press  $\blacktriangleright$ .**

- START is displayed.

 "How to use the mode menu" (P. 30)

**2 Press OK .**

- The BUSY bar is displayed during Pixel Mapping. When Pixel Mapping is finished, the screen returns to the mode menu.

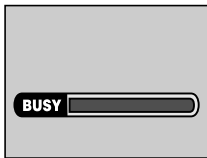
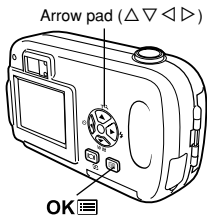

Note

- If you accidentally turn the camera off during Pixel Mapping, start again from step 1.

6

Useful functions

# VIDEO OUT - Video output selection

You can select NTSC or PAL according to your TV's video signal type. Set the video output before connecting the video cable to the camera. If you use the wrong video signal type, you will not be able to play back the recorded pictures properly on your TV. You can change the NTSC/PAL setting in either the shooting mode or the playback mode.

- 1 In the top menu, select MODE MENU → SETUP → VIDEO OUT → NTSC or PAL, and press OK.**

 "How to use the mode menu" (P. 30)

- Press **OK** again to exit the menu.
- The factory default setting varies depending on the area where you purchased this camera.

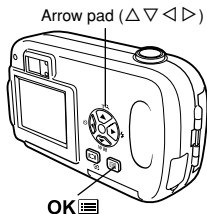

## TIPS

### • TV video signal types & main regions

Check the video signal type before using the camera.

NTSC : Japan, Taiwan, Korea, North America

PAL : European countries, China

### • NTSC (National Television Systems Committee) / PAL (Phase Alternating Line)

Television formats.

# 7 Print settings

## How to print pictures



Several different printing options are available when you want to print out pictures.

### ● **Printing at a photo lab that supports DPOF or printing on a DPOF-compatible printer**

Store the print reservation data on the card. Print reservation allows you to save printing data (number of prints, date/time information, etc.) with the pictures stored on the card.

#### ● **What is DPOF?**

DPOF is short for Digital Print Order Format. DPOF is the format used to record automatic print information from digital cameras.

If a card containing print reservation data is taken to a photo lab that supports the DPOF format, the pictures can be printed according to the DPOF reservations. Or pictures can be printed out at home on a personal DPOF-compatible printer.

### ● **Printing on an Olympus P-400, or P-200 digital color printer**

Printing is possible on specified printers without using a PC. For more details, refer to the printer's instruction manual.

An xD-Picture Card cannot be inserted into the printer without a specified card adapter (sold separately).

### ● **Transferring pictures to a PC and printing them from a printer connected to the PC**

If your PC has software applications installed that support JPEG images (Internet browser, Paint Shop Pro, Photoshop, etc.), you can print out your pictures on a printer connected to the PC. (Printing is also possible using CAMELIA Master software.) Check your software before printing. For details, refer to the application software's instructions.

For instructions on how to transfer images, or connect the camera to a PC, see "DIGITAL CAMERA-PC CONNECTION OPERATION MANUAL" on the CD-ROM.



## TIPS

### • **JPEG (Joint Photographic Experts Group)**

A compression format for color still images. Photographs (images) shot using this camera are recorded onto the card in JPEG format when the record mode is set to SHQ, HQ or SQ. By downloading these images to a personal computer, users can edit them using graphics application software or view the images using an Internet web browser.



### • **Picture size and printing**

The resolution of a computer/printer is generally based on the number of dots (pixel) per inch. This is called dpi (dots per inch). The higher the dpi value, the better the printed results. Keep in mind, however, that the dpi of the picture does not change. This means that when you print an image with a higher resolution, the size of the printed picture will be smaller. Although you can print magnified images, picture quality will decrease.

If you want to print large, high-quality pictures, set the record mode as high as possible when taking the pictures.  "Changing the record mode" (P. 59)



## Note

- DPOF reservations set by another device cannot be changed by this camera. Make changes using the original device.
- If a card contains DPOF reservations set by another device, entering reservations using this camera may overwrite the previous reservations.
- DPOF reservations can be performed for only the first 999 frames on a card.
- If the card is full, print reservation is not available. "CARD FULL" is displayed.
- Even if an image appears with the message "PICTURE ERROR", it may be possible to make print reservations. In such a case, the print reservation icon () does not appear when an image is displayed for full view.  appears when multiple images are displayed (index-display mode), allowing you to confirm the print reservation.
- Not all functions may be available on all printers or at all photo labs.
- Print reservation may take considerable time when saving printing data to a card.

Use this feature to print all the pictures stored on the card. You can set the number of prints and whether or not to include the shooting date and time.

## 1 Play back a still picture.

- You cannot print pictures with .

## 2 In the top menu, select **MODE MENU** → **PLAY** → , and press **▷**.

- If print reservation data is already stored on the card, the **PRINT ORDER SETTING** screen appears, giving you the choice of resetting the data or keeping it. Select **RESET** and press **OK** .

Arrow pad (△▽◀▶)



## 3 Press **△▽** to select , then press **OK** .

- The screen is displayed.

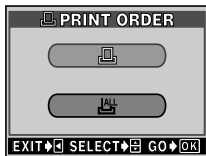

## 4 Press **△▽** to select x (number of prints) or (date/time), then press **▷**.

### ■ Set the number of prints

Press **△▽** to set the number of prints, then press **OK** .

△: Increases the number.

▽: Decreases the number.

### ■ Set the date/time printing options

Press **△▽** to select **NO**, **DATE** or **TIME**, then press **OK** .

**NO** : The pictures are printed without the date and time.

**DATE** : All the pictures are printed with the shooting date.

**TIME** : All the pictures are printed with the shooting time.

Press **OK** again.

- The print reservation data is stored on the card and the screen returns to the playback menu.

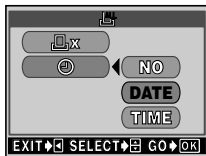
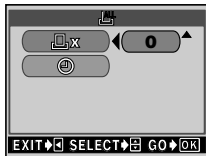



# Single-frame reservation



Use this feature to print only selected pictures. This function can also alter details (number of prints, date, etc.) of previously made reservations. Display the picture to be printed and select the desired number of prints.

## 1 Play back a still picture.

- You cannot print pictures with .

## 2 In the top menu, select MODE MENU → PLAY → , and press .

- If data is already stored on the card, the PRINT ORDER SETTING screen appears, giving you the choice of resetting the data or keeping it. Select KEEP and press **OK** .

Arrow pad (, , , )

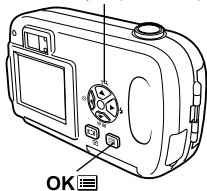

## 3 Press , to select , then press **OK** .

## 4 Press , , , to select the frame you want to print. Press **OK** .

- You can also use the index display to select the frame. "Index display" (P. 70)

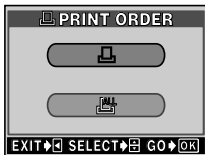

## 5 Press , , , to select the following.

- MORE** : Sets the number of prints and date/time options. Go to step 6.
- SINGLE PRINT** : Prints a single frame. The date/time setting is not available. Go to step 7.
- CANCEL** : Cancels print reservation for the current frame. "Resetting print reservation data" (P. 98).
- END** : Completes the print reservation. Go to step 10.

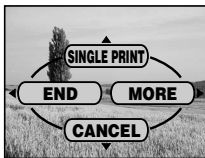

**6** Press  $\Delta$ / $\nabla$  to select  $\text{ⓧ}$  x (number of prints) or  $\text{Ⓢ}$  (date/time) then press  $\text{▶}$ .

- $\text{ⓧ}$  x : See below.
- $\text{Ⓢ}$  : See below.

■ Set  $\text{ⓧ}$  x (number of prints)

Press  $\Delta$ / $\nabla$  to set the number of prints, then press **OK**.

$\Delta$ : Increases the number.

$\nabla$ : Decreases the number.

■ Set  $\text{Ⓢ}$  (date/time printing options)

Press  $\Delta$ / $\nabla$  to select NO, DATE or TIME, then press **OK**.

NO : The pictures are printed without the date and time.

DATE : The shooting date is added to all pictures with print reserve.

TIME : The shooting time is added to all pictures with print reserve.

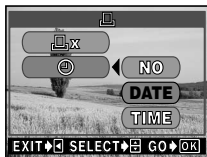
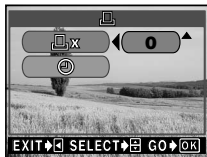

**7** After setting  $\text{ⓧ}$  x and  $\text{Ⓢ}$ , press **OK**. Print reservation is set and the screen in step 4 is restored.

- $\text{ⓧ}$  appears on the current frame.



**8** Press **OK** to display the single-frame reservation menu.

**9** Press  $\text{◀}$  to select **END**.

- The PRINT ORDER screen appears.

**10** Press  $\text{◀}$  repeatedly until the **MODE MENU** appears.

- Press **OK** to exit the menu.

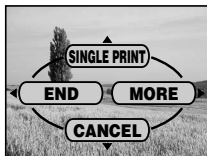

# Resetting print reservation data



This function allows you to reset the print reservation data for pictures stored on the card. There are two ways to reset print reservation: you can reset all print reservation data or you can reset the print reservation data for only the frames you do not need.

- 1 Display a still picture with .
- 2 In the top menu, select **MODE MENU** → **PLAY** → , and press .
  - If print reservation data is already stored on the card, the **PRINT ORDER SETTING** screen appears.
- 3 To reset all print reservation data, press to select **RESET**, then press .  
 Go to step 8.  
To reset only the print reservation data for the frames that you do not need, press to select **KEEP**, then press .











**PRINT ORDER SETTING** Screen

- 4 Press to select on the **PRINT ORDER** screen, then press .
- 5 Press to display the frame whose print reservation data you want to reset, then press .
  - The single-frame reservation menu is displayed.
- 6 Press to select **CANCEL**.
  - Print reservation is canceled, and the screen in step 5 is restored.
  - disappears.
- 7 If you are finished resetting print reservation data, press to display the single-frame reservation menu. Press .
- 8 Press repeatedly until the **MODE MENU** appears.
  - Press to exit the menu.



## 8 Miscellaneous

### Error codes





Monitor indication	Possible cause	Corrective action
 NO CARD	The card is not inserted, or it cannot be recognized.	<ul style="list-style-type: none"> <li>• Insert a card correctly or insert a different card.</li> <li>• If the card is dirty, wipe the gold contacts with a clean tissue and insert it again. If the problem is still not corrected, the card cannot be used.</li> </ul>
 CARD ERROR	There is a problem with the card, so the camera will not function.	Insert a different card.
 WRITE-PROTECT	Writing to the card is prohibited.	Read-only has been set using a computer. Use the computer again to cancel the read-only setting.
 CARD FULL	The card is full. No more pictures can be taken or no more information such as print reservation can be recorded.	Replace the card or erase unwanted pictures. Before erasing, download important images to a PC.
 NO PICTURE	There are no pictures on the card.	The card contains no pictures. Record pictures.
 PICTURE ERROR	There is a problem with the selected picture, so it cannot be played back on this camera.	Use image processing software to view the picture on a PC. If that cannot be done, the image file is damaged.
	The card is not formatted.	Format the card.
 CARD COVER OPEN	The card cover is open.	Close the card cover.

# Troubleshooting

Possible cause	Corrective action	Ref. Page
<b>The camera does not work or the monitor does not turn on.</b>		
The power is off.	Open the lens barrier fully to turn on the camera.	P. 21
The batteries are loaded incorrectly.	Reload the batteries correctly.	P. 14
The battery is exhausted.	Replace the batteries with new ones.	P. 14
The battery is temporarily unable to function because of the cold.	Warm the battery by putting it in your pocket for a while.	—
The camera is in the sleep mode.	Operate the camera (press the shutter button or the arrow pad).	P. 21
There is condensation * inside the camera	Wait until the camera dries before turning it on again.	—
The camera is connected to a PC.	The camera will not operate while it is connected to a PC.	—

\* Condensation: When it is cold outside, the water vapor in the air is rapidly cooled and turns to droplets of water. Condensation occurs when the camera is suddenly taken from a cold place into a warm room.

Possible cause	Corrective action	Ref. Page
<b>No picture is taken when the shutter button is pressed.</b>		
The lens barrier is closed.	Open the lens barrier fully.	P. 21
The power is off.	Open the lens barrier fully.	P. 21
The flash has not finished charging.	Take your finger off the shutter button. When the orange lamp stops blinking, start shooting again.	P. 49
The movie just taken is being written to the card.	Release your finger from the shutter button. When the orange lamp stops blinking, resume shooting.	P. 46
The card is full.	Erase unwanted pictures or insert a new card. Before erasing, download important images to a PC.	P. 18, 77
<b>The green lamp and orange lamp blink at the same time</b>		
The batteries are exhausted.	Replace the batteries with new ones.	P. 14
<b>The flash does not fire.</b>		
The flash is set to the flash off mode.	Select a flash mode other than flash off.	P. 49
The subject is illuminated.	If you want the flash to fire on a brightly illuminated subject, set the flash to fill-in mode.	P. 50
The movie mode is on.	The flash does not fire in the movie mode.	P. 49
Panorama mode is set.	The flash does not fire in the panorama mode. Cancel the panorama mode.	P. 55

Possible cause	Corrective action	Ref. Page
<b>The monitor is hard to see.</b>		
The brightness is not adjusted properly.	Select  in the MODE MENU and adjust the brightness.	P. 88
Vertical lines appear on the monitor.	Bright light (such as sunlight) may cause this. Use the viewfinder.	P. 43
The monitor is exposed to direct sunlight.	Block the sunlight with your hand.	—
<b>Pictures you have taken do not appear on the monitor.</b>		
The power is off.	With the lens barrier closed, press  to turn the monitor on.	P. 22
The camera is in the shooting mode.	Press  quickly twice, or close the lens barrier and then press  to switch to the playback mode.	P. 67, 68
There are no pictures on the card.	NO PICTURE appears on the monitor. Record pictures.	—
The camera is connected to a TV.	The monitor does not function when the video cable is connected to the camera.	P. 73
<b>The date recorded with the image data is wrong.</b>		
The date/time is not set.	Set the date/time. The clock adjustment is not factory-preset.	P. 26
The battery is exhausted.	When the battery runs down, the date/time setting is canceled. Replace with a new battery and reset the date and time.	P. 14, 26
The camera has been left with the battery removed.	If the camera is left for with the battery removed, the date/time setting is canceled. Set the date/time again.	P. 26
<b>The settings are returned to the factory default settings when the camera is turned off.</b>		
ALL RESET is set to ON.	Select the SETUP tab in the mode menu and set ALL RESET to OFF.	P. 84

Possible cause	Corrective action	Ref. Page
<b>The picture is too bright.</b>		
The flash was set to the fill-in flash mode.	Select a flash mode other than fill-in flash.	P. 49
The subject was excessively illuminated.	Adjust the exposure compensation toward minus (-) or change the camera position.	P. 63
<b>The picture is too dark.</b>		
The flash was blocked by your finger.	Hold the camera correctly, keeping your fingers away from the flash.	P. 28
The subject was out of the working range of the flash.	Shoot within the flash working range.	P. 49
The flash was set to the flash off mode.	Select a flash mode other than flash off.	P. 49
The subject was too small and was backlit.	Set the flash to fill-in mode.	P. 50
You shot a bright subject, such as snow.	Adjust the exposure compensation toward +.	P. 63
<b>The colors of pictures taken indoors look unnatural.</b>		
Indoor lighting can affect the picture's colors.	Set the white balance according to the lighting.	P. 65
There is no white in the subject.	Include something white in the picture, or shoot using the fill-in flash mode.	P. 50
The white balance setting is wrong.	Adjust the white balance according to the light source.	P. 65















Possible cause	Corrective action	Ref. Page
<b>The picture has obscured edge(s).</b>		
The lens was partly blocked by your finger or the strap.	Hold the camera correctly, keeping your fingers and the strap away from the lens.	P. 28
The subject was too close.	Check the actual picture area by using the monitor to take the picture.	P. 41
<b>The picture is out of focus.</b>		
The camera moved when the shutter button was pressed.	Hold the camera correctly and press the shutter button gently. Camera movement occurs easily with slower shutter speeds. When you take a picture with the flash off mode in a night scene or a dark situation, use a tripod, or hold the camera firmly.	P. 28
The lens was dirty.	Clean the lens. Use a commercially available blower brush and then wipe with a Lens cleaner to remove dust. Mold may form on the lens surface if the lens is left dirty.	P. 110
The camera may not be able to focus on the subject, even if the green lamp lights up.	Lock the focus on an object that is the same distance from the camera as the subject, then compose your shot again.	P. 44
<b>The battery's power is running out.</b>		
You are using the camera in an environment that is too cold.	Keep the camera as warm as possible. In cold weather, put it inside your clothes or another warm place for a short time before using it.	—
The monitor is always on.	Turn off the monitor as often as possible.	—

# Menu list













## ● Shooting mode menus ( :P/ / / / )

Top menu	Tab	Function	Setting	Ref. page
MODE MENU	CAMERA	SCENE SELECT	PROGRAM AUTO ,  ,  , ,	P. 37
			OFF, ON	P. 52
			OFF, ON	P. 54
			-2.0 to +2.0 (in 1/2 EV steps)	P. 63
		PANORAMA 2 IN 1		P. 55 P. 57
	PICTURE	WB	AUTO,  ,  , ,	P. 65
	CARD	CARD SETUP	FORMAT, CANCEL	P. 85
	SETUP	ALL RESET	OFF, ON	P. 84
			ENGLISH, FRANCAIS, DEUTSCH, ESPAÑOL	P. 24
			OFF, ON	P. 89
		REC VIEW	OFF, ON	P. 88
		FILE NAME	RESET, AUTO	P. 89
		PIXEL MAPPING		P. 91
				P. 88
				P. 26
	VIDEO OUT	NTSC, PAL	P. 92	
			P. 46	
		SHQ, HQ, SQ1, SQ2	P. 59	
MODE RESET		ALL RESET, CANCEL	P. 84	







## ● Shooting mode menus ( )

Top menu	Tab	Function	Setting	Ref. page	
MODE MENU	CAMERA		OFF, ON	P. 52	
			OFF, ON	P. 54	
			-2.0 to +2.0 (in 1/2 EV steps)	P. 63	
	PICTURE	WB		AUTO,  ,  ,	P. 65
				 , 	
	CARD	CARD SETUP	FORMAT, CANCEL	P. 85	
	SETUP		ALL RESET	ON/OFF	P. 84
				ENGLISH, FRANCAIS, DEUTSCH, ESPAÑOL	P. 24
				OFF, ON	P. 89
			REC VIEW	OFF, ON	P. 88
			FILE NAME	RESET, AUTO	P. 89
			PIXEL MAPPING		P. 91
					P. 88
					P. 26
	VIDEO OUT	NTSC, PAL	P. 92		
	PHOTO			P. 38	
			HQ, SQ	P. 59	
MODE RESET			ALL RESET, CANCEL	P. 84	

## ● Playback mode menus (Still picture)







Top menu	Tab	Function	Setting	Ref. page
MODE MENU	PLAY		OFF, ON	P. 76
			0°, +90°, -90°	P. 72
			 , 	P. 93
	EDIT	BLACK&WHITE	BLACK&WHITE, CANCEL	P. 79
		SEPIA	SEPIA, CANCEL	P. 80
			640 x 480, 320 x 240, CANCEL	P. 80
	CARD	CARD SETUP	ALL ERASE, FORMAT	P. 78, 85
	SETUP	ALL RESET	OFF, ON	P. 84
			ENGLISH, FRANCAIS, DEUTSCH, ESPAÑOL	P. 24
			OFF, ON	P. 89
				P. 88
				P. 26
		VIDEO OUT	NTSC, PAL	P. 92
		4, 9, 16	P. 70	
	INFO		P. 71	
		YES, NO	P. 87	
			P. 77	

## ● Playback mode menus ( )





Top menu	Tab	Function	Setting	Ref. page
MODE MENU	PLAY		OFF, ON	P. 76
	EDIT	INDEX	OK/RESET/CANCEL	P. 82
	CARD	CARD SETUP	ALL ERASE, FORMAT	P. 78, 85
	SETUP	ALL RESET	OFF, ON	P. 84
			ENGLISH, FRANCAIS, DEUTSCH, ESPAÑOL	P. 24
			OFF, ON	P. 89
				P. 88
				P. 26
		VIDEO OUT	NTSC, PAL	P. 92
			4, 9, 16	P. 70
MOVIE PLAY		PLAYBACK, FRAME BY FRAME, EXIT	P. 74	
INFO			P. 87	
		YES, NO	P. 77	

# Factory default settings





## ● Shooting mode

	AUTO
	OFF
Shooting mode	 PHOTO (still picture shooting mode)
SCENE SELECT	P (Program auto)
Digital zoom	1X
Monitor	OFF (turns off)
	HQ
	OFF
	0.0
PANORAMA	OFF
2 IN 1	OFF
WB	AUTO
REC VIEW	ON
FILE NAME	RESET
	OFF

## ● Playback mode















	OFF
	OFF
INFO	OFF
	OFF
	0°
	9

## ● Other

	± 0
	ON
ALL RESET	ON
	ENGLISH*
	2003.01.01
VIDEO OUT	*

\* Settings differ according to the region where the camera is sold.

# List of functions by shooting mode

Shooting mode Function	P					
	✓	✓	✓	✓	✓	✓
	✓	✓	✓	✓	✓	✓
	✓	✓	✓	✓	✓	—
	✓	✓	✓	✓	✓	✓
	✓	✓	✓	✓	✓	✓
	✓	✓	✓	✓	✓	✓
Digital zoom	✓	✓	✓	✓	—	—
PANORAMA	✓	✓	✓	✓	—	—
2 IN 1	✓	✓	✓	✓	✓	—
WB	✓	✓	✓	✓	✓	✓
CARD SETUP	✓	✓	✓	✓	✓	✓
ALL RESET	✓	✓	✓	✓	✓	✓
	✓	✓	✓	✓	✓	✓
	✓	✓	✓	✓	✓	✓
	✓	✓	✓	✓	✓	✓
REC VIEW	✓	✓	✓	✓	✓	✓
FILE NAME	✓	✓	✓	✓	✓	✓
	✓	✓	✓	✓	✓	✓

✓ : Available, — : Not available

# Camera maintenance

- 1 Close the lens barrier to turn the camera off.**  
Make sure that the monitor is turned off.
- 2 Remove the battery. (If you are using an AC adapter, unplug the AC adapter from the camera first before removing the plug from the wall outlet.)**
- 3 Exterior:**
  - Wipe gently with a soft cloth. If the camera is very dirty, soak the cloth in mild soapy water and wring well. Wipe the camera with the damp cloth and then dry it with a dry cloth. If you have used the camera at the beach, use a cloth soaked in clean water and well wrung.**Monitor and viewfinder:**
  - Wipe gently with a soft cloth.**Lens:**
  - Blow dust off the lens with a commercially available blower, then wipe gently with a lens cleaning paper.**CARD:**
  - Wipe gently with a soft, dry cloth.



Note

- Do not use strong solvents such as benzene or alcohol, or chemically treated cloths.
- Cleaning should be done only after the battery has been removed or the AC adapter has been disconnected.
- Mold may form on the lens surface if the lens is left dirty.

# Specifications

Product type	: Digital camera (for shooting and displaying)
Recording system	
Still picture	: Digital recording, JPEG (in accordance with Design rule for Camera File system (DCF)), Exif 2.2, Digital Print Order Format (DPOF) PRINT Image Matching II
Movie	: QuickTime Motion JPEG support
Memory	: xD-Picture Card (16 – 256MB)
No. of storable pictures/No. of pixels (on a16 MB card)	: Approx. 11 frame (SHQ: 1600 x 1200 pixels) Approx. 32 frames (HQ : 1600 x 1200 pixels) Approx. 76 frames (SQ1: 1024 x 768 pixels) Approx. 165 frames (SQ2: 640 x 480 pixels)
No. of effective pixels	: 2,000,000 pixels
Image pickup device	: 1/ 3.2" CCD solid-state image pickup, 2,110,000 pixels (gross)
Lens	: Olympus lens 5 mm (equivalent to 38 mm lens on 35 mm camera), f2.8, 5 elements in 4 groups
Photometric system	: Center-weighted average light metering, Spot metering
Shutter speed	: 1/2 to 1/1000 sec.
Shooting range	: 0.5 m (1.6 ft.) ∞ to (normal) 0.2 m (0.7 ft.) ∞ to (macro mode)
Viewfinder	: Reverse Galilean viewfinder
Monitor	: 1.8" TFT* color LCD display, 61,000pixels
Outer connector	: DC-IN jack, USB connector (mini-B), VIDEO OUT jack
Automatic calendar system	: 2000 – 2099





















\* A color monitor using a transistor made from thin-film.























Operating environment

Temperature	: 0° C to 40° C (32° F to 104° F) (operation) -20° C to 60° C (-4° F to 140° F) (storage)
Humidity	: 30% to 90% (operation)/ 10% to 90% (storage)
Power supply	: Two AA (R6) alkaline batteries or NiMH batteries One lithium CR-V3 battery pack AC adapter (optional) ● Manganese (zinc-carbon) batteries cannot be used.
Dimensions	: 112 mm (W) x 62 mm (H) x 40 mm (D) (4.4" x 2.4" x 1.6") (excluding protrusions)
Weight	: 166 g (0.4 lb.) (without battery or card)

SPECIFICATIONS ARE SUBJECT TO CHANGE WITHOUT ANY NOTICE OR OBLIGATION ON THE PART OF THE MANUFACTURER.

- A**
- AC adapter .....16
  - Adjusting the monitor
    - brightness  .....88
  - AF target mark .....8, 9
  - ALL RESET .....84
  - All-frame erase  .....78
  - All-frame reservation  .....95
  - Arrow pad .....8
  - Auto flash .....50
  - Auto white balance .....65
- B**
- Batteries .....14
  - Battery check .....9, 11
  - Battery compartment cover .....8, 14
  - Beep sound  .....89
  - Black and white .....79
- C**
- Card .....18
  - Card check .....23
  - Card cover .....8, 19
  - CARD SETUP  .....85
  - Close-up playback  .....69
  - Connector cover .....7
- D**
- Date/time setting  .....26
  - DC-IN jack .....7, 16
  - Digital zoom .....48
  - DPOF .....93
- E**
- Erasing pictures  .....77
  - Exposure compensation  .....63
- F**
- FILE NAME .....89
  - File number .....89
  - Fill-in flash  .....50
- Flash  .....49
  - Flash charge .....49
  - Flash mode .....50
  - Flash off  .....51
  - Flash stand-by .....49
  - Fluorescent lamp  .....65
  - Focus .....44
  - Focus lock .....44
  - Folder name .....89
  - Formatting .....85
  - Frame number .....10
- G**
- Green lamp .....8, 40
- H**
- High quality .....59
  - HQ .....59
- I**
- INDEX (Creating an index) .....82
  - Index display  .....70
  - Information display **INFO** .....87
- J**
- JPEG .....94, 111
- L**
- Landscape shooting  .....37
  - Language setting  .....24
  - Lens .....7
  - Lens barrier .....7
- M**
- Macro mode shooting  .....52
  - Mode menu .....34
  - MODE RESET .....84
  - Monitor .....8
  - Monitor button  .....8
  - MOVIE PLAY  .....74
  - Movie recording  .....46

- N**  
 Night scene shooting  .....37  
 No. of pictures in an  
   index display.....70  
 No. of storable still pictures ....9, 60  
 NTSC .....92
- O**  
 OK  (OK/Menu) button .....8, 29  
 Orange lamp .....8, 40  
 Overcast  .....65
- P**  
 PAL.....92  
 PANORAMA .....55  
 Picture rotation  .....72  
 Pixels .....62  
 PIXEL MAPPING .....91  
 Playback mode  .....67  
 Playing back pictures on a TV ....73  
 Portrait shooting  .....37  
 Print reservation  .....93  
 Program auto shooting  
   **P PROGRAM AUTO** .....37  
 Protecting  .....76
- Q**  
 QUICK VIEW .....68
- R**  
 REC VIEW .....88  
 Rechargeable batteries .....16  
 Record mode  .....59  
 Red-eye reduction flash  .....50  
 Resizing  .....80  
 Resolution .....60, 62
- S**  
 SCENE SELECT .....38  
 Seconds remaining.....9  
 Self portrait shooting  .....38  
 Self-timer lamp .....7, 53  
 Self-timer shooting  .....53
- SEPIA.....80  
 Shooting mode .....37  
 Shooting mode menu .....34  
 Shortcut menus .....32  
 SHQ .....59  
 Shutter button.....7, 40  
 Shutter speed .....37, 51, 111  
 Single-frame erase  .....77  
 Single-frame playback .....67  
 Single-frame reservation  .....96  
 Slideshow  .....71  
 Spot metering  .....54  
 SQ .....59  
 Still picture shooting  
    **PHOTO** .....40  
 Strap.....13  
 Strap eyelet .....13  
 Sunlight  .....65
- T**  
 Top menu .....29, 32  
 Tripod socket .....8  
 Tungsten lamp  .....65  
 Two-in-one pictures **2 IN 1** .....57
- U**  
 USB connector .....8
- V**  
 Video cable.....73  
 VIDEO OUT .....92  
 Video out jack.....7, 73  
 Viewfinder.....8
- W**  
 White balance **WB** .....65
- X**  
 xD-Picture Card .....18
- Z**  
 Zoom .....48

# OLYMPUS®

<http://www.olympus.com/>

## OLYMPUS OPTICAL CO., LTD.

Customer support (Japanese language only): Tel. 0426-42-7499 Tokyo

## OLYMPUS AMERICA INC.

Two Corporate Center Drive, Melville, NY 11747-3157, U.S.A. Tel. 1-631-844-5000

### Technical Support (USA)

24/7 online automated help: <http://support.olympusamerica.com/>

Phone customer support: Tel. 1-888-553-4448 (Toll-free)

Our phone customer support is available from 8 am to 10 pm (Monday to Friday) ET

E-Mail: [distec@olympus.com](mailto:distec@olympus.com)

Olympus software updates can be obtained at: <http://olympus.com/digital/>

## OLYMPUS OPTICAL CO. (EUROPA) GMBH.

Premises/Goods delivery: Wendenstrasse 14-18, 20097 Hamburg, Germany

Tel. +49(0)40-23 77 30/+49(0)40-23 77 33

Letters: Postfach 10 49 08, 20034 Hamburg, Germany

### European Technical Customer Support:

Please visit our homepage <http://www.olympus-europa.com>

or call our TOLL FREE NUMBER : **00800 - 67 10 83 00**

for Austria, Belgium, Denmark, Finland, France, Germany, Italy, Luxemburg, Netherlands, Norway, Portugal, Spain, Sweden, Switzerland, United Kingdom

- Please note some (mobile) phone services/provider do not permit access or request an additional prefix to +800 numbers.

For all not listed European Countries and in case that you can't get connected to the above mentioned number please make use of the following

CHARGED NUMBERS: **+49(0)1805-67 10 83** or **+49(0)40-23 77 38 99**

Our Technical Customer Support is available from 9 am to 6 pm MET (Monday to Friday)

# CAMEDIA

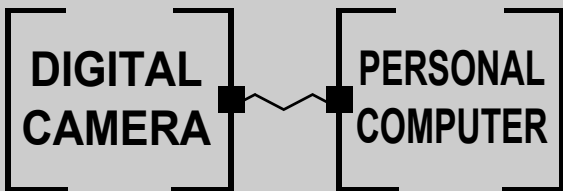

DIGITAL CAMERA — PC CONNECTION  
**OPERATION MANUAL**

How to use your PC to get the most from images taken with your digital camera.

- Thank you for purchasing an Olympus digital camera.
- This manual provides instructions on how to install the USB driver. To ensure correct installation, refer only to these installation procedures.

# Introduction

This manual explains in detail how to connect your Olympus digital camera to a computer. Read it carefully and keep it in a safe place for future reference.

## **About this manual**

- The information contained in this manual may be subject to change without notice. For the latest information on the product, please consult your local Olympus representative.
- The information contained in this manual has been compiled by taking all possible measures to ensure its accuracy. However, if you find any errors or incomplete information, please contact your local Olympus representative.
- It is prohibited by copyright laws to duplicate in part or in whole the information contained in this manual, except for personal use. Reproduction without permission of the copyright owner is prohibited.
- The PC screens shown in this manual may differ slightly from the actual displays on some PC models.

## **Trademarks**

- Microsoft and Windows are registered trademarks of Microsoft Corporation.
- Macintosh is a trademark of Apple Computer Inc.
- All other company and product names are registered trademarks and/or trademarks of their respective owners.

# INDEX

**Flowchart . . . . . 4**

**Identifying the OS . . . . . 6**

**Windows (98/Me/2000/XP) . . . . . 8**

Windows

**Macintosh (OS 9/X). . . . . 23**

Macintosh

**Downloading image files using other OS  
(For other OS users). . . . . 31**

# Flowchart

By connecting the camera to a computer with the provided USB cable, images on a card can be transferred to the computer. Some OS's (operating systems) may need a special setup before connecting to the camera for the first time. Follow the chart below.

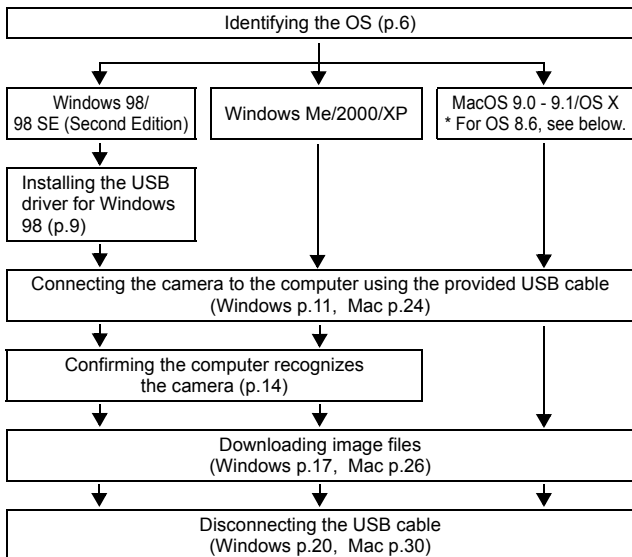

\* Even if your computer has a USB connector, data transfer may not function correctly if you are using one of the operating systems listed below or if you have an add-on USB connector (extension card, etc.).

- Windows 95/NT 4.0
- Windows 98/98 SE upgrade from Windows 95
- Mac OS 8.6 or lower (except Mac OS 8.6 equipped with USB MASS Storage Support 1.3.5 installed at the factory)
- Data transfer is not guaranteed on a home-built PC system or PCs with no factory installed OS.





- When connecting the camera to the computer, make sure that there is sufficient remaining battery power. When connected (transmitting) to the computer, the camera does not enter the sleep mode nor will the camera's power turn off automatically. Depending on the camera model, when the battery power runs out or the internal temperature rises, the camera may stop operating automatically. This could cause the computer to malfunction, and any image data (file) being transmitted may be lost. Be careful when downloading files for a long period of time. Use the AC adapter (optional) when downloading files.
- If you connect or disconnect the AC adapter when the camera is connected to the computer and is running on battery power, it may result in the loss of image data on the card or cause a malfunction in the computer. Before connecting or disconnecting the AC adapter, disconnect the camera from the computer and make sure that the camera is turned off.
- To avoid computer malfunctions, do not turn off the camera when the camera is connected to a computer.
- If the camera is connected to the computer via a USB hub, operation may not be stable if there are any compatibility problems between the computer and the hub. In such cases, do not use the hub and connect the camera directly to the computer.



- You can view images using: graphics applications that support the JPEG file format (Paint Shop Pro, Photoshop, etc.); Internet browsers (Netscape Communicator, Microsoft Internet Explorer, etc.); CAMEDIA Master software; or other software. For details on using commercial graphics applications, refer to their instruction manuals.
- QuickTime is needed for playing back movies. QuickTime is included on the provided software CD.
- If you want to process images, make sure to download them to your computer first. Depending on the software, image files may be destroyed if the images are processed (rotated, etc.) while they are on the card.

# Identifying the OS

Identify the OS on your computer before connecting the camera. How to identify the OS depends on the computer.

## ● Windows

### 1 Double-click the “My Computer” icon on your desktop.

When the “My computer” icon is not on your desktop, click “Control Panel” from the “Start” menu.

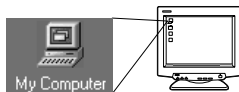

### 2 Double-click the “Control Panel” icon.



### 3 Double-click the “System” icon.



The way the file icons inside the folder appear may vary depending on your version of Windows. If you don't see the icon you are looking for, click on “view all Control Panel options” on the left of the window.

## 4 A System Properties window will appear. Note and record the “System:” information.

Confirm that your system is Windows 98, 98 SE, Me, 2000 Professional or Windows XP, then press “OK” to close the window.

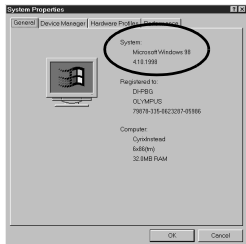

If your OS is Windows 98/98 SE, proceed to “Installing the USB driver for Windows 98” (👉 p.9).

Users running Windows Me/2000/XP 👉 p.11

Users running other OS 👉 p.31

## ● Mac OS (Macintosh)

Select “About This Computer” from the Apple menu on the menu bar.

A window appears with the name of the computer’s OS.

Confirm that the OS is OS 9.0-9.1 or OS X.

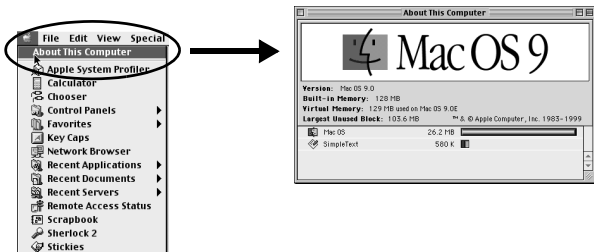

Users running Mac OS 9/X 👉 p.23

Users running other OS 👉 p.31

# Windows

## Using Windows 98/Me/2000/XP

### Make sure that:

- Your computer is turned on and Windows is running.
- If you are running any applications, quit them all.
- You are recommended to power the camera using the optional AC adapter. If the battery power runs out while the computer is accessing the card in the camera, the camera will turn off in the middle of the operation and this could destroy image files (data). If you are using batteries, make sure that there is sufficient remaining battery power.

<b>Installing the USB driver for Windows 98 (When using Windows 98/98 SE) .....</b>	<b>9</b>
<b>Connecting the camera to the computer .....</b>	<b>11</b>
<b>Confirming the computer recognizes the camera .....</b>	<b>14</b>
<b>Confirming the USB driver is installed .....</b>	<b>15</b>
<b>Downloading images to your computer.....</b>	<b>17</b>
<b>Disconnecting the camera from your computer .....</b>	<b>20</b>

# Installing the USB driver for Windows 98 (When using Windows 98/98 SE)

If your OS is Windows 98/98 SE, you must install the USB driver. Follow the instructions below to install the USB driver in your computer. Once it is fully installed, you do not need to repeat the procedure again.

**If your OS is Windows Me/2000/XP, you do not need to install the USB driver.** Proceed to “Connecting the camera to the computer” (👉 p.11).

- 1** Insert the provided software CD into your CD-ROM drive.

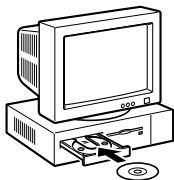

- 2** The Olympus Windows Installer should automatically launch. Click “USB Driver”.

If the USB driver is already installed in your computer, this option will not appear.

- This option will not appear if you are using Windows Me/2000/XP.

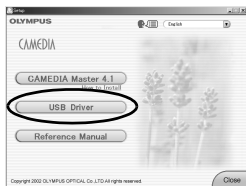

If the installer is not automatically launched, select “Run..” on the “Start” menu and then execute “(drive letter):/ Information.exe”.



The drive letter of the CD-ROM varies depending on the computer.  
To identify the drive letter, double-click “My Computer” on the desktop.

- 3** Click "Continue". The installation of the USB driver will start.



- 4** Click "OK" to restart your computer and the installation is complete.

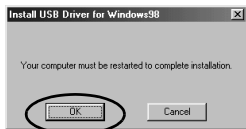

- 5** When the computer has restarted, installation is complete. If the Olympus Windows Installer screen appears, click "Close" and remove the CD-ROM from the CD-ROM drive.

# Connecting the camera to the computer

Users running Windows 98/98SE need to install the USB drive before connecting the camera to your computer for the first time. (☞ p.9)

- 1** Insert the marked end of the provided USB cable into the USB port on your computer as shown below.

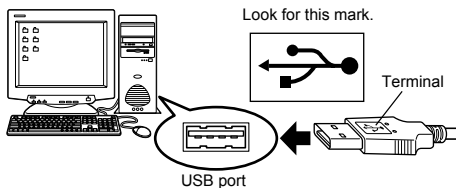

## Note

The location of the USB port varies depending on the computer. For details, refer to your computer's manual.

- 2** After making sure that the camera is turned off, connect the end of the USB cable to the USB connector on the camera.

The location of the USB connector or multi connector varies depending on the camera model. Refer to the camera manual for details.

### Camera with a USB connector

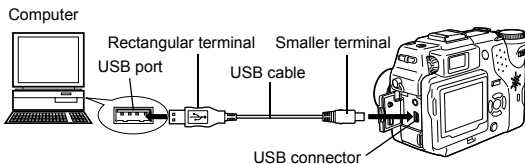

### Camera with a multi connector

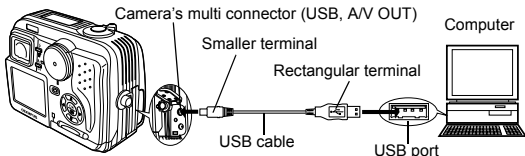

### 3 Turn the camera on.

- **Camera with a lens barrier**

The power turns on automatically, with the exception of some models which require you to press the  (monitor) button.

When the camera is turned on, the lamp on the right of the viewfinder lights up.

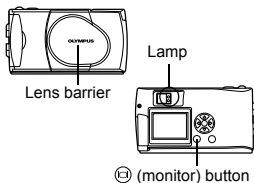

- **Camera with a  mode**

Set the mode dial to . (If the camera has a power switch as well as a mode dial, turn the power switch to ON.)

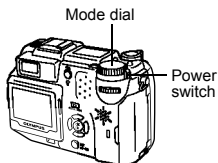
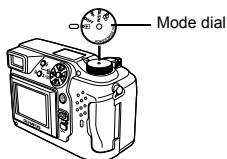

- **Camera with a  mode (Camera setup/connection mode)**

Set the mode dial to  to turn the camera on.

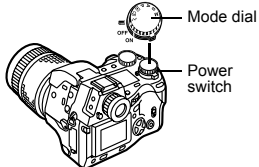



## 4 The computer recognizes the camera as a new device.

When you connect the camera to the computer for the first time, the computer automatically recognizes the camera. Click "OK" when the message saying that the installation is completed appears. The computer recognizes the camera as a "Removable Disk".

### ● Windows XP

You can download image files from the camera easily. Select "Copy pictures to folder on my computer using Microsoft Scanner and Camera Wizard", then follow the on-screen instructions. You may also select "take no action" to bypass the Microsoft Scanner and Camera Wizard. You may then use a more advanced image viewing/editing program such as Olympus CAMEDIA Master software. For detailed instructions on downloading, refer to the CAMEDIA Master software user's guide.



---

When the camera is connected to the computer, none of the camera buttons are functional.

# Confirming the computer recognizes the camera

## 1 Double-click the “My Computer” icon on the desktop.

For users running Windows XP, click “My Computer” from the “Start” menu.

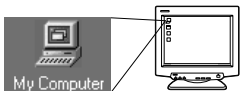

## 2 Make sure the “Removable Disk” icon appears in the window.

There may already be other “Removable Disk” icons for other devices, such as a removable media drive or USB SmartMedia Reader/Writer. In this case, the digital camera is recognized as another “Removable Disk”.

If you cannot find the icon, the camera and computer are not connected properly. Turn the camera off, disconnect the camera from the computer and connect again, or proceed to “Confirming the USB driver is installed” (p.15) to make sure that the USB driver is fully installed.

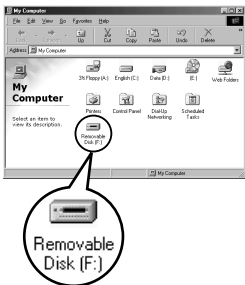

# Confirming the USB driver is installed

If the computer does not recognize the camera as a Removable Disk, follow the procedure below to check whether the USB driver has been fully installed.

- 1** Open "My Computer" and double-click the "Control Panel" icon. For users running Windows XP, open "Control Panel" from the "Start" menu.



- 2** Double-click the "System" icon.

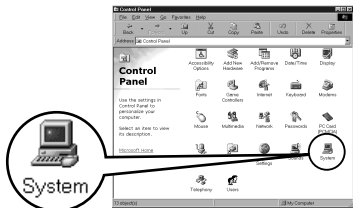

- 3** The System window will appear. Click the "Device Manager" tab.

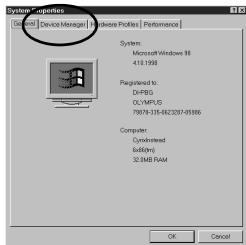

#### 4 Confirm that “OLYMPUS Digital Camera” is in the “Universal Serial Bus Controller” category.

If you cannot find the “OLYMPUS Digital Camera”, turn the camera off, disconnect the camera from the computer and start again.

Users running Windows 98/98 SE start again from “Confirming the USB driver is installed”, and Users running Window Me/2000/XP start from “Connecting the camera to the computer”.

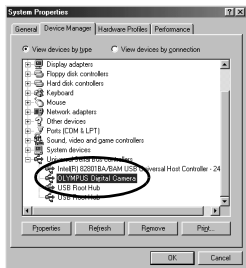

If the USB driver was successfully installed, you can find the following in the “Device Manager”.

- the name of the camera you have connected listed under “Disk drives”
- “OLYMPUS Digital Camera” listed as one of the items in the “Universal Serial Bus Controller” category

# Downloading images to your computer

## 1 Double-click the “My Computer” icon on the desktop.

For users running Windows XP, click “Control Panel” from the “Start” menu.

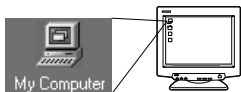

## 2 Double-click the “Removable Disk” icon.

A new “Removable Disk” icon appears when the camera is connected to the computer, as the digital camera is recognized as a “Removable Disk”.



### Note

If an error message appears when you double-click the icon, there may be a problem with one of the following:

- ① the camera's power source (the AC adapter is not properly connected or the battery power is low)  
Make sure that the AC adapter is correctly connected or that the batteries are not running low.
- ② the card (there is no card in the camera or there is a problem with the card)  
Check that you can play back pictures stored on the card on the monitor of your digital camera.

## 3 Double-click the “Dcim” folder.

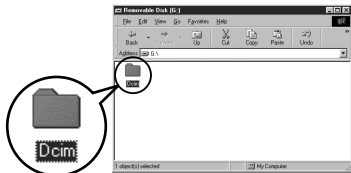

#### 4 Double-click the “100olymp” folder.

Image files (JPEG files) with file names such as “P1010001.jpg” are displayed.

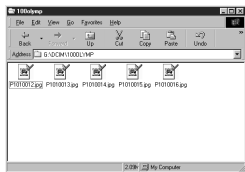

- The camera automatically assigns folder names and file names according to the following rules.

Folder name	File name
(Example) <b>100olymp</b>	(Example) <b>P1010001.jpg</b>
↓	↓ ↓ ↓
Serial number	Month / Day / Serial number

- Serial numbers of image files run from 0001 to 9999.
- Serial numbers of folders run from 100 to 999.
- When file number 9999 is reached, a new folder is created and assigned the next number.
- Months January through September are expressed by the numbers 1 through 9, October by the letter A, November by B and December by C.

#### 5 Double-click the “My Documents” icon on the desktop.

If you cannot find the icon on the desktop, select “Explorer” on the Start menu and double-click the “My Documents” icon.

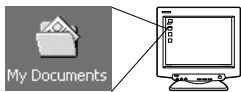

The “My Documents” window is displayed.



- 6** Drag & drop the image you want to save in the computer (in this case, P1010012.jpg) to the “My Documents” window.

The image is saved in the computer (in My Documents folder).

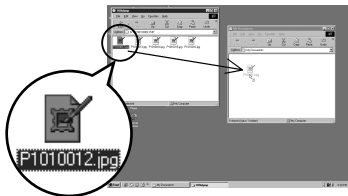

- To select all files, choose Edit > Select all.



When the image file has been downloaded to the computer, you can view images by double-clicking the image files downloaded to your computer. The files will be opened in the default image viewer of the operating system. If you want to view the image a different size or process it, you will need to open the image with software that supports JPEG or TIFF images files, such as Paint Shop Pro, Photoshop or CAMEDIA Master software.



The lamp on the right of the viewfinder or the card access lamp blinks while the image is being copied. Never open the card cover on the camera, load or remove the batteries, or connect or disconnect the AC adapter while the lamp is blinking as the image files may be destroyed.

# Disconnecting the camera from your computer

If your OS is Windows Me/2000, proceed to “Windows Me/2000/XP” (p.21).

## ● Windows 98

- 1** Make sure that the lamp on the right of the viewfinder or the card access lamp is not blinking.

Some camera models have either a lamp on the right of the viewfinder or a card access lamp, and the location varies depending on the model. Refer to your camera's reference manual.

Lamp

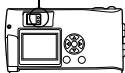

Card access lamp

- 2** Double-click the “My Computer” icon and right-click the “Removable Disk” to display the menu.



Removable  
Disk (F:)

- 3** Click “Eject” on the menu.





- 4** Make sure that the lamp on the right of the viewfinder or the card access lamp is not blinking.

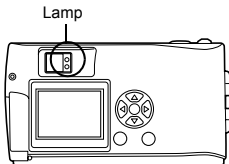

- 5** Remove the USB cable from the camera.

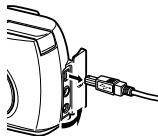

- 6** Remove the USB cable from your computer.

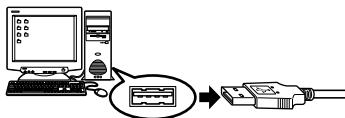

Windows

## ● Windows Me/2000/XP

- 1** Make sure that the lamp on the right of the viewfinder or the card access lamp is not blinking.

Some camera models have either a lamp on the right of the viewfinder or a card access lamp, and the location varies depending on the model. Refer to your camera's reference manual.

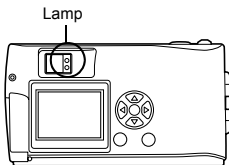

- 2** Click the  "Unplug or Eject Hardware" icon on the task bar.

The message saying that the drive has been stopped appears.

- 3** Click on the message.

The "Unplug or Eject Hardware" window appears.

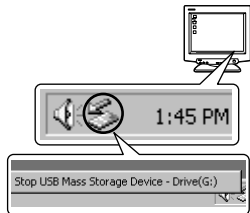

- 4** When a message appears, click "OK".



- 5** Remove the USB cable from the camera.

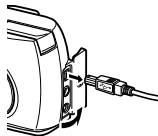

- 6** Remove the USB cable from your computer.

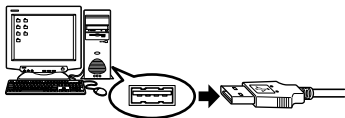

Caution

If the window returns the following message when you click "Unplug or Eject Hardware", first make sure that no image data is being downloaded from the camera, and then remove the USB cable.



# Macintosh

## Using Mac OS (9/X)

### Make sure that:

- Your computer is turned on and Mac OS is running.
- If you are running any applications, quit them all.
- You are recommended to power the camera using the optional AC adapter. If the battery power runs out while the computer is accessing the card in the camera, the camera will turn off in the middle of the operation and this could destroy image files (data). If you are using batteries, make sure that there is sufficient remaining battery power.

If you are running Mac OS X, the connection to the computer and downloading the image data are verified. Restrictions such as the following may occur due to the OS.

- The image file properties are not displayed correctly.
- Images in the camera cannot be opened without first downloading them. etc.

For more details, visit the Olympus web site.

<b>Connecting the camera to the computer .....</b>	<b>24</b>
<b>Downloading images to your computer.....</b>	<b>26</b>
<b>Disconnecting the camera from your computer .....</b>	<b>30</b>

# Connecting the camera to the computer

- 1** Insert the marked end of the USB cable into the USB port on your computer as shown below.

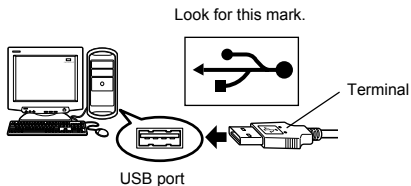

The location of the USB port varies depending on the computer. For details, refer to your computer's manual.

- 2** After making sure that the camera is turned off, connect the end of the USB cable to the USB connector on the camera.
- The location of the USB connector or multi connector varies depending on the camera model. Refer to the camera manual for details.

## Camera with a USB connector

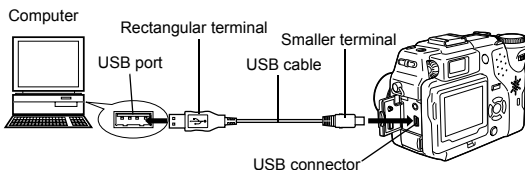

## Camera with a multi connector

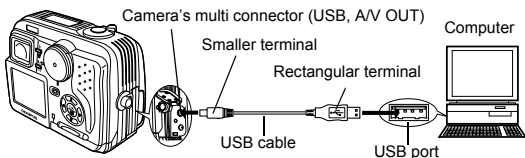

### 3 Turn the camera on.

#### ● Camera with a lens barrier

The power turns on automatically, with the exception of some models which require you to press the  (monitor) button.

When the camera is turned on, the green lamp on the right of the viewfinder lights up.

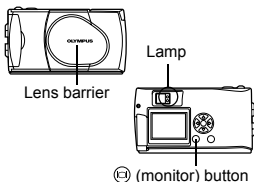

#### ● Camera with a mode

Set the mode dial to . (If the camera has a power switch as well as a mode dial, turn the power switch to ON.)

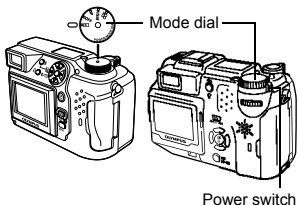

#### ● Camera with a mode (Camera setup/connection mode)

Set the mode dial to  to turn the camera on.

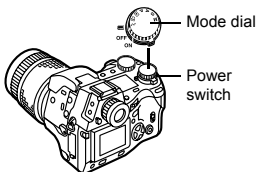

### 4 The computer recognizes the camera as a new device.

The computer recognizes the camera automatically and an "Untitled" icon appears on the desktop.

If you cannot find this icon, turn off the camera and connect again.

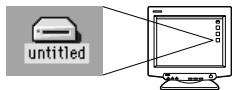

#### ● Mac OS X

When the computer has recognized the camera, the Apple Image Capture software automatically launches.  p.29



When the camera is connected to the computer, none of the camera buttons are functional.

# Downloading images to your computer

## ● Mac OS 9

You can download images from the camera and save them in your computer (in this case, in the Hard Disk).

- 1** Double-click the “Untitled” icon displayed on the desktop when the camera is connected to the computer.

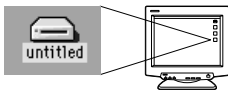

If you cannot find this icon, or if an error message appears when you double-click the icon, there may be a problem with one of the following:

- ① the camera's power source (the AC adapter is not properly connected or the battery power is low)
- ② the card (there is no card in the camera or there is a problem with the card)  
Check that you can play back pictures on the monitor of your camera.
- ③ the USB cable (the camera is not properly connected to the computer by the USB cable).
- ④ Apple "File Exchange" extension is not enabled.
  - Please refer to your Apple operating system manual for instructions on how to enable this extension.

- 2** Double-click the “Dcim” folder.

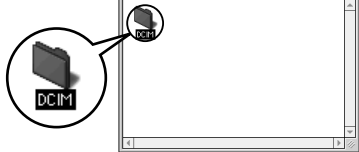

- 3** Double-click the “100OLYMP” folder.

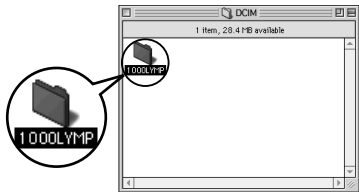
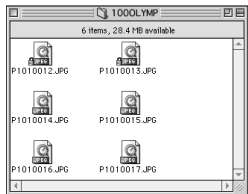
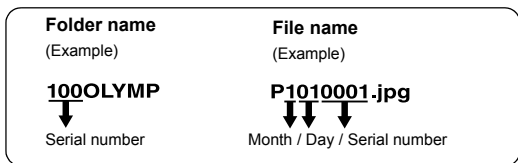

Image files (JPEG files) with file names such as "P1010001.JPG" are displayed.



- The camera automatically assigns folder names and file names according to the following rules.



- Serial numbers of image files run from 0001 to 9999.
- Serial numbers of folders run from 100 to 999.
- When file number 9999 is reached, a new folder is created and assigned the next number.
- Months January through September are expressed by the numbers 1 through 9, October by the letter A, November by B and December by C.

- 4 Double-click the "Macintosh HD" icon on the desktop.

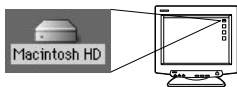

The “Hard Disk” window is displayed.

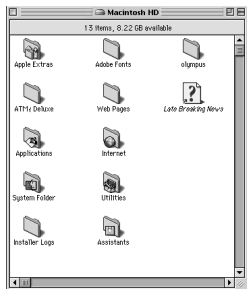

- 5** Drag & drop the image you want to save in the computer (in this case, P1010012.JPG) to the “Hard Disk” window.

The image is saved in the computer (in the Hard disk).

- To select all images, click Edit > Select all.

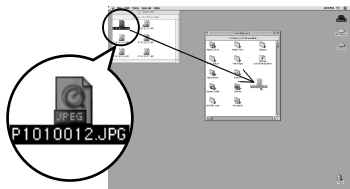

When the image file has been copied to the computer, you can view images by double-clicking the image files in the “Hard Disk” folder. The files will be opened in the default image viewer of the operating system. If you want to view the image a different size or process it, you will need to open the image with software that supports JPEG or TIFF images files, such as Paint Shop Pro, Photoshop or CAMEDIA Master software.



The lamp on the right of the viewfinder or the card access lamp blinks while the image is being copied. Never open the card cover on the camera, load or remove the batteries, or connect or disconnect the AC adapter while the lamp is blinking as the image files may be destroyed.



## ● Mac OS X

Malfunctions such as the following may occur due to the OS.

- If the camera is not connected correctly, a malfunction occurs in the computer.
- Date and time information of image files is not accurately displayed.
- If the card cover of the camera is opened while connecting to the computer, the “untitled” icon does not disappear from the desktop. etc.

When the computer has recognized the camera, the Apple Image Capture software dialog appears.

**1** From the “Download To” menu, select a destination folder.

**2** To download all images, click “Download All”.

To selectively download images, click “Download Some” and highlight the desired images.



The images are transferred from the camera to your computer.



Note

If you are operating Mac OS X and you want to download images using the same procedure as for Mac OS 9, select “File > Close” and exit the Apple Image Capture software. At this time, the camera is indicated as “unlabeled”.



Caution

If you use the Apple Image Capture software, images downloaded to your computer and transferred back to a card may not play back on the camera or may have other problems.

# Disconnecting the camera from your computer

- 1** Make sure that the lamp on the right of the viewfinder or the card access lamp is not blinking.

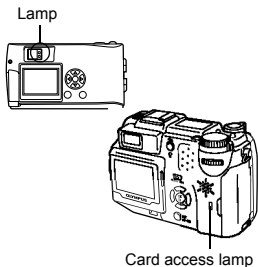

- 2** Drag the "untitled" icon on the desktop to "Trash".

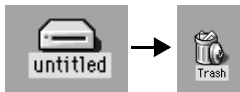

- 3** Make sure that the lamp on the right of the viewfinder or the card access lamp is not blinking.

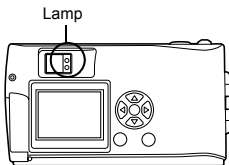

- 4** Remove the USB cable from the camera.

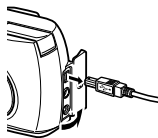

- 5** Remove the USB cable from your computer.

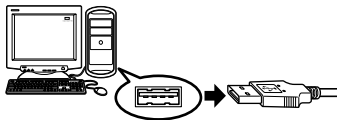

# Downloading image files using other OS (For other OS users)

Users running other OS cannot connect the camera directly to a computer.

● **Windows 95** ● **Windows NT** ● **Mac OS before OS 9**

You can download images directly to your computer using an optional floppy disk adapter or PC card adapter.

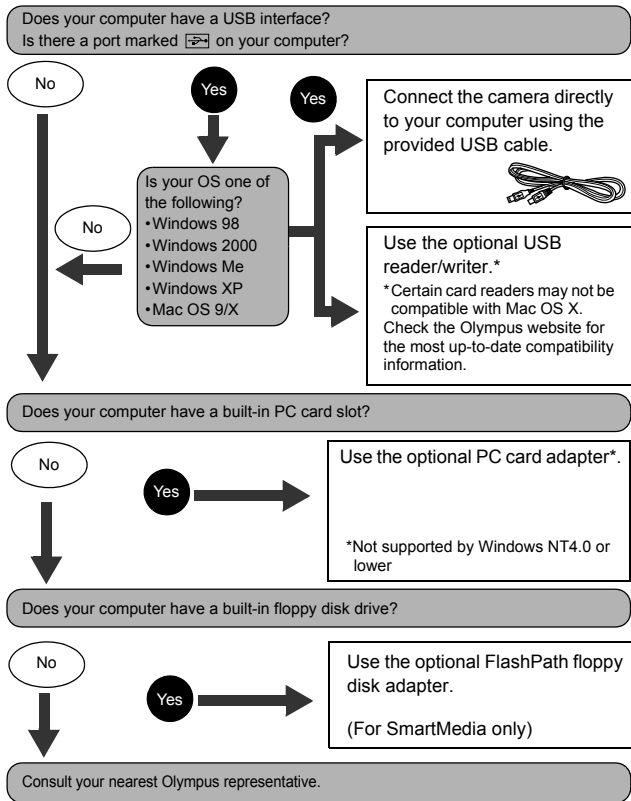

# OLYMPUS®

<http://www.olympus.com/>

## OLYMPUS OPTICAL CO., LTD.

Customer support (Japanese language only): Tel. 0426-42-7499 Tokyo

## OLYMPUS AMERICA INC.

Two Corporate Center Drive, Melville, NY 11747-3157, U.S.A. Tel. 1-631-844-5000

### Technical Support (USA)

24/7 online automated help: <http://support.olympusamerica.com/>

Phone customer support: Tel. 1-888-553-4448 (Toll-free)

Our phone customer support is available from 8 am to 10 pm (Monday to Friday) ET

E-Mail: [distec@olympus.com](mailto:distec@olympus.com)

Olympus software updates can be obtained at: <http://olympus.com/digital/>

## OLYMPUS OPTICAL CO. (EUROPA) GMBH.

Premises/Goods delivery: Wendenstrasse 14-18, 20097 Hamburg, Germany

Tel. +49(0)40-23 77 30/+49(0)40-23 77 33

Letters: Postfach 10 49 08, 20034 Hamburg, Germany

### European Technical Customer Support:

Please visit our homepage <http://www.olympus-europa.com>

or call our TOLL FREE NUMBER : **00800 - 67 10 83 00**

for Austria, Belgium, Denmark, Finland, France, Germany, Italy, Luxemburg, Netherlands, Norway, Portugal, Spain, Sweden, Switzerland, United Kingdom

- Please note some (mobile) phone services/provider do not permit access or request an additional prefix to +800 numbers.

For all not listed European Countries and in case that you can't get connected to the above mentioned number please make use of the following

**CHARGED NUMBERS: +49(0)1805-67 10 83 or +49(0)40-23 77 38 99**

Our Technical Customer Support is available from 9 am to 6 pm MET (Monday to Friday)

## Free Manuals Download Website

<http://myh66.com>

<http://usermanuals.us>

<http://www.somanuals.com>

<http://www.4manuals.cc>

<http://www.manual-lib.com>

<http://www.404manual.com>

<http://www.luxmanual.com>

<http://aubethermostatmanual.com>

Golf course search by state

<http://golfingnear.com>

Email search by domain

<http://emailbydomain.com>

Auto manuals search

<http://auto.somanuals.com>

TV manuals search

<http://tv.somanuals.com>