



4¹/₂" ANGLE GRINDER OPERATING MANUAL



WARNING:

Read carefully and understand **RULES FOR SAFE OPERATION** and instructions before operating.

Failure to follow the safety rules and other basic safety precautions may result in serious personal injury.

Item # 143379

READ ALL INSTRUCTIONS BEFORE OPERATING

SAVE THESE INSTRUCTIONS

Before attempting to operate your new Angle Grinder please read these instructions thoroughly. You will need these instructions for the safety warnings, precautions, assembly, operation, maintenance procedures, parts list and diagrams.

⚠ WARNING: The warnings, cautions and instructions discussed in this instruction manual cannot cover all possible conditions or situations that could occur. It must be understood by the operator that common sense and caution are factors which cannot be built into this product, but must be supplied by the operator.

TABLE OF CONTENTS

Description	Page #
Warranty.....	1
Specifications.....	1
Safety rules	1-2
Getting Started.....	3
Assembly	3
Operating Your Grinder.....	4
Tech Tips.....	4
Maintenance	5
Parts List and Diagram	6

SPECIFICATIONS

Motor	120V~ 60Hz – 8amp
No Load Speed.....	11,000 RPM
Weight.....	7 lbs
Overall Length.....	16.5"
Spindle Thread	5/8" - 11 UNC

SAFETY RULES

⚠ WARNING: The double-insulated system is intended to protect the user from shock resulting from a break in the tool's internal wiring. Observe all normal safety precautions related to avoiding electric shock.

1. Know your machine. Read this manual carefully. Learn the machine's applications and limitations, as well as specific potential hazards peculiar to it.
2. Ground all machines. This machine is "Double Insulated," meaning that all outside metal parts are insulated from electrical power. Double Insulated tools are equipped with a polarized plug. This plug will fit in a polarized outlet only one way. If the plug does not fit fully in the outlet, reverse the plug. If it still does not fit, contact a qualified electrician to install a polarized outlet. Do not attempt to circumvent this safety feature.

3. Do not expose tool to moisture. Don't use this machinery in damp or wet locations. Keep out of rain.
4. Keep work area clean. Cluttered areas invite injuries.
5. Keep children and pets away. All children should be kept away from the work area. Never let a child handle a tool without strict adult supervision.
6. Do not operate this tool if under the influence of alcohol or drugs or if you are tired. Read warning labels on prescriptions to determine if your judgment or reflexes are impaired while taking drugs. If there is any doubt, do not attempt to operate.
7. Use safety equipment. Eye protection should be worn at all times when operating this machine. Use ANSI approved safety glasses. Everyday eyeglasses only have impact resistance lenses. They are NOT safety glasses. Dust mask, respirator, non-skid safety shoes, hard hat, or hearing protection must be used in appropriate conditions.
8. Wear proper apparel. Loose clothing, gloves, neckties, rings, bracelets, or other jewelry may present a potential hazard when operating this machine. Please keep all apparel clear of the machine.
9. Don't overreach. Keep proper footing and balance at all times when operating this product.
10. Always disconnect the machine from power source before servicing or changing accessories.
11. Check for damage. Check your tool regularly. If part of the tool is damaged it should be carefully inspected to make sure it can perform its intended function correctly. If in doubt, the part should be repaired. Refer all servicing to a qualified technician. Consult your dealer for advice.
12. Keep away from flammables. Do not attempt to operate this tool near flammables or combustibles. Failure to comply may cause serious injury or death.
13. Do not start tool while it is resting on materials. Always turn tool on BEFORE coming in contact with material surface.
14. Do not set tool down until it has come to a complete stop.
15. Always check to make sure that trigger is not engaged before plugging tool in.
16. Keep hands clear of cutting edges and all moving parts.
17. Protect others in work area from debris such as chips and sparks. Provide barriers and shields as needed.
18. Secure work. Use a clamp, vise or other practical means to hold your work securely, freeing both hands to control the tool.
19. Use the right tool for the job. Do not use a tool or attachment to do a job for which it was not intended. Do not alter a tool.
20. Use proper accessories. Using accessories not recommended may be hazardous. Be sure accessories are properly installed and maintained. Do not defeat a guard or other safety device when installing an accessory or attachment.
21. Remove all adjusting keys and wrenches. Make a habit of checking that adjusting keys, wrenches, etc. are removed from the tool before turning it on.
22. Guard against electric shock. Prevent body contact with grounded surfaces such as pipes, radiators, ranges, and refrigerators. Hold your tool by insulated, non-metal grasping surfaces. Use a Ground Fault Circuit Interrupter (GFCI) to reduce shock hazards.

23. Avoid accidental starting. Be sure your tool is turned off before plugging it in. Do not use a tool if the power switch does not turn the tool on and off. Do not carry a plugged-in tool with your finger on the switch.
24. Do not force tool. Your tool will perform better at the rate for which it was designed. Excessive force only causes operator fatigue, increased wear and reduced control.
25. Do not abuse cord. Never carry your tool by its cord or unplug it by pulling the cord from the outlet. Pull the plug rather than the cord to reduce the risk of damage. Keep the cord away from heat, oil, sharp objects, cutting edges and moving parts.
26. Maintain tools carefully. Keep handles dry, clean and free from oil and grease. Follow instructions for lubricating and changing accessories. Periodically inspect tool cords and extension cords for damage. Refer all service to a qualified technician.
27. Store idle tools. When not in use, store your tool in a dry, secure place. Keep out of reach of children.
28. Never operate grinder without using a guard.

GETTING STARTED

Before operating your 4-1/2" Angle Grinder check the contents of the box to make sure you have everything you will need.

Items included in the box:

- 1 Operating Manual
- 1 4-1/2" Angle Grinder
- 1 Side/Top Mount Handle
- 1 Upper Spindle Nut
- 1 Lower Spindle Washer
- 1 Safety Guard
- 1 4-1/2" Grinding Disc
- 1 Spanner Wrench

Follow these instructions closely to insure optimum results.

ASSEMBLY

 **WARNING!** Your grinder should never be connected to power supply when you are assembling parts, making adjustments, installing or removing grinding wheels, or when not in use.

1. Choose the most comfortable position for your side/top mount handle. Screw the handle securely into one of the three handle ports located at the base of the gear housing.
2. Make sure tool is unplugged and lay it on its back with the spindle upright.
3. Remove upper spindle nut from spindle. (Turn counter clockwise. If spindle turns with spindle nut, depress spindle lock button -located on back of gear housing- and try again. Use of the included spanner wrench may be necessary to loosen upper spindle nut.)
4. After removing upper spindle nut, place 4-1/2" grinding disc into place. Line up flange on lower spindle washer with center hole of grinding disc.

 **WARNING:** Use only 4-1/2" disc rated for 11,000 RPM or higher.

5. Replace upper spindle nut. Flange of upper spindle nut should be facing downward so that it seats itself in the center reinforcement hub on the grinding disc.
6. Push in spindle lock button (located on the back side of the metal gear housing) and simultaneously tighten spindle nut with spanner wrench. Be sure to tighten nut securely.

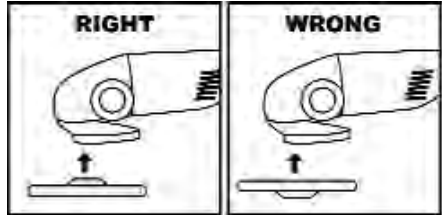

You are now ready to begin operation of your Angle Grinder.

OPERATING YOUR GRINDER

1. Plug Angle Grinder into standard 110/120 Volt wall socket.
2. Prior to contact with material surface, pull trigger switch to ON position.
3. Evenly and carefully, lower grinding disc surface to material surface. Do not apply excessive pressure. Forcing the grinder down against your work surface puts unnecessary strain on the motor and will likely produce undesired results in workmanship.
5. For extended work loads this tool is equipped with a "lock ON" switch. With trigger switch engaged, press lock switch with thumb. To release lock switch, press the trigger switch again.
6. When finished release trigger switch. Let the grinder come to a complete stop before resting tool on any surface.

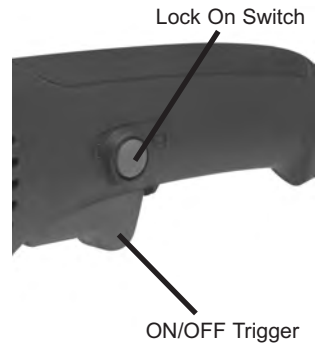

TECHNICAL TIPS

GRINDING

Always use side/top mount handle for control. Move the grinder back and forth in sweeping strokes. Too much pressure, the wrong angle or improper motion may cause burning. Be aware of your material's reaction to the grinding disc. Some materials may throw excessive sparks; some materials may conduct extreme heat from the point of contact.

Avoid unnecessary risks by staying alert and attentive at all times.

CUTTING

Always use side/top mount handle for control. Make sure your cutting disc is rated for AT LEAST 11,000 RPM. Pull trigger switch and carefully apply cutting blade edge to material to be cut. As with grinding, too much pressure, the wrong angle or improper motion may cause burning. Be aware of your material's reaction to the cutting disc. Some materials may throw excessive sparks; some materials may conduct extreme heat from the point of contact. Avoid unnecessary risks by staying alert and attentive at all times.

⚠ WARNING: To reduce the risk of injury, keep the cord away from the path of the grinder. Otherwise the cord may be caught by the disc; this may sever the cord and expose live wires or make the gear box electrically "live."

MAINTENANCE

Keep your tool in good condition by adopting a regular maintenance program. Before use, examine the general condition of your tool. Inspect guards, switches, tool cord and extension cord for damage. Check for loose screws, misalignment, binding of moving parts, improper mounting, broken parts, and any other condition that may affect its' safe operation. If abnormal noise or vibration occurs, turn the tool off immediately and have the problem corrected before further use. Do not use a damaged tool.

 **WARNING:** To reduce the risk of injury, always unplug your tool before performing any maintenance. Never disassemble the tool or try to do any rewiring on the tool's electrical system. Contact Northern for all repairs.

CLEANING

Clean dust and debris from vents. Keep the tool handles clean, dry and free of oil or grease. Use only mild soap and damp cloth to clean your tool since certain cleaning agents and solvents are harmful to plastics and other insulated parts. Some of these harmful solvents include: gasoline, turpentine, lacquer thinner, paint thinner, chlorinated cleaning solvents, ammonia, and household detergents containing ammonia. Never use flammable or combustible solvents around tools.

 **WARNING:** To reduce the risk of injury, electric shock and damage to the tool, never immerse your tool in liquid or allow liquid to flow inside the tool.

Parts List and Diagram

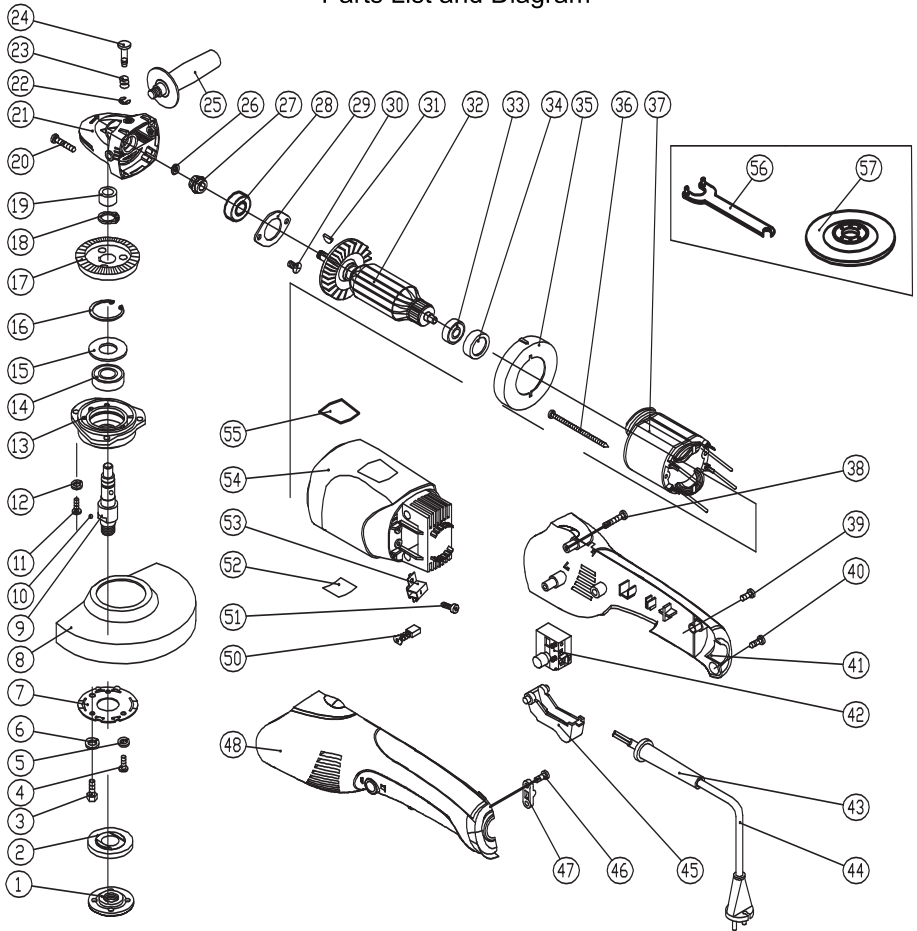

Part No.	Description	Qty.
01	Outer Flange	1
02	Inner Flange	1
03	Hex Screw	1
04	Screw	3
05	Spring Washer 04	3
06	Spring Washer 05	1
07	Disc Guard Cover	1
08	Disc Guard	1
09	Spindle	1
10	Stop Bearing	1
11	Screw	4
12	Spring Washer	4
13	Gear Housing Cover	1
14	Ball Bearing	1
15	Flat Washer	1
16	Circlip	1
17	Large Gear	1
18	Circlip	1
19	Bushing	1

Part No.	Description	Qty.
20	Screw	4
21	Gear Housing	1
22	e-ring	1
23	Brake Spring	1
24	Brake Pin	1
25	Side Handle	1
26	Nut	1
27	Pinion	1
28	Ball Bearing	1
29	Bearing Cover	1
30	Sink Screw	2
31	Key	1
32	Armature	1
33	Ball Bearing	1
34	Bushing	1
35	Guide Wind Circle	1
36	Screw	2
37	Stator	1
38	Screw	2

Part No.	Description	Qty.
39	Screw	1
40	Screw	1
41	Rear Handle (right)	1
42	ON/OFF Switch	1
43	Cord Sleeve	1
44	Power Cord	1
45	Switch Trigger	1
46	Screw	2
47	Cord Clamp	1
48	Rear Handle (left)	1
50	Carbon Brush	2
51	Screw	4
52	Spec Plate	1
53	Brush Holder	2
54	Housing	1
55	Name Plate	1
56	Wrench	1
57	Grinding Disc	1

WARNING!

Some dust created by power sanding, sawing, grinding, and other construction activities contains chemicals known to cause cancer, birth defects, or other reproductive harm. Some examples of these chemicals are:

- Lead, from lead-based paints
- Crystalline silica, from bricks, cement, and other masonry products
- Arsenic and chromium, from chemically treated lumber

Your risk from these exposures varies, depending on how often you do this type of work. To reduce your exposure to these chemicals: work in a well-ventilated area, and use approved personal protective equipment, such as dust masks that are specially designed to filter out microscopic particles.



Northern Tool + Equipment Co.,
2800 Southcross Drive West
P.O. Box 1499 Burnsville, MN55337-0499
Made in China

Free Manuals Download Website

<http://myh66.com>

<http://usermanuals.us>

<http://www.somanuals.com>

<http://www.4manuals.cc>

<http://www.manual-lib.com>

<http://www.404manual.com>

<http://www.luxmanual.com>

<http://aubethermostatmanual.com>

Golf course search by state

<http://golfingnear.com>

Email search by domain

<http://emailbydomain.com>

Auto manuals search

<http://auto.somanuals.com>

TV manuals search

<http://tv.somanuals.com>