

Nikon

Communication Unit

UT-1

.....
User's Manual

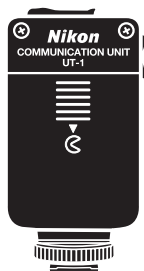

What the UT-1 Can Do for You

What the UT-1 Can Do for You

This manual describes how to connect to a network and upload pictures to a computer or ftp server or control the camera remotely using Camera Control Pro 2. Use the UT-1 to connect to Ethernet networks, or connect to wireless networks by attaching a WT-5 to the UT-1.

Connecting to a Network

Ethernet Networks

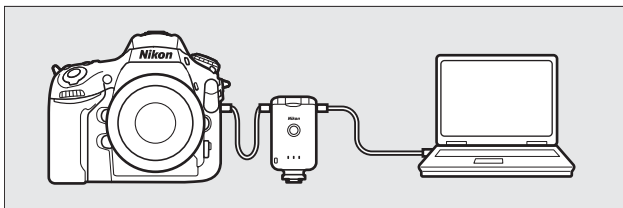

For information on connecting to a computer, see page 19.
For information on connecting to an ftp server, see page 49.

Wireless Networks

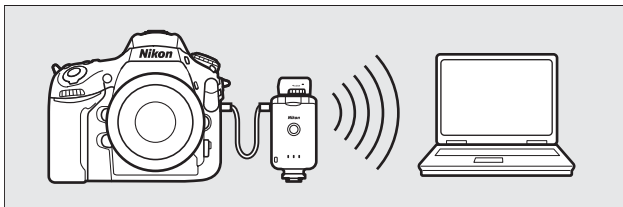

Connect to wireless networks using a WT-5 wireless transmitter (8).
For information on connecting to a computer, see page 19.
For information on connecting to an ftp server, see page 49.

Network Connections

Once a network connection has been established, you can:

Upload existing pictures (36)

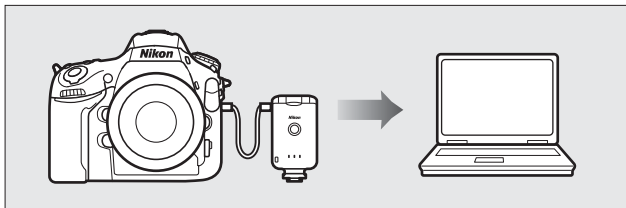

Control the camera remotely using Camera Control Pro 2 (45)

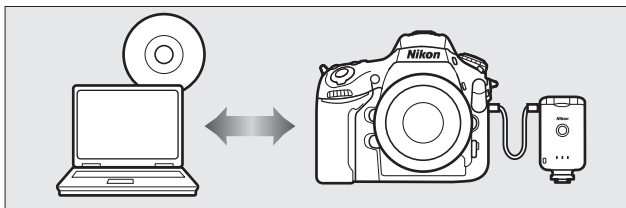

Upload pictures to an ftp server (49)

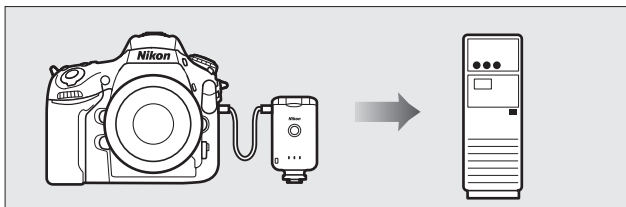

Trademark Information

Mac OS is a trademark of Apple Computer, Inc. Microsoft, Windows, and Windows Vista are registered trademarks of Microsoft Corporation. All other trade names mentioned in this manual or the other documentation provided with this Nikon product are trademarks or registered trademarks of their respective holders.

Apple Public Source License

This product includes Apple mDNS source code that is subject to the terms of the Apple Public Source License located at URL

<http://developer.apple.com/opensource/>.

Copyright © 2012 Apple Computer, Inc. All Rights Reserved.

This file contains Original Code and/or Modifications of Original Code as defined in and that are subject to the Apple Public Source License Version 2.0 (the 'License'). You may not use this file except in compliance with the License. Please obtain a copy of the License at

<http://www.opensource.apple.com/license/apsl/> and read it before using this file.

The Original Code and all software distributed under the License are distributed on an 'AS IS' basis, WITHOUT WARRANTY OF ANY KIND, EITHER EXPRESS OR IMPLIED, AND APPLE HEREBY DISCLAIMS ALL SUCH WARRANTIES, INCLUDING WITHOUT LIMITATION, ANY WARRANTIES OF MERCHANTABILITY, FITNESS FOR A PARTICULAR PURPOSE, QUIET ENJOYMENT OR NON-INFRINGEMENT. Please see the License for the specific language governing rights and limitations under the License.

For Your Safety

To prevent damage to your Nikon product or injury to yourself or to others, read the following safety precautions in their entirety before using this equipment. Keep these safety instructions where all those who use the product will read them.

The consequences that could result from failure to observe the precautions listed in this section are indicated by the following symbol:



This icon marks warnings, information that should be read before using this Nikon product to prevent possible injury.

⚠ WARNINGS

⚠ Do not disassemble

Failure to observe this precaution could result in fire, electric shock, or other injury. Should the product break open as the result of a fall or other accident, disconnect the camera power source and take the product to a Nikon-authorized service representative for inspection.

⚠ Cut power immediately in the event of malfunction

Should you notice smoke or an unusual smell coming from the equipment, immediately unplug the AC adapter and remove the battery, taking care to avoid burns. Continued operation could result in injury. After removing the battery, take the equipment to a Nikon-authorized service representative for inspection.

⚠ Do not use in the presence of flammable gas

Failure to observe this precaution could result in explosion or fire.

⚠ Keep dry

Do not immerse in or expose to water or rain. Failure to observe this precaution could result in fire or electric shock.

⚠ Do not handle with wet hands

Failure to observe this precaution could result in electric shock.

⚠ Keep out of reach of children

Failure to observe this precaution could result in injury.

⚠ Avoid extended contact

Do not remain in contact with the camera, communication unit, battery, or charger for extended periods while the products are on or in use. Parts of the product become hot; leaving the product in direct contact with the skin for extended periods may result in low-temperature burns.

⚠ Observe proper precautions when handling batteries

Batteries may leak or explode if improperly handled. Observe the following precautions when handling batteries for use in this product:

- Be sure the product is off before replacing the battery. If you are using an AC adapter, be sure it is unplugged.
- Use only batteries approved for use in this equipment.
- Do not attempt to insert the battery upside down or backwards.
- Do not short or disassemble the battery.
- Do not expose the battery to flame or to excessive heat.
- Do not immerse in or expose to water.
- Replace the terminal cover when transporting the battery. Do not transport or store with metal objects such as necklaces or hairpins.
- Batteries are prone to leakage when fully discharged. To avoid damage to the product, be sure to remove the battery when no charge remains.
- When the battery is not in use, attach the terminal cover and store in a cool place.
- Immediately after use, or when the product is used on battery power for an extended period, the battery may become hot. Before removing the battery, turn the product off and allow the battery to cool.
- Discontinue use immediately should you notice any changes in the battery, such as discoloration or deformation.

⚠ Do not expose to high temperatures

Do not leave the device in a closed vehicle under the sun or in other areas subject to extremely high temperatures. Failure to observe this precaution could result in fire or in damage to the casing or internal parts.

⚠ CD-ROMs

The CD-ROMs on which the software and manuals are distributed should not be played back on audio CD equipment. Playing CD-ROMs on an audio CD player could cause hearing loss or damage the equipment.

Notices

- No part of the manuals included with this product may be reproduced, transmitted, transcribed, stored in a retrieval system, or translated into any language in any form, by any means, without Nikon's prior written permission.
- Nikon reserves the right to change the specifications of the hardware and software described in these manuals at any time and without prior notice.
- Nikon will not be held liable for any damages resulting from the use of this product.
- While every effort has been made to ensure that the information in these manuals is accurate and complete, we would appreciate it were you to bring any errors or omissions to the attention of the Nikon representative in your area (address provided separately).

This product, which contains encryption software developed in the United States, is controlled by the United States Export Administration Regulations and may not be exported or re-exported to any country to which the United States embargoes goods. The following countries are currently subject to embargo: Cuba, Iran, North Korea, Sudan, and Syria.

CAUTION

RISK OF EXPLOSION IF BATTERY IS REPLACED BY AN INCORRECT TYPE.
DISPOSE OF USED BATTERIES ACCORDING TO THE INSTRUCTIONS.

Notice for Customers in the U.S.A.

U.S.A. Federal Communications Commission (FCC) Declaration of Conformity

Notices

FCC Radio Frequency Interference Statement

This equipment has been tested and found to comply with the limits for a Class B digital device, pursuant to Part 15 of the FCC rules. These limits are designed to provide reasonable

protection against harmful interference in a residential installation. This equipment generates, uses, and can radiate radio frequency energy and, if not installed and used in accordance with the instructions, may cause harmful interference to radio communications. However, there is no guarantee that interference will not occur in a particular installation. If this equipment does cause harmful interference to radio or television reception, which can be determined by turning the equipment off and on, the user is encouraged to try to correct the interference by one or more of the following measures:

- Reorient or relocate the receiving antenna.
- Increase the separation between the equipment and receiver.
- Connect the equipment into an outlet on a circuit different from that to which the receiver is connected.
- Consult the dealer or an experienced radio/television technician for help.

CAUTIONS

Modifications

The FCC requires the user to be notified that any changes or modifications made to this device that are not expressly approved by Nikon Corporation may void the user's authority to operate the equipment.

Interface Cables

Use the interface cables sold or provided by Nikon for your equipment. Using other interface cables may exceed the limits of Class B Part 15 of the FCC rules.

Notice for Customers in the State of California, U.S.A.

WARNING: Handling the cord on this product will expose you to lead, a chemical known to the State of California to cause birth defects or other reproductive harm. **Wash hands after handling.**

Nikon Inc.,

1300 Walt Whitman Road, Melville, New York

11747-3064, U.S.A. Tel.: 631-547-4200



Notices for Customers in Canada

CAUTION : This class B digital apparatus complies with Canadian ICES-003.

ATTENTION : Cet appareil numérique de la classe B est conforme à la norme NMB-003 du Canada.

Notices for Customers in Europe

Symbol for Separate Collection in European Countries

The following apply only to users in European countries:

This symbol indicates that this product is to be collected separately.

- This product is designated for separate collection at an appropriate collection point. Do not dispose of as household waste.
- For more information, contact the retailer or the local authorities in charge of waste management.



Notice for Customers in Thailand

This telecommunication equipment conforms to NTC technical requirements.

Table of Contents

What the UT-1 Can Do for You	ii
For Your Safety	v
Notices	vii
<hr/>	
Introduction	1
Parts of the UT-1	2
Supported Modes	6
Connecting the WT-5	8
Workflow	9
Preparing the UT-1	10
Installing the Wireless Transmitter Utility	14
<hr/>	
Using the UT-1 with a Computer	19
Copying Network Profiles to the Camera	20
Uploading Pictures to a Host Computer	33
Connecting the UT-1	33
Uploading Images	36
PC Mode	42
Connecting to the Computer	42
Controlling the Camera	45
<hr/>	
Uploading Pictures to an ftp Server	49
Copying Network Profiles to the Camera	50
Connecting to the ftp Server	62
Uploading Images	65

Menu Guide	71
Mode	72
Choose Profile	72
FTP Registration (Transfer Mode Only)	73
Editing ftp Profiles (for Connection to ftp Servers Only)	73
Transfer Settings	89
Auto Send	89
Delete After Send?	89
Send File As.....	90
Send Folder.....	90
Deselect All?.....	90
Print	91
Device Info	92
Battery Info.....	92
MAC Address.....	92
Firmware Version.....	92
Device Settings	93
Auto Power Off.....	93
Format Transmitter's Memory.....	93

Appendices	95
Creating an FTP Server	95
Windows 7.....	96
Windows Vista.....	103
Windows XP	110
Mac OS X 10.6.....	114
Creating ftp Profiles Using Camera Menus	116
Troubleshooting	119
Specifications.....	121
Index	124

Background Knowledge

This manual assumes basic knowledge of ftp servers and local area networks (LANs). For more information on installing, configuring, and using devices in a network, contact the manufacturer or network administrator.

Illustrations

The Nikon D800 and D800 menus are used in this manual for illustrative purposes. Save where otherwise noted, all software and operating system dialogs, messages, and displays are taken from Windows 7 Ultimate or Mac OS X. Their actual appearance and content may vary with the operating system used. For information on basic computer operations, see the documentation provided with the computer or operating system.

Life-Long Learning

As part of Nikon's "Life-Long Learning" commitment to ongoing product support and education, continually-updated information is available online at the following sites:

- For users in the U.S.A.: <http://www.nikonusa.com/>
- For users in Europe and Africa: <http://www.europe-nikon.com/support/>
- For users in Asia, Oceania, and the Middle East: <http://www.nikon-asia.com/>

Visit these sites to keep up-to-date with the latest product information, tips, answers to frequently-asked questions (FAQs), and general advice on digital imaging and photography. Additional information may be available from the Nikon representative in your area. See the following URL for contact information: <http://imaging.nikon.com/>

The D4

The **Wireless transmitter** option in the D800 setup menu performs the same function as the D4 **Network** option, while the options in the D800 **Device info** and **Device settings** menus can be found under **Network > Device info and settings**. When using the UT-1 with a D4, select **WT-4** for **Network > Choose hardware**.



Introduction

Thank you for your purchase of a UT-1 communication unit for compatible Nikon digital cameras. Please read this manual thoroughly and keep it where all those who use the product can read it.

The following symbols and conventions are used throughout this manual:



This icon marks cautions, information that should be read before use to prevent damage to the product.



This icon marks notes, information that should be read before using the device.



This icon marks references to other pages in this manual.

Parts of the UT-1

Parts of the UT-1

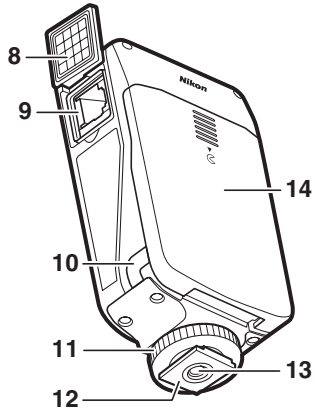
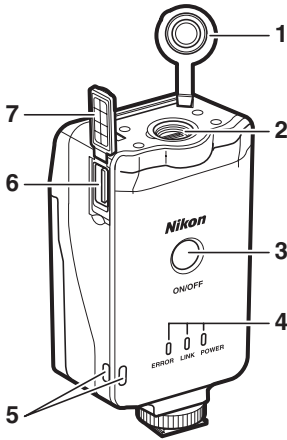

- 1 Peripheral connector cover
- 2 Peripheral connector
- 3 Power switch 35, 43, 64
- 4 Status LEDs 3, 40
POWER (green/yellow),
LINK (green), **ERROR** (orange)
- 5 Eyelet for strap
- 6 USB connector 33, 62

- 7 USB connector cover 33, 62
- 8 Ethernet connector cover
- 9 Ethernet connector
- 10 Power connector cover
- 11 Locking screw
- 12 Feet
- 13 Tripod socket
- 14 Battery-chamber cover 10

The POWER LED

When the UT-1 is on, the **POWER** LED glows green to indicate that the battery is fully charged or that an AC adapter is connected. At battery levels below 10%, it will flash green to warn that the battery requires charging. When the UT-1 is turned off, the **POWER** LED briefly turns yellow as the product powers down.

Supplied Accessories

The following accessories are supplied with the UT-1 (batteries such as the EN-EL15 and the battery chargers such as the MH-25 are not supplied):

- User's Manual* (this manual)
- Warranty
- CD
- Case
- Communication unit USB cable A (for use with D4 and D7000 cameras)
- Communication unit USB cable B (for use with D800 and D800E cameras)
- UF-3 USB cable cover
- UF3-RU14 USB cable gasket for the UT-1

In addition, the following accessories are supplied when the UT-1 is purchased as a set with the WT-5:

- WT-5 wireless transmitter
- WT-5 User's Manual*
- Going Wireless with a D4 Digital SLR Camera and WT-5 Wireless Transmitter*

Attaching the UT-1

The UT-1 can be mounted on a tripod or the camera accessory shoe. To mount the UT-1 on the camera when a flash unit or other accessory is mounted on the accessory shoe, use an optional SK-7 bracket.

To mount the UT-1 on the camera accessory shoe:

1 Remove the accessory shoe cover.

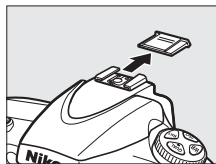

2 Slide the UT-1 onto the accessory shoe.

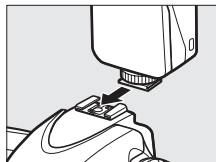

3 Tighten the locking screw.

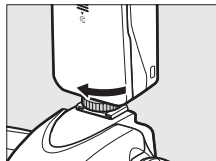

USB Cable Gaskets and Connector Covers

The USB cable gaskets and connector covers prevent accidental disconnections. Attach as shown below.

Camera

When connecting the USB cable to a D4, attach the optional UF-1 connector cover as shown.

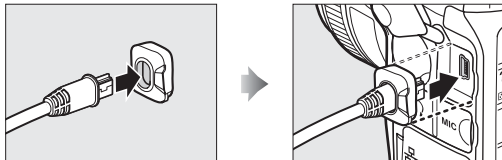

When connecting the USB cable to a D800 or D800E, attach the supplied UF-3 cable cover as shown.

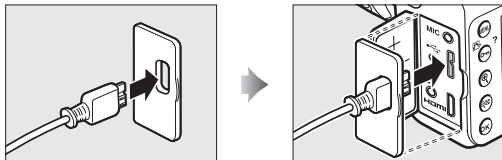

UT-1

When connecting the USB cable to the UT-1, attach the supplied UF3-RU14 cable gasket as shown.

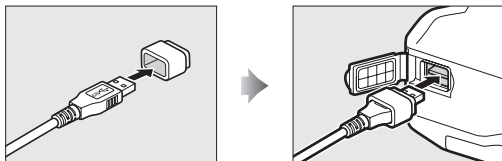

Supported Modes

The UT-1 connects the camera to Ethernet and, with the addition of an optional WT-5 wireless transmitter, wireless networks. Photographs on the camera can then be transmitted to a computer ftp server and the camera controlled remotely from a computer. The UT-1 supports the following modes:

Mode	Host	Description	See
Transfer mode	Computer or ftp server	Upload new photographs or existing photographs and movies to host.	📖33, 62
PC mode	Computer	Control camera from computer using optional Camera Control Pro 2 software.	📖42

Thumbnail select and print modes are not supported. Before data can be transferred over a wireless or Ethernet network, the camera must be supplied with a *network profile* providing information on the host computer or ftp server.

FTP Servers

Servers can be configured using standard ftp services available with supported operating systems, such as IIS (Internet Information Services). Connection to computers on other networks via a router, Internet ftp connections and ftp servers running third-party software are not supported.

Ethernet Connection

The camera can not connect to a wireless LAN when an Ethernet cable is connected. Before connecting to a wireless LAN, turn the UT-1 off and disconnect the Ethernet cable.

No adjustments to wireless LAN settings are required when the camera is connected to a LAN by an Ethernet cable.

Routers

Connection to computers on other networks via a router is not supported.

Firewall Settings

The UT-1 uses TCP ports 21 and 32768 through 61000 for ftp and TCP port 15740 and UDP port 5353 when connecting to a computer. Computer firewalls must be configured to allow access to these ports, as otherwise the computer may not be able to access the UT-1.

MAC Address Filtering

If the network uses MAC address filtering and the UT-1 is connected to a WT-5, the filter must be supplied with the MAC address of the WT-5. After connecting the WT-5, choose **Device info > MAC address** (□92) from the camera setup menu and note the wireless and Ethernet MAC addresses.

Connecting the WT-5

The UT-1 can be used in combination with the optional WT-5 wireless transmitter to connect to wireless LANs. The WT-5 connects as described below.

- 1 Open the UT-1 peripheral connector cover.

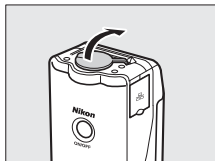

- 2 Fully insert the WT-5 connector into the UT-1 peripheral connector.

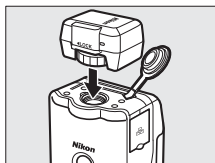

- 3 Rotate the locking wheel to lock the WT-5 in place.



D4 Cameras

Even when connected to a WT-5, the UT-1 functions as a WT-4 wireless transmitter. Select **WT-4** for **Network > Choose hardware** in the camera setup menu.

Workflow

When using the UT-1 for the first time, follow the steps below to set up the UT-1, install the required software and upload pictures to the computer.

1 Set up the UT-1 and install software (📖 2).

- 1-1 Preparing the UT-1
 - 1-2 Installing the Wireless Transmitter Utility
-



2 Upload pictures.

Uploading Pictures to a Host Computer (📖 19).

- 2-1 Copying Network Profiles to the Camera
- 2-2 Connecting the UT-1
- 2-3 Uploading Images

Uploading Pictures to an ftp Server (📖 49).

- 2-1 Copying Network Profiles to the Camera
 - 2-2 Connecting to the ftp Server
 - 2-3 Uploading Images
-

Preparing the UT-1

Inserting the Battery

To prevent loss of power during setup or upload, use a fully-charged battery or an optional AC adapter. The UT-1 takes one EN-EL15 rechargeable Li-ion battery; other batteries can not be used.

- 1** Slide (①) and open (②) the battery-chamber cover.

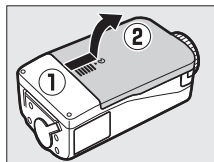

- 2** Insert the battery in the orientation shown. For safety precautions and information on charging the battery, see the battery and charger manuals.

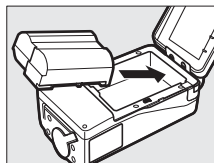

- 3** Close the battery-chamber cover.

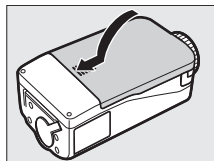

Removing the Battery

Being careful not to drop the battery, open the battery-chamber cover and remove the battery as shown at right.

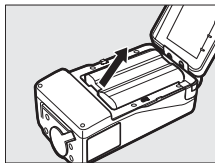

Stand-By Mode

When disconnected from the camera, the UT-1 will turn off automatically after the delay chosen for the **Auto power off** option in the **Wireless transmitter** menu (☞93), reducing the drain on the battery.

Battery Level

The level of the battery inserted in the UT-1 can be determined by connecting the UT-1 to the camera (☞33, 62) and checking the battery level using the **Battery info** option (☞92) in the camera setup menu.

Using an AC Adapter

An optional EP-5B power connector and EH-5b or EH-5/EH-5a AC adapter can also be used to power the camera when the UT-1 is connected.

Connecting the Adapter

1 Insert the power connector.

Open the UT-1 battery-chamber (①②) and power connector (③) covers and then insert the EP-5B power connector in the orientation shown (④). Position the power connector so that it passes through the power connector slot (⑤) and close the battery-chamber cover.

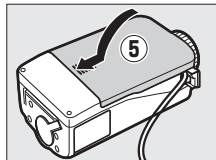
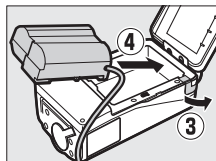
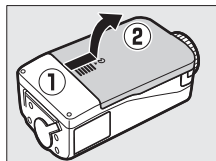

2 Connect the AC adapter.

Connect the AC adapter power cable to the AC socket on AC adapter (①) and the EP-5B power cable to the DC socket (②).

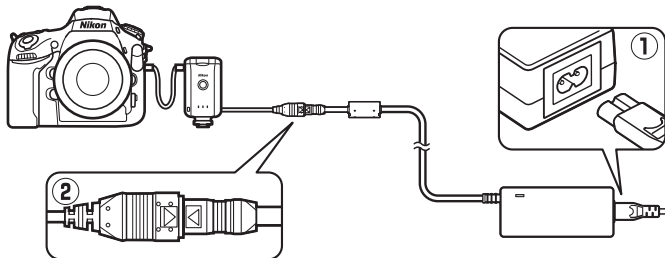

3 Plug the adapter in.

If the adapter power lamp does not light when the adapter is plugged in, consult a Nikon-authorized service representative.

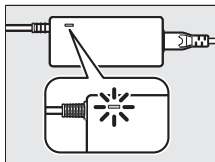

4 Turn the UT-1 on.

Press the power switch for about a second to turn the UT-1 on. When using the AC adapter, be careful that the cords do not become disconnected.

Disconnecting the Adapter

1 Unplug the adapter.

Turn the UT-1 off and unplug the adapter from the power outlet.

2 Disconnect the EP-5B.

Disconnect the EP-5B power cable from the AC adapter. Be sure to pull on the connector, not the cable.

3 Remove the EP-5B.

Open the battery-chamber cover and remove the EP-5B.

Installing the Wireless Transmitter Utility

This section describes how to install the Wireless Transmitter Utility. The Wireless Transmitter Utility is used to copy network profiles to the camera and is required when configuring the camera for connection to a computer in transfer and PC modes (either the Wireless Transmitter Utility or the camera menus can be used for connection to ftp servers in transfer mode; see page 116 for information on using the camera menus for ftp).

Follow the steps below to install the Wireless Transmitter Utility under Windows 7, Windows Vista, Windows XP, or Mac OS X.

System Requirements

Before using the UT-1, WT-5, or the Wireless Transmitter Utility, confirm that your system meets the following requirements:

Camera ¹	Nikon D4, D800, D800E, and D7000 digital single-lens reflex cameras. For information on whether more recent models support the UT-1, see the camera manual.
Power source	One EN-EL15 rechargeable Li-ion battery or EP-5B power connector and EH-5b AC adapter (available separately)

OS ²	<ul style="list-style-type: none"> • To connect to a computer: Pre-installed versions of Windows 7 Home Basic/Home Premium/Professional/Enterprise/Ultimate (Service Pack 1, 64- and 32-bit versions), Windows Vista Home Basic/Home Premium/Business/Enterprise/Ultimate (Service Pack 2, 64- and 32-bit versions), Windows XP Home Edition/Professional (Service Pack 3, 32-bit version only), or Mac OS X version 10.6.8 or 10.7.4 (Intel CPUs only). • To upload pictures to an ftp server: Windows 7 Home Basic/Home Premium/Professional/Enterprise/Ultimate (Service Pack 1), Windows Vista Home Basic/Home Premium/Business/Enterprise/Ultimate (Service Pack 2), Windows XP Home Edition/Professional (Service Pack 3), and Mac OS X version 10.6.8
Network	<ul style="list-style-type: none"> • Wireless: WT-5 wireless transmitter and wireless LAN access point or computer with built-in or external wireless LAN adapter (IEEE 802.11n, 802.11b, 802.11g, or 802.11a compliant). • Ethernet: Ethernet cable and computer with built-in or external Ethernet port (100 base-TX or 10 base-T)
Miscellaneous	<ul style="list-style-type: none"> • Wireless Transmitter Utility: required to copy computer profiles to camera.³ • CD-ROM drive: required when using supplied CD. • USB: the supplied USB cable and a computer with built-in USB port are required when copying network profiles to camera.⁴

1. Be sure to update to the latest versions of the UT-1 firmware and supplied software.
2. For the latest information on supported operating systems, see the Nikon website for your area (□xii).
3. Not required for connection to ftp servers.
4. Connect the camera directly to the computer. The camera may not function as expected when connected via a hub, extension cable, or keyboard.

❑ Installing Software

Before connecting to a network, install the Wireless Transmitter Utility. The Wireless Transmitter Utility is required for pairing in image transfer and PC modes and can be used to create network profiles.

Before installing the software, confirm that your computer meets the system requirements on page 14. Be sure to update to the latest versions of the camera and wireless transmitter firmware and the Wireless Transmitter Utility.

1 Double-click the installer icon.

Using the supplied CD, download the Wireless Transmitter Utility from a Nikon website. When download is complete, double-click the installer icon.



2 Select a language (Windows only).

Select a language and click **Next**.

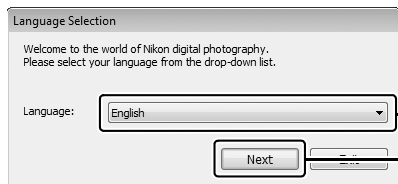

① Select language

② Click **Next**

3 Start the installer.

Click **Next** (Windows) or **Continue** (Mac OS) and follow the on-screen instructions.



Click **Next**



Click **Continue**

4 Exit the installer.

Click **OK** (Windows) or **Close** (Mac OS) when installation is complete.



Click **OK**



Click **Close**

The WT-4 Setup Utility

The Wireless Transmitter Utility must be reinstalled if the WT-4 Setup Utility or other Nikon software for wireless networks is installed after installation is complete.

Using the UT-1 with a Computer

The UT-1 can be used in the following modes (thumbnail select and printer modes are not supported):

- **Transfer mode:** Upload images to a computer.
- **PC mode:** Control the camera from a computer using Camera Control Pro 2 (available separately).

The workflow for each of these modes is shown below.

1 Copying Network Profiles to the Camera (📖 20).



2 Upload pictures.

Uploading Pictures to a Host Computer (📖 33–41).

- 2-1 Connecting the UT-1
- 2-2 Uploading Images

PC Mode (📖 42–47).

- 2-1 Connecting to the Computer
- 2-2 Controlling the Camera

☑ Before Connecting

Complete network settings on the computer before connecting.

Copying Network Profiles to the Camera

Before copying network profiles, confirm that the computer is running and the user is logged in.

- 1 Connect the USB cable supplied with the camera.

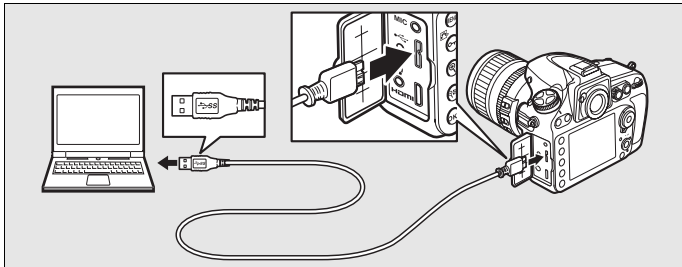

- 2 Turn the camera on.

Power switch

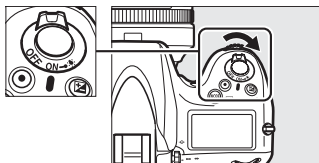

- 3 Start the Wireless Transmitter Utility.

- **Windows:** Double-click the **Wireless Transmitter Utility** icon on the desktop.
- **Mac OS X:** Click the **Wireless Transmitter Utility** icon in the Dock.

- 4** The dialog shown below will be displayed; click **Next**.



- 5** Select **WT-4** and click **Next** (note that you should select **WT-4** even when the UT-1 is connected to a WT-5 wireless transmitter).

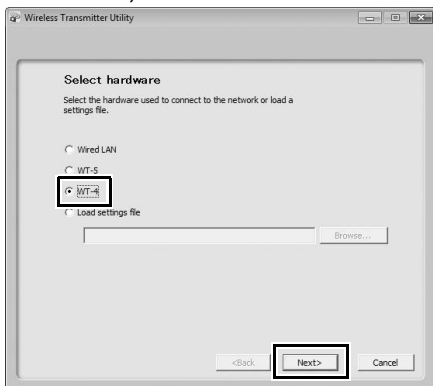

6 Select **Add/Edit profiles** and click **Next**.

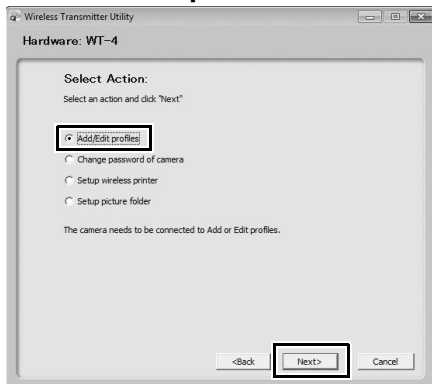

The “Select Action” Dialog

The other options in the “Select Action” dialog are described below.

- **Change password:** The dialog shown at right will be displayed. By default, no password is required to change device profiles using the Wireless Transmitter Utility. A password can be added by selecting **Change password**. If the camera is later connected to a different computer, a password prompt will be displayed. Once the correct password has been entered, the prompt will not be displayed again. To change an existing password, enter the old password before typing the new password. To remove the password, select **Reset password (profiles will be lost)** and click **Next**. Please note that resetting the password deletes all existing device profiles from the camera. Click **Back** to exit without changing password settings.

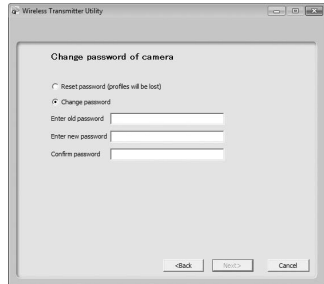

- **Setup picture folder:** The dialog shown at right will be displayed. This screen allows you to select the destination folder when downloading images to your computer in transfer mode. Click the **Browse...** button to select the destination for images uploaded to the computer (the camera need not be connected for this operation). The default destination is the “UT-1” folder in “My Pictures” (Windows XP) or “Pictures” (other versions of Windows).

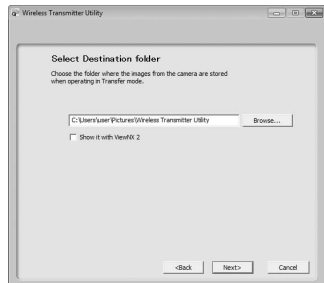

- **Show it with ViewNX 2:** If this option is selected, uploaded images will be displayed in ViewNX 2 when the connection with the UT-1 is terminated. This option is only available if ViewNX 2 is installed.

7 Select **Add new profile** and click **Next**.

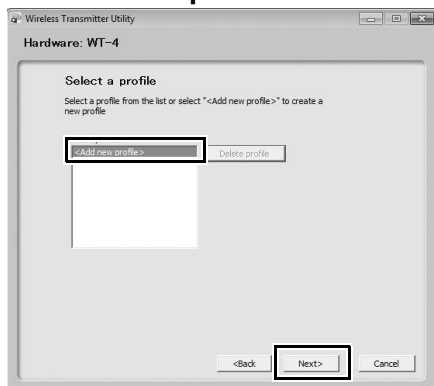

8 Enter the following information and click **Next**:

- **Profile name:** Enter a name of up to 16 characters.
- **Connection type:** Choose **Computer**.
- **Interface type:** Choose **Wireless & Ethernet** for networks that include wireless; if you will not be connecting to a wireless network, select **Ethernet only** and proceed to Step 11.

Wireless Transmitter Utility

Hardware: WT-4

Enter profile name

Enter a name for the new profile and select the type of profile and interface

Profile name:

Connection type:

Interface type:

Help <Back **Next>** Cancel

9 Select **Manual setup** and click **Next**.

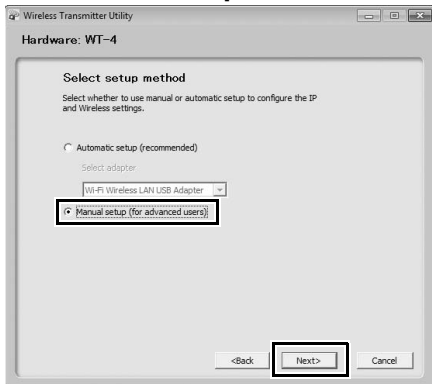

"Automatic Setup"

Choose **Automatic setup (recommended)** when using a new network for the first time. The following dialog will be displayed; select **Ad hoc**, or select **Infrastructure network (recommended)** and choose a network from the pull-down menu. Click **Next** to proceed to Step 11 (□ 30).

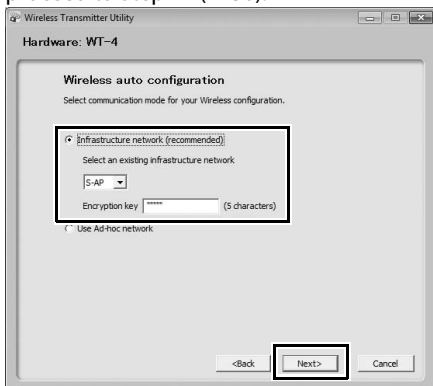

The **Automatic setup (recommended)** option can not be used with existing network profiles, third-party wireless LAN adapters, networks using static IP addresses, or Mac OS X.

10 Enter the following information and click **Next**.

- **Network name (SSID):** Enter a network name or choose from a list of existing networks. Do not change the name if it is supplied automatically.
- **Communication mode:** Select **Infrastructure** or **Ad-hoc**.
- **Channel:** Select a channel (ad hoc only; in infrastructure mode, the UT-1 will choose the channel automatically). Note that if a matching SSID is detected on a different channel, the UT-1 may change the channel automatically.
- **Authentication:** The authentication used on the network. Choose from open system, shared key, WPA-PSK, and WPA2-PSK (infrastructure) or from open system and shared key (ad hoc).
- **Encryption:** The encryption used on the network. The options available depend on the authentication used.
 - Open:** None; 64- or 128-bit WEP
 - Shared:** 64- or 128-bit WEP
 - WPA-PSK:** TKIP; AES
 - WPA2-PSK:** AES
- **Encryption key:** If the network uses encryption, enter the network key. The number of characters required depends on the type of key used:

	WEP (64-bit)	WEP (128-bit)	TKIP, AES
Number of characters (ASCII)	5	13	8–63
Number of characters (hex)	10	26	64

Note that depending on the device and the key setting used, the UT-1 may fail to connect. If this occurs, try choosing a different key setting.

- **Key index:** If **WEP64** or **WEP128** is selected for **Encryption**, choose a key index (the default index is **1**). A key index is not required when **None** is selected.

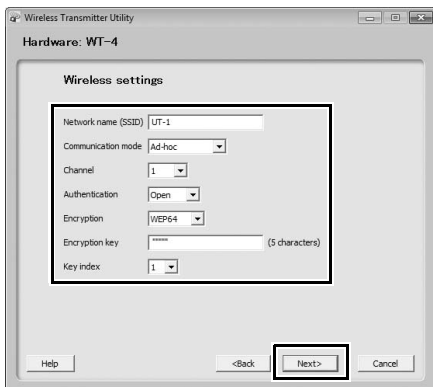

11 If the network is configured to supply IP addresses automatically using a DHCP server or Auto IP, select **Obtain IP address automatically** and click **Next**. Otherwise remove the check from this option and enter the following information before clicking **Next**:

- **Obtain IP address automatically:** Select this option if the network is configured to supply IP addresses automatically. If the network does not include a DHCP server, addresses will be supplied by Auto IP.
- **IP address:** If the network is configured for manual IP addressing, enter an IP address for the UT-1.
- **Subnet mask:** If the network is configured for manual IP addressing, enter a subnet mask for the UT-1.
- **Default gateway:** If the network requires a gateway address, select this option and enter the address supplied by the network administrator.
- **DNS Server:** If a Domain Name Server exists on the network, select this option and enter the address supplied by the network administrator.

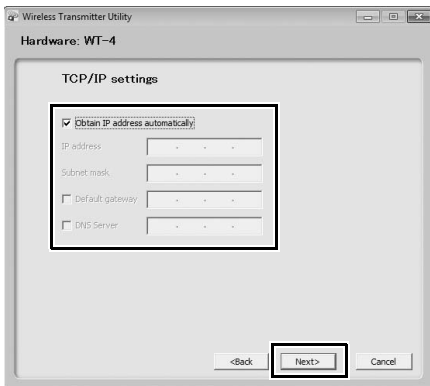

12 Confirm that settings are correct and click **Next**.

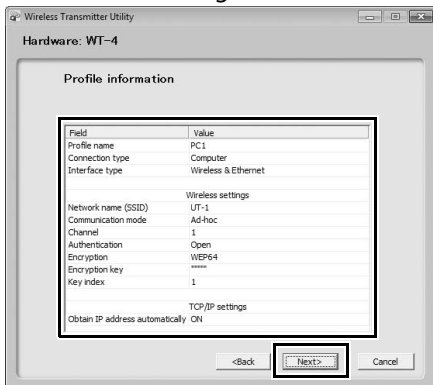

13 Select **Finish wizard** and click **Next**.

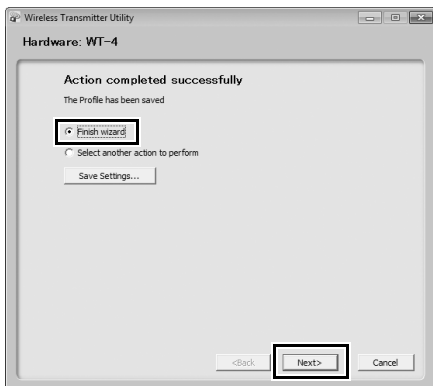

- 14 Turn the camera off and disconnect the USB cable.

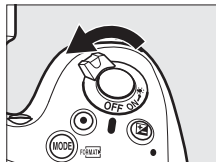

The network profile has now been copied to the camera. Proceed to “Uploading Pictures to a Host Computer” (📖 33) or “PC Mode” (📖 42).

Uploading Pictures to a Host Computer

Connecting the UT-1

Before connecting the UT-1, confirm that the host computer is running and the user is logged in.

- 1 Turn the camera off and insert the memory card containing the pictures to be sent (if the camera is equipped with multiple memory card slots, the card can be inserted into any slot).

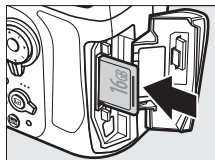

- 2 Open the UT-1 USB connector cover and connect the USB cable from the UT-1 to the camera USB connector (for more information on connecting USB cables to the camera, see the camera manual).

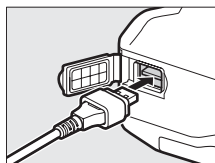

- 3 Connect the Ethernet cable or wireless transmitter.

Ethernet networks: Connect the Ethernet cable to the computer and UT-1 as shown. Do not use force or insert the connectors at an angle.

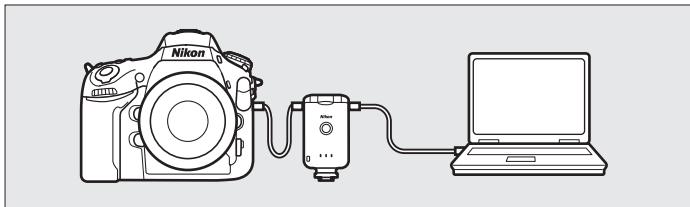

Wireless networks: Connect the WT-5 wireless transmitter as described on page 8.

- 4** Turn the camera on.

Power switch

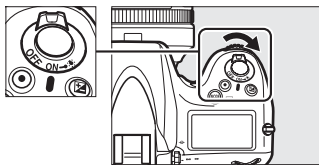

- 5** Select **Transfer mode** for the **Wireless transmitter > Mode** option in the camera setup menu (📖 72).

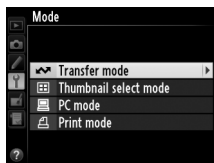

- 6** A list of available connection profiles will be displayed. Highlight the desired profile and press **OK**.

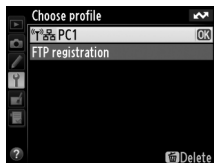

Viewing Profile Information

Press the camera **Info (?)** button to view information on the selected profile.

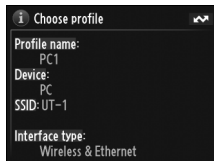

- 7** Select **Wireless transmitter > Transfer settings** and adjust settings as described on pages 89–90.

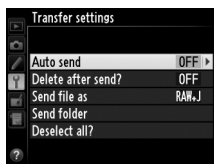

- 8** Press the power switch for about a second to turn the UT-1 on.



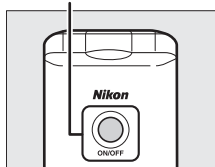

Power switch

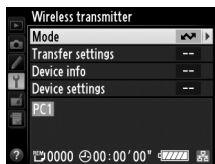

- 9** Confirm that the selected profile is displayed in green in the top level of the wireless transmitter menu. For information on what to do if an error is displayed, see "Troubleshooting" (119).



Uploading Images

- 1 Press the  button to view pictures on the memory card. Display the first picture to be sent in single-image playback or highlight it in the thumbnail list.
- 2 Press  (D800 and D800E), press the center of the multi selector while pressing  (D4), or press  while pressing the **BKT** button (D7000). The image will be marked with a white “send” icon and transmission will begin immediately. During upload, images are marked with a green “sending” icon. Repeat this process to send additional images (pictures will be sent in the order selected).



Images that have been successfully uploaded are marked with a blue “sent” icon. Images can be resent using the controls described above to change the blue “sent” icon to a white “send” icon.



D800 and D800E Retouch Options

When **Wireless transmitter > Mode > Transfer mode** is selected in the camera setup menu and the UT-1 is connected, the  button on the D800 or D800E is used during playback to select pictures for upload, preventing it from being used to select pictures for other operations, such as side-by-side comparison. To restore normal operation, select another option for **Wireless transmitter > Mode**.

- 3** Press the power switch for about a second to turn the UT-1 off. Disconnect the USB cable and UT-1. The destination folder selected in the Wireless Transmitter Utility (☐ 23) will open automatically when the connection between the computer and the UT-1 is terminated.

Power switch

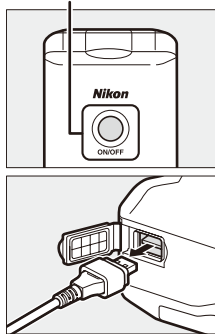

☐ Interrupting Transmission

To cancel transmission of images marked with a white “send” icon or green “sending” icon, select the images during playback and use the controls described in Step 2 on page 36. The icon will be removed. Any of the following actions will also interrupt transmission:

- Turning the camera or UT-1 off
- Selecting **Yes** for **Wireless transmitter > Transfer settings > Deselect all?**

☑ During Upload

Do not remove the memory card or disconnect the Ethernet cable during upload.

📎 Interval Timer Photography

Choose a long auto meter-off delay when using the interval timer.

📎 Voice Memos

Voice memos can not be uploaded separately, but will be included when associated pictures are transmitted. Voice recordings can not be selected for upload.

 Loss of Signal

Transmission may be interrupted if the signal is lost (□40). Transmission can be resumed by turning the UT-1 off and then on again.

 Turning the Camera Off

“Send” marking will be saved if the camera or UT-1 is turned off while transmission is in progress. Transmission of images marked with a “send” icon will resume when the camera or UT-1 is turned on.

❑ Transfer Status

During playback, the status of images selected for upload is shown as follows:

: "Send"

Images that have been selected for upload are marked with a white  icon.



: "Sending"

A green  icon is displayed during upload.



: "Sent"

Images that have been uploaded successfully are marked with a blue  icon.



Removing the "Send," "Sending," and "Sent" Icons

"Send," "sending," and "sent" icons can be removed from all images by selecting **Yes** for **Wireless transmitter** > **Transfer settings** > **Deselect all?** (📄 90).

❑ Network Status

The status of the link between the host and the UT-1 is shown by the status LEDs and by the display in the top level of the wireless transmitter menu.

The Status LEDs

The **POWER** LED lights when the UT-1 is on. Signal quality is shown by the **LINK** LED: the faster the LED flashes, the better the signal and the faster data can be transmitted. The **ERROR** LED flashes to show that an error has occurred.

Status LEDs

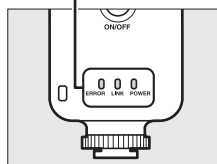

Status	POWER	LINK	ERROR
UT-1 off	● (off)	● (off)	● (off)
USB cable not connected	○ (on)	● (off)	● (off)
Connecting to host	○ (on)	○ (on)	● (off)
Waiting to send or sending data	○ (on)	✳ (flashes)	● (off)
Connection error	○ (on)	● (off)	✳ (flashes)
UT-1 hardware or battery malfunction	✳ (flashes)	✳ (flashes)	✳ (flashes)

The Status Display

Network status can also be viewed in the top level of the wireless transmitter menu.

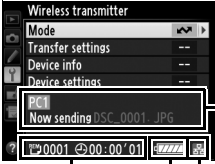

The screenshot shows the 'Wireless transmitter' menu with the following items: Mode, Transfer settings, Device info, Device settings, PCI, and Now sending DSC_0001.JPG. Below the menu, there is a status bar showing 'DSC_0001', a timer '00:00:01', a battery level indicator, and a signal strength indicator.

REM, ⊕: The estimated time required to send the remaining images.

Battery level: A five-level display showing the charge state of the battery in the UT-1.

Status area: The status of the connection to the host. The host name is displayed in green when a connection is established. While files are being transferred, the status display shows "Now sending" followed by the name of the file being sent. Any errors that occur during transfer are also displayed here (📖 119).

Signal strength: Wireless signal strength. Ethernet connections are shown by 📶.

PC Mode

In PC mode, a camera equipped with a UT-1 can be controlled over a wireless or Ethernet network from a computer running Camera Control Pro 2 (available separately) and photographs saved directly to the computer hard disk instead of the camera memory card (movies are still recorded to the memory card and can consequently only be recorded when a memory card is inserted in the camera).

Connecting to the Computer

Before connecting the UT-1, confirm that the host computer is running and the user is logged in.

1 After turning the camera off, open the UT-1 USB connector cover and connect the USB cable from the UT-1 to the camera USB connector (for more information on connecting USB cables to the camera, see the camera manual).

2 Connect the Ethernet cable or wireless transmitter.

Ethernet networks: To access the network via Ethernet, confirm that the camera is off and connect the Ethernet cable to the computer and UT-1 as shown. Do not use force or insert the connectors at an angle. Note that wireless transfer is disabled while an Ethernet cable is connected; before accessing a wireless network, turn the UT-1 off and disconnect the Ethernet cable.

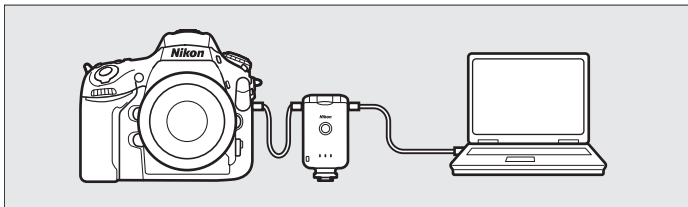

Wireless networks: Connect the WT-5 wireless transmitter as described on page 8.

- 3** Turn the camera on.

Power switch

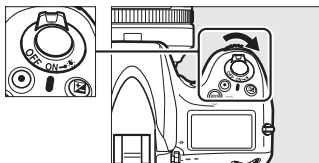

- 4** Select **PC mode** for the **Wireless transmitter** > **Mode** option in the camera setup menu (📖 72).

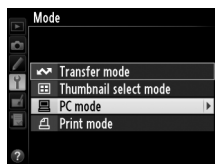

- 5** A list of available connection profiles will be displayed. Highlight the desired profile and press **OK**.

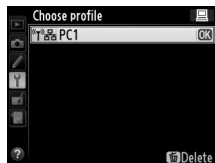

Viewing Profile Information

Press the camera **?** button to view information on the selected profile.

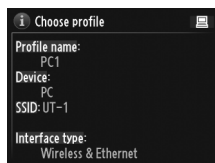

- 6** Press the power switch for about a second to turn the UT-1 on.

Power switch

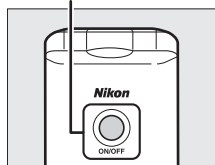

- 7** When a connection is established, the network name will be displayed in green in the top level of the wireless transmitter menu. For information on what to do if an error is displayed, see “Troubleshooting” (📖 119).

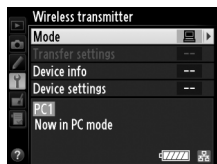

Controlling the Camera

1 Complete the steps in “Connecting to the Computer” (□42).

2 Start Camera Control Pro 2 on the host computer and confirm that “PC” is displayed in the camera control panel.

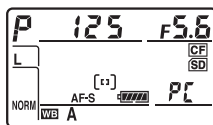

3 Control the camera as described in the Camera Control Pro 2 manual or online help.

4 When transfer is complete, press the power switch for about a second to turn the UT-1 off and then disconnect the USB cable.

Power switch

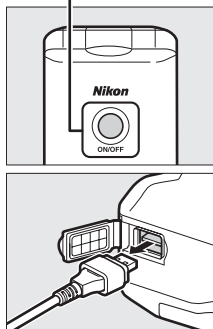

✔ Wireless Networks

More time may be required to complete operations on wireless networks.

✔ Ethernet Networks: Do Not Disconnect the Ethernet Cable

Do not disconnect the Ethernet cable while the camera is on.

🔌 Wireless Networks: Loss of Signal During Transfer

A loss of signal may interrupt the connection while pictures are being transferred to Camera Control Pro 2. If the **ERROR** LED on the UT-1 is flashing (□2), turn the UT-1 off and then on again. Transfer will resume when the connection is re-established. **Do not turn the camera off.** Transfer can not be resumed once the camera has been turned off.

❑ Network Status

The status of the link between the host and the UT-1 is shown by the status LEDs and by the display in the top level of the wireless transmitter menu.

The Status LEDs

The **POWER** LED lights when the UT-1 is on. Signal quality is shown by the **LINK** LED: the faster the LED flashes, the better the signal and the faster data can be transmitted. The **ERROR** LED flashes to show that an error has occurred.

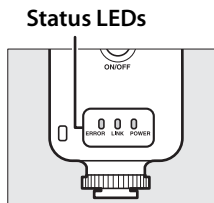

Status	POWER	LINK	ERROR
UT-1 off	● (off)	● (off)	● (off)
USB cable not connected	○ (on)	● (off)	● (off)
Connecting to host	○ (on)	○ (on)	● (off)
Waiting to send or sending data	○ (on)	✻ (flashes)	● (off)
Connection error	○ (on)	● (off)	✻ (flashes)
UT-1 hardware or battery malfunction	✻ (flashes)	✻ (flashes)	✻ (flashes)

The Status Display

Network status can also be viewed in the top level of the wireless transmitter menu.

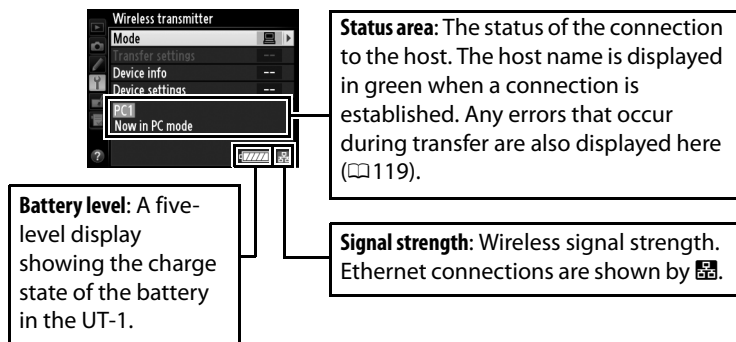

Uploading Pictures to an ftp Server

Follow the steps below to upload pictures to an ftp server over wireless or Ethernet networks.

1 Copying Network Profiles to the Camera (📖 50)



2 Connecting to the ftp Server (📖 62)



3 Uploading Images (📖 65)

Before Connecting

Configure the server before connecting. Servers can be configured using standard ftp services available with supported operating systems, such as IIS (Internet Information Services). Connection to computers on other networks via a router, Internet ftp connections and ftp servers running third-party software are not supported.

Copying Network Profiles to the Camera

Before copying network profiles, confirm that the computer is running and the user is logged in.

- 1 Connect the USB cable supplied with the camera.

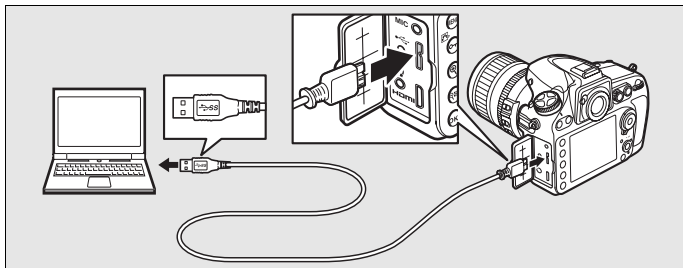

- 2 Turn the camera on.

Power switch

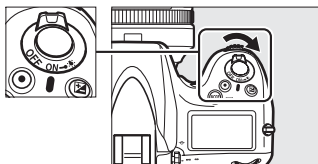

- 3 Start the Wireless Transmitter Utility.

- **Windows:** Double-click the **Wireless Transmitter Utility** icon on the desktop.
- **Mac OS X:** Click the **Wireless Transmitter Utility** icon in the Dock.

4 The dialog shown below will be displayed; click **Next**.



5 Select **WT-4** and click **Next** (note that you should select **WT-4** even when the UT-1 is connected to a WT-5 wireless transmitter).

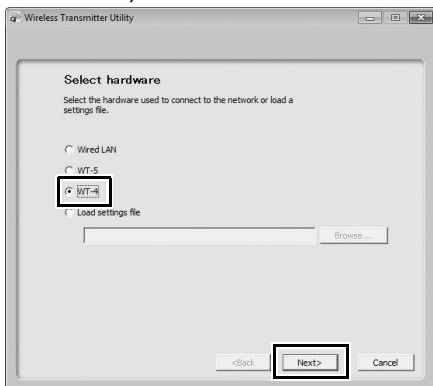

6 Select **Add/Edit profiles** and click **Next**.

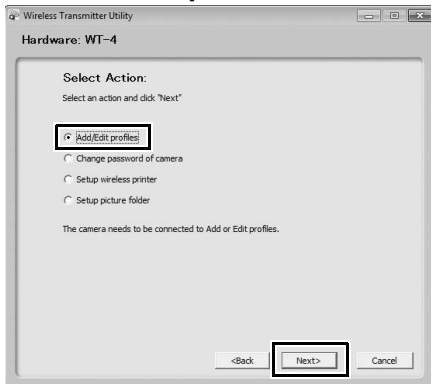

7 Select **Add new profile** and click **Next**.

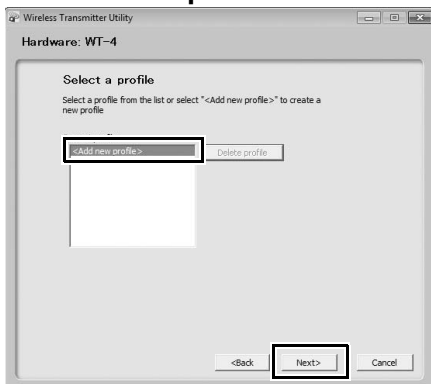

8 Enter the following information and click **Next**:

- **Profile name:** Enter a name of up to 16 characters.
- **Connection type:** Choose **FTP Server**.
- **Interface type:** Choose **Wireless & Ethernet** for networks that include wireless; if you will not be connecting to a wireless network, select **Ethernet only** and proceed to Step 11.

Wireless Transmitter Utility
Hardware: WT-4

Enter profile name
Enter a name for the new profile and select the type of profile and interface

Profile name:

Connection type:

Interface type:

Help <Back **Next>** Cancel

9 Select **Manual setup** and click **Next**.

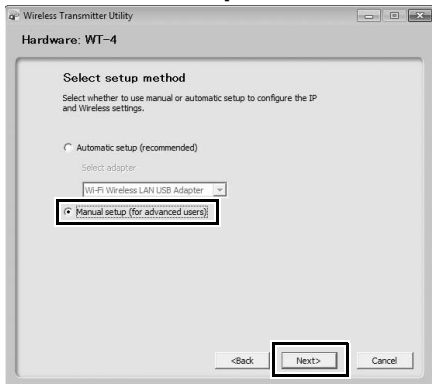

“Automatic Setup”

Choose **Automatic setup** when using a new network for the first time. The following dialog will be displayed; select **Ad hoc**, or select **Infrastructure network (recommended)** and choose a network from the pull-down menu. Click **Next** to proceed to Step 11 (📖58).

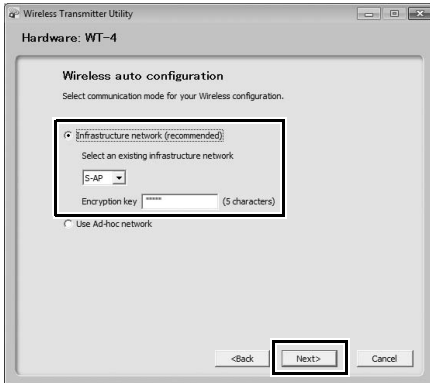

The **Automatic setup (recommended)** option can not be used with existing network profiles, third-party wireless LAN adapters, networks using static IP addresses, or Mac OS X.

10 Enter the following information and click **Next**.

- **Network name (SSID):** Enter a network name or choose from a list of existing networks. Do not change the name if it is supplied automatically.
- **Communication mode:** Select **Infrastructure** or **Ad-hoc**.
- **Channel:** Select a channel (ad hoc only; in infrastructure mode, the UT-1 will choose the channel automatically). Note that if a matching SSID is found on a different channel, the UT-1 may change the channel automatically.
- **Authentication:** The authentication used on the network. Choose from open system, shared key, WPA-PSK, and WPA2-PSK (infrastructure) or from open system and shared key (ad hoc).
- **Encryption:** The encryption used on the network. The options available depend on the authentication used.
 - Open:** None; 64- or 128-bit WEP
 - Shared:** 64- or 128-bit WEP
 - WPA-PSK:** TKIP; AES
 - WPA2-PSK:** AES
- **Encryption key:** If the network uses encryption, enter the network key. The number of characters required depends on the type of key used:

	WEP (64-bit)	WEP (128-bit)	TKIP, AES
Number of characters (ASCII)	5	13	8–63
Number of characters (hex)	10	26	64

Note that depending on the device and the key setting used, the UT-1 may fail to connect. If this occurs, try choosing a different key setting.

- **Key Index:** If **WEP64** or **WEP128** is selected for **Encryption**, choose a key index (the default index is **1**). A key index is not required when **None** is selected.

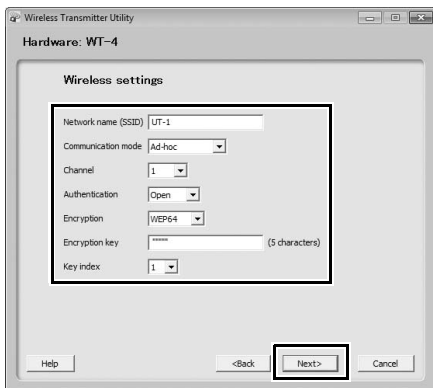

11 Remove the check from **Obtain IP address automatically** and enter the following information. Click **Next** to proceed when entry is complete.

- **IP address:** Enter an IP address for the UT-1.
- **Subnet mask:** Enter a subnet mask for the UT-1.
- **Default gateway:** If the network requires a gateway address, select this option and enter the address supplied by the network administrator.
- **DNS Server:** If a Domain Name Server exists on the network, select this option and enter the address supplied by the network administrator.

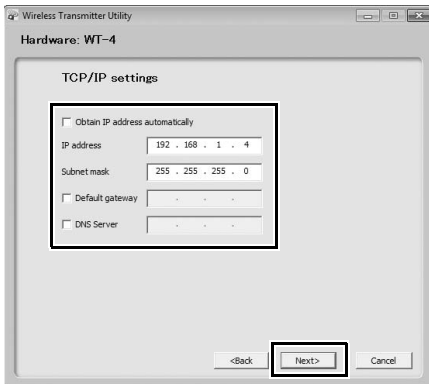

12 Enter ftp settings and click **Next**.

- **FTP server:** Enter the URL or IP address of the ftp server.
- **FTP server port:** Enter the port number for the ftp server.
- **FTP path:** Choose the folder to which pictures will be uploaded. If no path is specified, pictures will be uploaded to the home folder.
- **Anonymous login:** Select this option for anonymous login, or leave this option unchecked to supply a **User ID** and **Password**.
- **Use proxy server:** If a proxy server is required for ftp, select this option and enter the IP address and port number for the proxy server.
- **PASV mode:** Select this option to use PASV mode.

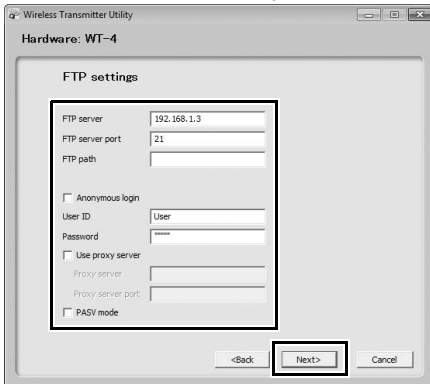

The screenshot shows a window titled "Wireless Transmitter Utility" with hardware "WT-4". Inside is an "FTP settings" dialog box. The "FTP server" field contains "192.168.1.3", "FTP server port" contains "21", and "FTP path" is empty. There are checkboxes for "Anonymous login", "Use proxy server", and "PASV mode", all of which are unchecked. The "User ID" field contains "User" and the "Password" field contains "user". The "Proxy server" and "Proxy server port" fields are empty. At the bottom, there are three buttons: "<Back", "Next>", and "Cancel". The "Next>" button is highlighted with a black box.

13 Confirm that settings are correct and click **Next**.

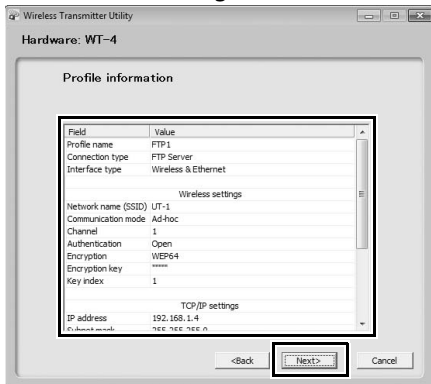

14 Select **Finish wizard** and click **Next**.

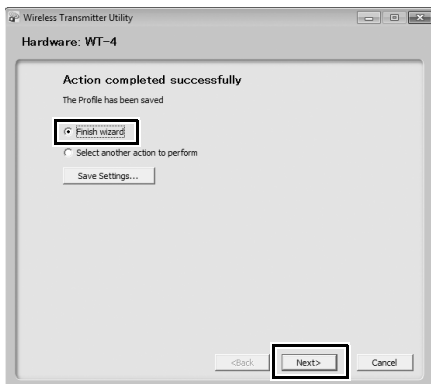

- 15** Press the power switch for about a second to turn the camera off and disconnect the USB cable.

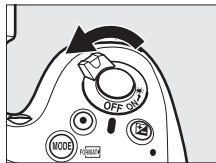

The network profile has now been copied to the camera. Proceed to “Connecting to the ftp Server” (62).

Connecting to the ftp Server

Before connecting the UT-1, confirm that the host computer is running and the user is logged in.

- 1 Turn the camera off and insert the memory card containing the pictures to be sent (if the camera is equipped with multiple memory card slots, the card can be inserted into any slot).

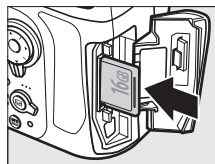

- 2 Open the UT-1 USB connector cover and connect the USB cable from the UT-1 to the camera USB connector (for more information on connecting USB cables to the camera, see the camera manual).

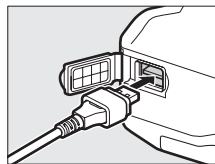

- 3 Connect the Ethernet cable or wireless transmitter.

Ethernet networks: To access the network via Ethernet, confirm that the camera is off and connect the Ethernet cable to the computer and UT-1 as shown. Do not use force or insert the connectors at an angle. Note that wireless transfer is disabled while an Ethernet cable is connected; before accessing a wireless network, turn the UT-1 off and disconnect the Ethernet cable.

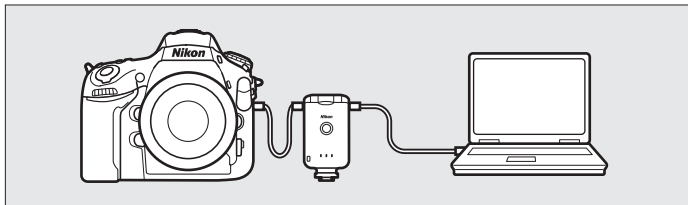

Wireless networks: Connect the WT-5 wireless transmitter as described on page 8.

- 4** Turn the camera on.

Power switch

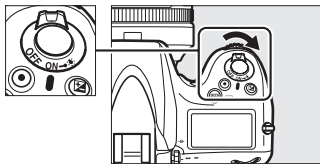

- 5** Select **Transfer mode** for the **Wireless transmitter > Mode** option in the camera setup menu (📖 72).

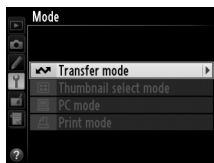

- 6** A list of available connection profiles will be displayed. Highlight the desired profile and press **OK**.



Viewing Profile Information

Press the camera **?** button to view information on the selected profile.

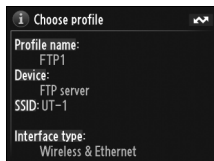

Editing ftp Server Profiles

To edit the ftp server profile, press the camera **?** button after turning on the UT-1. See the Menu Guide for more information (📖 73).

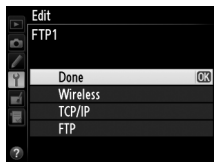

- 7** Select **Wireless transmitter > Transfer settings** and adjust settings as described on pages 89–90.

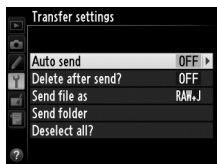

- 8** Press the power switch for about a second to turn on the UT-1.



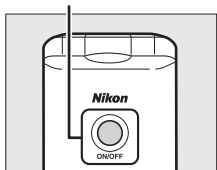

Power switch

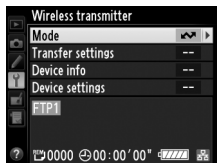

- 9** Confirm that the selected profile is displayed in green in the top level of the wireless transmitter menu. For information on what to do if an error is displayed, see “Troubleshooting” (p. 119).



Uploading Images

- 1 Press the  button to view pictures on the memory card. Display the first picture to be sent in single-image playback or highlight it in the thumbnail list.
- 2 Press  (D800 and D800E), press the center of the multi selector while pressing  (D4), or press  while pressing the **BKT** button (D7000). The image will be marked with a white “send” icon and transmission will begin immediately. During upload, images are marked with a green “sending” icon. Repeat this process to send additional images (pictures will be sent in the order selected).



Images that have been successfully uploaded are marked with a blue “sent” icon. Images can be resent using the controls described above to change the blue “sent” icon to a white “send” icon.



D800 and D800E Retouch Options

When **Wireless transmitter > Mode > Transfer mode** is selected in the camera setup menu and the UT-1 is connected, the  button on the D800 or D800E is used during playback to select pictures for upload, preventing it from being used to select pictures for other operations, such as side-by-side comparison. To restore normal operation, select another option for **Wireless transmitter > Mode**.

Interval Timer Photography

Choose a long auto meter-off delay when using the interval timer.

- 3** Press the power switch for about a second to turn the UT-1 off, then disconnect the USB cable and UT-1. The destination folder can be selected using the Wireless Transmitter Utility (☰ 23, 59).

Power switch

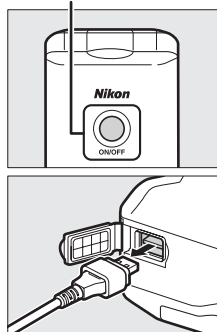

☐ Interrupting Transmission

To cancel transmission of images marked with a white “send” icon or green “sending” icon, select the images during playback and use the controls described in Step 2 on page 65. The icon will be removed. Any of the following actions will also interrupt transmission:

- Turning the camera or UT-1 off
- Selecting **Yes** for **Wireless transmitter > Transfer settings > Deselect all?**

☑ During Upload

Do not remove the memory card or disconnect the Ethernet cable during upload.

☑ File Names

To prevent files from being overwritten during transfer, select **On** for the **File number sequence** option in the camera Custom Settings menu before transfer. When uploading files from multiple cameras to the same server, assign each camera its own folder.

📝 Voice Memos

Voice memos can not be uploaded separately, but will be included when associated pictures are transmitted. Voice recordings can not be selected for upload.

❑ Transfer Status

During playback, the status of images selected for upload is shown as follows:

📷: "Send"

Images that have been selected for upload are marked with a white 📷 icon.



📷: "Sending"

A green 📷 icon is displayed during upload.



📷: "Sent"

Images that have been uploaded successfully are marked with a blue 📷 icon.



🔌 Loss of Signal

Transmission may be interrupted if the signal is lost (📶68). Transmission can be resumed by turning the UT-1 off and then on again.

🔌 Turning the Camera Off

"Send" marking will be saved if the camera or UT-1 is turned off while transmission is in progress. Transmission of images marked with a "send" icon will resume when the camera or UT-1 is turned on.

🔌 Removing the "Send," "Sending," and "Sent" Icons

"Send," "sending," and "sent" icons can be removed from all images by selecting **Yes** for **Wireless transmitter** > **Transfer settings** > **Deselect all?** (📷90).

❑ Network Status

The status of the link between the host and the UT-1 is shown by the status LEDs and by the display in the top level of the wireless transmitter menu.

The Status LEDs

The **POWER** LED lights when the UT-1 is on. Signal quality is shown by the **LINK** LED: the faster the LED flashes, the better the signal and the faster data can be transmitted. The **ERROR** LED flashes to show that an error has occurred.

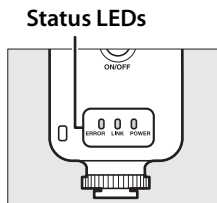

Status	POWER	LINK	ERROR
UT-1 off	● (off)	● (off)	● (off)
USB cable not connected	○ (on)	● (off)	● (off)
Connecting to host	○ (on)	○ (on)	● (off)
Waiting to send or sending data	○ (on)	✳ (flashes)	● (off)
Connection error	○ (on)	● (off)	✳ (flashes)
UT-1 hardware or battery malfunction.	✳ (flashes)	✳ (flashes)	✳ (flashes)

The Status Display

Network status can also be viewed in the top level of the wireless transmitter menu.

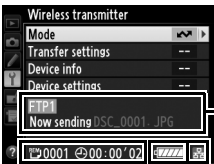

The screenshot shows the 'Wireless transmitter' menu with options: Mode, Transfer settings, Device info, and Device settings. Below these is an 'FTP' section displaying 'Now sending DSC_0001.JPG'. At the bottom of the screen, there are several status icons: a battery level indicator, a signal strength indicator, a timer showing '00:00:02', and a file transfer progress indicator.

REM, ⊕: The estimated time required to send the remaining images.

Battery level: A five-level display showing the charge state of the battery in the UT-1.

Status area: The status of the connection to the host. The host name is displayed in green when a connection is established. While files are being transferred, the status display shows "Now sending" followed by the name of the file being sent. Any errors that occur during transfer are also displayed here.

Signal strength: Wireless signal strength. Ethernet connections are shown by .

Uploading Images

Menu Guide

This section describes the settings available for the **Wireless transmitter** option in the camera setup menu when the UT-1 is connected.

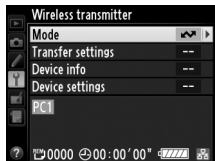

Menu item	Pg.
Mode	72
<i>Choose Profile</i>	72
<i>FTP Registration (Transfer Mode Only)</i>	73
<i>Editing ftp Profiles (for Connection to ftp Servers Only)</i>	73
Transfer Settings	89
<i>Auto Send</i>	89
<i>Delete After Send?</i>	89
<i>Send File As</i>	90
<i>Send Folder</i>	90
<i>Deselect All?</i>	90
Print	91
Device Info	92
<i>Battery Info</i>	92
<i>MAC Address</i>	92
<i>Firmware Version</i>	92
Device Settings	93
<i>Auto Power Off</i>	93
<i>Format Transmitter's Memory</i>	93

Mode

Choose from transfer (☰33) and PC (☰42) modes; thumbnail select and print modes are not supported. Selecting either option displays a profile list showing the connections available in the selected mode.

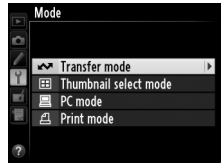

Choose Profile

Selecting an option from the **Mode** menu displays a profile list showing the connections available in the selected mode. The UT-1 can store a total of up to nine host and server profiles. To delete a profile, highlight it in the profile list and press the button. To edit an ftp server profile, highlight the profile and press the button (☰73).



To view profile information, highlight the desired profile and press the (?) button. The following information will be displayed.

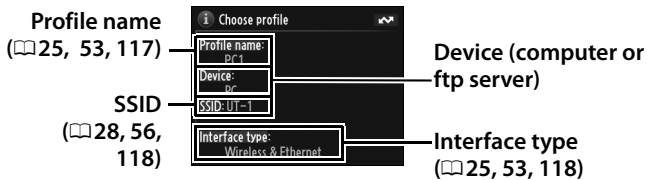

☑ Using the Menus

If the shutter-release button on the camera is pressed while menus are displayed, the monitor will turn off and any changes to the current profile will be lost.

FTP Registration (Transfer Mode Only)

In transfer mode, ftp profiles can be created without using the Wireless Transmitter Utility. See the Appendix for more information (116). This option is only available when the UT-1 is connected to the camera via USB and the UT-1 is on.

Editing ftp Profiles (for Connection to ftp Servers Only)

To edit an ftp server profile, highlight it in the profile list in transfer mode and press the  button. Choose the settings to be edited from **Wireless**, **TCP/IP**, and **FTP**, or select **Done** to save changes and return to the profile list. Only ftp server profiles can be edited in this fashion; to edit other profiles, use the Wireless Transmitter Utility. This option is only available when the UT-1 is connected to the camera via USB and the UT-1 is on.

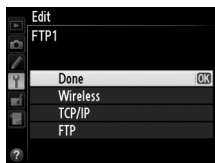



Text Entry

The following dialog is displayed when text entry is required.

Keyboard area: Use multi selector to highlight letters, press center to select.



Text display area: Text appears in this area. To move cursor, press  while using up, down, left, and right buttons on multi selector.

Use the multi selector to highlight the desired character in the keyboard area and press the center of the multi selector to insert the highlighted character at the current cursor position (note that if a character is entered when the field is full, the last character in the field will be deleted). To delete the character under the cursor, press the  button. To move the cursor to a new position, press the  button while using the multi selector.

To complete entry and return to the previous menu, press the  button. To exit to the previous menu without completing text entry, press MENU.

❑ Wireless

This option contains settings for connection to a wireless network and is only displayed if the interface type for the selected profile is **Wireless & Ethernet**. The wireless menu has two pages of options; to scroll between pages, press the multi selector up or down.

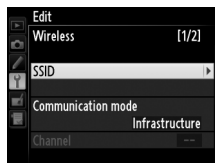

Wireless Menu, Page 1/2

SSID: A BSS- or ESS-ID is required for connection to a wireless LAN adapter or access point. To change the BSS- or ESS-ID, highlight the current ID, press the multi selector to the right, and enter a new ID as described in the note on the previous page. Press **OK** to return to the wireless menu (1/2).

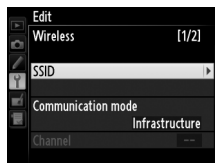

Communication mode: Choose a mode according to how the wireless network is set up.

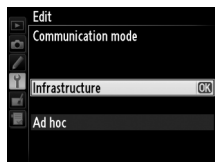

Option	Description
Infrastructure (default)	Connection to wireless network is via access point.
Ad hoc	Direct peer-to-peer wireless connection to host.

✎ Ethernet Networks

No adjustments to wireless LAN settings are required when the camera is connected to a LAN by an Ethernet cable.

Channel*

- 1 Choose a channel.



- 2 Return to the wireless menu (1/2).

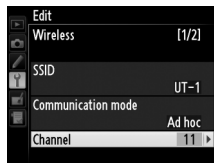

* Not required if **Infrastructure** is selected for **Communication mode**.

Authentication: Choose the type of authentication used by the computer or access point. The camera supports WPA-PSK, WPA2-PSK, open system, and shared key authentication. WPA-PSK and WPA2-PSK are available only in infrastructure mode.

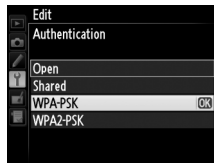

Encryption

1 Highlight an encryption method.

Encryption

The type of encryption available depends on the option selected for **Authentication** (☞ 28, 75):

- **Open:** No encryption, WEP
- **Shared:** WEP
- **WPA-PSK:** TKIP, AES
- **WPA2-PSK:** AES



2 Return the to wireless menu (2/2).



3 Highlight an encryption key. Skip Steps 3–5 if **No encryption** was selected in Steps 1–2.

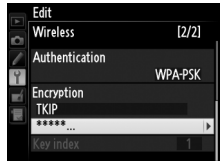

4 Edit the encryption key:

- **Base 16:** Enter the key as described on page 73. 64-bit keys require 10 digits, 128-bit keys 26 digits, TKIP and AES keys 64 digits.



- **ASCII:** Enter the key as described on page 26. 64-bit keys are 5 characters long, 128-bit keys 13 characters long, TKIP and AES keys 8 to 63 characters long.

Note that depending on the device and the key setting used, the UT-1 may fail to connect. If this occurs, try choosing a different key setting.

5 Return to the wireless menu (2/2).

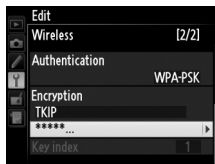

Key index: In infrastructure networks that use WEP encryption, choose the key index used by the host or access point.



1 Choose an index.



2 Return to the wireless menu (2/2).



❑ TCP/IP

Adjust TCP/IP settings as described on the following pages. The TCP/IP menu has two pages of options; to scroll between pages, press the multi selector up or down.

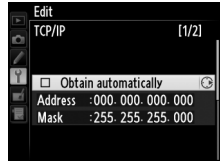

TCP/IP Menu, Page 1/2

Obtain automatically: Highlight this option and press the multi selector right to toggle it on (☑) or off. Turn this option on if the wireless network is configured to supply an IP address automatically by DHCP server or Auto IP. Otherwise turn it off and enter the address and sub-net mask supplied by the network administrator as described below.

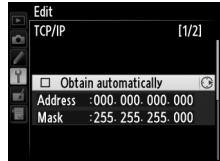

1 Highlight **Address**.

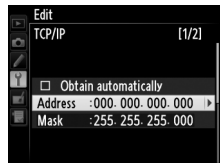

2 Enter edit mode.



3 Press the multi selector left or right to select, up or down to change.



- 4** Exit to the TCP/IP menu (1/2). If a sub-net mask is required, proceed to Step 5.

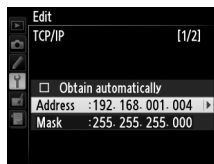

- 5** Highlight **Mask**.

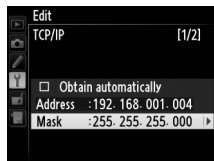

- 6** Enter edit mode.



- 7** Choose a sub-net mask.



- 8** Exit to the TCP/IP menu (1/2).

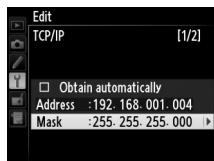

TCP/IP Menu, Page 2/2

Use gateway: Highlight this option and press the multi selector right to toggle it on (☑) or off. If the network requires a gateway address, turn this option on and enter the address supplied by the network administrator as described below.

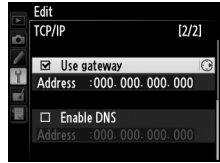

1 Highlight **Address**.

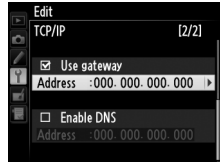

2 Enter edit mode.



3 Press the multi selector left or right to select, up or down to change.

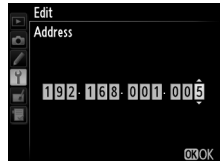

4 Return to the TCP/IP menu (2/2).

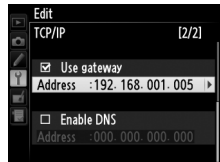

Enable DNS: Highlight this option and press the multi selector right to toggle it on () or off. If a Domain Name Server (DNS) exists on the network, turn this option on and enter the address supplied by the network administrator as described below.

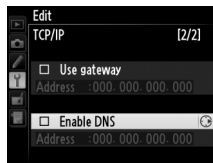

1 Highlight **Address**.

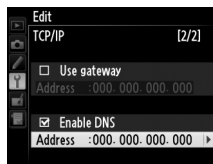

2 Enter edit mode.



3 Press the multi selector left or right to select, up or down to change.



4 Return the to TCP/IP menu (2/2).

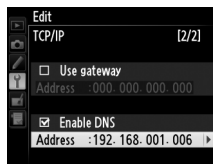

FTP

Adjust ftp settings as described on the following pages. The ftp menu has three pages of options; to scroll between pages, press the multi selector up or down.

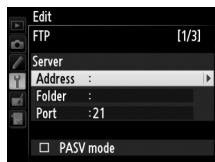

FTP Menu, Page 1/3

Server

1 Highlight **Address**.

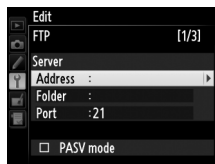

2 Display the text entry dialog.



3 Enter a server address (required; 73).



4 Return to the ftp menu (1/3).

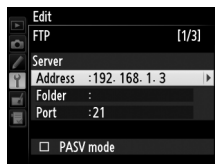

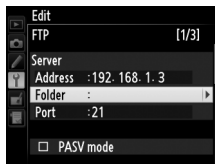
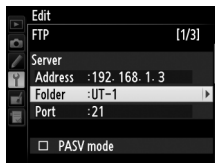
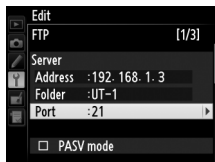
5 Highlight **Folder**.**6** Display the text entry dialog.**7** Enter the destination folder name (UT-1).**8** Return to the ftp menu (1/3).**9** Highlight **Port**.

10 Enter edit mode.



11 Press the multi selector left or right to select, up or down to change.



12 Return to the ftp menu (1/3).

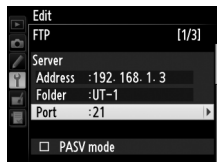

PASV mode: Highlight this option and press the multi selector right to toggle PASV mode on () or off.

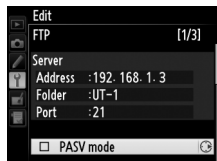

FTP Menu, Page 2/3

Anonymous login: Highlight this option and press the multi selector right to toggle it on () or off. Turn this option on for anonymous login, off to enter a user name and password as described below.

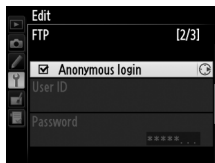

1 Highlight **User ID**.



2 Display the text entry dialog.



3 Enter a user name (n73).

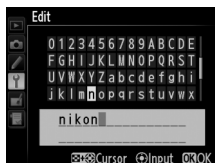

4 Return to the ftp menu (2/3).



5 Highlight **Password**.**6** Display the text entry dialog.**7** Enter a password (Ⓜ73).**8** Return to the ftp menu (2/3).

FTP Menu, Page 3/3

Use proxy server: Highlight this option and press the multi selector right to toggle it on (☑) or off. If a proxy server is required for ftp, turn this option on and enter an address and port number as described below.

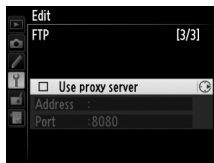
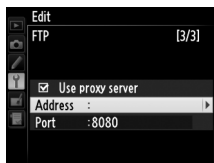
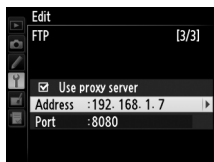
**1** Highlight **Address**.**2** Display the text entry dialog.**3** Enter a proxy server address (☞73).**4** Return to the ftp menu (3/3).

5 Highlight Port.

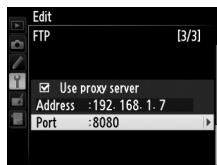

6 Enter edit mode.



7 Press the multi selector left or right to select, up or down to change.



8 Return to the ftp menu (3/3).

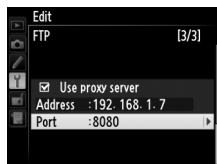

Transfer Settings (Transfer Mode Only)

The following settings are available in transfer mode:

Auto Send

Choose whether to upload photographs to the server as they are taken.

Option	Description
On	Photos are uploaded immediately after being recorded to camera memory card. * Be sure memory card is inserted in camera before shooting.
Off (default)	Photos are not automatically uploaded as they are taken. Photos can be selected for transmission when camera is in playback mode.

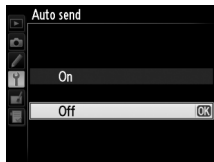

* Pictures will not be uploaded to the server when the UT-1 is turned off. Pictures will instead be marked with a “send” indicator as they are recorded to the memory card.

Delete After Send?

Select **Yes** to delete photographs from the camera memory card automatically once upload is complete (the default option is **No**). Deletion may be suspended during some camera operations; deletion resumes when the operation ends. Changes to this option have no effect on pictures that have already been uploaded.

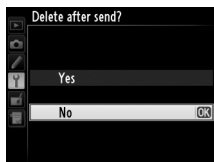

Send File As

When uploading NEF + JPEG images to an ftp server, choose whether to send both NEF (RAW) and JPEG files or only the JPEG files.

Option	Description
NEF (RAW) + JPEG (default)	Upload both NEF (RAW) and JPEG files.
JPEG only	Upload JPEG files only.

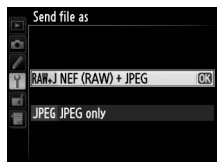

Send Folder

Upload all files in selected folders (including those already marked as “sent”).

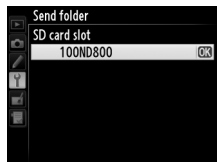

Deselect All?

Select **Yes** to remove “send,” “sending,” and “sent” marking from all images on the memory card. Upload of any images marked with a “sending” icon will immediately be terminated.



Print (Print Mode Only)

The UT-1 does not support this option.

Print

Device Info

This menu displays the following information about the UT-1. This option is only available when the UT-1 is connected to the camera via USB and the UT-1 is on. On the D4, the options in the D800

Device info and **Device settings** menus can be found under **Network > Device info and settings**.

Battery Info

Displays information on the battery inserted in the UT-1. The **Charging life** display shows battery age; replace the battery when **Charging life** reaches **4**.

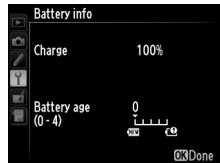

MAC Address

Shows the MAC address of the UT-1.



Firmware Version

Displays the UT-1 firmware version.



Device Settings

Format the transmitter's internal memory and choose the delay before the UT-1 turns off automatically. This option is only available when the UT-1 is connected to the camera via USB and the UT-1 is on. On the D4, the options in the D800 **Device info** and **Device settings** menus can be found under **Network > Device info and settings**.

Auto Power Off

Set the time delay until the UT-1 power automatically turns off after the USB connection between the camera and UT-1 is terminated.

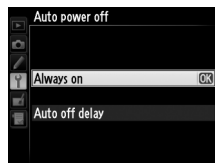

Option	Description
Always On (default)	The UT-1 does not turn off automatically.
Auto off delay	Choose the delay before the UT-1 turns off automatically from 30 seconds, 1 minute, 10 minutes, and 30 minutes.

Format Transmitter's Memory

The UT-1 has no built-in memory and does not support this option.

Appendices

Creating an FTP Server

Images can be uploaded to ftp servers created using the standard ftp services included with Windows 7 (Professional/Enterprise/Ultimate), Windows Vista (Ultimate/Business/Enterprise), Windows XP Professional, and Mac OS X. Under Windows, Internet Information Services (IIS) are required to configure ftp servers (installation instructions are available from Microsoft). Be sure to use only characters that appear in the keyboard area of the camera text-entry dialog (📖73) for such settings as user ID, password, and folder names.

The following settings are used below for illustrative purposes:



IP address: 192.168.1.3

Subnet mask: 255.255.255.0

ftp server port: 21

- Windows 7 📖 96
- Windows Vista 📖 103
- Windows XP 📖 110
- Mac OS X version 10.6 📖 114

Windows 7

1 Go to Network and Sharing Center.

Click **Start > Control Panel > Network and Internet > Network and Sharing Center**.

2 Display the network adapter list.

Click **Change adapter settings**.

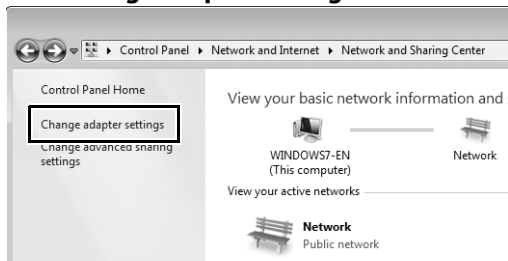

3 Open the network properties dialog.

If you are connecting via Ethernet, right-click **Local Area Connection** and select **Properties**. If connection is via a wireless LAN adapter, select **Properties** in the context menu for **Wireless Network Connection**.

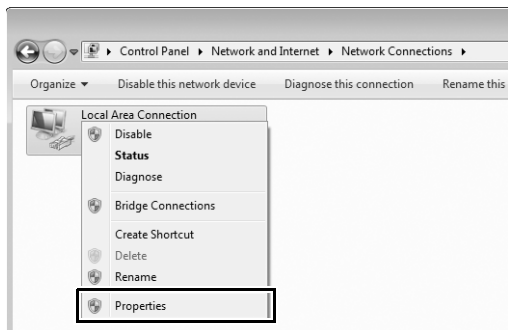

4 Display TCP/IP settings.

Select **Internet Protocol Version 4 (TCP/IPv4)** and click **Properties**.

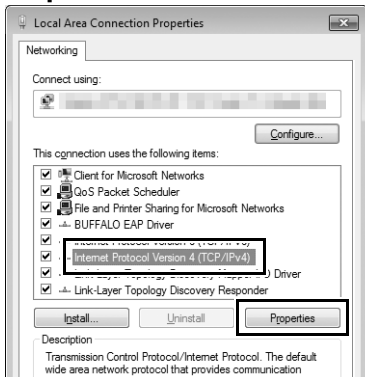

5 Enter an IP address and subnet mask.

Enter an IP address and subnet mask for the ftp server and click **OK**.

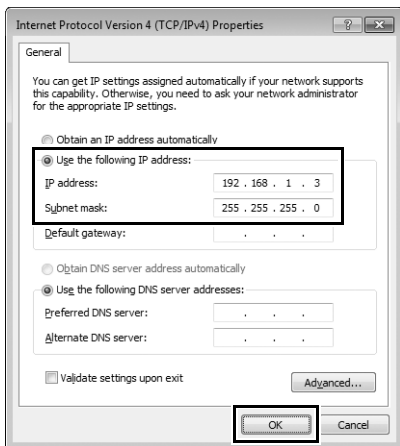

6 Close the network properties dialog.

Click **Close**.

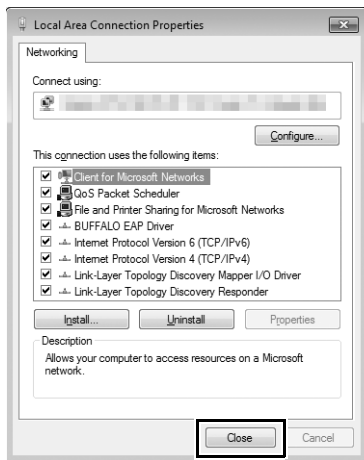

7 Open Administrative Tools.

Click **Start > Control Panel > System and Security > Administrative Tools**.

8 Open the IIS manager.

Double-click **Internet Information Services (IIS) Manager**.

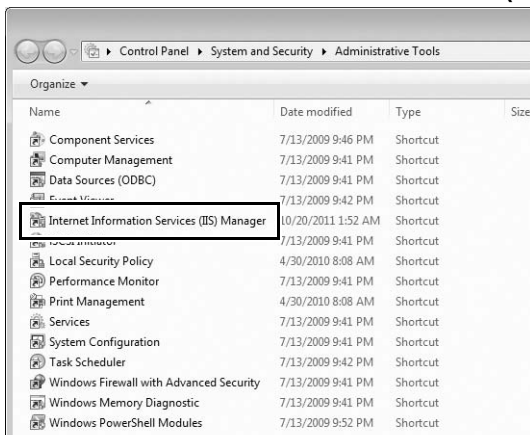

9 Select Add FTP Site....

Right-click the computer user name and select **Add FTP Site....**

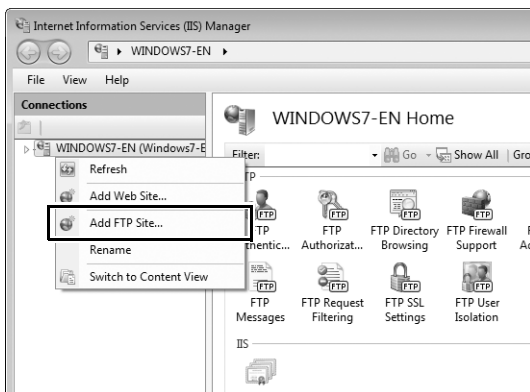

10 Enter site information.

Name the site and choose the path to the folder that will be used for ftp upload. Click **Next** to proceed.

The screenshot shows the 'Add FTP Site' dialog box with the 'Site Information' tab selected. The 'FTD site name' field is filled with 'FTP_UT-1'. The 'Content Directory' field is filled with 'C:\Users\user\FTP_UT-1'. The 'Next' button is highlighted with a red box.

Anonymous Login

To allow anonymous login, select a folder in the user's public folder as the content directory.

11 Choose binding and SSL options.

Select the IP address entered in Step 5, note the port number, select **Start FTP site automatically**, and check **No SSL**. Click **Next** to proceed.

The screenshot shows the 'Add FTP Site' wizard window, specifically the 'Binding and SSL Settings' step. The window title is 'Add FTP Site'. The main heading is 'Binding and SSL Settings'. The 'Binding' section contains a 'IP Address' dropdown menu with '192.168.1.3' selected, a 'Port' text box with '21', and an unchecked checkbox for 'Enable Virtual Host Names'. Below this is a text box for 'Virtual Host (example: ftp.contoso.com)'. The 'SSL' section has a checked checkbox for 'Start FTP site automatically', a selected radio button for 'No SSL', and unselected radio buttons for 'Allow SSL' and 'Require SSL'. Below the radio buttons is an 'SSL Certificate' dropdown menu with 'Not Selected' and a 'View...' button. At the bottom of the window are four buttons: 'Previous', 'Next', 'Finish', and 'Cancel'. The 'Next' button is highlighted with a black box.

12 Choose authentication options.

Adjust settings as described below and click **Finish**.

- **Authentication:** Basic
- **Allow access to:** All users
- **Permissions:** Read/Write



Windows Vista

1 Display network connections.

Click **Start > Control Panel > Network and Internet Settings > Network Connections > Manage Network Connections**.

2 Open the network properties dialog.

If you are connecting via Ethernet, right-click **Local Area Connection** and select **Properties**. If connection is via a wireless LAN adapter, select **Properties** in the context menu for **Wireless Network Connection**.

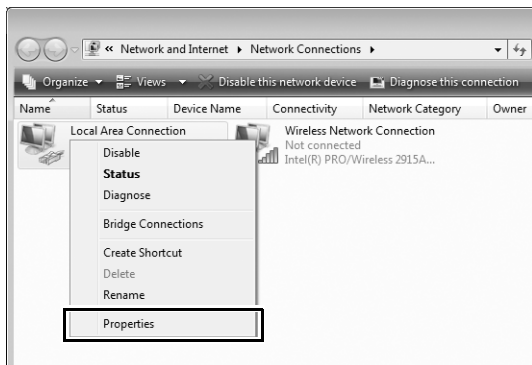

3 Click Allow.

A "User Account Control" dialog will be displayed; click **Allow**.

4 Display TCP/IP settings.

Select **Internet Protocol Version 4 (TCP/IPv4)** and click **Properties**.

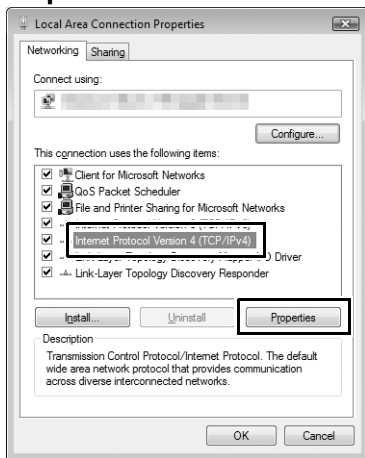

5 Enter an IP address and subnet mask.

Enter an IP address and subnet mask for the ftp server and click **OK**.

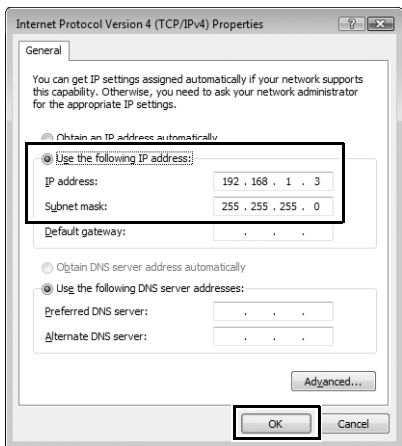

6 Open Administrative Tools.

Click **Start > Control Panel > System and Maintenance > Administrative Tools**.

7 Open the IIS manager.

Double-click **Internet Information Services (IIS) 6.0 Manager**.

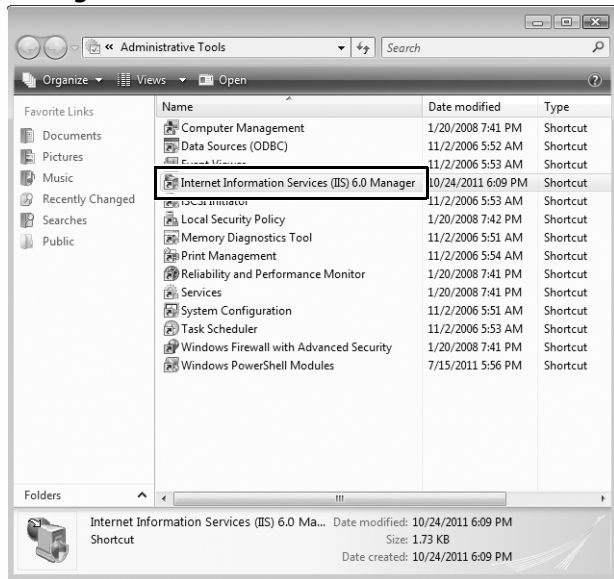

8 Click Allow.

A "User Account Control" dialog will be displayed; click **Allow**.

9 Display ftp site properties.

Right-click **Default FTP Site** and select **Properties**.

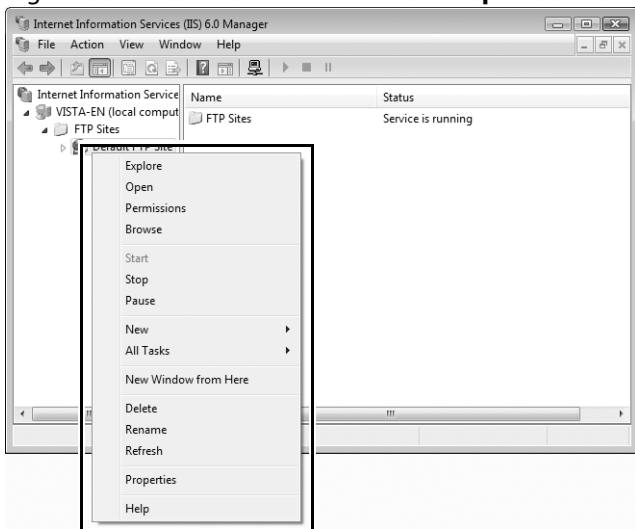

10 Select the address and port number.

Select the IP address entered in Step 5 and enter a **TCP port** number.

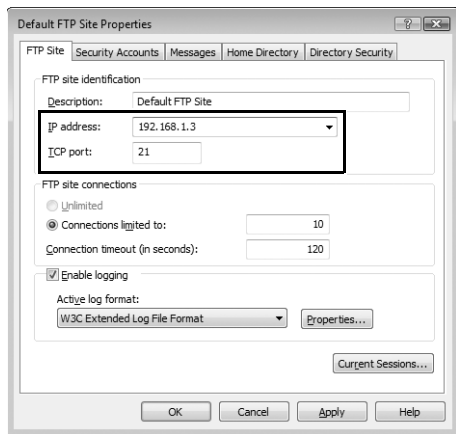

11 Choose a home directory.

Open the **Home Directory** tab and select **A directory located on this computer**. The root directory for images uploaded to the ftp server is listed in the **Local path** text box; choose a folder and select **Read**, **Write**, and **Log visits**. Click **OK** to close the properties dialog.

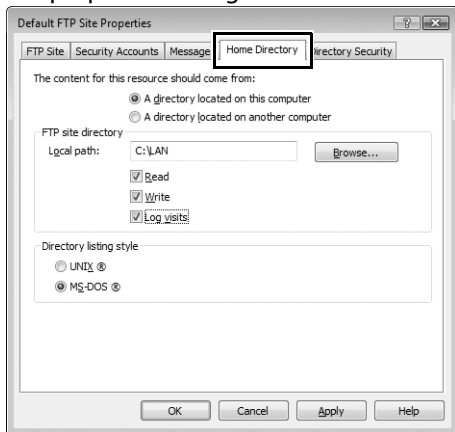

Windows XP

1 Display network connections.

Click **Start > Control Panel > Network and Internet Settings > Network Connections**.

2 Open the network properties dialog.

If you are connecting via Ethernet, right-click **Local Area Connection** and select **Properties**. If connection is via a wireless LAN adapter, select **Properties** in the context menu for **Wireless Network Connection**.

LAN or High-Speed Internet

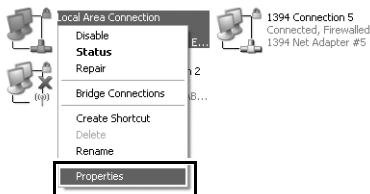

3 Display TCP/IP settings.

Select **Internet Protocol (TCP/IP)** and click **Properties**.



4 Enter an IP address and subnet mask.

Enter an IP address and subnet mask for the ftp server and click **OK**.

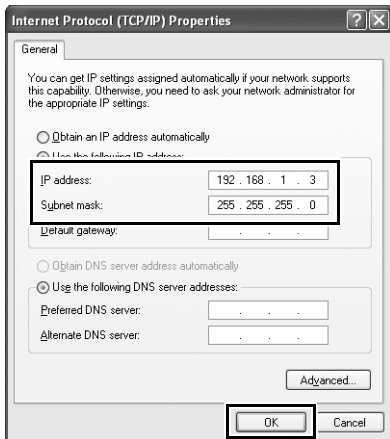

5 Open Internet Information Services.

Click **Start > Control Panel > System and Maintenance > Administrative Tools** and open the **Internet Information Services** console.



Internet Information Services
Shortcut
2 KB

6 Display ftp site properties.

Right-click **Default FTP Site** and select **Properties**.

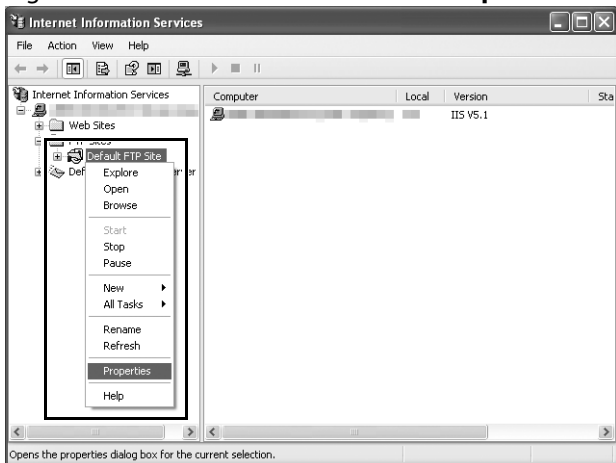

7 Select the address and port number.

Select the IP address entered in Step 4 and enter a **TCP port** number.

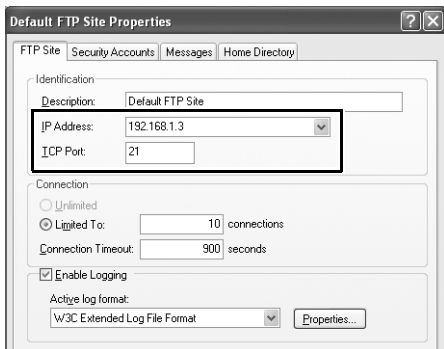

8 Choose a home directory.

Open the **Home Directory** tab and select **a directory located on this computer**. The root directory for images uploaded to the ftp server is listed in the **Local path** text box; choose a folder and select **Read**, **Write**, and **Log visits**. Click **OK** to close the properties dialog.

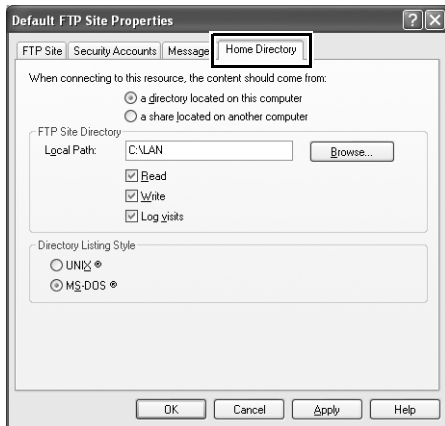

Mac OS X 10.6

1 Display network settings.

Open **System Preferences** and click **Network**.

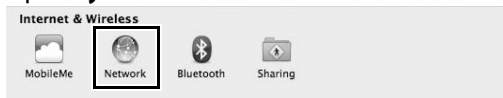

2 Adjust network settings.

Click the type of network you will use to connect to the server, enter an IP address, and note the subnet mask. Click **Show All** to return to the main System Preferences panel when settings are complete.

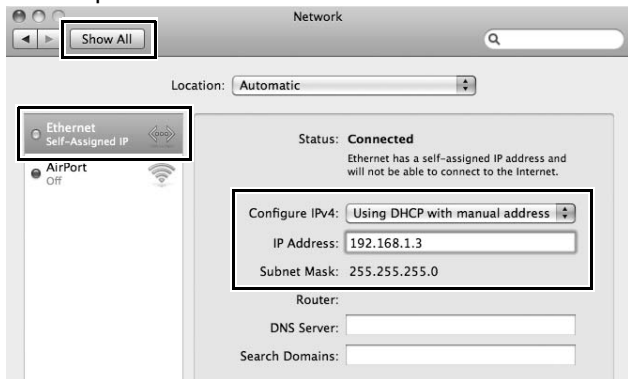

3 Click Sharing.

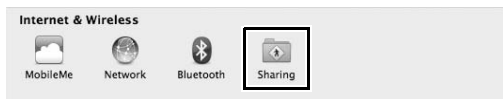

4 Display file sharing options.

Select **File Sharing** and click **Options...**

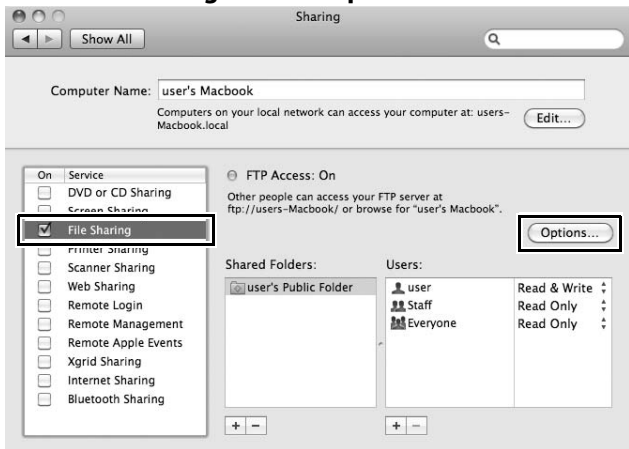

5 Turn ftp file sharing on.

Select **Share files and folders using ftp**.



Creating ftp Profiles Using Camera Menus

In transfer mode, the camera menus can be used in place of the Wireless Transmitter Utility to create ftp profiles. Before creating an ftp profile with the camera menus, connect the UT-1. To prevent unexpected loss of power, be sure the battery is fully charged or use an optional EP-5B power connector and EH-5b AC adapter.

- 1 Open the UT-1 USB connector cover and connect the USB cable from the UT-1 to the camera USB connector.

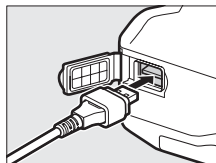

- 2 Turn the camera on.

Power switch

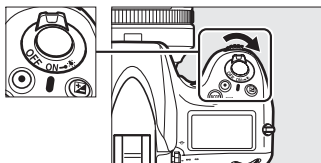

✓ Using the Menu

If the shutter-release button on the camera is pressed while menus are displayed, the monitor will turn off and any changes to the current profile will be lost.

✎ Firewalls

The UT-1 uses TCP ports 21 and 32768–61000 for ftp. It may be necessary to adjust firewall settings before connecting to a server behind a firewall.

✎ Editing Existing ftp Profiles

See page 73 for information on using camera menus to edit existing ftp profiles.

- 3** Press the power switch for about a second to turn the UT-1 on.

Power switch

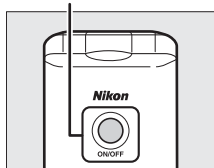

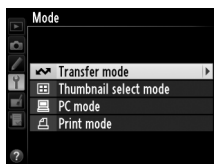

- 4** Select **Transfer mode** for **Wireless transmitter > Mode** (ⓘ72).

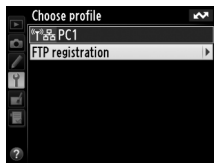

- 5** A profile list will be displayed showing the connections available in transfer mode. Highlight **FTP registration** and press the multi selector to the right. Note a new ftp profile can not be created if the camera already contains nine profiles; if necessary, delete a profile using the  button.



- 6** The registration dialog shown at right will be displayed. Press  or  to highlight an option, then press to the right to select. Select **Done** to proceed to Step 7 when settings are complete.

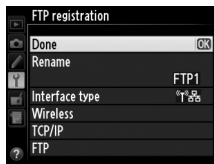

Rename: The dialog shown at right will be displayed. Enter a profile name of up to 16 characters as described in “Text Entry” (ⓘ73) and press the  button to return to the registration dialog.



Interface type: The dialog shown at right will be displayed. Highlight one of the following options and press the **OK** button to return to the registration dialog.

Option	Description
Wireless & Ethernet (default)	Connect via wireless and/or Ethernet.
Ethernet only	Connect via Ethernet only.

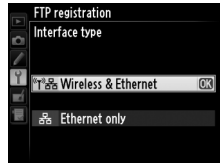

Wireless: If **Wireless & Ethernet** is selected for **Interface type**, select this option to adjust wireless settings as described in the Menu Guide (□ 74–77). Press **◀** to return to the registration dialog when settings are complete.

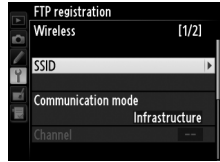

TCP/IP: Adjust TCP/IP settings as described in the Menu Guide (□ 78–81). Press **◀** to return to the registration dialog when settings are complete.

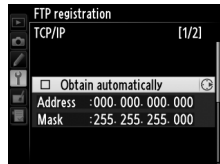

FTP: Adjust ftp settings as described in the Menu Guide (□ 82–88). Press **◀** to return to the registration dialog when settings are complete.

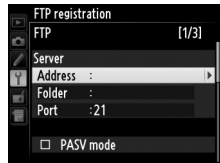

7 A confirmation dialog will be displayed. Choose from the following options:

- **Yes:** Open a connection to the new server and return to the top level of the wireless transmitter menu.
- **No:** Return to Step 5 without connecting to the server.

Troubleshooting

Problem	Solution	Page
"POWER" LED does not light.	<ul style="list-style-type: none"> • Turn the UT-1 on. • Confirm that the battery is inserted and fully charged. 	35, 43, 64 10, 92
Wireless transmitter option not available.	Confirm that the UT-1 is connected and on.	33, 42, 62
The Device info , and Device settings menus cannot be selected.	Confirm that the UT-1 is connected and on.	33, 42, 62
Excessive radio interference.	Adjust the position of the wireless access point or host computer.	—
All LEDs flash at once.	UT-1 hardware or battery malfunction. Contact a Nikon-authorized service representative.	—
Camera displays TCP/IP or FTP error.	<ul style="list-style-type: none"> • Check settings for host and/or wireless LAN adapter and adjust camera settings appropriately. 	28, 56, 73
	<ul style="list-style-type: none"> • Check firewall settings. 	7
Camera displays wireless error.	<ul style="list-style-type: none"> • Confirm that host and wireless LAN adapter are on. 	—
	<ul style="list-style-type: none"> • Ensure that there are no obstacles between UT-1 and wireless LAN adapter. • Check settings for host and/or wireless LAN adapter and adjust camera settings appropriately. 	28, 56, 73
Camera displays "Ethernet cable is not connected".	Connect Ethernet cable or change interface setting to Wireless & Ethernet .	25, 53, 118
Memory card error displayed.	Confirm that memory card is properly inserted.	—

Problem	Solution	Page
Transfer interrupted before all photographs are sent.	Transfer will resume if UT-1 is turned off and then on again.	35, 43, 64
USB cable disconnected during transmission.	Reconnect the USB cable. Do not turn the camera off.	—

Specifications

■ Communication Unit UT-1

Ethernet	
Standards	IEEE 802.3u (100 base-TX)/IEEE 802.3 (10 base-T)
Data rates	10/100 Mbps with auto detect
Port	100 base-TX/10 base-T (AUTO-MDIX)
Wireless (WT-5)	
Standards	WT-5/WT-5A/WT-5B/WT-5C: 802.11a/b/g/n WT-5D: 802.11b/g/n
Communications protocols	IEEE802.11a: OFDM IEEE802.11g: OFDM IEEE802.11b: DSSS IEEE802.11n: OFDM
Operating frequency (MHz)	WT-5: 5180-5320 MHz (36/40/44/48/52/56/60/64 ch) 5500-5700 MHz (100/104/108/112/116/120/124/128/132/136/140 ch) 2412-2472 MHz (1-13 ch) WT-5A: 5180-5320 MHz (36/40/44/48/52/56/60/64 ch) 5745-5825 MHz (149/153/157/161/165 ch) 2412-2462 MHz (1-11 ch) WT-5B: 5180-5320 MHz (36/40/44/48/52/56/60/64 ch) 2412-2472 MHz (1-13 ch) WT-5C: 5745-5825 MHz (149/153/157/161/165 ch) 2412-2472 MHz (1-13 ch) WT-5D: 2412-2462 MHz (1-11 ch)
Approximate range (line of sight)*	Approximately 180 m (590.5 ft)

Wireless (WT-5)	
Data rates †	IEEE 802.11a/g: 6, 9, 12, 18, 24, 36, 48 and 54 Mbps IEEE 802.11b: 1, 2, 5.5 and 11 Mbps IEEE 802.11n-HT20: 72 Mbps maximum IEEE 802.11n-HT40: 150 Mbps maximum
Security	Authentication: Open system, shared key, WPA-PSK, WPA2-PSK Encryption: 128/64 bit WEP, TKIP, AES
Access protocols	Infrastructure, ad hoc
Data transfer protocols	PTP-IP, ftp
Power consumption	Approximately 1.9 W maximum (UT-1 only) Approximately 2.8 W maximum (including WT-5)
Power source	Rechargeable EN-EL15 Li-ion battery ×1 (available separately), EP-5B power connector and EH-5b AC adapter (available separately)
Operating environment	Temperature: 0 °C–40 °C (32 °F–131 °F) Humidity: 85% or less (no condensation)
Weight	Approximately 205 g/7.2 oz. (body only)/ Approximately 120 g/4.2 oz. (including battery)
Dimensions (W × H × D)	Approximately 57 mm × 46 mm × 114 mm (2.2 in. × 1.8 in. × 4.5 in.)

* With large antenna at wireless LAN access point. Range may vary with signal strength and presence or absence of obstacles.

† Maximum logical data rates according to IEEE standard. Actual rates may differ.

Battery Life

The length of time batteries can be used and the number of shots that can be uploaded before recharging varies with the condition of the batteries, signal strength, and how camera and UT-1 are used. The following measurements were performed using a fully-charged EN-EL15 battery (1900 mAh) at a temperature of 23 °C (73.4 °F) while continuously uploading images with an average file size of 9 megabytes to an ftp server configured using Internet Information Services (ISS) under Windows 7 Ultimate over an infrastructure network with the UT-1 in transfer mode (all figures are approximate).

Network	Wireless (802.11n)	Ethernet (100 base-TX)
No. of shots uploaded	8000	17000
Battery life	300 min. (5 hr.)	480 min. (8 hr.)

To ensure maximum battery performance:

- Keep the battery contacts clean. Soiled contacts can reduce battery performance.
- Use EN-EL15 batteries immediately after charging. Batteries will lose their charge if left unused.
- Periodically check the battery level using **Wireless Transmitter > Device info > Battery info**.
- The battery level displayed by the camera may vary with changes in temperature.
- A sharp drop in the length of time the battery can hold a charge indicates that the battery must be replaced.

Index

Symbols

✉: "Send"	39, 67
✉: "Sending"	39, 67
✉: "Sent"	39, 67

A

Ad-hoc	74
Auto power off	11, 93
Auto send	89

B

Battery info	92
BSS-ID	28, 74

C

Camera Control Pro 2	6, 42, 45
Channel	28, 56, 75, 121
Connecting the UT-1	33, 42, 62, 116

D

Delete after send?	89
Deselect all?	90
Device info	92
Device settings	93
DHCP server	30, 78
Domain Name Server (DNS) ...	30, 58, 81

E

Encryption	28, 56, 76
key	28, 56, 76
Errors	119
ftp	119
TCP/IP	119
wireless	119
ESS-ID	28, 74
Ethernet	2, 6, 7, 25, 53, 118, 119

F

File names	41, 66, 69
Firmware Version	92
Folders	23, 37, 59, 83, 100, 109, 113
Format transmitter's memory	93
FTP	82, 118
FTP server	59, 82, 95

G

Gateway	58, 80
---------------	--------

I

Infrastructure	74
IP address	30, 58, 78, 118

M

MAC address	92
Mac OS X	114
Memory cards	33
Menus	71–93, 116–118
entering text in	73
Mode	6, 34, 43, 72

P

password	23
PASV mode	59, 84
PC mode	6, 42
Port	7, 59, 83, 116
Port number	101, 108, 112
Print	91
Printing	91
Proxy	59, 87
PTP-IP	122

S

Send file as	90
Send folder	90
SS-ID	28, 56, 74
Status LEDs	2, 3, 40, 46

T

TCP/IP	30, 58, 78, 118
Transfer mode	6, 33, 117
Transfer Settings	89

U

Upload	33, 36, 65
deleting images after	89
Interrupting	37, 66
selecting images for	36, 65
User ID	59, 85

W

Windows 7	96
Windows Vista	103
Windows XP	110

Wireless.....	74, 118
Wireless LAN	
access point.....	74
Wireless transmitter	71
Wireless Transmitter Utility	14, 20, 50

No reproduction in any form of this manual, in whole or in part (except for brief quotation in critical articles or reviews), may be made without written authorization from NIKON CORPORATION.



Free Manuals Download Website

<http://myh66.com>

<http://usermanuals.us>

<http://www.somanuals.com>

<http://www.4manuals.cc>

<http://www.manual-lib.com>

<http://www.404manual.com>

<http://www.luxmanual.com>

<http://aubethermostatmanual.com>

Golf course search by state

<http://golfingnear.com>

Email search by domain

<http://emailbydomain.com>

Auto manuals search

<http://auto.somanuals.com>

TV manuals search

<http://tv.somanuals.com>