



Series Twelve

ELECTRIC WATER HEATER USER'S GUIDE

FOR POTABLE WATER
HEATING ONLY
NOT SUITABLE FOR
SPACE HEATING



Model Numbers

HRE11240S
HRE41240S
HRE11250S
HRE41250S
HRE11250T
HRE41250T
HRE11282T
HRE41282T



LISTED



GAMA certification applies to all residential electric water heaters with capacities of 20 to 120 gallons. Input rating of 12 kW or less at a voltage no greater than 250V.

	! WARNING
	<p>Read and understand instruction manual and safety messages before installing, operating or servicing this water heater.</p> <p>Failure to follow instructions and safety messages could result in death or serious injury.</p> <p>Instruction manual must remain with water heater.</p>





SAVE THIS MANUAL FOR FUTURE REFERENCE.

SAFE INSTALLATION, USE AND SERVICE

Your safety and the safety of others is extremely important in the installation, use and servicing of this water heater.

Many safety-related messages and instructions have been provided in this manual and on your own water heater to warn you and others of a potential injury hazard. Read and obey all safety messages and instructions throughout this manual. It is very important that the meaning of each safety message is understood by you and others who install, use or service this water heater.

	This is the safety alert symbol. It is used to alert you to potential personal injury hazards. Obey all safety messages that follow this symbol to avoid possible injury or death.
---	--

	DANGER indicates an imminently hazardous situation which, if not avoided, could result in death or injury.
	WARNING indicates a potentially hazardous situation which, if not avoided, could result in death or injury.
	CAUTION indicates a potentially hazardous situation which, if not avoided, may result in minor or moderate injury.
	CAUTION used without the safety alert symbol indicates a potentially hazardous situation which, if not avoided, could result in property damage.

All safety messages will generally tell you about the type of hazard, what can happen if you do not follow the safety message and how to avoid the risk of injury.

IMPORTANT DEFINITIONS

- **Maytag Customer Service Center:** The Maytag Customer Service Center has the ability equivalent to a licensed tradesman in the fields of plumbing and electrical work including a thorough understanding of the requirements of the National Electric Code as it relates to the installation of electric water heaters. The Service Center also has a thorough understanding of this instruction manual, and is able to perform repairs strictly in accordance with the service guidelines provided by the manufacturer.

GENERAL SAFETY

	⚠ WARNING
	<p>Read and understand instruction manual and safety messages before installing, operating or servicing this water heater.</p> <p>Failure to follow instructions and safety messages could result in death or serious injury.</p> <p>Instruction manual must remain with water heater.</p>

CAUTION
Improper installation and use may result in property damage.
<ul style="list-style-type: none">• Do not operate water heater if flood damaged.• Inspect and replace the anode as needed.• Install in location with drainage.• Fill tank with water before operation.• Be alert for thermal expansion. <p>Refer to instruction manual for installation and service.</p>

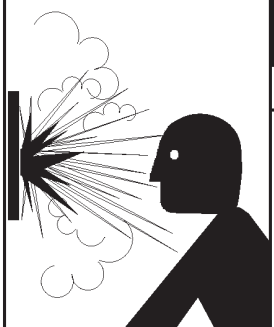
	⚠ WARNING
	Explosion Hazard <ul style="list-style-type: none">• Overheated water can cause water tank explosion.• Properly sized temperature and pressure relief valve must be installed in opening provided.

	⚠ WARNING
	<ul style="list-style-type: none">• Before removing any access panels or servicing the water heater, make sure the electrical supply to the water heater is turned "OFF".• Failure to do this could result in death, serious bodily injury, or property damage.

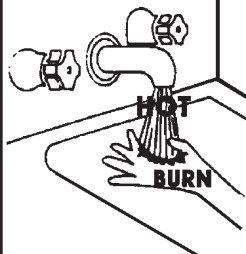
	⚠ DANGER
	<p>Water temperature over 125°F (52°C) can cause severe burns instantly resulting in severe injury or death.</p> <p>Children, the elderly, and the physically or mentally disabled are at highest risk for scald injury.</p> <p>Feel water before bathing or showering.</p> <p>Temperature limiting valves are available.</p> <p>Read instruction manual for safe temperature setting.</p>



⚠ WARNING		
Fire Hazard / Electric Shock Hazard		
	<ul style="list-style-type: none">• Do not use this water heater with any voltage other than shown on the model rating plate.• Failure to use the correct voltage shown on the model rating plate could result in death, serious bodily injury, or property damage.	

TABLE OF CONTENTS

SAFE INSTALLATION, USE AND SERVICE	2
GENERAL SAFETY	3
TABLE OF CONTENTS	4
CUSTOMER INFORMATION	5
PRODUCT SPECIFICATIONS	5
ACCESSORIES AND TOOLS NEEDED	6
Accessories	6
Tools	6
INSTALLATION INSTRUCTIONS	7-16
Removing the Old Water Heater	7,8
Locating the New Water Heater	8
Insulation Blankets	8
Typical Installation	8,9
The Convertible Lower Element	9
Water Piping	10
T & P Valve and Pipe Insulation	10,11
Temperature-Pressure Relief Valve	11,12
Filling the Water Heater	12
Converting the Lower Element	12-14
Wiring	14,15
Wiring Diagrams	16
SERVICE AND MAINTENANCE	17-22
Temperature Regulation	17
Thermostat	17
Temperature Settings	17
Thermostat Adjustment	17,18
Anode Rod Inspection	18
Temperature-Pressure Relief Valve Operation	18
Draining	18,19
Thermostat Removal/Replacement	19
Element Cleaning/Replacement	19-22
Drain Valve Washer Replacement	22
Service	22
TROUBLESHOOTING GUIDE	22-25
Start Up Conditions	22
Thermal Expansion	22
Strange Sounds	22
Operational Conditions	23,24
Smelly Water	23
“Air” in Hot Water Faucets	23
Rumbling Noise	23
High Temperature Shut Off System	23,24
Not Enough or No Hot Water	24
Water Is Too Hot	24
Leakage Checkpoints	24,25
REPAIR PARTS LIST	25-27
WARRANTY	28

CUSTOMER INFORMATION

Thank You for purchasing a Maytag water heater. Properly installed and maintained, it should give you years of trouble free service. It is strongly suggested that this new water heater be professionally installed, call Maytag Customer Service at 1-800-788-8899 for recommended installers.

Abbreviations Found In This Instruction Manual:

UL – Underwriters Laboratories, Inc.

NEC – National Electrical Code

ANSI – American National Standards Institute

- Read the “General Safety” section, page 3 of this manual first and then the entire manual carefully. If you don’t follow the safety rules, the water heater will not operate properly. It could cause DEATH, SERIOUS BODILY INJURY AND/OR PROPERTY DAMAGE.

This manual contains instructions for the installation, operation, and maintenance of this electric water heater. It also contains warnings throughout the manual that you must read and be aware of. All warnings and all instructions are essential to the proper operation of the water heater and your safety. Since we cannot put everything on the first few pages, **READ THIS ENTIRE MANUAL BEFORE ATTEMPTING TO INSTALL OR OPERATE THE WATER HEATER.**

- The installation must conform with the instructions in this manual; electric company rules; and Local Codes, or in the

absence of Local Codes, with the current edition of the NEC - National Electrical Code NFPA 70. This publication is available from your local government or public library or electric company or by writing Underwriters Laboratories Inc., 333 Pfingsten Road, Northbrook, IL 60062.

- If after reading this manual you have any questions or do not understand any portion of the instructions, call Maytag Customer Service at 1-800-788-8899 for an authorized servicer.
- Carefully plan the place where you are going to put the water heater. Correct electrical wiring and connections are very important in preventing death from possible electrical shock and fires.

Examine the location to ensure the water heater complies with the “Locating the New Water Heater” section.

- For California installation this water heater must be braced, anchored, or strapped to avoid falling or moving during an earthquake. See instructions for correct installation procedures. Instructions may be obtained from the California office of the State Architect, 400 P Street, Sacramento, CA 95814.
- Massachusetts Code requires this water heater to be installed in accordance with Massachusetts 248-CMR 2.00: State Plumbing Code and 248-CMR 5.00. In the Commonwealth of Massachusetts, this product must be installed by a licensed plumber or gasfitter.

PRODUCT SPECIFICATIONS

MODEL NUMBER	TANK CAPACITY	DIMENSIONS IN INCHES		RECOVERY RATE IN GALLONS PER HOUR @ 90°F RISE			ELEMENT WATTAGE @240 VOLTS			MINIMUM WIRE SIZE (GAUGE)	MAXIMUM FUSE OR CIRCUIT BREAKER SIZE (AMPS)
	GALS	DIA.	HEIGHT	UPPER	LOWER		UPPER	LOWER			
HRE11240S	40	22.5	47	17.3	17.3	25	3800	3800	5500	12	20
HRE41240S	40	22.5	47	17.3	17.3	25	3800	3800	5500	10	30
HRE11250S	50	24	50	17.3	17.3	25	3800	3800	5500	12	20
HRE41250S	50	24	50	17.3	17.3	25	3800	3800	5500	10	30
HRE11250T	50	22.5	57	17.3	17.3	25	3800	3800	5500	12	20
HRE41250T	50	22.5	57	17.3	17.3	25	3800	3800	5500	10	30
HRE11282T	80	26	62	17.3	17.3	25	3800	3800	5500	12	20
HRE41282T	80	26	62	17.3	17.3	25	3800	3800	5500	10	30

** Wiring size based on standard 60°C copper wire. If distance from fuse box to water heater is more than 90 feet, refer to your local electrical code.

ACCESSORIES AND TOOLS NEEDED

Accessories

To simplify the installation Maytag has available the installation parts shown below. You may or may not need all of these accessories depending on your type of installation. **Call Maytag Customer Service at 1-800-788-8899 for an authorized installer.**

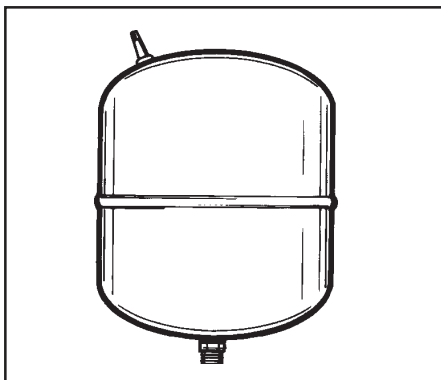

EXPANSION TANKS FOR THERMAL EXPANSION CONDITIONS AVAILABLE IN 2 GALLONS (7.6 LITERS), Part No. 66001013 AND 5 GALLONS (18.9 LITERS), Part No. 66001014 CAPACITY.

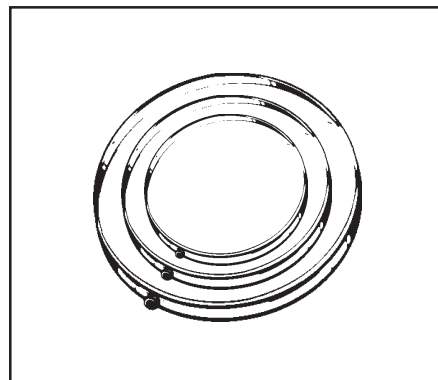

DRAIN PANS AVAILABLE IN 22" (559 mm) DIAMETER (PART NO. 66001011) FOR WATER HEATERS HAVING A DIAMETER 20" (508 mm) OR LESS, 24" (610mm) DIAMETER (PART NO. 66001105) FOR WATER HEATERS HAVING A DIAMETER 22" (559 mm) OR LESS AND 28" (711 mm) DIAMETER (PART NO. 66001012) FOR WATER HEATERS HAVING A DIAMETER 26" (660 mm) OR LESS.

Tools

You may or may not need all of these tools, depending on your type of installation. These tools can be purchased at your local Maytag store.

- Pipe Wrench (2) 14"
- Screwdriver
- 6 Foot Tape or Folding Rule
- Garden Hose
- Drill
- Pipe Dope or Teflon Tape



ROLL OF TEFLON TAPE (USE ON WATER CONNECTIONS)



PIPE DOPE (SQUEEZE TUBE) USE FOR WATER CONNECTIONS



GARDEN HOSE



6 FOOT TAPE

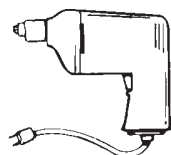

DRILL



SLOT-HEAD SCREWDRIVER



PHILLIPS SCREWDRIVER



PIPE WRENCH

Additional Tools Needed When Sweat Soldering

- Tubing Cutters or Hacksaw
- Propane Torch
- Soft Solder
- Solder Flux
- Emery Cloth
- Wire Brushes



TUBING CUTTER

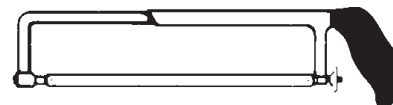

HACKSAW



ROLL OF EMERY CLOTH



ROLL OF LEAD-FREE SOFT SOLDER



SOLDER FLUX



PROPANE TORCH



3/4" (19 mm) WIRE BRUSH



1/2" (13 mm) WIRE BRUSH

INSTALLATION INSTRUCTIONS

Removing the Old Water Heater

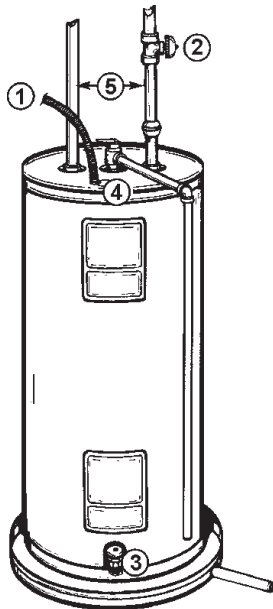

FIGURE 1.

1. Turn "OFF" electrical supply to the water heater.

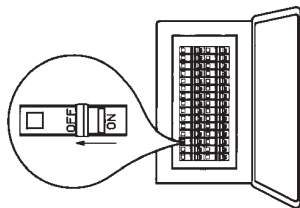

FIGURE 2.

2. Turn "OFF" the water supply to the water heater at the water shut-off valve or water meter.

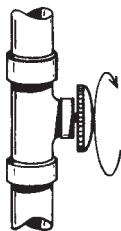

FIGURE 3.

3. Attach a hose to the water heater drain valve and put the other end in a floor drain or outdoors. Open the water heater drain valve. Open a nearby hot water faucet which will relieve pressure in the water heater and speed draining.

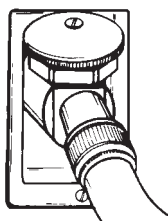
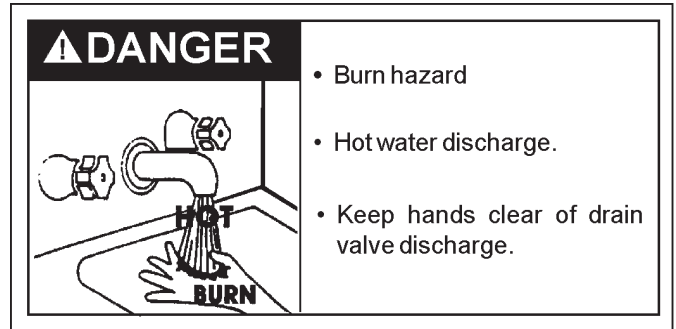

FIGURE 4.



The water passing out of the drain valve may be extremely hot. To avoid being scalded, make sure all connections are tight and that the water flow is directed away from any person.

4. Check again to make sure the electrical supply is turned "OFF" to the water heater. Then unplug the water heater (cord set) or disconnect the electrical supply connection from the water heater junction box.

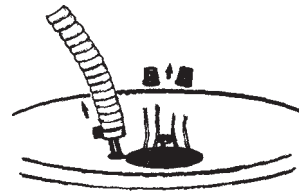

FIGURE 5.

5. a. If you have copper piping to the water heater, the two copper water pipes can be cut with a hacksaw approximately four inches away from where they connect to the water heater. This will avoid cutting off the pipes too short. Additional cuts can be made later if necessary. Disconnect the temperature-pressure relief valve drain line. When the water heater is drained, disconnect the hose from the drain valve. Close the drain valve. The water heater is now completely disconnected and ready to be removed.

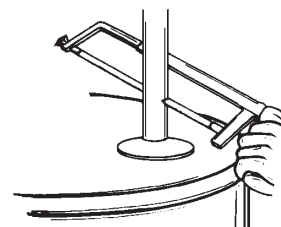

FIGURE 6.

5. b. If you have galvanized pipe to the water heater, loosen the two galvanized pipes with a pipe wrench at the union in each line. Also disconnect the piping remaining to the water heater. These pieces should be saved since they may be needed when reconnecting the new water heater. Disconnect the temperature-pressure relief valve drain line. When the water heater is drained, disconnect the hose from the drain valve. Close the drain valve. The water heater is now completely disconnected and ready to be removed.

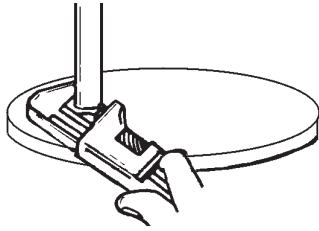

FIGURE 7.

CAUTION

Mineral Buildup or Sediment May Accumulate

- This causes the water heater to become much heavier than normal.
- If spilled, could cause staining.

Mineral buildup or sediment may have accumulated in the old water heater. This causes the water heater to be much heavier than normal and this residue, if spilled out, could cause staining.

Locating the New Water Heater

CAUTION

Property Damage Hazard

- All water heaters eventually leak
- Do not install without adequate drainage.

You should carefully choose an indoor location for the new water heater, because the placement is a very important consideration for the safety of the occupants in the building and for the most economical use of the appliance. **This water heater is not intended for outdoor installation.**

Whether replacing an old water heater or putting the water heater in a new location, the following critical points must be observed.

- The location selected should be indoors as close to and as centralized with the water piping system as possible. This water heater, as well as all water heaters, will eventually leak. Do not install without adequate drainage provisions so water flow will not cause damage.

Water heater life depends upon water quality, water pressure and the environment in which the water heater is installed. Water heaters are sometimes installed in locations where leakage may result in property damage, even with the use of a drain pan piped to a drain. However, unanticipated damage can be reduced or prevented by a leak detector or water shut-off device used in conjunction with a piped drain pan. These devices are available from some plumbing supply wholesalers and retailers, and detect and react to leakage in various ways:

- Sensors mounted in the drain pan that trigger an alarm or turn off the incoming water to the water heater when leakage is detected.

- Sensors mounted in the drain pan that turn off the water supply to the entire home when water is detected in the drain pan.
- Water supply shut-off devices that activate based on the water pressure differential between the cold water and hot water pipes connected to the water heater.

INSULATION BLANKETS

Insulation blankets are available to the general public for external use on electric water heaters but are not necessary with this product. The purpose of an insulation blanket is to reduce the standby heat loss encountered with storage tank heaters. Your water heater meets or exceeds the National Appliance Energy Conservation Act standards with respect to insulation and standby loss requirements, making an insulation blanket unnecessary.

Should you choose to apply an insulation blanket to this heater, you should follow these instructions below. Failure to follow these instructions can result in fire, serious personal injury, or death.

- **Do not** cover the temperature and pressure relief (T & P) valve with an insulation blanket.
- **Do not** cover the instruction manual. Keep it on the side of the water heater or nearby for future reference.
- **Do** obtain new warning and instruction labels for placement on the blanket directly over the existing labels.

Typical Installation

Check all connections for leaks. Consult the local utility company to examine installation for propriety and safety.

⚠ DANGER

Water temperature over 125°F (52°C) can cause severe burns instantly resulting in severe injury or death.

Children, the elderly, and the physically or mentally disabled are at highest risk for scald injury.

Feel water before bathing or showering.

Temperature limiting valves are available.

Read instruction manual for safe temperature setting.

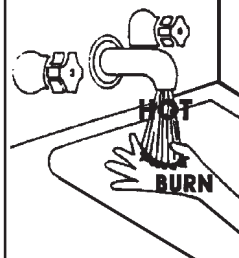

HOTTER WATER CAN SCALD: Water heaters are intended to produce hot water. Water heated to a temperature which will satisfy clothes washing, dish washing, and other sanitizing needs can scald and permanently injure you upon contact. Some people are more likely to be permanently injured by hot water than others. These include the elderly, children, the infirm, or physically/mentally handicapped. If anyone using hot water in your home fits into one of these groups or if there is a local code or state law requiring a certain temperature water at the hot water tap, then you must take special precautions. In addition to using the lowest possible temperature setting that satisfies your hot water needs, a means such as a mixing valve, shall be used at the hot water taps used by these people or at the water heater. Mixing valves are available at plumbing

supply or hardware stores. Follow manufacturers instructions for installation of the valves. Before changing the factory setting on the thermostat, read the "Temperature Regulation" section in this manual.

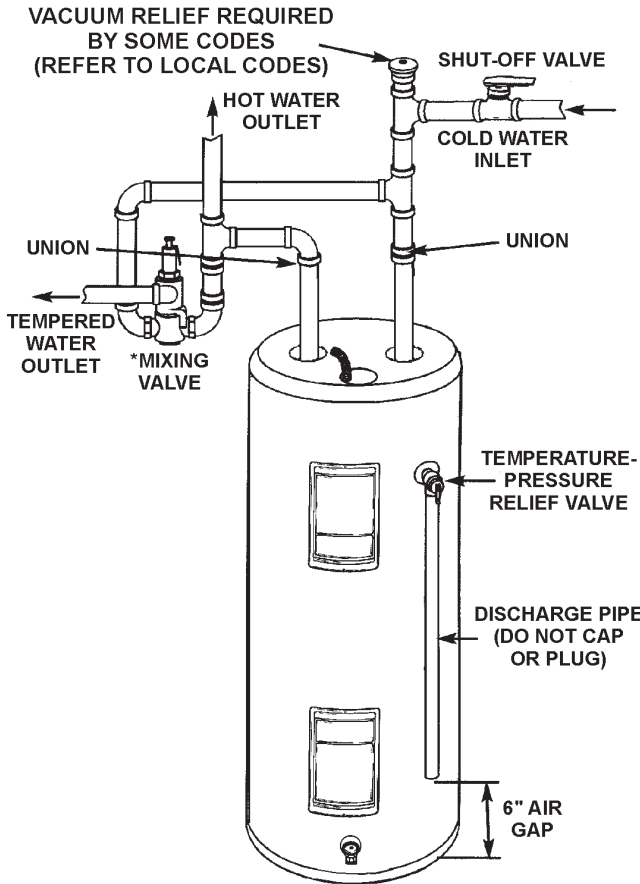

FIGURE 8

INSTALLATION IN RESIDENTIAL GARAGES: The water heater must be located and/or protected so it is not subject to physical damage by a moving vehicle.

- The location selection must provide adequate clearances for servicing and proper operation of the water heater.

The Convertible Lower Element

The Upper Element, is a conventional 3800 watt element which only operates at its rated wattage on 240 volts. (See rating plate on the water heater).

The Lower Element of the water heater can be converted from operation at 3800 watts to 5500 watts on a 240 volt system.

Read and follow water heater warnings and instructions. If after reading these instructions in this manual, you do not understand any portion, call **Maytag Customer Service at 1-800-788-8899** for an authorized sevicer.

! WARNING

Fire Hazard / Electric Shock Hazard



- Do not use this water heater with any voltage other than shown on the model rating plate.
- Failure to use the correct voltage shown on the model rating plate could result in death, serious bodily injury, or property damage.

CAUTION

Property Damage Hazard

- All water heaters eventually leak
- Do not install without adequate drainage.

WATER HEATERS EVENTUALLY LEAK: Installation of the water heater must be accomplished in such a manner that if the tank or any connections should leak, the flow of water will not cause damage to the structure. For this reason, it is not advisable to install the water heater in an attic or upper floor. When such locations cannot be avoided, a suitable drain pan should be installed under the water heater. Drain pans are available at your local hardware store. Such a drain pan must have a minimum length and width of at least 1 3/4 inches greater than the water heater dimensions and must be piped to an adequate drain.

CAUTION

Installations in Residential Garages

- Water heater must be located in a protective area.

Before making the conversion to 5500 watts, check the (1) power supply . . . must be 240 volts, (2) wiring . . . 10 gauge AWG @ Type TW, 60°C or equivalent, and (3) Circuit breakers or fusing . . . capable of 30 amp loading. Also, the installation must conform with this manual, local codes and electric utility rules. Failure to comply can result in **DEATH, SERIOUS BODILY INJURY, OR PROPERTY DAMAGE.**

ELECTRIC WATER HEATER			LISTED 932N
MODEL NUMBER	CAPACITY U.S. GAL.	SERIAL NUMBER	
FACTORY EQUIPPED WITH			
UPPER ELEMENT WATTS	LOWER ELEMENT WATTS	MAXIMUM WATTS	VOLTS A.C. ONLY
			CHECK HERE IF INSTALLED AS FACTORY EQUIPPED
			MAXIMUM WORKING PRESSURE P.S.I.
OPTIONAL WATTAGE			
UPPER ELEMENT WATTS	LOWER ELEMENT WATTS	MAXIMUM WATTS	CHECK HERE IF CONVERTED
			WARNING SEE CONVERSION INSTRUCTION

NOTE: Whether or not the element conversion is made the model rating plate must be marked. Using a hard point ink pen, check the appropriate block within the model rating plate, which is located adjacent to the lower access panel.

Water Piping

⚠ DANGER

Water temperature over 125°F (52°C) can cause severe burns instantly resulting in severe injury or death.

Children, the elderly, and the physically or mentally disabled are at highest risk for scald injury.

Feel water before bathing or showering.

Temperature limiting valves are available.

Read instruction manual for safe temperature setting.

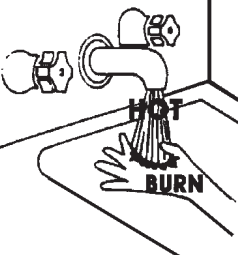

HOTTER WATER CAN SCALD: Water heaters are intended to produce hot water. Water heated to a temperature which will satisfy clothes washing, dish washing, and other sanitizing needs can scald and permanently injure you upon contact. Some people are more likely to be permanently injured by hot water than others. These include the elderly, children, the infirm, or physically/mentally handicapped. If anyone using hot water in your home fits into one of these groups or if there is a local code or state law requiring a certain temperature water at the hot water tap, then you must take special precautions. In addition to using the lowest possible temperature setting that satisfies your hot water needs, a means such as a mixing valve, shall be used at the hot water taps used by these people or at the water heater. Mixing valves are available at plumbing supply or hardware stores. Follow manufacturers instructions for installation of the valves. Before changing the factory setting on the thermostat, read the "Temperature Regulation" section in this manual.

See Figure 8 on page 9 for mixing valve usage.

Figure 9 shows the attachment of the water piping to the water heater. The water heater is equipped with 3/4" water connections.

If a water heater is installed in a closed water supply system; such as one having a back-flow preventer, check valve, water meter with a check valve, etc... in the cold water supply; means must be provided to control thermal expansion. Contact the local utility or call **Maytag Customer Service at 1-800-788-8899** for an authorized servicer on how to control this situation.

NOTE: If using copper tubing, solder tubing to an adapter before attaching the adapter to the water inlet connection. Do not solder the water supply lines directly to the cold water inlet. It will harm the dip tube and damage the tank.

CAUTION

Property Damage Hazard

- Avoid water heater damage.
- Install thermal expansion tank if necessary.
- Do not apply heat to cold water inlet.
- Contact qualified installer or service agency.

NOTE: To protect against untimely corrosion of hot and cold water fittings, it is strongly recommended that di-electric unions or couplings be installed on this water heater when connected to copper pipe.

1. Look at the upper pipe nipple on the water heater. The water outlet is marked hot. Connect the hot water pipe to the hot water outlet of the water heater.
2. Look at the lower pipe nipple on the water heater. The cold water inlet is marked cold. Connect the cold water pipe to the cold water inlet of the water heater.

NOTE: Your water heater is insulated to minimize heat loss from the tank. Further reduction in heat loss can be accomplished by insulating the hot water lines from the water heater.

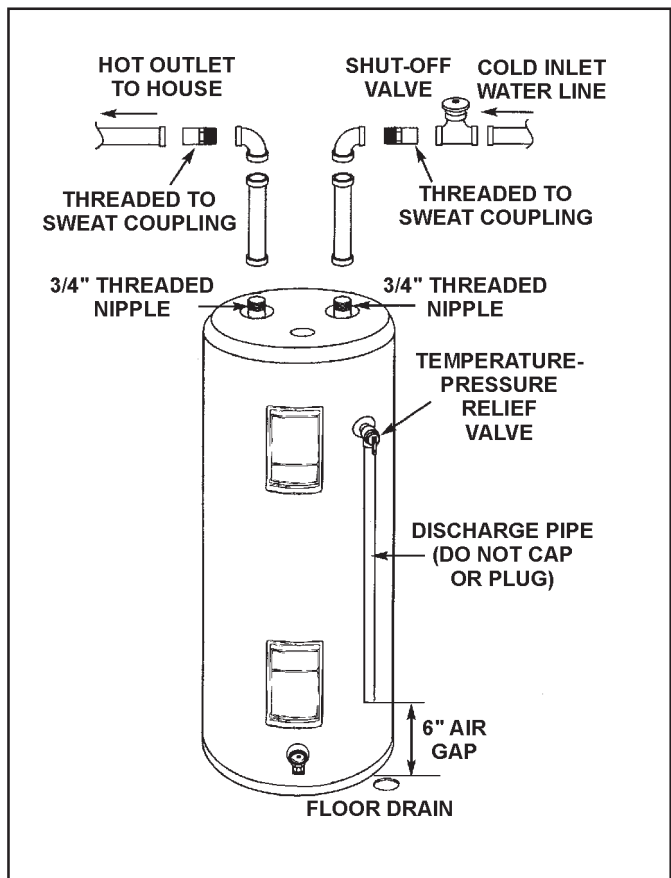

FIGURE 9.

T & P Valve and Pipe Insulation

Remove insulation for T & P valve and pipe connections from carton.

Fit pipe insulation over the incoming cold water line and the hot water line. Make sure that the insulation is against the top cover of the heater.

Fit T & P valve insulation over valve. Make sure that the insulation does not interfere with the lever of the T & P valve.

Secure all insulation using tape.

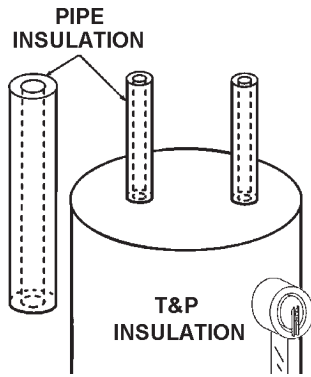
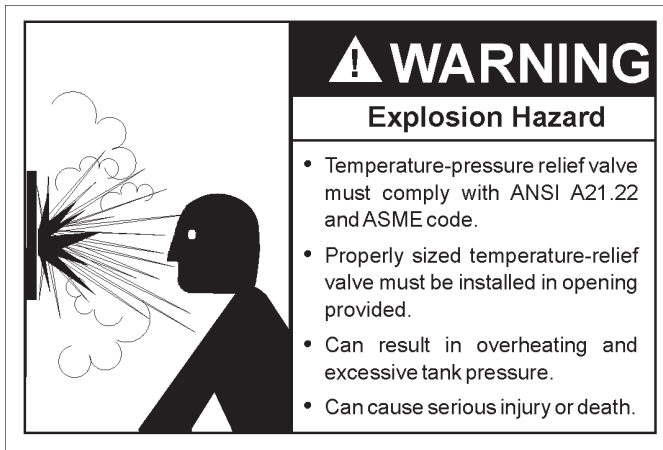

FIGURE 9A.

Temperature-Pressure Relief Valve



This heater is provided with a properly certified combination temperature - pressure relief valve by the manufacturer.

The valve is certified by a nationally recognized testing laboratory that maintains periodic inspection of production of listed equipment of materials as meeting the requirements for Relief Valves and Automatic Gas Shut-off Devices for Hot Water Supply Systems, ANSI Z21.22 • CSA 4.4, and the code requirements of ASME.

If replaced, the valve must meet the requirements of local codes, but not less than a combination temperature and pressure relief valve certified as indicated in the above paragraph.

The valve must be marked with a maximum set pressure not to exceed the marked hydrostatic working pressure of the water heater (150 psi = 1,035 kPa) and a discharge capacity not less than the water heater input rate as shown on the model rating plate.

For safe operation of the water heater, the relief valve must not be removed from its designated opening nor plugged.

The temperature-pressure relief valve must be installed directly into the fitting of the water heater designed for the relief valve. Position the valve downward and provide tubing so that any discharge will exit only within 6 inches (153 mm) above, or at any distance below the structural floor. Be certain that no contact is made with any live electrical part. The discharge opening must not be blocked or reduced in size under any

circumstances. Excessive length, over 30 feet (9.14 m), or use of more than four elbows can cause restriction and reduce the discharge capacity of the valve.

No valve or other obstruction is to be placed between the relief valve and the tank. Do not connect tubing directly to discharge drain unless a 6 inch air gap is provided. To prevent bodily injury, hazard to life, or property damage, the relief valve must be allowed to discharge water in quantities should circumstances demand. If the discharge pipe is not connected to a drain or other suitable means, the water flow may cause property damage.

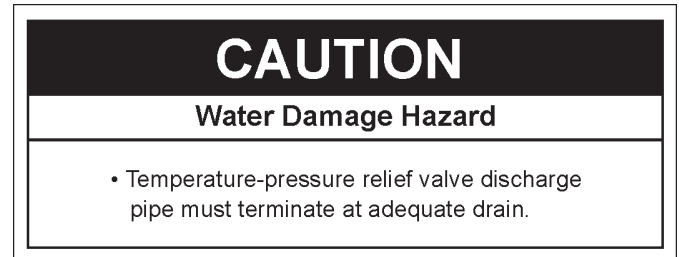

The Discharge Pipe:

- Shall not be smaller in size than the outlet pipe size of the valve, or have any reducing couplings or other restrictions.
- Shall not be plugged or blocked.
- Shall be of material listed for hot water distribution.
- Shall be installed so as to allow complete drainage of both the temperature-pressure relief valve, and the discharge pipe.
- Shall terminate at an adequate drain.
- Shall not have any valve between the relief valve and tank.

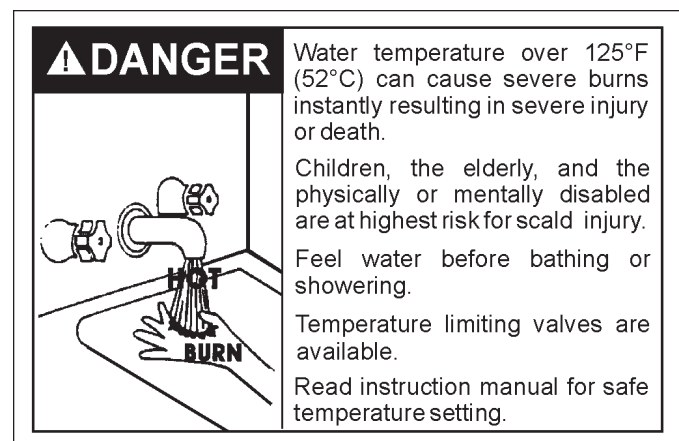

The temperature-pressure relief valve must be manually operated at least once a year. Caution should be taken to ensure that (1) no one is in front of or around the outlet of the temperature-pressure relief valve discharge line, and (2) the water manually discharged will not cause any bodily injury or property damage because the water may be extremely hot.

If after manually operating the valve, it fails to completely reset and continues to release water, immediately close the cold water inlet to the water heater, follow the draining instructions, and replace the temperature-pressure relief valve with a new one.

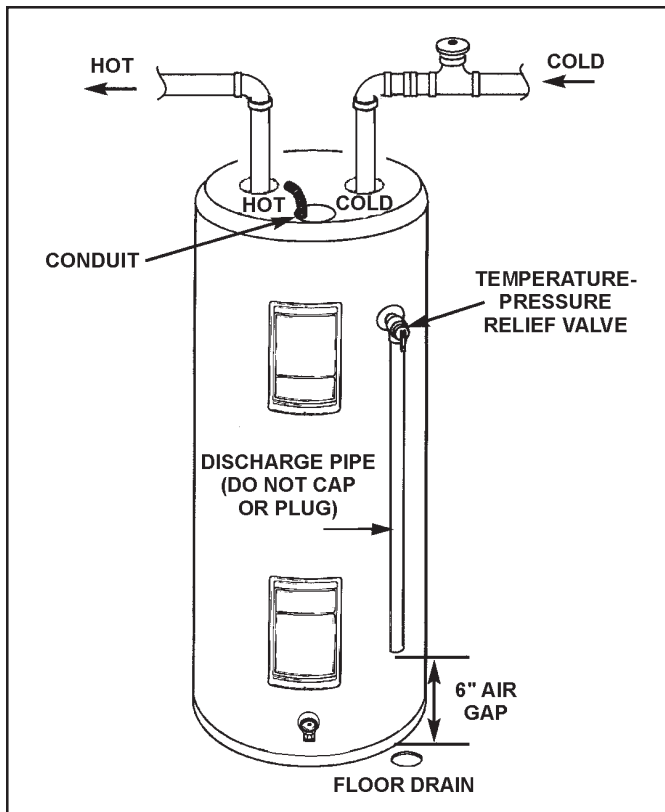

FIGURE 10.

Filling the Water Heater

CAUTION
Property Damage Hazard
<ul style="list-style-type: none"> • Avoid water heater damage. • Fill tank with water before operating.

Never use this water heater unless it is completely full of water. To prevent damage to the tank and heating element, the tank must be filled with water. Water must flow from the hot water faucet before turning "ON" power.

To fill the water heater with water:

1. Close the water heater drain valve by turning the handle to the right (clockwise). The drain valve is located on the lower front of the water heater.
2. Open the cold water supply valve to the water heater.

NOTE: The cold water supply valve must be left open when the water heater is in use.

3. To insure complete filling of the tank, allow air to exit by opening the nearest hot water faucet. Allow water to run until a constant flow is obtained. This will let air out of the water heater and the piping.

4. Check all new water piping for leaks. Repair as needed.

Converting the Lower Element

These instructions only cover the conversion of the convertible element, read this entire manual before attempting to install or operate the water heater. The water heater is factory set to operate at 3800 watts. The lower element can be converted to operate at 5500 watts. Refer to "The Convertible Lower Element" section.

The Upper Element is a conventional 3800 watt element which only operates at its rated wattage on 240 volts. (See rating plate on the water heater.

The lower Element of the water heater can be converted from operation at 3800 watts to 5500 watts on a 240 volt system.

If after reading these instructions and this manual, if you do not understand any portion, call **Maytag Customer Service at 1-800- 788-8899 for an authorized servicer.**

⚠ WARNING	
Fire Hazard / Electric Shock Hazard	
	<ul style="list-style-type: none"> • Do not use this water heater with any voltage other than shown on the model rating plate. • Failure to use the correct voltage shown on the model rating plate could result in death, serious bodily injury, or property damage.

Before making the conversion to 5500 watts, check the (1) power supply . . . must be 240 volts, (2) wiring . . . 10 gauge AWG @ Type TW, 60°C or equivalent, and (3) Circuit breakers or fusing . . . capable of 30 amp loading. Also, the installation must conform with this manual, local codes and electric utility rules. Failure to comply can result in DEATH, SERIOUS BODILY INJURY, OR PROPERTY DAMAGE.

NOTE: Whether or not the element conversion is made the model rating plate must be marked. Using a hard point ink pen, check the appropriate block within the model rating plate, which is located adjacent to the lower access panel.

ELECTRIC WATER HEATER			
MODEL NUMBER	CAPACITY U.S. GAL.	SERIAL NUMBER	
FACTORY EQUIPPED WITH			
UPPER ELEMENT WATTS	LOWER ELEMENT WATTS	MAXIMUM WATTS	CHECK HERE IF INSTALLED AS FACTORY EQUIPPED
OPTIONAL WATTAGE			
UPPER ELEMENT WATTS	LOWER ELEMENT WATTS	MAXIMUM WATTS	CHECK HERE IF CONVERTED
			WARNING SEE CONVERSION INSTRUCTION

FIGURE 11.

Necessary element conversion parts are located in a small bag contained within the large plastic manual envelope attached to the side of the water heater.

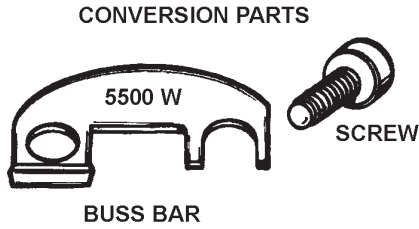

FIGURE 12.

1. Before beginning the conversion turn "OFF" electric power supply to the water heater.

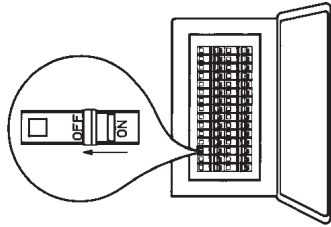

FIGURE 13.

2. The convertible element is located behind the lower access panel of the water heater. Remove the two screws securing the access panel, and remove panel.

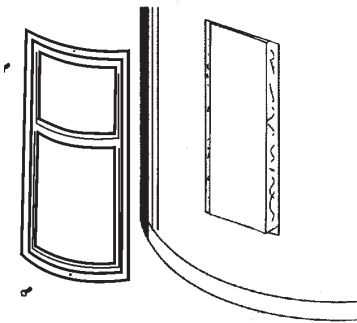

FIGURE 14.

3. Remove the insulation cap with handle to expose the terminal cover.

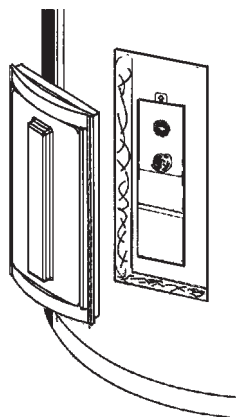

FIGURE 15.

4. Lower Element: Lift out the tab as shown to unclip the terminal cover from the thermostat. The terminal cover can now be removed from the thermostat.

LIFT OUT TAB TO UNCLIP
TERMINAL COVER FROM
THERMOSTAT

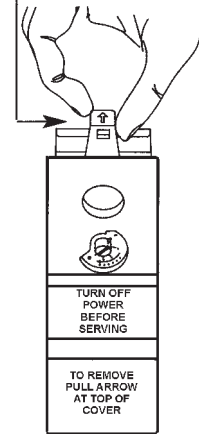

FIGURE 16.

5. Remove the screws from terminal 2 of the element, and move the looped end of the wire aside.

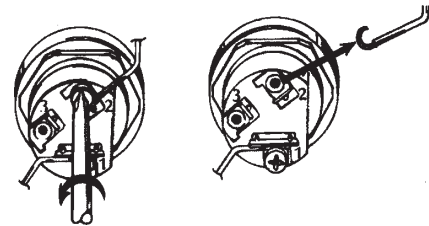

FIGURE 17.

6. The buss bar is labeled 5500 W. Place the buss bar over terminals 2 and 3 with the 5500 W visible. Install the extra screw provided into terminal 3.

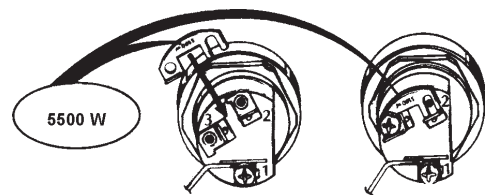

FIGURE 18.

7. The wire removed from terminal 2 has a looped end. It must remain looped and now be placed (as shown) on top of the buss bar, over the opening of terminal 2, and secured using the remaining screw.



FIGURE 19.

8. Tighten terminals 2 and 3 to ensure proper electrical connection.

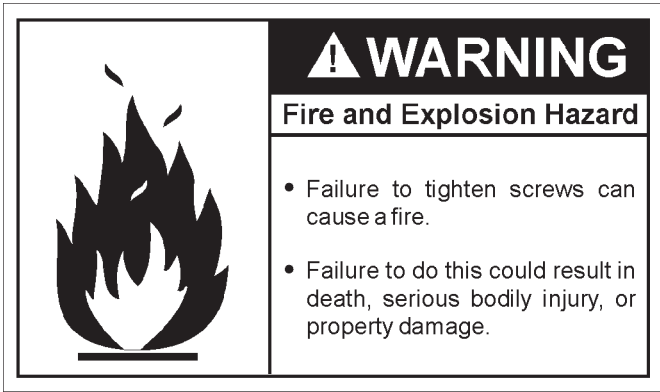

Failure to tighten terminal screws can cause a fire which can result in DEATH, SERIOUS BODILY INJURY, OR PROPERTY DAMAGE.

9. Replace terminal cover on thermostat and fold insulation back over the element making sure that the locking tabs on the terminal cover are in place.



Make sure the thermostat is flush against the tank, the terminal cover is in place, and the insulation is replaced. Failure to do so can result in DEATH, SERIOUS BODILY INJURY, OR PROPERTY DAMAGE.

10. Replace the insulation cap with handle back in place so that it completely covers the thermostat and element.

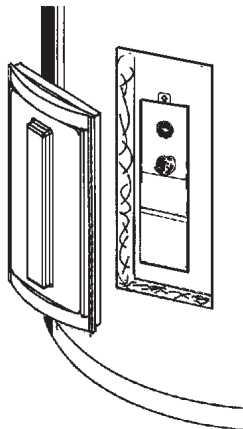

FIGURE 20.

11. Replace the access panel.

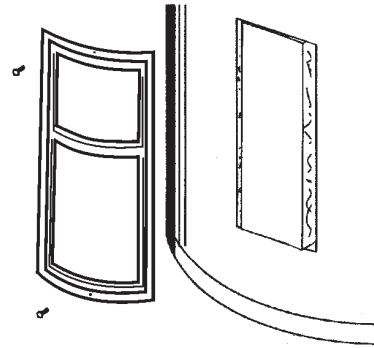

FIGURE 21.

12. Complete wiring to the water heater, or if completed, turn "ON" electric power to the water heater after filling the tank with water.

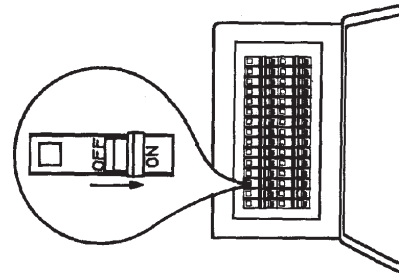

FIGURE 22.



Never use this water heater unless it is completely full of water. To prevent damage to the tank and heating element, the tank must be filled with water. Water must flow from the hot water faucet before turning "ON" power.

Wiring



Never use this water heater unless it is completely full of water. To prevent damage to the tank and heating element, the tank must be filled with water. Water must flow from the hot water faucet before turning on power.

You must provide all wiring of the proper size outside of the water heater. You must obey local codes and electric company requirements when you install this wiring.

If you are not familiar with electric codes and practices, or if you have any doubt, even the slightest doubt, in your ability to connect the wiring to this water heater, obtain the service of a competent electrician. **Call Maytag Customer Service at 1-800-788-8899 for an authorized servicer.**

⚠ WARNING	
Fire Hazard / Electric Shock Hazard	
	<ul style="list-style-type: none"> • Do not use this water heater with any voltage other than shown on the model rating plate. • Failure to use the correct voltage shown on the model rating plate could result in death, serious bodily injury, or property damage.

WATER HEATERS EQUIPPED FOR ONE VOLTAGE ONLY: This water heater is equipped for one type voltage only. Check the rating plate near the bottom access panel for the correct voltage. **DO NOT** use this water heater with any voltage other than the one shown on the model rating plate. Failure to use the correct voltage can cause problems which can result in **DEATH, SERIOUS BODILY INJURY, OR PROPERTY DAMAGE.** If you have any questions or doubts consult your electric company.

If wiring from your fuse box or circuit breaker box was aluminum for your old water heater, replace it with copper wire. If you wish to reuse the existing aluminum wire, have the connection at the water heater made by a competent electrician. **Call Maytag Customer Service at 1-800-788-8899 for an authorized servicer.**

1. Provide a way to easily shut off the electric power when working on the water heater. This could be with a circuit breaker or fuse block in the entrance box or a separate disconnect switch.
2. Install and connect a circuit directly from the main fuse or circuit breaker box. This circuit must be the right size and have its own fuse or circuit breaker. Refer to the chart in the "Product Specifications" section for the correct size wire and fuse or circuit breaker.
3. If metal conduit is used for the grounding conductor:
 - A. The grounding electrode conductor shall be of copper, aluminum, or copperclad aluminum. The material shall be of one continuous length without a splice or joint.
 - B. Rigid metal conduit, intermediate metal conduit, or electrical metallic tubing may be used for the grounding means if conduit or tubing is terminated in fittings approved for grounding.
 - C. Flexible metal conduit or flexible metallic tubing shall be permitted for grounding if all the following conditions are met:

- The length in any ground return path does not exceed 6 feet.
- The circuit conductors contained therein are protected by overcurrent devices rated at 20 amperes or less.
- The conduit or tubing is terminated in fittings approved for grounding.

For complete grounding details and all allowable exceptions, refer to the current edition of the NEC - National Electrical Code NFPA 70.

4. A standard 1/2" conduit opening has been made in the water heater junction box for the conduit connection.
5. Wiring Diagrams, see "Wiring Diagrams" section have been supplied showing the two most common types of connections between the water heater and the power supply. You can easily see which type connection you have by removing the junction box cover on top of the water heater.
 - **Two Wire Connection Diagrams:** is the most common requiring you to simply connect red to red, black to black, and the ground wire to the green ground screw in the junction box of the water heater.
 - **Three Wire Connection Diagram:** is used when you are connecting the water heater to power a supply that has a "Time Clock" or "Off Peak" meter. To make these connections refer to block 1 or 2 in this wiring diagram for the type of system you have.

NOTE: If you have purchased a three wire connection water heater but you are not on a "Time Clock" or "Off Peak" meter and have a standard two wire connection power supply, simply follow the connection diagram in block 3 of the three wire connection diagram.

6. Use wire nuts and connect the power supply wiring to the wires inside the water heater's junction box.
7. The water heater must be electrically "grounded" by the installer. A green ground screw has been provided on the water heater's junction box. Connect ground wire to this location.
8. Replace the wiring junction cover using the screw provided.

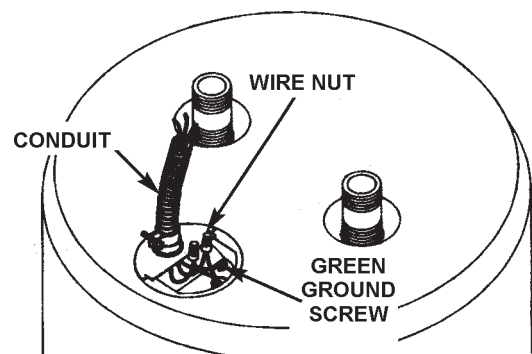



FIGURE 23.

STANDARD WIRING FOR 2 WIRE LEAD WATER HEATERS
NON-SIMULTANEOUS OPERATION 240 VOLT DOUBLE ELEMENT



⚠ WARNING

- Before removing any access panels or servicing the water heater, make sure the electrical supply to the water heater is turned "OFF".
- Failure to do this could result in death, serious bodily injury, or property damage.

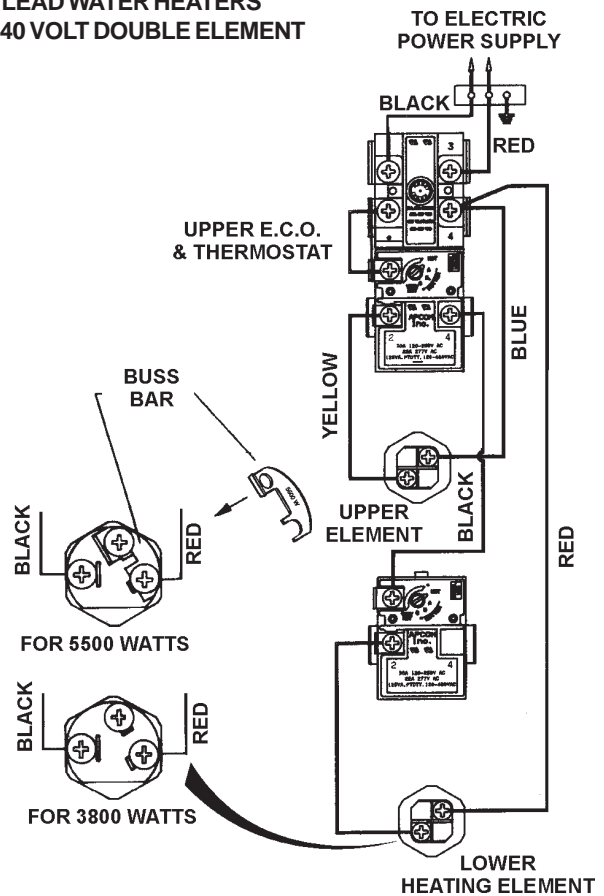

FIGURE 24.

WIRING FOR 3 WIRE LEAD WATER HEATERS NON-SIMULTANEOUS OPERATION 240 VOLT DOUBLE ELEMENT

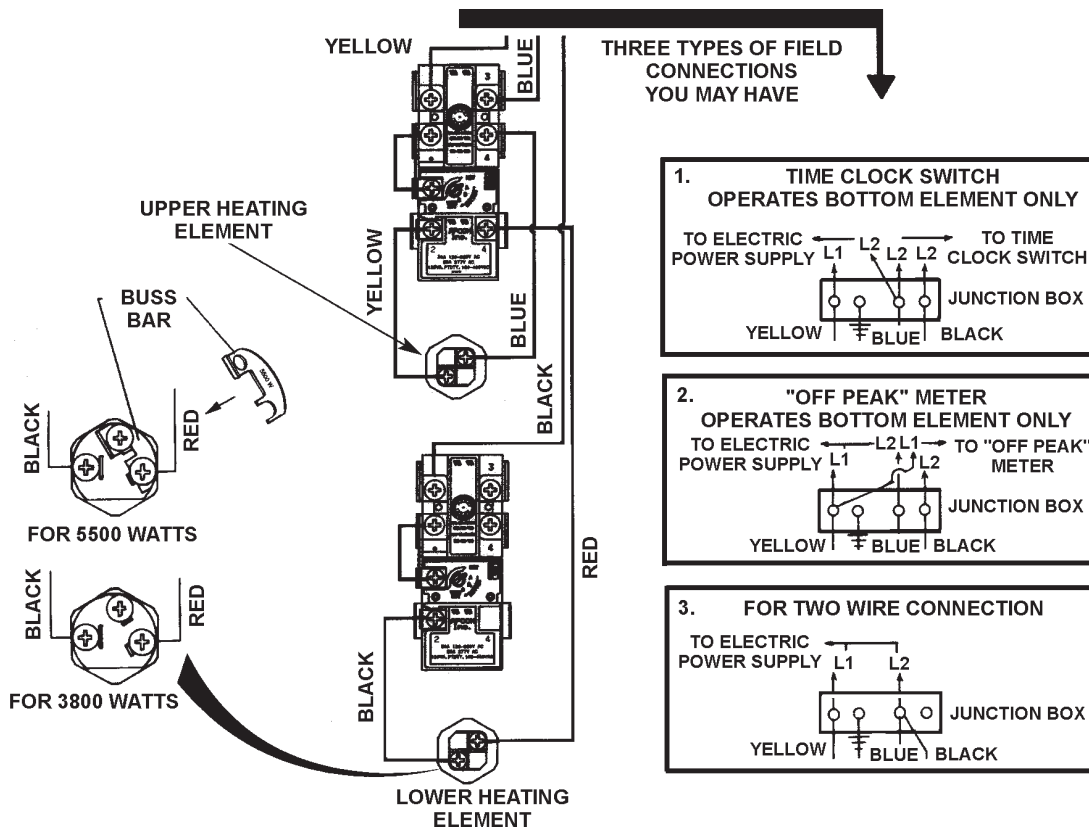
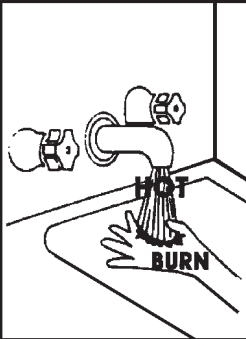

FIGURE 25.

SERVICE AND MAINTENANCE

Temperature Regulation



⚠ DANGER Water temperature over 125°F (52°C) can cause severe burns instantly resulting in severe injury or death.

Children, the elderly, and the physically or mentally disabled are at highest risk for scald injury.

Feel water before bathing or showering.

Temperature limiting valves are available.

Read instruction manual for safe temperature setting.

HOTTER WATER CAN SCALD: Water heaters are intended to produce hot water. Water heated to a temperature which will satisfy clothes washing, dish washing, and other sanitizing needs can scald and permanently injure you upon contact. Some people are more likely to be permanently injured by hot water than others. These include the elderly, children, the infirm, or physically/mentally handicapped. If anyone using hot water in your home fits into one of these groups or if there is a local code or state law requiring a certain temperature water at the hot water tap, then you must take special precautions. In addition to using the lowest possible temperature setting that satisfies your hot water needs, some type of tempering device, such as a mixing valve, should be used at the hot water taps used by these people or at the water heater. Mixing valves are available at plumbing supply or hardware stores. Follow manufacturers instructions for installation of the valves, Before changing the factory setting of the thermostat, read the "Temperature Regulation" section in this manual.

Never allow small children to use a hot water tap, or to draw their own bath water. Never leave a child or handicapped person unattended in a bathtub or shower.

Thermostat

The thermostats of this water heater have been factory set at the "HOT" position which approximates 120°F (49°C). The thermostats are adjustable if a different water temperature is desired. Read all warnings in this manual and on the water heater before proceeding.

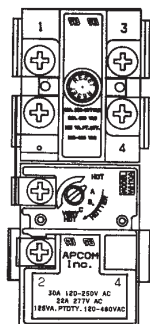

UPPER THERMOSTAT ADJUSTABLE BEHIND UPPER ACCESS PANEL

FIGURE 27.

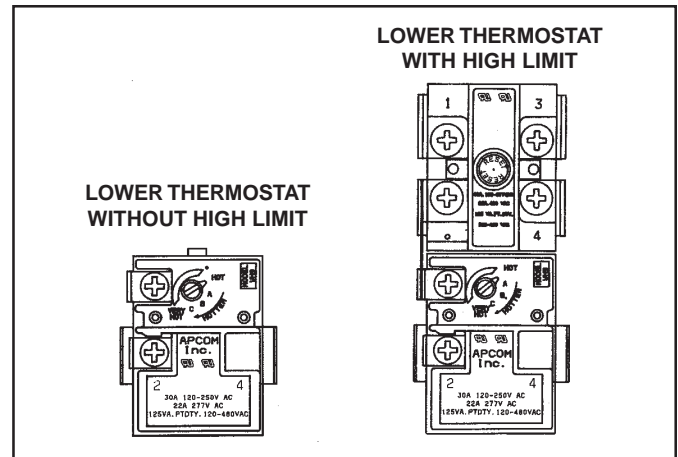

FIGURE 28.

Temperature Settings

- HOT** – Is a thermostat setting of approximately 120°F (49°C), which will supply hot water at the most economical temperatures.
- A** – Is a thermostat setting of approximately 130°F (54°C).
- B** – Is the thermostat setting of approximately 140°F (60°C).
- C** – Is a thermostat setting of approximately 150°F (65°C).
- VERY HOT** – Is a thermostat setting of approximately 160°F (71°C). It is recommended that the dial be set lower whenever possible.

NOTE: Water temperature range of 120°—140°F (49°-60°C) recommended by most dishwasher manufacturers.

Temperature Setting	Time to Produce 2nd & 3rd Degree Burns on Adult Skin
VERY HOT = APPROX. 160°F (71°C)	About 1/2 second
C = APPROX. 150°F (65°C)	About 1-1/2 seconds
B = APPROX. 140°F (60°C)	Less than 5 seconds
A = APPROX. 130°F (54°C)	About 30 seconds
HOT = APPROX. 120°F (49°C)	More than 5 minutes

Thermostat Adjustments



⚠ WARNING

- Before removing any access panels or servicing the water heater, make sure the electrical supply to the water heater is turned "OFF".
- Failure to do this could result in death, serious bodily injury, or property damage.

The upper and lower thermostats have been factory set at HOT approximately 120°F (49°C) to reduce the risk of scald injury.

The upper and lower thermostats are adjustable if a different water temperature is desired. Read all warnings in the "Temperature Regulation" section before proceeding.

NOTE: It is not necessary to adjust the upper thermostat. However, if it is adjusted above the factory set point of 120°F (49°C) HOT it is recommended that it not be set higher than the lower thermostat setting.

To adjust the temperature setting for both upper and lower thermostats, proceed as follows:

1. Turn "OFF" the electric power to the water heater at the junction box.

	⚠ WARNING
	<ul style="list-style-type: none"> • Before removing any access panels or servicing the water heater, make sure the electrical supply to the water heater is turned "OFF". • Failure to do this could result in death, serious bodily injury, or property damage.

2. Take off the access panel, insulation cap with handle.
3. The slotted adjustment (using a screwdriver) can be turned clockwise (↻) to increase the temperature setting or counter clockwise (↻) to decrease the temperature setting.
4. Replace the insulation cap with handle and access panel.
5. Turn "ON" the power supply.

Anode Rod Inspection

CAUTION
Property Damage Hazard
<ul style="list-style-type: none"> • Avoid water heater damage. • Inspection and replacement of anode as needed.

The anode rod is used to protect the tank from corrosion. Most hot water tanks are equipped with an anode rod. The submerged rod sacrifices itself to protect the tank. Instead of corroding the tank, water ions attack and eat away the anode rod. This does not affect the water's taste or color. The rod must be maintained to keep the tank in operating condition.

Anode deterioration depends on the water conductivity, not necessarily water condition. A corroded or pitted anode rod indicates high water conductivity and should be checked and/or replaced more often than an anode rod that appears to be intact. Replacement of a depleted anode rod can extend the life of your water heater. Inspection should be conducted by **calling Maytag Customer Service at 1-800-788-8899 for an authorized servicer.** At a minimum the anode(s) should be checked annually after the warranty period.

Temperature-Pressure Relief Valve Operation

The temperature-pressure relief valve must be manually operated at least once a year.

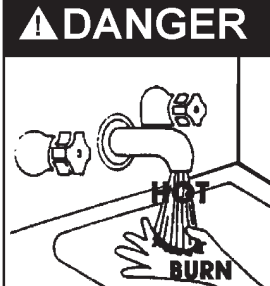
	<ul style="list-style-type: none"> • Burn hazard • Hot water discharge. • Keep clear of relief valve discharge outlet.
--	---

The temperature-pressure relief valve must be manually operated at least once a year. Caution should be taken to ensure that (1) no one is in front of or around the outlet of the temperature-pressure relief valve discharge line, and (2) the water manually discharged will not cause any property damage or bodily injury. The water may be extremely hot.

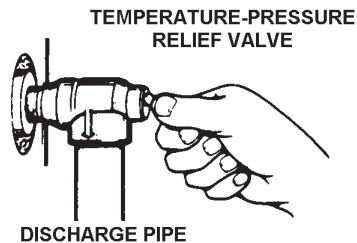

FIGURE 29.

If after manually operating the valve, it fails to completely reset and continues to release water, immediately close the cold water inlet to the water heater, follow the draining instructions, and replace the temperature-pressure relief valve with a new one.

Failure to install and maintain a new properly listed temperature-pressure relief valve will release the manufacturer from any claim which might result from excessive temperature or pressure.

If the temperature-pressure relief valve on the appliance weeps or discharges periodically, this may be due to thermal expansion. Your water heater may have a check valve installed in the water line or a water meter with a check valve. **Call Maytag Customer Service at 1-800-788-8899 for an authorized servicer.** Do not plug the temperature-pressure relief valve.

Draining

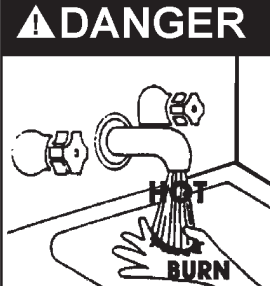
	<ul style="list-style-type: none"> • Burn hazard • Hot water discharge. • Keep hands clear of drain valve discharge.
--	---

The water heater should be drained if being shut down during freezing temperatures. Also, periodic draining and cleaning of sediment from the tank may be necessary.

	<h2>⚠ WARNING</h2>
	<ul style="list-style-type: none"> • Before removing any access panels or servicing the water heater, make sure the electrical supply to the water heater is turned "OFF". • Failure to do this could result in death, serious bodily injury, or property damage.

1. Before beginning turn "OFF" the electric power supply to the water heater.
2. CLOSE the cold water inlet valve to the water heater.
3. OPEN a nearby hot water faucet and leave open to allow for draining.
4. Connect a hose to the drain valve and terminate to an adequate drain or outdoors.
5. OPEN the water heater drain valve to allow for tank draining.

NOTE: If the water heater is going to be shut down and drained for an extended period, the drain valve should be left open with hose connected allowing water to terminate to an adequate drain.

6. Close the drain valve.
7. Follow "Filling the Water Heater" instructions in the "Installation Instructions" section.
8. Turn "ON" power to the water heater.

<h2>CAUTION</h2>
<p>Improper installation and use may result in property damage.</p>
<ul style="list-style-type: none"> • Fill tank with water before operation.

Never use this water heater unless it is completely full of water. To prevent damage to the tank and heating element, the tank must be filled with water. Water must flow from the hot water faucet before turning "ON" power.

Thermostat Removal/Replacement

	<h2>⚠ WARNING</h2>
	<ul style="list-style-type: none"> • Before removing any access panels or servicing the water heater, make sure the electrical supply to the water heater is turned "OFF". • Failure to do this could result in death, serious bodily injury, or property damage.

1. Turn "OFF" the electrical power to the water heater at the junction box.
2. Remove the access panel and the insulation cap with handle.
3. Lift out the tab as shown below to unclip the terminal cover from the thermostat. The terminal cover can now be removed from the thermostat.

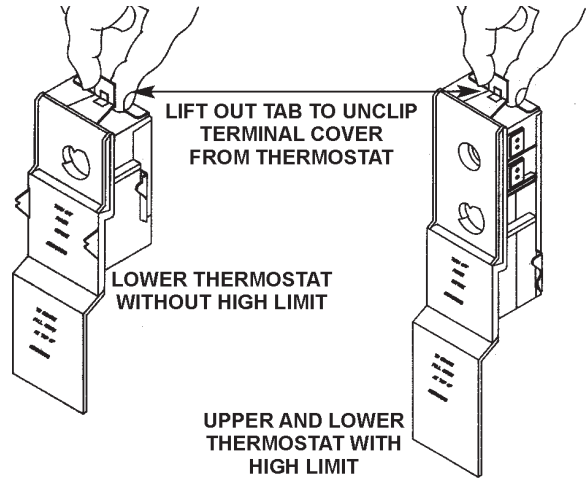



FIGURE 30.

4. Remove the wires attached to the thermostat.
5. Remove the thermostat from behind the thermostat bracket.
6. Disconnect wires from thermostat and slide out of the bracket.
7. Place the new thermostat in the bracket making sure it fits firmly against the tank.
8. Attach the wires to the new thermostat.

NOTE: Some of the terminals may require straight-in wiring through an eye-opening. If wires are now looped, recut and strip wire 3/8" to a straight length and insert.

9. Put plastic terminal cover back in place.
10. Replace the insulation cap with handle to cover the thermostat.
11. Replace access panel, then turn the electric power on.

Element Cleaning/Replacement

	<h2>⚠ WARNING</h2>
	<ul style="list-style-type: none"> • Before removing any access panels or servicing the water heater, make sure the electrical supply to the water heater is turned "OFF". • Failure to do this could result in death, serious bodily injury, or property damage.

NOTE: These instructions are written for element cleaning and element replacement for the lower element. If it is necessary to clean or replace the upper element, then repeat these instructions.

To remove the element from your tank in order to clean or replace it:

1. Before beginning turn "OFF" the electric power supply to the water heater.

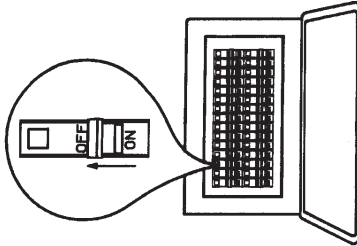

FIGURE 31.

2. Turn off the water supply to the water heater at the water Shut-off valve or water meter.



FIGURE 32.

3. Attach a hose to the water heater drain valve and put the other end in a floor drain or outdoors. Open the water heater drain valve. Open a nearby hot water faucet which will relieve pressure in the water heater and speed draining.

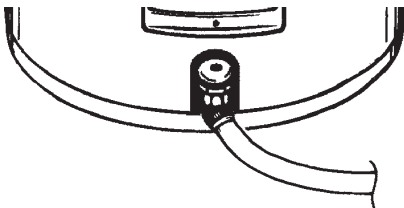

FIGURE 33.

⚠ DANGER	<ul style="list-style-type: none"> • Burn hazard • Hot water discharge. • Keep hands clear of drain valve discharge.

The water passing out of the drain valve may be extremely hot. To avoid being scalded, make sure all connections are tight and that the water flow is directed away from any person.

4. Remove the two screws securing the access panel, and remove panel.

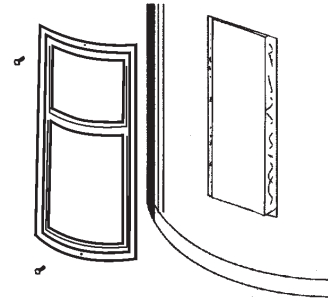

FIGURE 34.

5. Remove the insulation cap with handle to expose the terminal cover.

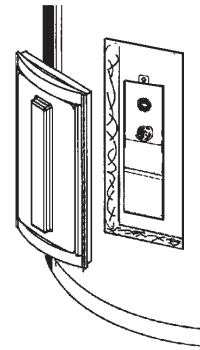

FIGURE 34.

6. Lift out the tab as shown to unclip the terminal cover from the thermostat. The terminal cover can now be removed from the thermostat.

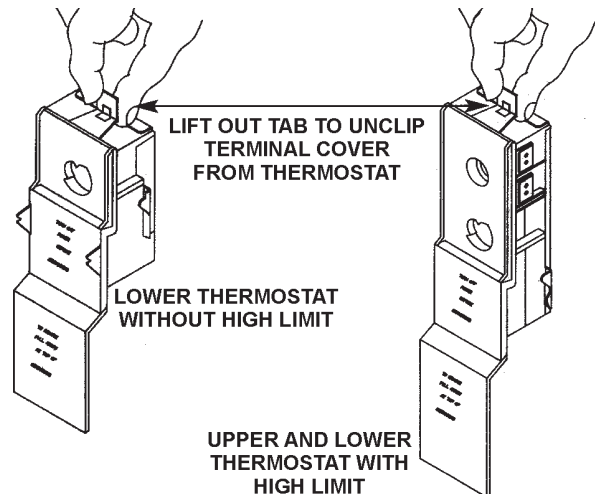

FIGURE 35.

7. Disconnect the two wires on the element and unscrew the old element from the tank.

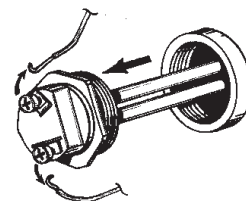



FIGURE 36.

8. Clean the area around the element opening. Remove any sediment from or around the element opening, inside the tank.
9. If you are cleaning the element you have removed, do so by scraping or soaking in vinegar or a de-liming solution.

⚠ WARNING	
	Fire Hazard and Electric Shock Hazard
	<ul style="list-style-type: none"> • Do not use replacement elements with any voltage other than shown on the model rating plate. • Failure to use the correct voltage shown on the model rating plate could result in death, serious bodily injury, or property damage.

Replacement elements must (1) be the same voltage and (2) no greater wattage than listed on the model rating plate affixed to the water heater.

10. A new gasket should be used in all cases to prevent a possible water leak. (See Element Gasket in the "Repair Parts" Chart). Place the new element gasket on the thread side of the cleaned or new element and screw into tank, securing tightly using an element wrench.

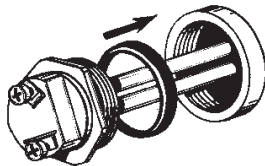

FIGURE 37.

11. Close the water heater drain valve by turning the handle to the right (clockwise). The drain valve is on the lower front of the water heater.
12. Open the cold water supply valve to the water heater.

NOTE: The cold water supply valve must be left open when the water heater is in use.

13. To insure complete filling of the tank, allow air to exit by opening the nearest hot water faucet. Allow water to run until a constant flow is obtained. This will let air out of the water heater and the piping.

CAUTION
Improper installation and use may result in property damage.
<ul style="list-style-type: none"> • Fill tank with water before operation.

Never use this water heater unless it is completely full of water. To prevent damage to the tank and heating element, the tank must be filled with water. Water must flow from the hot water faucet before turning "ON" power.

14. Check element for water leaks. If leakage occurs, tighten element or repeat steps 2 and 3, remove element and reposition gasket. Then repeat steps 10 through 14.
15. Reconnect the two wires to the element and then check to make sure the thermostat remains firmly against the surface of the tank.

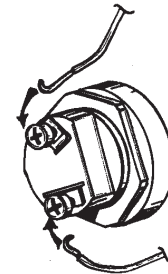

FIGURE 38.

16. Replace terminal cover on thermostat making sure that the locking tabs on the terminal cover are in place.

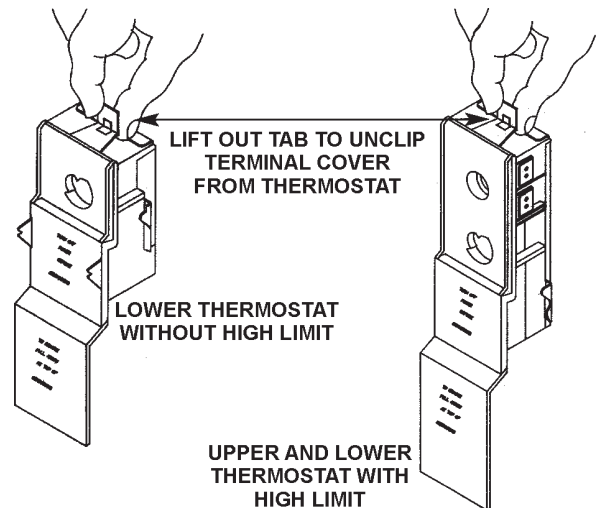

FIGURE 39.

17. Place the insulation cap with handle back in place so that it completely covers the thermostat and element.

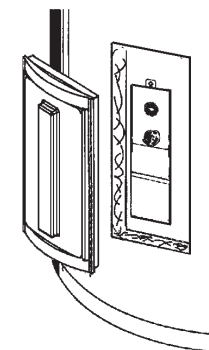

FIGURE 40.

18. Replace access panel.
19. Turn "ON" electric power to water heater.

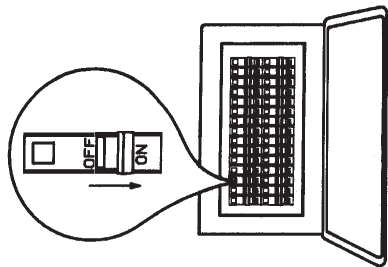

FIGURE 41.

Drain Valve Washer Replacement

	<h3>⚠ WARNING</h3> <ul style="list-style-type: none"> • Before removing any access panels or servicing the water heater, make sure the electrical supply to the water heater is turned "OFF". • Failure to do this could result in death, serious bodily injury, or property damage.
--	--

NOTE: For replacement, use a 17/32" x 13/64" x 1/8" thick washer available at your nearest hardware store. For ordering a replacement washer, refer to the "Parts Order List" section.

- Before beginning turn "OFF" the electrical power supply to the water heater.
- Follow "Draining" instructions in the "Service and Maintenance" section.
- Turning counter clockwise, remove the hex cap below the screw handle.
- Remove the washer and put the new one in place.
- Screw the handle and cap assembly back into the drain valve and retighten using a wrench. **DO NOT OVER TIGHTEN.**
- Follow "Filling the Water Heater" instructions in the "Installation Instructions" section.
- Check for leaks.
- Turn "ON" electric power to the water heater.

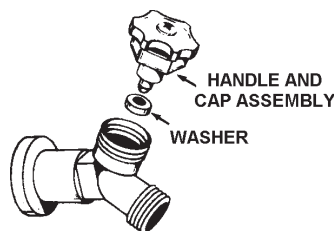

FIGURE 42.

Service

Before calling for repair service, read the "Start Up Conditions" and "Operational Conditions" found in the Troubleshooting section of this manual.

If a condition persists or you are uncertain about the operation of the water heater, let a qualified person check it out.

Call Maytag Customer Service at 1-800-788-8899.

TROUBLESHOOTING

Start Up Conditions

THERMAL EXPANSION

<h2>CAUTION</h2> <h3>Property Damage Hazard</h3> <ul style="list-style-type: none"> • Avoid water heater damage. • Install thermal expansion tank or device if necessary. • Contact qualified installer or service agency.

Water supply systems may, because of such events as high line pressure, frequent cut-offs, the effects of water hammer among others, have installed devices such as pressure reducing valves, check valves, back flow preventers, etc...to control these types of problems. When these devices are not equipped with an internal by-pass, and no other measures are taken, the devices cause the water system to be closed. As water is heated, it expands (thermal expansion) and closed

systems do not allow for the expansion of heated water.

The water within the water heater tank expands as it is heated and increases the pressure of the water system. If the relieving point of the water heater's temperature-pressure relief valve is reached, the valve will relieve the excess pressure. **The temperature-pressure relief valve is not intended for the constant relief of thermal expansion.** This is an unacceptable condition and must be corrected.

It is recommended that any devices installed which could create a closed system have a by-pass and/or the system have an expansion tank to relieve the pressure built by thermal expansion in the water system. Thermal expansion tanks are available for ordering through the Maytag Customer Service. Contact the local water supplier and/or call Maytag Customer Service at 1-800-788-8899 for an authorized servicer for assistance in controlling these situations.

STRANGE SOUNDS

Possible noises due to expansion and contraction of some metal parts during periods of heat-up and cool-down do not represent harmful or dangerous conditions.

Operational Conditions

SMELLY WATER

In each glass-lined water heater there is installed one anode rod (see parts section) for corrosion protection of the tank. Certain water conditions will cause a reaction between this rod and the water. The most common complaint associated with the anode rod is one of a "rotten egg smell". This odor is derived from hydrogen sulfide gas dissolved in the water. The smell is the result of four factors which must all be present for the odor to develop:

- A concentration of sulfate in the supply water.
- Little or no dissolved oxygen in the water.
- A sulfate reducing bacteria within the water heater. (This harmless bacteria is non-toxic to humans.)
- An excess of active hydrogen in the tank. This is caused by corrosion protective action of the anode.

Smelly water may be eliminated or reduced in some water heater models by replacing the anode rod with one of less active material, and then chlorinating the water heater tank and all hot water lines. **Call Maytag Customer Service at 1-800-788-8899 for an authorized servicer for further information concerning an anode replacement kit #66001068 and this chlorination treatment.**

If smelly water persists, after anode replacement and chlorination treatment, we can only suggest that continuous chlorination and filtering conditioning equipment be considered to eliminate the water problem.

Do not remove the anode leaving the tank unprotected. By doing so, all warranty on the water heater tank is voided.

"AIR" IN HOT WATER FAUCETS

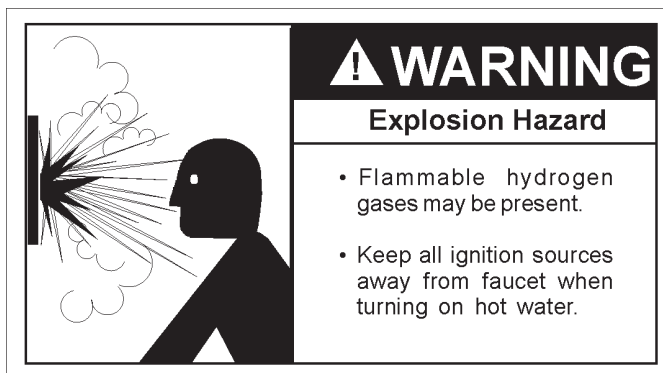

HYDROGEN GAS: Hydrogen gas can be produced in a hot water system that has not been used for a long period of time (generally two weeks or more). Hydrogen gas is extremely flammable and explosive. To prevent the possibility of injury under these conditions, we recommend the hot water faucet be opened for several minutes at the kitchen sink before any electrical appliances which are connected to the hot water system are used (such as a dishwasher or washing machine). If hydrogen gas is present, there will probably be an unusual sound similar to air escaping through the pipe as the hot water faucet is opened. There must be no smoking or open flame near the faucet at the time it is open.

RUMBLING NOISE

In some water areas, scale or mineral deposits will build up on your heating elements. This buildup will cause a rumbling noise. Follow "Element Cleaning/Replacement" instructions to clean and replace the elements.

HIGH TEMPERATURE SHUT OFF SYSTEM

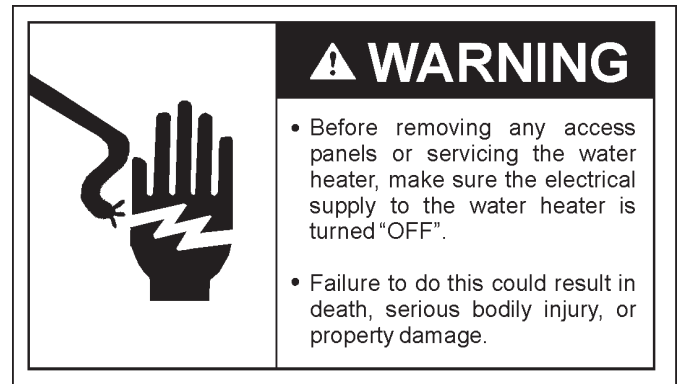

The water heater has a high limit shut off system with a reset button located on the thermostat.

Follow the resetting instructions which refer to the high limit behind the access panel.

NOTE: If your water heater is connected to an "Off Peak" Clock, and uses the "3 wire lead" wiring diagram in the "Wiring Diagram" section, then the water heater will have a high limit on both the upper and lower thermostats. Follow the instructions to reset the high-limit behind the upper and lower access panels.

1. Before beginning, turn "OFF" electrical power supply to the water heater.

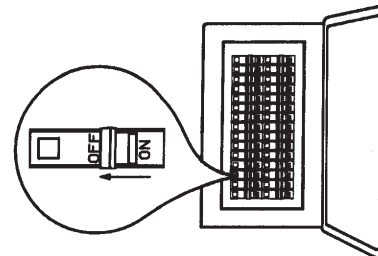

FIGURE 43.

2. Remove the two screws securing the access panel and remove panel.
3. Remove the insulation cap with handle to expose the terminal cover.
4. Reset the high limit by pushing in the red button marked "RESET".

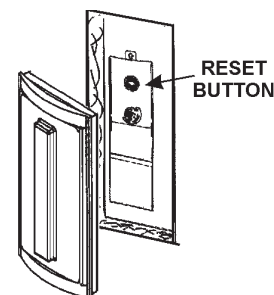

FIGURE 44.

5. Replace the insulation cap with handle so that it completely covers the thermostat and element.
6. Replace the access panel.
7. Turn "ON" electric power to the water heater.

If the high limit must be reset again, **call Maytag customer Service at 1-800-788-8899** for an authorized servicer to find out why the high limit turned "OFF" the electric power.

NOT ENOUGH OR NO HOT WATER



1. In a new installation, the water heater may not be properly connected. Make sure the cold water supply valve is open. Review and check piping installation. Make sure that the cold water line is connected to the cold water inlet to the water heater and the hot water line to the hot water outlet on the water heater.
2. Make sure the electrical supply to your water heater is "ON".
3. Check for loose or blown fuses in your water heater circuit. Circuit breakers weaken with age and may not handle their rated load and should be replaced.
4. Make certain the disconnect switch, if used, is in the "ON" position.

5. Check to see the electric service to your house has not been interrupted. If this is the case, contact the electric company.
6. Is the thermostat set to the desired temperature? See "Temperature Regulation" section.
7. If you had experienced very hot water and now no hot water, the problem may be due to the high temperature shut off system. See "High Temperature Shut Off System" in the "Troubleshooting" section.
8. During very cold weather, the incoming water will also be colder and it will require a longer time to become heated.
9. The hot water usage may exceed the capacity of the water heater. If so, wait for water heater to recover after abnormal demand. Also examine pipes and faucets for possible water leaks.
10. If you can not determine the problem, then call the Maytag Service Department.

WATER IS TOO HOT

Adjust the thermostat to a lower setting. See the "Temperature Regulation" section.

Leakage Checkpoints

	 WARNING
	<p>Read and understand instruction manual and safety messages before installing, operating or servicing this water heater.</p> <p>Failure to follow instructions and safety messages could result in death or serious injury.</p> <p>Instruction manual must remain with water heater.</p>

Read this manual first. Then before checking the water heater make sure the electric supply has been turned "OFF", and never turn the electric supply "on" before the tank is completely full of water.



Use this guide to check a "Leaking" water heater. Many suspected "Leakers" are not leaking tanks. Often the source of the water can be found and corrected.

If you are not thoroughly familiar with electric codes, the water heater, and safety practices, contact your local utility or **call Maytag Customer Service at 1-800-788-8899 for an authorized servicer to check the water heater.**

<h2>CAUTION</h2> <p>Improper installation and use may result in property damage.</p> <ul style="list-style-type: none"> • Fill tank with water before operation.
--

Never use this water heater unless it is completely full of water. To prevent damage to the tank and heating element, the tank must be filled with water. The water must flow from the hot water faucet before turning "ON" power.

- (A) *Condensation may be seen on pipes in humid weather or pipe connections may be leaking.
- (B) *The primary anode rod may be leaking.
- (C) Small amounts of water from the temperature-pressure relief valve may be due to thermal expansion or high water pressure in your area.
- (D) *The temperature-pressure relief valve may be leaking at the tank fitting.
- (E) The element may be leaking at the tank fitting.

	 WARNING
	<ul style="list-style-type: none"> • Before removing any access panels or servicing the water heater, make sure the electrical supply to the water heater is turned "OFF". • Failure to do this could result in death, serious bodily injury, or property damage.

Turn electrical power "OFF", remove access panel and insulation cap with handle. If leaking around element, follow proper draining instructions and remove element. Reposition or replace gasket on element. Place element into opening and tighten securely. Then follow "Filling the Water Heater" instructions in the "Installation Instructions" section.

- (F) Water from drain valve may be due to the valve being opened slightly
- (G) *The drain valve may be leaking at the tank fitting.
- (H) Water in the water heater bottom or on the floor may be from condensation, loose connections or the temperature-pressure relief valve. DO NOT replace the water heater until a full inspection of all possible water sources is made and necessary corrective steps taken.

Leakage from other appliances, water lines, or ground seepage should also be checked.

Note: To check where threaded portion enters tank, insert cotton swab between jacket opening and fitting. If cotton is wet, follow "Draining" instructions in the "Service and Maintenance" section and then remove fitting. Put pipe dope or teflon tape on the threads and replace. Then follow "Filling the Water Heater" instructions in the "Installation Instructions" section.

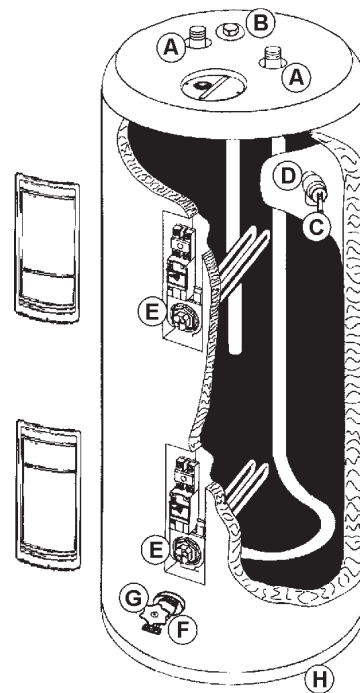

FIGURE 44.

REPAIR PARTS LIST

MAYTAG/STATE PART NUMBER CONVERSION KEY	
MAYTAG	STATE
66001001	9000225
66001002	9000396
66001010	9002403
66001011	9001609
66001012	9001608
66001013	ETC2X
66001014	ETC5X
66001020	9000734
66001021	9001584
66001034	9002445
66001053	9000308
66001054	9000309
66001055	9001591
66001056	9002439
66001054	9000309
66001064	9002438
66001065	9002432
66001066	9002416

MAYTAG/STATE PART NUMBER CONVERSION KEY	
MAYTAG	STATE
66001105	9002769
66001199	900452
66001201	9000507
66001202	9000509
66001251	9001829
66001254	9001954
66001260	9001982
66001269	9002277
66001520	9003473
66001709	9003716
66001738	9003934
66001739	9003935
66001745	9003936
66001747	9004001
66001763	9003485
66001864	184743-001
66001865	9002430

REPAIR PARTS LIST

MAYTAG ELECTRIC WATER HEATERS

MODEL NO'S

HRE11240S	40 Gallon
HRE41240S	40 Gallon
HRE11250S	50 Gallon
HRE41250S	50 Gallon

NOTE:

UPPER ELEMENT: These water heaters are equipped with 3800 watt elements.

LOWER ELEMENT: These water heaters are equipped with factory installed convertible elements, which can be operated at 3800 watts or 5500 watts. Convertible elements are not offered as replacement parts.

If a replacement 3800 watt, 240 volt element is needed, order part no. 66001106 replacement element. If, at the time of installation, the water heater was converted to operate at 5500 watts, order part no. 66001107 replacement element. (See model rating plate" If Converted" box

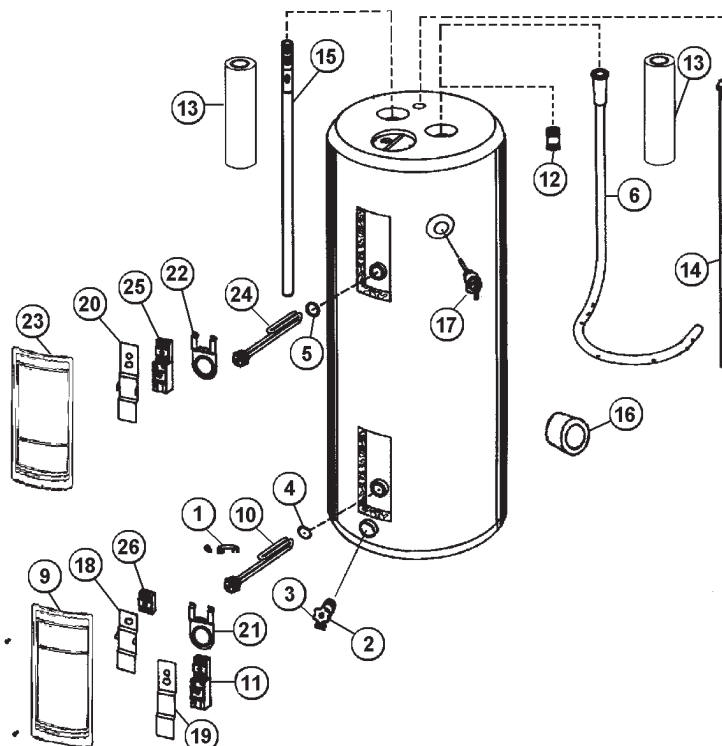

Key No.	Part Description	Model No.			
		HRE11240S	HRE41240S	HRE11250S	HRE41250S
1	Buss Bar Kit	66001055	66001055	66001055	66001055
2	Drain Valve	66001747	66001747	66001747	66001747
3	Drain Valve Washer (17/32" x 13/64" x 1/8" Tick)	66001021	66001021	66001021	66001021
4	Element Gasket	66001053	66001053	66001053	66001053
5	Element Gasket	66001053	66001053	66001053	66001053
6	Inlet Tube	66001520	66001520	66001065	66001065
#7	Inlet Tube Seal	66001269	66001269	66001269	66001269
#8	Instruction Manual	66001864	66001864	66001864	66001864
9	Lower Access Panel	66001199	66001199	66001199	66001199
10	Lower Element	66001002	66001002	66001002	66001002
11	Lower Thermostat w/HiLimit (Three Wire Lead Models)†	-----	66001202	-----	66001202
12	Nipple w/Heat Traps	66001745	66001745	66001745	66001745
13	Pipe Insulation (2 Each)	66001034	66001034	66001034	66001034
14	Primary Anode	66001763	66001763	66001251	66001251
15	Secondary Anode/ Nipple w/Heat traps	66001738	66001738	66001738	66001738
16	T & P Insulation	66001709	66001709	66001709	66001709
17	Temperature-Pressure Relief Valve	66001010	66001010	66001010	66001010
18	Terminal Cover (Lower)	66001056	-----	66001865	-----
19	Terminal Cover (Lower Three Wire)	-----	66001064	-----	66001064
20	Terminal Cover (Upper)	66001064	66001064	66001064	66001064
21	Thermostat Bracket	66001054	66001054	66001054	66001054
22	Thermostat Bracket	66001054	66001054	66001054	66001054
23	Upper Access Panel	66001199	66001199	66001199	66001199
24	Upper Element	66001001	66001001	66001001	66001001
25	Upper Thermostat w/HiLimit	66001254	66001254	66001254	66001254
26	2 Pole Thermostat (Two Wire Lead Models)†	66001201	-----	66001201	-----

* Also available at most hardware stores. † Refer to wiring diagram section for verification. # Not Illustrated.

Now that you have purchased this water heater, should a need ever exist for repair parts or service, simply call **Maytag Customer Service at 1-800-788-8899 for an authorized servicer.** Be sure to provide all pertinent facts when you call or visit.

The model number of the water heater will be found on the model rating plate located above the access panel.

WHEN ORDERING REPAIR PARTS, ALWAYS GIVE THE FOLLOWING INFORMATION:

- Model Number
- Part Number (If available)
- Serial Number
- Voltage and Element Wattage
- Part Description

THIS IS A REPAIR PARTS LIST, NOT A PACKAGING LIST.

REPAIR PARTS LIST

MAYTAG ELECTRIC WATER HEATERS

MODEL NO'S

HRE11250T	50 Gallon
HRE41250T	50 Gallon
HRE11282T	80 Gallon
HRE41282T	80 Gallon

NOTE:

UPPER ELEMENT: These water heaters are equipped with 3800 watt elements.

LOWER ELEMENT: These water heaters are equipped with factory installed convertible elements, which can be operated at 3800 watts or 5500 watts. Convertible elements are not offered as replacement parts.

If a replacement 3800 watt, 240 volt element is needed, order part no. 66001106 replacement element. If, at the time of installation, the water heater was converted to operate at 5500 watts, order part no. 66001107 replacement element. (See model rating plate "If Converted" box

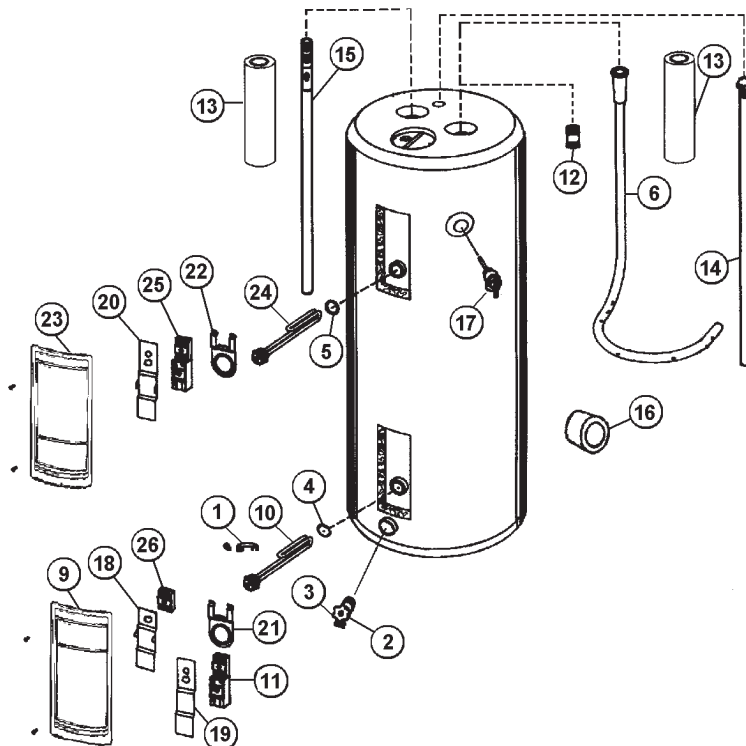

Key No.	Part Description	Model No.			
		HRE11250T	HRE41250T	HRE11282T	HRE41282T
1	Buss Bar Kit	66001055	66001055	66001055	66001055
2	Drain Valve	66001747	66001747	66001747	66001747
3	Drain Valve Washer (17/32" x 13/64" x 1/8" Tick)	66001021	66001021	66001021	66001021
4	Element Gasket	66001053	66001053	66001053	66001053
5	Element Gasket	66001053	66001053	66001053	66001053
6	Inlet Tube	66001260	66001260	66001066	66001066
#7	Inlet Tube Seal	66001269	66001269	66001269	66001269
#8	Instruction Manual	66001864	66001864	66001864	66001864
9	Lower Access Panel	66001199	66001199	66001199	66001199
10	Lower Element	66001002	66001002	66001002	66001002
11	Lower Thermostat w/HiLimit (Three Wire Lead Models)†	-----	66001202	-----	66001202
12	Nipple w/Heat Traps	66001745	66001745	66001745	66001745
13	Pipe Insulation (2 Each)	66001034	66001034	66001034	66001034
14	Primary Anode	66001251	66001251	66001020	66001020
15	Secondary Anode/ Nipple w/Heat traps	66001739	66001739	66001739	66001739
16	T & P Insulation	66001709	66001709	66001709	66001709
17	Temperature-Pressure Relief Valve	66001010	66001010	66001010	66001010
18	Terminal Cover (Lower)	66001056	-----	66001865	-----
19	Terminal Cover (Lower Three Wire)	-----	66001064	-----	66001064
20	Terminal Cover (Upper)	66001064	66001064	66001064	66001064
21	Thermostat Bracket	66001054	66001054	66001054	66001054
22	Thermostat Bracket	66001054	66001054	66001054	66001054
23	Upper Access Panel	66001199	66001199	66001199	66001199
24	Upper Element	66001001	66001001	66001001	66001001
25	Upper Thermostat w/HiLimit	66001254	66001254	66001254	66001254
26	2 Pole Thermostat (Two Wire Lead Models)†	66001201	-----	66001201	-----

* Also available at most hardware stores. † Refer to wiring diagram section for verification. # Not Illustrated.

Now that you have purchased this water heater, should a need ever exist for repair parts or service, simply call **Maytag Customer Service at 1-800-788-8899 for an authorized servicer.** Be sure to provide all pertinent facts when you call or visit.

The model number of the water heater will be found on the model rating plate located above the access panel.

WHEN ORDERING REPAIR PARTS, ALWAYS GIVE THE FOLLOWING INFORMATION:

- Model Number
- Serial Number
- Part Description
- Part Number (If available)
- Voltage and Element Wattage

THIS IS A REPAIR PARTS LIST, NOT A PACKAGING LIST.

FULL ONE YEAR WARRANTY

For one year from date of original retail purchase, any part which fails in normal home use will be repaired or replaced free of charge.

If a leak occurs in the tank, a new water heater of the closest capacity and quality then available, will be replaced free of charge.

The warranty of the replacement is the balance of the original water heater's warranty.

LIMITED PARTS WARRANTY

After the first year and through the twelfth year from the date of original retail purchase, any parts which fail due to a defect in material or workmanship, will be replaced or repaired free of charge for the part itself, with the owner paying all other costs, including labor, mileage and transportation.

If the water heater is subjected to commercial, institutional, industrial or non-residential use, the above warranty coverage for parts that are proved to be defective in material or workmanship is effective for one year from the date of the original retail purchase.

The warranty of the replacement is the balance of the original water heater's warranty, or twelve months from the date of the part(s) purchase, whichever comes first.

The warranty is limited to the original owner of the water heater.

LIMITED TANK WARRANTY AGAINST LEAKS

After the first year and through the twelfth year from the date of original retail purchase, if a leak occurs in the tank, a new water heater of the closest capacity and quality then available, will be replaced free of charge for the water heater, with the owner paying all other costs, including labor, mileage and transportation.

If the water heater is subjected to commercial, institutional, industrial or non-residential use, the above warranty coverage for the tanks that are proven to be defective in material and workmanship is effective for two years from the date of the original retail purchase.

The warranty of the replacement is the balance of the original water heater's warranty.

Please note: The full and limited warranty applies only while this water heater is used in the United States of America.

The warranty is limited to the original owner of the water heater.

TO RECEIVE WARRANTY SERVICE

To locate an authorized service company in your area contact the Maytag dealer from whom your appliance was purchased; or call Maytag Customer Service at the number listed below. Should you not receive satisfactory warranty service, please call or write:

Maytag Customer Service
P.O. Box 2370
Cleveland, TN 37320-2370
Canada: 1-800-788-8899

When contacting Maytag Customer Service be sure to provide the model and serial number of your appliance, the name and address of the dealer from whom you purchased the appliance and the date of purchase.

MAYTAG WATER HEATERS ARE MANUFACTURED AND THIS WARRANTY IS PROVIDED BY A.O. SMITH CORPORATION. MAYTAG® IS A TRADEMARK OF MAYTAG CORPORATION AND IS USED UNDER LICENSE TO A.O. SMITH CORPORATION.

Free Manuals Download Website

<http://myh66.com>

<http://usermanuals.us>

<http://www.somanuals.com>

<http://www.4manuals.cc>

<http://www.manual-lib.com>

<http://www.404manual.com>

<http://www.luxmanual.com>

<http://aubethermostatmanual.com>

Golf course search by state

<http://golfingnear.com>

Email search by domain

<http://emailbydomain.com>

Auto manuals search

<http://auto.somanuals.com>

TV manuals search

<http://tv.somanuals.com>