



# Series Six

# ELECTRIC WATER HEATER USER'S GUIDE



### Model Numbers

HR630SJRT	HR630DJRT
HR630SJLS	HR630DJLS
HR640SJRT	HR640DJRT
HR640SJRS	HR640DJRS
HR640SJLS	HR640DJLS
HR652SJRT	HR652DJRT
HR650SJRS	HR650DJRS
HR650SJLS	HR650DJLS
HR666SJRT	HR666DJRT
HR682SJRT	HR682DJRT
HR6120SJRT	HR6120DJRT



GAMA certification applies to all residential electric water heaters with capacities of 20 to 120 Gallons. Input rating of 12 Kw or less at a voltage no greater than 250 V.

**FOR POTABLE WATER  
HEATING ONLY**

**NOT SUITABLE FOR  
SPACE HEATING**

**Caution:  
Read and Follow All  
Safety Rules and  
Operating Instructions  
Before First Use of  
This Product.**

**⚠ WARNING**  
**READ THE GENERAL SAFETY SECTION BEGINNING ON INSIDE  
COVER AND THEN THIS ENTIRE MANUAL BEFORE  
INSTALLING OR OPERATING THIS WATER HEATER.**

*Save this Manual for Future Reference.*

# Safety Instructions

## ⚠ WARNING

Improper installation, adjustment, alteration, service or maintenance can cause **DEATH, SERIOUS BODILY INJURY, OR PROPERTY DAMAGE**. Refer to this manual for assistance consult your local utility or call Maytag Customer Service at 1-800-788-8899 for an authorized servicer for further information.

## ⚠ WARNING

**HAZARD OF ELECTRICAL SHOCK!** Before removing any access panels or servicing the water heater, make sure the electrical supply to the water heater is turned "OFF". Failure to do this could result in **DEATH, SERIOUS BODILY INJURY, OR PROPERTY DAMAGE**.

## ⚠ WARNING

**HOTTER WATER CAN SCALD:** Water heaters are intended to produce hot water. Water heated to a temperature which will satisfy clothes washing, dish washing, and other sanitizing needs can scald and permanently injure you upon contact. Some people are more likely to be permanently injured by hot water than others. These include the elderly, children, the infirm, or physically/mentally handicapped. If anyone using hot water in your home fits into one of these groups or if there is a local code or state law requiring a certain temperature water at the hot water tap, then you must take special precautions. In addition to using the lowest possible temperature setting that satisfies your hot water needs, a means such as a mixing valve, should be used at the hot water taps used by these people or at the water heater. Mixing valves are available at plumbing supply or hardware stores. Follow manufacturers instructions for installation of the valves. Before changing the factory setting on the thermostat, read the "Temperature Regulation" section in this manual.

## ⚠ WARNING

**INSULATING JACKETS:** When installing an external water heater insulation jacket on an electric water heater:

- **DO NOT** cover the temperature-pressure relief valve.
- **DO NOT** put insulation over the access covers or any access areas.
- **DO NOT** remove operating instructions, and safety related warning labels and materials affixed to the water heater.
- **DO** obtain new warning and instruction labels from Maytag for placement on the jacket directly over the existing labels.

## ⚠ WARNING

Do not use this appliance if any part of it has been under water. An electrical short or malfunction could occur. The water heater should be replaced.

## ⚠ WARNING

At the time of manufacture this water heater was provided with a combination temperature-pressures relief valve certified by a nationally recognized testing laboratory that maintains periodic inspection of production of listed equipment or materials, as meeting the requirements for Relief Valves and Automatic Gas Shutoff Devices for Hot Water Supply Systems, and the current edition of ANSI Z21.22 • CSA 4.4 and the code requirements of ASME. If replaced, the valve must meet the requirements of local codes, but not less than a combination temperature and pressure relief valve certified as meeting the requirements for Relief Valves and Automatic Gas Shutoff Devices for Hot Water Supply Systems, ANSI Z21.22 • CSA 4.4 by a nationally recognized testing laboratory that maintains periodic inspection of production of listed equipment or materials.

The valve must be marked with a maximum set pressure not to exceed the marked hydrostatic working pressure of the water heater (150 lbs./sq. in.) and a discharge capacity not less than the water heater input rate as shown on the model rating plate. (Electric heaters - watts divided by 1000 x 3412 equal BTU/Hr. rate.)

Your local jurisdictional authority, while mandating the use of a temperature-pressure relief valve complying with ANSI Z21.22 • CSA 4.4 and ASME, may require a valve model different from the one furnished with the water heater.

Compliance with such local requirements must be satisfied by the installer or end user of the water heater with a locally prescribed temperature-pressure relief valve installed in the designated opening in the water heater in place of the factory furnished valve. For safe operation of the water heater, the relief valve must not be removed from it's designated opening or plugged.

The temperature-pressure relief valve must be installed directly into the fitting of the water heater designated for the relief valve. Position the valve downward and provide tubing so that any discharge will exit only within 6 inches above, or at any distance below the structural floor. Be certain that no contact is made with any live electrical part. The discharge opening must not be blocked or reduced in size under any circumstances. Excessive length, over 30 feet, or use of more than four elbows can cause restriction and reduce the discharge capacity of the valve.

No valve or other obstruction is to be placed between the relief valve and the tank. Do not connect tubing directly to discharge drain unless a 6" air gap is provided. To prevent bodily injury, hazard to life, or property damage, the relief valve must be allowed to discharge water in quantities should circumstances demand. If the discharge pipe is not connected to a drain or other suitable means, the water flow may cause property damage.

**The Discharge Pipe:**

- **Must not** be smaller in size than the outlet pipe size of the valve, or have any reducing couplings or other restrictions.
- **Must not** be plugged or blocked.
- **Must be** of material listed for hot water distribution.
- **Must be** installed so as to allow complete drainage of both the temperature-pressure relief valve, and the discharge pipe.
- **Must terminate** at an adequate drain.
- **Must not** have any valve between the relief valve and tank.

# Safety Instructions (cont'd)

## **▲WARNING**

**WATER HEATERS EQUIPPED FOR ONE VOLTAGE ONLY:** This water heater is equipped for one type voltage only. Check the rating plate near the bottom access panel for the correct voltage. **DO NOT** use this water heater with any voltage other than the one shown on the model rating plate. Failure to use the correct voltage can cause problems which can result in **DEATH, SERIOUS BODILY INJURY, OR PROPERTY DAMAGE**. If you have any questions or doubts consult your electric company.

## **▲WARNING**

**HYDROGEN GAS:** Hydrogen gas can be produced in a hot water system that has not been used for a long period of time (generally two weeks or more). Hydrogen gas is extremely flammable and explosive. To prevent the possibility of injury under these conditions, we recommend the hot water faucet be opened for several minutes at the kitchen sink before any electrical appliances which are connected to the hot water system are used (such as a dishwasher or washing machine). If hydrogen gas is present, there will probably be an unusual sound similar to air escaping through the pipe as the hot water faucet is opened. There must be no smoking or open flame near the faucet at the time it is open.

## **▲CAUTION**

**WATER HEATERS EVENTUALLY LEAK:** Installation of the water heater must be accomplished in such a manner that if the tank or any connections should leak, the flow of water will not cause damage to the structure. For this reason, it is not advisable to install the water heater in an attic or upper floor. When such locations cannot be avoided, a suitable drain pan should be installed under the water heater. Drain pans are available at your local hardware store. Such a drain pan must have a minimum diameter of at least 1<sup>3</sup>/<sub>4</sub> inches greater than the water heater diameter and must be piped to an adequate drain.

## **▲CAUTION**

Never use this water heater unless it is completely full of water. To prevent damage to the tank and heating element, the tank must be filled with water. Water must flow from the hot water faucet before turning "ON" power.

# Table of Contents

Safety Instructions.....	2,3
Table of Contents.....	4
Customer Information.....	5
Product Specifications.....	5-7
Accessories and Tools Needed.....	8
Accessories.....	8
Tools.....	8
Instructions for Installation.....	9-15
Removing the Old Water Heater.....	9
Locating the New Water Heater.....	10
Typical Installation.....	10
Water Piping.....	11
T&P Valve and Pipe Insulation.....	11
Temperature-Pressure Relief Valve.....	12
Filling the Water Heater.....	13
Wiring Diagrams.....	13
Wiring.....	14
Installation Checklist.....	15
Service and Maintenance.....	16-21
Temperature Regulation.....	16
Thermostats.....	16
Temperature Settings.....	16
Thermostat Adjustments.....	17
Anode Rod Inspection.....	17
Temperature-Pressure Relief Valve Operation.....	17
Draining.....	18
Thermostat Removal/Replacement.....	18,19
Element Cleaning and Replacement.....	19-21
Drain Valve Washer Replacement.....	21
Service.....	21
Troubleshooting.....	22-24
Start Up Conditions.....	22
Thermal Expansion.....	22
Strange Sounds.....	22
Operational Conditions.....	22,23
Smelly Water.....	22
Air in Hot Water Faucets.....	22
Rumbling Noise.....	22
High Temperature Shut Off System.....	22,23
Not Enough Hot Water.....	23
Water is Too Hot.....	23
Leakage Checkpoints.....	24
Repair Parts List.....	26-34
Warranty.....	36

# Customer Information

**Thank You** for purchasing a Maytag water heater. Properly installed and maintained, it should give you years of trouble free service. It is strongly suggested that this new water heater be professionally installed, call Maytag Customer Service at 1-800-788-8899 for recommended installers.

## Abbreviations Found In This Instruction Manual

U.L. - Underwriters Laboratories Inc.

NEC - National Electrical Code

ANSI - American National Standards Institute

- Read the "Safety Instructions" section, pages 2 and 3 of this manual first and then the entire manual carefully. If you don't follow the safety rules, the water heater will not operate properly. It could cause DEATH, SERIOUS BODILY INJURY AND/OR PROPERTY DAMAGE. This manual contains instructions for the installation, operation, and maintenance of this electric water heater. It also contains warnings throughout the manual that you must read and be aware of. All warnings and all instructions are essential to the proper operation of the water heater and your safety. Since we cannot put everything on the first few pages, READ THIS ENTIRE MANUAL BEFORE ATTEMPTING TO INSTALL OR OPERATE THE WATER HEATER.
- The installation must conform with the instructions in this manual; electric company rules; and Local Codes, or in

the absence of Local Codes, with the current edition of the NEC - National Electrical Code NFPA 70. This publication is available from your local government or public library or electric company or by writing Underwriters Laboratories Inc., 333 Pfingsten Road, Northbrook, IL 60062.

- If after reading this manual you have any questions or do not understand any portion of the instructions, call Maytag Customer Service at 1-800-788-8899 for an authorized servicer.
- Carefully plan the place where you are going to put the water heater. Correct electrical wiring and connections are very important in preventing death from possible electrical shock and fires. Examine the location to ensure the water heater complies with the "Locating the New Water Heater" section.
- For California installation this water heater must be braced, anchored, or strapped to avoid falling or moving during an earthquake. See instructions for correct installation procedures. Instructions may be obtained from the California office of the State Architect, 400 P Street, Sacramento, CA 95814.
- Massachusetts Code requires this water heater to be installed in accordance with Massachusetts 248-CMR 2.00: State Plumbing Code and 248-CMR 5.00.

# Product Specifications

Model	HR630SJRT	HR630DJRT	HR630SJLS	HR630DJLS	HR640SJRT	
<b>Tank Capacity In Gal.</b>	30	30	30	30	40	
<b>*Element Wattage at 240 Volt</b>	<b>Upper</b>	—	4500	—	4500	—
	<b>Lower</b>	4500	4500	4500	4500	4500
<b>Recovery Rate In Gals Per Hr. @ 90°F Rise</b>	<b>Upper</b>	—	20	—	20	—
	<b>Lower</b>	20	20	20	20	20
<b>Diameter</b>	18"	18"	22"	22"	18"	
<b>Height</b>	46 1/2"	46 1/2"	30"	30"	59 1/2"	
<b>Maximum Fuse or Circuit Breaker Size</b>	30	30	30	30	30	
<b>Minimum Wire Size (Gauge)</b>	10	10	10	10	10	

\*Standard element wattages are shown. Other element wattages (up to the maximum shown) are available when specified.

\*Wiring size based on standard 60°C copper wire. If distance from fuse box to water heater is more than 90 feet, refer to your local electrical code.

# Product Specifications

Model	HR640DJRT	HR640SJRS	HR640DJRS	HR640SJLS	HR640DJLS
Tank Capacity In Gal.	40	40	40	40	40
*Element Wattage at 240 Volt	Upper	—	4500	—	4500
	Lower	4500	4500	4500	4500
Recovery Rate In Gals. Per Hr. @ 90°F Rise	Upper	—	20	—	20
	Lower	20	20	20	20
Diameter	18"	20 1/2"	20 1/2"	25"	25"
Height	59 1/2"	44"	44"	32 1/4"	32 1/4"
Maximum Fuse or Circuit Breaker Size	30	30	30	30	30
Minimum Wire Size (Gauge)	10	10	10	10	10

Model	HR652SJRT	HR652DJRT	HR650SJRS	HR650DJRS	HR650SJLS
Tank Capacity In Gal.	50	50	50	50	50
*Element Wattage at 240 Volt	Upper	—	4500	—	4500
	Lower	4500	4500	4500	4500
Recovery Rate In Gals. Per Hr. @ 90°F Rise	Upper	—	20	—	20
	Lower	20	20	20	20
Diameter	20 1/2"	20 1/2"	22"	22"	26 1/2"
Height	54"	54"	48"	48"	34"
Maximum Fuse or Circuit Breaker Size	30	30	30	30	30
Minimum Wire Size (Gauge)	10	10	10	10	10

Model	HR650DJLS	HR666SJRT	HR666DJRT	HR682SJRT	HR682DJRT
Tank Capacity In Gal.	50	66	66	80	80
*Element Wattage at 240 Volt	Upper	—	4500	—	4500
	Lower	4500	4500	4500	4500
Recovery Rate In Gals. Per Hr. @ 90°F Rise	Upper	—	20	—	20
	Lower	20	20	20	20
Diameter	26 1/2"	22"	22"	24"	24"
Height	34"	60 1/4"	60 1/4"	60 1/2"	60 1/2"
Maximum Fuse or Circuit Breaker Size	30	30	30	30	30
Minimum Wire Size (Gauge)	10	10	10	10	10

\*Standard element wattages are shown. Other element wattages (up to the maximum shown) are available when specified.

\*Wiring size based on standard 60°C copper wire. If distance from fuse box to water heater is more than 90 feet, refer to your local electrical code.

# Product Specifications

Model	HR6120SJRT	HR6120DJRT
<b>Tank Capacity In Gal.</b>	119	119
<b>*Element Wattage at 240 Volt</b>	<b>Upper</b>	—
	<b>Lower</b>	4500
<b>Recovery Rate In Gals. Per Hr. @ 90°F Rise</b>	<b>Upper</b>	—
	<b>Lower</b>	20
<b>Diameter</b>	28"	28"
<b>Height</b>	64 1/4"	64 1/4"
<b>Maximum Fuse or Circuit Breaker Size</b>	30	30
<b>Minimum Wire Size (Gauge)</b>	10	10

\*Standard element wattages are shown. Other element wattages (up to the maximum shown) are available when specified.

\*Wiring size based on standard 60°C copper wire. If distance from fuse box to water heater is more than 90 feet, refer to your local electrical code.

# Accessories and Tools Needed

## Accessories

To simplify the installation Maytag has available the installation parts shown below. You may or may not need all of these accessories depending on your type of installation. Call Maytag Customer Service at 1-800-788-8899 for an authorized installer.

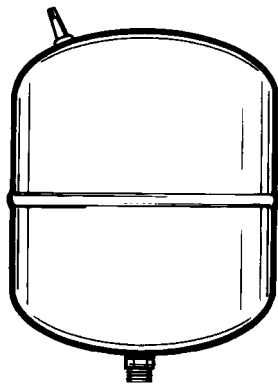

EXPANSION TANKS FOR THERMAL EXPANSION CONDITIONS AVAILABLE IN 2 GALLON (PART NUMBER 66001013) AND 5 GALLON (PART NUMBER 66001014) CAPACITY

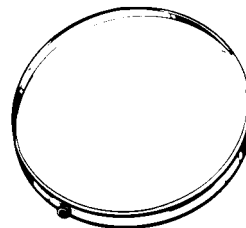

DRAIN PANS AVAILABLE IN 22" DIAMETER (PART NUMBER 66001011) FOR WATER HEATERS HAVING A DIAMETER 20" OR LESS, 24" DIAMETER (PART NUMBER 66001105) FOR WATER HEATERS HAVING A DIAMETER 22" OR LESS AND AVAILABLE IN 28" DIAMETER (PART NUMBER 66001012) FOR WATER HEATERS HAVING A DIAMETER 26.25" OR LESS

## Tools

You may or may not need all of these tools, depending on your type of installation. These tools can be purchased at your local Maytag store.

- Pipe Wrenches (2) 14"
- Screwdriver
- 6 Foot Tape or Folding Rule
- Garden Hose
- Drill
- Pipe dope or Teflon Tape



GARDEN HOSE



6 FOOT TAPE



PIPE WRENCH

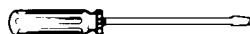

SLOT-HEAD SCREW DRIVER

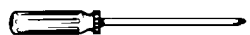

PHILLIPS SCREWDRIVER



PIPE DOPE (SQUEEZE TUBE)



ROLL OF TEFLON TAPE  
(Use only on water connections)

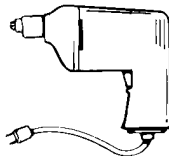

DRILL

## ADDITIONAL TOOLS NEEDED WHEN SWEAT SOLDERING

- Tubing Cutters or Hacksaw
- Propane Torch
- Soft Solder
- Solder Flux
- Emery Cloth
- Wire Brushes

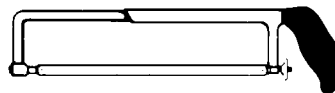

HACKSAW



3/4" WIRE BRUSH



1/2" WIRE BRUSH



ROLL OF LEAD FREE SOFT SOLDER



ROLL OF EMERY CLOTH



SOLDER FLUX



PROPANE TORCH



TUBING CUTTER



# Installation Instructions

## Removing the Old Water Heater

- ① Turn "OFF" electrical supply to the water heater.

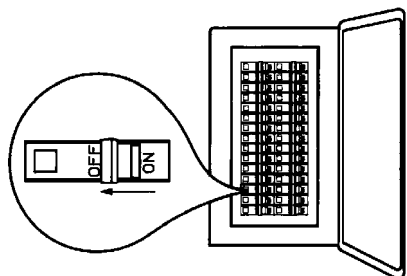

- ② Turn "OFF" the water supply to the water heater at the water shutoff valve or water meter.

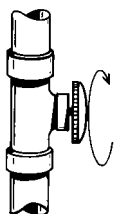

- ③ Attach a hose to the water heater drain valve and put the other end in a floor drain or outdoors. Open the water heater drain valve. Open a nearby hot water faucet which will relieve pressure in the water heater and speed draining.

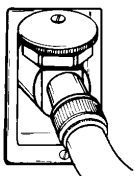

### ⚠ WARNING

The water passing out of the drain valve may be extremely hot. To avoid being scalded, make sure all connections are tight and that the water flow is directed away from any person.

- ④ Check again to make sure the electrical supply is turned "OFF" to the water heater. Then disconnect the electrical supply connection from the water heater junction box.

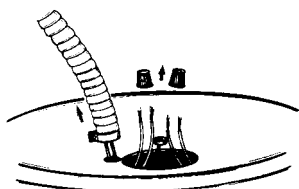

- ⑤ a. If you have copper piping to the water heater, the two copper water pipes can be cut with a hacksaw approximately four inches away from where they connect to the water heater. This will avoid cutting off the pipes too short. Additional cuts can be made later if necessary. Disconnect the temperature-pressure relief valve drain line. When the water heater is drained, disconnect the hose from the drain valve. Close the drain valve. The water heater is now completely disconnected and ready to be removed.

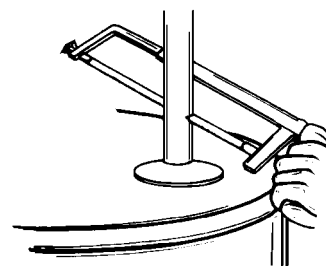
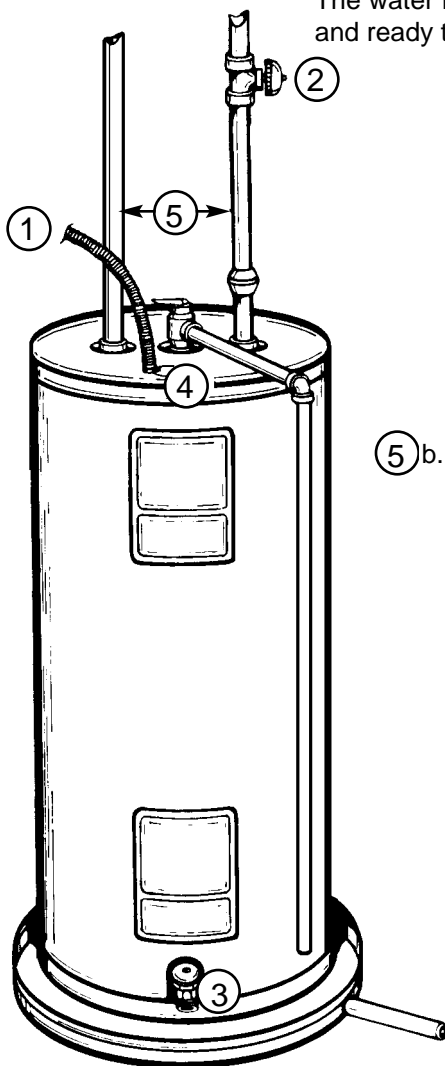

- ⑤ b. If you have galvanized pipe to the water heater, loosen the two galvanized pipes with a pipe wrench at the union in each line. Also disconnect the piping remaining to the water heater. These pieces should be saved since they may be needed when reconnecting the new water heater. Disconnect the temperature-pressure relief valve discharge pipe. When the water heater is drained, disconnect the hose from the drain valve. Close the drain valve. The water heater is now completely disconnected and ready to be removed.

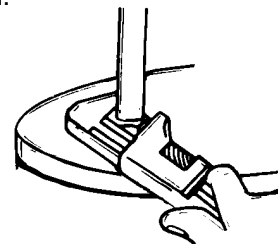

### ⚠ CAUTION

Mineral buildup or sediment may have accumulated in the old water heater. This causes the water heater to be much heavier than normal and this residue, if spilled out, could cause staining.

# Instructions for Installation (cont'd)

## Locating The New Water Heater

You should carefully choose an indoor location for the new water heater, because the placement is a very important consideration for the safety of the occupants in the building and for the most economical use of the appliance. This water heater is not intended for outdoor installation.

Whether replacing an old water heater or putting the water heater in a new location, the following critical points must be observed.

1. The location selected should be indoors as close to and as centralized with the water piping system as possible. This water heater, as well as all water heaters, will eventually leak. Do not install without adequate drainage provisions where water flow will cause damage.

## Typical Installation

**CHECK ALL CONNECTIONS FOR LEAKS. CONSULT THE LOCAL UTILITY COMPANY TO EXAMINE INSTALLATION FOR PROPRIETY AND SAFETY.**

<b>* ⚠ WARNING</b>
<p><b>HOTTER WATER CAN SCALD:</b> Water heaters are intended to produce hot water. Water heated to a temperature which will satisfy clothes washing, dish washing, and other sanitizing needs can scald and permanently injure you upon contact. Some people are more likely to be permanently injured by hot water than others. These include the elderly, children, the infirm, or physically/mentally handicapped. If anyone using hot water in your home fits into one of these groups or if there is a local code or state law requiring a certain temperature water at the hot water tap, then you must take special precautions. In addition to using the lowest possible temperature setting that satisfies your hot water needs, a means such as a mixing valve, should be used at the hot water taps used by these people or at the water heater. Mixing valves are available at plumbing supply or hardware stores. Follow manufacturers instructions for installation of the valves. Before changing the factory setting on the thermostat, read the "Temperature Regulation" section in this manual.</p>

<b>⚠ CAUTION</b>
<p><b>WATER HEATERS EVENTUALLY LEAK:</b> Installation of the water heater must be accomplished in such a manner that if the tank or any connections should leak, the flow of water will not cause damage to the structure. For this reason, it is not advisable to install the water heater in an attic or upper floor. When such locations cannot be avoided, a suitable drain pan should be installed under the water heater. Drain pans are available at your local hardware store. Such a drain pan must have a minimum diameter of at least 1 3/4 inches greater than the water heater diameter and must be piped to an adequate drain.</p>

<b>⚠ CAUTION</b>
<p><b>INSTALLATION IN RESIDENTIAL GARAGES:</b> The water heater must be located and/or protected so it is not subject to physical damage by a moving vehicle.</p>

2. The location selection must provide adequate clearances for servicing and proper operation of the water heater.

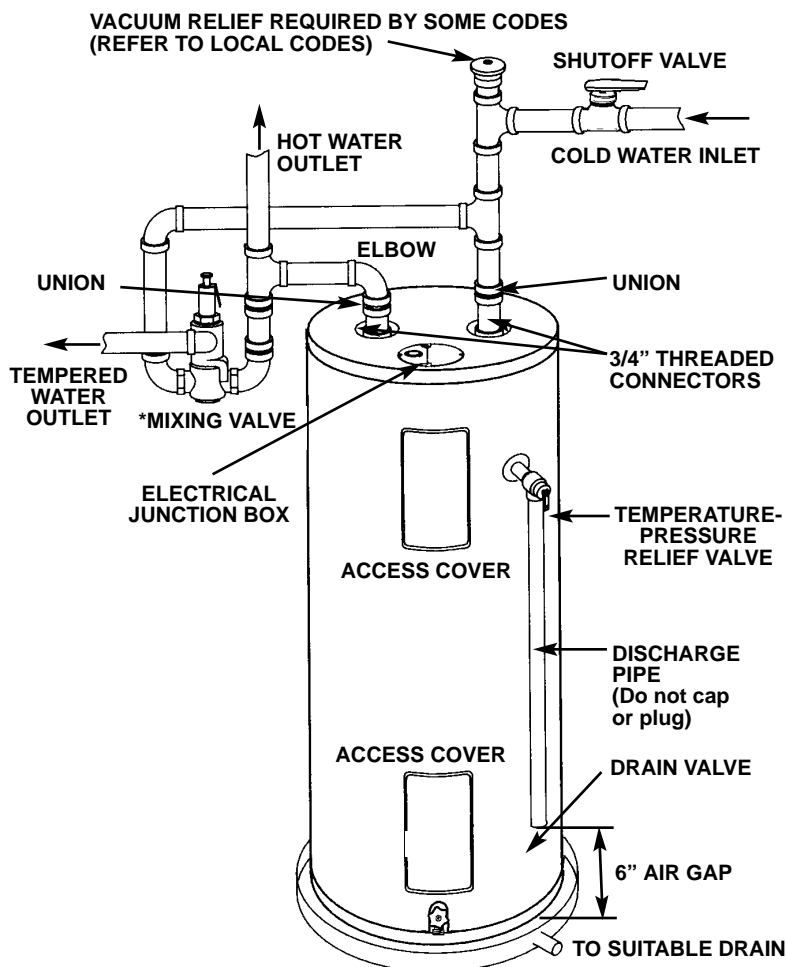

# Instructions for Installation (cont'd)

## Water Piping

### \* ⚠ WARNING

**HOTTER WATER CAN SCALD:** Water heaters are intended to produce hot water. Water heated to a temperature which will satisfy clothes washing, dish washing, and other sanitizing needs can scald and permanently injure you upon contact. Some people are more likely to be permanently injured by hot water than others. These include the elderly, children, the infirm, or physically/mentally handicapped. If anyone using hot water in your home fits into one of these groups or if there is a local code or state law requiring a certain temperature water at the hot water tap, then you must take special precautions. In addition to using the lowest possible temperature setting that satisfies your hot water needs, a means such as a mixing valve, should be used at the hot water taps used by these people or at the water heater. Mixing valves are available at plumbing supply or hardware stores. Follow manufacturers instructions for installation of the valves. Before changing the factory setting on the thermostat, read the "Temperature Regulation" section in this manual.

\*See illustration on page 10 for mixing valve usage.

The illustration shows the attachment of the water piping to the water heater. The water heater is equipped with 3/4 inch water connections.

If a water heater is installed in a closed water supply system; such as one having a back-flow preventer, check valve, water meter with a check valve, etc. in the cold water supply; means shall be provided to control thermal expansion. Contact the local utility or call Maytag Customer Service at 1-800-788-8899 for an authorized servicer on how to control this situation.

**NOTE:** If using copper tubing, solder tubing to an adapter before attaching the adaptor to the cold water inlet connection. Do not solder the cold water supply line directly to the cold water inlet. It will harm the dip tube and damage the tank.

**NOTE:** To protect against untimely corrosion of hot and cold water fittings, it is strongly recommended that di-electric unions or couplings be installed on this water heater when connected to copper pipe.

1. Look at the top cover of the water heater. The water outlet is marked hot. Connect the hot water pipe to the hot water outlet of the water heater.
2. Look at the top cover of the water heater. The cold water inlet is marked cold. Connect the cold water pipe to the cold water inlet of the water heater.

**NOTE:** Your water heater is super insulated to minimize heat loss from the tank. Further reduction in heat loss can be accomplished by insulating the hot water lines from the water heater.

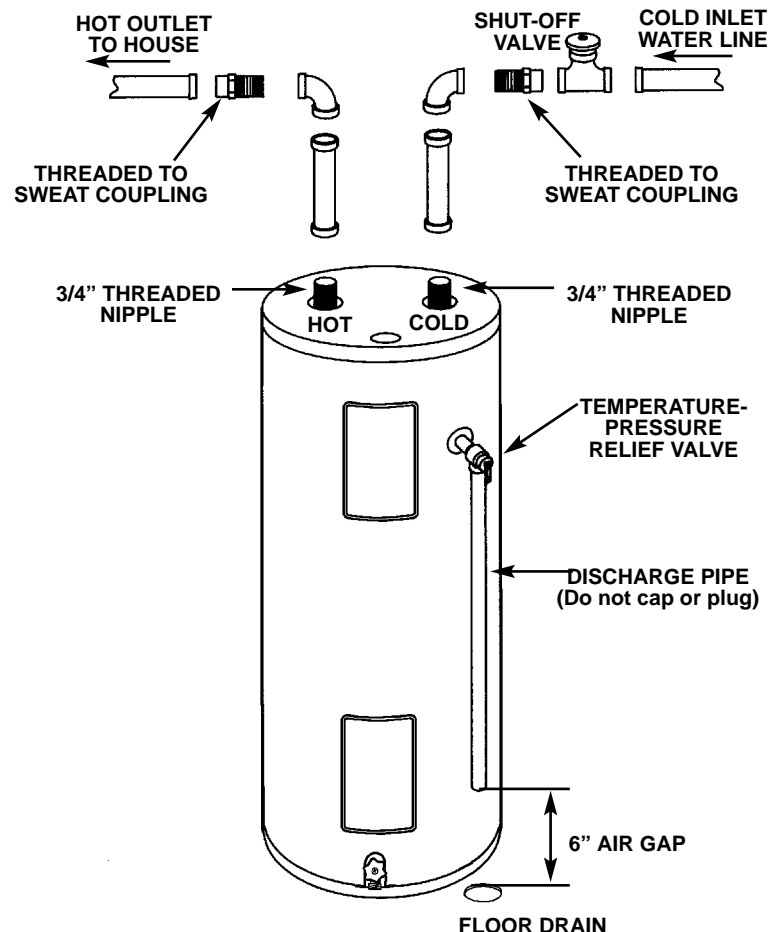

## T&P Valve and Pipe Insulation

Remove insulation for T&P Valve and pipe connections from carton.

Fit pipe insulation over the incoming cold water line and the hot water line. Make sure that the insulation is against the top cover of the heater.

Fit T&P Valve insulation over valve. Make sure that the insulation does not interfere with the lever of the T&P valve.

Secure all insulation using tape.

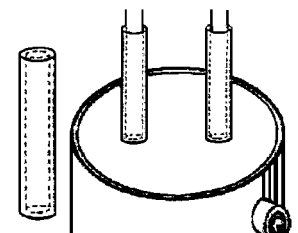

# Instructions for Installation (cont'd)

## Temperature-Pressure Relief Valve

### ▲ WARNING

At the time of manufacture this water heater was provided with a combination temperature-pressure relief valve certified by a nationally recognized testing laboratory that maintains periodic inspection of production of listed equipment or materials, as meeting the requirements for Relief Valves and Automatic Gas Shutoff Devices for Hot Water Supply Systems, and the current edition of ANSI Z21.22 • CSA 4.4 and the code requirements of ASME. If replaced, the valve must meet the requirements of local codes, but not less than a combination temperature and pressure relief valve certified as meeting the requirements for Relief Valves and Automatic Gas Shutoff Devices for Hot Water Supply Systems, ANSI Z21.22 • CSA 4.4 by a nationally recognized testing laboratory that maintains periodic inspection of production of listed equipment or materials.

The valve must be marked with a maximum set pressure not to exceed the marked hydrostatic working pressure of the water heater (150 lbs./sq. in.) and a discharge capacity not less than the water heater input rate as shown on the model rating plate. (Electric heaters - watts divided by 1000 x 3412 equal BTU/Hr. rate.)

Your local jurisdictional authority, while mandating the use of a temperature-pressure relief valve complying with ANSI Z21.22 • CSA 4.4 and ASME, may require a valve model different from the one furnished with the water heater.

Compliance with such local requirements must be satisfied by the installer or end user of the water heater with a locally prescribed temperature-pressure relief valve installed in the designated opening in the water heater in place of the factory furnished valve.

For safe operation of the water heater, the relief valve must not be removed from its designated opening or plugged.

The temperature-pressure relief valve must be installed directly into the fitting of the water heater designated for the relief valve. Position the valve downward and provide tubing so that any discharge will exit only within 6 inches above, or at any distance below the structural floor. Be certain that no contact is made with any live electrical part. The discharge opening must not be blocked or reduced in size under any circumstances. Excessive length, over 30 feet, or use of more than four elbows can cause restriction and reduce the discharge capacity of the valve.

No valve or other obstruction is to be placed between the relief valve and the tank. Do not connect tubing directly to discharge drain unless a 6" air gap is provided. To prevent bodily injury, hazard to life, or property damage, the relief valve must be allowed to discharge water in quantities should circumstances demand. If the discharge pipe is not connected to a drain or other suitable means, the water flow may cause property damage.

#### The Discharge Pipe:

- Must not be smaller in size than the outlet pipe size of the valve, or have any reducing couplings or other restrictions.
- Must not be plugged or blocked.
- Must be of material listed for hot water distribution.
- Must be installed so as to allow complete drainage of both the temperature-pressure relief valve, and the discharge pipe.
- Must terminate at an adequate drain.
- Must not have any valve between the relief valve and tank.

### ▲ WARNING

The temperature-pressure relief valve must be manually operated at least once a year. Caution should be taken to ensure that (1) no one is in front of or around the outlet of the temperature-pressure relief valve discharge line, and (2) the water manually discharged will not cause any bodily injury or property damage because the water may be extremely hot. If after manually operating the valve, it fails to completely reset and continues to release water, immediately close the cold water inlet to the water heater, follow the draining instructions, and replace the temperature-pressure relief valve with a new one.

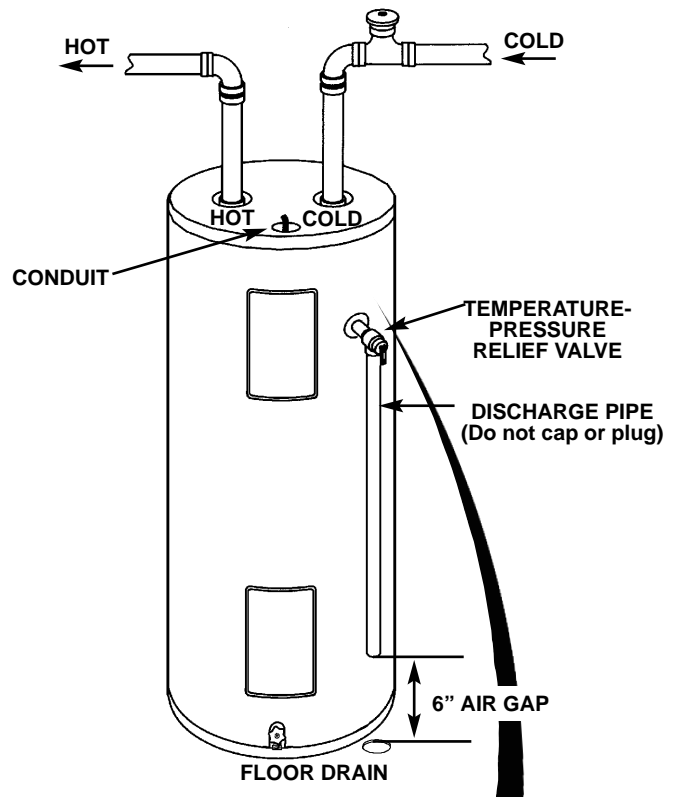

### WARNING "RELIEF VALVE OPENING"

This water heater is provided with a combination Temperature-Pressure Relief Valve listed as complying with the standard for Relief Valves and Automatic Gas Shutoff Devices for Hot Water Supply Systems, ANSI Z21.22 and the code requirements of ASME.

Your local jurisdictional authority, while mandating the use of a Temperature-Pressure Relief Valve complying with ANSI Z21.22 and ASME, may require a valve model different from the one furnished with the water heater. Compliance with such local requirements must be satisfied by the installer or end user of the water heater with a locally prescribed Temperature-Pressure Relief Valve installed in the designated opening in the water heater.

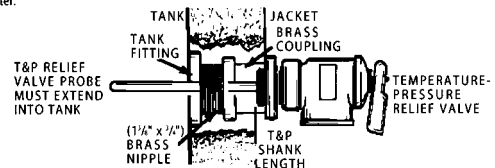

- If a short shank (less than 2") temperature-pressure relief valve is to be installed (as shown), a nipple and coupling must be used.
- If a long shank (2" or longer) is to be installed, do not use the nipple and coupling.

"Install Temperature-Pressure protective equipment required by local codes, but not less than a combination Temperature-Pressure Relief Valve certified as meeting the requirements for Relief Valves and Automatic Gas Shutoff Devices for Hot-Water Supply Systems, ANSI Z21.22 by a nationally recognized testing laboratory that maintains periodic inspection of production of listed equipment or materials. The valve must be oriented, provided with tubing, or otherwise installed so that discharge can exit only within 6 inches above, or at any distance below the structural floor, and cannot contact any live electrical part." For safe operation of the water heater, the Relief Valve must not be removed or plugged. See manual heading - "Temperature-Pressure Relief Valve" for installation and maintenance of Relief Valve, discharge pipe and other safety precautions.

# Instructions for Installation (cont'd)

## Filling the Water Heater

To fill the water heater with water:

1. Close the water heater drain valve by turning the handle to the right (clockwise). The drain valve is on the lower front of the water heater.
2. Open the cold water supply valve to the water heater.  
**NOTE: The cold water supply valve must be left open when the water heater is in use.**
3. To insure complete filling of the tank, allow air to exit by opening the nearest hot water faucet. Allow water to run until a constant flow is obtained. This will let air out of the water heater and the piping.

### CAUTION

Never use this water heater unless it is completely full of water. To prevent damage to the tank and heating element, the tank must be filled with water. Water must flow from the hot water faucet before turning "ON" power.

4. Check all new water piping for leaks. Repair as needed.

## Wiring Diagrams

### STANDARD WIRING FOR 2 WIRE LEAD WATER HEATERS NON-SIMULTANEOUS OPERATION 240 VOLT DOUBLE ELEMENT

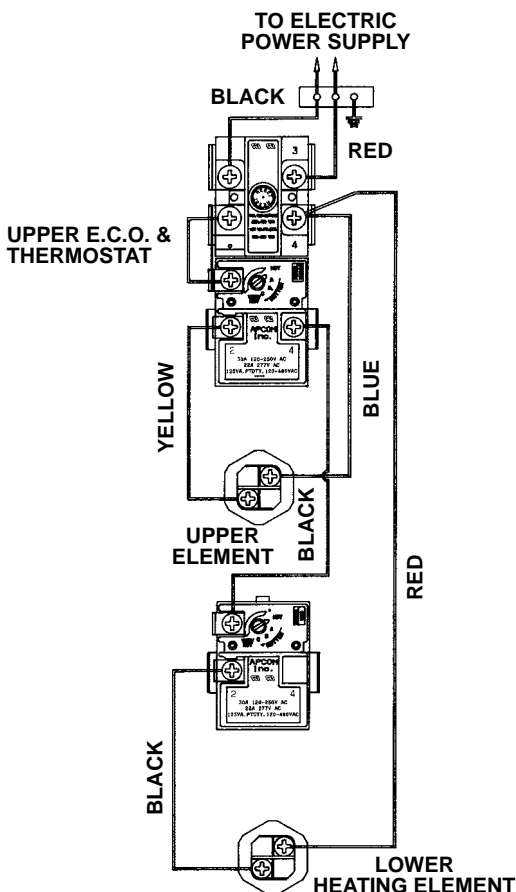

### STANDARD WIRING FOR SINGLE ELEMENT 240 VOLT TO ELECTRIC POWER SUPPLY

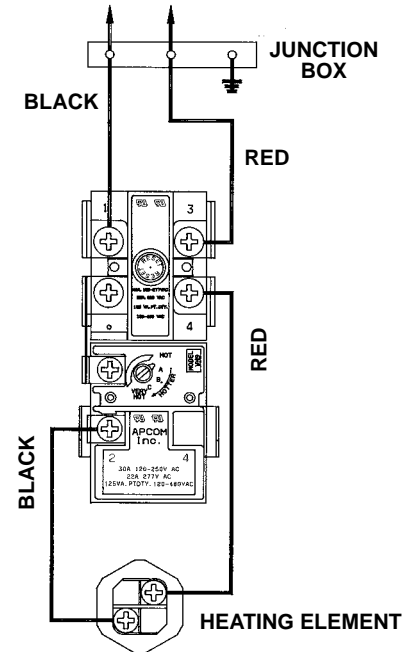

### WIRING FOR 3 WIRE LEAD WATER HEATERS NON-SIMULTANEOUS OPERATION 240 VOLT DOUBLE ELEMENT

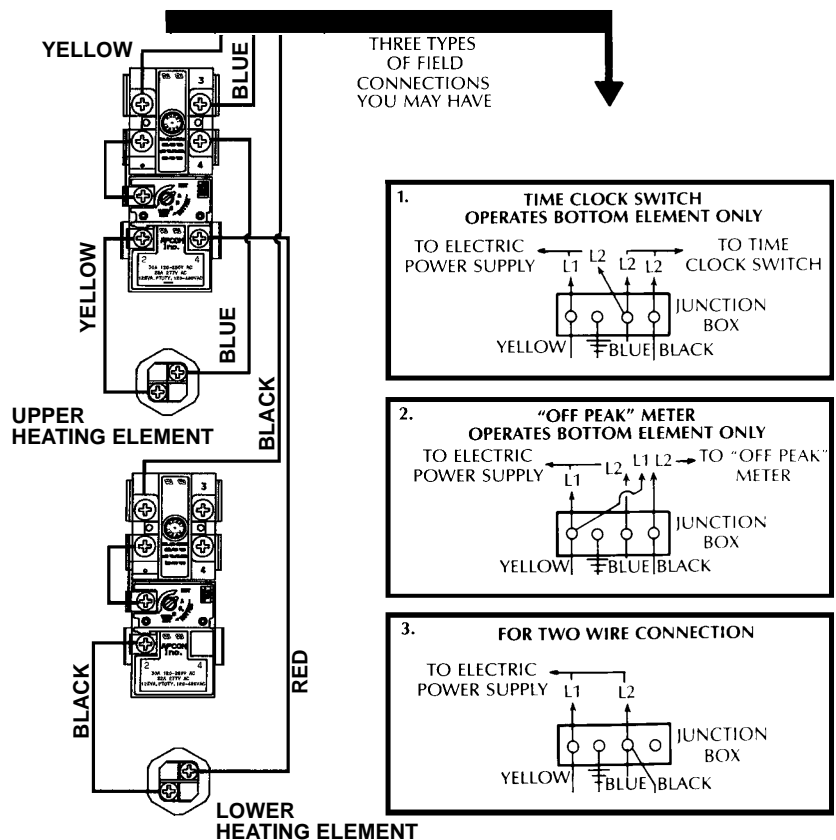

Note: Some Lower Hi-Temp Limit switches may have 4 terminals. Use only the 2 terminals on left.

# Instructions for Installation (cont'd)

## Wiring

### ⚠ CAUTION

Never use this water heater unless it is completely full of water. To prevent damage to the tank and heating element, the tank must be filled with water. Water must flow from the hot water faucet before turning on power.

You must provide all wiring of the proper size outside of the water heater. You must obey local codes and electric company requirements when you install this wiring.

If you are not familiar with electric codes and practices, or if you have any doubt, even the slightest doubt, in your ability to connect the wiring to this water heater, obtain the service of a competent electrician. Call Maytag Customer Service at 1-800-788-8899 for an authorized servicer.

### ⚠ WARNING

**WATER HEATERS EQUIPPED FOR ONE VOLTAGE ONLY:** This water heater is equipped for one type voltage only. Check the rating plate near the bottom access panel for the correct voltage. **DO NOT** use this water heater with any voltage other than the one shown on the model rating plate. Failure to use the correct voltage can cause problems which can result in **DEATH, SERIOUS BODILY INJURY, OR PROPERTY DAMAGE.** If you have any questions or doubts consult your electric company.

### ⚠ CAUTION

If wiring from your fuse box or circuit breaker box was aluminum for your old water heater, replace it with copper wire. If you wish to reuse the existing aluminum wire, have the connection at the water heater made by a competent electrician. Call Maytag Customer Service at 1-800-788-8899 for an authorized servicer.

1. Provide a way to easily shut off the electric power when working on the water heater. This could be with a circuit breaker or fuse block in the entrance box or a separate disconnect switch.
2. Install and connect a circuit directly from the main fuse or circuit breaker box. This circuit must be the right size and have its own fuse or circuit breaker. Refer to the chart in the "Product Specifications" section for the correct size wire and fuse or circuit breaker.
3. If metal conduit is used for the grounding conductor:
  - A. The grounding electrode conductor shall be of copper, aluminum, or copperclad aluminum. The material shall be of one continuous length without a splice or joint.
  - B. Rigid metal conduit, intermediate metal conduit, or electrical metallic tubing may be used for the grounding means if conduit or tubing is terminated in fittings approved for grounding.

C. Flexible metal conduit or 3 metallic tubing shall be permitted for grounding if all the following conditions are met:

1. The length in any ground return path does not exceed 6 feet.
2. The circuit conductors contained therein are protected by overcurrent devices rated at 20 amperes or less.
3. The conduit or tubing is terminated in fittings approved for grounding.

For complete grounding details and all allowable exceptions, refer to the current edition of the NEC - National Electrical Code, NFPA 70.

4. A standard 1/2" conduit opening has been made in the water heater junction box for the conduit connection.
5. Wiring Diagrams (See "Wiring Diagrams" Section) have been supplied showing the two most common types of connections between the water heater and the power supply. You can easily see which type connection you have by removing the junction box cover on top of the water heater.
  - A. Two Wire Connection Diagrams:** is the most common requiring you to simply connect red to red, black to black, and the ground wire to the green ground screw in the junction box of the water heater.
  - B. Three Wire Connection Diagram:** is used when you are connecting the water heater to power a supply that has a "Time Clock" or "Off Peak" Meter. To make these connections refer to block 1 or 2 in this wiring diagram for the type of system you have.**NOTE: If you have purchased a three wire connection water heater but you are not on a "Time Clock" or "Off Peak" meter and have a standard two wire connection power supply, simply follow the connection diagram in block 3 of the Three Wire Connection Diagram.**

6. Use wire nuts and connect the power supply wiring to the wires inside the water heater's junction.
7. The water heater must be electrically "grounded" by the installer. A green ground screw has been provided in the water heater's junction box. Connect ground wire to this location.
8. Replace the wiring junction cover using the screw provided.

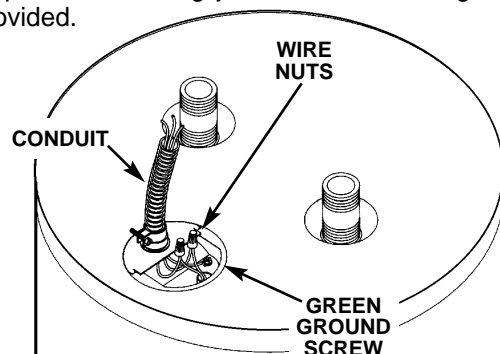

# Instructions for Installation (cont'd)

## Installation Checklist

1. Whether or not the element conversion is made, the model rating plate must be marked. Using a hard point ink pen, check the appropriate block within the model rating plate, which is located adjacent to the lower access panel.
2. Is the fuse or circuit breaker size correct as shown in the chart in the "Product Specifications" section?
3. Are the wires from the circuit breaker or fuse service to the water heater's junction box on the correct wire size (gauge) as shown in the chart in the "Product Specifications" section?
4. Is the new temperature-pressure relief valve properly installed, and piped to an adequate drain? See "Temperature-Pressure Relief Valve" in the "Instructions for Installation" section.
5. Is the water heater completely filled with water? See "Filling the Water Heater" instructions in the "Instructions for Installation" section.
6. Will a water leak damage anything? See "Locating the New Water Heater" in the "Instructions for Installation" section.
7. Are the cold and hot water lines connected to the water heater correctly? See "Water Piping" instructions in the "Instructions for Installation" section.
8. Is there adequate clearance for maintenance around the water heater?
9. Do you need to call your electric company to check your wiring?

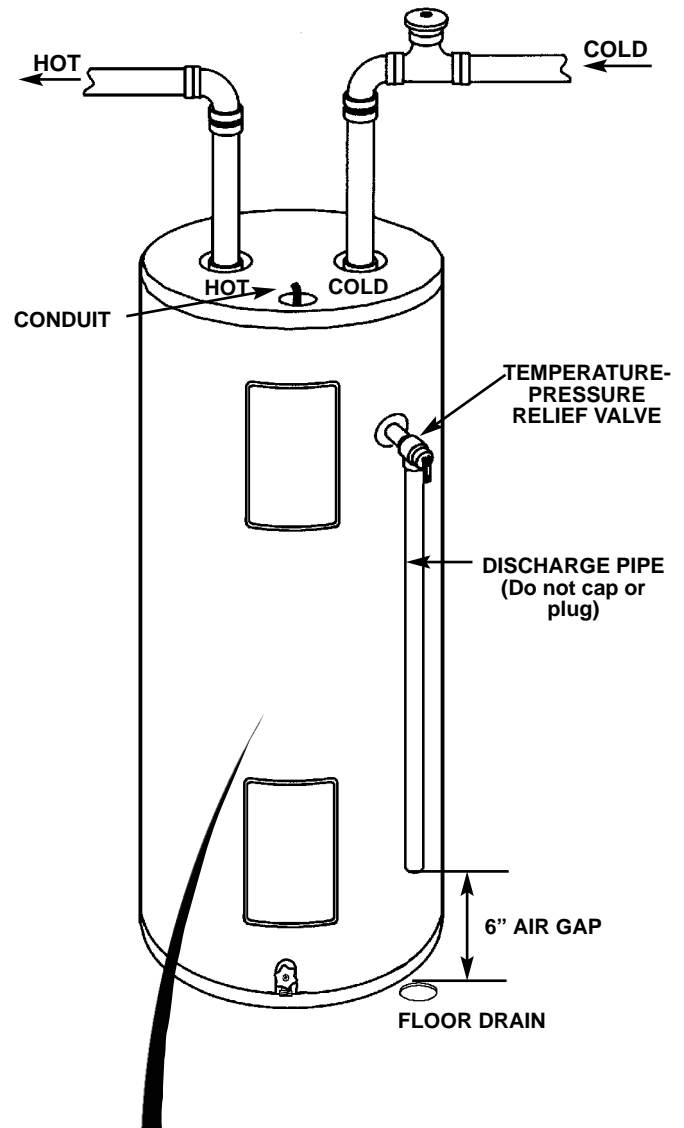

ELECTRIC STORAGE TANK WATER HEATER						 Listed 932N	
MODEL NUMBER		SERIAL NUMBER		ITEM ID / PART NUMBER			
VOLTS - AC	PHASE	WATTS UPPER	WATTS LOWER	TOTAL WATTS CONNECTED	CAPACITY US GAL.	MAX WORKING PRESSURE	
ALTERNATE RATINGS							
VOLTS - AC	WATTS UPPER	WATTS LOWER	TOTAL WATTS CONNECTED		CITY OF NEW YORK DEPT. OF BUILDINGS MEA		
CIRCUIT							

**MODEL RATING PLATE**

# Service and Maintenance

## Temperature Regulation

### ⚠ WARNING

**HOTTER WATER CAN SCALD:** Water heaters are intended to produce hot water. Water heated to a temperature which will satisfy clothes washing, dish washing, and other sanitizing needs can scald and permanently injure you upon contact. Some people are more likely to be permanently injured by hot water than others. These include the elderly, children, the infirm, or physically/mentally handicapped. If anyone using hot water in your home fits into one of these groups or if there is a local code or state law requiring a certain temperature water at the hot water tap, then you must take special precautions. In addition to using the lowest possible temperature setting that satisfies your hot water needs, a means such as a mixing valve, should be used at the hot water taps used by these people or at the water heater. Mixing valves are available at plumbing supply or hardware stores. Follow manufacturers instructions for installation of the valves. Before changing the factory setting on the thermostat, read the "Temperature Regulation" section in this manual.

### ⚠ WARNING

Never allow small children to use a hot water tap, or to draw their own bath water. Never leave a child or handicapped person unattended in a bathtub or shower.

## Thermostats

The thermostat(s) of this water heater have been factory set at a position which approximates 120°F (HOT) to reduce the risk of scald injury.

The upper and/or lower thermostat(s) are factory set at a position which approximates 120°F (HOT) and is adjustable if a different water temperature is desired. Read all warnings in this manual and on the water heater before proceeding.

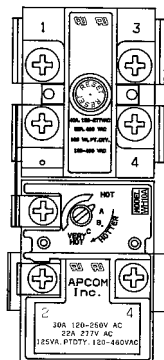

**UPPER THERMOSTAT ADJUSTABLE  
BEHIND UPPER ACCESS PANEL**

**LOWER THERMOSTAT  
WITH HIGH LIMIT**

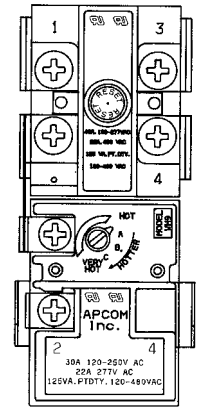

**LOWER THERMOSTAT  
WITHOUT HIGH LIMIT**

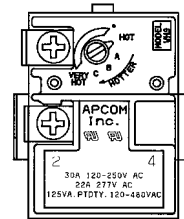

**LOWER THERMOSTAT ADJUSTABLE  
BEHIND LOWER ACCESS PANEL**

## Temperature Settings

**HOT**—Is a thermostat setting of approximately 120°F, which will supply hot water at the most economical temperatures.

**A**—Is a thermostat setting of approximately 130°F.

**B**—Is a thermostat setting of approximately 140°F.

**C**—Is a thermostat setting of approximately 150°F.

**VERY HOT**—Is a thermostat setting of approximately 160°F. It is recommended that the dial be set lower whenever possible.

**NOTE:** Water temperature range of 120°–140°F recommended by most dishwasher manufacturers.

Temperature Setting	Time to Produce 2nd & 3rd Degree Burns on Adult Skin
160°F	About 1/2 seconds
150°F	About 1-1/2 seconds
140°F	Less than 5 seconds
130°F	About 30 seconds
120°F	More than 5 minutes



# Service and Maintenance (cont'd)

## Thermostat Adjustments

The upper and/or lower thermostat(s) have been factory set at HOT (approximately 120°F) to reduce the risk of scald injury.

The upper and/or lower thermostat(s) are adjustable if a different water temperature is desired. Read all warnings in the "Temperature Regulation" section before proceeding.

**NOTE: It is not necessary to adjust the upper thermostat. However, if it is adjusted above the factory set point of 120°F (HOT) it is recommended that it not be set higher than the lower thermostat setting.**

To adjust the temperature setting for both upper and lower thermostats, proceed as follows:

1. Turn "OFF" the electric power to the water heater at the junction box.

### ⚠ WARNING

**HAZARD OF ELECTRICAL SHOCK! Before removing any access panels or servicing the water heater, make sure the electrical supply to the water heater is turned "OFF". Failure to do this could result in DEATH, SERIOUS BODILY INJURY, OR PROPERTY DAMAGE.**

2. Take off the access panel, insulation block and pad.
3. The slotted adjustment (using a screwdriver) can be turned clockwise (↻) to increase the temperature setting or counter clockwise (↻) to decrease the temperature setting.
4. Replace the insulation block, pad and access panel.
5. Turn "ON" the power supply.

## Anode Rod Inspection

The anode rod is used to protect the tank from corrosion. Most hot water tanks are equipped with an anode rod. The submerged rod sacrifices itself to protect the tank. Instead of corroding the tank, water ions attack and eat away the anode rod. This does not affect the water's taste or color. The rod must be maintained to keep the tank in operating condition.

Anode deterioration depends on water conductivity, not necessarily water condition. A corroded or pitted anode

rod indicates high water conductivity and should be checked and/or replaced more often than an anode rod that appears to be intact. Replacement of a depleted anode rod can extend the life of your water heater. Inspection should be conducted by a qualified service technician, and at a minimum should be checked annually after the warranty period.

## Temperature-Pressure Relief Valve Operation

The temperature-pressure relief valve must be manually operated at least once a year.

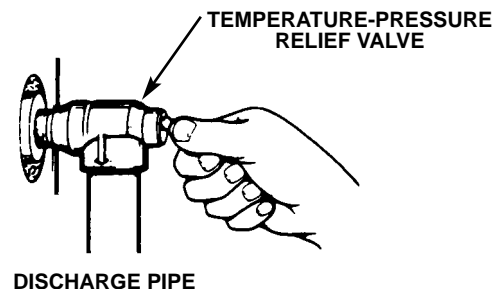

### ⚠ WARNING

**The temperature-pressure relief valve must be manually operated at least once a year. Caution should be taken to ensure that (1) no one is in front of or around the outlet of the temperature-pressure relief valve discharge line, and (2) the water manually discharged will not cause any property damage or bodily injury. The water may be extremely hot.**

**If after manually operating the valve, it fails to completely reset and continues to release water, immediately close the cold water inlet to the water heater, follow the draining instructions, and replace the temperature-pressure relief valve with a new one.**

Failure to install and maintain a new properly listed temperature-pressure relief valve will release the manufacturer from any claim which might result from excessive temperature or pressure.

### ⚠ WARNING

**If the temperature-pressure relief valve on the appliance weeps or discharges periodically, this may be due to thermal expansion. Your water heater may have a check valve installed in the water line or a water meter with a check valve. Call Maytag Customer Service at 1-800-788-8899 for an authorized servicer. Do not plug the temperature-pressure relief valve.**

# Service and Maintenance (cont'd)

## Draining

The water heater should be drained if being shut down during freezing temperatures. Also periodic draining and cleaning of sediment from the tank may be necessary.

1. Before beginning turn "OFF" the electric power supply to the water heater.

### ⚠ WARNING

**HAZARD OF ELECTRICAL SHOCK! Before removing any access panels or servicing the water heater, make sure the electrical supply to the water heater is turned "OFF". Failure to do this could result in DEATH, SERIOUS BODILY INJURY, OR PROPERTY DAMAGE.**

2. CLOSE the cold water inlet valve to the water heater.
3. OPEN a nearby hot water faucet and leave open to allow for draining.
4. Connect a hose to the drain valve and terminate to an adequate drain or outdoors.
5. OPEN the water heater drain valve to allow for tank draining.  
**NOTE: If the water heater is going to be shut down and drained for an extended period, the drain valve should be left open with hose connected allowing water to terminate to an adequate drain.**
6. Close the drain valve.
7. Follow "Filling the Water Heater" instructions in the "Instructions for Installation" section.

8. Turn "ON" power to the water heater.

### ⚠ CAUTION

**Never use this water heater unless it is completely full water. To prevent damage to the tank and heating element, the tank must be filled with water. Water must flow from the hot water faucet before turning "ON" power.**

## Thermostat Removal/Replacement

1. Turn "OFF" the electrical power to the water heater at the junction box.

### ⚠ WARNING

**HAZARD OF ELECTRICAL SHOCK! Before removing any access panels or servicing the water heater, make sure the electrical supply to the water heater is turned "OFF". Failure to do this could result in DEATH, SERIOUS BODILY INJURY, OR PROPERTY DAMAGE.**

2. Remove the access panel and the insulation block and pad.
3. Lift out the tab as shown below to unclip the terminal cover from the thermostat.

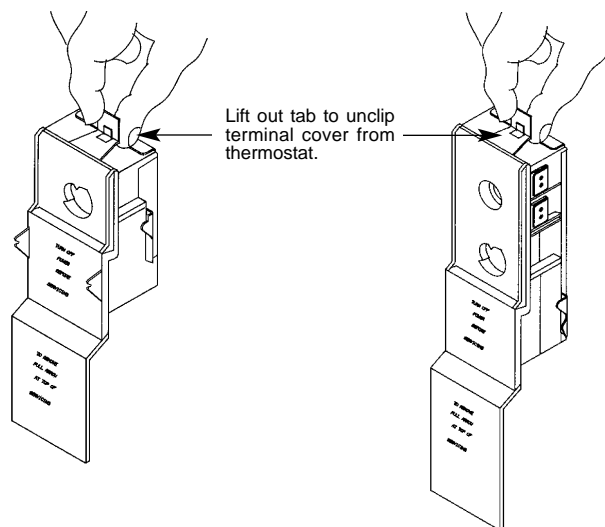

LOWER THERMOSTAT WITHOUT HIGH LIMIT

UPPER OR LOWER THERMOSTAT WITH HIGH LIMIT

4. Remove the two wires attached to the thermostat.
5. Remove the thermostat from behind the thermostat bracket.
6. Disconnect wires from thermostat and slide out of the bracket.
7. Place the new lower thermostat in the bracket making sure it fits firmly against the tank.
8. Attach the wires to the new thermostat.

**NOTE: Some of the terminals may require straight-in wiring through an eye-opening. If wires are now looped, re-cut and strip wire 3/8" to a straight length and insert.**

# Service and Maintenance (cont'd)

## Thermostat Removal (cont'd)

- Put plastic terminal cover back in place.
- Replace the insulation block and pad to cover the thermostat.
- Replace access panel, then turn the electric power "ON".

## Element Cleaning/ Replacement

**NOTE:** These instructions are written for element cleaning and element replacement for the lower element. If it is necessary to clean or replace the upper element, then repeat these instructions.

To remove the element from your tank in order to clean or replace it:

- Before beginning turn "OFF" the electric power supply to the water heater.

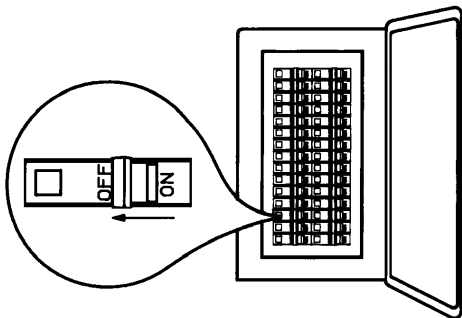

<b>⚠ WARNING</b>
<b>HAZARD OF ELECTRICAL SHOCK!</b> Before removing any access panels or servicing the water heater, make sure the electrical supply to the water heater is turned "OFF". Failure to do this could result in DEATH, SERIOUS BODILY INJURY, OR PROPERTY DAMAGE.

- Turn off the water supply to the water heater at the water shutoff valve or water meter.



- Attach a hose to the water heater drain valve and put the other end in a floor drain or outdoors. Open the water heater drain valve. Open a nearby hot water faucet which will relieve pressure in the water heater and speed draining.

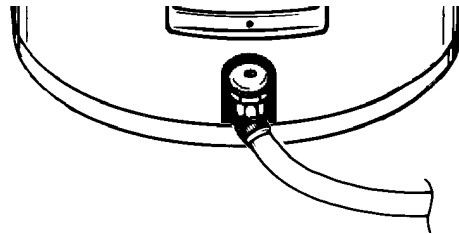

<b>⚠ WARNING</b>
The water passing out of the drain valve may be extremely hot. To avoid being scalded, make sure all connections are tight and that the water flow is directed away from any person.

- Remove the two screws securing the access panel, and remove panel.

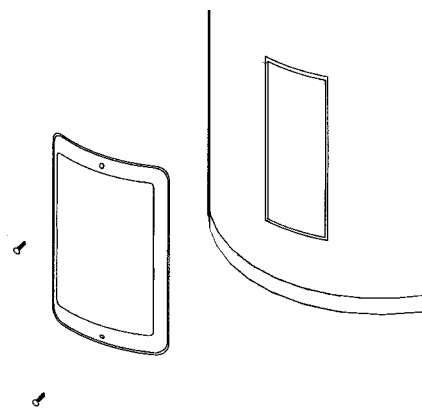

- Remove the block of insulation and pad to expose the terminal cover.

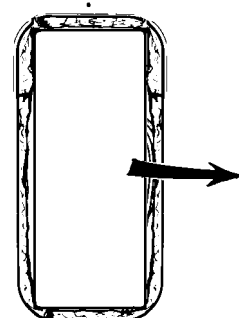

# Service and Maintenance (cont'd)

- Lift out the tab as shown to unclip the terminal cover from the thermostat. The terminal cover can now be removed from the thermostat.

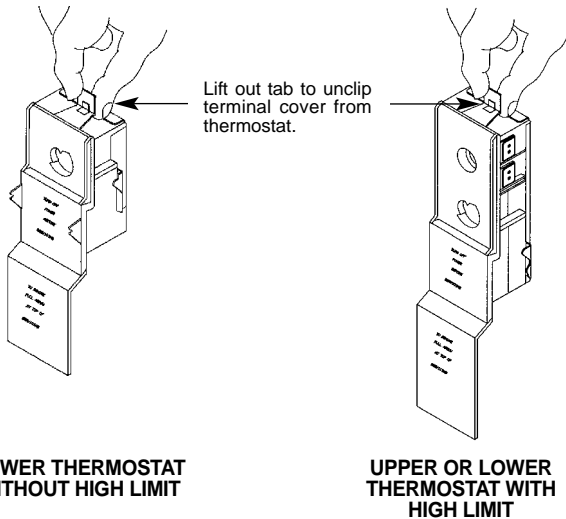

- Disconnect the two wires on the element and unscrew the old element from the tank.

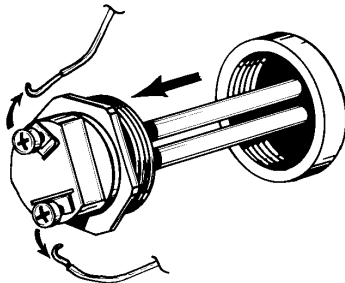

- Clean the area around the element opening. Remove any sediment from or around the element opening and inside the tank.
- If you are cleaning the element you have removed, do so by scraping or soaking in vinegar or a delimiting solution.

## **▲WARNING**

Replacement elements must (1) be the same voltage and (2) no greater wattage than listed on the model rating plate affixed to the water heater.

- A new gasket should be used in all cases to prevent a possible water leak. (See Element Gasket in the Repair Parts Chart). Place the new element gasket on the thread side of the cleaned or new element and screw into tank, securing tightly using an element wrench.

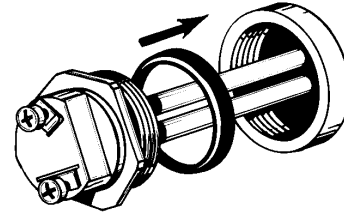

- Close the water heater drain valve by turning the handle to the right (clockwise). The drain valve is on the lower front of the water heater.
  - Open the cold water supply valve to the water heater.
- NOTE: The cold water supply valve must be left open when the water heater is in use.
- To insure complete filling of the tank, allow air to exit by opening the nearest hot water faucet. Allow water to run until a constant flow is obtained. This will let air out of the water heater and the piping.

## **▲CAUTION**

Never use this water heater unless it is completely full of water. To prevent damage to the tank and heating element, the tank must be filled with water. Water must flow from the hot water faucet before turning "ON" power.

- Check element for water leaks. If leakage occurs, tighten element or repeat steps 2 and 3, remove element and reposition gasket. Then repeat steps 10 through 14.
- Reconnect the two wires to the element and then check to make sure the thermostat remains firmly against the surface of the tank.

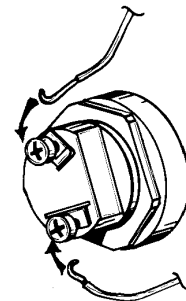

# Service and Maintenance (cont'd)

## Element Cleaning/ Replacement (cont'd)

16. Replace the terminal cover on the thermostat making sure that the locking tabs on the terminal cover are in place.

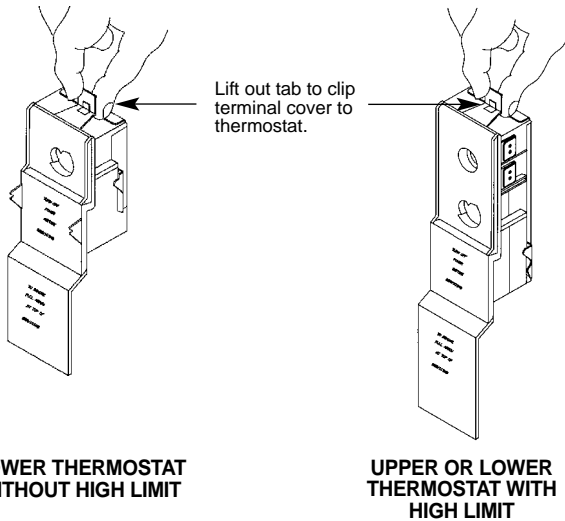

17. Place the insulation block and pad back in place so that it completely covers the thermostat and element.

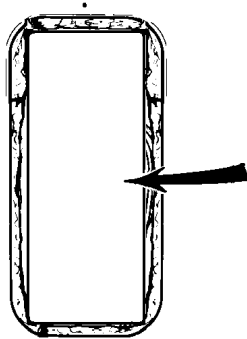

18. Replace access panel.
19. Turn "ON" electric power to water heater.

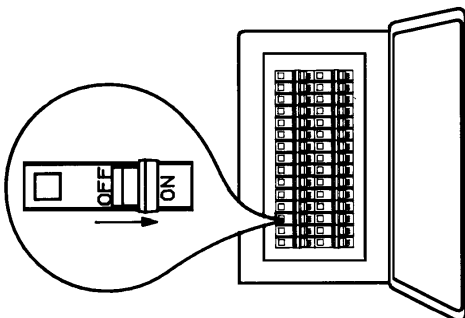

## Drain Valve Washer Replacement

**NOTE:** For replacement, use a 17/32"x 13/64"x 1/8" thick washer available at your nearest hardware store. For ordering a replacement washer, refer to the "Repair Parts" section.

1. Before beginning turn "OFF" the electrical power supply to the water heater.

### ⚠ WARNING

**HAZARD OF ELECTRICAL SHOCK!** Before removing any access panels or servicing the water heater, make sure the electrical supply to the water heater is turned "OFF". Failure to do this could result in DEATH, SERIOUS BODILY INJURY, OR PROPERTY DAMAGE.

2. Follow "Draining" instructions in the "Service and Maintenance" section.
3. Turning counter clockwise, remove the hex cap below the screw handle.
4. Remove the washer and put the new one in place.
5. Screw the handle and cap assembly back into the drain valve and retighten using a wrench. **DO NOT OVER TIGHTEN.**
6. Follow "Filling the Water Heater" instructions in the "Instructions for Installation" section.
7. Check for leaks.
8. Turn "ON" electric power to the water heater.



## Service

Before calling for repair service, read the "Start Up Conditions" and "Operational Conditions" found in the "Troubleshooting" section of this manual.

If a condition persists or you are uncertain about the operation of the water heater, let a qualified person check it out.

**Call Maytag Customer Service at 1-800-788-8899.**

# Troubleshooting

## Start Up Conditions

### THERMAL EXPANSION

Water supply systems may, because of such events as high line pressure, frequent cut-offs, the effects of water hammer among others, have installed devices such as pressure reducing valves, check valves, back flow preventers, etc...to control these types of problems. When these devices are not equipped with an internal by-pass, and no other measures are taken, the devices cause the water system to be closed. As water is heated, it expands (thermal expansion) and closed systems do not allow for the expansion of heated water.

The water within the water heater tank expands as it is heated and increases the pressure of the water system. If the relieving point of the water heater's temperature-pressure relief valve is reached, the valve will relieve the excess pressure. **The temperature-pressure relief valve is not intended for the constant relief of thermal expansion.** This is an unacceptable condition and must be corrected.

It is recommended that any devices installed which could create a closed system, have a by-pass and/or the system have an expansion tank to relieve the pressure built by thermal expansion in the water system. Expansion tanks are available for ordering through the Maytag Customer Service. Contact the local water supplier and/or call Maytag Customer Service at 1-800-788-8899 for an authorized servicer for assistance in controlling these situations.

### STRANGE SOUNDS

Possible noises due to expansion and contraction of some metal parts during periods of heat-up and cool-down do not represent harmful or dangerous conditions.

## Operational Conditions

### SMELLY WATER

In each glasslined water heater there is installed at least one anode rod (see parts section) for corrosion protection of the tank. Certain water conditions will cause a reaction between this rod and the water. The most common complaint associated with the anode rod is one of a "rotten egg smell". This odor is derived from hydrogen sulfide gas dissolved in the water. The smell is the result of four factors which must all be present for the odor to develop:

- a concentration of sulfate in the supply water.
- little or no dissolved oxygen in the water.
- a sulfate reducing bacteria within the water heater. (This harmless bacteria is non-toxic to humans.)
- an excess of active hydrogen in the tank. This is caused by the corrosion protective action of the anode.

Smelly water may be eliminated or reduced in some water heater models by replacing the anode(s) with one of less active material, and then chlorinating the water heater tank and all hot water lines. Call Maytag Customer Service at 1-800-788-8899 for an authorized servicer for further information concerning an Anode Replacement Kit #66001068 and this Chlorination Treatment.

If the smelly water persists after the anode replacement and chlorination treatment, we can only suggest that continuous chlorination and filtering conditioning equipment be considered to eliminate the water problem.

Do not remove the anode leaving the tank unprotected. By doing so, all warranty on the water heater tank is voided.

### "AIR" IN HOT WATER FAUCETS

#### ⚠ WARNING

**HYDROGEN GAS:** Hydrogen gas can be produced in a hot water system that has not been used for a long period of time (generally two weeks or more). Hydrogen gas is extremely flammable and explosive. To prevent the possibility of injury under these conditions, we recommend the hot water faucet be opened for several minutes at the kitchen sink before any electrical appliances which are connected to the hot water system are used (such as a dishwasher or washing machine). If hydrogen gas is present, there will probably be an unusual sound similar to air escaping through the pipe as the hot water faucet is opened. There must be no smoking or open flame near the faucet at the time it is open.

### RUMBLING NOISE

In some water areas, scale or mineral deposits will build up on your heating elements. This buildup will cause a rumbling noise. Follow "Element Cleaning/Replacement" instructions to clean and replace the elements.

### HIGH TEMPERATURE SHUT OFF SYSTEM

The water heater has a high limit shut off system with a reset button located on the thermostat.

Follow the resetting instructions which refer to the high limit behind the access panel.

**NOTE: If your water heater is connected to an "OFF PEAK" clock, and uses the "3 wire lead" wiring diagram in the "Wiring Diagram" section, then the water heater will have a hi-limit on both the upper and lower thermostats. Follow the instructions to reset the hi-limit behind the upper and lower access panels.**

# Troubleshooting (cont'd)

1. Before beginning, turn "OFF" electrical power supply to the water heater.

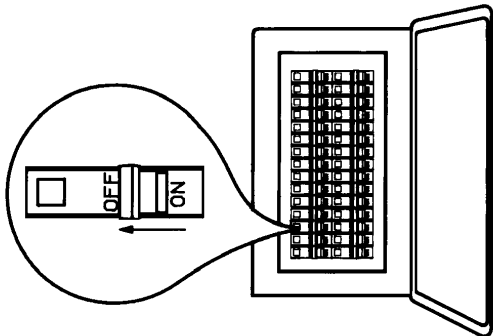

## ⚠ WARNING

**HAZARD OF ELECTRICAL SHOCK!** Before removing any access panels or servicing the water heater, make sure the electrical supply to the water heater is turned "OFF". Failure to do this could result in **DEATH, SERIOUS BODILY INJURY, OR PROPERTY DAMAGE.**

2. Remove the two screws securing the access panel and remove panel.
3. Remove the insulation block and pad to expose the terminal cover.
4. Reset the high limit by pushing in the red button marked "RESET".

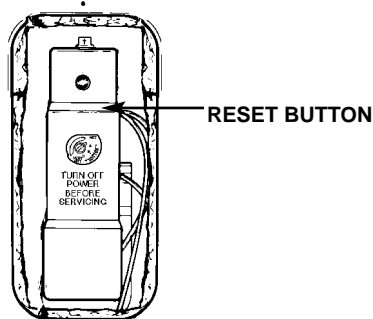

5. Replace the insulation block and pad so that it completely covers the thermostat and element.
6. Replace the access panel.
7. Turn "ON" electric power to the water heater.

## ⚠ CAUTION

**If the high limit must be reset again, call Maytag Customer Service at 1-800-788-8899 for an authorized servicer to find out why the high limit turned "OFF" the electric power.**

## NOT ENOUGH OR NO HOT WATER

1. In a new installation, the water heater may not be properly connected. Make sure the cold water supply valve is open. Review and check piping installation. Make sure that the cold water line is connected to the cold water inlet to the water heater and the hot water line to the hot water outlet on the water heater.
2. Make sure the electrical supply to your water heater is "ON".
3. Check for loose or blown fuses in your water heater circuit. Circuit breakers weaken with age and may not handle their rated load and should be replaced.
4. Make certain the disconnect switch, if used, is in the "ON" position.
5. Check to see the electric service to your house has not been interrupted. If this is the case, contact the electric company.
6. Are the thermostats set to the desired temperature? See "Temperature Regulation" section.
7. If you had experienced very hot water and now no hot water, the problem may be due to the high temperature shut off system. See "High Temperature Shut Off System" in the "Troubleshooting" section.
8. During very cold weather, the incoming water will also be colder and it will require a longer time to become heated.
9. The hot water usage may exceed the capacity of the water heater. If so, wait for water heater to recover after abnormal demand. Also examine pipes and faucets for possible water leaks.
10. If you can not determine the problem, then call the Maytag Service Department.

## WATER IS TOO HOT

Adjust the thermostat to a lower setting. See the "Temperature Regulation" section.

# Troubleshooting (cont'd)

## Leakage Checkpoints

Use this guide to check a "Leaking" water heater. Many suspected "Leakers" are not leaking tanks. Often the source of the water can be found and corrected.

If you are not thoroughly familiar with electric codes, the water heater, and safety practices, contact your local utility or call Maytag Customer Service at 1-800-788-8899 for an authorized servicer to check the water heater.

- (A) \*Condensation may be seen on pipes in humid weather or pipe connections may be leaking.
- (B) \*The primary anode rod may be leaking.
- (C) Small amounts of water from temperature pressure relief valve may be due to thermal expansion or high water pressure in your area.
- (D) \*The temperature-pressure relief valve may be leaking at the tank fitting.
- (E) The elements may be leaking at the tank fitting.

### ⚠ WARNING

**HAZARD OF ELECTRICAL SHOCK!** Before removing any access panels or servicing the water heater, make sure the electrical supply to the water heater is turned "OFF". Failure to do this could result in DEATH, SERIOUS BODILY INJURY, OR PROPERTY DAMAGE.

Turn electrical power "OFF", remove access panels, insulation blocks and pads. If leaking around elements, follow proper draining instructions and remove element. Reposition or replace gasket on element. Place element into opening and tighten securely. Then follow "Filling the Water Heater" instructions in the "Installation Instructions" section.

- (F) Water from drain valve may be due to the valve being opened slightly.
- (G) \*The drain valve may be leaking at the tank fitting.
- (H) \*Water in the water heater bottom or on the floor may be from condensation, loose connections or the temperature-pressure relief valve. DO NOT replace the water heater until a full inspection of all possible water sources is made and necessary corrective steps taken.

Leakage from other appliances, water lines, or ground seepage should also be checked.

**\*NOTE:** To check where threaded portion enters tank, insert cotton swab between jacket opening and fitting. If cotton is wet, follow "Draining" instructions in the "Service and Maintenance" section and then remove fitting. Put pipe dope or teflon tape on the threads and replace. Then follow "Filling the Water Heater" instructions in the "Instructions for Installation" section.

### ⚠ CAUTION

Read this manual first, then before checking the water heater make sure the electric supply has been turned "OFF", and never turn the electric supply "ON" before the tank is completely full of water.

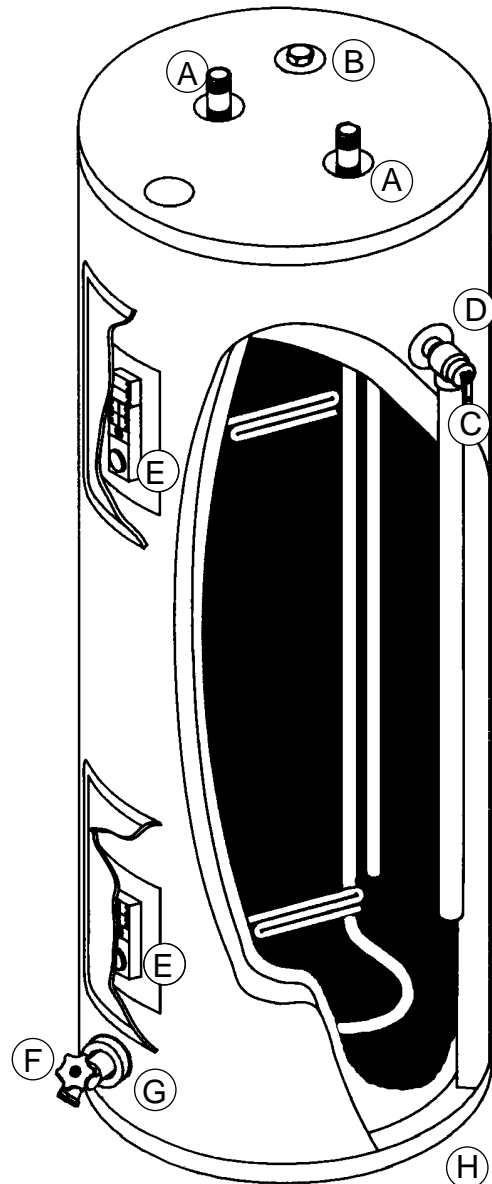



# Notes

# Repair Parts List

## MAYTAG ELECTRIC WATER HEATERS MODEL NUMBERS

HR630SJRT	30 GALLON
HR630SJLS	30 GALLON
HR640SJRT	40 GALLON
HR640SJRS	40 GALLON
HR640SJLS	40 GALLON

### NOTE:

**LOWER ELEMENT:** These water heaters have a 4500 watt lower element as standard. Order part no. 66001875 replacement element.

However, your specific model may be equipped with a nonstandard element. Refer to model rating plate for wattage of a non-standard lower element. Give voltage and element wattage when ordering replacement part.

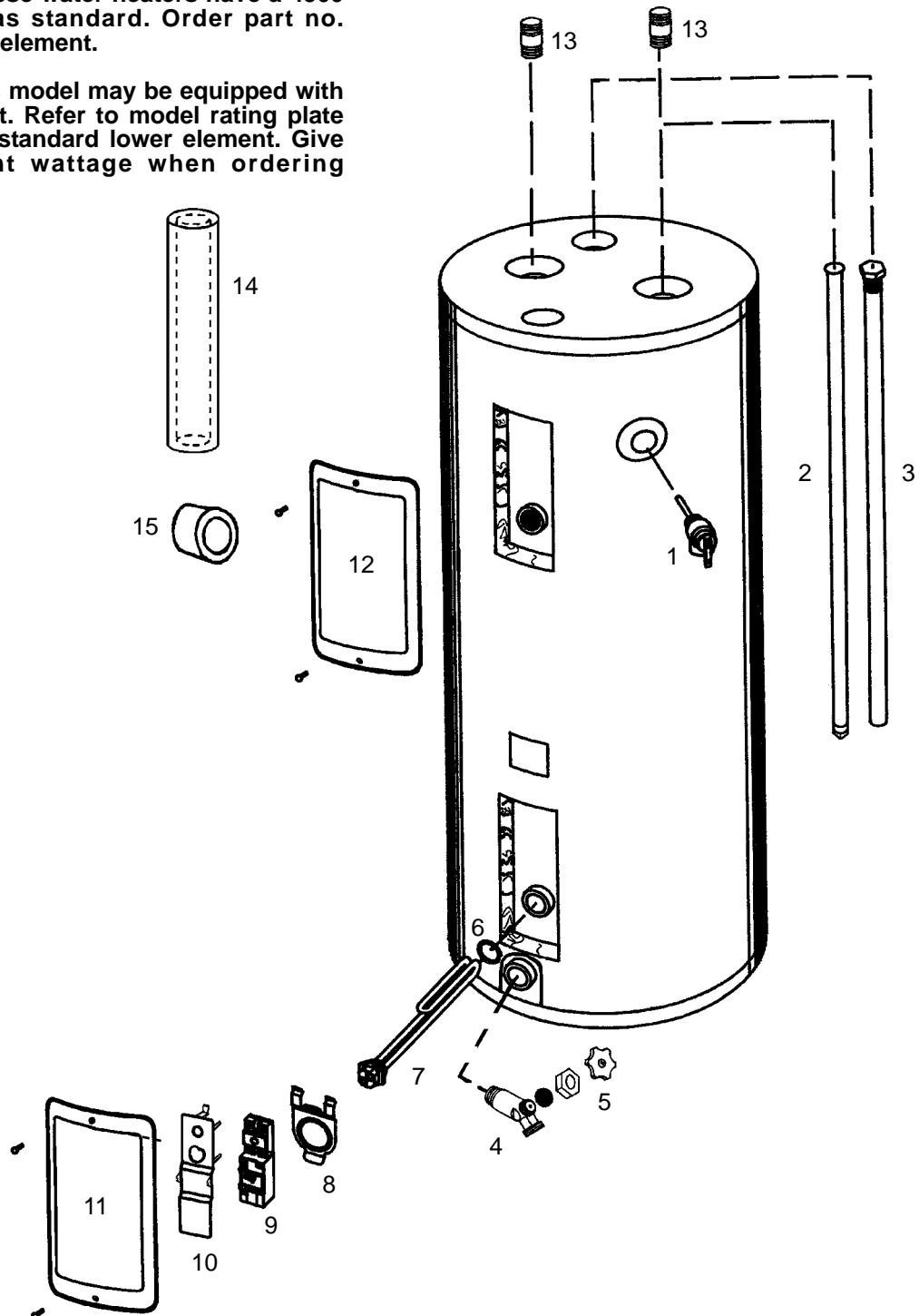

# Repair Parts List (cont'd)

## MAYTAG ELECTRIC WATER HEATERS MODEL NUMBERS

HR630SJRT 30 GALLON  
 HR630SJLS 30 GALLON  
 HR640SJRT 40 GALLON  
 HR640SJRS 40 GALLON  
 HR640SJLS 40 GALLON

KEY NO.	PART DESCRIPTION	MODEL NUMBERS				
		HR630SJRT	HR630SJLS	HR640SJRT	HR640SJRS	HR640SJLS
		PART NUMBERS				
1	Temperature-Pressure Relief Valve	66001700	66001700	66001700	66001700	66001415
2	Dip Tube	66001307	66001870	66001309	66001306	66001303
3	Primary Anode Rod	66001871	66001872	66001832	66001729	66001729
4	Drain Valve	66001246	66001647	66001246	66001246	66001647
5	Drain Valve Washer (17/32"x 13/64"x 1/8" thick)*	66001021	66001021	66001021	66001021	66001021
6	Element Gasket (10 pack)	66001053	66001053	66001053	66001053	66001053
7	Element	<b>SEE NOTE ON PAGE 26</b>				
8	Thermostat Bracket	66001054	66001054	66001054	66001054	66001054
9	Thermostat w/Hi Limit †	66001202	66001202	66001202	66001202	66001202
10	Terminal Cover	66001064	66001064	66001064	66001064	66001064
11	Lower Access Panel	66001703	66001703	66001703	66001703	66001703
12	Upper Access Panel **	—	—	66001703	66001703	—
13	Nipple w/Heat Traps	66001704	66001704	66001705	66001705	66001705
14	Pipe Insulation	66001708	66001708	66001708	66001708	66001708
15	T&P Insulation	66001709	66001709	66001709	66001709	66001709
#	Manual	66001869				

\*Also available at most hardware stores.

†Refer to Wiring Diagram Section for verification.

#Not Illustrated

Now that you have purchased this water heater, should a need ever exist for repair parts or service, simply call Maytag Customer Service at 1-800-788-8899 for an authorized servicer. Be sure to provide all pertinent facts when you call or visit.

The model number of the water heater will be found on the model rating plate located above the access panel.

### WHEN ORDERING REPAIR PARTS, ALWAYS GIVE THE FOLLOWING INFORMATION:

**Model Number**  
**Serial Number**  
**Part Description**  
**Part Number**  
**Voltage and Element Wattage**

**THIS IS A REPAIR PARTS LIST, NOT A PACKING LIST.**

# Repair Parts List (cont'd)

## MAYTAG ELECTRIC WATER HEATERS MODEL NUMBERS

HR652SJRT	50 GALLON
HR650SJRS	50 GALLON
HR650SJLS	50 GALLON
HR666SJRT	66 GALLON
HR682SJRT	80 GALLON
HR6120SJRT	119 GALLON

### NOTE:

**LOWER ELEMENT:** These water heaters have a 4500 watt lower element as standard. Order part no. 66001875 replacement element.

However, your specific model may be equipped with a nonstandard element. Refer to model rating plate for wattage of a non-standard lower element. Give voltage and element wattage when ordering replacement part.

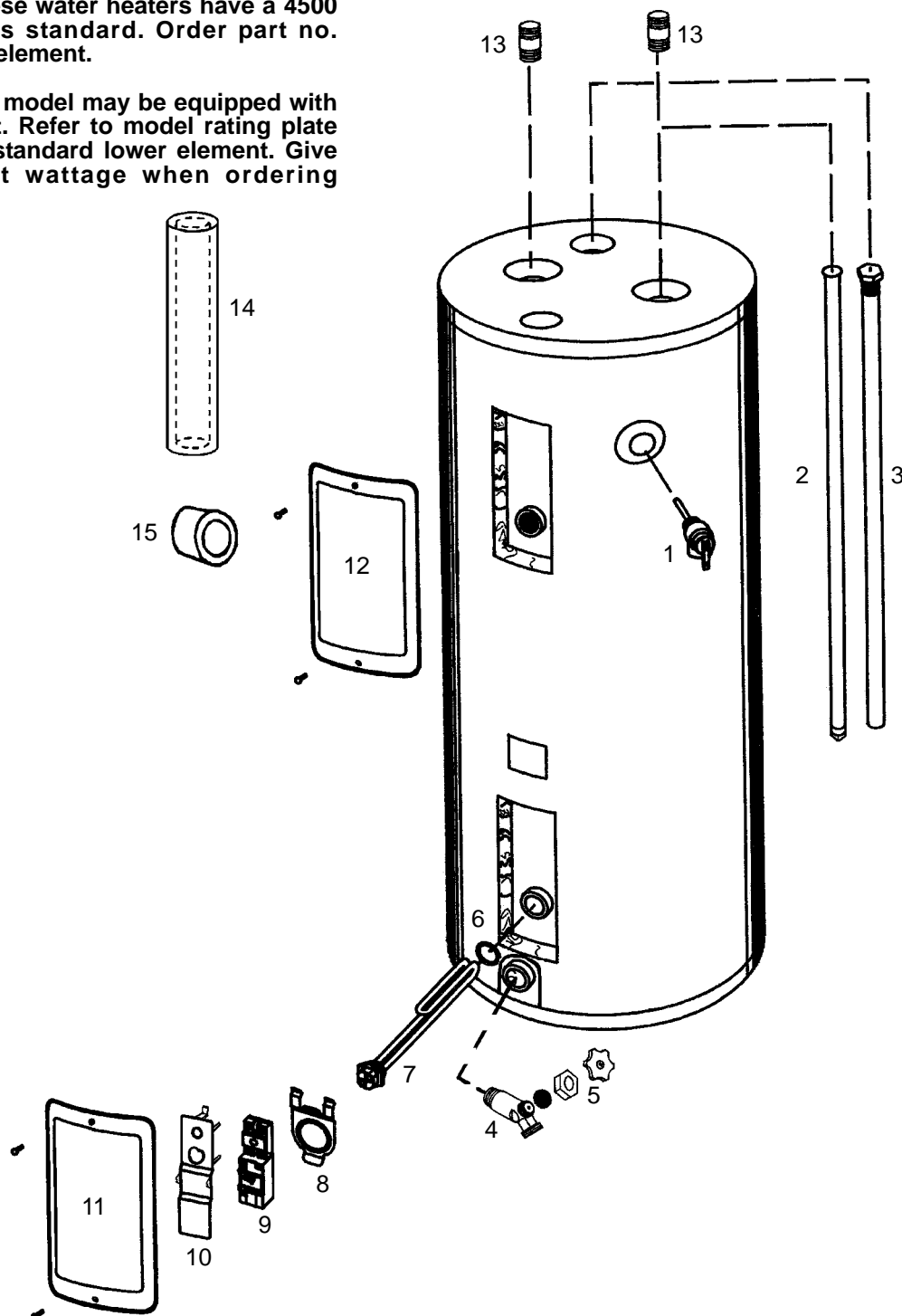

# Repair Parts List (cont'd)

## MAYTAG ELECTRIC WATER HEATERS MODEL NUMBERS

HR652SJRT	50 GALLON
HR650SJRS	50 GALLON
HR650SJLS	50 GALLON
HR666SJRT	66 GALLON
HR682SJRT	80 GALLON
HR6120SJRT	119 GALLON

KEY NO.	PART DESCRIPTION	MODEL NUMBERS				
		HR652SJRT	HR650SJRS	HR650SJLS	HR666SJRT HR682SJRT	HR6120SJRT
		PART NUMBERS				
1	Temperature-Pressure Relief Valve	66001700	66001700	66001682	66001700	66001700
2	Dip Tube	66001874	66001307	66001303	†† 66001309	66001309
3	Primary Anode Rod	66001730	66001730	—	66001731	66001873
4	Drain Valve	66001246	66001246	66001647	66001246	66001246
5	Drain Valve Washer (17/32"x 13/64"x 1/8" thick)*	66001021	66001021	66001021	66001021	66001021
6	Element Gasket (10 pack)	66001053	66001053	66001053	66001053	66001053
7	Element	<b>SEE NOTE ON PAGE 28</b>				
8	Thermostat Bracket	66001054	66001054	66001054	66001054	66001054
9	Thermostat w/Hi Limit †	66001202	66001202	66001202	66001202	66001202
10	Terminal Cover	66001064	66001064	66001064	66001064	66001064
11	Lower Access Panel	66001703	66001703	66001703	66001703	66001703
12	Upper Access Panel **	66001703	66001703	66001703	66001703	66001703
13	Nipple w/Heat Traps	66001705	66001707	66001704	—	—
13	Nipple w/o Heat Traps	—	—	—	††† 66001736	66001737
14	Pipe Insulation	66001708	66001708	66001708	66001708	66001708
15	T&P Insulation	—	66001709	66001709	—	—
#	Manual	66001869				

\*Also available at most hardware stores.

\*\* Not on Model

†Refer to Wiring Diagram Section for verification.

††66001309 for Model HR682

†††66001735 for Model HR682

#Not Illustrated

Now that you have purchased this water heater, should a need ever exist for repair parts or service, simply call Maytag Customer Service at 1-800-788-8899 for an authorized servicer. Be sure to provide all pertinent facts when you call or visit.

The model number of the water heater will be found on the model rating plate located above the access panel.

### WHEN ORDERING REPAIR PARTS, ALWAYS GIVE THE FOLLOWING INFORMATION:

- Model Number
- Serial Number
- Part Description
- Part Number (if available)
- Voltage and Element Wattage

**THIS IS A REPAIR PARTS LIST, NOT A PACKING LIST.**

# Repair Parts List (cont'd)

## MAYTAG ELECTRIC WATER HEATERS MODEL NUMBERS

HR630DJRT	30 GALLON
HR630DJLS	30 GALLON
HR640DJRT	40 GALLON
HR640DJRS	40 GALLON
HR640DJLS	40 GALLON

### NOTE:

**LOWER ELEMENT and UPPER ELEMENT:** These water heaters have 4500 watt lower and upper elements as standard. Order part no. 66001875 replacement element.

However, your specific model may be equipped with nonstandard elements. Refer to model rating plate for wattage of non-standard lower and upper elements. Give voltage and element wattage when ordering replacement parts.

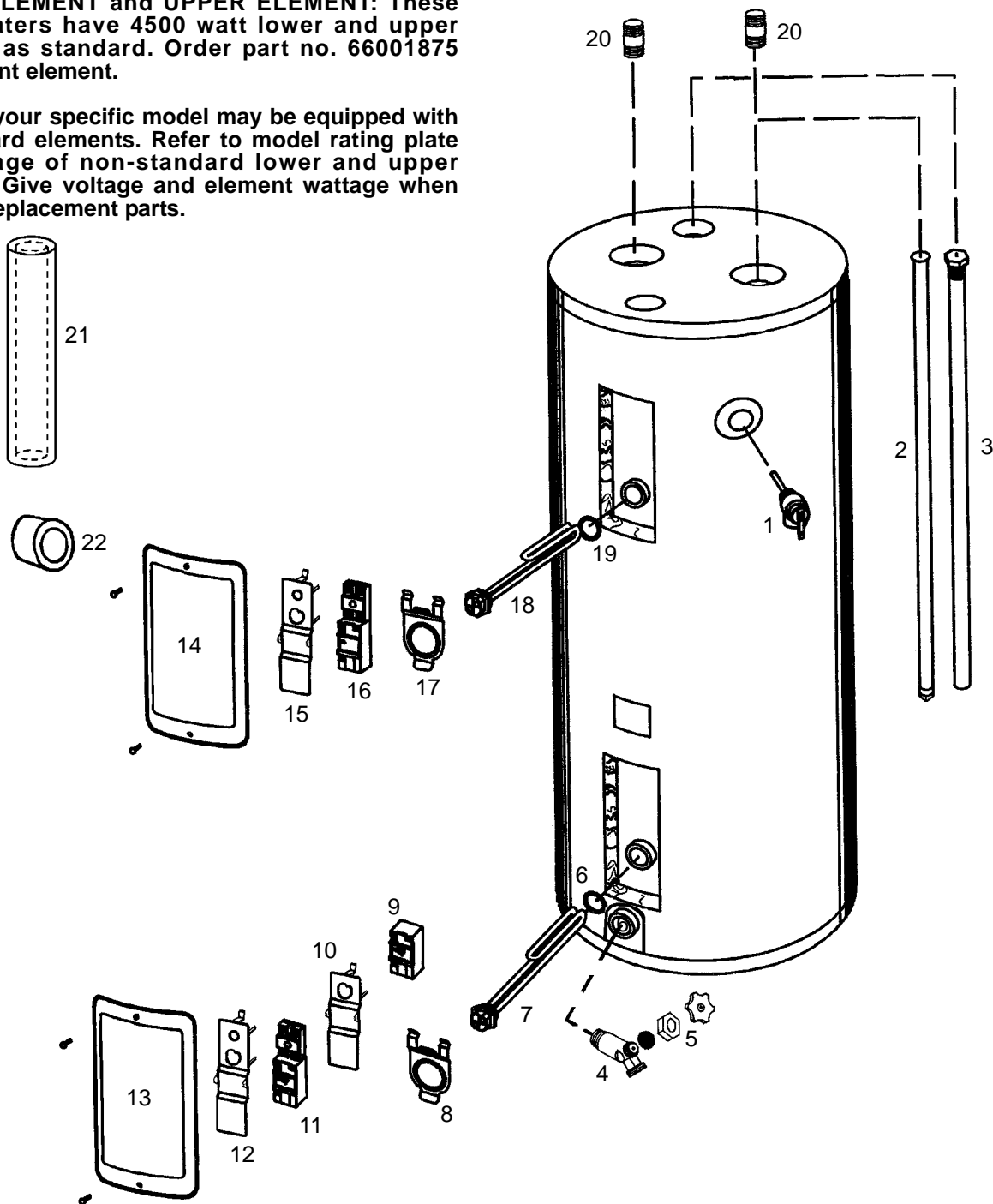

# Repair Parts List (cont'd)

## MAYTAG ELECTRIC WATER HEATERS MODEL NUMBERS

HR630DJRT	30 GALLON
HR630DJLS	30 GALLON
HR640DJRT	40 GALLON
HR640DJRS	40 GALLON
HR640DJLS	40 GALLON

KEY NO.	PART DESCRIPTION	MODEL NUMBERS				
		HR630DJRT	HR630DJLS	HR640DJRT	HR640DJRS	HR640DJLS
		PART NUMBERS				
1	Temperature-Pressure Relief Valve	66001700	66001700	66001700	66001700	66001682
2	Dip Tube	66001307	66001870	66001309	66001306	66001303
3	Primary Anode	66001871	66001872	66001832	66001729	66001729
4	Drain Valve	66001246	66001647	66001246	66001246	66001647
5	Drain Valve Washer (17/32"x 13/64"x 1/8" thick)*	66001021	66001021	66001021	66001021	66001021
6	Element Gasket (10 pack)	66001053	66001053	66001053	66001053	66001053
7	Lower Element	<b>SEE NOTE ON PAGE 30</b>				
8	Thermostat Bracket	66001054	66001054	66001054	66001054	66001054
9	2 Pole Thermostat (Two Wire Lead Models)†	66001201	66001201	66001201	66001201	66001201
10	Terminal Cover (Lower)	66001268	66001268	66001268	66001268	66001268
11	Lower Thermostat w/Hi Limit (Three Wire Lead Models)†	66001202	66001202	66001202	66001202	66001202
12	Terminal Cover (Lower Three Wire)	66001064	66001064	66001064	66001064	66001064
13	Lower Access Panel	66001703	66001703	66001703	66001703	66001703
14	Upper Access Panel	66001703	66001703	66001703	66001703	66001703
15	Terminal Cover (Upper)	66001064	66001064	66001064	66001064	66001064
16	Upper Thermostat w/Hi Limit	66001254	66001254	66001254	66001254	66001254
17	Thermostat Bracket	66001054	66001054	66001054	66001054	66001054
18	Upper Element	<b>SEE NOTE ON PAGE 30</b>				
19	Element Gasket (10 pack)	66001053	66001053	66001053	66001053	66001053
20	Nipple w/Heat Traps	66001704	66001704	66001705	66001705	66001705
21	Pipe Insulation	66001708	66001708	66001708	66001708	66001708
22	T&P Insulation	66001709	66001709	66001709	66001709	66001709
#	Manual	66001869				

\*Also available at most hardware stores.

†Refer to Wiring Diagram Section for verification.

#Not Illustrated

Now that you have purchased this water heater, should a need ever exist for repair parts or service, simply call Maytag Customer Service at 1-800-788-8899 for an authorized servicer. Be sure to provide all pertinent facts when you call or visit.

The model number of the water heater will be found on the model rating plate located above the access panel.

### WHEN ORDERING REPAIR PARTS, ALWAYS GIVE THE FOLLOWING INFORMATION:

**Model Number**  
**Serial Number**  
**Part Description**  
**Part Number (if available)**  
**Voltage and Element Wattage**

**THIS IS A REPAIR PARTS LIST, NOT A PACKING LIST.**

# Repair Parts List (cont'd)

## MAYTAG ELECTRIC WATER HEATERS MODEL NUMBERS

HR652DJRT	50 GALLON
HR650DJRS	50 GALLON
HR650DJLS	50 GALLON
HR666DJRT	66 GALLON
HR682DJRT	80 GALLON
HR6120DJRT	119 GALLON

### NOTE:

**LOWER ELEMENT and UPPER ELEMENT:** These water heaters have 4500 watt lower and upper elements as standard. Order part no. 66001875 replacement element.

However, your specific model may be equipped with nonstandard elements. Refer to model rating plate for wattage of non-standard lower and upper elements. Give voltage and element wattage when ordering replacement parts.

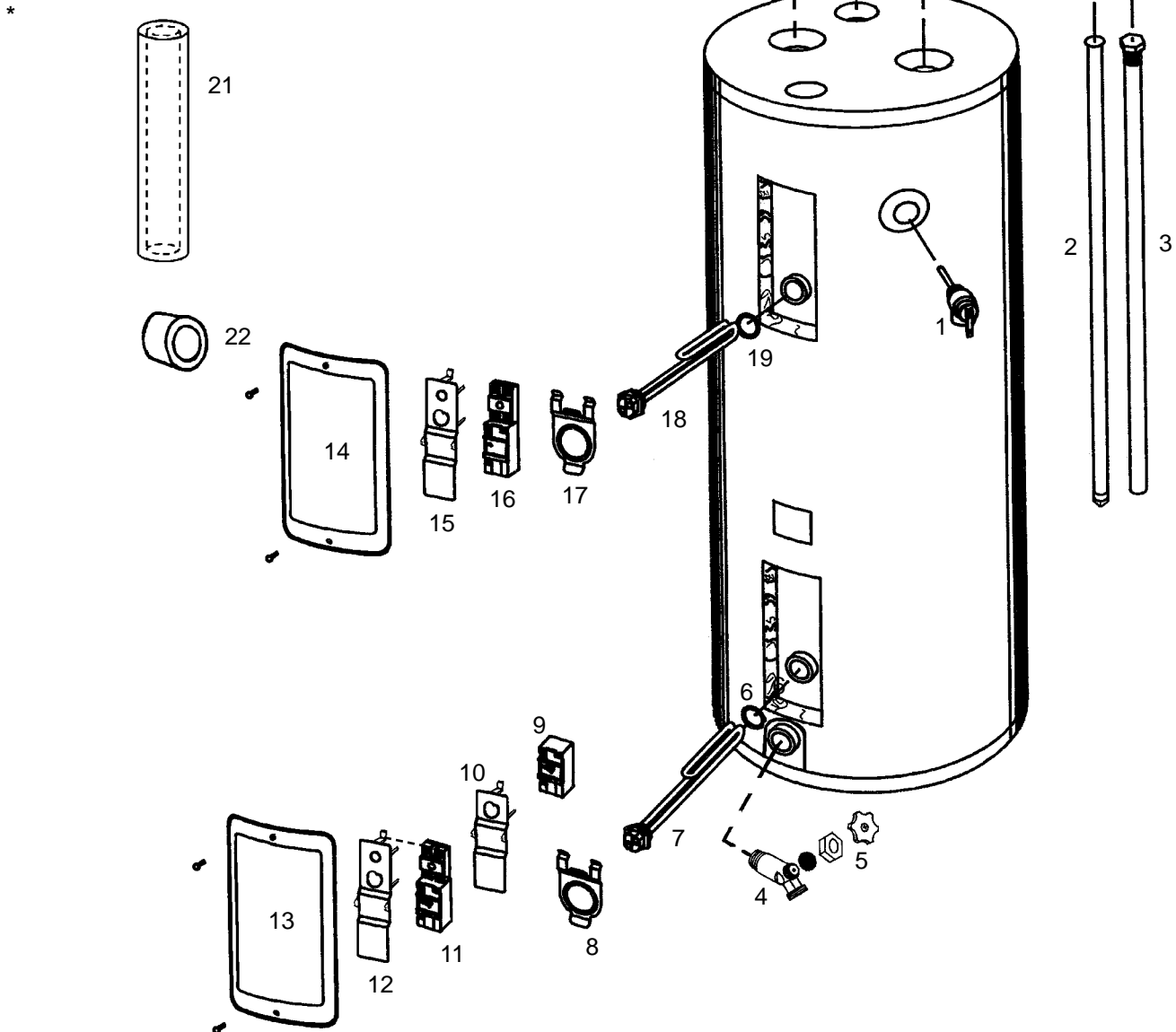



# Repair Parts List (cont'd)

## MAYTAG ELECTRIC WATER HEATERS MODEL NUMBERS

HR652DJRT	50 GALLON
HR650DJRS	50 GALLON
HR650DJLS	50 GALLON
HR666DJRT	66 GALLON
HR682DJRT	80 GALLON
HR6120DJRT	119 GALLON

KEY NO.	PART DESCRIPTION	MODEL NUMBERS				
		HR652DJRT	HR650DJRS	HR650DJLS	HR666DJRT HR682DJRT	HR6120DJRT
		PART NUMBERS				
1	Temperature-Pressure Relief Valve	66001700	66001700	66001682	66001700	66001700
2	Dip Tube	66001874	66001307	66001303	†† 66001309	66001309
3	Primary Anode	66001730	66001730	66001729	66001731	66001873
4	Drain Valve	66001246	66001246	66001647	66001246	66001246
5	Drain Valve Washer (17/32"x 13/64"x 1/8" thick)*	66001021	66001021	66001021	66001021	66001021
6	Element Gasket (10 pack)	66001053	66001053	66001053	66001053	66001053
7	Lower Element	<b>SEE NOTE ON PAGE 32</b>				
8	Thermostat Bracket	66001054	66001054	66001054	66001054	66001054
9	2 Pole Thermostat (Two Wire Lead Models)†	66001201	66001201	66001201	66001201	66001201
10	Terminal Cover (Lower)	66001268	66001268	66001268	66001268	66001268
11	Lower Thermostat w/Hi Limit (Three Wire Lead Models)†	66001202	66001202	66001202	66001202	66001202
12	Terminal Cover (Lower Three Wire)	66001064	66001064	66001064	66001064	66001064
13	Lower Access Panel	66001703	66001703	66001703	66001703	66001703
14	Upper Access Panel	66001703	66001703	66001703	66001703	66001703
15	Terminal Cover (Upper)	66001064	66001064	66001064	66001064	66001064
16	Upper Thermostat w/Hi Limit	66001254	66001254	66001254	66001254	66001254
17	Thermostat Bracket	66001054	66001054	66001054	66001054	66001054
18	Upper Element	<b>SEE NOTE ON PAGE 32</b>				
19	Element Gasket (10 pack)	66001053	66001053	66001053	66001053	66001053
20	Nipple w/Heat Traps	—	66001707	66001744	—	—
20	Nipple w/o Heat Traps	66001734	—	—	††† 66001736	66001737
21	Pipe Insulation	66001708	66001708	66001708	66001708	66001708
22	T&P Insulation	—	66001709	66001709	—	—
#	Manual	66001869				

\*Also available at most hardware stores.

†Refer to Wiring Diagram Section for verification.

††66001309 for Model HR682

†††66001735 for Model HR682

#Not Illustrated

Now that you have purchased this water heater, should a need ever exist for repair parts or service, simply call Maytag Customer Service at 1-800-788-8899 for an authorized servicer. Be sure to provide all pertinent facts when you call or visit.

The model number of the water heater will be found on the model rating plate located above the access panel.

### WHEN ORDERING REPAIR PARTS, ALWAYS GIVE THE FOLLOWING INFORMATION:

**Model Number**  
**Serial Number**  
**Part Number (if available)**  
**Part Description**  
**Voltage and Element Wattage**

**THIS IS A REPAIR PARTS LIST, NOT A PACKING LIST.**

# Repair Parts List (cont'd)

## MAYTAG ELECTRIC WATER HEATERS

MAYTAG/STATE PART NUMBER CONVERSION KEY	
MAYTAG	STATE
66001011	9001609
66001012	9001608
66001013	ETC2X
66001014	ETC5X
66001021	9001584
66001053	9000308
66001054	9000309
66001064	9002438
66001068	9001453
66001105	9002769
66001182	9000092
66001201	9000507
66001202	9000509
66001246	9001588
66001254	9001954
66001268	9002276
66001303	9002542
66001306	9002546
66001307	9002547
66001309	9002549
66001415	9001583
66001647	9003464
66001682	9003741
66001700	9003917
66001703	9003900
66001704	9003915
66001705	9003719
66001707	9003909
66001708	9003717
66001709	9003716
66001710	184740-001
66001729	9003889
66001730	9003972
66001732	9003973
66001735	9003975
66001736	9003976
66001737	9003977
66001734	9003974
66001744	9003921
66001832	9003891
66001870	9003663
66001871	9003888
66001872	9003944
66001873	9003893
66001874	9004261
66001875	9003950

# Notes

# Warranty

## **FULL ONE YEAR WARRANTY**

For One Year from the date of Original Retail Purchase, any part which fails in normal home use will be repaired or replaced free of charge.

If a leak occurs in the Tank, a new water heater of the closest capacity and quality then available, will be replaced free of charge.

The warranty of the replacement is the balance of the original water heater's Warranty.

## **LIMITED PARTS WARRANTY**

After the First year and through the Sixth Year from the date of Original Retail Purchase, any Parts which fail due to a defect in materials or workmanship, will be replaced or repaired free of charge for the part itself, with the owner paying all other costs, including labor, mileage and transportation.

If the water heater is subjected to commercial, institutional, industrial or non-residential use, the above warranty coverage for parts that are proved to be defective in material or workmanship is effective for one year from the date of the Original Retail Purchase.

The warranty of the replacement is the balance of the original water heater's Warranty, or twelve months from the date of the part(s) purchase, whichever comes first.

The warranty is limited to the original owner of the water heater.

## **LIMITED TANK WARRANTY AGAINST LEAKS**

After the First Year and through the Sixth Year from the date of Original Retail Purchase, if a leak occurs in the Tank, a new water heater of the closest capacity and quality then available, will be replaced free of charge for the water heater, with the owner paying all other costs, including labor, mileage and transportation.

If the water heater is subjected to commercial, institutional, industrial or non-residential use, the above warranty coverage for tanks that are proven to be defective in material or workmanship is effective for two years from the date of the Original Retail Purchase.

The warranty of the replacement is the balance of the original water heater's Warranty.

Please note: The Full and Limited Warranty applies only while this water heater is used in the United States of America.

The warranty is limited to the original owner of the water heater.

## **TO RECEIVE WARRANTY SERVICE**

To locate an authorized service company in your area contact the Maytag dealer from whom your appliance was purchased; or call Maytag Customer Service at the number listed below. Should you not receive satisfactory warranty service, please call or write:

Maytag Customer Service  
P.O. Box 2370  
Cleveland, TN 37320-2370  
U.S.A. 1-800-788-8899

When contacting Maytag Customer Service be sure to provide the Model and Serial Number of your appliance, The Name and Address of the Dealer from whom you purchased the appliance and the Date of Purchase.

MAYTAG WATER HEATERS ARE MANUFACTURED AND THIS WARRANTY PROVIDED BY STATE INDUSTRIES, INC., ASHLAND CITY, TN. MAYTAG IS A TRADEMARK OF MAYTAG CORPORATION AND IS USED UNDER LICENSE TO STATE INDUSTRIES, INC.

## Free Manuals Download Website

<http://myh66.com>

<http://usermanuals.us>

<http://www.somanuals.com>

<http://www.4manuals.cc>

<http://www.manual-lib.com>

<http://www.404manual.com>

<http://www.luxmanual.com>

<http://aubethermostatmanual.com>

Golf course search by state

<http://golfingnear.com>

Email search by domain

<http://emailbydomain.com>

Auto manuals search

<http://auto.somanuals.com>

TV manuals search

<http://tv.somanuals.com>