

Operating Instructions

Washing Machine

*Dear Maytag customer,
Thank you for choosing this quality product from
Scandinavia, made in Vara, Sweden.*

*We want you to feel assured that the inside of your new
machine is just as good as the outside and that the ethics and
standards that went into the production of this machine are
just as high as the quality and performance that you will
receive from it. We hope that this product will give you many
years of pleasure.*

*To get the most out of your new machine, we recommend that
you read the installation and operating instructions before
using the machine.*

MAF9501



Contents

Contents	2	Care and cleaning	14
Before using your machine for the first time	3	Checking the filter and drainage pump	14
Transport protection	3	Cleaning the detergent compartment	14
Packing material	3	Cleaning the outside of the machine	14
Washer door	3	Cleaning the inside of the machine	14
Checking water hardness	3	Rinse holes under the agitator	15
Safety instructions	4	If you have hard water	15
General	4	Troubleshooting	16
Installation	4	The washer door will not open	16
Overflow guard function	4	The machine will not start	16
Transport/Winter storage	4	Error messages	16
Disposal	4	Technical information	18
Child safety	5	Technical data	18
Automatic door opening	5	Standard tests	18
Parts of the washing machine	6	Transport protection	19
Detergent compartment	6	Installation	20
Options buttons	7	Positioning the washing machine	20
Advice and tips before washing	8	Adjusting the feet	20
Sorting laundry	8	Connection to water supply	20
Clothing	8	Drainage connection	20
Laundry labels	8	Electrical installation	21
Coloured cotton	8	Programme plate in multiple languages	21
Delicates	8	Service	22
Laundry label symbols	8	Before contacting the service division	22
Wool and silk	9	Search words	23
Artificial fibres and synthetic fibres	9	Quick guide	24
Reducing allergic reactions	9		
Dyeing fabrics	9		
Washing	10		
Sort laundry	10		
Turn on the main power switch	10		
Open the washer door and load the washing	10		
Add detergent and fabric softener, as required	10		
Select programme	11		
Programme chart	11		
Select options and settings	12		
Close the door and press Start	13		
Once the programme has finished	13		

Before using your machine for the first time

Transport protection

Has the transport protection been removed? If not, see the “Transport protection” chapter.

Packing material

Sort waste in accordance with local guidelines.

Washer door

The washer door cannot be opened until the machine is connected to the electricity supply.

To open the door manually, see the section entitled “The door will not open” in the “Troubleshooting” chapter.

It is not possible to start the machine with the door open.

To open the door during an ongoing programme, see the section entitled “Close the door and press Start”.

Checking water hardness

The quantity of detergent required depends on water hardness, among other things.

Phone your local Water Board to check the water hardness in your area.

Safety instructions



General

- Read and keep the operating instructions!
- Installation of water and electricity, if required, should be carried out by a qualified professional.
- The machine should only be used for washing items as described in these instructions - it is not intended for dry cleaning!
- Use only detergent intended for machine washing!
- Remove any transport protection devices before using the machine (see the “Transport protection” chapter).
- Repairs and maintenance relating to safety or performance must be carried out by a qualified professional.

Installation

See the “Installation” chapter.

Overflow guard function

If the machine’s water level rises above the normal level, the overflow guard function begins to pump water out and shuts off the water intake. If the water level has not dropped within 60 seconds, the programme is terminated.

Transport/ Winter storage

If the machine is to be transported or stored in unheated premises where the temperature can fall below freezing, do as follows:

- Empty the filter and drainage pump (see the “Care and cleaning” chapter).
- Shut off the water to the washing machine, loosen the supply hose to the intake valve and let the water run out from the valve and hose.

Disposal

When the machine has reached the end of its service life and is to be disposed of, it should immediately be made unusable. Contact your local authority for information about where your machine should be disposed of and recycled in the proper way. The machine is manufactured and labelled for recycling.



Keep an eye on children!

Always close the door and start the programme immediately once you have added detergent.

Do not allow small children to use or play with the washing machine.

Store detergent and fabric softener out of the reach of children!

Automatic door opening

The machine comes with an automatic door opening function, which means that the door opens automatically once the programme has finished.

If you wish to prevent small children or pets from climbing into the machine, you can deactivate the automatic door opening function.

1. Turn off the machine using the main power switch.
2. Press the Door Open button while simultaneously pressing the main power switch. Release the buttons.
3. Press the Key button and the red fields go out. Automatic door opening is now deactivated.
4. Press the Start/Stop button to store the setting.

If you want to reactivate the function, follow the instructions above, but when you press the Key button (point 3) the red fields light up. Store the setting by pressing the Start/Stop button.

Parts of the washing machine

1. Detergent compartment
2. Main power switch
3. Programme panel
4. Type plate
5. Hatch - drainage pump
6. Drainage pump (behind hatch)
7. Washer door
8. Outer door (not all models)

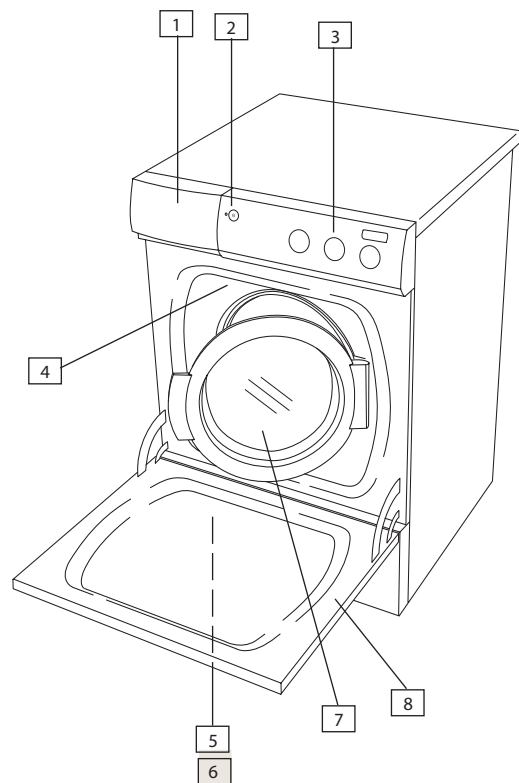

Detergent compartment

1. Detergent compartment - pre-wash
2. Detergent compartment - main wash
3. Fabric softener compartment

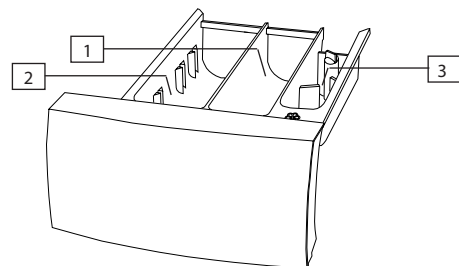

Front panel

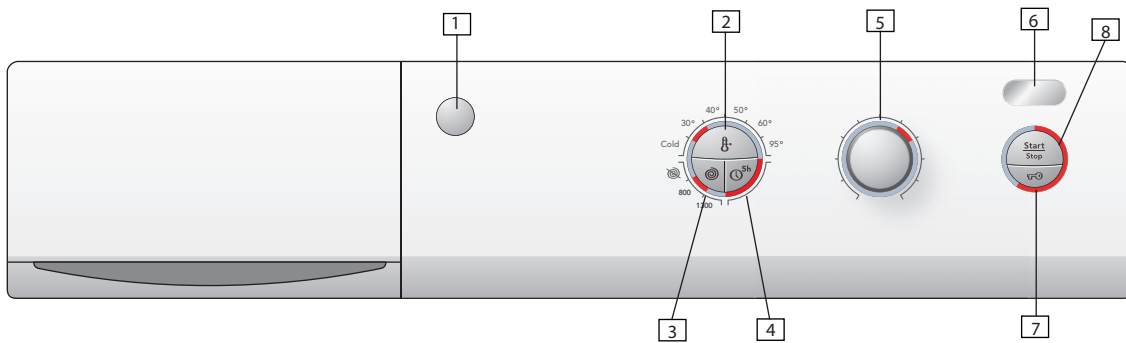

- 1. Main power switch
- 2-4. Options buttons
- 5. Programme selector
- 6. Display window

- 7. Door opening
- 8. Start/Stop

Options buttons

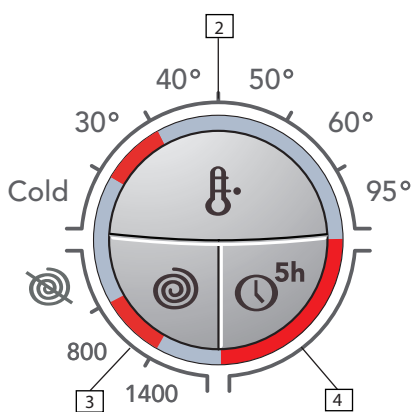

- 2. Button for selecting Temperature
- 3. Button for selecting Spin speed
- 4. Button for selecting Delayed Start

Advice and tips before washing

Here are some tips that may help you before washing.

Sorting your laundry

Sort items according to:

- how soiled they are
- colour
- material

Clothing

- Do up zips so that they don't harm fabrics.
- New coloured items may contain excess dye and should therefore be washed separately the first few times.
- Turn delicate items inside out. This reduces the risk of burling and fading.
- Empty pockets and wash them inside out if possible!

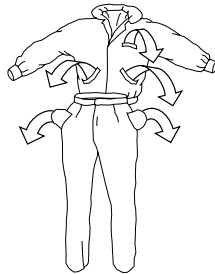

Laundry labels

Look at the item's laundry label. The table below indicates suitable wash programmes for various materials and wash loads.

Coloured cotton

Coloured cotton items labelled for hot washing (60°C) should be washed at 60°C the first time in order to remove any excess dye. If you do not do so, there is a risk that the colour will run. Use detergent without bleach in order to preserve the colour of the fabric.

Delicates

Unbleached linen

Unbleached linen fabrics should be washed at 60°C, using detergent containing no bleach or optical whiteners. Heavily-soiled linen can occasionally be washed at higher temperatures, but not too often since the heat can destroy the linen's shine and strength.

Laundry label symbols

Laundry labels



Cotton, linen, white and light-coloured items.

Programme

White Cotton 60° to 95°

Load

1/1 drum



Cotton, linen. Dark-coloured items.

Coloured Cottons 60°

1/1



Polyester, cotton/polyester, nylon. White items.

Synthetic 60°

1/2



Rayon, acetate, acrylic. Non-colourfast items.

Synthetic 40°

1/2



Polyester, cotton/polyester, nylon. Coloured items.

Synthetic 40°

1/2



Silk and very delicate items

Synthetic 30°

1/3



Items labelled with the IWS or Superwash mark

Wool/Hand 40° 1/3



Wool and silk

These fabrics are sometimes labelled as machine washable and sometimes as hand wash. The machine's Wool/Hand programme is at least as gentle as washing by hand.

Wool is especially sensitive to processes such as washing. If you do not want to spin it, you can squeeze out the water using terry towels. In this case select No spin. To find out how to select this setting, see the "Washing" chapter. However, most items can stand a short spin. Select short spin by selecting spin speed 800 rpm.

Artificial fibres and synthetic fibres

These materials require plenty of room if they are not to become wrinkled. Only fill the drum half way when washing artificial or synthetic fibres. Select short spin by selecting a spin speed of 800 rpm.

Note!

Viscose and acetates are fragile when wet.

Economy and efficiency

You can save a lot of energy by not using more intensive programmes than necessary.

- Select Quick if you just need to freshen up shirts or exercise clothes, for example. This will save both water and energy.
- If you select a fast spin speed, this reduces energy consumption when drying in a tumble dryer or airing cupboard.

Note!

When using agents for bleaching or stain removal, there is a risk of rust (corrosion) and discolouration of the machine.

Environmental concerns also lead us to discourage the use of strong chemicals.



Washing

1 Sort your laundry

See the Advice and Tips section before washing.

Note!

Empty pockets. Coins, nails and the like can cause damage to the machine and fabrics.

2 Turn on the main power switch

3 Open the washer door and load the washing

If the door is closed, press the Key button (door open). The red field lights up and the door opens after a few seconds. Load the laundry. The laundry programme chart shows how much laundry can be washed with each programme.

4 Add detergent and fabric softener, as required

The detergent packaging will have recommendations for how much detergent you should use. The machine holds 6.0 kg of laundry. If you only have a small amount of washing in the machine, you can reduce the amount of detergent used.

Powder detergent

Pour the powder into the compartment for the main wash, and pre-wash as well if desired.

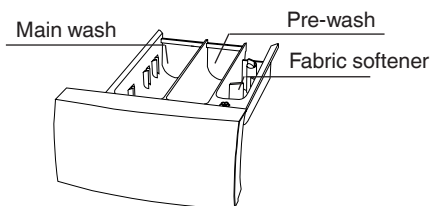

Liquid detergent

When using liquid detergent, follow the detergent manufacturer's recommendations.

Wash ball or net

If you use a wash ball or net, place it directly in the drum and select a programme without pre-wash.

Note!

Detergent overdosing does not give better washing results, but merely causes a greater impact on the environment.

Try to use less detergent, and increase only if you are not satisfied with the results.

Fabric softener

Pour the fabric softener into the compartment with the  symbol. Use the dosage given in the recommendations on the fabric softener package.

Note!

Do not fill above the compartment's maximum fill level. Otherwise fabric softener will run in too early, which impairs the washing effect.

5 Select programme

You can select a programme by turning the programme selector. A red field lights up beside the selected programme, and the estimated programme time is shown in the display window. Start by pressing the Start/Stop button, or go on to Options and Settings. Guidelines as to what specific programmes can be used for.

Heavy Cotton

Use this programme for heavily-soiled laundry. You only need to use the maximum temperature, 95 °C, if the laundry is **very** heavily soiled.

White Cotton

This programme is equivalent to the Heavy Cotton programme, but without a pre-wash. To be used for heavily-soiled whites where 60 °C is an adequate temperature.

Cotton Eco

Normally-soiled sheets, pillowcases and towels will come clean at 60 °C.

Coloured Cottons

Garments worn next to the skin should be washed at 60 °C. Lightly-soiled laundry can be washed at 40 °C. Most detergents today clean even at 40 °C.

Quick

Lightly-soiled laundry that only needs freshening up can be washed in a short time at 40 °C.

Synthetic

This programme is good for shirts and blouses of synthetic and blended material. Wash white items at 60 °C and coloured items at 40 °C.

WoolHand

This programme is used for items marked as Wool and/or Hand wash only.

Maximum temperature is 40 °C, and the programme has a short spin.

Rinse

This programme performs one rinse cycle + spin. Good for cleaning cloths and mops.

Spin or Drain

To be used when you only want to spin the load or drain the water from the machine.

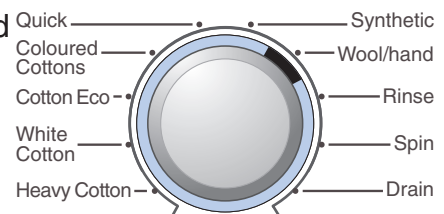

Programme chart

Programme	Pre-wash	Main wash	Temp. °C	Rinses (number)	Short spin (number)	Final spin	Max. RPM	Max. load	Water consumption (approx. litres)	Energy consumption (approx. kWh)	Programme time (approx. min)
Heavy Cotton	Yes	Long	95	5	3	Long	1400	1/1	65	2.20	170
White Cotton*	No	Long	60	3	3	Long	1400	1/1	54	1.14	130
Cotton Eco	No	Short	60	3	3	Long	1400	1/1	54	1.00	90
Coloured Cottons	No	Short	40	3	3	Long	1400	1/1	54	0.50	70
Quick	No	Short	40	2	0	Long	1400	1/2	22	0.30	35
Synthetic	No	Short	40	3	0	Short	800	1/2	30	0.30	65
Wool/Hand	No	Short	30	3	0	Short	800	1/3	54	0.30	40
Rinse				1	0	Long	1400	1/1	9	0.05	16
Spin					0	Long	1400	1/1		0.05	11

* Programme tested in accordance with EN 60456/A11/A12/A13

6 Select options and settings

By adjusting options and settings you can tailor washing programmes to suit your own laundry requirements.

The machine remembers which settings and options you choose for each programme and uses these the next time you select the programme in question. Naturally, you can change the selection if you wish.

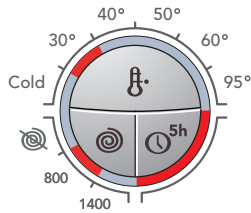

Temperature

Select temperature by pressing the Temperature button until the red field lights up beside the desired temperature.

You can select temperatures between 30 °C and 95 °C or C. If you select C, the washing temperature will be the same as that of the water entering the machine.

For Wool/Hand, it is not possible to select a temperature in excess of 40°C (see the table).

Spin speed/No spin

Select spin speed by pressing the Spin button until the red field lights up beside the desired spin speed.

You can choose from No spin, 800 rpm and 1200 rpm.

Spin at 800 rpm always signifies short spin. For certain programmes, it is not possible to select a speed in excess of 800 rpm (see the table).

No spin means that the programme does not include a spin cycle and ends by draining.

Delayed Start

When you select Delayed Start, the machine will start 5 hours after you press:

- Delayed Start button, followed by
- Start/Stop button.

The figure '5' in the display and a lighted red field next to the button indicate that the option has been activated. The number of hours until start will be shown by a countdown from 5 to 1. To cancel the delayed start, press the Start/Stop button for 3 seconds. The red field goes out. To start the machine without Delayed Start, select a programme and press the Start/Stop button.

Important!

Remember to press Delayed Start followed by the Start/Stop button to start the programme.

7 Close the door and press the Start/Stop button

Time remaining

The time remaining is shown in hours and minutes.

Once a programme has been selected, an estimated running time for the complete programme is displayed. This may differ from time to time depending on the temperature of the water entering the machine and the size of the load. During the actual programme the time counts down in minutes. If the programme time is longer than a previous wash with the same programme, “1” will be displayed until the programme is finished.

To add or remove washing after the programme starts

If you want to add or remove items after the programme has started, you can stop the programme by pressing and holding the Key button (door open) for three seconds. The red field flashes. When restarting, add any extra detergent needed and close the door. The machine starts automatically from the point where the programme was interrupted.

If you want to stop or change a programme

You can also stop a programme by pressing the Start/Stop button for three seconds. To restart the machine, select a new programme, add any new detergent needed and press the Start/Stop button.

8 Once the programme has finished

Once a programme is finished, “End” is shown in the display.

The door opens automatically once the programme has finished. If you want to deactivate “automatic door opening”, see the “Child safety” chapter.

- Remove the laundry.
- Switch off the main power switch.

If you have small children or pets at home, close the washer door once you have removed the laundry.

Care and cleaning

Checking the filter and drainage pump

The washing machine has a filter, where coins, hairpins and the like can get caught. To clean the filter and drainage pump:

1. Make sure the machine is empty of water and that it is switched off at the mains.

2. Open the drainage pump hatch. Use the partition for the detergent compartment as shown in the picture.

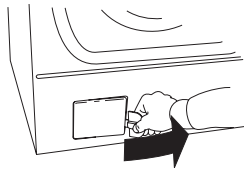

3. Drain out the water, into a bowl, for example, by unhooking the drainage hose from the pin inside the hatch.

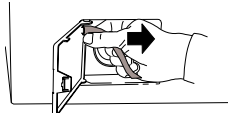

4. Open the pump by screwing the cover anti-clockwise. Remove the cover with the filter.

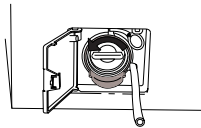

5. Remove any objects or rubbish from the pump housing. Check to see that the pump blades, right at the back, will rotate.

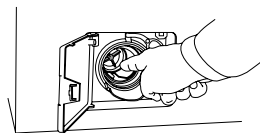

6. Screw on the cover and filter, replace the drainage hose on the hatch pin and close the hatch.

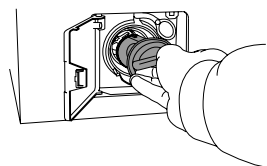

Cleaning the detergent compartment

Pull the detergent compartment out as far as it will go.

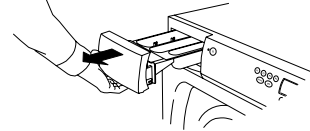

Then pull it up and out as shown in the illustration. Rinse the detergent compartment and brush it clean.

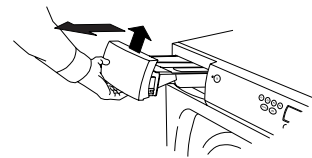

Replace the compartment.

Note!

Do not run the detergent compartment through a dishwasher!

Cleaning the outside of the machine

Clean the outside of the machine and the programme panel with a mild cleaner. Do not use any solvents, as these can damage the machine.

Note!

Do not hose down or spray the machine with water.

Cleaning the inside of the machine to avoid unpleasant smells

Modern washing detergents often allow washing at low temperatures. This means, however, that small deposits can build up in the machine. These, in turn, may lead to unpleasant smells developing.

To avoid this, we recommend running a 95° wash programme now and again. When you do this, use a small quantity of detergent. It is not necessary to put any actual washing in the machine.

Rinse holes under the agitator

If you think that objects such as nails, paper clips, needles or the like may have fallen into the wash drum, you should check under the agitator. Such objects can rust and cause spots on clothing. Nails and other sharp objects can cause holes in fabrics.

Do as follows:

1. Use a screwdriver or similar tool.

2. Insert the screwdriver into the central hole on the agitator and twist the screwdriver handle gently to the left.

3. With your other hand, grasp the agitator and pull it towards you as shown in the illustration.

4. Lift the agitator.

5. Remove any objects.

6. Place the agitator in the mounting hole with the F-mark towards you. Ensure that all the agitator fasteners are in their holes in the drum. Push it away from you until it catches.

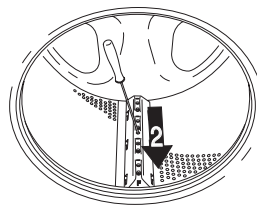
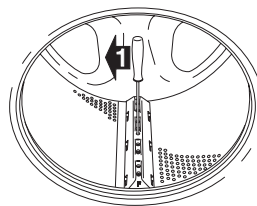

If you have hard water

If you live in an area with hard water, the washer drum may develop a greyish-white coating. To get rid of this, empty a sachet of citric acid, approximately 20 grams, into the washer drum and run the White Cotton wash at 95° C. You can find citric acid among the spices, etc. at your local supermarket.

Troubleshooting

The washer door will not open

1. Check that the main power switch is on.
2. Is there power? Check your home's fuses (circuit breakers). The washer door cannot be opened with the Key button if power is off.
3. If nothing else works, the washer door can be opened as follows:

- First check that there is no water left in the machine. If there is any water left and you are unable to run the Drain programme, empty the machine by detaching the drainage hose. This is described under the heading "Checking the Filter and Drainage pump", in the "Care and cleaning" chapter.

- Ensure that the main power switch is off.

- Open the hatch to the drainage pump, bottom left as shown in the illustration.

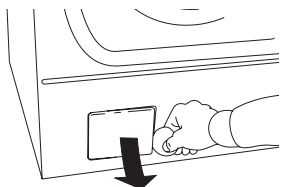

- Unfasten the screws holding the red plastic handle in place.

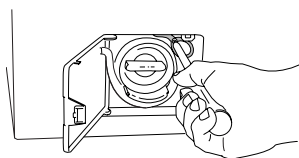

- Pull the handle and the door opens.

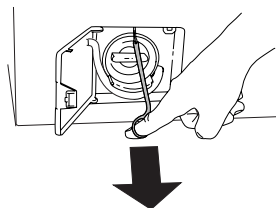

- Insert the handle back into its slot and screw it tight. Close the hatch to the drainage pump.

If the washer door still will not open in the normal way, contact the service division.

The machine will not start

1. Is the washer door properly closed? Push it firmly.
2. Is there power? Check your home's fuses.

Error messages

The display indicates if an error has occurred during operation. In order to exit error message status after implementing the measures below, turn off the machine. The error messages that may be shown are:

The door is not closed

If the first red field beside the Start/Stop button is flashing, you tried to start a programme with the washer door open. Close the door and the programme will start.

Overfilling

If **F1** is flashing in the display.

1. Shut off the water tap.
2. Call the service division.

Drainage error

If **F3** is flashing, there is a problem with drainage. Check:

- that no objects are stuck in the drainage hose outlet.
- that the drainage pump is not blocked by foreign objects. Clean the pump (see the "Care and cleaning" chapter).
- that there are no kinks in the drainage hose.

After implementing corrective action, run the Drain programme or press the Key button (door open) to empty the machine. If this does not help, call the service division.

Water intake error

If **F4** is flashing in the display.

Fault with water supply. Check:

- that the tap on the water pipe is open.
- that the filter in the machine's water intake is not blocked.

1. Shut off the water tap.
2. Unscrew the hose.
3. Clean the filter in the intake valve on the machine.
4. Screw the hose back on.
5. Turn on the tap.
6. Run the programme again to check if the fault is fixed.
7. If the fault remains, call the service division.

Door opening error

If **F6** is flashing in the display, call the service division.

Technical information

Technical data

Height:	850 mm
Width:	595 mm
Depth:	585 mm
Weight:	73/78 (with outer door) kg
Cylinder volume:	50 l
Max. washing capacity:	6.0 kg
Spin speed:	800/1400 rpm
Rated power:	See type plate.
Element power:	See type plate.
Water pressure:	0.1 - 1 MPa 1 - 10 kp/cm ² 10 - 100 N/cm ²
Wash drum and liquid compartment material:	Stainless steel
Outer casing material:	Powder-coated and ParaStyle:Technical information hot-galvanized sheet steel or stainless steel.
Setup:	Stationary on four adjustable, rubber-clad feet
Water connection:	1.5 m PEX tubing
Drain:	1.7 m polypropylene tubing

Standard tests

Europe:	EN 60456/A11/A12/A13
Washing programme:	Heavy white, 60°C, 6.0 kg cotton
Connection:	Cold water 15°C
Test method noise measurement:	IEC-60704-2-4

Transport protection

Before the machine is used, the three transport protection devices should be removed as shown below.

Each transport protection device consists of a screw, a washer, and a rubber spacer. The rubber spacers are used after removal as protection for the transport protection device holes.

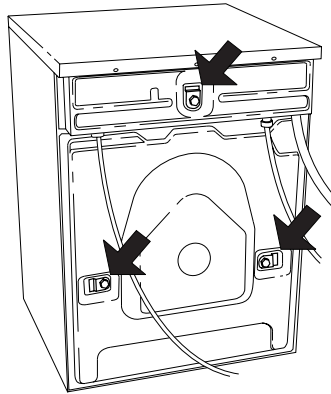

1. First remove the screws and remove the washers.

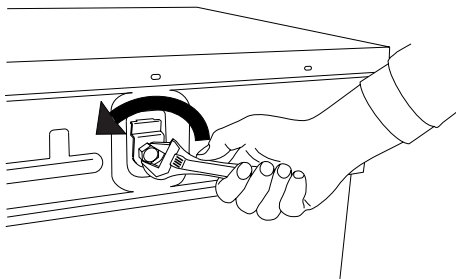

2. Then remove the rubber spacers.

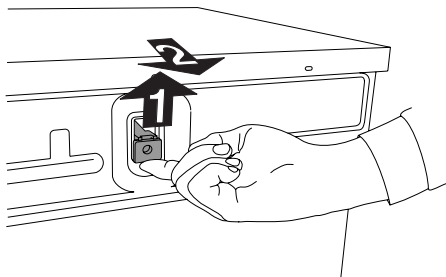

3. Finally, the rubber spacers should be turned over and replaced in the transport protection device holes.

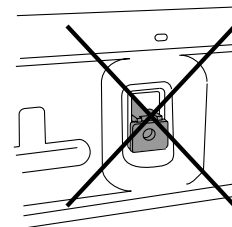
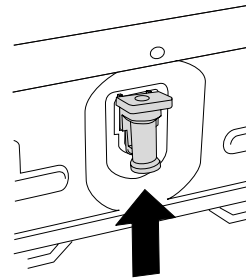

Installation

Positioning the washing machine

The washing machine can be installed as a built-in or freestanding unit. Position the machine so that the electrical plug is easily accessible.

A. Built-in

The washing machine can be installed under a counter top with a working height of 850-900 mm. Leave a space of approximately 5 mm around the machine.

B. Freestanding

The washing machine can be positioned beside or under a dryer.

Adjusting the feet

Adjust the feet so that the machine is steady and balanced on the floor. Tighten the locking nuts.

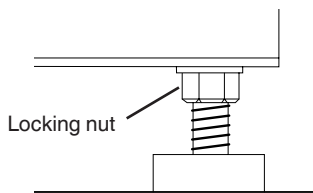

Connection to water supply

Water connection should be carried out by a qualified person.

Connect the machine using the accompanying supply hose. Water pressure

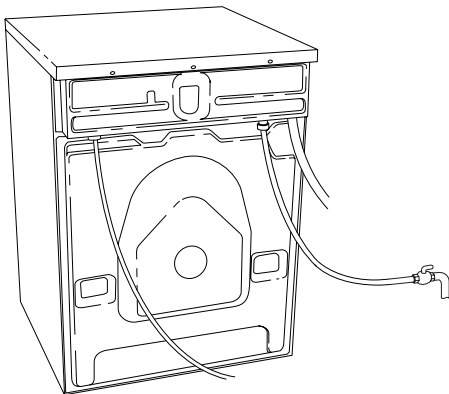

should be 0.1–1MPa (approx. 1–10kp/cm²; 10–100N/cm²).

There should be a stopcock on the water pipe.

If the pipes are newly installed, it may be wise to flush them through so that any dirt is washed away. Otherwise, dirt can clog the filter in the machine's water intake and cut off the water supply.

Drainage connection

The machine is supplied with a connected drainage hose that can be fastened to a laundry sink or similar. The height must be 600 - 900 mm above floor level.

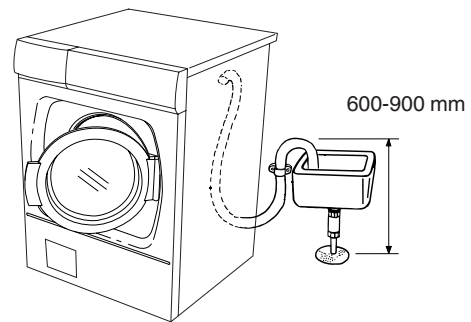

A lower position (600 mm) is always preferable. Ensure that the drainage hose has no kinks.

Electrical installation

Electrical connection must be via a plug connected to an earthed wall socket or by cable for fixed installation and all-pole disconnection, by a qualified professional.

Connection on delivery

The machine is supplied as single-phase, 230V with plug, heat output 2000 W and has a 10A fuse. Any earth fault fuses must be type A.

Note!

Repairs and maintenance relating to safety or performance must be carried out by a qualified professional.

Programme plate in multiple languages

Certain machines include double-sided programme plates in different languages (see the detergent compartment and the bag with the user handbook that comes with the machine).

You can replace or turn the card yourself for the most appropriate language for you.

To remove the card from its holder in the detergent compartment, press the card with your thumb and push it sideways (see illustration). The card will then bend slightly and you can easily remove it.

To fit the card, bend it slightly in order to easily insert it into the holder in the detergent compartment.

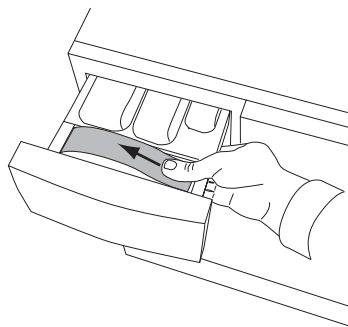

Service

Before contacting the service division,

make sure you know the model designation, type designation and serial number. The model designation can be found on the detergent compartment. Type designation and serial number can be found on the type plate above the washer door.

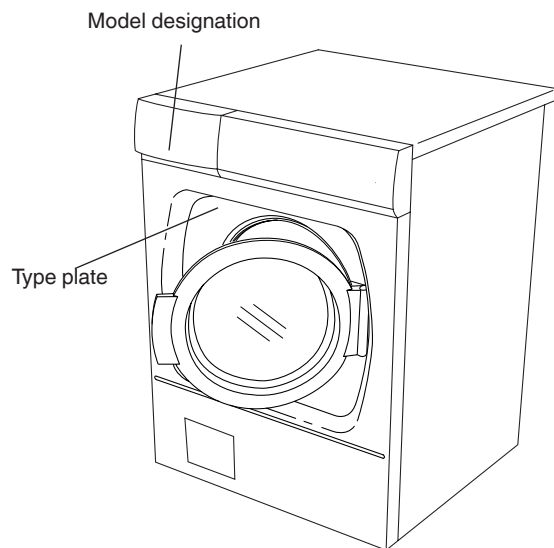
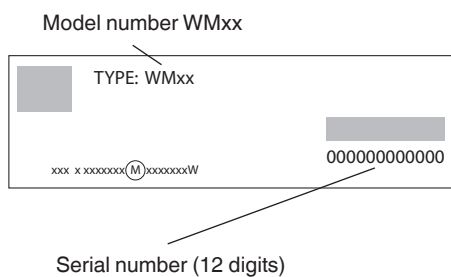

Search words

A

Acrylic 8
Allergies 9
Artificial fibres 9

B

Bleach 8
Bleaching 9

C

Care 14
Child safety 5
Cleaning 14
Cotton 8

D

Delayed Start 12
Delicates 8
Depth 18
Detergent 3, 4, 10, 11
Detergent compartment 6, 24
Disposal 4
Door 3, 6, 10, 13
Dosage 3, 10
Drainage pump 6, 14, 16
Dyeing fabrics 9

E

Energy consumption 9
Error messages 16

F

Fabric softener 6, 10, 24
Filter 14

H

Hand wash 8, 9, 11
Height 18

I

Installation 4, 20, 21

L

Laundry labels 8, 24
Limescale 15
Linen 8
Liquid detergent 6, 24

M

Main power switch 6, 7

N

No spin 12

O

Options 7, 12
Overflow guard function 4

P

Packaging 3
Panel 6, 7
Polyester 8, 9
Powder detergent 10
Programmes 8, 11, 13, 24
Programme time 13

Q

Quick guide 24

S

Safety 4
Service 22
Settings 12
Short spin 9, 11, 12
Silk 9
Sorting laundry 8, 24
Spin 7, 9, 11, 12, 18
Start 7, 11
Stop 13
Stop or change prog 13
Synthetic fibres 9

T

Technical information 18
Temperature 7, 11, 12
Transport 4
Transport protection 19
Troubleshooting 16
Type plate 6, 22

V

Viscose 9

W

Wash ball 10
Wash load 8
Water hardness 3
Weight 18
Width 18
Winter storage 4
Wool 8, 9, 11

Quick guide

1 Washing

- Empty pockets and do up zips.
- Read the item's laundry label.
- Sort your laundry.



NB! Place underwired bras in a laundry net

2 Load the laundry

- Press the main power switch.
- Press and hold the Key button for 3 seconds to open the door.
- Load the laundry and close the door.

3 Detergent compartment

- Pour detergent into the main wash compartment, and pre-wash compartment as well if required. Pour fabric softener into the compartment on the right with the  symbol.
- If you use liquid detergent, follow the detergent manufacturer's recommendations.

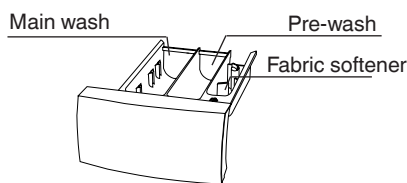

4 Select programme

- Select a programme by turning the programme selector.
- Select any options and settings.

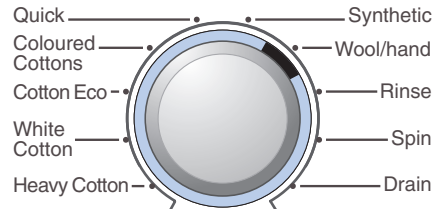

- Press the Start/Stop button.

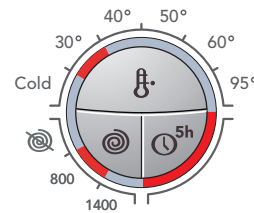

Programme finished

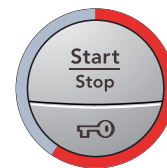

- The text **End** in the display indicates that the wash programme has finished.

• The washer door opens automatically once the programme has finished.

- Remove the laundry.
- Switch off the main power switch.

If you have small children or pets at home, close the washer door once you have removed the laundry.

Free Manuals Download Website

<http://myh66.com>

<http://usermanuals.us>

<http://www.somanuals.com>

<http://www.4manuals.cc>

<http://www.manual-lib.com>

<http://www.404manual.com>

<http://www.luxmanual.com>

<http://aubethermostatmanual.com>

Golf course search by state

<http://golfingnear.com>

Email search by domain

<http://emailbydomain.com>

Auto manuals search

<http://auto.somanuals.com>

TV manuals search

<http://tv.somanuals.com>