



# ELECTRIC RANGE USER INSTRUCTIONS

THANK YOU for purchasing this high-quality product. If you should experience a problem not covered in TROUBLESHOOTING, please visit our website at [www.maytag.com](http://www.maytag.com) for additional information. If you still need assistance, call us at 1-800-688-9900.

You will need your model and serial number, located on the oven frame behind the top right side of the oven door.

Para obtener acceso a "Instrucciones para el usuario de la estufa eléctrica" en español, o para obtener información adicional acerca de su producto, visite: [www.maytag.com](http://www.maytag.com)

Deberá tener a mano el número de modelo y de serie, que están ubicados en el marco del horno, detrás del lado derecho superior de la puerta del horno.

## Table of Contents

|                                      |           |
|--------------------------------------|-----------|
| <b>RANGE SAFETY</b> .....            | <b>2</b>  |
| The Anti-Tip Bracket.....            | 2         |
| <b>FEATURE GUIDE</b> .....           | <b>4</b>  |
| <b>COOKTOP USE</b> .....             | <b>6</b>  |
| Cookware.....                        | 8         |
| Home Canning.....                    | 8         |
| <b>OVEN USE</b> .....                | <b>9</b>  |
| Electronic Oven Controls.....        | 9         |
| Sabbath Mode.....                    | 10        |
| Aluminum Foil.....                   | 10        |
| Positioning Racks and Bakeware.....  | 11        |
| Oven Vent.....                       | 11        |
| Baking and Roasting.....             | 12        |
| Broiling.....                        | 12        |
| Convection Cooking.....              | 12        |
| Cook Time.....                       | 13        |
| Warming Drawer (on some models)..... | 13        |
| <b>RANGE CARE</b> .....              | <b>14</b> |
| Clean Cycle.....                     | 14        |
| General Cleaning.....                | 15        |
| Oven Light.....                      | 16        |
| <b>TROUBLESHOOTING</b> .....         | <b>16</b> |
| <b>ACCESSORIES</b> .....             | <b>17</b> |
| <b>WARRANTY</b> .....                | <b>18</b> |

# RANGE SAFETY

## Your safety and the safety of others are very important.

We have provided many important safety messages in this manual and on your appliance. Always read and obey all safety messages.



This is the safety alert symbol.

This symbol alerts you to potential hazards that can kill or hurt you and others.

All safety messages will follow the safety alert symbol and either the word "DANGER" or "WARNING."

These words mean:

**⚠ DANGER**

You can be killed or seriously injured if you don't immediately follow instructions.

**⚠ WARNING**

You can be killed or seriously injured if you don't follow instructions.

All safety messages will tell you what the potential hazard is, tell you how to reduce the chance of injury, and tell you what can happen if the instructions are not followed.

## The Anti-Tip Bracket

The range will not tip during normal use. However, the range can tip if you apply too much force or weight to the open door without having the anti-tip bracket fastened down properly.

**⚠ WARNING**

### Tip Over Hazard

A child or adult can tip the range and be killed.

Verify the anti-tip bracket has been properly installed and engaged per installation instructions.

Re-engage anti-tip bracket if range is moved.

Do not operate range without anti-tip bracket installed and engaged.

Failure to follow these instructions can result in death or serious burns to children and adults.

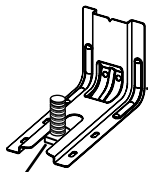

Anti-Tip Bracket

Range Foot

To verify the anti-tip bracket is installed and engaged:

- Slide range forward.
- Look for the anti-tip bracket securely attached to floor or wall.
- Slide range back so rear range foot is under anti-tip bracket.
- See installation instructions for details.

State of California Proposition 65 Warnings:

WARNING: This product contains one or more chemicals known to the State of California to cause cancer.

WARNING: This product contains one or more chemicals known to the State of California to cause birth defects or other reproductive harm.

# IMPORTANT SAFETY INSTRUCTIONS

**WARNING:** To reduce the risk of fire, electrical shock, injury to persons, or damage when using the range, follow basic precautions, including the following:

- **WARNING:** TO REDUCE THE RISK OF TIPPING OF THE RANGE, THE RANGE MUST BE SECURED BY PROPERLY INSTALLED ANTI-TIP DEVICES. TO CHECK IF THE DEVICES ARE INSTALLED PROPERLY, SLIDE RANGE FORWARD, LOOK FOR ANTI-TIP BRACKET SECURELY ATTACHED TO FLOOR OR WALL, AND SLIDE RANGE BACK SO REAR RANGE FOOT IS UNDER ANTI-TIP BRACKET.
- **CAUTION:** Do not store items of interest to children in cabinets above a range or on the backguard of a range – children climbing on the range to reach items could be seriously injured.
- Proper Installation – Be sure the range is properly installed and grounded by a qualified technician.
- Never Use the Range for Warming or Heating the Room.
- Do Not Leave Children Alone – Children should not be left alone or unattended in area where the range is in use. They should never be allowed to sit or stand on any part of the range.
- Wear Proper Apparel – Loose-fitting or hanging garments should never be worn while using the range.
- User Servicing – Do not repair or replace any part of the range unless specifically recommended in the manual. All other servicing should be referred to a qualified technician.
- Storage in or on the Range – Flammable materials should not be stored in an oven or near surface units.
- Do Not Use Water on Grease Fires – Smother fire or flame or use dry chemical or foam-type extinguisher.
- Use Only Dry Potholders – Moist or damp potholders on hot surfaces may result in burns from steam. Do not let potholder touch hot heating elements. Do not use a towel or other bulky cloth.
- DO NOT TOUCH SURFACE UNITS OR AREAS NEAR UNITS – Surface units may be hot even though they are dark in color. Areas near surface units may become hot enough to cause burns. During and after use, do not touch, or let clothing or other flammable materials contact surface units or areas near units until they have had sufficient time to cool. Among those areas are the cooktop and surfaces facing the cooktop.
- Use Proper Pan Size – The range is equipped with one or more surface units of different size. Select utensils having flat bottoms large enough to cover the surface unit heating element. The use of undersized utensils will expose a portion of the heating element to direct contact and may result in ignition of clothing. Proper relationship of utensil to burner will also improve efficiency.
- Never Leave Surface Units Unattended at High Heat Settings – Boilover causes smoking and greasy spillovers that may ignite.
- Make Sure Reflector Pans or Drip Bowls Are in Place – Absence of these pans or bowls during cooking may subject wiring or components underneath to damage.

- Protective Liners – Do not use aluminum foil to line surface unit drip bowls or oven bottoms, except as suggested in the manual. Improper installation of these liners may result in a risk of electric shock, or fire.
- Glazed Cooking Utensils – Only certain types of glass, glass/ceramic, ceramic, earthenware, or other glazed utensils are suitable for range-top service without breaking due to the sudden change in temperature.
- Utensil Handles Should Be Turned Inward and Not Extend Over Adjacent Surface Units – To reduce the risk of burns, ignition of flammable materials, and spillage due to unintentional contact with the utensil, the handle of a utensil should be positioned so that it is turned inward, and does not extend over adjacent surface units.
- Do Not Soak Removable Heating Elements – Heating elements should never be immersed in water.
- Do Not Cook on Broken Cooktop – If cooktop should break, cleaning solutions and spillovers may penetrate the broken cooktop and create a risk of electric shock. Contact a qualified technician immediately.
- Clean Cooktop With Caution – If a wet sponge or cloth is used to wipe spills on a hot cooking area, be careful to avoid steam burn. Some cleaners can produce noxious fumes if applied to a hot surface.
- Use Care When Opening Door – Let hot air or steam escape before removing or replacing food.
- Do Not Heat Unopened Food Containers – Build-up of pressure may cause container to burst and result in injury.
- Keep Oven Vent Ducts Unobstructed.
- Placement of Oven Racks – Always place oven racks in desired location while oven is cool. If rack must be moved while oven is hot, do not let potholder contact hot heating element in oven.
- DO NOT TOUCH HEATING ELEMENTS OR INTERIOR SURFACES OF OVEN – Heating elements may be hot even though they are dark in color. Interior surfaces of an oven become hot enough to cause burns. During and after use, do not touch, or let clothing or other flammable materials contact heating elements or interior surfaces of oven until they have had sufficient time to cool. Other surfaces of the appliance may become hot enough to cause burns – among these surfaces are oven vent openings and surfaces near these openings, oven doors, and windows of oven doors.

## For self-cleaning ranges –

- Do Not Clean Door Gasket – The door gasket is essential for a good seal. Care should be taken not to rub, damage, or move the gasket.
- Do Not Use Oven Cleaners – No commercial oven cleaner or oven liner protective coating of any kind should be used in or around any part of the oven.
- Clean Only Parts Listed in Manual.
- Before Self-Cleaning the Oven – Remove broiler pan and other utensils.

## For units with ventilating hood –

- Clean Ventilating Hoods Frequently – Grease should not be allowed to accumulate on hood or filter.
- When flambeing foods under the hood, turn the fan on.

## SAVE THESE INSTRUCTIONS

# FEATURE GUIDE

This manual covers several models. Your model may have some or all of the items listed. Refer to this manual or Frequently Asked Questions (FAQs) section of our website at [www.maytag.com](http://www.maytag.com) for more detailed instructions.



## ⚠ WARNING

**Food Poisoning Hazard**

**Do not let food sit in oven more than one hour before or after cooking.**

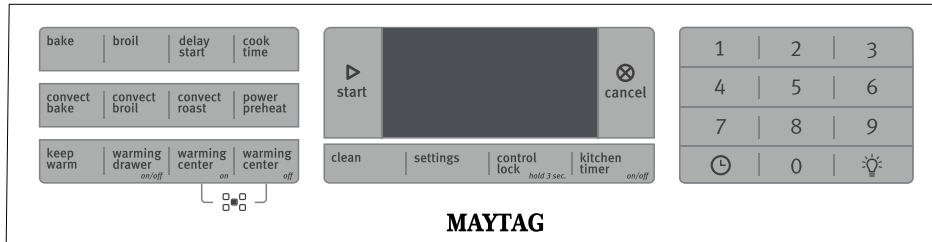
**Doing so can result in food poisoning or sickness.**



| KEYPAD   | FEATURE                    | INSTRUCTIONS   |
|--|----------------------------|--|
| <b>CLOCK</b><br>        | <b>Clock</b>               | <p>This clock can use a 12- or 24-hour cycle. See “Oven Use” section.</p> <ol style="list-style-type: none"> <li>1. Press SETTINGS once.</li> <li>2. Press START to change the time.</li> <li>3. Press “3” for AM or “6” for PM.</li> <li>4. Press the number keypads to set the time of day.</li> <li>5. Press START.</li> </ol>  |
| <b>OVEN LIGHT</b><br> | <b>Oven cavity light</b>   | <p>While the oven door is closed, press the OVEN LIGHT keypad to turn the light on and off. The oven light will come on when the oven door is opened.</p>  |
| <b>KITCHEN TIMER ON/OFF</b>  | <b>Oven timer</b>          | <p>The Timer can be set in hours or minutes up to 9 hours and 59 minutes.</p> <ol style="list-style-type: none"> <li>1. Press KITCHEN TIMER.</li> <li>2. Press the number keypads to set the length of time in hr-hr-min-min. Leading zeroes do not have to be entered. For example, for 2 minutes, enter “2.”</li> <li>3. Press KITCHEN TIMER or START to begin the countdown. If enabled, end-of-cycle tones will sound at end of countdown.</li> <li>4. Press KITCHEN TIMER twice to cancel the Kitchen Timer and return to the time of day. Do not press the Cancel keypad because the oven will turn off.</li> <li>5. If the Kitchen Timer is running, but not in the display, press KITCHEN TIMER to display the countdown for 5 seconds.</li> </ol> |
| <b>START</b>   | <b>Cooking start</b>       | <p>The Start pad begins any oven function. If Start is not pressed within 2 minutes after pressing a keypad, the function is canceled and the time of day is displayed.</p>  |
| <b>CANCEL</b>  | <b>Range function</b>      | <p>The Cancel keypad stops any oven function except the Clock, Kitchen Timer, Control Lock and Warming Drawer.</p>   |
| <b>BAKE</b>  | <b>Baking and roasting</b> | <ol style="list-style-type: none"> <li>1. Press BAKE.</li> <li>2. Press the number keypads to set a temperature other than 350°F (175°C) in 5° increments between 170°F and 500°F (75°C and 260°C).</li> <li>3. Press START.</li> <li>4. To change the temperature, repeat steps 1 and 2. Press START for the change to take effect.</li> <li>5. Press CANCEL when finished.</li> </ol>  |
| <b>BROIL</b>   | <b>Broiling</b>            | <ol style="list-style-type: none"> <li>1. Press BROIL.</li> <li>2. Select the broiling temperature by pressing 1 - high (500°F [260°C]), 2 - medium (450°F [232°C]) or 3 - low (400°F [204°C]). The default setting is high.</li> <li>3. Press START and allow the oven to preheat for 5 minutes.</li> <li>4. Position the cookware in the oven and leave the door open 6" (15 cm) at the broil stop position.</li> <li>5. Press CANCEL when finished.</li> </ol>  |

| KEYPAD                                  | FEATURE                                | INSTRUCTIONS   |
|---|--|--|
| <b>CONVECT BAKE</b>                     | <b>Convection cooking</b>              | <ol style="list-style-type: none"> <li>1. Press CONVECT BAKE.</li> <li>2. Press the number keypads to set a temperature other than 350°F (177°C) in 5° increments between 170°F and 500°F (77°C and 260°C).</li> <li>3. Press START. Auto conversion will reduce the temperature by 25°F (15°C).</li> <li>4. To change the temperature, repeat steps 1 and 2. Press START for the change to take effect.</li> <li>5. Press CANCEL when finished.</li> </ol>  |
| <b>CONVECT ROAST</b>                    | <b>Convection cooking</b>              | <ol style="list-style-type: none"> <li>1. Press CONVECT ROAST.</li> <li>2. Press the number keypads to set a temperature other than 325°F (163°C) in 5° increments between 170°F and 500°F (77°C and 260°C).</li> <li>3. Press START. Auto conversion will reduce the temperature by 25°F (15°C).</li> <li>4. To change the temperature, repeat steps 1 and 2. Press START for the change to take effect.</li> <li>5. Press CANCEL when finished.</li> </ol>   |
| <b>CONVECT BROIL</b>                    | <b>Convection cooking</b>              | <ol style="list-style-type: none"> <li>1. Press CONVECT BROIL.</li> <li>2. Press the number keypads to set a temperature other than 350°F (177°C) in 5° increments between 170°F and 500°F (77°C and 260°C).</li> <li>3. Press START. Auto conversion will reduce the temperature by 25°F (15°C).</li> <li>4. To change the temperature, repeat steps 1 and 2. Press START for the change to take effect.</li> <li>5. Press CANCEL when finished.</li> </ol>   |
| <b>KEEP WARM</b>                        | <b>Hold warm</b>                       | <p>Food must be at serving temperature before placing it in the warmed oven.</p> <ol style="list-style-type: none"> <li>1. Press KEEP WARM.</li> <li>2. Set temperature between 145°F (63°C) and 190°F (88°C) using the number keypads. The default temperature is 170°F (75°C).</li> <li>3. Press START.</li> <li>4. Press CANCEL when finished.</li> </ol>   |
| <b>DELAY START</b>                      | <b>Delayed start</b>                   | The DELAY START keypad is used to enter the starting time for an oven function with a delayed start.   |
| <b>COOK TIME</b>                        | <b>Timed cooking</b>                   | <p>Timed Cooking allows the oven to be set to turn on at a certain time of day, cook for a set length of time, and/or shut off automatically. Delay start should not be used for foods such as breads and cakes because they may not bake properly.</p> <p>To set a Timed Cook or a Delayed Timed Cook, see “Cook Time” section.</p>   |
| <b>POWER PREHEAT</b>                    | <b>Rapid oven preheating</b>           | <p>Provides the fastest preheat time for the BAKE function.</p> <ol style="list-style-type: none"> <li>1. Press POWER PREHEAT.</li> <li>2. Press the number keypads in response to the scrolling text to enter the Bake temperature.</li> <li>3. Press START.</li> <li>4. A reminder tone will sound when the preheat temperature is reached. Place food inside the oven.</li> </ol> <p><b>NOTE:</b> This feature should only be used for one-rack baking. Unused racks should be removed prior to Power Preheat. A standard flat rack should be used for Power Preheat.</p> <p>If preheating for the Bake cycle has already started, Power Preheat may be started directly by pressing Power Preheat.</p> |
| <b>WARMING CENTER ON/OFF</b>            | <b>Warming zone</b>                    | <p>Press WARMING CENTER ON to select the warming element on the cooktop, then press START.</p> <p>Press WARMING CENTER OFF to turn off the warming element.</p>  |
| <b>WARMING DRAWER ON/OFF</b>            | <b>Warming drawer (on some models)</b> | <ol style="list-style-type: none"> <li>1. Press WARMING DRAWER to select the Warming Drawer function.</li> <li>2. Press START to begin preheating the warming drawer.</li> <li>3. Press WARMING DRAWER to turn off the heating element.</li> </ol> <p>See the “Warming Drawer” section for more information.</p>   |
| <b>CLEAN</b>                            | <b>Clean cycle</b>                     | See the “Clean Cycle” section.   |
| <b>CONTROL LOCK hold 3 sec. to lock</b> | <b>Oven control lockout</b>            | <p>No keypads will function with the controls locked.</p> <ol style="list-style-type: none"> <li>1. Check that the oven and the Kitchen Timer are off.</li> <li>2. Press and hold CONTROL LOCK keypad for 3 seconds.</li> <li>3. If enabled, a tone will sound, and “CONTROL LOCKED” will be displayed.</li> <li>4. Repeat to unlock.</li> </ol>   |
| <b>SETTINGS</b>                         | <b>Oven use functions</b>              | Enables you to personalize the audible tones and oven operation to suit your needs. See the “Oven Use” section.  |

# COOKTOP USE

## ⚠️ WARNING



### Fire Hazard

Turn off all controls when done cooking.  
Failure to do so can result in death or fire.

The control knobs can be set to anywhere between HIGH and LOW. Push in and turn to setting.

**REMEMBER:** When range is in use, the entire cooktop area may become hot.

## Ceramic Glass

The surface cooking area will glow red when an element is on. Some parts of the surface cooking area may not glow red when an element is on. This is normal operation. It may cycle on and off to maintain the selected heat level.

It is normal for the surface of light colored ceramic glass to appear to change color when surface cooking areas are hot. As the glass cools, it will return to its original color.

Clean the cooktop after each use to help avoid scratches, pitting, abrasions and to condition the glass surface. Ceramic glass cooktop cleaner and a cooktop scraper are also recommended for stubborn soils. Do not use abrasive cleaners, cleaning pads or harsh chemicals for cleaning. The Cooktop Care Kit Part Number 31605 contains all of the items needed to clean and condition your ceramic glass cooktop. Refer to the "Range Care" section for additional information.

**IMPORTANT:** To avoid permanent damage to the cooktop surface and to make soils easier to remove, clean the cooktop after each use to remove all soils.

- Avoid storing jars or cans above the cooktop. Dropping a heavy or hard object onto the cooktop could crack the cooktop.
- To avoid damage to the cooktop, do not leave a hot lid on the cooktop. As the cooktop cools, air can become trapped between the lid and the cooktop, and the ceramic glass could break when the lid is removed.
- For foods containing sugar in any form, clean up all spills and soils as soon as possible. Allow the cooktop to cool down slightly. Then, while wearing oven mitts, remove the spills using a scraper while the surface is still warm. If sugary spills are allowed to cool down, they can adhere to the cooktop and can cause pitting and permanent marks.
- To avoid scratches, do not slide cookware or bakeware across the cooktop. Aluminum or copper bottoms and rough finishes on cookware or bakeware could leave scratches or marks on the cooktop.
- Do not cook popcorn in prepackaged aluminum containers on the cooktop. They could leave aluminum marks that cannot be removed completely.
- To avoid damage to the cooktop, do not allow objects that could melt, such as plastic or aluminum foil, to touch any part of the entire cooktop.
- To avoid damage to the cooktop, do not use the cooktop as a cutting board.

- Use cookware about the same size as the surface cooking area. Cookware should not extend more than ½" (1.3 cm) outside the area.

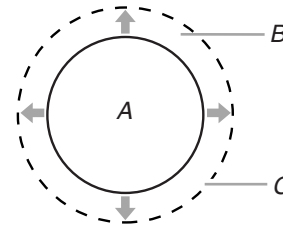

A. Surface cooking area  
B. Cookware/canner  
C. ½" (1.3 cm) maximum overhang

- Use flat-bottomed cookware for best heat conduction and energy efficiency. Cookware with rounded, warped, ribbed or dented bottoms could cause uneven heating and poor cooking results.
- Determine flatness by placing the straight edge of a ruler across the bottom of the cookware. While you rotate the ruler, no space or light should be visible between it and the cookware.
- Cookware designed with slightly indented bottoms or small expansion channels can be used.
- Make sure the bottoms of pots and pans are clean and dry before using them. Residue and water can leave deposits when heated.
- To avoid damage to the cooktop, do not cook foods directly on the cooktop.

## Cooktop On Indicator Light

The Cooktop On indicator light is located on the console panel. When any control knob on the console panel is turned on, the Cooktop On indicator light will glow.

## Hot Surface Indicator Light

On ceramic glass models, the hot surface indicator light is located on the console panel.

The hot surface indicator light will glow as long as any surface cooking area is too hot to touch, even after the surface cooking area is turned off.

## Triple-Choice™ Element

The Triple-Choice™ Element offers flexibility depending on the size of the cookware. Single size can be used in the same way as a regular element. The dual and triple sizes combine single, dual and outer element and are recommended for larger size cookware, large quantities of food, and home canning.

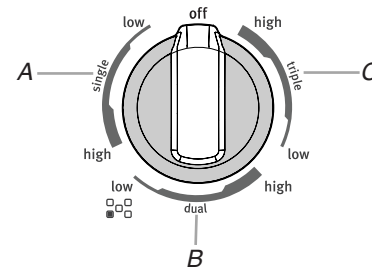

A. Single  
B. Dual  
C. Triple

## Melt Element

The Melt Cooking Zone offers flexibility due to a wide range of settings between High and Melt. The High heat option can be used to boil small amounts of liquid quickly. To reduce the power setting, turn the knob clockwise. The Melt setting is designed for delicate foods that require low heat, such as when melting chocolate or holding sauces. Use cookware appropriate in size for the Melt Cooking Zone.

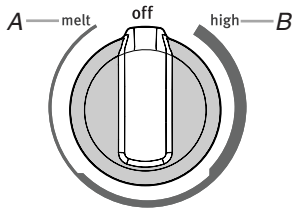

A. Melt option  
B. High heat option

## Warming Center Element

### ! WARNING

#### Food Poisoning Hazard

**Do not let food sit for more than one hour before or after cooking.**

**Doing so can result in food poisoning or sickness.**

Use the Cooktop Warming Center element to keep cooked foods warm. One hour is the recommended maximum time to maintain food quality.

Do not use it to heat cold foods.

The Warming Center element can be used alone or when any of the other surface cooking areas are being used.

The Warming Center element area will not glow red when cycling on. However, the Element On light will glow while the Cooktop Warming Center element is in use.

- Use only cookware recommended for oven and cooktop use.
- Cover all foods with a lid or aluminum foil. When warming baked goods, allow a small opening in the cover for moisture to escape.
- To avoid damage to the cooktop, do not use plastic wrap to cover food because the plastic wrap may melt.
- Use pot holders or oven mitts to remove food.



### To Use:

1. To turn on, press WARMING CENTER ON and then START.
2. To turn off, press WARMING CENTER OFF.

## Bridge Element

Use the bridge area to create an oblong heated area to cook with large cookware.

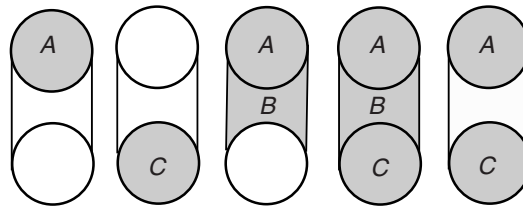

A. Right rear single element  
B. Right center bridge element  
C. Right front single element

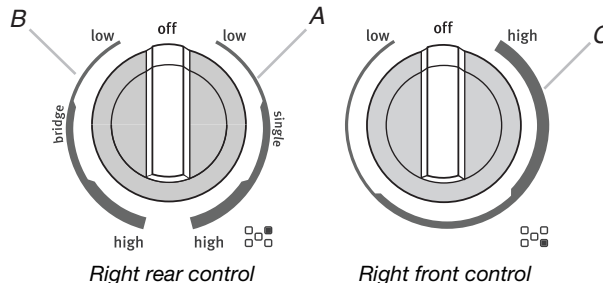

### To use SINGLE (A):

1. Push in and turn right rear control knob clockwise from the Off position to the SINGLE zone anywhere between LOW and HIGH.
2. Turn control knob to Off when finished.

### To use SINGLE (C):

1. Push in and turn right front control knob counterclockwise from the Off position to anywhere between LOW and HIGH.
2. Turn control knob to OFF when finished.

### To use both SINGLE elements and BRIDGE (A+B+C):

1. Push in and turn right rear control knob counterclockwise from the Off position to the BRIDGE zone anywhere between LOW and HIGH.
2. Push in and turn right front control knob counterclockwise from the Off position to anywhere between LOW and HIGH.
3. Turn both control knobs to OFF when finished.

### To use both SINGLE elements (A+C):

1. Push in and turn right rear control knob clockwise from the Off position to the SINGLE zone anywhere between LOW and HIGH.
2. Push in and turn right front control knob counterclockwise from the Off position to anywhere between LOW and HIGH.
3. Turn both control knobs to OFF when finished.

## Cookware

**IMPORTANT:** Do not leave empty cookware on a hot surface cooking area, element or surface burner.

Ideal cookware should have a flat bottom, straight sides and a well-fitting lid, and the material should be of medium-to-heavy thickness.

Rough finishes may scratch the cooktop. Aluminum and copper may be used as a core or base in cookware. However, when used as a base they can leave permanent marks on the grates.

Cookware material is a factor in how quickly and evenly heat is transferred, which affects cooking results. A nonstick finish has the same characteristics as its base material. For example, aluminum cookware with a nonstick finish will take on the properties of aluminum.

Cookware with nonstick surfaces should not be used under the broiler.

Check for flatness by placing the straight edge of a ruler across the bottom of the cookware. While you rotate the ruler, no space or light should be visible between it and the cookware.

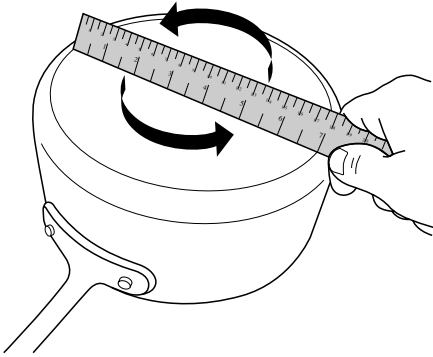

Use the following chart as a guide for cookware material characteristics.

| COOKWARE                                      | CHARACTERISTICS  |
|---|--|
| <b>Aluminum</b>                               | <ul style="list-style-type: none"><li>■ Heats quickly and evenly.</li><li>■ Suitable for all types of cooking.</li><li>■ Medium or heavy thickness is best for most cooking tasks.</li></ul> |
| <b>Cast iron</b>                              | <ul style="list-style-type: none"><li>■ Heats slowly and evenly.</li><li>■ Good for browning and frying.</li><li>■ Maintains heat for slow cooking.</li></ul>                                |
| <b>Ceramic or Ceramic glass</b>               | <ul style="list-style-type: none"><li>■ Follow manufacturer's instructions.</li><li>■ Heats slowly, but unevenly.</li><li>■ Ideal results on low to medium heat settings.</li></ul>          |
| <b>Copper</b>                                 | <ul style="list-style-type: none"><li>■ Heats very quickly and evenly.</li></ul>   |
| <b>Earthenware</b>                            | <ul style="list-style-type: none"><li>■ Follow manufacturer's instructions.</li><li>■ Use on low heat settings.</li></ul>  |
| <b>Porcelain enamel-on-steel or cast iron</b> | <ul style="list-style-type: none"><li>■ See stainless steel or cast iron.</li></ul>  |
| <b>Stainless steel</b>                        | <ul style="list-style-type: none"><li>■ Heats quickly, but unevenly.</li><li>■ A core or base of aluminum or copper on stainless steel provides even heating.</li></ul>                      |

Use flat-bottomed cookware for best cooking results and energy efficiency. The cookware should be about the same size as the cooking area outlined on the cooktop. Cookware should not extend more than 1/2" (1.3 cm) outside the area.

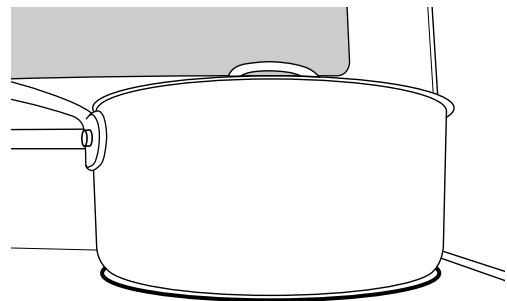

## Home Canning

Canning can be performed on a glass smooth top cooking surface. When canning for long periods, alternate the use of surface cooking areas or elements between batches. This allows time for the most recently used areas to cool.

- Center the canner on the largest surface cooking area or element. On electric cooktops, canners should not extend more than 1/2" (1.3 cm) beyond the surface cooking area or element.

- Do not place canner on 2 surface cooking areas or elements at the same time.
- On ceramic glass models, use only flat-bottomed canners to avoid damage to the cooktop and elements.
- For more information, contact your local agricultural extension office, or refer to published home canning guides. Companies that manufacture home canning products can also offer assistance.



---

# OVEN USE

Odors and smoke are normal when the oven is used the first few times, or when it is heavily soiled.

**IMPORTANT:** The health of some birds is extremely sensitive to the fumes given off. Exposure to the fumes may result in death to certain birds. Always move birds to another closed and well-ventilated room.

---

## Electronic Oven Controls

---

### Control Display

The display will flash when powered up or after a power loss. Press CANCEL to clear. When oven is not in use, the time of day is displayed. Indicator lights show functions that are in use.

---

### Tones

Tones are audible signals, indicating the following:

#### One tone

- Valid pad press
- Oven is preheated (long tone)
- Function has been entered
- Reminder (on some models), repeating each minute after the end-of-cycle tones

#### Three tones

- Invalid pad press

#### Four tones

- End of cycle

Use the Settings key to change the tone settings.

---

### Settings

Many features of the oven control can be adjusted to meet your personal needs. These changes are made using the Settings key.

Use the Settings key to scroll through the features that can be changed. Each press of the Settings key will advance the display to the next setting. After selecting the feature to be changed, the control will prompt you for the required input. After the setting is saved by pressing Start, the control will exit Settings and display the time of day. Details of all of the feature changes are explained in the following sections.

Press CANCEL to exit Settings.

---

### Clock Time of Day

This clock can use a 12- or 24-hour cycle. To adjust, see "12/24 Hour Clock" in this section.

Check that the oven and Timer are off.

#### To Change Time of Day:

1. Press SETTINGS once. After 3 seconds, "SET CLOCK-PUSH START TO CHANGE" will be displayed.
  2. Press START to display the current setting.
  3. Press "3" for AM or "6" for PM.
  4. Press the number keypads to set the time of day.
  5. Press START.
  6. Press CANCEL to exit.
- 

---

### Oven Temperature Offset Control

**IMPORTANT:** Do not use a thermometer to measure oven temperature because opening the oven door may cause element cycling to give incorrect readings.

The oven provides accurate temperatures; however, it may cook faster or slower than your previous oven, so the temperature can be adjusted to personalize it for your cooking needs. It can be changed in Fahrenheit or Celsius.

#### To Adjust Oven Temperature:

1. Press SETTINGS until "TEMP OFFSET" is displayed.
  2. Press START to display the current setting.
  3. Press the "3" keypad to increase the temperature in 5°F (3°C) increments, or press the "6" keypad to decrease the temperature in 5°F (3°C) increments. The range is from -30°F to +30°F (18°C to 18°C).
  4. Press START to save the setting.
  5. Press CANCEL to exit.
- 

### Fahrenheit and Celsius

The temperature is preset at Fahrenheit, but can be changed to Celsius.

#### To change:

1. Press SETTINGS until "TEMP UNIT" is displayed.
  2. Press START to display the current setting.
  3. Press the "3" keypad to adjust the setting.
  4. Press START to save the setting.
  5. Press CANCEL to exit.
- 

### Audible Tones Disable

Turns off all tones, including the end of cycle tone and key press tones. Reminder tones are still active when all tones are disabled.

1. Press SETTINGS until "ALL SOUNDS" is displayed.
  2. Press START to display the current setting.
  3. Press the "3" keypad to adjust the setting.
  4. Press START to save the setting.
  5. Press CANCEL to exit.
- 

### End of Cycle Tone

Activates or turns off the tones that sound at the end of a cycle.

1. Press SETTINGS until "CYCLE TONE END" is displayed.
  2. Press START to display the current setting.
  3. Press the "3" keypad to adjust the setting.
  4. Press START to save the setting.
  5. Press CANCEL to exit.
- 

### Reminder Tones Disable

Turns off the short repeating tone that sounds every 1 minute after the end of cycle tones.

1. Press SETTINGS until "REMINDER TONE" is displayed.
  2. Press START to display the current setting.
  3. Press the "3" keypad to adjust the setting.
  4. Press START to save the setting.
  5. Press CANCEL to exit.
-

---

## Key Press Tones

Activates or turns off the tones when a keypad is pressed.

1. Press SETTINGS until "KEY PRESS TONE" is displayed.
2. Press START to display the current setting.
3. Press the "3" keypad to adjust the setting.
4. Press START to save the setting.
5. Press CANCEL to exit.

---

## Tone Pitch

Sets the pitch of the tone to either high or low.

1. Press SETTINGS until "TONE PITCH" is displayed.
2. Press START to display the current setting.
3. Press the "3" keypad to adjust the setting.
4. Press START to save the setting.
5. Press CANCEL to exit.

---

## Demo Mode

**IMPORTANT:** This feature is intended for use on the sales floor with 120 V power connection and permits the control features to be demonstrated without heating elements turning on. If this feature is activated, the oven will not work.

1. Press SETTINGS until "DEMO MODE" is displayed.
2. Press START to display the current setting.
3. Press the "3" keypad to adjust the setting.
4. Press START to save the setting.
5. Press CANCEL to exit.

---

## Sabbath Mode

The Sabbath Mode sets the oven to remain on in a bake setting until turned off.

When the Sabbath Mode is set, all cooking and cleaning cycles are disabled. Only the Bake cycle will operate in the Sabbath Mode. No tones will sound, and the displays will not show messages or temperature changes.

When the oven door is opened or closed, the oven light will not turn on or off and the heating elements will not turn on or off immediately.

### To Enable Sabbath Mode Capability (one time only):

1. Open oven door.
2. Press 7-8-9-6.  
"SABBATH ON" or "SABBATH OFF" and "PRESS START TO ENTER" will appear in the display.
3. Press START to change the displayed status.
4. Close oven door. Sabbath Mode can be used for baking.

**NOTE:** To disable the Sabbath Mode, repeat steps 1 - 3 to change the status from "SABBATH ON" to "SABBATH OFF."

---

## 12-Hour Shutoff

The oven control is set to automatically shut off the oven 12 hours after the oven initiates a cook or clean function. This will not interfere with any timed or delay cook functions.

1. Press SETTINGS until "12-HR SHUT-OFF" is displayed.
2. Press START to display the current setting.
3. Press the "3" keypad to adjust the setting.
4. Press START to save the setting.
5. Press CANCEL to exit.

---

## 12/24 Hour Clock

1. Press SETTINGS until "12/24 HR" is displayed.
2. Press START to display the current setting.
3. Press the "3" keypad to adjust the setting.
4. Press START to save the setting.
5. Press CANCEL to exit.

---

## Languages - Scrolling Display Text

Language options are English, Spanish and French.

1. Press SETTINGS until "LANGUAGE" is displayed.
2. Press START to display the current setting.
3. Press the "3" keypad to adjust the setting.
4. Press START to save the setting.
5. Press CANCEL to exit.

### To Activate Sabbath Mode:

1. Press BAKE.
2. Press the number keypad to set a temperature other than 350°F (177°C).
3. Press START.  
For timed cooking in Sabbath Mode, press COOK TIME, then the number keypad to set the desired cook time.
4. Press SETTINGS, then press "7." "SAB" will appear in the display.

### To Adjust Temperature (when Sabbath Mode is running):

1. Press the number keypad as instructed by the scrolling text to select the new temperature.  
**NOTE:** The temperature adjustment will not appear on the display. The scrolling text will be shown on the display as it was before the keypad was pressed.
2. Press START.

### To Deactivate Sabbath Mode:

Press SETTINGS, then press "7" to return to regular baking or press CANCEL to turn off the range.

---

## Aluminum Foil

**IMPORTANT:** To avoid permanent damage to the oven bottom finish, do not line the oven bottom with any type of foil or liner.

For best cooking results, do not cover entire oven rack with foil because air must be able to move freely.

## Positioning Racks and Bakeware

**IMPORTANT:** To avoid permanent damage to the porcelain finish, do not place food or bakeware directly on the oven door or bottom.

### Bakeware

To cook food evenly, hot air must be able to circulate. Allow 2" (5 cm) of space around bakeware and oven walls. Make sure that no bakeware piece is directly over another.

### Racks

- Position racks before turning on the oven.
- Do not move racks with bakeware on them.
- Make sure racks are level.

To move a rack, pull it out to the stop position, raise the front edge, and then lift out. Use the following illustration and charts as a guide.

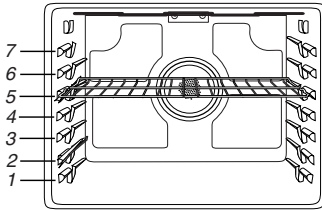

The oven has 7 positions for a flat rack, as shown in the previous illustration and the following table.

| Flat Rack Position* | Type of Food                               |
|---------------------|--|
| 7                   | Broiling/searing meats, hamburgers, steaks |
| 6                   | Broiled meats, poultry, fish               |
| 3 or 4              | Most baked goods, casseroles               |
| 2                   | Roasted meats                              |
| 1                   | Large roasts or poultry                    |

\*If your model has a Max Capacity Oven Rack, the recessed ends must be placed in the rack position above the desired position of the food. See the following illustration.

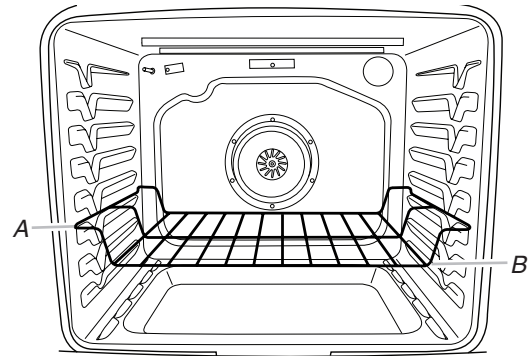

A. Ends of rack in position 3  
B. Food in position 2

**IMPORTANT:** These rack positions are for flat racks. If a Max Capacity Oven Rack is used, the rack position must be adjusted as shown in the previous figure.

### Multiple Rack Cooking

2-rack: Use rack positions 2 and 5 for regular baking.

2-rack (convection only): Use rack positions 2 and 5; or 3 and 6.

3-rack (convection only): Use rack positions 1, 4 and 7; or 2, 4 and 6.

### Baking Cakes on 2 Racks

For best results when baking cakes on 2 racks, use racks 2 and 5. For best results when convection baking cakes on 2 racks, use racks 1 and 4. Place the cakes on the racks as shown.

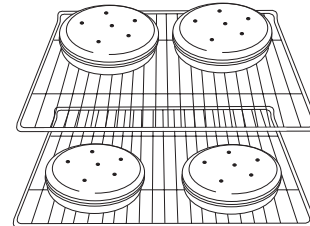

## Oven Vent

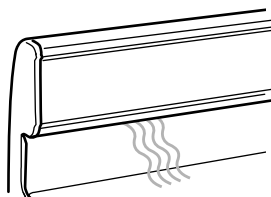

The oven vent releases hot air and moisture from the oven, and should not be blocked or covered. Blocking or covering the oven vent will cause poor air circulation, affecting cooking and cleaning results. Do not set plastics, paper or other items that could melt or burn near the oven vent.

---

## Baking and Roasting

### Precision Cooking™ System - Precise Bake

The Precise Bake system electronically regulates the oven heat levels during preheat and bake to maintain a precise temperature range for optimal cooking results. The bake and broil elements or burners cycle on and off in intervals. On convection range models, the fan will run while preheating and may be cycled on and off for short intervals during preheating to provide the best results. This feature is automatically activated when the oven is in use.

Before baking and roasting, position racks according to “Positioning Racks and Bakeware” section. When roasting, it is not necessary to wait for the oven preheat cycle to end before putting food in unless it is recommended in the recipe.

### Preheating

When START is pressed, the oven will begin preheating. Once 100°F (38°C) is reached, the display temperature will increase as the actual temperature of the oven increases. When the preheat temperature is reached, a tone will sound, and the selected temperature will appear on the display. The time necessary to preheat the oven to 350°F (177°C) is approximately 10 to 15 minutes, depending on the model.

### Power Preheat

Power Preheat can be used to shorten the preheating time. Only one standard flat rack should be in the oven during Power Preheat. Extra racks should be removed prior to starting Power Preheat. Press POWER PREHEAT and follow the oven control prompts, or, if preheating has already started, simply press POWER PREHEAT. The preheating cycle should be completed before placing food in the oven and should be used only for one-rack baking. When the Power Preheat cycle is complete, the oven starts a normal Bake cycle.

---

## Broiling

Leave the door open 6" (15 cm) at the broil stop position to ensure proper broiling temperature. Preheat the oven for 5 minutes before putting food in unless recommended otherwise in the recipe. Position food on grid in a broiler pan, then place it in the center of the oven rack.

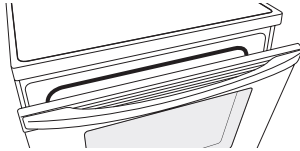

**NOTE:** Odors and smoke are normal the first few times the oven is used or if the oven is heavily soiled.

Changing the temperature when broiling allows more precise control when cooking. The lower the broil setting, the slower the cooking. Thicker cuts and unevenly shaped pieces of meat, fish and poultry may cook better at lower broil settings. Use racks 6 or 7 for broiling. Refer to the “Positioning Racks and Bakeware” section for more information.

On lower settings, the broil element will cycle on and off to maintain the proper temperature.

- For best results, use a broiler pan and grid. It is designed to drain juices and help avoid spatter and smoke.

If you would like to purchase a broiler pan, one may be ordered. Please refer to the “Accessories” section for more information.

---

## Convection Cooking

In a convection oven, the fan-circulated hot air continually distributes heat more evenly than the natural movement of air in a standard thermal oven. This movement of hot air helps maintain a consistent temperature throughout the oven, cooking foods more evenly, crisping surfaces while sealing in moisture and yielding crustier breads.

**IMPORTANT:** With convection cooking, most foods can be cooked at a lower temperature or at a shorter time. This range automatically reduces the set oven temperature by 25°F (15°C) for convection cooking.

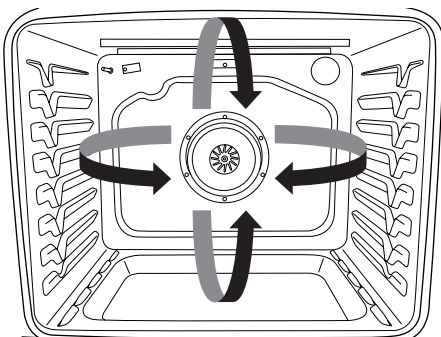

During convection cooking, the bake, broil, and convection elements cycle on and off in intervals to maintain the oven temperature, while the fan circulates the hot air.

If the oven door is opened during convection cooking, the fan will turn off immediately. It will come back on when the oven door is closed.

**NOTE:** The oven door must be closed for convection broiling.

### EvenAir™ True Convection

When convection baking, broiling or roasting enter your normal baking temperature. The control will automatically reduce the set oven temperature by 25°F (15°C).

### Convection Options

Convection Bake - Multiple-rack baking or cookies, biscuits, breads, casseroles, tarts, tortes, cakes.

Convection Broil - Thicker cuts or unevenly shaped pieces of meat, fish or poultry.

Convection Roast - Whole chicken or turkey, vegetables, pork roasts, beef roasts.

## Cook Time

### **WARNING**

#### Food Poisoning Hazard

**Do not let food sit in oven more than one hour before or after cooking.**

**Doing so can result in food poisoning or sickness.**

#### To Set a Timed Cook:

1. Press BAKE, CONVECT BAKE or CONVECT ROAST.
2. Press the number keypads to enter a temperature other than the one displayed.
3. Press COOK TIME. The cook time oven indicator light will light up.
4. Press the number keypads to enter the length of time to cook.
5. Press START. The display will count down the time. When the time ends, the oven will shut off automatically.
6. Press CANCEL to clear the display.

#### To Set a Delayed Timed Cook:

1. Press BAKE, CONVECT BAKE or CONVECT ROAST.
2. Press the number keypads to enter a temperature other than the one displayed.
3. Press COOK TIME. The cook time oven indicator light will light up.
4. Press number keypads to enter the length of time to cook.
5. Press START TIME. The start time/delay oven indicator light will light up.
6. Press number keypads to enter the number of hours and/or minutes you want to delay the start time.
7. Press START.

When the start time is reached, the oven will automatically turn on. The temperature and/or time settings can be changed anytime after pressing Start by repeating steps 1-7. When the set cook time ends, the oven will shut off automatically.

8. Press CANCEL to clear the display.

## Warming Drawer (on some models)

### **WARNING**

#### Food Poisoning Hazard

**Do not let food sit for more than one hour before or after cooking.**

**Doing so can result in food poisoning or sickness.**

The Warming Drawer is ideal for keeping hot cooked foods at serving temperature. It may also be used for warming breads and pastries.

Different types of food may be placed in the warming drawer at the same time. For best results, do not hold foods longer than 1 hour. For smaller quantities, pizza, or heat-sensitive foods, such as eggs, do not hold longer than 30 minutes.

Food must be at serving temperature before being placed in the warming drawer. Breads, pastries, and fruit pies may be heated from room temperature.

Remove food from plastic bags and place in oven-safe container. Cover foods with a lid or aluminum foil.

Do not cover with plastic wrap.

Empty serving dishes and ovenproof dishes can be heated while the warming drawer is preheating. Check the dish manufacturer's recommendations before warming the cookware.

Before using the warming drawer, wash the bottom of the drawer with soap and water. See "General Cleaning" section.

#### To Use:

1. Press WARMING DRAWER.
2. Press START.
3. Allow the warming drawer to preheat for 15 minutes.
4. Place cooked food(s) in warming drawer.
5. Press WARMING DRAWER when finished.

The Warming Drawer operates at a temperature of approximately 160°F (71°C).

# RANGE CARE

## AquaLift™ technology

AquaLift™ Technology is an innovative cleaning solution that utilizes heat and water to release baked-on spills from the oven in less than 1 hour. This new cleaning technology is a low-heat, odor-free alternative to traditional self-cleaning options.

Allow the oven to cool to room temperature before using the Clean cycle. If your oven cavity is above 200°F (93°C), “OVEN COOLING” will appear in the display, and the Clean cycle will not be activated until the oven cavity cools down.

### To Clean:

1. Remove all racks and accessories from the oven cavity and wipe excess soil. Use a plastic scraper to remove easily-removed soils.

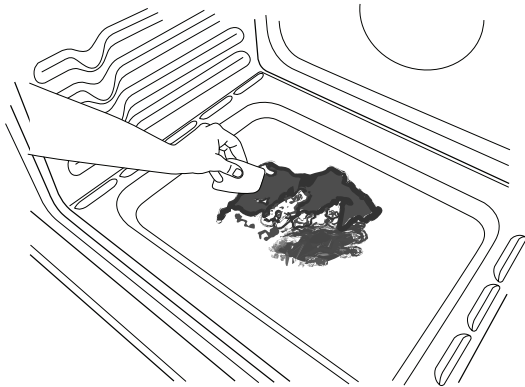

2. Pour 2 cups (16 oz [500 mL]) of distilled or filtered water onto the bottom of the empty oven and close the oven door.

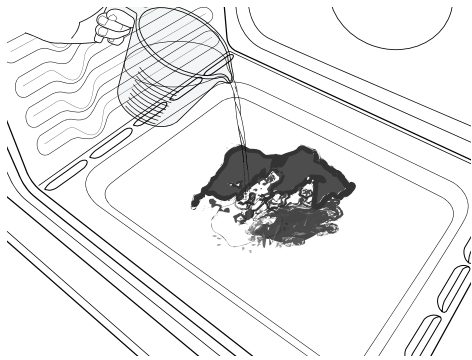

**IMPORTANT:** Do not use chemicals or other additives with the water. Do not open the oven door during the Clean cycle. The water on the oven bottom is hot.

### Clean Cycle

3. Press CLEAN and then START on the oven control panel.
4. Allow 40 minutes for cleaning and cool down. A beep will sound when the Clean cycle is complete.
5. Press CANCEL at the end of the cycle. CANCEL may be pressed at any time to stop the Clean cycle.
6. Remove the residual water and loosened soils with a sponge or cloth immediately after the Clean cycle is complete. Much of the initial 2 cups (16 oz [500 mL]) of water will remain in the oven after the cycle is completed. If additional soils remain, leave a small amount of water in the oven bottom to assist with the cleaning.

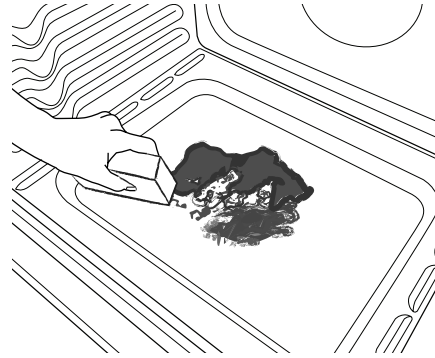

7. If any soils remain, remove them with a non-scratch scrubbing sponge or plastic scraper. Additional Clean cycles may be run to help remove the stubborn soils.

**IMPORTANT:** Do not use oven cleaners. The use of chemicals, including commercial oven cleaners or metal scouring pads, may cause permanent damage to the porcelain surface of the oven interior.

### NOTES:

- The range should be level to ensure that the entire surface of the bottom of the oven cavity is covered by water at the beginning of the Clean cycle.
- For best results, use distilled or filtered water. Tap water may leave mineral deposits on the oven bottom.
- Before removing the residual water and loosened soils at the end of the Clean cycle, insert a cloth or paper towel between the lower edge of the oven door and the front frame to keep water from spilling onto the front of the range and the floor.
- Soil baked on through several cooking cycles will be more difficult to remove with the Clean cycle.
- Nonabrasive scrub sponges or eraser style cleaning pads (without cleaners) can be effective for cleaning the oven cavity walls, oven door and oven bottom for difficult soils. For best results, moisten the pads and sponges before use.
- Run an additional Clean cycle for stubborn soils.
- affresh™ Kitchen and Appliance Cleaner and affresh™ Cooktop Cleaner may be used to clean the oven bottom, walls and door when the oven has finished the cycle and returned to room temperature. Refer to the “Accessories” section for information on ordering.
- Additional AquaLift™ Technology Cleaning Kits may be obtained by ordering Part Number W10423113RP. See the “Accessories” section for more information.
- For assistance with AquaLift™ Technology, call 1-877-258-0808, or visit our website at <http://whr.pl/aqualift>.

---

## General Cleaning

**IMPORTANT:** Before cleaning, make sure all controls are off and the oven and cooktop are cool. Always follow label instructions on cleaning products. For additional information, you can visit the Frequently Asked Questions (FAQs) section of our website at [www.maytag.com](http://www.maytag.com).

Soap, water and a soft cloth or sponge are suggested first unless otherwise noted.

---

### EXTERIOR PORCELAIN ENAMEL SURFACES (on some models)

Food spills containing acids, such as vinegar and tomato, should be cleaned as soon as the entire range is cool. These spills may affect the finish.

#### Cleaning Method:

- Glass cleaner, mild liquid cleaner or nonabrasive scrubbing pad:  
Gently clean around the model and serial number plate because scrubbing may remove numbers.
- affresh™ Kitchen and Appliance Cleaner Part Number W10355010 (not included):  
See the “Accessories” section for more information.

---

### STAINLESS STEEL (on some models)

**NOTE:** To avoid damage to stainless steel surfaces, do not use soap-filled scouring pads, abrasive cleaners, Cooktop Cleaner, steel-wool pads, gritty washcloths or abrasive paper towels. Damage may occur to stainless steel surfaces, even with one-time or limited use.

#### Cleaning Method:

Rub in direction of grain to avoid damaging.

- affresh™ Stainless Steel Cleaner Part Number W10355016:  
See the “Accessories” section for more information.

Liquid detergent or all-purpose cleaner:  
Rinse with clean water and dry with soft, lint-free cloth.

---

### METALLIC PAINT (on some models)

Do not use abrasive cleaners, cleaners with bleach, rust removers, ammonia or sodium hydroxide (lye) because paint surface may stain.

---

### CERAMIC GLASS (on some models)

#### Cleaning Method:

Use affresh™ Cooktop Cleaner Part Number W10355051 with Cooktop Scraper Part Number WA906B to clean and remove stains from the cooktop. Use Cooktop Protectant Part Number 31463A regularly to avoid stain buildup, pitting and scratching, while conditioning the cooktop for easier future cleaning. These can be ordered as accessories. See the “Accessories” section for more information. The Cooktop Scraper uses razor blades. Store razor blades out of the reach of children.

Do not use steel wool, abrasive powder cleansers, chlorine bleach, rust remover or ammonia because damage may occur.

#### Light to moderate soil

- Can be cleaned with damp paper towels or sponge. Light stains should be addressed with cleaner and cleaning pad.

#### Sugary spills (jellies, candy, syrup)

- Clean with cooktop scraper and cooktop cleaner. Scrape off sugary spills while the cooktop is still warm. You may want to wear oven mitts while cleaning the cooktop.

#### Heavy soil, dark streaks, specks and discoloration

- Clean with Cooktop Cleaner or nonabrasive cleaner and cleaning pad.

### Burned-on soil

- Clean with Cooktop Cleaner, Cleaning Pad and Cooktop Scraper.

### Metal marks from aluminum and copper

- Clean with Cooktop Cleaner and Cleaning Pad as soon as cooktop has cooled down. The marks will not totally disappear, but after many cleanings they will become less noticeable.

### Tiny scratches and abrasions

- Use Cooktop Cleaner and Cleaning Pad for scratches. Scratches and abrasions do not affect cooking performance, and after many cleanings they will become less noticeable.

---

## COOKTOP CONTROLS

To avoid damage to the cooktop controls, do not use steel wool, abrasive cleansers or oven cleaner.

To avoid damage, do not soak knobs.

When replacing knobs, make sure knobs are in the Off position.

On some models, do not remove seals under knobs.

#### Cleaning Method:

- Soap and water:  
Pull knobs straight away from control panel to remove.

---

## CONTROL PANEL AND OVEN DOOR EXTERIOR

To avoid damage to the control panel, do not use abrasive cleaners, steel-wool pads, gritty washcloths or abrasive paper towels.

#### Cleaning Method:

- Glass cleaner and soft cloth or sponge:  
Apply glass cleaner to soft cloth or sponge, not directly on panel.
- affresh™ Kitchen and Appliance Cleaner Part Number W10355010 (not included):  
See the “Accessories” section for more information.

---

## OVEN RACKS

#### Cleaning Method:

- Steel-wool pad
- For racks that have discolored and are harder to slide, a light coating of vegetable oil applied to the rack guides will help them slide.

---

## STORAGE DRAWER OR WARMING DRAWER (on some models)

Check that storage drawer or warming drawer is cool and empty before cleaning.

#### Cleaning Method:

- Mild detergent

---

## OVEN CAVITY

Use AquaLift™ Technology regularly to clean oven spills.

Do not use oven cleaners.

Food spills should be cleaned when oven cools. At high temperatures, foods react with porcelain and staining, etching, pitting or faint white spots can result.

#### Cleaning Method:

- Clean cycle: See “Clean Cycle” first.

## Oven Light

The oven light is a standard 40-watt appliance bulb. Before replacing, make sure the oven and cooktop are cool and the control knobs are in the off position.

### To Replace:

1. Unplug range or disconnect power.

2. Turn the glass bulb cover in the back of the oven counterclockwise to remove.
3. Turn bulb counterclockwise to remove from socket.
4. Replace bulb, then bulb cover by turning clockwise.
5. Plug in range or reconnect power.

# TROUBLESHOOTING

First try the solutions suggested here or visit our website and reference FAQs (Frequently Asked Questions) to possibly avoid the cost of a service call.

[www.maytag.com](http://www.maytag.com)

## Operation

| PROBLEM   | POSSIBLE CAUSES  | SOLUTIONS  |
|---|--|--|
| <b>Nothing will operate</b>   | Power supply cord is unplugged.                          | Plug into a grounded outlet.   |
|   | Household fuse is blown or a circuit breaker is tripped. | Replace the fuse or reset the circuit breaker. If the problem continues, call an electrician.  |
|   | Range is in Sabbath Mode.                                | See "Sabbath Mode" section.  |
| <b>Cooktop will not operate</b>   | The control knob is set incorrectly.                     | Push in knob before turning to a setting.  |
|   | The range is in Demo Mode.                               | Demo Mode will deactivate the Warming Center element. See "Demo Mode" in the "Electronic Oven Controls" section.   |
| <b>Excessive heat around cookware on cooktop</b>                          | Cookware that is not the proper size                     | Use cookware about the same size as the surface cooking area, element or surface burner. Cookware should not extend more than ½" (1.3 cm) outside the cooking area.  |
| <b>Cooktop cooking results not what expected</b>                          | Control knob set to incorrect heat level                 | See "Cooktop Use" section.   |
|   | Range is not level.                                      | Level the range. See the Installation Instructions.  |
| <b>Oven will not operate</b>  | The electronic oven control was set incorrectly.         | See "Electronic Oven Controls" section.  |
|   | Delay Start was set.                                     | See "Cook Time" section.   |
|   | The oven control lockout is set.                         | See the control lock keypad feature in the "Feature Guide" section.  |
|   | The range is in Demo Mode.                               | Demo Mode will deactivate all heating elements. See "Demo Mode" in the "Electronic Oven Controls" section.   |
| <b>Convection fan not working</b>   | Oven door is open.                                       | Close oven door. See "Convection Cooking" section.   |
| <b>Oven temperature too high or too low</b>                               | Oven temperature calibration needs adjustment            | See "Oven Temperature Control" in the "Electronic Oven Controls" section.  |
|   | Temperature has been changed to Fahrenheit or Celsius.   | See "Fahrenheit and Celsius" in the Electronic Oven Controls" section.   |
| <b>Oven indicator lights flash</b>  | Needs service (oven indicator lights are flashing)       | See "Control Display" in the "Electronic Oven Controls" section. If the indicator light(s) keeps flashing, call for service. See cover for contact information.  |
| <b>Display shows messages</b>   | Power failure (display shows flashing time)              | Clear the display. On some models, reset the clock, if needed. See "Clock" keypad feature in the "Feature Guide" section.  |
|   | Error code (display shows letter followed by number)     | Press the CANCEL keypad to clear the display. See "Control Display" in the "Electronic Oven Controls" section. If it reappears, call for service. See cover for contact information.   |
| <b>Mineral deposits are left on the oven bottom after the Clean cycle</b> | Tap water was used in the Clean cycle.                   | Use distilled or filtered water in the Clean cycle.<br>To remove deposits, use a cloth soaked with vinegar. Then use a cloth dampened with water to thoroughly remove any vinegar residue.   |
|   | Range is not level.                                      | Mineral deposits will collect on dry areas of the oven bottom during the Clean cycle. Level the range. See the Installation Instructions.<br>To remove deposits, use a cloth soaked with vinegar. Then use a cloth dampened with water to thoroughly remove any vinegar residue. |



| PROBLEM   | POSSIBLE CAUSES   | SOLUTIONS   |
|---|---|---|
| <b>Oven cooking results not what expected</b>             | Range is not level.   | Level the range. See the Installation Instructions.                               |
|   | The temperature set was incorrect.  | Double-check the recipe in a reliable cookbook.                                   |
|   | Oven temperature is calibrated incorrectly.   | See "Oven Temperature Control" in the "Electronic Oven Controls" section.         |
|   | Oven was not preheated.   | See "Baking and Roasting" section.  |
|   | Racks were positioned improperly.   | See "Positioning Racks and Bakeware" section.                                     |
|   | Not enough air circulation around bakeware  | See "Positioning Racks and Bakeware" section.                                     |
|   | Batter distributed unevenly in pan  | Check that batter is level in the pan.  |
|   | Darker browning of food caused by dull or dark bakeware   | Lower oven temperature 25°F (15°C) or move rack to a higher position in the oven. |
|   | Lighter browning of food caused by shiny or light colored bakeware  | Move rack to a lower position in the oven.  |
|   | Incorrect length of cooking time was used.  | Adjust cooking time.  |
|   | Oven door was not closed.   | Be sure that the bakeware does not keep the door from closing.                    |
|   | Oven door was opened during cooking.  | Oven peeking releases oven heat and can result in longer cooking times.           |
|   | Rack is too close to bake burner, making baked items too brown on bottom.   | Move rack to higher position in the oven.   |
| Pie crusts browning too quickly                           | Use aluminum foil to cover the edge of the crust and/or reduce baking temperature.  |   |
| Temperature scale was changed from Fahrenheit to Celsius. | Foods are overdone or burnt even at low temperatures. See "Fahrenheit and Celsius" in the "Electronic Oven Controls" section. |   |

## ACCESSORIES

For accessories, you can visit our website at [www.maytag.com/cookingaccessories](http://www.maytag.com/cookingaccessories).

### Cooktop Care Kit

(ceramic glass models)  
(includes cleaner, protectant, scraper, and applicator pads)  
Order Part Number 31605

### Cooktop Protectant

(ceramic glass models)  
Order Part Number 31463A

### affresh™ Stainless Steel Cleaning Wipes

(stainless steel models)  
Order Part Number W10355049

### affresh™ Cooktop Cleaner

(ceramic glass models)  
Order Part Number W10355051

### affresh™ Stainless Steel Cleaner

(stainless steel models)  
Order Part Number W10355016

### affresh™ Kitchen and Appliance Cleaner

Order Part Number W10355010

### AquaLift™ Technology Oven Cleaning Kit

Order Part Number W10423113RP

### Cooktop Cleaning Pads

(ceramic glass models)  
Order Part Number 31609

### Cooktop Scraper

(ceramic glass models)  
Order Part Number WA906B

### Granite Cleaner and Polish

Order Part Number W10275756

### Cooktop Protectant Applicator

(ceramic glass models)  
Order Part Number 31610

### Gas Grate and Drip Pan Cleaner

Order Part Number 31617A

### Gourmet Griddle

Order Part Number 4396096RB

### Standard Flat Oven Rack

Order Part Number W10179196

### Split Oven Rack

Order Part Number W10205524

### Max Capacity Oven Rack

Order Part Number W10289145

### Porcelain Broiler Pan and Grid

Order Part Number 4396923

### Premium Broil Pan and Roasting Rack

Order Part Number W10123240  
[www.maytag.com/broilerpan](http://www.maytag.com/broilerpan)

---

# MAYTAG® ELECTRIC RANGE LIMITED WARRANTY

---

## FIRST YEAR LIMITED WARRANTY (PARTS AND LABOR)

For one year from the date of purchase, when this major appliance is installed, operated and maintained according to instructions attached to or furnished with the product, Maytag brand of Whirlpool Corporation or Whirlpool Canada, LP (hereafter "Maytag") will pay for factory specified replacement parts and repair labor to correct defects in materials or workmanship that existed when this major appliance was purchased.

## SECOND THROUGH TENTH YEAR LIMITED WARRANTY (CERTAIN COMPONENT PARTS ONLY - LABOR NOT INCLUDED)

In the second through tenth years from the date of original purchase, when this major appliance is installed, operated and maintained according to instructions attached to or furnished with the product, Maytag will pay for factory specified parts for the following components to correct non-cosmetic defects in materials or workmanship in this part that prevent function of the range and that existed when this major appliance was purchased. This is a limited 10-year warranty on the below named parts only and does not include labor.

- Glass-ceramic cooktop, if due to thermal breakage
- Electric surface elements
- Electric bake/broil oven elements (excludes convection element)

YOUR SOLE AND EXCLUSIVE REMEDY UNDER THE LIMITED WARRANTY SHALL BE PRODUCT REPAIR AS PROVIDED HEREIN. Service must be provided by a Maytag designated service company. This limited warranty is valid in the United States or Canada and applies only when the major appliance is used in the country in which it was purchased. This limited warranty is effective from the date of the original consumer purchase. Proof of original purchase date is required to obtain service under this limited warranty.

---

## ITEMS EXCLUDED FROM WARRANTY

### This limited warranty does not cover:

1. Service calls to correct the installation of your major appliance, to instruct you on how to use your major appliance, to replace or repair house fuses, or to correct house wiring or plumbing.
2. Service calls to repair or replace appliance light bulbs, air filters or water filters. Consumable parts are excluded from warranty coverage.
3. Repairs when your major appliance is used for other than normal, single-family household use or when it is used in a manner that is contrary to published user or operator instructions and/or installation instructions.
4. Damage resulting from accident, alteration, misuse, abuse, fire, flood, acts of God, improper installation, installation not in accordance with electrical or plumbing codes, or use of consumables or cleaning products not approved by Maytag.
5. Cosmetic damage, including scratches, dents, chips or other damage to the finish of your major appliance, unless such damage results from defects in materials or workmanship and is reported to Maytag within 30 days from the date of purchase.
6. Any food loss due to refrigerator or freezer product failures.
7. Costs associated with the removal from your home of your major appliance for repairs. This major appliance is designed to be repaired in the home and only in-home service is covered by this warranty.
8. Repairs to parts or systems resulting from unauthorized modifications made to the appliance.
9. Expenses for travel and transportation for product service if your major appliance is located in a remote area where service by an authorized Maytag servicer is not available.
10. The removal and reinstallation of your major appliance if it is installed in an inaccessible location or is not installed in accordance with published installation instructions.
11. Major appliances with original model/serial numbers that have been removed, altered or cannot be easily determined. This warranty is void if the factory applied serial number has been altered or removed from your major appliance.

The cost of repair or replacement under these excluded circumstances shall be borne by the customer.

---

## DISCLAIMER OF IMPLIED WARRANTIES; LIMITATION OF REMEDIES

CUSTOMER'S SOLE AND EXCLUSIVE REMEDY UNDER THIS LIMITED WARRANTY SHALL BE PRODUCT REPAIR AS PROVIDED HEREIN. IMPLIED WARRANTIES, INCLUDING WARRANTIES OF MERCHANTABILITY OR FITNESS FOR A PARTICULAR PURPOSE, ARE LIMITED TO ONE YEAR OR THE SHORTEST PERIOD ALLOWED BY LAW. MAYTAG SHALL NOT BE LIABLE FOR INCIDENTAL OR CONSEQUENTIAL DAMAGES. SOME STATES AND PROVINCES DO NOT ALLOW THE EXCLUSION OR LIMITATION OF INCIDENTAL OR CONSEQUENTIAL DAMAGES, OR LIMITATIONS ON THE DURATION OF IMPLIED WARRANTIES OF MERCHANTABILITY OR FITNESS, SO THESE EXCLUSIONS OR LIMITATIONS MAY NOT APPLY TO YOU. THIS WARRANTY GIVES YOU SPECIFIC LEGAL RIGHTS, AND YOU MAY ALSO HAVE OTHER RIGHTS WHICH VARY FROM STATE TO STATE OR PROVINCE TO PROVINCE.

---

If outside the 50 United States and Canada, contact your authorized Maytag dealer to determine if another warranty applies.

5/10

---

For additional product information, visit [www.maytag.com](http://www.maytag.com).

If you do not have access to the Internet and you need assistance using your product or you would like to schedule service, you may contact us at the number below.

*Have your complete model number ready. You can find your model number and serial number on the label, located on the oven frame behind the top right side of the oven door.*

For assistance or service, call 1-800-688-9900.

If you need further assistance, you can write with any questions or concerns to the address below:

Maytag Brand Home Appliances  
Customer eXperience Center  
553 Benson Road  
Benton Harbor, MI 49022-2692

Please include a daytime phone number in your correspondence.

Please keep these User Instructions and model number information for future reference.

**W10392923C**  
**SP PN W10454297A**  
© 2011  
All rights reserved.

®Registered trademark/™ Trademark of Maytag Properties, LLC, or its related companies.  
AQUALIFT and AQUALIFT Design are trademarks of Whirlpool, U.S.A.  
TM AFFRESH is a trademark of Whirlpool, U.S.A.

12/11  
Printed in U.S.A.

## Free Manuals Download Website

<http://myh66.com>

<http://usermanuals.us>

<http://www.somanuals.com>

<http://www.4manuals.cc>

<http://www.manual-lib.com>

<http://www.404manual.com>

<http://www.luxmanual.com>

<http://aubethermostatmanual.com>

Golf course search by state

<http://golfingnear.com>

Email search by domain

<http://emailbydomain.com>

Auto manuals search

<http://auto.somanuals.com>

TV manuals search

<http://tv.somanuals.com>