



MAYTAG USER'S GUIDE

Electric Range with Electronic Control

TABLE OF CONTENTS

IMPORTANT SAFETY INSTRUCTIONS	2-4	• Oven Window	15
RANGE FEATURES	5	• Oven Vent	16
CLOCK AND OVEN CONTROL	6-7	• Oven Light	16
ABOUT YOUR COOKTOP	8-10	• Oven Racks	16
• Cooktop	8	• Storage Drawer	17
• Coil Elements	9	• Leveling Legs	17
• Drip Bowls	9	ABOUT CLEANING	18-22
• Smoothtop Cooktop	10	• Self-Clean Oven Feature	18-19
ABOUT YOUR OVEN	11-14	• Cleaning Chart	20-22
• How To Set Oven	11	ABOUT COOKING	23-28
• Automatic Oven Timed Cook Feature	12	• Surface Cooking	23-24
• How To Set Broil	13	• Aluminum Foil Usage	25
• Oven Characteristics	14	• Baking & Roasting	25-27
• Oven Temperature Adjustment	31	• Broiling	28
ABOUT YOUR RANGE	15-17	ABOUT SERVICE	29-32
• Oven Door	15	• Troubleshooting Chart	29-31
• Door Lock Lever	15	• How To Receive Service	32
		WARRANTY	32

INSTALLER Please leave this manual with this appliance.

CONSUMER Please read and keep this manual for future reference. Keep sales receipt and/or cancelled check as proof of purchase.

Model Number: _____

Serial Number: _____

Date of Purchase: _____

Model and serial numbers are on the rating plate. See page 5 for location.

FOR MAYTAG CUSTOMER ASSISTANCE CALL 1-800-688-9900 US
1-800-688-2002 CANADA

8111P375-60
(08-99-01)

74003845

2

IMPORTANT SAFETY INSTRUCTIONS

Thank You . . . for purchasing our cooking appliance. To help you obtain the maximum in cooking satisfaction, we offer these suggestions:

- ☞ Read this manual before using the appliance.
- ☞ Review all safety and caution instructions.
- ☞ Review the Troubleshooting Chart on pages 29 to 31 if service becomes necessary.
- ☞ Include the model and serial numbers of your appliance when requesting service.
 - Proof of purchase such as sales receipt will be needed for warranty service.

☞ You can contact us at:

MAYTAG CONSUMER EDUCATION
ONE DEPENDABILITY SQUARE
NEWTON, IOWA 50208
(515) 791-8911
(Monday - Friday, 8 am - 5 pm CST)
Internet: <http://www.maytag.com>

In our continuing effort to improve the quality and performance of our cooking appliances, it may be necessary to make changes to the appliance without revising this manual.

MODELS: MER5510 and MER5530

IMPORTANT INSTRUCTIONS

Read and follow all instructions before using this appliance to prevent the potential risk of fire, electric shock, personal injury or damage to the appliance as a result of improper usage of the appliance. Use appliance only for its intended purpose as described in this manual.

To ensure proper and safe operation: Appliance must be properly installed and grounded by a qualified technician.

	<h3> WARNING</h3> <ul style="list-style-type: none">• ALL RANGES CAN TIP AND CAUSE INJURIES TO PERSONS.• INSTALL ANTI-TIP DEVICES PACKED WITH RANGE.• FOLLOW ALL INSTALLATION INSTRUCTIONS.
--	--

WARNING: To reduce risk of tipping of the appliance from abnormal usage or by excessive loading of the oven door, the appliance must be secured by a properly installed anti-tip device.

To check if device is properly installed, remove storage drawer and look underneath range to make sure one of the rear leveling legs is properly engaged in the bracket slot. The anti-tip device secures the rear leveling leg to the floor when properly engaged. You should check this **anytime** the range has been moved.

IN CASE OF FIRE

Turn off appliance and ventilating hood to avoid spreading the flame. Extinguish flame then turn on hood to remove smoke and odor.

- **Cooktop:** Smother fire or flame in a pan with a lid or cookie sheet.

NEVER pick up or move a flaming pan.

- **Oven:** Smother fire or flame by closing the oven door.

Do not use water on grease fires. Use baking soda, a dry chemical or foam-type extinguisher to smother fire or flame.



IMPORTANT SAFETY INSTRUCTIONS

3

GENERAL INSTRUCTIONS

WARNING: NEVER use appliance door, or drawer, if equipped, as a step stool or seat as this may result in possible tipping of the appliance, damage to the appliance, and serious injuries.



If appliance is installed near a window, proper precautions should be taken to prevent curtains from blowing over surface elements.

NEVER use appliance to warm or heat the room. Failure to follow this instruction can lead to possible burns, injury, fire, or damage to the appliance.

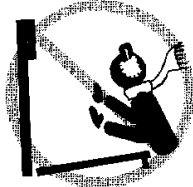

NEVER wear loose-fitting or hanging garments while using the appliance. Clothing could catch utensil handles or ignite and cause burns if garment comes in contact with hot heating elements.



To ensure proper operation and to avoid damage to the appliance or possible injury, do not adjust, service, repair or replace any part of the appliance unless specifically recommended in this manual. Refer all other servicing to a qualified technician.

NEVER store or use gasoline or other combustible or flammable materials in the oven, near surface units or in the vicinity of this appliance as fumes could create a fire hazard or an explosion.

To prevent grease fires, do not let cooking grease or other flammable materials accumulate in or near the appliance.

Use only dry potholders. Moist or damp potholders on hot surfaces may result in a steam burn. Do not let potholder touch hot heating elements. Do not use a towel or other bulky cloth which could easily touch hot heating elements and ignite.

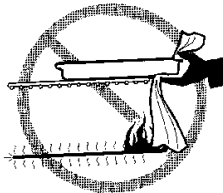

Always turn off all controls when cooking is completed.

NEVER heat unopened containers on the surface unit or in the oven. Pressure build-up in the container may cause container to burst resulting in burns, injury or damage to the appliance.

NEVER use aluminum foil to line drip bowls, or to cover an oven rack or oven bottom. Misuse could result in risk of electric shock, fire, or damage to the appliance. Use foil only as directed in this manual.

COOKTOP

NEVER leave surface units unattended especially when using high heat settings. An unattended boilover could cause smoking and a greasy spillover can cause a fire.



This appliance is equipped with different size surface elements. Select pans having flat bottoms large enough to cover element. Proper relationship of pan to element will improve cooking efficiency.

If pan is smaller than element, a portion of the element will be exposed to direct contact and could ignite clothing or potholder.

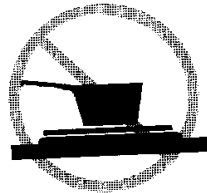

Only use certain types of glass, glass/ceramic, ceramic, earthenware, or other glazed utensils suitable for cooktop or oven service that will not break due to the sudden change in temperature. Follow utensil manufacturer's instructions when using glass.

Turn pan handle toward center of cooktop, not out into the room or over another surface element. This reduces the risk of burns, ignition of flammable materials, or spillage if pan is accidentally bumped or reached by small children.



To prevent damage to removable heating elements, do not immerse, soak or clean in a dishwasher or self-clean oven. A damaged element could short resulting in a fire or shock hazard.

Make sure drip bowls are in place as absence of these bowls during cooking could damage wiring or parts.

SMOOTHTOP

NEVER cook on broken cooktop. Contact a qualified technician immediately. If cooktop should break, cleaning solutions and spillovers may penetrate the broken cooktop and create a risk of electric shock.

Clean cooktop with caution. Some cleaners can produce noxious fumes if applied to a hot surface. If a wet sponge, cloth, or paper towel is used to wipe spills on a hot cooking area, be careful to avoid steam burn.

OVEN

Use care when opening door. Let hot air or steam escape before removing or replacing food.

For proper oven operation and performance, do not block or obstruct oven vent duct.

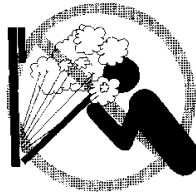

Always place oven racks in desired locations while oven is cool. If rack must be moved while oven is hot, do not let potholder contact hot heating element in oven.

SELF-CLEANING OVEN

Clean only parts listed in this manual. Do not clean door gasket. The gasket is essential for a good seal. Care should be taken not to rub, damage, or move the gasket.

Do not use oven cleaners. No commercial oven cleaner or oven liner protective coating of any kind should be used in or around any part of the oven.

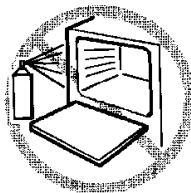

Before self-cleaning the oven, remove broiler pan, oven racks and other utensils to prevent excessive smoking, discoloration of the oven racks or possible damage to utensils.

Wipe up excessive spillovers, especially greasy spills, before the clean cycle to prevent excessive smoking or flare-ups.

It is normal for the cooktop to become hot during a clean cycle. Therefore, avoid touching or lifting the cooktop during a clean cycle.

VENTILATING HOODS

Clean range hood and filters frequently to prevent grease or other flammable materials from accumulating on hood or filter and to avoid grease fires.

Turn the fan on when flambéing foods (such as Cherry Jubilee) under the hood.

DEEP FAT FRYERS

Use extreme caution when moving the grease kettle or disposing of hot grease. Allow grease to cool before attempting to move pan.

CHILD SAFETY

NEVER leave children alone or unsupervised in area where appliance is in use or is still hot.

NEVER allow children to sit or stand on any part of the appliance as they could be injured or burned.

CAUTION: NEVER store items of interest to children in cabinets above an appliance or on backguard of a range. Children climbing on appliance, door or drawer to reach items could damage the appliance or be burned or seriously injured.

Children must be taught that the appliance and utensils in or on it can be hot. Let hot utensils cool in a safe place, out of reach of small children. Children should be taught that an appliance is not a toy. Children should not be allowed to play with controls or other parts of the unit.

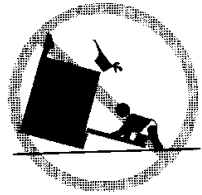

HEATING ELEMENTS

NEVER touch surface or oven heating elements, areas near elements or interior surfaces of oven.

Heating elements may be hot even though they are dark in color. Areas near surface elements and interior surfaces of an oven may become hot enough to cause burns. During and after use, do not touch or let clothing or other flammable materials contact heating elements, areas near elements, or interior surfaces of oven until they have had sufficient time to cool.

Other potentially hot surfaces include: Cooktop, areas facing the cooktop, oven vent opening, surfaces near the vent opening, oven door, areas around the door, and oven window.

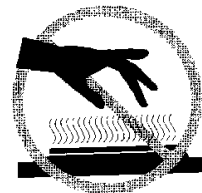

IMPORTANT SAFETY NOTICE & WARNING

The California Safe Drinking Water and Toxic Enforcement Act of 1986 (Proposition 65) requires the Governor of California to publish a list of substances known to the State of California to cause cancer or reproductive harm, and requires businesses to warn customers of potential exposures to such substances.

Users of this appliance are hereby warned that when the oven is engaged in the self-clean cycle, there may be some low level exposure to some of the listed substances including carbon monoxide. Exposure to these substances can be minimized by properly venting the oven to the outdoors during the self-clean cycle by opening a window and/or door in the room where the appliance is located.

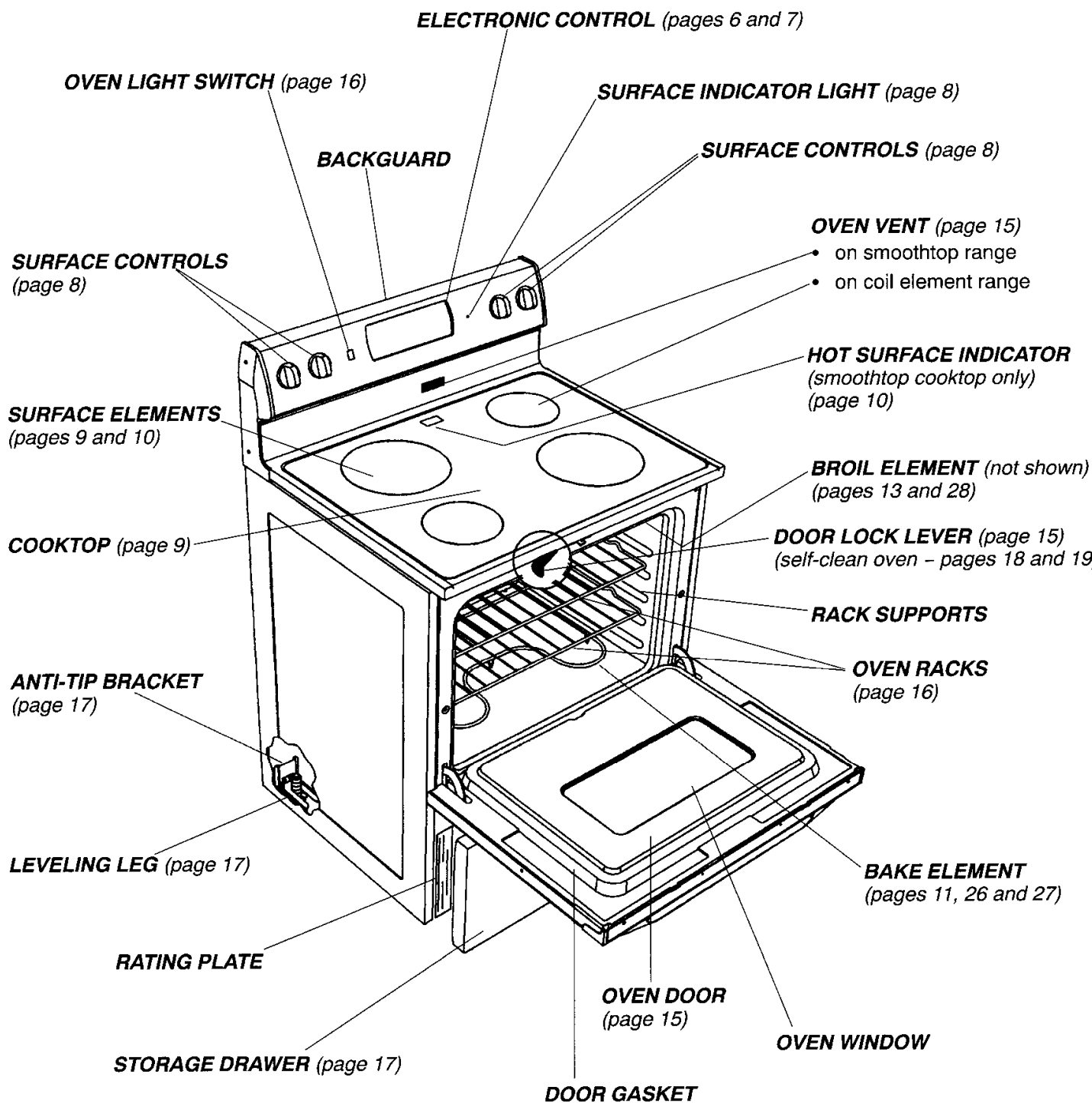

CLOCK AND OVEN CONTROL

Press this pad to cancel all operations except the TIMER. The time of day will reappear in the display.

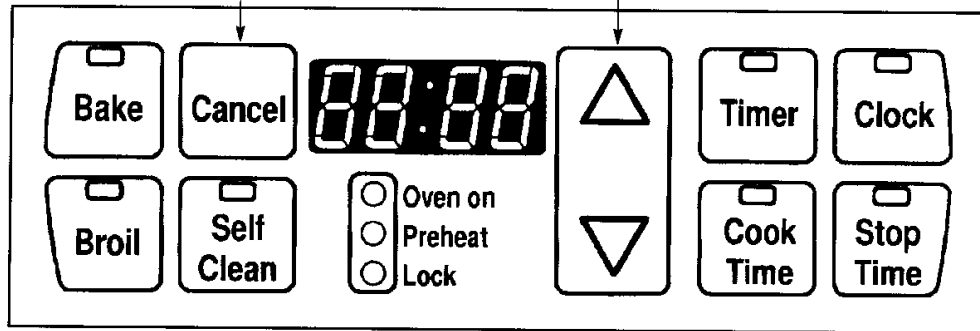

Press or press and hold these pads to enter time, oven temperature or to select HI or LO broil.

ABOUT THE FUNCTION PADS

- Function pads are the BAKE, BROIL, SELF-CLEAN, TIMER, CLOCK, COOK TIME, STOP TIME, and CANCEL pads. A beep will sound when these pads are pressed.
- No beep will sound when the ▲ or ▼ pad is pressed.

- All function pads except the CANCEL pad feature an indicator light.

When the BAKE or BROIL pad is pressed, the indicator light will turn on to let you know that the oven is set for this operation.



Indicator lights on SELF-CLEAN, TIMER, CLOCK, COOK TIME and STOP TIME pads will **flash** when the pad is pressed. These indicator lights will stop flashing but will remain lit once the function starts.

- If an indicator light on a function pad is lit and you set a second operation:
 - Either the control will not accept the operation or
 - The indicator light on the first pad will "dim" slightly and the indicator light on the pad you just pressed will be "full on." This lets you know that you have set the control for two operations.

For example: If you set the oven to bake at 350°F and then set a timing operation, the indicator light on the BAKE pad will "dim" and the indicator light on the TIMER pad will be "full on."



The display will show the operation for the pad with the "full on" indicator light. Press the function pad with the "dim" indicator light to recall that operation.

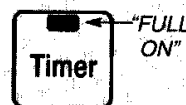

HOW TO SET CLOCK

- Press CLOCK pad.

- Press or press and hold ▲ or ▼ pad until correct time of day appears in display.



then

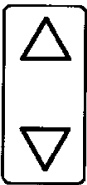

Display will flash when power is supplied to unit.

Press CLOCK pad. To recall time of day when another function is displayed.

Clock time cannot be changed if oven is set for timed bake or delayed clean operation. Cancel the operation before setting the clock.

If timer is in use, press CLOCK pad **once** to recall the time of day or **twice** to reset the time of day.

CLOCK DISPLAY DISABLE FEATURE

If you prefer that the time of day is not displayed:

- Press and hold **both** CLOCK and CANCEL pads **for 3 seconds**.



and



When clock display is disabled, press CLOCK pad to recall time of day for 4 seconds. Display will then blank.

If a power failure occurs when the clock has been disabled, the display remains blank and will not flash when power is restored.

Repeat step 1 to reactivate clock feature.

HOW TO SET TIMER

1. Press TIMER pad.
2. Press or press and hold ▲ or ▼ pad until correct time appears in display.

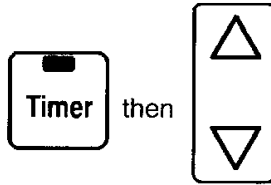

The timer feature does not operate the oven.

The timer can be set from 1 minute [0:01] up to 9 hours and 50 minutes [9:50].

The timer will start automatically. The TIMER indicator on the TIMER pad will light whenever the timer is in use. One long beep and "End" will be briefly displayed to signal the end of the timer operation.

To cancel timer: Press and hold TIMER pad for 3 seconds. Time of day will reappear in the display.

12 HOUR ENERGY SAVER FEATURE

The 12 Hour Energy Saver feature automatically turns off the oven if it was accidentally left on for 12 hours. To deactivate this feature so the oven will NOT turn off automatically at the end of 12 hours:

1. Press and hold CLOCK pad for 3 seconds.
2. Press ▲ or ▼ pad until 8:88 appears in the display. Current time of day will reappear in the display after 4 seconds.

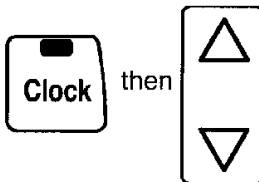

Repeat steps 1 and 2 to reactivate the 12 Hour Energy Saver feature. 12:00 will appear in display to indicate the Energy Saver feature is restored.

CONTROL LOCK-OUT FEATURE

The Control Lock-Out feature prevents the oven from being turned on.

To activate:

1. Press and hold both STOP TIME and CANCEL pads for 3 seconds.

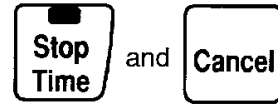

2. "OFF" will appear in display when this feature is activated. Only the clock and timer functions will operate when Control Lock-Out feature is activated.

Repeat step 1 to deactivate.

"END OF TIMED COOK" BEEPS

You have a choice of three "end of cooking" reminder beeps for the Automatic Oven Timer feature.

- **Option 1:** Four beeps then one beep every 30 seconds for the next 5 minutes or until CANCEL pad is pressed. (Default option.)
- **Option 2:** Four beeps. There are no other beeps.
- **Option 3:** Four beeps then one beep every minute for the next 12 hours or until CANCEL pad is pressed.

How to select the desired option:

1. Press and hold both COOK TIME and CLOCK pads for 3 seconds.

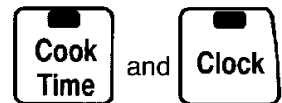

- A single beep will sound.
- Display will show current option.

2. Press ▲ or ▼ pad to select the option number you wish. The current time of day will reappear in the display after 4 seconds.

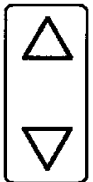

**Before cooking . . .**

- Always place a pan on the surface unit **before** you turn it on. To prevent damage to range, **never** operate surface unit without a pan in place.
- **NEVER** use the cooktop as a storage area for food or cookware.

During cooking . . .

- Be sure you know which knob controls which surface unit. Make sure you turned on the correct surface unit.
- Begin cooking on a higher heat setting then **reduce** to a lower setting to complete the operation. Never use a high heat setting for extended cooking.
- **NEVER** allow a pan to boil dry. This could damage the pan and the appliance.
- **NEVER** touch cooktop until it has cooled. Expect some parts of the cooktop, especially around the surface units, to become warm or hot during cooking. Use potholders to protect hands.

After cooking . . .

- Be sure surface element is off after cooking.
- Clean up greasy spills as soon as possible.

Other tips . . .

- To eliminate the hazard of reaching over hot surface elements do not install cabinet storage directly above a unit.
- If storage is provided, limit it to items that are infrequently used and can be safely stored in an area subjected to heat.
- Temperatures may be unsafe for items such as volatile liquids, cleaners or aerosol sprays.
- Aerosol-type spray cans are **EXPLOSIVE** or highly flammable when exposed to heat. Avoid their use or storage near an appliance.
- **NEVER** leave any items, especially plastic items, unattended on the cooktop. The hot air from the vent may ignite flammable items, melt or soften plastics, or increase pressure in closed containers causing them to burst.
- **NEVER** allow aluminum foil, meat probes or any other metal object, other than a utensil on a surface element, to contact heating elements.

HOW TO OPERATE SURFACE UNIT

1. Place pan on surface unit.

2. Push in and turn knob to desired setting.

- Each knob is identified by international symbols located below each knob.
- Knob can be turned in either direction.
- Knob can be set on any number or between any numbers.

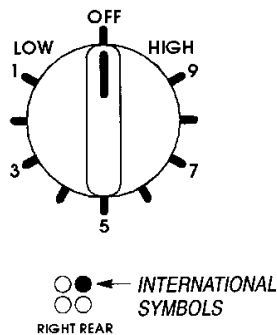
**SURFACE INDICATOR LIGHT**

A SURFACE indicator light, located on the backguard, will turn on whenever a surface unit is turned on. Light will turn off when surface unit is turned off.

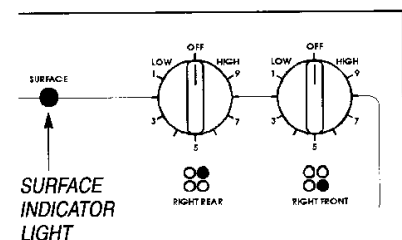

3. After cooking, turn knob to OFF then remove pan.

COOKTOP

Freestanding ranges with a coil element cooktop will feature a lift-up cooktop.

The smoothtop cooktop does not lift up.

To prevent staining or discoloration of cooktop:

- Clean cooktop after each use.
- Wipe acid or sugar stains as soon as they occur as these stains may discolor or etch the porcelain.

To raise the cooktop:

1. When cool, grasp the front edge of the cooktop.
2. Gently lift up until the two support rods, at the front of the cooktop, snap into place.

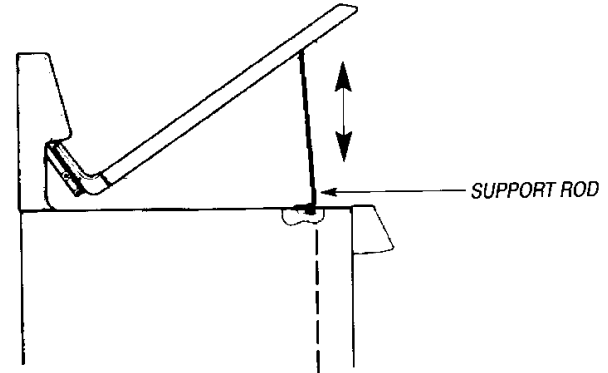

To lower the cooktop:

1. Hold the front edge of the cooktop and carefully push back on each support rod to release the notched support.
2. Then gently lower the top into place. The support rods will slide into the range frame.

COIL ELEMENTS, select models

- When an element is turned on, it will cycle on and off to maintain the heat setting.
- Coil surface elements are self-cleaning.
- Do not immerse elements in water.

To remove element:

1. When cool, raise element.
2. Carefully pull out and away from receptacle.

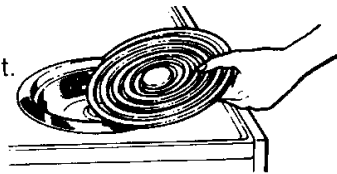

To replace element:

1. Insert terminals on the element into receptacle.
2. Gently lift up on outer edge of element while inserting terminals into receptacle.
3. Gently press down on outer edge of element until element sits level on drip bowl.



NOTE: When replacing element, be sure support leg on element is inserted into the slot in the front of the drip bowl.

DRIP BOWLS, select models

- Be sure drip bowl is properly installed and in place.
- Drip bowl will not "rock" when installed properly. Notch above opening on bowl should be centered over screw that secures receptacle to the cooktop.
- Absence of these bowls during cooking may subject wiring or component parts underneath the cooktop to damage.
- To prevent risk of electric shock or fire, never line drip bowls with aluminum foil.

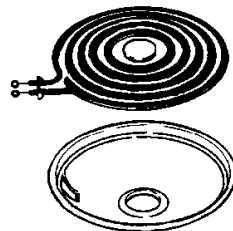

Your range will be equipped with either chrome plated or porcelain coated steel drip bowls.

- **Chrome** drip bowls will turn blue or gold over time or if overheated. This type of discoloration is normal and permanent. It will not affect cooking performance.
- To protect the **chrome** or **porcelain** finish:
 - Avoid using high settings for long periods of time.
 - Reduce to a lower setting once food begins cooking.
 - Do not use oversized cookware. Pan should not extend more than 1 inch from the element.
 - Clean bowls after each use.



CAUTION

NEVER use cooktop if the smoothtop is cracked, broken, or if metal melts onto the top. Call an authorized servicer. Do not attempt to repair it yourself.

SMOOTHTOP COOKTOP, select models

- **Canadian models only:**
 - Freestanding ranges: The right front surface element will not operate during a self-clean operation.
 - Slide-in and drop-in ranges: The cooktop will not operate during a self-clean operation.
- Cooktop may emit a light smoke and odor the first few times cooktop is used. This is normal.
- Element under smoothtop cycles on and off to maintain the preset heat setting. Element will glow red when it cycles ON.
- Smoothtop **RETAINS** heat for a period of time after the unit is turned off. When the **HOT SURFACE** light turns off, cooktop will be cool enough to touch.
- Before using cooktop for the first time, clean it thoroughly as directed in the cleaning chart on page 22. This will protect the smoothtop and will guarantee a clean cooktop when the elements are turned on.

Aluminum foil will damage the smoothtop if it melts onto the top. Never use aluminum foil or foil-type disposable containers such as popcorn poppers. They may leave metal marks or may permanently melt onto the smoothtop.

Important: Watch sugary or starchy solutions carefully to avoid boilovers. If a sugar solution (jam, jelly, candy) or a starch solution (potatoes, rice) boils over, it may pit or discolor the smoothtop. Turn element to **LOW** and clean boilover **immediately**. See page 22 for cleaning instructions.

HOT SURFACE LIGHT

HOT SURFACE light will turn on when smoothtop cooktop is hot. Light will turn off when top cools. Hot surface light is located either on the backguard or at the back center of the cooktop.

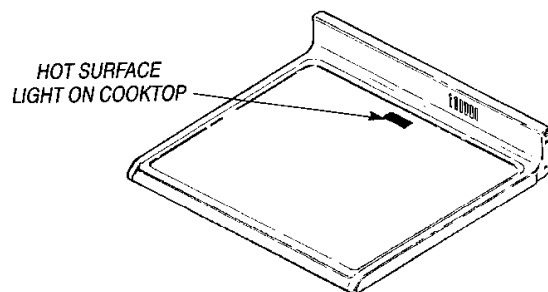
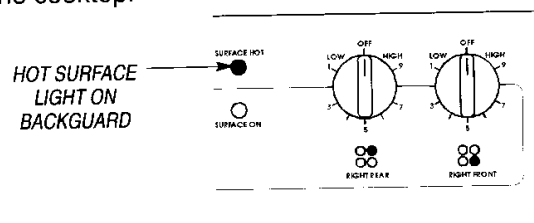

TIPS TO PROTECT SMOOTHTOP COOKTOP

TO PROTECT SMOOTHTOP from scratching, chipping, etching, or metal marks:

- Clean smoothtop after each use.
- Never let pan boil dry as this will permanently damage top.
- Never use smoothtop as a work surface or cutting board.
- Never cook food directly on smoothtop.
- Never place trivet or wok ring between top and pan. These items can mark or etch the top.
- Never place plastics on warm or hot smoothtop. Plastic may melt onto top. Top may chip or pit in attempting to remove plastic.
- Never leave sugar, salt, sand, soil, shortening, or fat on smoothtop. They may scratch or damage top.
- Only use flat-bottom pans that are free of soil, rough areas, nicks or scratches as these may soil or scratch the top.

HOW TO SET OVEN TO BAKE OR ROAST

1. Press BAKE pad.

- BAKE indicator on the BAKE pad will light.
- 000 will light in display.

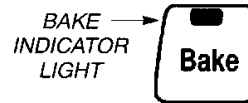

2. Press or press and hold ▲ or ▼ pad to select oven temperature.

- 350° will light when either pad is pressed.
- Oven temperature can be set from 170° to 550°.

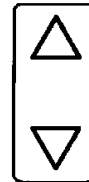

3. There will be a 4 second delay before the oven turns on. When the oven turns on:

- OVEN ON indicator will light.
- PREHEAT indicator will light.
- The preselected temperature will remain in display.



4. Allow 8 to 15 minutes for the oven to preheat.

- A single beep will indicate that the oven has preheated.
- The OVEN ON indicator will remain lit.
- The PREHEAT indicator will turn off.



5. Place food in the oven.

NOTE: The oven temperature can be changed at any time. If the temperature is changed, the PREHEAT indicator will turn back on until the new temperature is reached. A beep will signal that the new temperature has been reached.

6. Check cooking progress at the minimum cooking time. Cook longer if needed.

NOTE: See pages 25, 26, and 27 for additional information on baking and roasting.

7. Press CANCEL pad and remove food from the oven.

- The BAKE indicator on the BAKE pad will turn off.
- The OVEN ON indicator will turn off.
- Time of day will reappear in display.

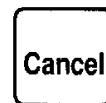

NOTE: If you forget to turn off the oven, it will automatically turn off at the end of 12 hours. If you wish to deactivate this energy saving feature, see page 7.

CAUTION

- Highly perishable foods such as dairy products, pork, poultry, seafood or stuffing are not recommended for a delayed cooking operation.
- Baking is not recommended because preheating is required.

The Automatic Oven Timer Control is used to turn the oven on and off at a preset time of day. This feature can be used for either oven cooking or self-cleaning.

The clock must be functioning and set at the correct time of day for this feature to operate properly.

- **Immediate start:** Oven turns on immediately and automatically turn off at a preset time.
- **Delayed start:** Delays the start of cooking or cleaning and automatically turns off at a preset time.

Cook time can only be set for up to 11 hours and 59 minutes (11:59).

HOW TO SET TIMED COOK OPERATION

1. Press COOK TIME pad.
 - COOK TIME indicator on the COOK TIME pad will flash.
 - 0:00 will light in display.

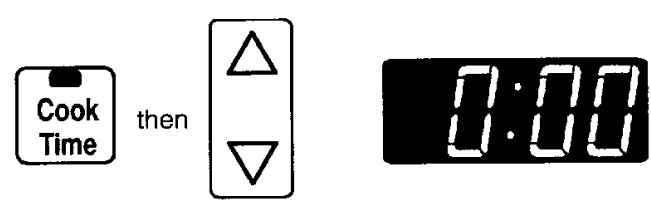

2. Press or press and hold ▲ or ▼ pad to enter cooking time.

3. Press BAKE pad.
 - BAKE indicator on BAKE pad will light.
 - 000 will light in display.

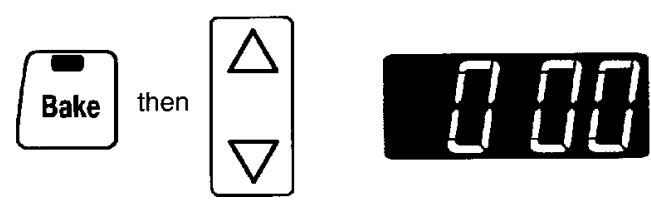

4. Press or press and hold ▲ or ▼ pad to enter oven temperature.

NOTE: Beeps will sound and 000 will flash in display if the BAKE pad is not pressed within 4 seconds.

5. **IF YOU WISH TO DELAY THE START OF COOKING** (if not, skip to #6):

- a. Press STOP TIME pad.
 - STOP TIME indicator on STOP TIME pad will flash.
- b. Press or press and hold ▲ or ▼ pad to enter time of day you wish oven to turn off.
- c. Press CLOCK pad.
 - Time of day will reappear in display.

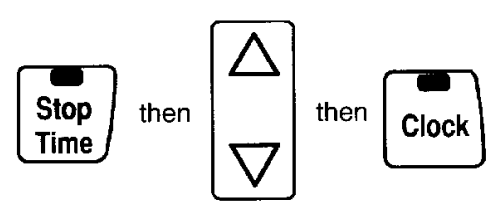

6. When the oven turns on, the OVEN ON indicator will light. The oven temperature will appear in the display. Press the COOK TIME pad to recall the remaining cook time.

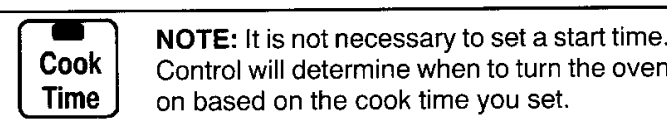

7. Oven will automatically turn off. Four beeps will sound and "End" will light in display. A beep will sound every 30 seconds for the next 5 minutes.

NOTE: See page 7 if you wish to change the end of cooking reminder beeps.

8. Press CANCEL pad and beeps will stop. Remove food from oven.



HOW TO SET OVEN TO BROIL

1. Press BROIL pad.

- BROIL indicator on the BROIL pad will light.
- 000 will light in display.

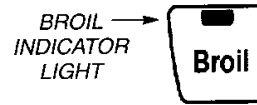

2. Press the ▲ pad to select HI (high) broil or the ▼ pad to select LO (low) broil.

- Select HI broil for normal broiling.
- Select LO broil for low temperature broiling of longer cooking foods such as poultry.

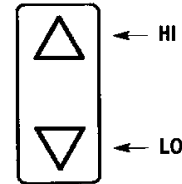

3. There will be a 4 second delay before the oven turns on. When the oven turns on:

- The OVEN ON indicator will light.



4. For optimum browning, preheat broil element for 3 to 4 minutes before adding food.

NOTE: Expect broil times to increase and browning to be slightly lighter if appliance is installed on a 208 volt circuit.

5. Place food in the oven. Leave oven door opened to the broil stop position (opened about 4-inches).

NOTE: See page 28 for broiling instructions and broiling chart.

6. Turn meat once about half way through cooking.

7. Press CANCEL pad. Remove food and broiler pan from the oven.

- The OVEN ON indicator will turn off.
- The BROIL indicator on the BROIL pad will turn off.
- Time of day will reappear in display.





CAUTION

- Be sure all packing material is removed from oven before turning on.
- Do not use oven for storing food or cookware.
- Many aerosol-type spray cans are **EXPLOSIVE** when exposed to heat and may be highly flammable. Avoid their use or storage near the oven.
- Allow steam and hot air to escape before reaching into oven to check, add, or remove food.
- Prepared Food Warning: Follow food manufacturer's instructions. If a plastic frozen food container and/or its cover distorts, warps, or is otherwise damaged during cooking, immediately discard the food and its container. The food could be contaminated.
- Follow the manufacturer's directions when using oven cooking bags.

GENERAL INFORMATION

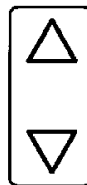
- Do not lock oven door during a cooking operation.
 - If the door is locked the LOCK indicator will light and the operation will be canceled. Unlock the door then reset the operation.
- If oven temperature is above 400°F, the internal locking mechanism will engage and the door can not be unlocked until the oven has cooled.
- Both the bake and broil elements cycle on and off to maintain the oven temperature for baking. Only the broil element turns on for broiling.
- If you press BAKE or BROIL pad and do not set an oven temperature or broil setting within 30 seconds, the program will automatically cancel. The time of day will reappear in the display.
- To change oven temperature or broil setting during cooking:
 - If temperature is displayed, press ▲ or ▼ pad to select the new temperature.
 - If another function is displayed, press BAKE or BROIL pad then press ▲ or ▼ pad to select new temperature.

**OVEN CHARACTERISTICS**

Because each oven has its own baking characteristics, do not expect your new oven to perform exactly like your previous oven. Allow a period of adjustment.

OVEN TEMPERATURE ADJUSTMENT

You can adjust the oven temperature if you feel the temperature is too hot or too cool.

To adjust the oven temperature:

1. Press BAKE pad.
2. Press ▲ pad until 550° is displayed.
3. Press and hold BAKE pad for 3 seconds until 00° appears in display.
4. Press and hold the ▲ or ▼ pad to select the temperature change you wish.
 - The oven temperature can be increased or decreased by 5° to 35°.
 - If the oven temperature was previously adjusted, the change will be displayed.

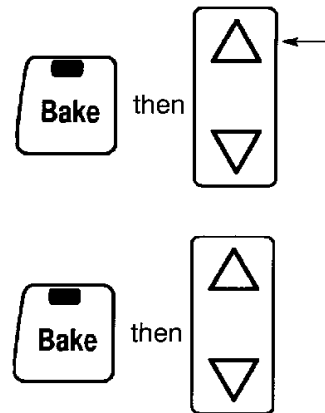

For example: If the oven temperature was reduced by 15°, the display will show - 15°.

5. Time of day will automatically reappear in display.

It is not necessary to readjust the oven temperature if there is a power failure or interruption. Broiling and cleaning temperatures cannot be adjusted.

OVEN DOOR



- **WARNING: NEVER** place excessive weight on or stand on an open oven door. This could cause the range to tip over, break the door, or injure the user.
- **NEVER** place fingers between hinge and front oven frame. Hinge arms are spring mounted. If accidentally hit, the hinge will slam shut against oven frame and could injure your fingers.

When baking, be sure oven door is completely closed. Baking results will be affected if door is not closed.

NOTE: When range is new, the oven door may feel "spongy" when you close the door. This is normal and will become less "spongy" with use.

To remove lift-off oven door:

1. When cool, open oven door to the broil stop position (opened about 4-inches).
2. Grasp door at each side.
3. Lift up evenly until door clears hinge arms. Do not use door handle to lift door.

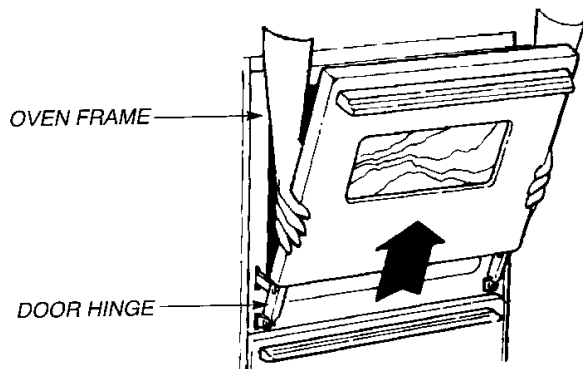

To replace oven door:

1. Grasp door at each side.
2. Align slots in door with hinge arms on range.
3. Slide door down onto hinge arms until door is completely seated on hinges. Then push down on top corners of door to completely seat door on hinges.

Door is not completely seated if one side is higher or if door appears to be crooked.

Do not attempt to open or close door or operate oven until door is properly replaced.

DOOR LOCK LEVER

The door lock lever is used to lock the oven door during a self-clean operation. To lock door, move the lever to the right. This is the locked position for the clean cycle.

Do not move the lock lever to the right or locked position when baking. If the door is accidentally locked:

- The cooking operation will be canceled.
- If oven temperature is above 400°F, the door will not unlock until the oven has cooled.
- Allow oven to cool then unlock and open door. (Place a fan in front of oven to speed cooling.)

OVEN WINDOW

To protect the oven door window:

1. Do not use abrasive cleaning agents such as steel wool scouring pads or powdered cleansers as they may scratch the glass.
2. Do not hit the glass with pots, pans, furniture, toys, or other objects.
3. Do not close the oven door until the oven racks are in place.

Scratching, hitting, jarring or stressing the glass may weaken its structure causing an increased risk of breakage at a later date.

OVEN VENT



When oven is in use, the area near the oven vent opening may feel warm or hot to the touch.

On **coil element** cooktops, the oven vent is located at the **RIGHT REAR** element.

- Be sure drip bowl for the right rear element has a hole in the center to allow proper oven venting.
- Do not cover this drip bowl with aluminum foil as this will block proper oven venting and may affect baking results.

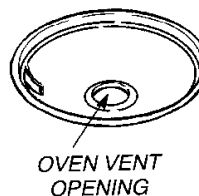

On a **smoothtop**, the vent is located at the center of the backguard.

OVEN LIGHT

CAUTION

- Disconnect power to range by tripping circuit breaker or removing fuse before replacing light bulb.
- Be sure bulb is cool before touching or replacing bulb.
- Use a dry potholder to prevent possible harm to hands when replacing bulb.
- Do not touch hot bulb with a damp cloth as this may cause the bulb to break.

To turn on the oven light: Push in rocker switch located on the backguard.

**To replace oven light bulb:**

1. Disconnect power to range.
2. Hold bulb cover in place then slide wire retainer off cover. **NOTE:** Bulb cover will fall if not held in place while removing wire retainer.
3. Remove bulb cover.
4. Remove light bulb and replace with a 40 watt appliance bulb.
5. Replace bulb cover and secure with wire retainer.
6. Reconnect power to range. Reset clock.

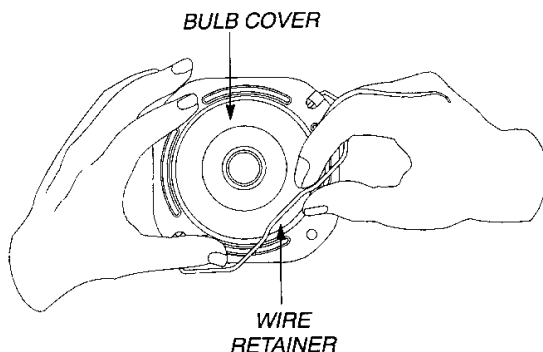

OVEN RACKS

CAUTION

Do not attempt to change the rack position when the oven is hot.

The oven rack is designed with a safety lock-stop position. This prevents the rack from accidentally coming completely out of the oven when pulling the rack out to add or remove food.

To remove oven rack:

1. When rack is cool, pull rack straight out until it stops at the lock-stop position.

NOTE: If it is necessary to change rack position when rack is hot, use potholders to protect hands.

2. Tilt the front end of the rack up.
3. Continue pulling rack out of oven.

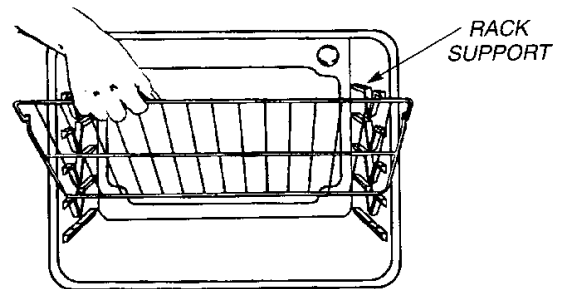
**To replace oven rack:**

1. Place rack on the rack supports in oven.
2. Tilt the front end of the rack up slightly.
3. Slide rack back until it clears the lock-stop position.
4. Lower front of rack and slide rack straight back into oven.
5. **IMPORTANT:** Pull rack out to the lock-stop position to be sure rack is correctly replaced.
6. If properly installed, rack will not come out of oven unless the front edge is lifted up.
7. Push rack back into oven and close oven door.

STORAGE DRAWER



Do not store plastic, paper products, food or flammable materials in this drawer. The drawer may become too warm for these items when the oven is in use.

The storage drawer at the bottom of the range is safe and convenient for storing metal and glass cookware.

The storage drawer can be removed to clean under the range.

To remove storage drawer:

1. Pull drawer out to the first stop position.
2. Lift up front of drawer.
3. Pull out to the second stop position.
4. Grasp sides and lift drawer up and out.

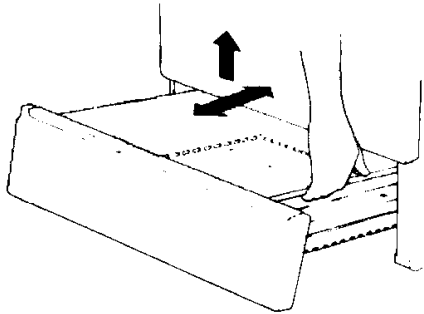

To replace storage drawer:

1. Fit the rollers located at the ends of the drawer glides into the rails on the range.
2. Lift up front of drawer and gently push in to first stop position.
3. Lift drawer up again and push until drawer is closed.

LEVELING LEGS

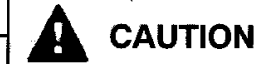

WARNING: The anti-tip bracket provided with this range must secure one of the rear leveling legs to the floor. This bracket prevents the range from accidentally tipping.

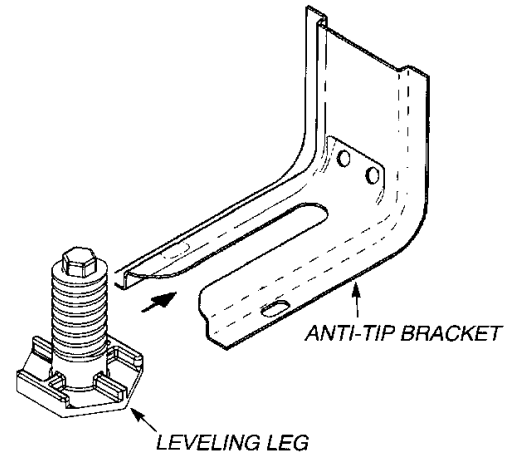

The installer should level the range when it is installed.

If the range is not level, turn the leveling legs, located at each corner of the range, until range is level. Place level on an oven rack to determine if range is level.

Cooking results can be affected if the range was not properly leveled during installation.

HOW TO SET OVEN FOR A CLEAN CYCLE

1. Move door lock lever to locked position.



2. Press SELF-CLEAN pad.

- CLEAN indicator on the SELF-CLEAN pad will flash.
- 3:00 will light in display.
- If door is not locked, "dr" will appear in display. Lock door.



then

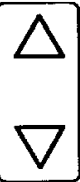

3. Press ▲ or ▼ pad to select clean time.

- You can select from 2 up to 4 hours.
- Oven will automatically clean for 3 hours. Or,
 - Select 2 hours for light soil.
 - Select 4 hours for heavy soil.

4. IF YOU WISH TO DELAY THE START OF CLEANING (if not, skip to #5):

- Press STOP TIME pad.
- Press ▲ pad to select the time of day you wish the oven to turn off.
 - Press CLOCK pad and time of day will reappear in display.
 - Press STOP TIME pad to recall the time you set.



then

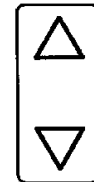

5. When the oven turns on:

- The OVEN ON indicator will light.
- LOCK indicator will light when oven heats to 400°.
- Internal lock will engage. Door cannot be unlocked and opened when LOCK indicator is lit.



LIGHT TURNS ON WHEN OVEN REACHES 400°F.

6. About one hour after the clean cycle ends, the LOCK indicator will turn off. The oven door can be unlocked and opened.

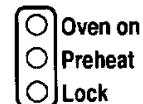

TO CANCEL CLEAN CYCLE:

- Press CANCEL pad.
- If LOCK indicator is NOT lit, unlock and open oven door.

If LOCK indicator is lit, allow oven to cool about one hour then unlock and open oven door.

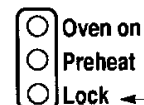
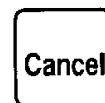

WHEN LIGHT TURNS OFF, UNLOCK AND OPEN DOOR.



CAUTION

- It is normal for parts of the range to become hot during a clean cycle.
- Avoid touching cooktop, door, window, or oven vent area during a clean cycle.
- To prevent damage to oven door, do not attempt to unlock the door when the LOCK indicator is displayed.
- It is normal for excessive flare-ups and smoking to occur during cleaning if the oven is heavily soiled.

BEFORE SELF-CLEAN CYCLE

- Remove pans, broiler pan, and oven racks. Racks may discolor and not slide easily after cleaning.
- Clean oven window (see glass on page 21), oven frame and door frame. These areas are not exposed to cleaning temperatures; soil may bake on during clean cycle.
- To prevent damage, do not clean gasket located on oven door. Gasket seals in heat during the clean cycle.
- To prevent excessive smoke, flare-ups or flaming, wipe up excess grease or spillovers from oven bottom.
- Porcelain is acid resistant, not acid proof and may discolor during the clean cycle. To prevent or reduce discoloration, wipe up sugar or acid spills (lemon, milk, barbecue sauce, cheese).

DURING SELF-CLEAN CYCLE

- As oven heats, the LOCK indicator will light in the display. At this point, the door can not be unlocked and opened.
- To prevent damage to door or lock lever, do not force door open when the LOCK indicator is displayed.
- Some smoke and odor may be detected the first few times the oven is cleaned. This is normal and will lessen in time.
- Smoke may occur if oven is heavily soiled or if broiler pan was left in oven.
- As oven heats, you may hear sounds of metal parts expanding and contracting. This is normal and will not damage oven.

AFTER SELF-CLEAN CYCLE

- The LOCK indicator will turn off about one hour after clean cycle ends. The door can be unlocked and opened. Use care as oven may still be hot.
- A gray powdery ash may remain on the oven bottom or walls. This is normal. Use a damp cloth to remove ash.
- If soil remains, the clean cycle may not have been long enough.
- Wipe oven racks with a small amount of vegetable oil if racks do not slide easily after clean cycle.
- Clean around oven vent opening if there is a deposit from the fumes vented during cleaning.
- A white discoloration may appear after cleaning if acid soils (milk, tomato, lemon, etc.) or sugary soils were not wiped up before the clean cycle. This discoloration is normal and will not affect the performance of the clean cycle.

CLEANING TIPS

- Turn off oven light before cleaning as the light may burn out during a clean cycle.
- Clean oven regularly rather than allowing soil to build-up.
- Do not use oven cleaners in, on, or around any part of the range as they will damage the finish or parts.

CANADIAN MODELS ONLY

- The right front surface element will not operate during a self-clean operation.

ABOUT CLEANING PRODUCTS

Read and carefully follow the manufacturer's instructions. Test a small inconspicuous area using a very light pressure to see if the surface may scratch or discolor. This is particularly important for porcelain enamel, highly polished or shiny metal or plastic surfaces, and painted surfaces.

Glass Cleaners – Bon Ami, Cinch, Glass Plus, Windex.

Dishwashing Liquid Detergents – Dawn, Dove, Ivory, Joy.

Mild Liquid Spray Cleaners – Fantastik, Formula 409.

Non-Abrasive Cleaners – Bon Ami, paste of baking soda and water.

Mildly Abrasive Powder or Liquid All Purpose Cleansers – Ajax, Barkeepers Friend, Cameo, Comet, Soft Scrub, Elco Cleaner Conditioner.

Non-Abrasive or Scratchless Plastic or Nylon Scouring Pads or Sponges – Chore Boy Plastic Cleaning Puff, Scrunge Scrub Sponges, or Scotch-Brite No Scratch, Cookware or Kitchen Sponge.

Abrasive Scouring Pads – S.O.S., Brillo Steel Wool Soap, Scotch-Brite Pads.

NOTE: The cleaning products for the smoothtop cooktop are listed in the chart on page 22.

(Brand names for the above cleaning products are registered trademarks of the respective manufacturers.)



- Be sure appliance is off and all parts are cool before handling or cleaning. This is to avoid damage and possible burns.
- If a part is removed, be sure it is correctly replaced.
- **To prevent staining or discoloration, clean appliance after each use.**

CLEANING CHART

PARTS	CLEANING AGENTS	CLEANING PROCEDURES
Broiler pan and insert , Select models	<ul style="list-style-type: none"> • Soap and water • Plastic or soap filled scouring pad • Dishwasher 	<p>Never cover insert with aluminum foil as this prevents the fat from draining to pan below.</p> <ol style="list-style-type: none"> 1. Remove from oven after use. Cool then pour off grease. 2. Place soapy cloth over insert and pan; let soak to loosen soil. 3. Wash in warm soapy water. Use soap filled scouring pad to remove stubborn soil. 4. Broiler pan and insert can be cleaned in the dishwasher.
Control knobs	<ul style="list-style-type: none"> • Soap and water • Mild liquid sprays • Glass cleaners 	<p>For ease of cleaning, turn off knob and remove by pulling forward.</p> <ol style="list-style-type: none"> 1. Wash, rinse, and dry. Do not use abrasive cleaning agents as they may scratch the finish and remove the markings. 2. Turn on each element to be sure knobs have been correctly replaced.
Drip bowls, chrome	<ul style="list-style-type: none"> • Soap and water • Plastic scouring pads • Mild abrasive cleaners • Flitz Metal Polish 	<p>Do not cover drip bowls with aluminum foil.</p> <p>Bowls can permanently discolor over time, if exposed to excessive heat, or if soil is allowed to bake on. The discoloration will not affect the cooking performance.</p> <ol style="list-style-type: none"> 1. After each use, wash, rinse and dry. 2. If heavily soiled, gently scrub with plastic scouring pad. If soil is allowed to burn on, it may be impossible to remove. 3. A non-abrasive metal polish such as Flitz may be used to help remove blue/gold heat stains. Flitz is available in many automotive supply and hardware stores. These stains are caused by overheating, and normally occur over a period of time. They are usually permanent. Follow package directions.
Drip bowls, porcelain	<ul style="list-style-type: none"> • Soap and water • Mild abrasive cleaners • Plastic scouring pads • Dishwasher 	<p>Porcelain may discolor or craze over time, if overheated, or if soil is allowed to bake on. This is normal and will not affect cooking performance.</p> <ol style="list-style-type: none"> 1. When cool, wash after each use, rinse and dry to prevent staining or discoloration. 2. To clean heavy soil, soak in hot sudsy water, then use mild abrasive cleaner and plastic scouring pad.

ABOUT CLEANING

21

PARTS	CLEANING AGENTS	CLEANING PROCEDURES
Enamel, painted <ul style="list-style-type: none"> • Backguard • Oven door • Side panels • Storage drawer or lower panel 	<ul style="list-style-type: none"> • Soap and water • Mild liquid cleaner • Glass cleaner 	<p>NOTE: Use dry towel or cloth to wipe up spills, especially acid (milk, lemon juice, fruit, mustard, tomato sauce) or sugary spills. Surface may discolor or dull if soil is not immediately removed. This is especially important for white surfaces.</p> <ol style="list-style-type: none"> 1. When cool, wash with warm soapy water, rinse and dry. Never wipe a warm or hot surface with a damp cloth as this may damage the surface and may cause a steam burn. 2. For stubborn soil, use mildly abrasive cleaning agents such as baking soda paste or Bon Ami. 3. Do not use abrasive, caustic or harsh cleaning agents such as steel wool pads or oven cleaners. These products will scratch or permanently damage the surface.
Elements, oven and coil		<ol style="list-style-type: none"> 1. Elements are self-cleaning. Soil will burn off as elements are used. 2. Do not spray oven cleaner on elements, electrical hook up or connection. 3. Do not immerse coil-type surface elements in water.
Glass <ul style="list-style-type: none"> • Oven window 	<ul style="list-style-type: none"> • Soap and water • Glass cleaner • Paste of baking soda and water 	<p>To prevent staining of the oven window, avoid using excessive amounts of water which may seep under or behind glass.</p> <ol style="list-style-type: none"> 1. Wash with soap and water. Remove stubborn soil with paste of baking soda and water. Rinse with clear water and dry. 2. Do not use abrasive materials such as scouring pads, steel wool or powdered cleaning agents. They will damage glass.
Metal finishes such as brushed aluminum, or chrome <ul style="list-style-type: none"> • Backguard • Cooktop • Oven door • Storage door • Trim parts 	<ul style="list-style-type: none"> • Soap and water • Glass cleaner • Plastic or non-abrasive pad or sponge 	<ol style="list-style-type: none"> 1. Wash with soap and water or a glass cleaner and a soft cloth. 2. To prevent scratching or dulling of the finish, do not use mildly abrasive, abrasive, or harsh cleaners, or caustic cleaners such as oven cleaners. 3. To clean brushed aluminum: Use only soap and water or a soft cloth and glass cleaner to prevent scratching or dulling of the finish. 4. To clean brushed chrome cooktop or door: <ul style="list-style-type: none"> • Use a paste of baking soda and water and a soft cloth. • Rub with the grain to prevent scratching, dulling or streaking of the finish. • Use a soft cloth and mineral oil to restore luster or to remove fingerprints or smudges. • Clean with an automotive chrome cleaner or polisher.
Oven interior		<p>Porcelain enamel is acid resistant, not acid proof. Therefore, when cool, wipe up sugary or acid spills (milk, fruit, tomato, etc.) as they occur. See pages 18-19 for self-clean oven.</p>
Oven racks	<ul style="list-style-type: none"> • Soap and water • Plastic scouring pad • Cleansing powders • Soap-filled scouring pad 	<ol style="list-style-type: none"> 1. Clean with soapy water. 2. Remove stubborn soil with cleansing powder or soap-filled scouring pad. Rinse and dry. <p>Racks will permanently discolor and may not slide smoothly if left in the oven during a self-clean operation. If this occurs, wipe the rack and embossed rack supports with a small amount of vegetable oil to restore ease of movement, then wipe off excess oil.</p>
Plastic finishes <ul style="list-style-type: none"> • Door handles • Backguard trim • Knobs • End caps 	<ul style="list-style-type: none"> • Soap and water • Non-abrasive plastic pad or sponge • Glass cleaner 	<p>NOTE: To prevent staining or discoloration, wipe up fat, grease or acid (tomato, lemon, vinegar, milk, fruit juice, marinade) immediately with a dry paper towel or cloth.</p> <ol style="list-style-type: none"> 1. When cool, clean with soap and water, rinse, and dry. 2. Use a glass cleaner and a soft cloth. <p>NOTE: Never use oven cleaners, abrasive or caustic liquid or powdered cleansers on plastic finishes. These cleaning agents will scratch or mar finish.</p>

PARTS	CLEANING AGENTS	CLEANING PROCEDURES
Porcelain enamel <ul style="list-style-type: none"> • Cooktop on coil elements • Trim on smoothtop cooktop • Backguard 	<ul style="list-style-type: none"> • Soap and water • Paste of baking soda and water • Non-abrasive plastic pad or sponge 	<p>Porcelain enamel is glass fused on metal and may crack or chip with misuse. It is acid resistant, not acid proof. All spillovers, especially acid or sugar spillovers, should be wiped up immediately with a dry cloth. This is especially important around the vent opening for smoothtop cooktop. Surface may discolor or dull if soil is not removed.</p> <ol style="list-style-type: none"> 1. When cool, wash with soapy water, rinse and dry. 2. Never wipe off a warm or hot surface with a damp cloth. This may cause cracking and chipping. 3. Never use oven cleaners, abrasive or caustic cleaning agents on exterior finish of range.
Smoothtop cooktop	<p>Never use oven cleaners, ammonia or glass cleaners with ammonia.</p>	<p>NOTE: Call an authorized servicer if the smoothtop should crack, break or if metal or aluminum foil should melt on the cooktop.</p>
<ul style="list-style-type: none"> • To clean light to moderate soil 	<ul style="list-style-type: none"> • Cooktop Cleaning Creme* or other product specially formulated for the smoothtop • Soap and water 	<p>Wait until cooktop has cooled before cleaning. Gently apply cleaning agent with a non-abrasive plastic brush, nylon or plastic pad, paper towel or clean cloth. (Do not use soiled sponge or cloth as these may leave a film and discoloration.) Rinse thoroughly and completely dry.</p> <p>* Cooktop Cleaning Creme can be purchased from your dealer.</p>
<ul style="list-style-type: none"> • To clean heavy soil or brown/gray stains from hard water or metal marks 	<ul style="list-style-type: none"> • Cooktop Cleaning Creme* or other product specially formulated for the smoothtop 	<p>Gently scrub with cleaning creme and clean cloth or paper towel. Reapply cleaner. Cover with damp paper towels to keep cleaner moist. Let stand for 30 to 45 minutes. Scrub to remove remaining stain. Do not use abrasive powders or pads as they may scratch the surface. Rinse and dry.</p>
<ul style="list-style-type: none"> • To clean burned-on or crusty soils or residue 	<ul style="list-style-type: none"> • Single-edge safety razor blade • Cooktop Cleaning Creme* 	<p>Hold razor blade scraper at 30° angle and very carefully scrape off soil. Clean remaining soil with Cooktop Cleaning Creme.</p>
<ul style="list-style-type: none"> • To clean sugar, starch, plastic 	<ul style="list-style-type: none"> • Single-edge safety razor blade held with a potholder • Wooden spoon or plastic handled metal spatula 	<p>Turn element to LOW and immediately scrape from hot surface to a cool area. Then turn element OFF and cool. Clean residue with razor blade scraper and cleaning creme.</p>
<ul style="list-style-type: none"> • Aluminum foil 		<p>Aluminum foil can not be removed once it melts on to the top. If the foil melts over a cooking area, the cooking area cannot be used as it may damage the cookware or damage the smoothtop.</p>

SELECTING HEAT SETTINGS

- If a higher setting is used to begin a surface cooking operation or to bring water to a boil, always **reduce** to a lower setting once cooking begins or water comes to a boil.
- For smoothtop cooking, it is better to select a lower setting and increase to a higher one later, if needed.
- Food will not cook faster at a setting that is higher than needed to maintain a gentle boil. The temperature of the water is the same whether boiling vigorously or gently.

Factors affecting the heat setting include:

- Type, flatness and size of the cookware.
- Quantity and type of food being cooked.
- Use of a lid (covering pans speeds cooking and saves energy).
- Element voltage or voltage supply to your home.

SUGGESTED HEAT SETTING GUIDE

When turning knob to HIGH, there is an indent to identify the HIGH setting.

HIGH OR 9: Use to bring liquid to a boil, blanch, preheat skillet, or reach pressure in a pressure cooker.

Always reduce to a lower heat setting when liquid just begins to boil or food begins to cook.

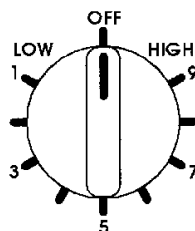

MEDIUM-HIGH (7, 8): Use to brown or sear meat; heat oil for deep fat frying; scald; to saute or fry. Maintain fast boil for large amounts of liquid.

MEDIUM (4, 5, 6): Use to maintain moderate to slow boil for large amounts of liquid. To continue cooking uncovered food and for most frying operations.

MEDIUM-LOW (2,3): Use to continue cooking covered food and to maintain pressure in most pressure cookers. Stew, braise or steam operations. To maintain boil for small amounts of liquid, poach, steam or simmer.

LOW OR 1: Use to keep food warm before serving. Melt chocolate or butter.

CANNING INFORMATION

Acceptable water bath or pressure canners should not be oversized and should have flat bottoms.

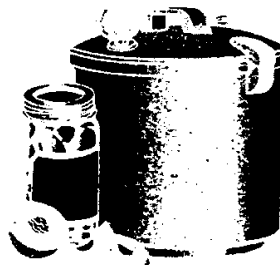

When canners do not meet these standards, cooking times may be longer and the cooktop may be damaged.

On a smoothtop cooktop, the canner bottom should not extend more than one-inch beyond the cooking area and must have a flat bottom.

When canning, use the HIGH setting just until the water comes to a boil or pressure is reached in the canner, then reduce to the lowest heat setting that maintains the boil or pressure. If the heat setting is not turned down, damage to the cooktop may occur.

A special canning element (model CE1) is available from your dealer for coil element cooktops. It elevates the canner above the cooktop to reduce trapped heat. This prevents damage to the porcelain surface and drip bowls.



CANNER ELEMENT
(MODEL CE1)

Check with your local Extension Service or a manufacturer of glass canning jars for the latest canning information.

ABOUT COOKWARE



CAUTION

Never allow a pan to boil dry as this may damage the pan, cooktop and/or heating element.

To achieve optimum surface cooking performance, select heavy gauge, flat, smooth bottom pans that fit the size of the surface unit.

Proper pans will reduce cooking times, use less energy and cook food more evenly. Use these tests to determine if pan bottom is flat.

Ruler Test:

1. Place a ruler across the bottom of the pan.
2. Hold it up to the light. Little light should be visible under the ruler.

Bubble Test:

1. Put an inch of water into the pan, place on cooktop and turn control to HIGH.
2. Watch the bubble formation as the water heats.
 - Uniform bubbles = good performance.
 - Uneven bubbles = hot spots and uneven cooking.

Good Pans:

- Flat bottom, straight sides, and tight fitting covers.
- Made of a heavy gauge material that conducts heat well.
- Weight of handle does not tilt pan.
- Pan size matches the size of the surface unit. Pan should not extend more than 1-inch beyond the surface unit.



Poor Pans:

- Grooved or warped pan bottoms.
- Pan that is smaller than the surface unit.
- Thin gauge metal pans.
- Unstable pan such as a small saucepan with a heavy or loose handle.
- Oversized pans or pans that rest across two coil elements. These will cause discoloration or damage to the drip bowls, damage to the porcelain cooktop, and may lengthen the cooking time on the smoothtop cooktop.
- Woks with round metal rings. The ring traps heat and may damage coil element, porcelain cooktop, and smoothtop cooktop.

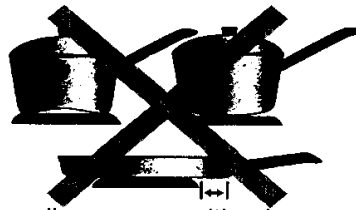

COOKWARE MATERIALS

The pan material determines how evenly and quickly heat is transferred from the heating element to the pan bottom.

Aluminum

Heats evenly. Avoid thin gauge aluminum. Acidic foods or salt will cause it to discolor or pit. Anodizing improves stain resistance and pitting. Often used as a bottom coating to improve the heating of other materials.

Sliding aluminum pans across smoothtop may leave metal marks. Remove these marks immediately to prevent permanent marks (see page 22).

Copper

Heats evenly; discolors easily. Often used as a bottom coating to improve the heat conduction of other materials. May leave metal marks on the smoothtop (see aluminum above).

If copper cleaner is not completely removed from pan, the cleaning residue may permanently damage or discolor the smoothtop the next time the pan is used.

Stainless Steel

Heats unevenly unless lined with copper or has an aluminum bottom or inner core. Durable, easy to clean and stain resistant.

Cast Iron

Heats slowly and evenly; retains heat; slow to cool. Needs seasoning to prevent sticking and rusting. May affect color and taste of some foods.

Porcelain Enamel

Glass-like substance fused to metal. Heating characteristics depend on base material (usually steel or cast iron).

Glass-Ceramic

Heats slowly and unevenly. May scratch the smoothtop if slid across cooktop. Some types may only be used in the oven.

ABOUT SPECIALTY COOKWARE

This appliance has been tested for safe performance using conventional cookware. Do not use any devices or accessories that are not specifically recommended in this manual. Do not use eyelid covers for the surface units, stove top grills, or add-on oven convection systems

The use of devices or accessories that are not expressly recommended in this manual can create serious safety hazards, result in performance problems, and reduce the life of the components of the appliance.

ALUMINUM FOIL USAGE

- Do not cover an entire oven rack or oven bottom with aluminum foil. This will reduce heat circulation, result in poor baking and may damage the oven bottom.
- A small piece of foil may be used to catch spillovers. Place it on a lower rack several inches below the food.

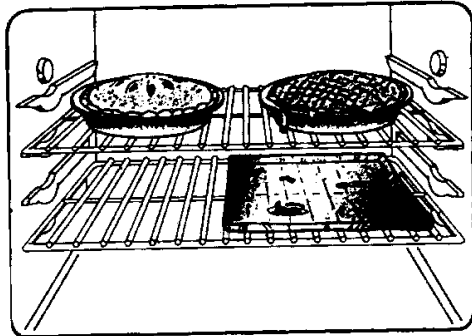

- Do not cover the broiler insert with aluminum foil. This prevents fat from draining into the pan below and increases flare-ups and smoke. However, the broiler pan may be lined with foil for easier clean-up.

PREHEATING

- Preheating is necessary for baking.
- It is not necessary to preheat for roasting.
- To preheat, set the oven to the desired temperature and allow about 8 to 15 minutes for the oven to preheat. A single beep will indicate that the oven is preheated.
- Selecting a temperature higher than desired will NOT preheat the oven any faster, and may have a negative effect on baking results.

RACK POSITIONS

- For optimum results, air must circulate freely within the oven and around the food. To help ensure this, place food in the center of the oven. Allow two inches between the edge of the pan(s) and the oven walls.
- Use one rack for optimum baking results of cakes, cookies or biscuits.

Position the rack so the food is in the center of the oven. Use either rack position 2 or 3.

- If cooking on two racks, stagger the food to ensure proper air flow.
- If cooking on two racks, use rack positions 2 and 4 for cakes and rack positions 1 and 4 or 2 and 5 when using cookie sheets. Never place two cookie sheets on one rack.
- If roasting a large turkey, place the turkey on rack 1 and the side dishes on rack 5.

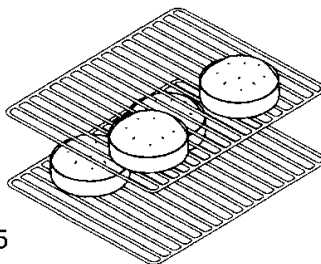

RACK 5 (highest position): Used for toasting bread, or for two-rack baking.

RACK 4: Used for most broiling and two-rack baking.

RACK 3: Used for most baked goods on a cookie sheet or jelly roll pan, or frozen convenience foods, or for two-rack baking.

RACK 2: Used for roasting small cuts of meat, large casseroles, baking loaves of bread, cakes (in either tube, bundt, or layer pans) or two-rack baking.

RACK 1: Used for roasting large cuts of meat and large poultry, pies, souffles, or angel food cake, or for two-rack baking.

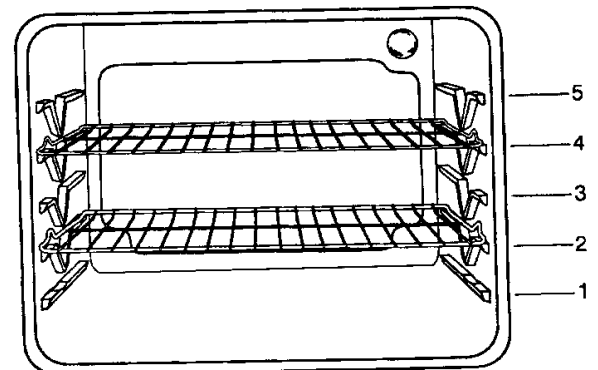

BAKING TIPS

Use a **reliable recipe** and accurately measure fresh ingredients. **Carefully follow directions** for oven temperature and cooking time. Preheat oven if recommended.

Use the correct rack position. Baking results may be affected if the wrong rack position is used.

- Top browning may be darker if food is located toward the top of the oven.
- Bottom browning may be darker if food is located toward the bottom of the oven.

Bakeware material plays an important part in baking results. Always use the type and size of pan called for in the recipe. Cooking times or cooking results may be affected if the wrong size is used.

- **Shiny metal pan** reflects heat away from the food, produces lighter browning and a softer crust. Use shiny pans for baking cakes or cookies.
- **Dark metal pan or a pan with an anodized (dull) bottom** absorbs heat, produces darker browning and a crisper crust. Use this type of pan for pies, pie crusts or bread.
- For optimum baking results, bake cookies and biscuits on a **flat** cookie sheet. If the pan has sides, such as a jelly roll pan, browning may not be even.
- If using **oven-proof glassware**, or **dark pans such as Baker's Secret** reduce the oven temperature by 25°F except when baking pies or bread. Use the same baking time as called for in the recipe.
- If using insulated bakeware, expect cooking times to increase slightly. It is not necessary to adjust the oven temperature.

Check the cooking progress at the minimum time recommended in the recipe. If necessary, continue checking at intervals until the food is done. If the oven door is opened too frequently, heat will escape from the oven; this can affect baking results and wastes energy.

If you add additional ingredients or alter the recipe, expect cooking times to increase or decrease slightly.

ROASTING TIPS

Roasting is the method for cooking large, tender cuts of meat uncovered, without adding moisture. Most meats are roasted at 325°F. It is not necessary to preheat the oven.

- For best results use tender cuts of meat weighing 3-lbs. or more.
- Some good choices are: Beef rib, ribeye, top round, high quality tip and rump roast, pork loin roast, leg of lamb, veal shoulder roast and cured or smoked hams.
- Place the meat fat-side-up on a rack in a shallow roasting pan. Placing the meat on a rack holds it out of the drippings, thus allowing better heat circulation for even cooking. As the fat on top of the roast melts, the meat is basted naturally, eliminating the need for additional basting.
- The cooking time is determined by the weight of the meat and the desired doneness.
- For more accurate results, use a meat thermometer. Insert it so the tip is in the center of the thickest part of the meat. It should not touch fat or bone.
- Remove the roast from the oven when the thermometer registers the desired doneness.

NOTE: For more information about food safety, call USDA's Meat & Poultry Hotline at 1-800-535-4555.

For cooking information, write to the National Cattlemen's Beef Association, 444 North Michigan Avenue, Chicago, Illinois 60611, or call 1-800-368-3138.

COMMON BAKING PROBLEMS AND WHY THEY HAPPEN

PROBLEM	POSSIBLE CAUSES
<i>Cakes are uneven.</i>	<ul style="list-style-type: none"> • Pans too close or touching each other or oven walls. • Batter uneven in pans. • Temperature set too low or baking time too short. • Oven not level. • Undermixing. • Too much liquid.
<i>Cake high in middle.</i>	<ul style="list-style-type: none"> • Temperature set too high. • Baking time too long. • Overmixing. • Too much flour. • Pans touching each other or oven walls. • Incorrect rack position.
<i>Cake falls.</i>	<ul style="list-style-type: none"> • Too much shortening or sugar. • Too much or too little liquid. • Temperature set too low. • Old or too little baking powder. • Pan too small. • Oven door opened frequently. • Added incorrect type of oil to cake mix. • Added additional ingredients to cake mix or recipe.
<i>Cakes, cookies, biscuits don't brown evenly.</i>	<ul style="list-style-type: none"> • Incorrect rack position. • Oven door not closed properly. • Door gasket not sealing properly or properly attached to door. • Incorrect use of aluminum foil. • Oven not preheated. • Pans darkened, dented or warped. <p>For optimum results, bake on one rack. If baking cakes on two racks, place pans toward the front of the oven on the upper rack and toward the back of the oven on the lower rack.</p>
<i>Cakes, cookies, biscuits too brown on bottom.</i>	<ul style="list-style-type: none"> • Oven not preheated. • Pans touching each other or oven walls. • Incorrect rack position. • Incorrect use of aluminum foil. • Placed 2 cookie sheets on one rack. • Used glass, dark, stained warped or dull finish metal pans. (Use a shiny cookie sheet.) <p>Follow cookware manufacturer's instructions for oven temperature. Glassware and dark cookware such as Ecco's Baker's Secret may require lowering the oven temperature by 25°F.</p>
<i>Cakes don't brown on top.</i>	<ul style="list-style-type: none"> • Incorrect rack position. • Temperature set too low. • Overmixing. • Too much liquid. • Pan size too large or too little batter in pan. • Oven door opened too often.
<i>Excessive shrinkage.</i>	<ul style="list-style-type: none"> • Too little leavening. • Overmixing. • Pan too large. • Temperature set too high. • Baking time too long. • Pans too close to each other or oven walls.
<i>Uneven texture.</i>	<ul style="list-style-type: none"> • Too much liquid. • Undermixing. • Temperature set too low. • Baking time too short.
<i>Cakes have tunnels.</i>	<ul style="list-style-type: none"> • Not enough shortening. • Too much baking powder. • Overmixing or at too high a speed. • Temperature set too high.
<i>Cake not done in middle.</i>	<ul style="list-style-type: none"> • Temperature set too high. • Pan too small. • Baking time too short. <p>If additional ingredients were added to mix or recipe, expect cooking time to increase.</p>
<i>Pie crust edges too brown.</i>	<ul style="list-style-type: none"> • Temperature set too high. • Pans touching each other or oven walls. • Edges of crust too thin; shield with foil.
<i>Pies don't brown on bottom.</i>	<ul style="list-style-type: none"> • Used shiny metal pans. • Temperature set too low. • Incorrect rack position. • Some frozen pies should be placed on a cookie sheet, check package directions.
<i>Pies have soaked crust.</i>	<ul style="list-style-type: none"> • Temperature too low at start of baking. • Filling too juicy. • Used shiny metal pans.

BROILING TIPS

Broiling is used for tender cuts of meat or marinated meats, poultry, fish and some fruits and vegetables. The food is placed directly under the broil element.

Cooking time is determined by the desired degree of doneness and the distance between the food and the element.

- For best results, steaks and chops should be at least 3/4-inch thick. Thinner cuts should be pan broiled.
- Before broiling, trim excess fat to prevent excessive spattering or smoking. Cut slashes in the outer edges of the fat to prevent curling during cooking.
- Season meat after cooking. Salt tends to draw juices out of the meat and delay browning.
- Preheat broil element 3 minutes for optimum browning.
- Use a broiler pan with an insert designed to drain excess liquid and fat away from the cooking surface. This is to prevent spatters and smoke.
- For a brown exterior and rare interior, meat should be close to the broil element. For well-done meat, place the broiler pan farther from the element.
- Increasing the distance between the meat and the broil element will help reduce spattering and smoking.

- When broiling in an electric oven, the door should be opened to the broil stop position (opened about 4-inches).

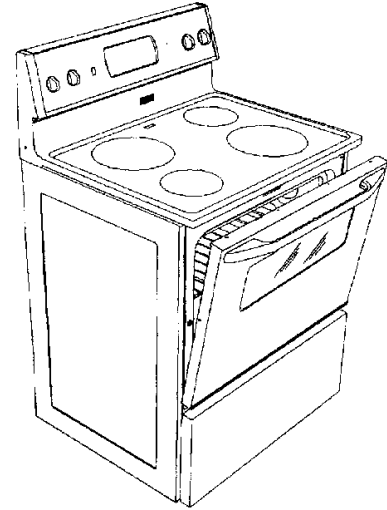

- Select Lo Broil for longer cooking foods such as chicken pieces.
- Foods that require turning should be turned only once during broiling. Turn after half the recommended cooking time.

BROILING CHART

TYPE OF MEAT	RACK POSITION*	DONENESS	TOTAL COOK TIME (MINUTES)**
BACON	#4	Well Done	6 to 10 min.
BEEF STEAKS 1-inch thick	#4 #4	Medium Well Done	15 to 18 min. 19 to 23 min.
CHICKEN Pieces	#3 or #4	Well Done	LO BROIL 30 to 45 min.
FISH Fillets Steaks, 1-inch thick	#4 #4	Flaky Flaky	8 to 12 min. 10 to 15 min.
GROUND BEEF PATTIES 3/4-inch thick	#4	Well Done	15 to 18 min.
HAM SLICE , precooked 1/2-inch thick	#4	Warm	8 to 12 min.
PORK CHOPS 1-inch thick	#4	Well Done	22 to 26 min.

* The top rack position is position #5.

** Broiling times are approximate and may vary depending on the meat.



CAUTION

- Do not attempt to service this appliance yourself unless directed to do so in this manual or the chart below. Refer all other servicing to a qualified servicer or call us at **1-800-688-1120**.
- Locate and mark circuit breaker or fuse. Never replace a blown fuse or reset a circuit breaker until you know what caused the problem. Always replace a blown fuse with one of the correct amperage, do not use a substitute.
- Always disconnect power to unit **before** any servicing by tripping circuit breaker to the OFF position or by removing the fuse.

TROUBLESHOOTING CHART

PROBLEM	POSSIBLE CAUSES	SUGGESTED CORRECTIONS
<p>Part or all of appliance does not operate.</p>	<ol style="list-style-type: none"> Range is disconnected from power or is loosely connected to power. Tripped circuit breaker or blown fuse. Power supply has been interrupted. Surface or oven controls not set properly. Oven door left in locked position after clean cycle. Oven set for delayed cook or clean. 	<ol style="list-style-type: none"> Check to be sure plug is securely inserted into wall receptacle. Check or re-set circuit breaker. Check or replace fuse. Wait until power has been restored. See page 8 for setting surface units; see pages 11, 12 and 13 for setting oven control. Unlock oven door. Cancel program. See page 12 or 18.
<p>Surface or oven elements fail to operate or heat food.</p> <p>CANADIAN MODELS ONLY: The right front element on the smoothtop will not operate during a clean operation.</p>	<ol style="list-style-type: none"> Range is disconnected from power or is loosely connected to power. Tripped circuit breaker or blown fuse. Power supply has been interrupted. Surface or oven controls not set properly. Surface element is not properly installed. Oven was not set to correct temperature. Oven was set for delayed cook. Oven was not preheated properly. Defective part. 	<ol style="list-style-type: none"> Check to be sure plug is securely inserted into wall receptacle. Check or re-set circuit breaker. Check or replace fuse. Wait until power has been restored. See page 8 for setting surface units; see pages 11, 12 and 13 for setting oven control. See page 9 for instructions on how to replace surface element. Set oven to temperature recommended in recipe. Cancel program and reset. See page 12. Allow oven to preheat until PREHEAT indicator turns off and a beep is heard. Then place food in oven. Have authorized servicer replace part.
<p>Smoothtop cooktop.</p> <ol style="list-style-type: none"> Tiny scratches or abrasions Metal-marks Brown streaks and specks Areas of discoloration with a metallic sheen Pitting or flaking 	<ol style="list-style-type: none"> Coarse particles (dust, salt, sand) between cookware and cooktop. Incorrect cleaner. Sliding glass or metal pan across top. Using cookware with rough bottoms. Sliding or scraping metal pans or oven racks across cooktop. Boilovers, incorrect cleaner, used soiled cloth or sponge, soiled cookware. Mineral deposits from water and foods. Sugary boilovers from sugar syrups, candy, jams, jellies, dessert sauces, etc. 	<ol style="list-style-type: none"> Tiny scratches are not removable and do not affect cooking. In time, the scratches will become less visible. Be sure cookware bottom and cooktop are clean before use. Use cookware with a smooth, non-scratching bottom. Do not slide cookware across cooktop. Do not slide metal object across cooktop. When cool, clean with Cooktop Cleaning Creme. Clean up boilover before reusing the cooktop. Be sure cookware, especially bottoms, are clean and dry. Use cookware with bottoms that are clean and dry. Use correct heat setting to prevent boilovers. Use correct heat setting and large enough pan. Watch cooking operation to prevent boilovers or spattering.

PROBLEM	POSSIBLE CAUSES	SUGGESTED CORRECTIONS
<p>Baking results are not what you expected.</p> <ul style="list-style-type: none"> • Uneven browning (too dark on top or bottom). • Underdone or overdone. • Browning is too dark or light. • Cake is not level. 	<ol style="list-style-type: none"> 1. Oven is too hot or too cool. 2. Selected BROIL rather than BAKE. 3. Food not positioned correctly in oven. 4. Used incorrect pan. 5. Used aluminum foil incorrectly. 6. Oven rack was crowded with pans. 7. Used unreliable recipe or did not follow recipe. 8. Oven vent was blocked. 9. Range is not level. 10. Door is not correctly installed. 	<ol style="list-style-type: none"> 1. Select correct oven temperature. When baking, always preheat oven before adding food. 2. Select the BAKE pad, not BROIL, for baking. 3. See rack placement on page 25. 4. Dark pans produce dark browning. Select shiny aluminum pans or reduce the oven temperature by 25°F. See page 26. 5. Never use foil to cover an oven rack. Place a small piece of foil on the rack below the rack holding the pan. See page 25. 6. Stagger pans on rack. Allow 1 to 2-inches between pans and oven walls. 7. Select recipes from reliable sources. Read and carefully follow instructions and do not substitute ingredients. 8. See page 15 for information on oven vent. 9. See page 17 for instructions on leveling range. 10. See page 15 for instructions on replacing door.
<p>Baking results differ from previous oven.</p>	<ol style="list-style-type: none"> 1. Oven seems hotter or cooler than your previous oven. <p>NOTE: Oven temperatures may vary between the new and the old oven. As ovens age, the oven temperature often "drifts" and may become hotter or cooler. Also, newer ovens may operate differently from older ovens. You should expect some differences in baking results.</p>	<ol style="list-style-type: none"> 1. See page 31 for instructions on adjusting the oven temperature. NOTE: Do not adjust temperature if only one or two recipes are in question. The problem may be the recipe rather than the oven.
<p>Food not broiling properly.</p>	<ol style="list-style-type: none"> 1. Oven incorrectly set. 2. Used incorrect rack position. 3. Broil element was not preheated. 4. Used aluminum foil incorrectly. 5. Oven door was closed during broiling. 	<ol style="list-style-type: none"> 1. See page 13 for operating instructions. 2. See page 28 for information on broiling. 3. For optimum browning, preheat the broil element for 3 minutes before placing food in the oven. 4. The broiler pan can be lined with foil; never line the broiler insert with foil. 5. Always leave door opened to the broil stop position (opened about 4-inches) during broiling.
<p>Oven smokes excessively during broiling.</p>	<ol style="list-style-type: none"> 1. Food placed too close to broil element. 2. Broiler insert covered with aluminum foil. 3. Meat is too fatty. 4. Marinade not completely drained before broiling. 5. Basted meat too early during broiling. 6. Used a soiled broiler pan. 	<ol style="list-style-type: none"> 1. Move broiler pan down one rack position. 2. Never cover insert with foil as this prevents fat from draining to pan below. 3. Trim excess fat before broiling. 4. Completely drain marinade from meat. 5. Baste meat during the last few minutes of cooking. 6. Always clean broiler pan and insert after use.
<p>Oven will not self-clean.</p>	<ol style="list-style-type: none"> 1. Self-clean feature was not properly set. 2. Oven set for a delayed clean. 3. Oven door not closed and/or locked. 	<ol style="list-style-type: none"> 1. Follow instructions on page 18. 2. Cancel program and reset clean cycle. 3. Close and lock oven door.

PROBLEM	POSSIBLE CAUSES	SUGGESTED CORRECTIONS
Oven door will not lock for self-clean.	<ol style="list-style-type: none"> 1. Self-clean was not properly set. 2. Oven door is not closed. 	<ol style="list-style-type: none"> 1. Follow instructions on page 18. 2. Be sure door is properly closed.
Oven door will not unlock after clean cycle or if accidentally locked during baking.	<ol style="list-style-type: none"> 1. Clean cycle ended less than one hour ago. 2. Oven hot enough to engage internal lock, if accidentally locked during baking. 	<ol style="list-style-type: none"> 1. Allow about 1 hour for oven to cool. Door can be unlocked when LOCK indicator is no longer displayed. 2. Allow oven to cool until LOCK indicator no longer is displayed. To speed cooling, allow a fan to blow on oven door.
Moisture condensation on oven window.	<ol style="list-style-type: none"> 1. Window may fog when cooking food high in moisture. 2. Used a cloth saturated with water to clean window. 	<ol style="list-style-type: none"> 1. This condition is normal. 2. Wring excess water from cloth before cleaning.
Oven light does not turn on.	<ol style="list-style-type: none"> 1. Oven light bulb is loose or burned out. 2. Light switch in the OFF position. 	<ol style="list-style-type: none"> 1. Check or replace bulb. 2. See page 16 for instructions.
Strong odor or light smoke when oven is turned on the first few times.	<ol style="list-style-type: none"> 1. "Burning off" of manufacturing oils, lubricants used during the manufacturing process, or insulation. 2. Food soil. 	<ol style="list-style-type: none"> 1. This is normal for a new range and will disappear after a few uses. A clean cycle will speed up the process. Opening a window or turning on a fan will help remove the smoke and odor. 2. Use self-clean feature.
<p>"F" plus a number or letters appear in display.</p> 	<p>This is called a FAULT CODE. If a fault code appears in the display and beeps sound, press any pad except the CANCEL and ▲ or ▼ pads. If the fault code and beeps continue, disconnect power to the appliance and call an authorized servicer.</p> <p>If the oven is heavily soiled, excessive flare-ups may result in a fault code during a clean cycle. Press any pad except the CANCEL and ▲ or ▼ pads and allow oven to cool for one hour then reset the clean cycle.</p>	

MAYTAG COOKING APPLIANCE WARRANTY

ONE YEAR – FULL WARRANTY (Parts and Labor)

For **one (1) year** from the date of original retail purchase, any part which fails in normal home use will be repaired or replaced free of charge by the manufacturer.

ADDITIONAL FOUR YEAR – LIMITED WARRANTY (Parts only)

For an additional four (4) year period beyond the first year of the Full warranty, the parts listed below which fail in normal home use will be provided by the manufacturer free of charge for the part itself, with the owner paying all other costs, including labor, when the appliance is located in the United States or Canada. These parts must be installed by an authorized servicer.

- **Smoothtop heating element**
- **Gas sealed surface burner**
- **Glass-ceramic cooktop** – due to thermal breakage

Canadian Residents: The above warranties only cover an appliance installed in Canada that has been certified to a National Standard of Canada unless the appliance was brought into Canada due to transfer of residence from the United States to Canada.

The specific warranties expressed above are the **only** warranties provided by the manufacturer. These warranties give you specific legal rights, and you may also have other rights which vary from state to state.

WHAT IS NOT COVERED BY THESE WARRANTIES:

1. Conditions and damages resulting from any of the following:
 - a. Improper installation, delivery, or maintenance.
 - b. Any repair, modification, alteration or adjustment not authorized by the manufacturer, or an authorized servicer.
 - c. Misuse, abuse, accidents or unreasonable use.
 - d. Incorrect electrical current, voltage or supply.
 - e. Improper setting of any control.
2. Warranties are void if the original serial numbers have been removed, altered, or cannot be readily determined.
3. Light bulbs.
4. Products purchased for commercial or industrial use.
5. The cost of service or service call to:
 - a. Correct installation errors.
 - b. Instruct the user on the proper use of the product.
 - c. Transport the appliance to a servicer.
6. Consequential or incidental damages sustained by any person as a result of any breach of these warranties.

Some states do not allow the exclusion or limitation of consequential or incidental damages, so the above exclusion may not apply to you.

HOW TO RECEIVE WARRANTY SERVICE:

1. For authorized service, contact the Maytag dealer from whom you purchased the appliance or call Maytag Customer Service at **1-800-688-9900 (USA)** or **1-800-688-2002 (Canada)**.
2. If you are not able to satisfactorily resolve the complaint with local response, call or write to:

Maytag Appliances Sales Company
Attn: CAIRSM Center
P. O. Box 2370
Cleveland, TN 37320-2370
1-800-688-9900 (USA)
1-800-688-2002 (Canada)
3. When requesting service, the following information will be needed:
 - a. Your name, address, and telephone number.
 - b. Model and serial numbers (found on the data plate)
 - c. Name and address of dealer or servicer.
 - d. Proof of purchase date (sales receipt).
 - e. A clear description of the problem and service history.

Free Manuals Download Website

<http://myh66.com>

<http://usermanuals.us>

<http://www.somanuals.com>

<http://www.4manuals.cc>

<http://www.manual-lib.com>

<http://www.404manual.com>

<http://www.luxmanual.com>

<http://aubethermostatmanual.com>

Golf course search by state

<http://golfingnear.com>

Email search by domain

<http://emailbydomain.com>

Auto manuals search

<http://auto.somanuals.com>

TV manuals search

<http://tv.somanuals.com>