

HEAT CONTROLLER, INC.

OWNER'S MANUAL

VMH 09/12/18/24

Version C

Inverter Single Zone

Ductless Mini-Split Heat Pump

Table of Contents

Safety Precautions

Warning and Cautions 2

Operating Instructions

Identification of Parts 3
 Display and Remote Controller Features 3
 Operating Conditions and Manual Operation 5
 Airflow Direction Control 6
 Operation Modes 7

Care and Maintenance

Care and Maintenance 8

Operation Tips

Typical Operational Occurrences 10

Troubleshooting Tips



Troubleshooting Tips 12





Caution

- Contact an authorized service technician for repair or maintenance of this unit.
- Contact the installer for installation of this unit.
- Installation work must be performed in accordance with local and national electrical codes and standards by authorized personnel only.

To prevent injury to the user, other people and/or to property, the following instructions must be followed. Incorrect operation due to ignoring these instructions may cause harm or damage. The seriousness is classified by the following indications:

 WARNING!	This symbol indicates the possibility of death or serious injury.
 CAUTION!	This symbol indicates the possibility of injury or damage to property.

Meanings of symbols used in this manual are as shown below:

	Never do this.
	Always do this.

-  **WARNING!**
- Do not attempt to install this air conditioner by yourself.
 - This unit contains no user-serviceable parts. Always consult authorized service personnel for repairs.
 - Do not insert fingers or objects into the outlet or intake grilles.
 - Do not start and stop air conditioner operation by disconnecting the power supply.
 - Take care not to damage the power supply wiring.
 - In the event of a malfunction (burning smell, etc.), immediately stop operation, disconnect the power supply, and consult authorized service personnel.

-  **CAUTION!**
- Provide occasional ventilation during use.
 - Do not direct air flow at fireplaces or heating apparatus.
 - Avoid installing the air conditioner near a fireplace or other heating apparatus.
 - Do not climb on, or place objects on, the air conditioner.
 - Do not hang objects from the indoor unit.
 - Do not set flower vases or water containers on top of the air conditioner.
 - Do not expose the air conditioner directly to water.
 - Do not operate the air conditioner with wet hands.
 - Turn off power source when not using the unit for extended periods.
 - Do not drink the water drained from the air conditioner.
 - Connection valves become hot during Heating; handle with care.
 - Do not apply any heavy pressure to evaporator fins.
 - Operate only with air filters installed.
 - Do not block or cover the intake or outlet grille.
 - Ensure that any electronic equipment is at least 3 feet (1m) away from either the indoor or outdoor units.
 - Do not use inflammable gases near the air conditioner.

OPERATING INSTRUCTIONS

Identification of Parts

Indoor unit

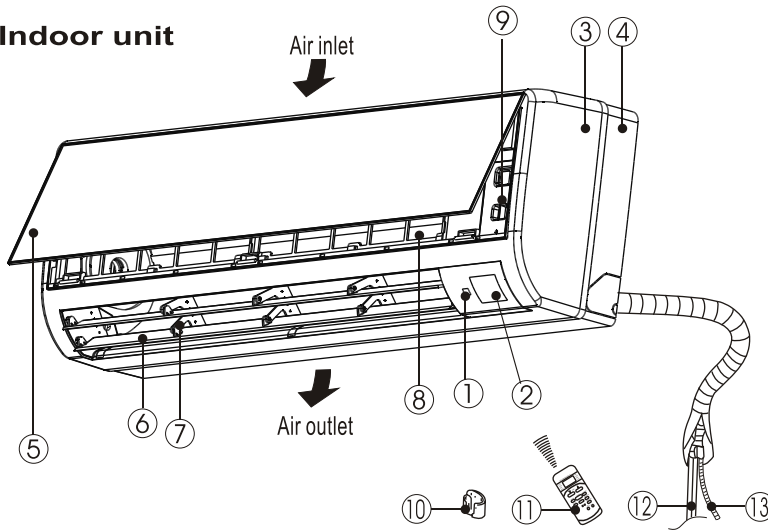

Indoor unit

- 1. Signal receptor
- 2. LCD Display window
- 3. Panel frame
- 4. Chassis
- 5. Front panel
- 6. Horizontal louver
- 7. Vertical louver
- 8. Air filter
- 9. Manual control button
- 10. Remote controller holder
- 11. Remote controller
- 12. Connecting pipe
- 13. Drain hose

Outdoor unit

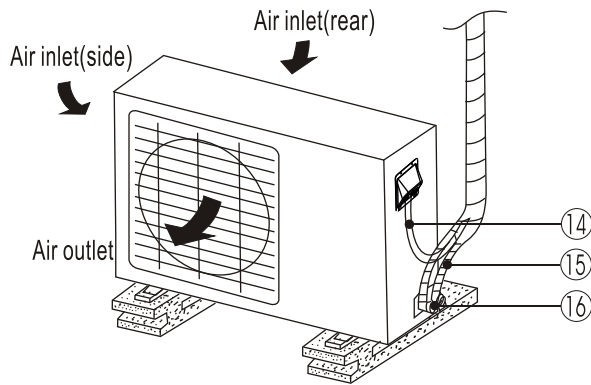

Outdoor unit

- 14. Connecting cable
- 15. Connective pipe
- 16. Base valve

NOTE:

- All the pictures in this manual are for explanation purpose only. Your air conditioner may be slightly different.
- The actual shape shall prevail.

LCD display window

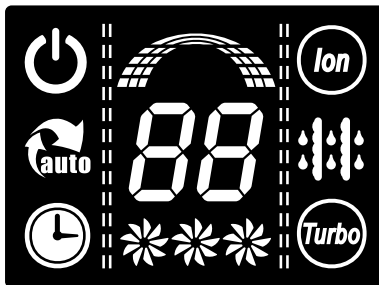

OPERATION display

Illuminated when the air conditioner is in operation.



AUTO operation display

Illuminated during Auto operation.



DEFROST operation display

(Heat Pump model only):
Illuminated when the air conditioner starts defrosting automatically or when the warm air control feature is activated in heating mode.

OPERATING INSTRUCTIONS



TIMER display

Illuminated during Timer operation.



CLEAN AIR display(for some model)

Displayed when TURBO function is selected in cooling or in heating modes. This air conditioner is equipped with an ionizer, which generates ions to remove microscopic particles from the air. Rooms become healthier for those suffering from asthma or allergies with the use of this feature.



TURBO operation display

Illuminated when TURBO function is selected in cooling or heating operation.





DIGITAL DISPLAY

Displays the current set temperature when the air conditioner is in operation. When SELF CLEAN feature is activated, its displays "SC".



FAN SPEED display

Displayed the selected fan speed: LOW() , MED() and HIGH() .



Operation Frequency display

This display is separated into five zones. The zones illuminate base on the compressor's current frequency. For example, a higher frequency will illuminate more zones.

Remote Controller Features

The remote controller comes with a FOLLOW ME feature which allows the remote controller to act as a thermostat. This allows the unit to sense the temperature at the location of the remote controller, rather than sensing the temperature at the indoor unit. The indoor unit is installed high on a wall, thus the thermostat on the remote controller will provide a more accurate temperature reading for the room. Consult the remote controller manual for more information.

OPERATING INSTRUCTIONS

NOTE: This manual does not include Remote Controller Operations, see the <<Remote Controller Manual>> packaged with the unit for details.

See chart below for operating conditions:

Mode	Temp	Ambient Operating Conditions	
		Fahrenheit	Celsius
Cooling	Outdoor	5 to 122	-15 to 50
	Indoor	=62.6	=17
Heating	Outdoor	5 to 93.2	-15 to 34
	Indoor	=86	=30
Dehumidification	Outdoor	5 to 122	-5 to 50
	Indoor	>50	>10

Operating Conditions:

When cooling is needed year round, including when outdoor temperatures are apt to fall below freezing, our V Series inverter driven ductless mini-split systems will continue to work, as they come with factory installed low ambient controls. The low ambient feature works by regulating the head pressure by varying the amount of air flow through the condenser, which helps to prevent evaporator freeze ups and low pressure problems due to low ambient outdoor temperatures. Low ambient operation is a great feature for temperature/humidity sensitive environments or applications such as server/computer rooms, supermarkets, restaurants, or cooling tower fans. Additionally, a crank case heater is required and factory installed, as it is needed for use with the low ambient controls. The crank case heater minimizes liquid refrigerant migration to the compressor when the compressor is not operating and helps to keep the compressor oil warm enough so that it remains fluid to prevent slugging. Crank case heaters also assist to greatly reduce heat loss to ambient air. Together, the lower ambient feature combined with the factory installed crank case heater, will not only allow the air conditioner to cool year round, but will also prevent compressor failure in low ambient conditions.

Manual Operation:

Manual operation can be used temporarily to run the unit without using the remote controller. This feature can also be used to test the unit during installation and troubleshooting by an authorized service technician.

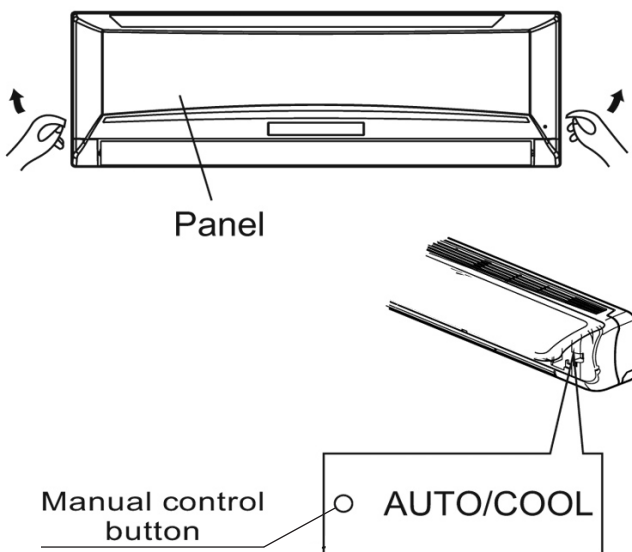

NOTE: The unit must be turned off before operating the manual control button. If the unit operational, continue pressing the manual control button until the unit is off.

1. Grasp both sides of the panel and pull it down. The panel opens upward to an angle of 15°. Push the panel upward and then lift it up.
2. One press of the manual control button will lead to the forced AUTO operation. If the button is pressed twice within five seconds, the unit will operate under forced COOL operation. Press the button a third time to stop the manual operation.
3. Close the panel firmly to its original position.

CAUTION:

- This button is used for testing purposes only.
- To restore the remote controller to control the unit, simply begin to operate the unit with the remote controller.

OPERATING INSTRUCTIONS

Airflow direction control

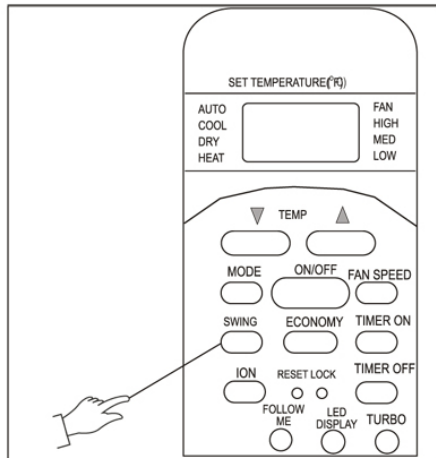

NOTE: The remote controller provided with your unit may differ in appearance. Please refer to the <<Remote Controller Manual>> supplied with the unit to operate the unit properly.

- Adjust the air flow direction properly otherwise it might cause discomfort or uneven room temperatures.
- Adjust the horizontal louver using the remote controller.
- Adjust the vertical louver manually.

To set the vertical (up-down) air flow direction

Perform this function while the unit is in operation. Press the SWING button on the remote controller to move the louver to the desired direction. The angle of the horizontal louver moves 6° for each press of the button.

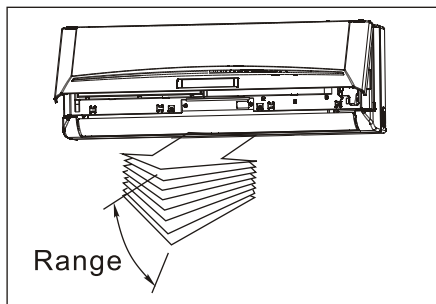

To set the horizontal (left-right) air flow direction

Adjust the vertical louver manually using the lever on the left or right side of the vertical louver arm (depending on model). Take care not to catch fingers on the fan, horizontal louver or to damage vertical louvers. Move the lever to the desired position to direct air flow.

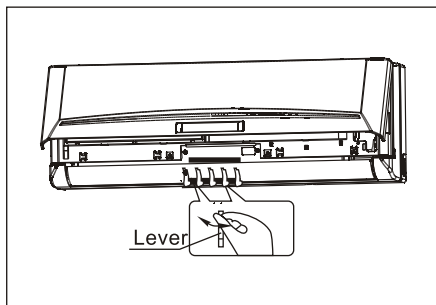

To automatically swing the air flow direction (up - down)

Perform this function while the air conditioner is in operation.

- Hold the SWING button without releasing it for more than 2 seconds. The horizontal louver will swing up and down automatically.
- To stop the function, press the SWING button again.

CAUTION

- The swing function will be disabled when the air conditioner is not in operation (including when the TIMER ON is set).
- Do not operate the air conditioner for long periods with the air flow direction set downward in cooling or dry mode. Otherwise, condensation may occur on the surface of the horizontal louver causing moisture to drop on to the floor or on furnishings.
- Do not move the horizontal louver manually. Always use the SWING button
- When the air conditioner is started immediately after it was stopped, the horizontal louver might not move for approximately 10 seconds.
- Open angle of the horizontal louver should not be set too small, as COOLING or HEATING performance may be impaired due to too restricted air flow area. Do not operate unit with horizontal louver in closed position.
- When the air conditioner is connected to power (initial power), the horizontal louver may generate a sound for 10 seconds, this is a normal operation.

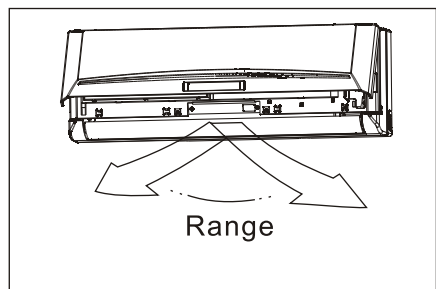

OPERATING INSTRUCTIONS

OPERATING MODES

AUTO operation

- When you set the air conditioner to AUTO mode, it will automatically select cooling, heating (heat pump models only), or fan only operation depending on what temperature you have selected and the actual room temperature.
- The air conditioner will control room temperature automatically around the temperature set point you select.
- If the AUTO mode is uncomfortable, you can change desired temperature settings manually.

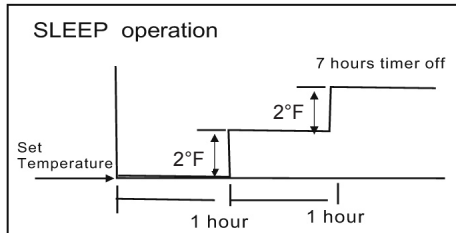

Cooling

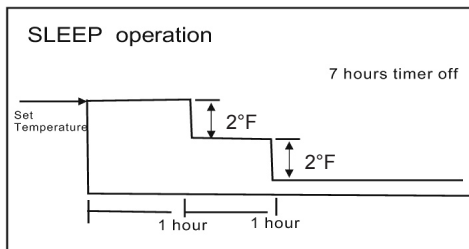

Heating

ECONOMY/SLEEP operation

- When you push ECONOMY button on remote controller it activates SLEEP mode. During cooling, heating (heat pump only), or AUTO operation, the air conditioner will automatically increase (cooling) or decrease (heating) 2°F (1°C) per hour.
- The set temperature will become steady 2 hours later.
- The SLEEP mode will turn off after 7 hours and revert back to the previous settings.
- The fan speed will be automatically controlled.
- This feature can maintain the most comfortable temperature and save more energy during use.

DRY MODE/DEHUMIDIFYING operation:

- The temperature is regulated while dehumidifying by repeatedly turning on and off of the cooling operation or fan only. The fan speed will be automatically controlled. In this mode, if the room temperature is lower than 50°F (10°C) the compressor will stop. The compressor will restart when the room temperature is above 54°F (12.2°C).

Optimal Usage Tips:

To achieve optimal performance, please note the following:

- Adjust the air flow direction correctly so that it is not directed directly blowing on people/animals.
- Adjust the temperature to achieve the highest comfort level. Do not adjust the unit to excessive temperature levels.
- When in COOL or HEAT modes close any open doors and windows within the room that the unit is operating in to increase performance.
- Use TIMER ON button on the remote controller to select a time you want to start your air conditioner.
- Do not put any objects near air inlet or air outlet, as the efficiency of the air conditioner may be reduced and the air conditioner may stop running due to air flow blockages.
- Clean the air filter periodically, otherwise performance may be reduced.
- Do not operate unit with louvers in a closed position
- **SUGGESTION: For units with an electric heater, when the outside ambient temperature is below 32°F (0°C), we strongly recommend that you keep the unit powered on in order to guarantee it runs smoothly.**

CARE AND MAINTENANCE

Care and maintenance

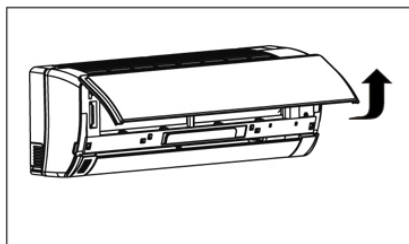
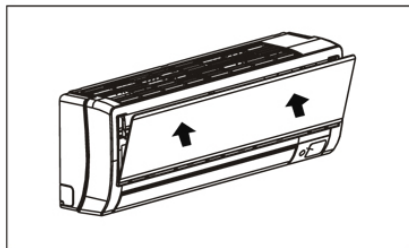
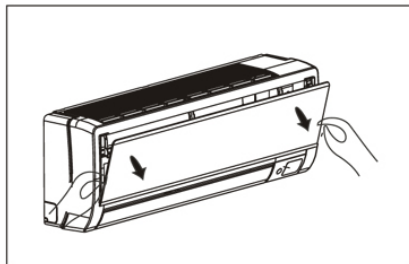
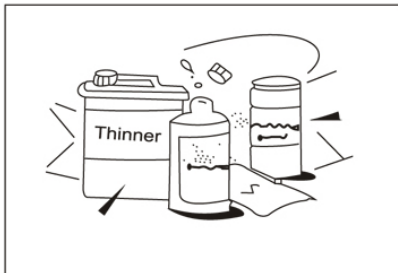
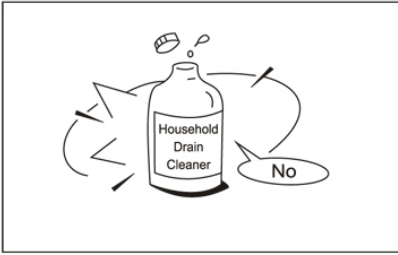

Cleaning the Grille, Case and Remote Controller

- Turn the system off before cleaning. To clean, wipe with a soft, dry cloth. Do not use bleach or abrasives.

NOTE: Supply power must be disconnected before cleaning the indoor unit.

⚠ CAUTIONS

- Do not use an overly wet cloth to clean the unit as it may damage the electronic components. A damp cloth can be used if needed.
- Do not use a chemically treated cloth or duster to clean the unit.
- Do not use benzine, thinner, polishing powder, or similar solvents for cleaning. These may cause the plastic surface to crack or deform.
- Never use water hotter than 104°F (40°C) to clean the front panel. It could cause deformation or discoloration.

Cleaning the air filter

NOTE: Supply power must be disconnected before cleaning the indoor unit.

A clogged air filter reduces the cooling efficiency of this unit. Please clean the filter once every 2 weeks.

1. Lift the indoor unit panel up to an angle until it stops with a clicking sound.
2. Hold the handle of the air filter and lift it up slightly to take it out from the filter holder, then pull it downwards.

CARE AND MAINTENANCE

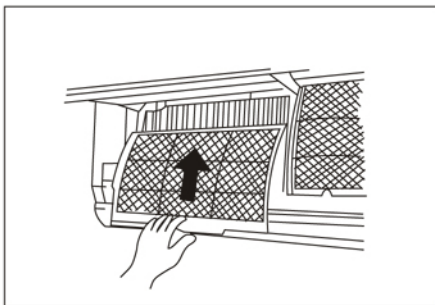
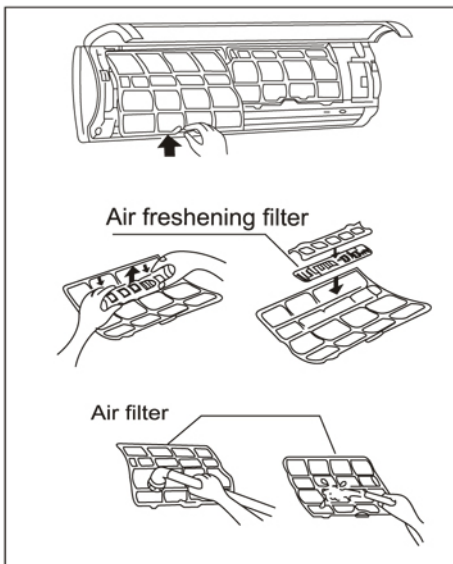
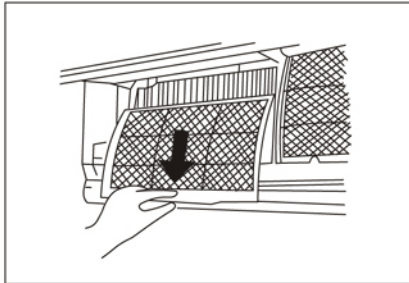
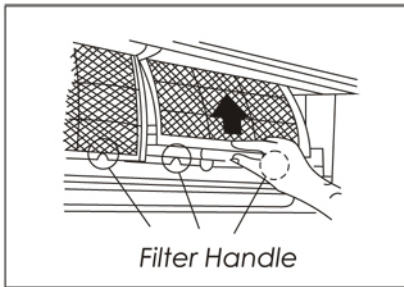

3. Remove the AIR FILTER from the indoor unit.
 - Clean the AIR FILTER once every two weeks.
 - Clean the AIR FILTER with a vacuum cleaner or with water, then dry it in a cool place
4. Remove the **Air Freshening Filter (optional filters: plasma dust collector/silver ion filter/bio filter/vitamin C filter)** from its support frame. The installation and removing method of the air freshening filter is different depending on the models. See the pictures marked 1 and 2 on the left.
 - Clean the air freshening filter at least once a month, and replace it every 4-5 months.
 - Clean it with a vacuum cleaner, then dry it in a cool place.
5. Install the air freshening filter back into position.
6. Insert the upper portion of the air filter back into the unit taking care that the left and right edges line up correctly when placing filter into position.

⚠ Caution

- Do not touch the metal parts of the unit when removing the filter. Injuries can occur when handling sharp metal edges.
- Do not use water to clean inside the air conditioner. Exposure to water can destroy the insulation, leading to possible electric shock.
- When cleaning the unit, first make sure that the power and circuit breaker are turned off.

Maintenance

If you do not plan on using the unit for a long period of time:

1. Clean the indoor unit and air filter.
2. Select FAN only mode, let the indoor fan run for a while to dry the inside of the unit.
3. Disconnect the power supply and remove the batteries from the remote controller.
4. Check components of the outdoor unit periodically. Contact a local dealer or an authorized servicer if the unit requires servicing.

NOTE: Before you clean the air conditioner, be sure to switch the unit off and disconnect the power supply.

When the air conditioner is to be used again:

- Use a dry cloth to wipe off the dust accumulated on rear air intake grille in order to avoid the dust blowing out from the outdoor unit.
- Check that the wiring is not broken off or disconnected.
- Check that the air filter is installed.
- Check if the air outlet or inlet is blocked after the air conditioner has not been used for a long time.

Typical Operational Occurrences

The following events may occur during normal operation.

1. Protection of the air conditioner.

Compressor protection

- If the unit is stopped and then immediately restarted again, the compressor will not operate for about 3 minutes in order to protect the compressor.

Anti-cold air (heat pump models only)

- The unit is designed not to blow cold air in HEAT mode, when the indoor heat exchanger is in one of the following three situations and the set temperature has not been reached.
 - A) When heating has just starting.
 - B) Defrosting is occurring
 - C) Low temperature heating is occurring

Defrosting (Cooling and heating models only)

- The indoor or outdoor fan stop running when defrosting (heat pump models only).
- Frost may accumulate on the outdoor unit during heat cycle when outdoor temperature is low and humidity is high, resulting in lower heating efficiency of the air conditioner.
- During this condition, air conditioner will stop the heating operation and start defrosting automatically.
- Defrost time may vary from 4 to 10 minutes according to the outdoor temperature and the amount of frost buildup on the outdoor unit.

2. Mist or steam are being emitted

- A white mist may emit from the indoor unit due to a large temperature difference between air inlet and air outlet in COOL mode in an indoor environment that has a high relative humidity.
- A white mist may emit due to moisture generated from the defrosting process when the air conditioner restarts in HEAT mode operation after defrosting.

3. Typical sounds

- You may hear a low hissing sound when the compressor is running or has just stopped running. This sound is the sound of the refrigerant flowing or coming to a stop.
- You can also hear a low "squeak" sound when the compressor is running or has just stopped running. This is caused by heat expansion and cold contraction of the plastic parts in the unit when the temperature is changing.
- A noise may be heard due to louver restoring its original position when power is first turned on.
- A sizzling sound may be heard occasionally when the unit is defrosting.

4. Dust is blown out from the indoor unit

- This is a normal condition when the air conditioner has not been used for a long time or during first use of the unit and an accumulation of dust has formed on the unit's outlet. Cleaning dust off of the unit before operation will prevent this.

5. A peculiar smell comes out from the indoor unit

- This is caused by the indoor unit giving off smells permeated from building material, from furniture, or smoke. A burning smell could mean there is something wrong with the unit. Power off the unit and call an authorized servicer.

6. Operating mode changes to FAN ONLY mode

- When the indoor temperature reaches the temperature set point on air conditioner, the compressor will stop automatically, and the air conditioner mode changes to FAN only mode. The compressor will start again when the indoor temperature rises above the set point in the COOL mode or falls below the set point in the HEAT mode (heat pump only models).

7. Condensation

- Dripping water may generate on the surface of the indoor unit when cooling in relatively high humidity. Adjust the vertical louver to the maximum air outlet position and select HIGH fan speed. **NOTE:** Water could drop onto the floor or objects below the indoor unit.

8. Heating mode (heat pump models only)

- The air conditioner draws in heat from the outdoor unit and releases it via the indoor unit during heating operation. When the outdoor temperature falls, heat drawn in by the air conditioner decreases accordingly. At the same time, the heat load of the air conditioner increases due to larger difference between indoor and outdoor temperature. If a comfortable temperature can't be achieved by the air conditioner, we suggest you use a supplementary heating device.

9. Auto-restart function

- Power failure during operation will stop the unit completely.
- For units with the Auto-restart feature, when the power restores, the unit restarts automatically using the previous settings preserved by the memory function of the unit. Timer settings may need to be adjusted after a power failure.

10. Electrical interference

- Electronic equipment which uses wireless radio transmitters within 3 ft (1m) of the air conditioning unit may cause the unit to malfunction. Disconnect the unit with power and then re-connect the unit with power again. Push the ON/OFF button on the remote controller to restart operation. Ensure that the air conditioner unit is as far away from any electronic interference sources as possible, otherwise wireless interference can occur.

Troubleshooting Tips

Stop the air conditioner immediately if one of the following errors occurs. Disconnect the power and contact an authorized servicer.

Call for service if	If any of the following error codes appear on the LED window, disconnect the power and contact an authorized servicer: E0, E1, E2, E3, E4, E5, E6, E7, E8, P0, P1, P2, P3, P4.
	Fuse blows or circuit breaker trips frequently
	Other abnormal situations (such as burning smells) that can't be resolved using the steps outlined below.

Symptoms	Possible Cause/Things to Check	What should be done?
Unit does no start or operate at all	Is there power supplied to the unit?	Wait for the power to be restored or call an electrician to address any power supply problem.
	Fuse may have blown out or a circuit breaker has been tripped.	Replace the fuse or flip the circuit breaker.
	Batteries in remote controller may be dead or installed incorrectly.	Replace the batteries and ensure the polarities are correct.
	Is the unit's timer set?	Wait or cancel timer setting.
Poor cooling or heating (heat pump models only) performance	Inappropriate temperature setting.	Set temperature correctly.
	Air filter may be blocked	Clean the air filter to prevent air flow blockages.
	Doors or windows are open.	Close the doors or windows within the area being cooled/heated to increase efficiency and performance.
	Air inlet or outlet of indoor or outdoor unit are blocked.	Clear obstructions away, then restart the unit.
	Compressor time delay has been activated	Wait approximately 3 minutes for the compressor to turn on and the unit to begin cooling/heating.

If the problem persists after performing these checks, or if you notice burning smells, or the operation indicator light flashes repeatedly, immediately stop operation, disconnect the power, and call an authorized service center.

Design, material, performance data and components
subject to change without notice.

HEAT CONTROLLER, INC.

1900 Wellworth Ave., Jackson, MI 49203 ♦ Ph. 517-787-2100 ♦ Fax 517-787-9341

THE QUALITY LEADER IN CONDITIONING AIR

www.heatcontroller.com

Free Manuals Download Website

<http://myh66.com>

<http://usermanuals.us>

<http://www.somanuals.com>

<http://www.4manuals.cc>

<http://www.manual-lib.com>

<http://www.404manual.com>

<http://www.luxmanual.com>

<http://aubethermostatmanual.com>

Golf course search by state

<http://golfingnear.com>

Email search by domain

<http://emailbydomain.com>

Auto manuals search

<http://auto.somanuals.com>

TV manuals search

<http://tv.somanuals.com>