

Service

This manual is to be used by qualified appliance technicians only. Maytag does not assume any responsibility for property damage or personal injury for improper service procedures done by an unqualified person.

Freestanding Double Oven Electric Range

This Base Manual covers general information

Refer to individual Technical Sheet for information on specific models

This manual includes, but is not limited to the following:

MER6555AAB/Q/W
MER6751AAB/Q/S/W
MER6755AAB/Q/S/W
MER6775AAB/F/N/Q/S/W
MER6875AAB/F/N/Q/S/W
MER6775ACB/F/N/S/W
MER6875ACB/F/N/S/W
MER6755ACB/S/W
MER6555ACW

Important Information

Pride and workmanship go into every product to provide our customers with quality products. It is possible, however, that during its lifetime a product may require service. Products should be serviced only by a qualified service technician who is familiar with the safety procedures required in the repair and who is equipped with the proper tools, parts, testing instruments and the appropriate service information. **IT IS THE TECHNICIANS RESPONSIBILITY TO REVIEW ALL APPROPRIATE SERVICE INFORMATION BEFORE BEGINNING REPAIRS.**

Important Notices for Servicers and Consumers



WARNING

To avoid risk of severe personal injury or death, disconnect power before working/servicing on appliance to avoid electrical shock.

To locate an authorized servicer, please consult your telephone book or the dealer from whom you purchased this product. For further assistance, please contact:

Customer Service Support Center

CAIR Center

<u>Web Site</u>	<u>Telephone Number</u>
WWW.MAYTAG.COM	1-800-688-9900
CAIR Center in Canada	1-800-688-2002

Recognize Safety Symbols, Words, and Labels



DANGER

DANGER—Immediate hazards which **WILL** result in severe personal injury or death.



WARNING

WARNING—Hazards or unsafe practices which **COULD** result in severe personal injury or death.



CAUTION

CAUTION—Hazards or unsafe practices which **COULD** result in minor personal injury, product or property damage.

Table of Contents

Important Information	2	Disassembly Procedures	
Safety Information		Moving and/or Replacing Range	22
Safety Practices for Servicer	4	Leveling Legs	22
Servicing	4	Anti-Tip Bracket	22
Electrical Requirements	4	Smoothtop Removal	22
Extension Cord	4	Side Panel	22
Receiving Oven	5	Bake Element	22
Using the Oven	5	Broil Element	22
Baking, Broiling, and Roasting	5	Oven Sensor	22
Surface Cooking Units	6	Oven Control/Electronic Clock	23
Ovens	6	Oven Light Replacement	23
Precautions	6	Oven Door(s)	
Product Safety Devices	6	Door Removal	23
General Information		Door Replacement	23
Cooking Nomenclature	7	Gasket and Door Disassembly	23
Specifications	8	Lower Latch Assembly	25
Placement of the Oven	8	Upper Latch Assembly	25
Location of Model Number	8	Oven Door Hinge	26
Model Identification	8	Convection Assembly	26
Service	8	Door Plunger	26
Parts and Accessories	8	Rocker Switch	26
Extended Service Plan	8	Indicator Lamps	26
Range Description	9	Hi-Limit Thermostat	26
Troubleshooting Procedures		Infinite Switch	27
Control Systems Troubleshooting	10	Convenience Outlet (Canadian Models Only)	27
Component Troubleshooting	13	Oven Racks	27
Testing Procedures		Rack Positions	27
Component Testing	15	Oven Cavity Components (Electric)	28
H2 Oven Control Testing	18	Appendix A	
H3 Oven Control Testing	19	Installation Instructions	A-2
Quick Test Mode	20	Appendix B	
		Use and Care Model MER6555A**	B-2
		Use and Care Models MER6751AA*, MER6755A**	
		MER6775A**	B-13
		Use and Care Model MER6875A**	B-26
		Cleaning Procedures	B-41

Important Safety Information

Recognize this symbol as a safety precaution.



WARNING

If the information in this manual is not followed exactly, a fire or explosion may result causing property damage, personal injury or death.

There can be a risk of injury or electrical shock while performing services or repairs. Injury or electrical shock can be serious or even fatal. Consequently, extreme caution should be taken when performing voltage checks on individual components of a product. The electrical power supply should ALWAYS be disconnected when servicing a product.

This appliance must be properly grounded. Never plug in or direct-wire an appliance unless it is properly grounded and in accordance with all local and national codes. See "Installation Instructions" that accompany the product for the appropriate grounding procedures.

GROUND PATH SPECIFICATIONS:

Ground Path Resistance: 0.1 ohms maximum
Insulation Resistance: 250k ohms minimum

WARNING

To avoid risk of electrical shock, property damage, personal injury or death; verify wiring is correct, if components were replaced. Verify proper and complete operation of unit after servicing.

This appliance contains or produces a chemical or chemicals which are known to the state of California to cause cancer, birth defects or other reproductive harm. To reduce the risk from substances in the fuel or from fuel combustion, make sure this appliance is installed, operated, and maintained according to the instructions in this manual.



WARNING

Due to the nature of cooking, fires can occur as a result of overcooking or excessive grease. Although a fire is unlikely, if one occurs proceed as follows:

Oven Fires

1. Do not open the oven door.
2. Turn all controls to the OFF position.
3. As an added precaution turn off the electricity at the main circuit breaker or fuse box.
4. Allow the food or grease to burn itself out in the oven.

If smoke or fire persist call the local fire department.

To avoid risk of property damage or personal injury, do not obstruct the flow of combustion or ventilation air to the oven.

To avoid risk of electrical shock, serious personal injury or death: Verify the oven has been properly grounded and always disconnect the electrical supply before servicing this unit.

Safety Practices for Servicer

Safe and satisfactory operation of electrical ranges depends upon its design and proper installation.

Servicing

Listed below are some general precautions and safety practices which should be followed in order to protect the service technician and consumer during service and after service has been completed.

1. **Check range when service is complete**—After servicing, make visual checks on electrical connection. Inform consumer of the condition of range before leaving.
2. **Adhere to all local regulations and codes when performing service.**

Electrical Requirements

120-volt, 60 Hertz, 15 amp, individual circuit which is properly grounded, polarized and protected by a circuit breaker or fuse.

Extension Cord

Due to possible pinching during installation, extension cords should not be used on products.

Extension cords will adversely affect the performance of spark system.

Important Safety Information

Receiving Oven

- Authorized servicer must install the range, in accordance with the Installation Instructions. Adjustments and service should be performed only by authorized servicer.
- Plug range into a 120-volt grounded outlet only. Do not remove round grounding prong from the plug. If in doubt about grounding of the home electrical system, it is consumers responsibility and obligation to have an ungrounded outlet replaced with a properly grounded three-prong outlet in accordance with the National Electrical Code. Do not use an extension cord with this appliance.
- Insure all packing materials are removed from the range before operating it, to prevent fire or smoke damage should the packing material ignite.
- With prolonged use of a range, high floor temperatures could result. Many floor coverings will not be able to withstand this kind of use. Never install range over vinyl tile or linoleum that cannot withstand high temperatures. Never install range directly over carpeting.

Using the Oven

- Do not leave children alone or unattended where a range is hot or in operation. They could be seriously burned.
- Do not allow anyone to climb, stand or hang on the door. They could damage the range and cause severe personal injury.
- Wear proper apparel. Loose fitting or hanging garments should never be worn when using oven. Flammable material could ignite if brought in contact with flame or hot oven surfaces which may cause severe burns.
- Never use range for warming or heating a room. This may cause burns, injuries, or a fire.
- Do not use water on grease fires.
- Do not let grease or other flammable materials collect in or around range.
- Do not repair or replace any part of range unless it is recommended in this manual.
- Use only dry potholders. Moist or damp potholders used on hot surfaces may result in a burn from steam. Do not let a potholder touch the flame. Do not use a towel or a bulky cloth as a potholder.
- Never leave range unattended while cooking. Boilovers can cause smoking and may ignite.
- Only certain types of glass/ceramic, earthenware, or other glazed utensils are suitable for oven use. Unsuitable utensils may break due to sudden temperature change.
- Use care when opening oven door. Let hot air or steam escape before removing or replacing food.

- Do not heat unopened food containers in oven. Buildup of pressure may cause a container to burst and result in injury.
- Keep range vent ducts unobstructed.
- Place oven racks in desired location while oven is cool. If a rack must be moved while oven is hot, use a dry potholder.
- Do not use aluminum foil to line oven bottom or racks. Aluminum foil can cause a fire and will seriously affect baking results, and damage to porcelain surfaces.
- Do not touch interior surfaces of oven during or immediately after use. Do not let clothing or other flammable materials come in contact with bake or broil burners.
- Other areas of the oven can become hot enough to cause burns, such as vent openings, window, oven door and oven racks.
- To avoid steam burns, do not use a wet sponge or cloth to wipe up spills on hot cooking area.
- Do not store combustible or flammable materials, such as gasoline or other flammable vapors and liquids near or in oven.
- Do not clean oven door gasket located on back of the door. Gasket is necessary to seal the oven and can be damaged as a result of rubbing or being moved.
- Do not drape towels or any materials on oven door handles. These items may ignite causing a fire.



CAUTION

Do not store items of interest to children in cabinets above range. Children may climb on oven to reach these items and become seriously injured.

Baking, Broiling, and Roasting

- Do not use oven area for storage.
- Stand back from range when opening a hot oven door. Hot air or steam can cause burns to hands, face, and eyes.
- Use only glass cookware appropriate for use in electric ovens.
- Always remove broiler pan from oven when finished broiling. Grease left in pan can catch fire if oven is used without removing grease from the broiler pan.
- Make sure broiler pan is placed correctly to reduce any possibility of grease fires.
- Should a grease fire occur in the broiler pan, turn off oven, and keep oven door closed until fire burns out.

Important Safety Information

Surface Cooking Units

1. Use Proper Pan Size—This appliance is equipped with one or more surface units of different size. Select utensils having flat bottoms large enough to cover the surface unit heating element. The use of undersized utensils will expose a portion of the heating element to direct contact and may result in ignition of clothing. Proper relationship of utensil to burner will also improve efficiency.
2. Never Leave Surface Units Unattended—Boilover causes smoking and greasy spillovers that may ignite.
3. Make Sure Reflector Pans or Drip Bowls Are In Place—Absence of these pans or bowls during cooking may subject wiring or components underneath to damage.
4. Protective Liners—Do not use aluminum foil to line oven bottom. Improper installation of these liners may result in a risk of electrical shock or fire.
5. Glazed Cooking Utensils—Do not use glass, ceramic, earthenware, or other glazed utensils. They can damage smoothtop and can break due to sudden change in temperature.
6. Utensil Handles Should be Turned Inward and Not Extend Over Adjacent Surface Units—To reduce the risk of burns, ignition of flammable materials, and spillage due to unintentional contact with the utensil, the handle of a utensil should be positioned so that it is turned inward, and does not extend over adjacent surface units.
7. Do Not Soak Removable Heating Elements—Heating elements should never be immersed in water.

Ovens

1. Use Care When Opening Door—Let hot air or steam escape before removing or replacing food.
2. Do Not Heat Unopened Food Containers—Buildup of pressure may cause container to burst and result in injury.
3. Keep Oven Vent Ducts Unobstructed.
4. Placement of Oven Racks—Always place oven racks in desired location while oven is cool. If rack is removed while oven is hot, do not let potholder contact hot heating element in oven.

In Case of Fire

Fires can occur as a result of over cooking or excessive grease. Though a fire is unlikely, proceed as follows:

Surface Element Fire

1. Smother fire with a nonflammable lid/baking soda, or use a Class ABC or BC extinguisher. Not water, salt or flour.
2. As soon as it is safe to do so, turn the surface controls to “OFF”.

Oven Fires

1. If smoke is visible, do not open oven door.
2. Turn oven control to “OFF”.
3. Turn off power at main circuit breaker or fuse box.
4. Turn on vent to remove smoke.
5. Allow food/grease to burn out in oven.
6. If smoke and fire persist, call fire department.
7. If there is any damage to components, call an authorized servicer before using range.

Precautions

- Do not cook food directly on range top surface, always use cookware.
- Do not mix household cleaning products. Chemical mixtures may interact with hazardous results.
- Do not put plastic items on warm cooking areas.
- Do not slide rough objects across range top surface.
- Do not leave fat heating unless you remain nearby. Fat can ignite if overheated by spilling onto hot surfaces.
- Do not allow pots to boil dry as this can cause damage to cooking surface and pan.
- Do not use range top surface as a cutting board.

Product Safety Devices

Safety devices and features have been engineered into the product to protect consumer and servicer. Safety devices must never be removed, bypassed, or altered in such a manner as to defeat the purpose for which they were intended.

Grounded Oven Frame

Ground prong on power cord is connected to the frame, usually a green lead fastened by a screw. In addition, any part or component capable of conducting an electric current is grounded by its mounting.

If any ground wire, screw, strap, nut, etc. is removed for service, or any reason, it must be reconnected to its original position with original fastener before the appliance is put into operation again.

Failure to do so can create a possible shock hazard.

General Information

This manual provides basic instructions and suggestions for handling, installing and servicing electric ranges.

The directions, information, and warnings in this manual are developed from experience and careful testing of the product. If the unit is installed according to this manual, it will operate properly and will require minimal servicing. A unit in proper operating order ensures the consumer all the benefits provided by clean, modern electric cooking.

This manual contains information needed by authorized service technicians to install and service electric ranges.

There may be, however, some parts which need further explanation. Refer to the Installation Instructions, Use and Care, Technical Sheets or the toll-free technical support line.

Cooking Nomenclature

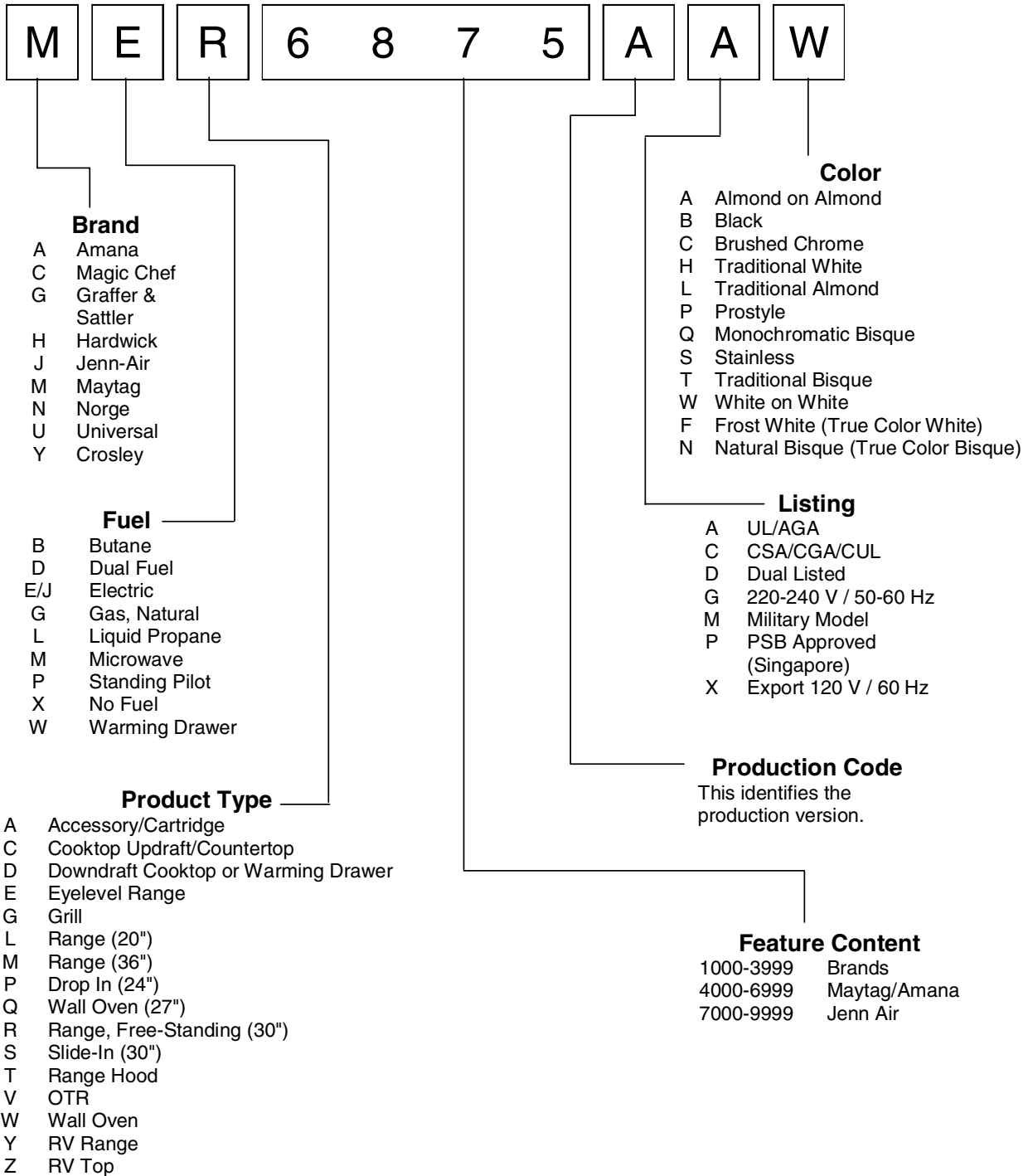

General Information

Specifications

Refer to individual Technical Sheet for specification information.

Placement of the Oven

This freestanding range must be placed in the kitchen or comparable room. All safety guidelines must be followed (see Chapter 2) and free air flow around the range is essential.

Do Not Block Air Vents

All air vents must be kept clear during cooking. If air vents are covered during operation, the oven may overheat. If this occurs, a sensitive, thermal safety device automatically removes power to the oven, rendering the oven inoperable. The oven will remain in this state until it has sufficiently cooled.

Location of Model Number

To request service information or replacement parts, the service center will require the complete model, serial, and manufacturing number of your freestanding range. The number can be found on a metal tag located on the back of the control panel. Reach behind the top left corner of the control panel and rotate the tags up to view the data.

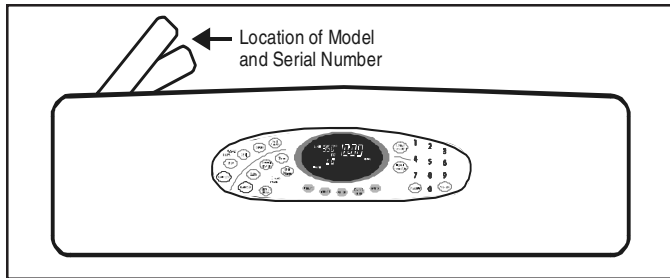

Model Identification

Complete enclosed registration card and promptly return. If registration card is missing:

- For Maytag product call 1-800-688-9900 or visit the Web Site at www.maytag.com
- For product in Canada call 1-866-587-2002 or visit the Web Site at www.maytag.com

When contacting provide product information located on rating plate. Record the following:

Model Number: _____
Manufacturing Number: _____
Serial or S/N Number: _____
Date of purchase: _____
Dealer's name and address: _____

Service

Keep a copy of sales receipt for future reference or in case warranty service is required. To locate an authorized servicer:

- For Maytag product call 1-800-688-9900 or visit the Web Site at www.maytag.com
- For product in Canada call 1-866-587-2002 or visit the Web Sites at www.maytag.com

Warranty service must be performed by an authorized servicer. We also recommend contacting an authorized servicer, if service is required after warranty expires.

Parts and Accessories

Purchase replacement parts and accessories over the phone. To order accessories for your product call:

- For Maytag product call 1-800-462-9824 or visit the Web Site at www.maytag.com
- For product in Canada call 1-866-587-2002 or visit the Web Sites at www.amana.com or www.maytag.com

Extended Service Plan

We offer long-term service protection for this new oven.

- Dependability PlusSM Extended Service Plan is specially designed to supplement Maytag's warranty. This plan covers parts, labor, and travel charges. Call 1-800-925-2020 for information.

Range Description

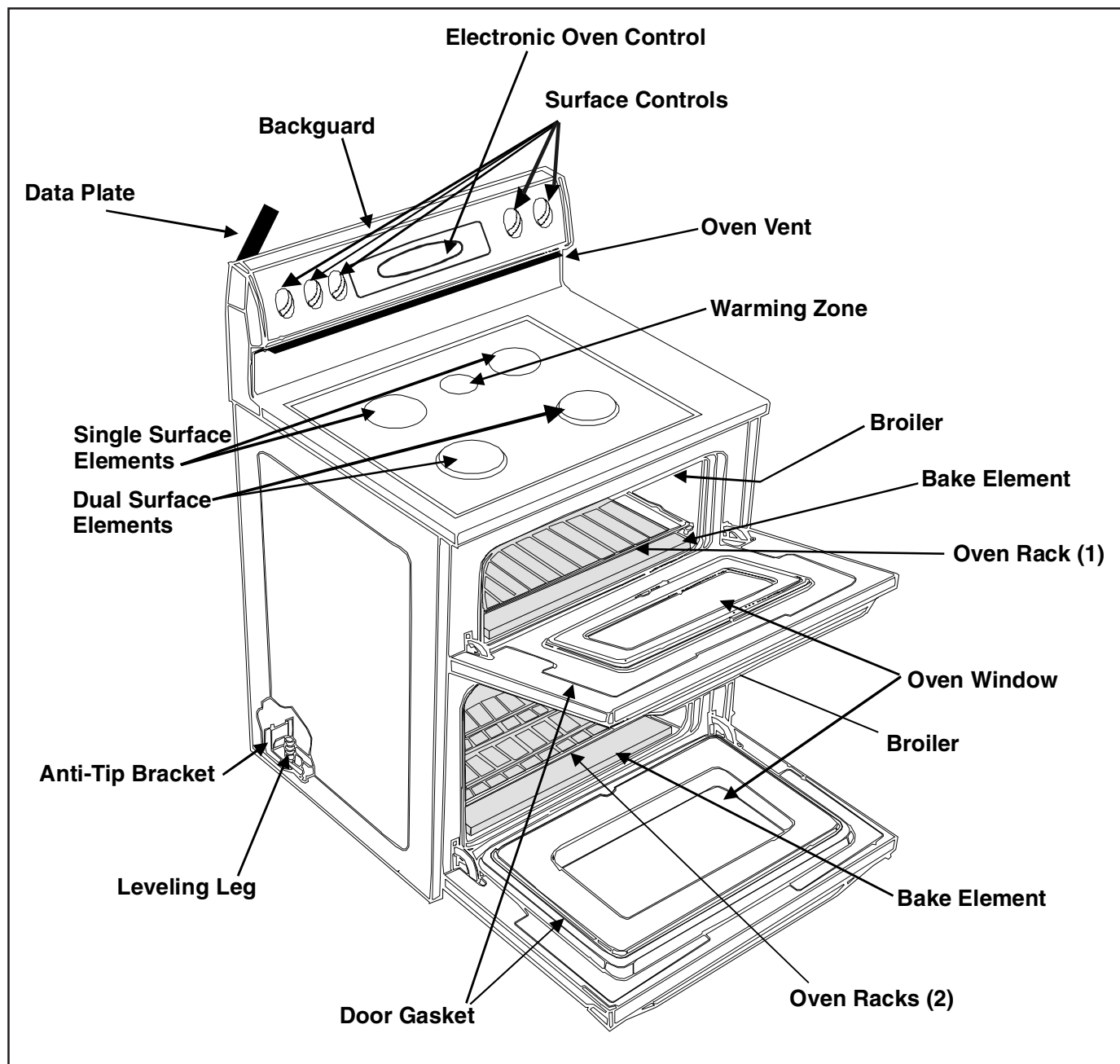

Troubleshooting Procedures



WARNING

To avoid risk of electrical shock, personal injury or death; disconnect power to oven before servicing, unless testing requires power.



CAUTION

- Verify proper grounding before checking for trouble.
- Be careful of the high voltage circuit.
- Discharge the high voltage capacitor.
- When checking the continuity of the switches or of the high voltage transformer, disconnect one lead wire from these parts and then check continuity with the AC plug removed. To do otherwise may result in a false reading or damage to your meter.
- Do not touch any part of the circuit on the printed circuit board, since static electric discharge may damage the control panel. Always touch yourself to ground while working on this panel to discharge any static charge built up on your body.

Control Systems Troubleshooting

Description of Error Codes

The Diagnostic Code Display Mode allows viewing of the error diagnostic codes.

Each error code consists of four digits. The following table describes the function of each digit.

Digit	Description
1 st	Primary System: 1 – Local to the control circuit board 3 – Sensor or meat probe 4 – Control input 9 – Door lock
2 nd	Measurable: d – Diagnostic: measurable parameter c – Control related, replace control
3 rd	Secondary System: Sequential numbering
4 th	Oven Cavity: 1 – Upper oven (or single cavity oven) 2 – Lower oven c – Control specific

Diagnostic Code Display Mode is accessed via the Quick Test Mode. To view the last 5 error codes, enter the Quick Test Mode by **pressing and holding** the *UPPER CANCEL* and *UPPER BROIL* pads for 3 seconds within 5 minutes of power-up. **Diagnostic Code Display Mode may be activated only when applying power to the control.**

Troubleshooting Procedures



WARNING

To avoid risk of electrical shock, personal injury or death; disconnect power to oven before servicing, unless testing requires power.

Diagnostic Code Checking

Code	Description	When Checked	Detection
1c1c	Shorted key	Always	1 minute
1c2c	Keyboard tail disconnected	Always	1 minute
1c31	Cancel key circuit problem	Always	20 seconds
1c32	Cancel key circuit problem	Always	20 seconds
1c6c	EEPROM error	When accessing EEPROM	3 tries
1c7c	Control not calibrated	Always	3 tries
1c8c	Cooking program error	Cook or clean programmed	3 tries
1d11	Runaway temp (650°F), door unlocked	Latch unlocked	1 minute
1d12	Runaway temp (650°F), door unlocked	Latch unlocked	1 minute
1d21	Runaway temp (950°F), door locked	Latch locked	1 minute
1d22	Runaway temp (950°F), door locked	Latch locked	1 minute
3d11	Sensor open	Cook or clean active	20 seconds
3d12	Sensor open	Cook or clean active	20 seconds
3d21	Sensor shorted	Cook or clean active	20 seconds
3d22	Sensor shorted	Cook or clean active	20 seconds
4d11	Door switch position failure	Clean or keyboard Lockout active	1 minute
4d12	Door switch position failure	Clean or keyboard Lockout active	1 minute
4d21	No reverse airflow fan rotation (no/low RPM)	Clean or Cook programmed	1 minute
4d31	Reverse airflow fan state (on when should be off)	Suppose to be OFF	1 minute
4d51	Door switch circuit failure	Convect, Clean or Keyboard Lockout programmed	1 minute
4d52	Door switch circuit failure	Convect, Clean or Keyboard Lockout programmed	1 minute
9d11	Latch will not lock	Latch should be locked	See Note ⁶
9d12	Latch will not lock	Latch should be locked	See Note ⁶
9d21	Latch will not unlock	Latch should be unlocked	See Note ⁶
9d22	Latch will not unlock	Latch should be unlocked	See Note ⁶
9d31	Latch state unknown, both locked and unlocked	Latch should be locked or when lock attempted	See Note ⁶
9d32	Latch state unknown, both locked and unlocked	Latch should be locked or when lock attempted	See Note ⁶

Diagnostic Code Handling

Code	Measurable	What is Displayed	Action Taken By Control
1c1c	Keypress	Nothing	Disables audible for affected key depression Disables all outputs ^{1, 2} Disables lights and timers
1c2c	Keyboard loop improper value	Nothing	Disables audible for key depression Disables all outputs ¹ Disables lights and timers
1c31	Cancel key improper value	BAKE flashes ³	Disables all outputs for cavity ¹
1c32	Cancel key improper value	BAKE flashes ³	Disables all outputs for cavity ¹
1c6c	No response from EEPROM	Nothing	Disables all outputs ¹
1c7c	Calibration value out of range	"CAL" in the time digits	Completely disables oven ⁴
1c8c	CRC invalid	Nothing	Cancels active cook function
1d11	Sensor resistance > 2237 Ω	BAKE flashes ³	Disables all cook function for cavity
1d12	Sensor resistance > 2237 Ω	BAKE flashes ³	Disables all cook function for cavity
1d21	Sensor resistance > 2787 Ω	BAKE flashes ³	Disables all cook function for cavity
1d22	Sensor resistance > 2787 Ω	BAKE flashes ³	Disables all cook function for cavity
3d11	Sensor resistance > Infinite Ω	BAKE flashes ³	Disables all cook function for cavity
3d12	Sensor resistance > Infinite Ω	BAKE flashes ³	Disables all cook function for cavity
3d21	Sensor resistance > 0 Ω	BAKE flashes ³	Disables all cook function for cavity
3d22	Sensor resistance > 0 Ω	BAKE flashes ³	Disables all cook function for cavity
4d11	Door switch not closed when door is locked	Nothing	Disables Clean and Lockout functions ⁵
4d12	Door switch not closed when door is locked	Nothing	Disables Clean and Lockout functions ⁵
4d21	No reverse airflow fan rotation (no/low RPM)	Nothing	Disables all cook function for cavity
4d31	Reverse airflow fan state (on when should be off)	Nothing	No action
4d51	Door switch not open or closed	Nothing	Disables Convect, Clean, and Lockout functions ^{4, 5} Turn off light and disable light from door switch
4d52	Door switch not open or closed	Nothing	Disables Convect, Clean, and Lockout functions ^{4, 5} Turn off light and disable light from door switch
9d11	Lock switch not closed	LOCK flashes ³	Disables Clean and Lockout functions ⁴
9d12	Lock switch not closed	LOCK flashes ³	Disables Clean and Lockout functions ⁴
9d21	Unlock switch not closed	LOCK flashes ³	Disables Clean and Lockout functions ⁴
9d22	Unlock switch not closed	LOCK flashes ³	Disables Clean and Lockout functions ⁴
9d31	Latch both locked and unlocked	LOCK flashes ³	Disables Clean and Lockout functions ⁴
9d32	Latch both locked and unlocked	LOCK flashes ³	Disables Clean and Lockout functions ⁴

Troubleshooting Procedures



WARNING

To avoid risk of electrical shock, personal injury or death; disconnect power to oven before servicing, unless testing requires power.

NOTES:

- 1 "Action Taken" applies as long as the condition exists. If the condition goes away, the control recovers.
- 2 If there is a cook function or timer active, the function continues. The user cannot edit the function, and [Cancel] will cancel the cook mode.
- 3 Flash rate: 0.2 seconds on, 0.1 second off. Pressing any key will clear the display until the fault clears and is re-triggered.
- 4 "Action Taken" applies until there is a POR (Power On Reset ["hard reset"]).
- 5 If the control believes the door is locked, it will attempt to unlock it when the function cancels and the cavity temperature cools.
- 6 Special conditions for latch faults (9dxx):
 - A known good **unlock** position is defined as when the unlock switch reads closed and lock switch reads open.
 - A known good **lock** position is defined as when the unlock switch reads open and lock switch reads closed.
 - A **faulted switch** means the switch input is reading an invalid state, neither open nor closed.
 - Once a latch fault occurs, latch movement is disabled until there is a POR. An error tone will sound if a function requiring a faulted latch is attempted.
 - If at POR, the latch is not at a known good unlock position:
 - If the latch is at a good lock position, it will attempt to unlock when the RTD (Resistance Temperature Device) temperature is below 400°F.
 - If the latch is not at a good lock position, the control will fault.
 - If a latch fault occurs while the RTD is above the lock temperature, the latch will not try to move, but the fault is still logged to EEPROM after the first stage of detection.
 - The Display column for latch faults applies 1) If the latch was moving when the fault occurred; 2) If the latch is already in a known locked state when the fault occurs.
 - LOCK flashes after a fault is detected and until the unlocked position is achieved. The unlock position may be identified by a successful unlock switch closure, or as the result of timing when the unlock switch is not functioning properly.
 - If the last known good position was unlock (e.g. baking, or idle) and a latch fault occurs, the motor is never moved. The fault is logged to EEPROM and is not seen by the user.
 - Latch fault detection is in two stages. The first stage is to allow the control to recover without moving the latch. After this:
 - If the latch was previously at a known good unlock position, the latch will not move and the control will fault.
 - If the control was previously in a known good lock position:
 - If the RTD is below 400°F, the latch will attempt to recover to its proper position (up to three revolutions). If it cannot, the control will fault and the latch will move to a calculated unlock position.
 - If the RTD is at or above 400°F, the control will fault. When the RTD cools to below 400°F, the control will attempt to recover to a good unlock position (up to three revolution). If it cannot, the control will fault and the latch will move to a calculated unlock position.
 - **Note:** If the unlock position cannot be found, this may result in a second fault, the first fault occurring when the latch request was locked, and the second when the latch request is unlocked.
 - If the latch is moving when the fault occurs, the control will bypass the first stage of detection and immediately try to find its proper position. If it cannot, the control will fault and the latch will move to a calculated unlock position.
 - Affected DLBs (Double Line Breaks) and loads are disabled during detection.
 - If the control is in a known good unlock position and the lock switch becomes faulted:
 - The control will not fault.
 - If a function requiring latch movement is attempted while the lock switch is faulted, the control will sound an error tone and the function will be disabled.
 - If the control is in a known good lock position and the unlock switch becomes faulted:
 - The control will not fault.
 - After the function is canceled and unlock is attempted, the control will attempt to unlock the latch according to the procedures in these notes.

Troubleshooting Procedures



WARNING

To avoid risk of electrical shock, personal injury or death; disconnect power to oven before servicing, unless testing requires power.

Component Troubleshooting

Problem	Possible Cause	Correction
Part or all of the appliance does not work.	Power outage..... Improperly set oven controls..... Oven door locked..... Delayed cooking/cleaning	<ul style="list-style-type: none"> • Check power supply/circuit breaker. • Verify oven controls are properly set. • Verify oven door is unlocked after a self-clean cycle. • Verify oven is not set for delayed cooking or cleaning program.
Surface or oven elements fail to operate or heat food.	No Power Improperly set oven controls.....	<ul style="list-style-type: none"> • Check to be sure plug is securely inserted into receptacle. • Check or re-set circuit breaker. • Check or replace fuse. • Check power supply. • Check if surface and/or oven controls have been properly set. • Ensure oven is not set for a delayed oven operation. • Upper oven may be in a toasting operation. Lower oven will operate when the toasting operation is completed.
Glass-Ceramic surface shows wear.	Tiny scratches or abrasions..... Metal marks Brown streaks and specks..... Areas with a metallic sheen Pitting or flaking	<ul style="list-style-type: none"> • Check to make sure cooktop and pan bottom are clean. Do not slide glass or metal pans across top. Make sure pan bottom is not rough. Use the recommended cleaning agents. • Do not slide metal pans across top. If metal marks appear, clean when cool with Cooktop Cleaning Creme. • Spills not removed promptly. Wiping with soiled cloth/sponge. Pan bottom not clean. • Deposits from water/food. • Sugary boilovers.
No oven operation in bake or broil.	No voltage to control..... No voltage from control..... Loose wire connection or broken wire	<ul style="list-style-type: none"> • Check for 120 VAC at control. If no voltage check power source. • Check 120 VAC to ignitor, if no voltage, replace control. • Verify all connections are clean and tight, replace broken wire.

Troubleshooting Procedures



WARNING

To avoid risk of electrical shock, personal injury or death; disconnect power to oven before servicing, unless testing requires power.

Problem	Possible Cause	Correction
Broil element shuts off shortly after the start of self-clean operation. Bake and broil functions operate normally.	Power outage Control Error	<ul style="list-style-type: none"> • Verify power is present at unit. Verify that the circuit breaker is not tripped. • Replace household fuse, but do not fuse capacity. • See "Control Systems Troubleshooting."
Convection fan motor does not operate.	No power to fan motor Failed fan motor or winding/frozen shaft	<ul style="list-style-type: none"> • Check for 120 VAC supplied at fan motor. If no voltage is present, check for broken or loose wiring between fan motor and relay board. If voltage is present at fan motor, go to the next step. • Check motor winding for continuity. Check for a frozen motor shaft. Check for broken wiring between motor and neutral terminal block.
Oven light does not operate.	Failed oven lamp Failed wiring..... Failed light socket..... Failed light plunger/switch	<ul style="list-style-type: none"> • Check/replace lamp, if necessary. • Check for broken, loose or dirty connections. • Check light socket for continuity. • Check plunger/switch for continuity. Check wiring diagram for application.
Self-clean cycle not working.	Programming error	<ul style="list-style-type: none"> • Shut off power to oven for five minutes by switching off circuit breaker. Reset circuit breaker and try oven again.
Oven door will not unlock.	Oven is self-cleaning Oven is still hot	<ul style="list-style-type: none"> • Allow cycle to complete. • Door will not unlock until unit has cooled to safe temperature. Do not force door open, this will void warranty. Blow cool air on door latch area to quicken process.
Oven smokes/odor first few times of usage.	Normal	<ul style="list-style-type: none"> • Minor smoking and/or odor is normal the first few times of oven usage. • Ventilate area well and perform self-clean cycle.
Failure Codes.	Electronically Controlled	<ul style="list-style-type: none"> • See Testing Procedures for diagnostic checks.





Testing Procedures

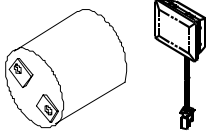
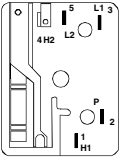

WARNING

To avoid risk of electrical shock, personal injury or death; disconnect power to oven before servicing, unless testing requires power.

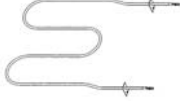
Component Testing

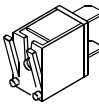

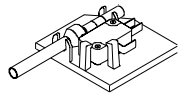
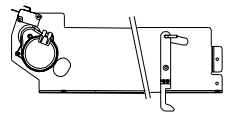

Illustration	Component	Test Procedure	Results
	Oven light socket	Remove one wire from receptacle and test resistance of terminals Measure voltage at oven light	Indicates continuity with bulb screwed in. 120 VAC, see wiring diagram for terminal identification. If no voltage is present at oven light, check wiring or light switches.
4-turn 5-turn (Model MER655AA*)	Coil elements	Remove element and measure resistance across terminals.	Continuity, if not replace. 4-turn: 37 to 45 Ω Approximately 5-turn: 23 to 27 Ω Approximately
1200 W 2500 W	Ribbon elements	Remove element and measure resistance across terminals.	Continuity. If not, replace. 1200W: 45 to 49 Ω Approximately 2500W: 20 to 24 Ω Approximately
2400 W/1100 W (Dual) 2700 W/1700 W (Dual) (Models MER6775AA*, MER6875AA*)	Ribbon elements	Remove element and measure resistance across terminals.	Continuity. If not, replace. 1100W: 40 to 46 Ω Approximately (Inner) 1300W: 47 to 54 Ω Approximately (Outer) 1700W: 30 to 36 Ω Approximately (Inner) 1000W: 53 to 59 Ω Approximately (Outer)
2700 W (Single) (Model MER6755AA*)	Ribbon elements	Remove element and measure resistance across terminals.	Continuity. If not, replace. 2700W: 19 to 23 Ω Approximately
100 W (Warmer) (Models MER6775AA*, MER6875AA*)	Ribbon elements	Remove element and measure resistance across terminals.	Continuity. If not, replace. 100W: 132 to 146 Ω Approximately
	Snap Action Infinite switch	Connect Volt-ohms meter to H1 and H2. Measure the following for voltages at LO, MED, HI: H1 to H2	Approximate Time On Time Off LO 5% 95% MED (4-5) 35% 65% HI 100% 0% 240 VAC, if not replace switch.
	Bake element, Upper	Disconnect wire leads to element and measure resistance of terminals Measure voltage at bake element	Approximately 31.0 Ω, if not replace. 240 VAC, see wiring diagram for terminal identification. If no voltage is present at bake element check wiring.
	Bake element, Lower	Disconnect wire leads to element and measure resistance of terminals Measure voltage at bake element	Approximately 21.3 Ω, if not replace. 240 VAC, see wiring diagram for terminal identification. If no voltage is present at bake element check wiring.
	Broil element, Upper	Disconnect wire leads to element and measure resistance of terminals Measure voltage at broil element	Approximately 25.4 Ω, if not replace. 240 VAC, see wiring diagram for terminal identification. If no voltage is present at broil element check wiring.
	Broil element, Lower	Disconnect wire leads to element and measure resistance of terminals Measure voltage at broil element	Approximately 18.6 Ω, if not replace. 240 VAC, see wiring diagram for terminal identification. If no voltage is present at broil element check wiring.

Testing Procedures



WARNING

To avoid risk of electrical shock, personal injury or death; disconnect power to oven before servicing, unless testing requires power.

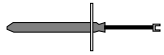
Illustration	Component	Test Procedure	Results
	Oven indicator light and Surface indicator light	Measure voltage at indicator light.	If voltage is present and light does not work replace light. If no voltage is present at indicator light check wiring.
	Rocker switch	Measure continuity of switch positions: Closed..... Open.....	Continuity Infinite
	Door plunger switch	Measure continuity at the following points: C-NO	Plunger in continuity, Plunger out infinite.
	Autolatch assembly with switch	Disconnect wires and test for continuity per wiring diagram.	See wiring diagram for schematic layout. Refer to Parts Manual for correct autolatch switch associated with the correct manufacturing number.
	Convection Assembly Convection Element Convection Motor	Measure voltage..... Remove wires, check resistance..... Check motor windings to ground..... Motor speed.....	120 VAC. Approximately 30 Ω. No continuity. Approx. 900 RPM.
	Limiter	Normally Closed Verify proper operation. Open..... Approx. 216°F..... Closed..... Approx. 176°F.....	Infinite Continuity
	Temperature sensor	Measure resistances	Approximately 1100 Ω at room temperature 75°F.

Testing Procedures



WARNING

To avoid risk of electrical shock, personal injury or death; disconnect power to oven before servicing, unless testing requires power.

H2 Control Testing (Model MER6875A**)

Illustration	Component	Test Procedure	Results
H2 Controlled	Oven temperature adjustment (Upper Oven)	Press Upper Bake pad. Enter 550 on the digit-pad. Immediately press and hold Upper Bake pad for 3 seconds. Adjust oven from -35° to +35° (-37.2° to + 1.6° C) in 5° F (2.7° C) increments by pressing Autoset pad. To avoid over adjusting the oven, move temperature 5° F (2.7° C) each time. Wait 4 seconds for the data entry timer to expire to accept the change. Temperature adjustment is retained even through a power failure.	While increasing or decreasing oven temperature, this does not affect self-cleaning temperature.
H2 Controlled	Oven temperature adjustment (Lower Oven)	Press Lower Bake pad. Enter 550 on the digit-pad. Immediately press and hold Lower Bake pad for 3 seconds. Adjust oven from -35° to +35° (-37.2° to + 1.6° C) in 5° F (2.7° C) increments by pressing Autoset pad. To avoid over adjusting the oven, move temperature 5° F (2.7° C) each time. Wait 4 seconds for the data entry timer to expire to accept the change. Temperature adjustment is retained even through a power failure.	While increasing or decreasing oven temperature, this does not affect self-cleaning temperature.
H2 Controlled	Temperature display	Press and hold Upper Cancel and Upper Bake pads for 3 seconds.	This mode enables the user to indicate °F or °C on the display.
H2 Controlled	Clock Display	Press and hold Upper Cancel and Clock pads for 3 seconds.	Allows clock to be toggled On or OFF.
H2 Controlled	24 Hour Clock	Press and hold Upper Cancel and Favorite pads for 3 seconds.	Allows the time on the clock to be toggled from 12 hour or 24 hour display.
H2 Controlled	Factory Default	Press and hold Upper Cancel and Upper Keep Warm pads for 3 seconds.	Allows the clock to be reset to factory settings.
H2 Controlled	Twelve hour off	Control automatically cancels cooking operation and removes all relay drives 12 hours after the last pad touch.	See Sabbath mode to disable.
H2 Controlled	Sabbath Mode	Hold Clock pad for 3 to 5 seconds to activate Sabbath mode. Hold Clock pad for 3 to 5 seconds to disable Sabbath mode.	“SAbbAth” displays for 5 seconds, then changes to “SAb” (displayed in Temp area). All pad inputs are disabled except CANCEL and CLOCK pads. This mode disables the normal 12 hour shutoff to allow operation of the bake mode for a maximum of 72 hours.
H2 Controlled	Beeper Volume	Hold Upper Cancel and Delay pads for 3 seconds to adjust beeper loudness level.	Volume settings are Low, Medium and High.
H2 Controlled	Child lock out	Press and hold Upper Cancel and Cook & Hold pads for 3 seconds. “OFF” will display where the temperature normally appears. “LOCK” will display flashing while door is locking. To reactivate the control, press and hold Cancel and Cook & Hold pads for 3 seconds.	This is a safety feature that can be used to prevent children from accidentally programming the oven. It disables the electronic oven control. Child lockout features must be reset after a power failure.
H2 Controlled	Diagnostic Code Display	Press and hold Upper Cancel and Autoset pads for 3 seconds. See “Quick Test Mode.” Cycle through the codes using the number pads 1 through 5.	The last 5 diagnostic codes will be stored in the non-volatile memory. See “Description of Error Codes” for explanation.

Testing Procedures



WARNING

To avoid risk of electrical shock, personal injury or death; disconnect power to oven before servicing, unless testing requires power.

H3 Control Testing (Models MER6555A**, MER6751AA*, MER6755A**, MER6775A**)

H3 Controlled	Oven temperature adjustment (Upper Oven)	Press Upper Bake pad. Enter 550 on the digit-pad. Immediately press and hold Upper Bake pad for 3 seconds. Adjust oven from -35° to +35° (-37.2° to +1.6° C) in 5° F (2.7° C) increments by pressing More+ or Less- pads. To avoid over adjusting the oven, move temperature 5° F (2.7° C) each time. Wait 4 seconds for the data entry timer to expire to accept the change. Temperature adjustment is retained even through a power failure.	While increasing or decreasing oven temperature, this does not affect self-cleaning temperature.
H3 Controlled	Oven temperature adjustment (Lower Oven)	Press Lower Bake pad. Enter 550 on the digit-pad. Immediately press and hold Lower Bake pad for 3 seconds. Adjust oven from -35° to +35° (-37.2° to +1.6° C) in 5° F (2.7° C) increments by pressing More+ or Less- pads. To avoid over adjusting the oven, move temperature 5° F (2.7° C) each time. Wait 4 seconds for the data entry timer to expire to accept the change. Temperature adjustment is retained even through a power failure.	While increasing or decreasing oven temperature, this does not affect self-cleaning temperature.
H3 Controlled	Temperature display	Press and hold Upper Cancel and Upper Bake pads for 3 seconds.	This mode enables the user to indicate °F or °C on the display.
H3 Controlled	Factory Default	Press and hold Upper Cancel and Warm pads for 3 seconds.	Allows the clock to be reset to factory settings.
H3 Controlled	Clock Display	Press and hold Upper Cancel and Clock pads for 3 seconds.	Allows clock to be toggled On or OFF.
H3 Controlled	24 Hour Clock	Press and hold Upper Cancel and Delay pads for 3 seconds.	Allows the time on the clock to be toggled from 12 hour or 24 hour display.
H3 Controlled	Demo	Press and hold Upper Cancel and Less - pads for 3 seconds.	Enters a demonstrative sales mode.
H3 Controlled	Twelve hour off	Control will automatically cancel any cooking operation and remove all relay drives 12 hours after the last pad touch.	See Sabbath mode to disable.
H3 Controlled	Sabbath Mode	Hold Clock pad for 5 seconds to activate Sabbath mode. Hold Clock pad for 5 seconds to disable Sabbath mode. Oven must be in BAKE mode before enabling SABBATH.	“SAb” displays and flashes for 5 seconds. All pad inputs are disabled except for CANCEL and CLOCK pads. This mode disables the normal 12 hour shutoff to allow operation of the bake mode for a maximum of 72 hours.
H3 Controlled	Beeper Volume	Hold Upper Cancel and More+ pads for 3 seconds to adjust beeper volume.	Volume settings are Low, Medium and High.
H3 Controlled	Child lock out	Press and hold Upper Cancel and Cook & Hold pads for 3 seconds. “OFF” will display where the temperature normally appears. “LOCK” will display flashing while door is locking. To reactivate the control, press and hold Cancel and Cook & Hold pads for 3 seconds.	This is a safety feature that can be used to prevent children from accidentally programming the oven. It disables the electronic oven control. Child lockout features must be reset after a power failure.
H3 Controlled	Diagnostic Code Display	Press and hold Upper Cancel and Timer for 3 seconds within 5 minutes of power up. See “Quick Test Mode.” Cycle through the codes.	The last 5 diagnostic codes will be stored in the non-volatile memory. See “ Description of Error Codes ” for explanation.

Testing Procedures



WARNING

To avoid risk of electrical shock, personal injury or death; disconnect power to oven before servicing, unless testing requires power.

“Quick Test” Mode for Electronic Range Control

Follow the procedure below to perform the Electronic Range Control (ERC) quick test. Instructions must be entered within 32 seconds of each other (via the touch pad) or the ERC will exit the quick test.

1. **Press and hold** the *UPPER CANCEL* and *BROIL* pads for 3 seconds.
2. Once the control has entered the “Quick Test” mode, release both pads.
3. Press each of the following pads indicated in the table below.

NOTE: Press the applicable pad once to activate the associated response.
Press the applicable pad a second time to deactivate the associated response.

Display will indicate the following:

Pad	Response
BAKE	Bake DLB and Bake relay activated
BROIL.....	Broil DLB and Broil relay activated
KEEP WARM	Bake DLB and Broil DLB activated
CONVECT BAKE	Convection Fan on low speed
CONVECT ROAST	Convection Fan on high speed
CLEAN.....	MDL relay activated
COOK & HOLD.....	Displays last diagnostic code
FAVORITE.....	Displays EEPROM version number
TIMER	Displays main code version number
CLOCK	All display segments illuminated
OVEN LIGHT	Oven light activated
CANCEL	Exit Quick Test mode
1.....	Even segments on
2.....	Odd segments on
3.....	Convection Ring activated; Convection Ring DLB activated
4.....	N/A
5.....	N/A
6.....	N/A
7.....	N/A
8.....	N/A
9.....	N/A
AUTOSET.....	Steps through last 5 diagnostic codes

Setup Options (0) pad is pressed “Press Desired Pad for Selection” will scroll in the display. When a feature is displayed the **AUTO SET** pad is used to toggle the options. Use the chart below to identify the available options.

Control Function	Pad Selection	Default Option	Additional Options
12 hour shut-off	1	12 HR Energy Saver ON	12 HR Energy Saver OFF
Timer beeps	2	Timer Reminder Beeps for 5 Min.	Timer Reminder Beeps for 30 Min. No Timer Reminder Beeps
Cook time beeps	3	Cook Time Reminder Beeps for 30 Min.	Cook Time Reminder Beeps for 5 Min. No Cook Time Reminder Beeps
Control lock	4	Control Unlocked	Control Locked
Scroll speed	5	Medium Speed	Fast Speed Slow Speed
Volume level	6	6 bars	1 to 8 bars
Temp C/F	7	Degrees F	Degrees C
Language	8	English	French, Spanish
Default	9	Press AUTO SET for Factory Settings	N/A
Display On/Off	Clock	Clock Display is ON	Clock Display is OFF

Testing Procedures



WARNING

To avoid risk of electrical shock, personal injury or death; disconnect power to oven before servicing, unless testing requires power.

Component	Test Procedure	Results
Electronic range control	<p>F1-1 –Upper Oven >650°F with door unlocked</p> <p>F1-2 –Lower Oven >650°F with door unlocked</p> <p>F1-3 –Upper Oven >950°F with door locked</p> <p>F1-4 –Lower Oven >950°F with door locked</p> <p>F1-7 –Membrane switch is not responding</p> <p>F3-1 –Upper sensor is shorted at (< 100 Ω) or open at (>5 K Ω)</p> <p>F3-2 –Lower sensor is shorted at (< 100 Ω) or open at (>5 K Ω)</p>	<p>Check actual upper oven temperature, if > 650°F check sensor.</p> <p>Check actual lower oven temperature, if > 650°F check sensor.</p> <p>Check actual upper oven temperature, if > 950°F check sensor.</p> <p>Check actual lower oven temperature, if > 950°F check sensor.</p> <p>Check membrane switch for connection or damage.</p> <p>Check upper sensor, harness, and connections</p> <p>Check upper sensor, harness, and connections</p>
Engineering Test Mode	<p>Press BAKE pad.</p> <p>Enter 100°F using the number pads.</p> <p>Immediately push and hold BAKE pad for appropriate oven approximately 3 seconds.</p> <p>This mode can also be entered by pressing the hidden pad for 3 second located to the left of the lower oven light pad.</p>	<p>Used to view the actual oven temperature for both ovens at all times, even when an oven function is active.</p> <p>This mode will also display the current fault code for 5 seconds in the time digits.</p>
Fault codes accessed through Engineering Test Mode	<p>F0-0 –No fault.....</p> <p>F1-5 –Upper hardware failure within control.....</p> <p>F1-6 –Lower hardware failure within control.....</p> <p>F1-8 –Shorted key in membrane switch.....</p> <p>F1-9 –Internal communication errors within control.....</p> <p>F1-A –Upper latch switches.....</p> <p>F1-B –Lower latch switches.....</p> <p>F1-C –Upper door switch.....</p> <p>F1-D –Lower door switch.....</p> <p>F1-E –Sensor input not calibrated</p> <p>F1-H –EEPROM error.....</p> <p>F1-L –Temp in ovens are the same for long period</p> <p>F1-N –Internal voltage on control not working.....</p> <p>F9-1 –Upper lock switch is not correct</p> <p>F9-2 –Upper unlock switch is not correct.....</p> <p>F9-3 –Control does not see upper door lock.....</p> <p>F9-4 –Lower lock switch is not correct</p> <p>F9-5 –Lower unlock switch is not correct</p> <p>F9-6 – Control does not see lower door lock.....</p> <p>EE –Control cannot read E-PROM. Unit will shut down.</p>	<p>Default from factory</p> <p>Replace control</p> <p>Replace control</p> <p>Check membrane connection</p> <p>Replace control</p> <p>Check latch wire harness</p> <p>Check latch wire harness</p> <p>Check lock wire harness</p> <p>Check lock wire harness</p> <p>Verify sensor is operating properly</p> <p>Replace control</p> <p>Verify sensor is operating properly</p> <p>Replace control</p> <p>Check lock wire harness, and lock switch</p> <p>Check lock wire harness, and lock switch</p> <p>Check lock wire harness, and lock switch</p> <p>Check lock wire harness, and lock switch</p> <p>Check lock wire harness, and lock switch</p> <p>Check lock wire harness, and lock switch</p> <p>Disconnect power for 60 seconds. If EE reappears, replace ERC</p>
Test Mode	<p>This mode must be activated within the first 5 minutes of power up.</p> <p>Press BROIL and CANCEL pad for approximately 3 seconds.</p> <p>If oven temperature is greater than 400°F, the Test Mode cannot be activated or will abort if active.</p> <p>Press and hold individual pads for 4 seconds to activate.</p> <p>Display will have dashes in all segments to indicate the mode is active.</p>	<p>Upper Bake: Energizes upper bake element</p> <p>Lower Bake: Energizes lower bake element</p> <p>Upper Broil: Energizes upper broil element</p> <p>Convection Bake: Energizes convection fan</p> <p>Upper Oven Light: Energizes upper oven light</p> <p>Lower Oven Light: Energizes lower oven light</p> <p>Upper Clean: Energizes upper motorized door lock</p> <p>Lower Clean: Energizes lower motorized door lock</p> <p>Stop Time: Energizes Beeper</p> <p>Cook Time: Displays error codes</p> <p>Timer 1: Energizes ROM version</p> <p>Timer 2: Energizes EEPROM version</p> <p>Keep Warm: Cooling Fan</p> <p>Clock: All display segments light</p> <p>If functions do not perform as specified, replace ERC</p>
Oven temperature adjustment	<p>Push BAKE pad.</p> <p>Enter 550°F using the number pads.</p> <p>Immediately push and hold BAKE pad for appropriate oven approximately 3 seconds.</p> <p>To decrease or increase oven temperature. Push AUTO SET pad until negative or positive numbers appear. Oven can be adjusted from -35° to +35° (-37.2° to + 1.6° C). To avoid over adjusting oven, move temperature -5° (2.7° C) each time.</p> <p>Push OVEN CANCEL button.</p>	<p>While increasing or decreasing oven temperature, this does not affect self-cleaning temperature.</p> <p>Holds offset through power outage.</p>

Disassembly Procedures



WARNING

To avoid risk of electrical shock, personal injury, or death: disconnect electrical and gas supply before servicing.

Moving and/or Replacing Range

1. Turn off electrical power to the range.
2. Slide range forward from installation position.
3. Unplug power cord.
4. Replace range using Installation Instructions.

NOTE: When placing range into installation position, verify anti-tip bracket(s) are engaged.

Leveling Legs

Some floors are not level. For proper baking, your range must be level.

- Leveling legs are located on each corner of the base of the range.
- Place a level horizontally on oven rack and check front-to-back and side-to-side. Level by turning legs.

Anti-Tip Bracket

When ever range is moved or replaced for safety reasons this bracket must be engaged.

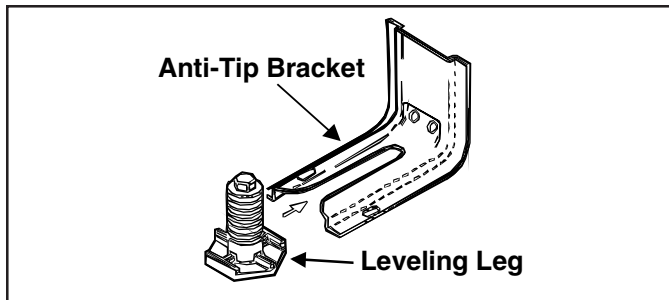

Smoothtop Removal

1. Disconnect power before servicing.
2. Remove screws securing assembly to frame.

NOTE: Open oven door to access screws.

3. Raise smoothtop slightly and move slightly forward.
4. With the smoothtop moved slightly forward, label and disconnect wire harness.
5. Remove smoothtop and place in a protected area with underside up.
6. Reverse procedures to reassemble.

Elements

1. Disconnect power before servicing.
2. Remove smoothtop, see "Smoothtop Removal" procedure. (Perform steps 1 – 5.)
3. Remove screws securing element to assembly.
4. Label and disconnect wiring and remove element.
5. Reverse procedures to reassemble.

Side Panel

NOTE: Removal of range from installation position is required.

1. Disconnect power before servicing.
2. Remove range from installation position, see "Move and/or Replacing Range" procedure.
3. Remove smoothtop, see "Smoothtop Removal" procedure. (Perform steps 1 – 5.)
4. Remove screws securing right side panel at the top and back of panel.
5. Pull side panel outward away from rear of range, then lift upward on the side panel to release from slotted clips located in front and set aside.
6. Reverse procedures to reassemble.

Bake Element

1. Disconnect power before servicing.
2. Remove oven door for easier accessibility, see "Oven Door(s)-Door Removal" procedure.
3. Remove screws securing bake element to back of oven cavity.
4. Gently pull element through cavity wall until terminals can be accessed.
5. Label and disconnect wiring and remove element.
6. Reverse procedures to reassemble.

Broil Element

1. Disconnect power before servicing.
2. Remove oven door for easier accessibility, see "Oven Door(s)-Door Removal" procedure.
3. Remove broil element support brackets.
4. Remove screws securing broil element to back of oven cavity.
5. Gently pull element through cavity wall until terminals can be accessed.
6. Label and disconnect wiring and remove element.
7. Reverse procedures to reassemble.

Oven Sensor

The oven sensor is located inside oven cavity, attached to the upper left rear wall of the cavity.

1. Disconnect power before servicing.
2. Open oven door and remove screws securing sensor to oven cavity.
3. Gently pull wiring through cavity wall.
4. Disconnect sensor at connector block and remove.
5. Reverse procedures to reassemble.

NOTE: Verify connector is pushed through the insulation.

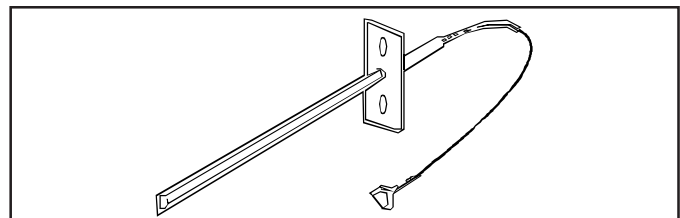

Disassembly Procedures



WARNING

To avoid risk of electrical shock, personal injury, or death: disconnect electrical and gas supply before servicing.

Oven Control/Electronic Clock

1. Disconnect power before servicing.
2. Remove vent deflector by removing screws located on the underside of the backguard.
3. Remove screws securing backguard panel to backguard housing. (Screws are located on the bottom and back side of control panel.)
4. Lift backguard up, tilt forward, and lay panel on a protected surface of the smoothtop for servicing.
5. Remove screw securing mounting plate to backguard.
6. Disconnect and label wiring and remove oven control/electronic clock.
7. Reverse procedures to reassemble.

Oven Light Replacement

The oven light used is a 120 volt, 20 watt Halogen bulb. The light automatically illuminates when the door is opened, or may be manually activated when the door is closed via the light pad. The light will not operate during a clean cycle. The oven light automatically illuminates one minute before a clock-controlled cooking operation ends.

1. Disconnect power before servicing.
2. Open oven door and locate oven light.
3. Grasp lens cover and pull outward on one side to gain access to bulb.
4. Carefully remove old bulb by lifting bulb out of ceramic base.

NOTE: To avoid damaging the new bulb and decreasing life of the bulb, do not touch new bulb with bare hands or fingers.

Hold with a cloth or paper towel.

5. Reverse procedures to reassemble.

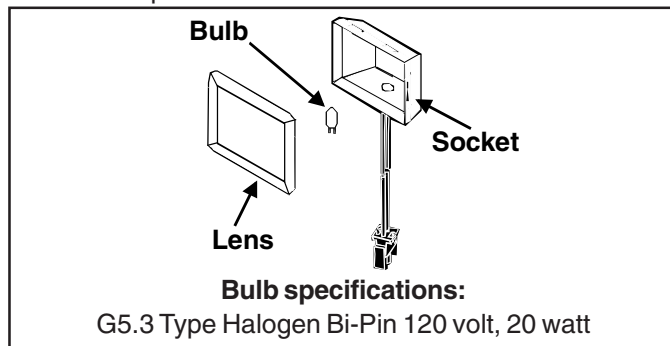

Oven Door(s)

Do not place excessive weight on an open oven door or stand on an opened door as, in some cases, the range may tip over, break, or cause serious injury.

Both the upper and lower oven doors are removable.

NOTE: DO NOT LIFT OVEN DOOR USING HANDLE. Damage to the oven door and personal injury may occur.

Door Removal

- Open door to stop position (approximately 4"), then grasp both sides of the door and lift up off hinges.
- Lay door on a protected surface, liner side up.
- Close door hinges completely to avoid personal injury.

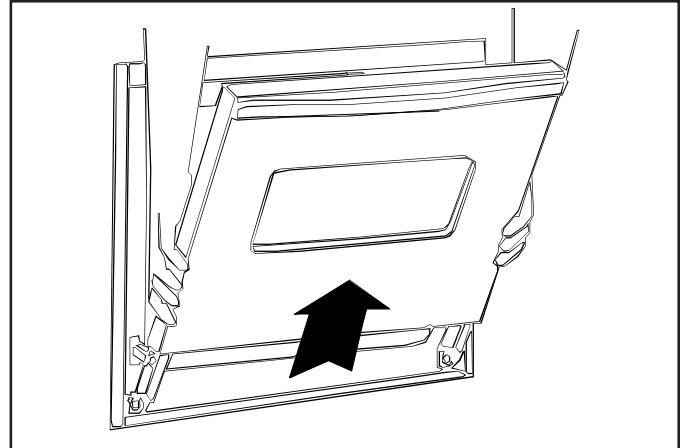

Door Replacement

1. Open door hinges to first stop position and align slots on the door with the hinge arms on the range.
2. Slide door downward onto hinge arms until the door is completely seated on the hinges. Push down on the top corners of the door to completely seat door on hinges. Door should not appear crooked.

NOTE: The oven door on a new range may feel "spongy" when closed. This is normal and will decrease with use.

Gasket and Door Disassembly

NOTE: Door gasket can be replaced by removing door insert clips and sliding gasket out of bottom door insert.

1. Remove oven door, see "Oven Door(s)-Door Removal" procedure.
2. Remove screws securing doorframe to liner located at the bottom.
3. Remove side screws securing doorframe to door liner.
4. Remove screws securing door trim at the top.
5. Slide doorframe and glass off liner from the bottom.
6. Remove screws securing door handle to door liner. (Two on the sides and two in front.)
7. Remove screws securing door baffle to liner.
8. Remove screws securing door baffle to window pack.
9. Remove door baffle and insulation wrap.
10. Remove screws securing window pack to liner. (Window pack comes out as an assembly.)

Disassembly Procedures



WARNING

To avoid risk of electrical shock, personal injury, or death: disconnect electrical and gas supply before servicing.

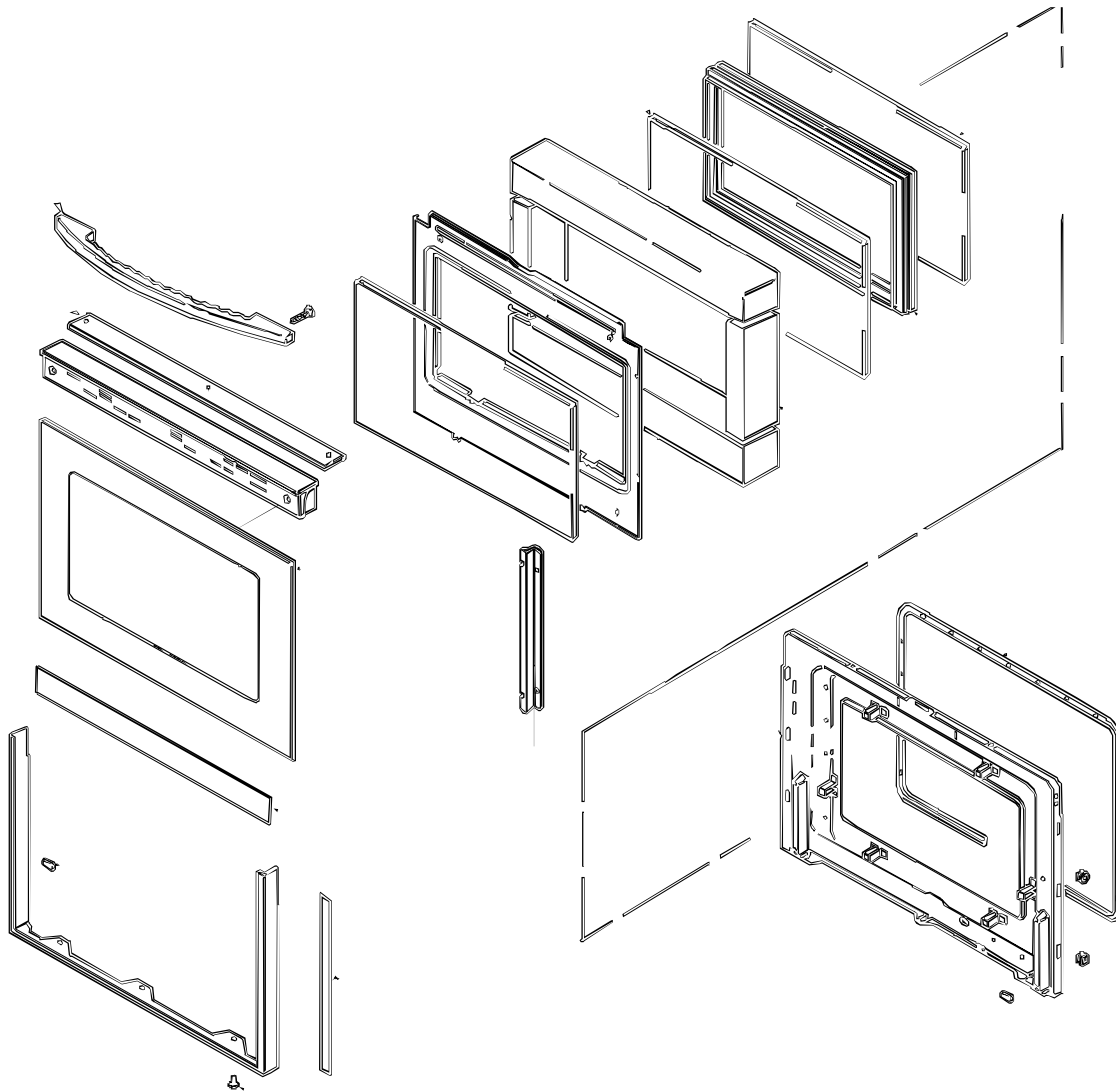

Lower Oven Door

Disassembly Procedures



WARNING

To avoid risk of electrical shock, personal injury, or death: disconnect electrical and gas supply before servicing.

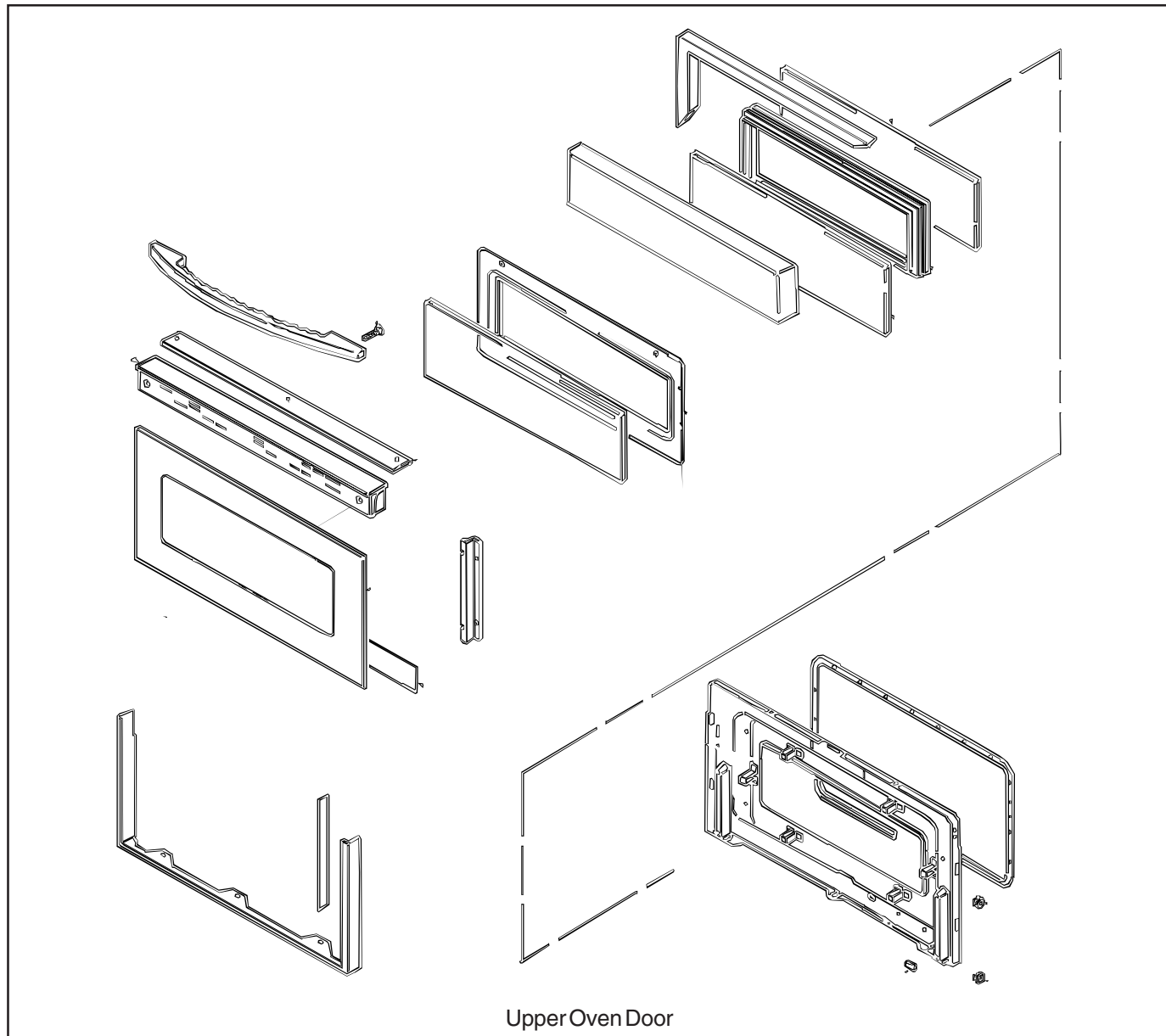

Lower Latch Assembly

NOTE: Removal of range from installation position is required.

1. Disconnect power before servicing.
2. Remove oven door, see "Oven Door(s)-Door Removal" procedure.
3. Remove range from installation position, see "Move and/or Replacing Range" procedure.
4. Remove smoothtop, see "Smoothtop Removal" procedure. (Perform steps 1 – 5.)
5. Remove left side panel, see "Side Panel" procedure.
6. Disconnect and label wiring from door lock switch and motor.
7. Remove screws securing latch assembly and slide assembly from range.
8. Reverse procedure to reassemble.

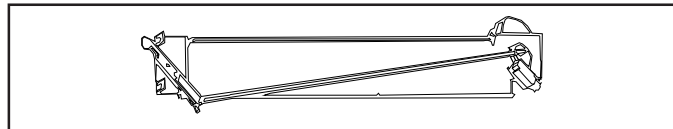

Upper Latch Assembly

1. Disconnect power before servicing.
2. Remove oven door, see "Oven Door(s)-Door Removal" procedure.
3. Remove smoothtop, see "Smoothtop Removal" procedure. (Perform steps 1 – 5.)
4. Disconnect and label wiring from door lock switch and motor.
5. Remove screws securing latch assembly and slide assembly from range.
6. Reverse procedure to reassemble.

Disassembly Procedures



WARNING

To avoid risk of electrical shock, personal injury, or death: disconnect electrical and gas supply before servicing.

Oven Door Hinge

NOTE: Removal of range from installation position is required.

1. Disconnect power before servicing.
2. Remove range from installation position, see "Move and/or Replacing Range" procedure.
3. Remove oven door, see "Oven Door(s)-Door Removal" procedure.
4. Remove smoothtop, see "Smoothtop Removal" procedure. (Perform steps 1 – 5.)
5. Remove appropriate side panel (left or right), see "Side Panel" procedure.
6. Remove screws securing hinge to front frame flange.
7. Complete hinge assembly may be removed.
8. Reverse procedure to reassemble.

NOTE: The door hinges are colored coded for ease of installation. The upper spring hook is gold and the lower spring hook is white.

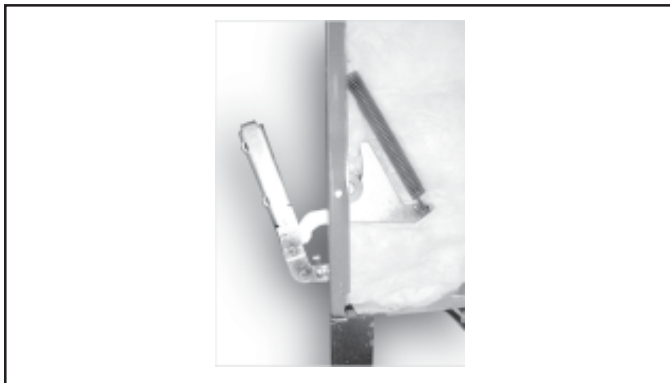

Convection Assembly

(Model MER6875AA*)

1. Disconnect power before servicing.
2. Remove oven door, see "Oven Door(s)-Door Removal" procedure.
3. Remove oven racks from oven cavity.
4. From inside the oven cavity (center-rear), remove screws securing assembly shroud or ring-cover.
5. Remove screws securing assembly to cavity.
6. Remove by gently rotating assembly until enough clearance is established between assembly, cavity wall and wire terminals/connectors.
7. Disconnect and label wire terminals from heat element and assembly (connector block).
8. Remove assembly from cavity.
9. Reverse procedures to reassemble.

Door Plunger

NOTE: Removal of range from installation position is required.

1. Disconnect power before servicing.
2. Remove range from installation position, see "Move and/or Replacing Range" procedure.
3. Remove smoothtop, see "Smoothtop Removal" procedure. (Perform steps 1 – 5.)
4. Remove right side panel, see "Side Panel" procedure.
5. Label and disconnect wiring from door plunger switch.
6. Open oven door and remove screws securing door plunger to the front of the oven cavity.
7. Reverse procedures to reassemble.

Rocker Switch

1. Disconnect power before servicing.
2. Remove infinite switch control knobs located on the backguard.
3. Remove backguard, see "Oven Control/Electronic Clock" procedures. (Perform steps 1 – 4.)
4. Remove housing securing rocker switch to the backguard.
5. Label and disconnect wiring and remove switch.
6. Reverse procedures to reassemble.

Indicator Lamps

Indicator lamps include "Hot Surface" and "Element On."

1. Disconnect power before servicing.
2. Remove infinite switch control knobs located on the backguard.
3. Remove backguard, see "Oven Control/Electronic Clock" procedures. (Perform steps 1 – 4.)
4. Remove housing securing indicator lamps to the backguard.
5. Label and disconnect wiring and remove lamps.
6. Reverse procedures to reassemble.

Hi-Limit Thermostat

NOTE: Removal of range from installation position is required.

1. Disconnect power before servicing.
2. Remove range from installation position, see "Move and/or Replacing Range" procedure.
3. Remove screws securing main back shield and remove shield.
4. Remove screws securing thermostat to range main back.
5. Label and disconnect wiring and remove thermostat.
6. Reverse procedures to reassemble.

Disassembly Procedures



WARNING

To avoid risk of electrical shock, personal injury, or death: disconnect electrical and gas supply before servicing.

Infinite Switch

The infinite switch is a rotary switch, which controls the power dissipated by a heating element. They are located on the control panel.

1. Disconnect power before servicing.
2. Remove infinite switch control knobs located on the backguard.
3. Remove backguard, see "Oven Control/Electronic Clock" procedures. (Perform steps 1 – 4.)
4. Remove screws securing infinite switch to backguard.
5. Label and disconnect wiring and remove infinite switch.
6. Reverse procedures to reassemble.

NOTE: When replacing an infinite switch, ensure the switch is matched to the element.

Convenience Outlet (Canadian Models Only)

The convenience outlet is located on the lower side of the backguard. It is useful for small appliances.

When using the outlet be sure the appliance cord does not rest on or near the surface element. If the surface element is turned on, the cord and outlet will be damaged.

The convenience outlet circuit breaker may trip if the small appliance plugged into it exceeds 10 amps.

1. Disconnect power before servicing.
2. Remove infinite switch control knobs located on the backguard.
3. Remove backguard, see "Oven Control/Electronic Clock" procedures. (Perform steps 1 – 4.)
4. Remove screws securing outlet to backguard.
5. Label and disconnect wiring and remove outlet.
6. Reverse procedures to reassemble.

Oven Racks

- All racks are designed with a lock-stop edge.

Upper Oven

- Equipped with one rack and rack position.
- When pulling the upper oven rack out to remove or check food, grasp the front edge of the rack.

Lower Oven

- Equipped with two RollerGlide™ racks, or 1 RollerGlide rack and 1 Rollout rack.

To remove oven racks:

- Pull rack straight out until it stops at the lock-stop position; lift up on the front of the rack and pull out.
- For lower oven racks, pull both the rack glide and rack base out together.

To replace oven racks:

- Place rack on the rack support in the oven; tilt the front end up slightly; slide rack back until it clears the lock stop position; lower front and slide back into the oven.

Rack Positions

Rack 4: Use for some two-rack baking.

Rack 3: Use for most baked goods on a cookie sheet or jelly roll pan, layer cakes, frozen pies, and frozen convenience foods.

Rack 2: Use for roasting small cuts of meat, casseroles, baking loaves of bread, bundt cakes or custard pies, and two-rack baking of cakes and cookies.

Rack 1: Use for roasting large cuts of meat and poultry, dessert souffles or angel food cake, and two-rack baking of biscuits.

Multiple Rack Cooking:

Two Rack: Use rack position 1 and 4, 1 and 5 or 2 and 5.

Half Rack Accessory (lower oven only)

A half rack, to increase oven capacity, is available as an accessory. It fits in the left, upper portion of the oven and provides space for a vegetable dish when a large roaster is on the lower rack.

Contact your Maytag dealer for the "HALFRACK" Accessory Kit or call 1-800-688-8408.

Disassembly Procedures



WARNING

To avoid risk of electrical shock, personal injury, or death: disconnect electrical and gas supply before servicing.

Oven Cavity Components (Electric)

Open or remove the oven door. The following components are accessible:

Upper Oven

- Racks
- Oven Sensor
- Broiler Element
- Bake Element

Lower Oven

- Racks
- Oven Sensor
- Broil Element
- Bake Element
- Convection Element
- Convection Fan

Appendix A

Maytag Double Oven Range

Cuisinière à deux fours Maytag/Estufa con Horno Doble Maytag

Installation Instructions/Instructions d'installation/Instrucciones de Instalación

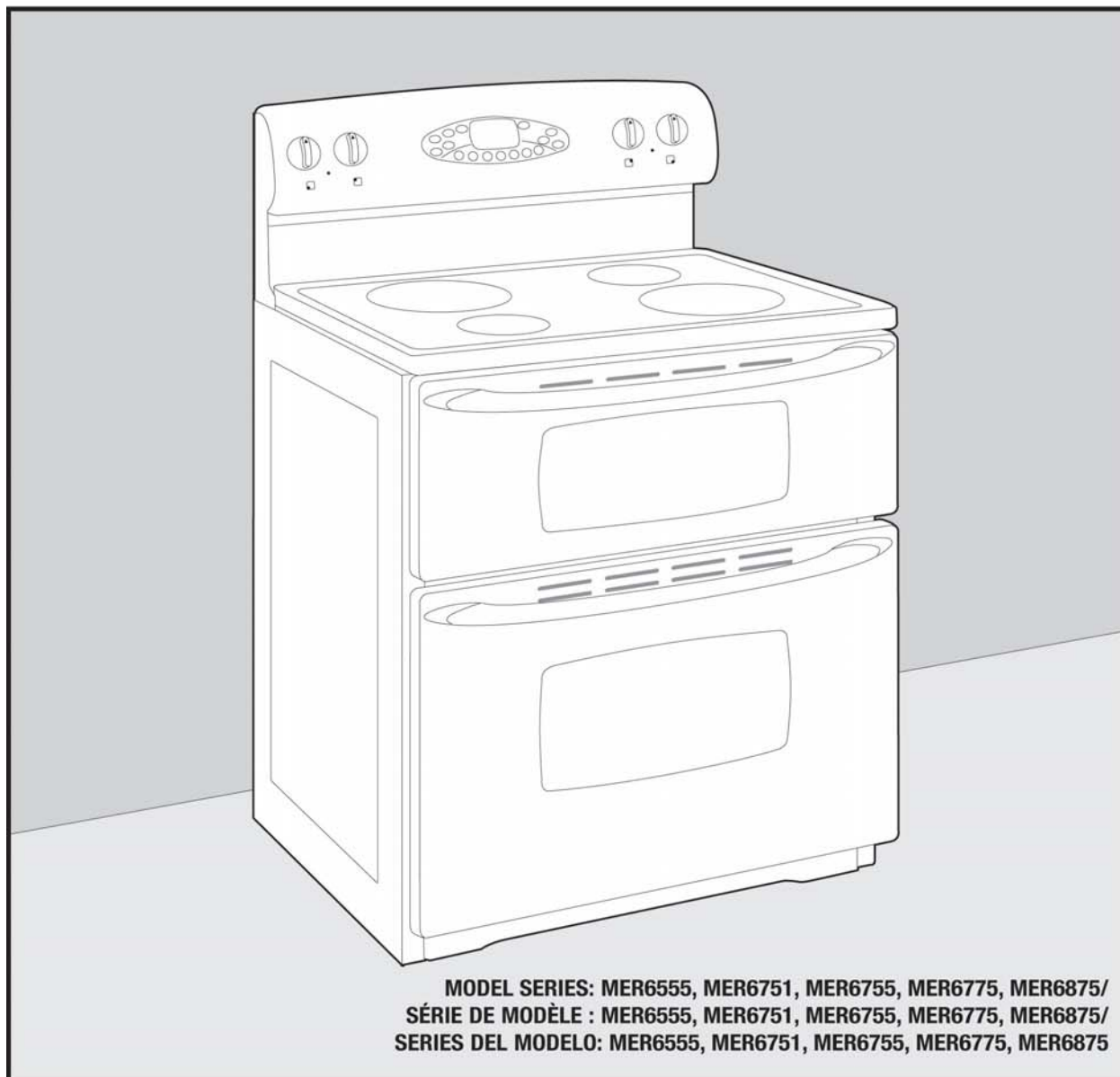

INSTALLER: Leave these instructions with the appliance./**INSTALLATEUR:** Laissez ces instructions avec l'appareil./
INSTALADOR: Deje estas instrucciones con el electrodoméstic.

IMPORTANT: Keep for Local Electrical Inspector/**IMPORTANT :** À conserver pour l'inspecteur local/ **IMPORTANTE:** Guarde esta información para el inspector local.

Installation Instructions

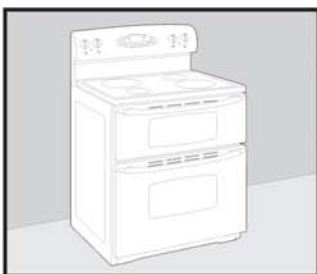

Double Oven Range

INSTALLATION INSTRUCTIONS

PLEASE KEEP THIS MANUAL FOR FUTURE REFERENCE

This manual is intended to assist in the initial installation and adjustments of the range.

- Only qualified personnel should install or service this range.
- Read "Safety Instructions" in Use & Care book before using range.
- Improper installation, adjustment, alteration, service, maintenance or use of range can result in serious injury or property damage.

CAUTIONS

Damage to the range may occur if range is moved or lifted by grasping the main top or backguard. All freestanding ranges with a glass-top have a non lift-top. Coil tops are lift-up.



For **SAFETY CONSIDERATIONS** do not install a range in any combustible cabinetry which is not in accord with the installation clearances found under "Important: Keep for Local Electrical Inspector."

This range has been designed in accordance with the requirements of various safety agencies and complies with the maximum allowable wood cabinet temperatures of 194°F. If this range is installed with cabinets that have a lower working temperature than 194°F, discoloration, delamination or melting may occur.

Place range in a well lit area. Do not set range over holes in the floor or other locations where it may be subject to strong drafts. Any opening in the wall behind the range and in the floor under the range should be sealed. Make sure the flow of cooling/ventilation air is not obstructed below the range. Note: A range should NOT be installed over kitchen carpeting.

WARNING



• **All RANGES CAN TIP AND CAUSE INJURIES TO PERSONS.**

• **INSTALL ANTI-TIP DEVICES PACKED WITH RANGE.**



• **FOLLOW ALL INSTALLATION INSTRUCTIONS.**

A risk of range tip-over exists if the appliance is not installed in accordance with the provided installation instructions. The proper use of the ANTI-TIP device minimizes the risk of TIP-OVER. In using this device the consumer must still observe the safety precautions as stated in the USE and CARE MANUAL and avoid using the oven doors as a step stool. Installation instructions are provided for wood and cement in either floor or wall. Any other type of construction may require special installation techniques as deemed necessary to provide adequate fastening of the ANTI-TIP bracket to the floor or wall. The bracket may be installed to engage the LEFT or RIGHT rear leveling foot. NOTE: The bracket provided is designed for use with flush mount and non-flush mount outlet receptacles. Install the bracket with the orientation hole in the longer leg against the wall or floor as shown in steps 9-12.

MOBILE HOMES

The installation of a range designed for mobile home installation must conform with the Manufactured Home Construction and Safety Standard, Title 24 CFR, Part 3280 (formerly the Federal Standard for Mobile Home Construction and Safety, Title 24 HUD, Part 280) or, when such standard is not applicable, the Standard for Manufactured Home Installations 1982 (Manufactured Home Sites, Communities and Set-Ups), ANSI A225.1-latest edition, or with local codes.

CONNECTING THE RANGE

The range must be installed in accordance with Local and National Electric Code (NEC) ANSI/NFPA No. 70-latest edition, or Canadian Electric Code CSA STD.C221 latest edition. See rating plate for total connected KW rating.

Your local utility company will tell you whether the present electric service to your home is adequate. It may be necessary to increase the size of the wiring to the house and service switch to take care of the electrical load demanded by the range. The kilowatt rating for the range is specified on the rating plate located on flip-up plate at the rear center of backguard.

Most local Building Regulations and Codes require that all electrical wiring be done by licensed electricians. All wiring should conform to Local and National Electrical Codes. This range requires a single phase three wire 120/240 or a 120/208 volt, 60 Hz, AC circuit. Wiring codes require a separate circuit be run from the main entrance panel to the range and that it be equipped with separate disconnect switch and fuses, either in the main entrance panel or in a separate switch and fuse box.

Some models are shipped direct from the factory with service cord attached. There are no range connections necessary on these models. Just plug into the wall outlet. On models not provided with a service cord, connection to the power supply is necessary in accordance with local codes. Provisions for using either conduit or a flexible power cord are provided. When using a power supply cord, use only a supply cord with closed loop terminals rated either 240 volts, 40 amps or 240 volts, 50 amps that is marked for use with nominal 1-3/8" (34.94 mm) diameter connection opening and marked for ranges. A 4-conductor cord is to be used on new branch-circuit installations (1996 NEC), mobile homes, recreational vehicles and where local codes prohibit grounding through the neutral conductor. A 3-wire service may be used when permitted by local codes. When a power supply cord is used, a cord no longer than 4 feet should be used.

Canada

This model is shipped direct from the factory with the service cord attached. There are no range connections necessary.

SERVICE-PARTS INFORMATION

When your range requires service or replacement parts, contact your dealer or authorized service agency. Please give the complete model and serial number of the range which is located on flip-up plate at the rear of upper left-hand corner or center of backguard.

Your range may not be equipped with some of the features referred to in this manual.

Installation Instructions

Dimensions/Dimensions/Dimensiones

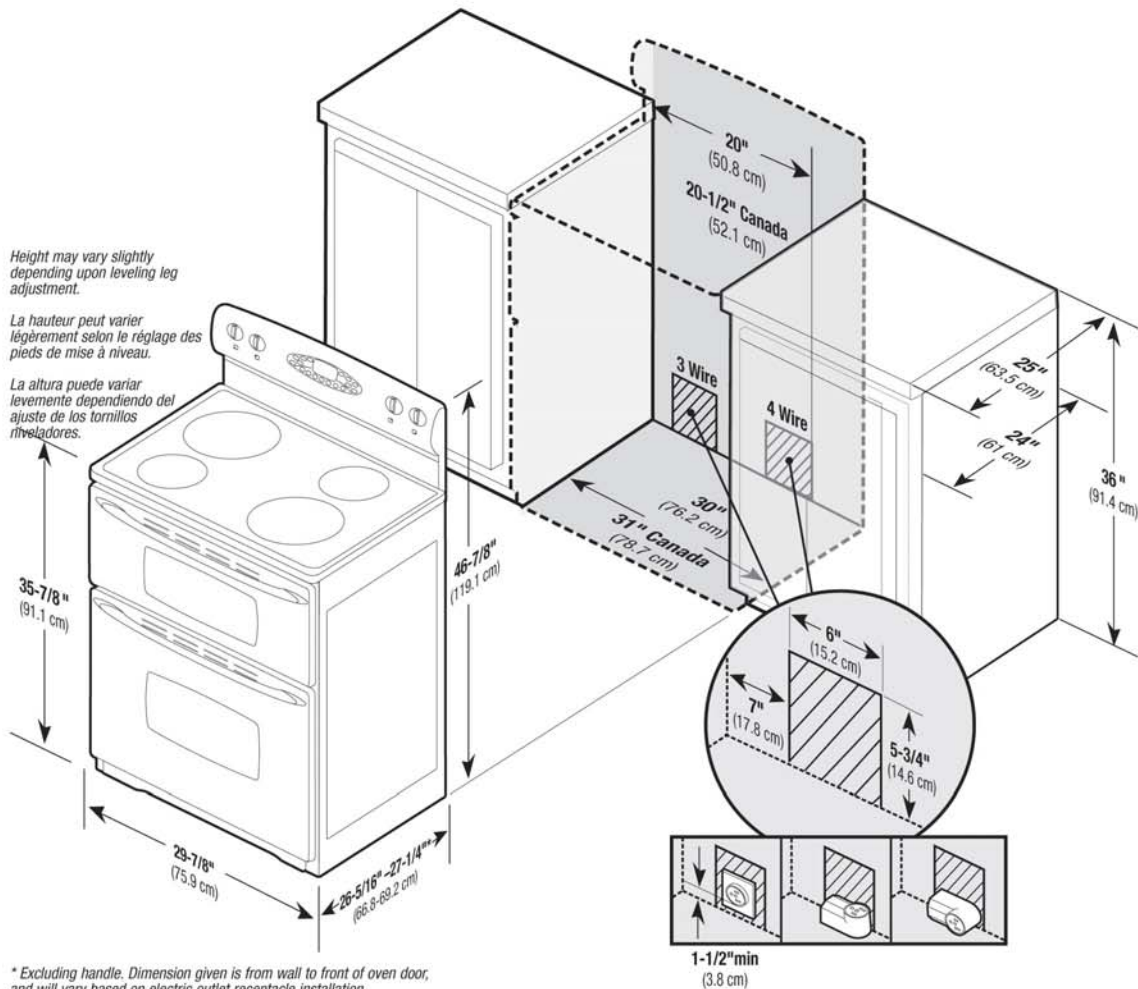

* Excluding handle. Dimension given is from wall to front of oven door, and will vary based on electric outlet receptacle installation.

* Sans la poignée. La dimension donnée est celle du mur à l'avant de la porte du four et variera selon l'installation de la prise de courant.

* No incluye la manija. Las dimensiones mostradas son desde la pared hasta la parte delantera de la puerta del horno, y variarán dependiendo de la instalación del tomacorriente.

120/208, 120/240 Volt Outlet/Prise de 120/208, 120/240 volts/Tomacorriente de 120/208 o 120/240 voltios

Provide for either a 3-wire or 4-wire 120/208, 120/240 volt outlet per applicable cord in a striped area shown above. Refer to dimensions. Proper positioning of outlet shown above.

Prévoyez une prise soit pour 3 fils, soit pour 4 fils de 120/208, 120/240 volts par cordon dans la zone rayée indiquée ci-dessus. Reportez-vous aux dimensions. Bon emplacement de la prise indiqué ci-dessus.

Proporcione un tomacorriente trifilar o tetrafilar de 120/208 o 120/240 voltios en el área sombreada que se muestra arriba de acuerdo con el cordón eléctrico adecuado. Consulte el diagrama de dimensiones. La posición correcta del tomacorriente se muestra arriba.

Important: Because of continuing product improvements, Maytag reserves the right to change specifications without notice. Dimensional specifications are provided for planning purposes only. For complete details see installation instructions that accompany each product before selecting cabinetry, making cutouts or beginning installation.

Important : En raison de l'amélioration continue de ses produits, Maytag se réserve le droit de changer les spécifications sans préavis. Les spécifications dimensionnelles sont fournies à des fins de planification seulement. Pour obtenir des détails complets, consultez les instructions d'installation qui accompagnent chaque produit avant de choisir les armoires, de faire des découpes ou de commencer l'installation.g cabinetry, making cutouts or beginning installation.

Importante: Debido a las mejoras continuas del producto, Maytag se reserva el derecho de cambiar las especificaciones sin aviso previo. Las especificaciones dimensionales se proporcionan para propósitos de planificación únicamente. Para obtener los detalles completos, vea las instrucciones de instalación que acompañan a cada producto antes de seleccionar los armarios, hacer los cortes o comenzar la instalación.

Installation Instructions

Conduit Option/Option pour conduit/Opción del conducto

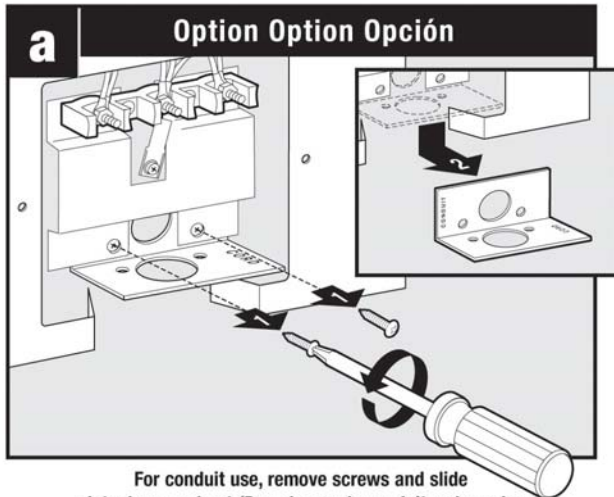

For conduit use, remove screws and slide plate down and out./Dans le cas de conduit, enlevez les vis et abaissez la plaque pour la sortir./Para usar el conducto, retire los tornillos y deslice la placa hacia abajo y hacia afuera.

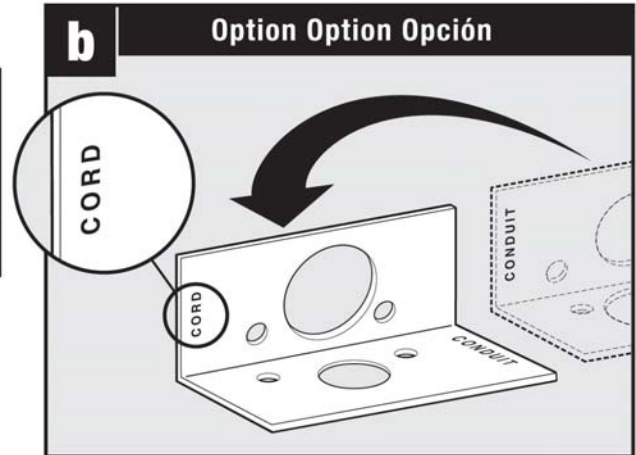

Position conduit plate as shown./Positionnez la plaque à conduit comme il est illustré./Coloque la placa del conducto como se muestra.

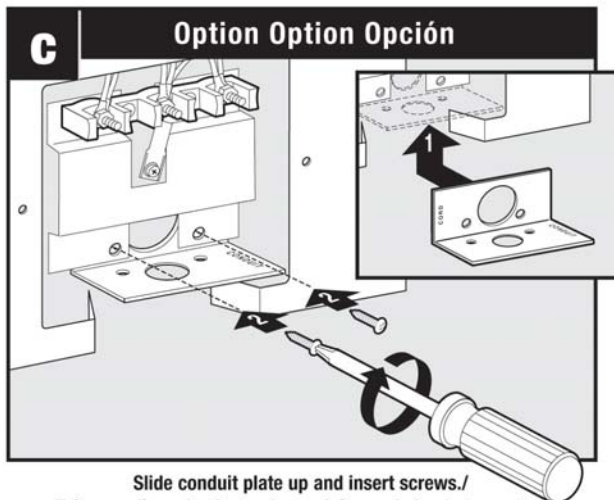

Slide conduit plate up and insert screws./Faites coulisser la plaque du conduit vers le haut et remettez les vis./Deslice la placa del conducto hacia arriba y coloque los tornillos.

Installation Instructions

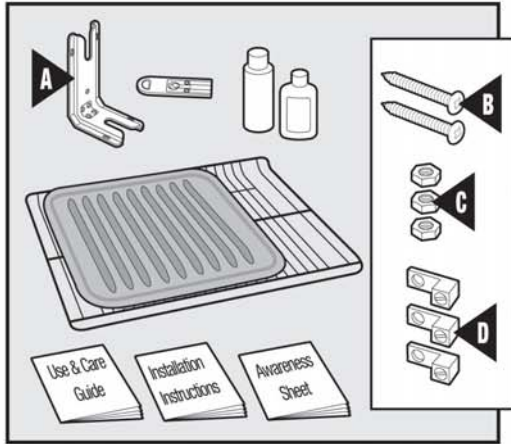

Included./Compris./Se incluye.

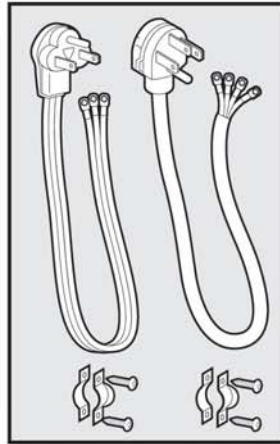

Not included./Non inclus./
No se incluye.

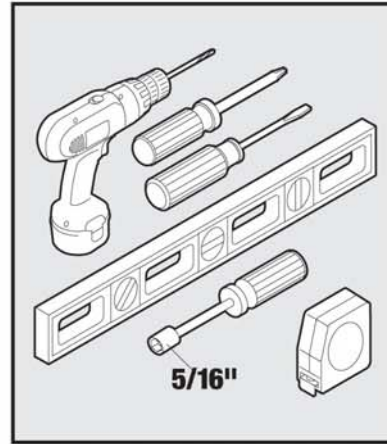

Tools needed./Outils nécessaires./
Herramientas necesarias.

Identify Electrical Connection/Identifiez le raccordement électrique/Identifique la conexión eléctrica/

Note: Some models are shipped directly from the factory with a service cord connected. No additional connections are needed./
Remarque : Certains modèles sont livrés directement de l'usine avec un cordon d'alimentation. Aucun raccordement supplémentaire n'est nécessaire./**Nota:** Algunos modelos vienen equipados de la fábrica con un cordón eléctrico de servicio instalado.
No es necesario realizar conexiones adicionales.

<p>A Existing Outlet/ Prise existante/ Tomacorriente existente</p> <p>240v 3-Wire/240 V, 3 fils/ Cable Trifilar para 240 V</p>	<p>Plug Needed/ Fiche nécessaire/ Se necesita enchufe</p>	<p>B Existing Outlet/ Prise existante/ Tomacorriente existente</p> <p>240v 4-Wire/240 V, 4 fils/ Cable Tetrafilair para 240 V</p>	<p>Plug Needed/ Fiche nécessaire/ Se necesita enchufe</p>	<p>C Existing Connection/ Raccordement existant/ Conexión existente</p> <p>240v 3-Wire/240 V, 4 fils/ Cable Tetrafilair para 240 V</p>	<p>D Existing Connection/ Raccordement existant/ Conexión existente</p> <p>240v 4-Wire/240 V, 4 fils/ Cable Tetrafilair para 240 V</p>
---	---	--	---	---	---

Before Installation/Avant l'installation/Antes de la instalación

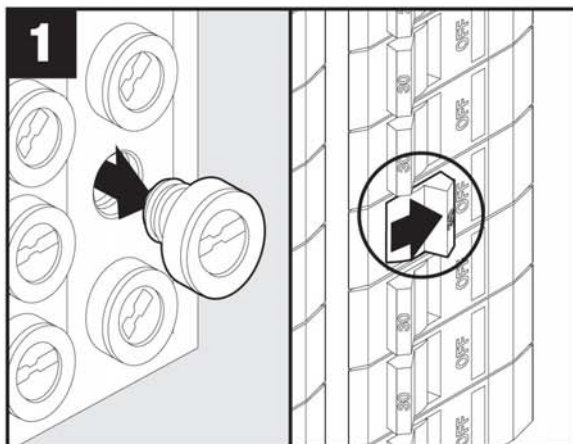

Turn off power source./Coupez l'alimentation./Apague el suministro eléctrico.

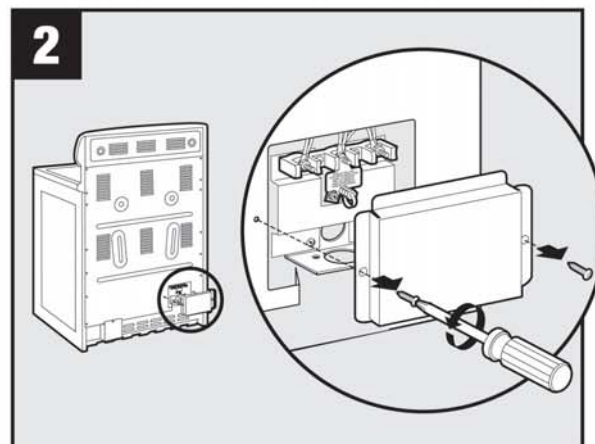

Remove terminal block access cover./Enlevez le couvercle d'accès de la plaque à bornes./Retire la tapa de acceso del tablero de terminales.

Installation Instructions

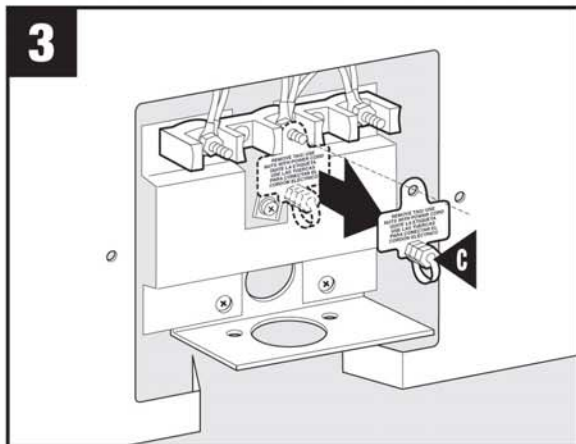

3
Remove hex nut holder./Enlevez la retenue de l'écrou hex./
Retire el soporte de la tuerca hexagonal.

If you have electrical connection:
Si vous avez un raccordement électrique :
Si ya tiene una conexión eléctrica:

- A** Go to / Passez à / Vaya a **A1**
- B** Go to / Passez à / Vaya a **B1**
- C** Go to / Passez à / Vaya a **C1**
- D** Go to / Passez à / Vaya a **D1**

Conduit users should refer to special option steps on last page./
Les utilisateurs de conduits devraient se reporter aux étapes pour les
options spéciales de la dernière page./
Si va a utilizar un conducto, consulte los pasos opcionales especiales
en la última página.

3-Wire Connection/Raccordement - 3 fils/Conexión trifilar

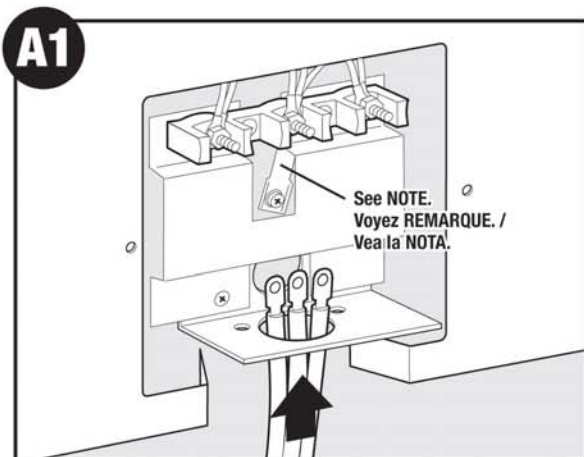

A1
Pull service cord through./Passez le cordon électrique ici./
Tire del cordón eléctrico.

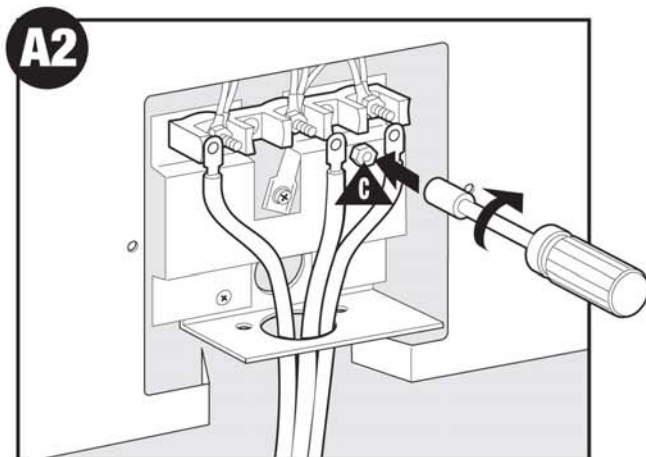

A2
Middle wire **MUST** connect to middle post./
Le fil du milieu **DOIT** être raccordé à la borne centrale./
El alambre central **DEBE** conectarse al conector central.

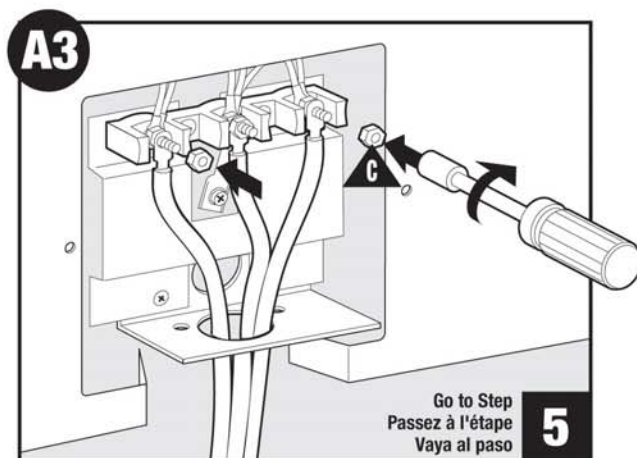

A3
Connect remaining wires./Raccordez les fils restants./Conecte los
alambres restantes.

NOTE: The copper ground strap **MUST** stay connected between middle
post and range./

REMARQU : La bande en cuivre de mise à la terre **DOIT** rester
branchée entre la borne centrale et la cuisinière./

NOTA: La cinta de cobre de puesta a tierra **DEBE** permanecer conectada
entre el conector central y la estufa.

Go to Step
Passez à l'étape
Vaya al paso **5**

Installation Instructions

4-Wire Connection/Raccordement - 4 fils/Conexión tetrafilar

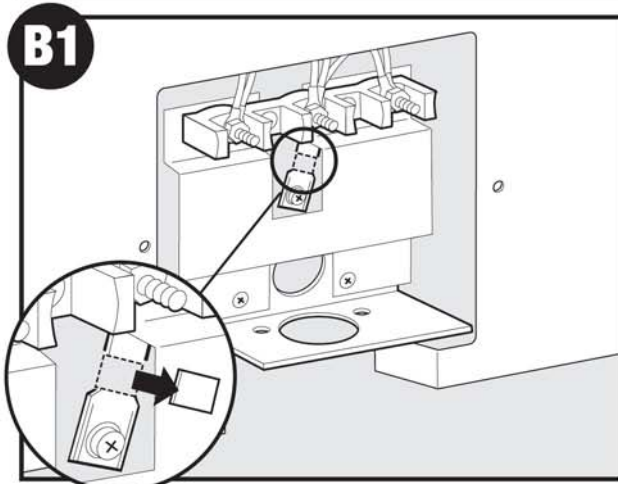

Part of copper ground strap **MUST** be cut out and removed./Une section de la bande en cuivre de mise à la terre **DOIT** être coupée et enlevée./ Una parte o la totalidad de la cinta de conexión a tierra **DEBE** ser cortada y descartada.

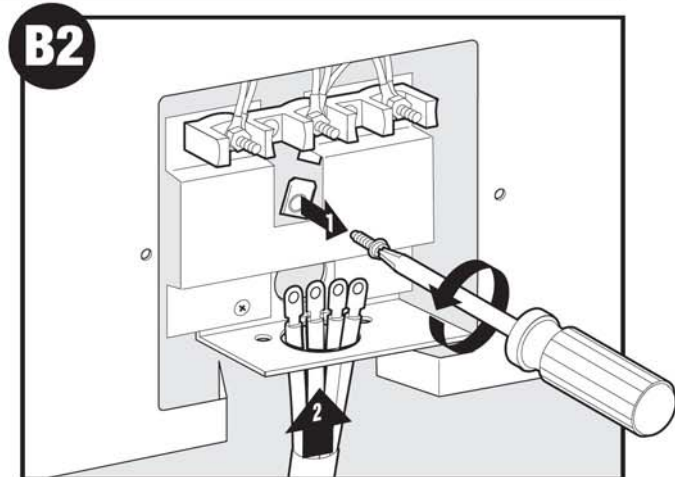

Remove grounding screw, pull service cord through./Retirez la vis de mise à la terre, et passez le cordon d'alimentation./Retire el tornillo de puesta a tierra y tire del cordón eléctrico de servicio a través del agujero.

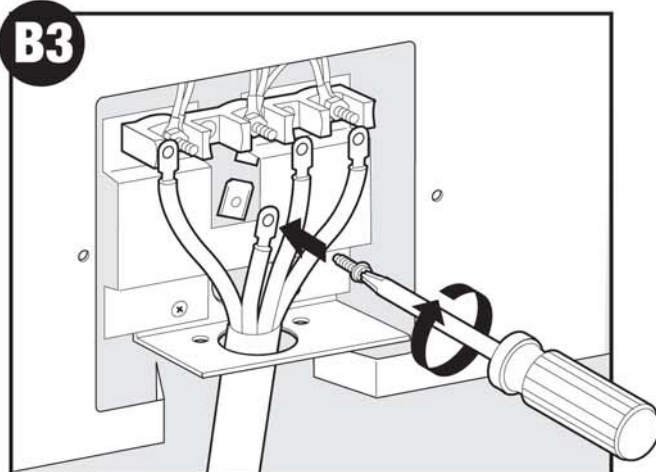

Connect ground wire./Raccordez le fil de mise à la terre./ Conecte el alambre de tierra.

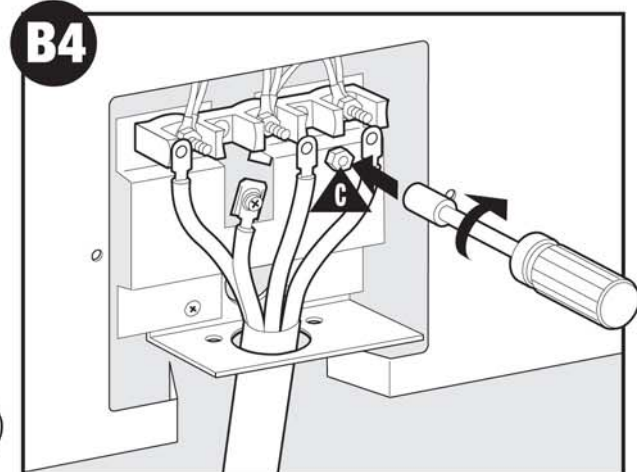

Connect white neutral wire to middle post./ Raccordez le fil blanc du neutre à la borne centrale./ Conecte el alambre blanco del neutro al conector central.

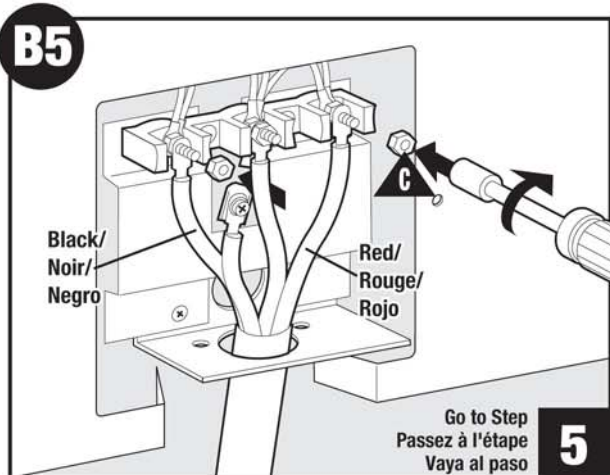

Connect remaining wires./Raccordez les fils restants./Conecte los alambres restantes.

NOTE: cord replacement - **Only** a power cord rated at 240 volts minimum. 40 amperes or 50 amperes power supply cord that is marked for use with nominal 1 3/8" (34.93mm) diameter connection opening, with closed loop terminals and marked for use with ranges shall be used.

REMARQUE : Remplacement du cordon - N'utilisez qu'un cordon d'alimentation pour 240 volts minimum, 40 ou 50 ampères, prévu pour être utilisé avec des cosses fermées - ouverture de 34,93 mm (1-3/8 po) de diamètre et pouvant être utilisé avec des cuisinières.

NOTA: reemplazo del cordón - Use sólo un cordón eléctrico clasificado para por lo menos 240 voltios. Sólo utilice cordones eléctricos de 40 o 50 amperios marcados para su uso en estufas con una abertura de conexión nominal de 1-3/8" (34,93 mm) de diámetro y para terminales de bucle cerrados.

Installation Instructions

Bare 3-Wire Connection/Raccordement - 3 fils dénudés/Conexión trifilar descubierta

Note: Conduit users should refer to special option steps on the last page./**REMARQUE :** Les utilisateurs de conduits devraient se reporter aux étapes pour les options spéciales de la dernière page./**NOTA:** Si va a utilizar un conducto, consulte los pasos opcionales especiales en la última página.

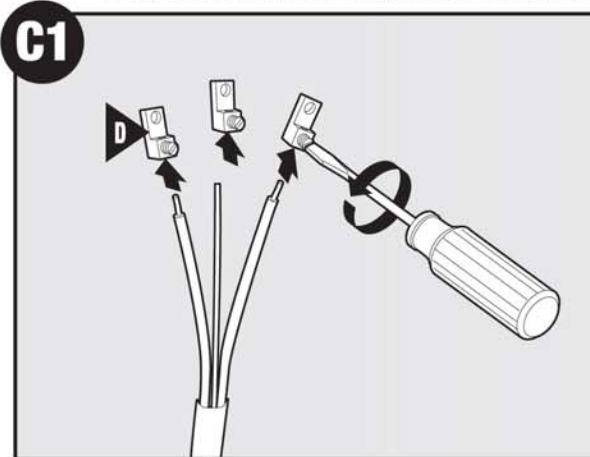

C1
Attach lugs. See Torque specifications below./Fixez les cosses à vis. Caractéristiques de couple ci-dessous./Fije las tuercas. Consulte las especificaciones del torque abajo.

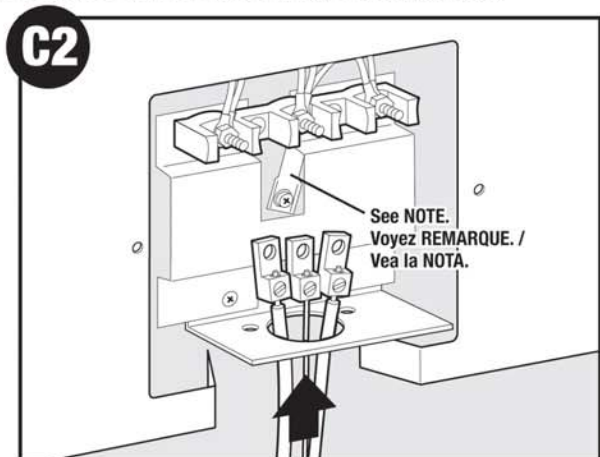

C2
Pull conduit through./Passez le conduit./Tire del conducto a través del agujero.

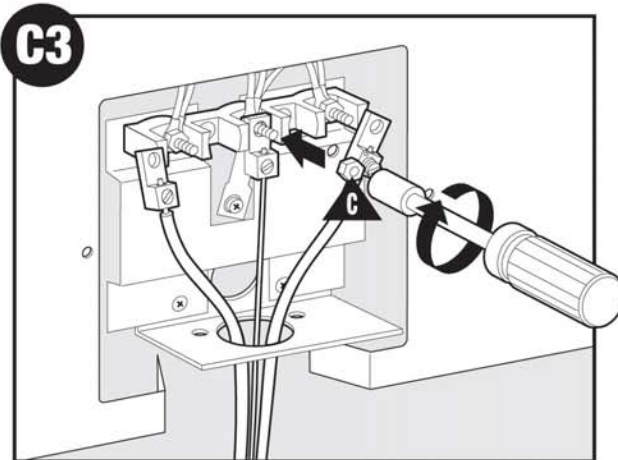

C3
Ground wire **MUST** connect to middle post. /Le fil de mise à la terre **DOIT** être connecté à la borne centrale./El alambre de tierra **DEBE** conectarse al conector central.

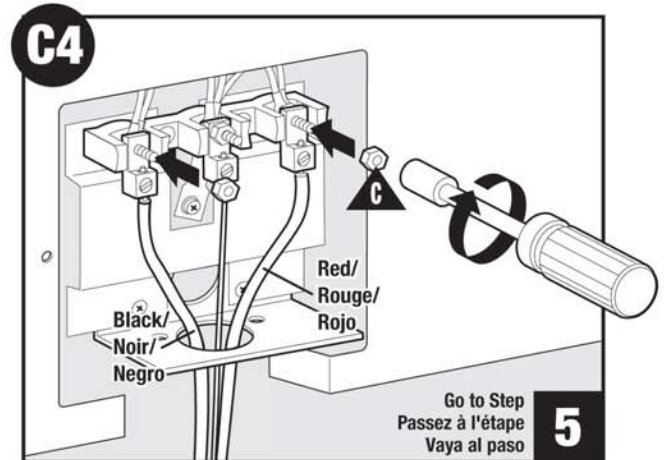

C4
Connect remaining wires./Raccordez les fils restants./Conecte los alambres restantes.

Bare Wire Torque Specifications

Lug attached to Terminal Block - 20 in-lb

Fils dénudés - caractéristiques de couple

Cosse fixée à la plaque à bornes - 20 lb-po

Especificaciones del torque para los alambres desforrados

Tuerca fijada al tablero de terminales - 20 pulg-lb

Wire AWG/Fil AWG/ Clasificación AWG del alambre	Torque/ Couple/Torque
10 - 14	20 in-lb/20 lb-po/20 pulg-lb
8	25 in-lb/25 lb-po/25 pulg-lb
4 - 6	35 in-lb/35 lb-po/35 pulg-lb

NOTE: The copper ground strap **MUST** stay connected between middle post and range./

REMARQUE : La bande en cuivre de mise à la terre **DOIT** rester branchée entre la borne centrale et la cuisinière./

NOTA: La cinta de cobre de puesta a tierra **DEBE** permanecer conectada entre el conector central y la estufa.

Installation Instructions

Bare 4-Wire Connection/Raccordement - 4 fils dénudés/Conexión tetrafililar descubierta

Note: Conduit users should refer to special option steps on the last page./**REMARQUE :** Les utilisateurs de conduits devraient se reporter aux étapes pour les options spéciales de la dernière page./**NOTA:** Si va a utilizar un conducto, consulte los pasos opcionales especiales en la última página.

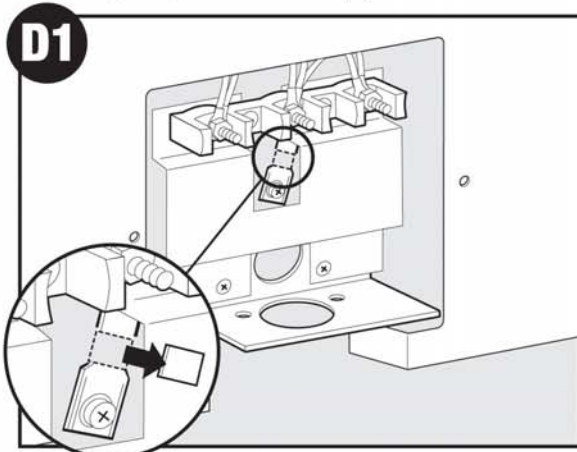

Part of copper ground strap **MUST** be cut out and removed./Une partie de la bande en cuivre de mise à la terre **DOIT** être coupée et enlevée./Una parte o la totalidad de la cinta de conexión a tierra **DEBE** ser cortada y descartada.

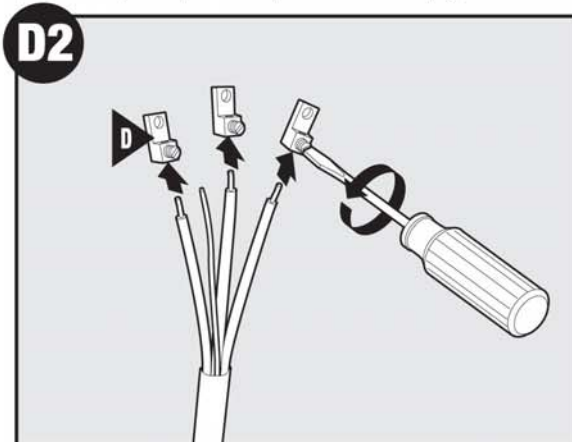

Attach lugs. See Torque specifications at right./Fixez les tenons. Consultez les spécifications de couple de serrage qui se trouvent à gauche./Fije las tuercas. Coloque las tuercas. Vea las especificaciones de torque a la izquierda.

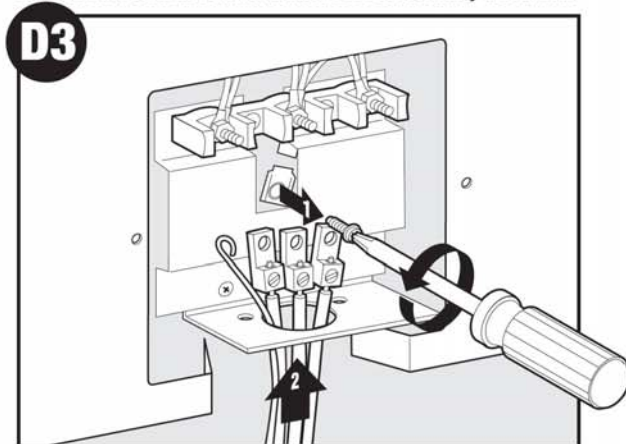

Remove grounding screw, pull conduit through./Retirez la vis de mise à la terre, passez le conduit./Retire el tornillo de puesta a tierra y tire del conducto a través del agujero.

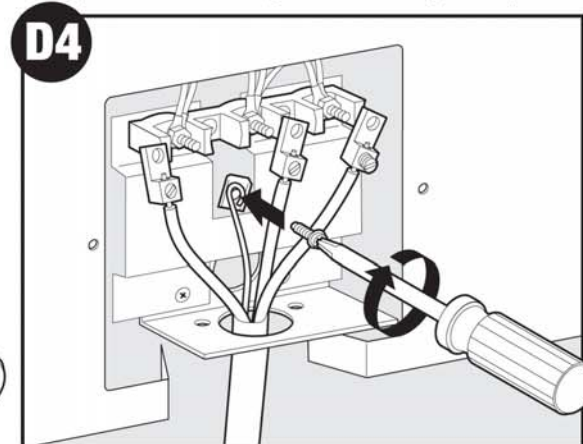

Connect ground wire./Raccordez le fil de mise à la terre./Conecte el alambre de tierra.

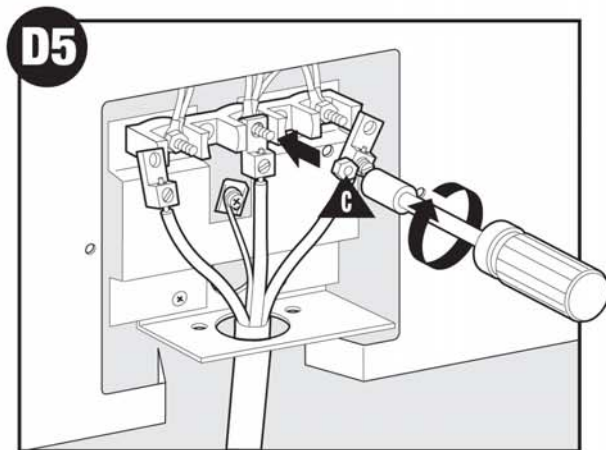

Connect white neutral wire to middle post./Raccordez le fil blanc du neutre à la borne centrale./Conecte el alambre blanco del neutro al conector central.

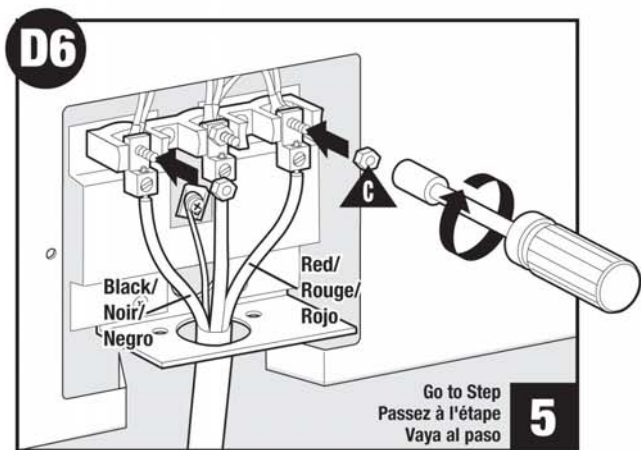

Connect remaining wires./Raccordez les fils restants./Conecte los alambres restantes.

Installation Instructions

Install Strain Relief for 3 or 4-Wire Connection/Installez le dispositif anti-étrirage pour le raccordement de 3 ou 4 fils/Instale el liberador de tensión para la conexión trifilar o tetrafilar

Note: Strain relief for service cord or conduit **MUST** be attached to the conduit plate./Remarque : Le dispositif anti-étrirage pour le cordon d'alimentation ou le conduit **DOIT** être fixé à la plaque du conduit./Nota: El liberador de tensión para el cordón de servicio o para el conducto **DEBE** estar fijado a la placa del conducto.

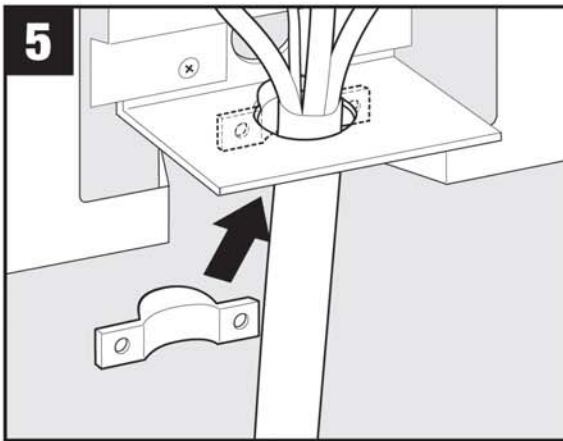

Position rear strain relief./Placez la bride arrière du dispositif anti-étrirage. Coloque el liberador de tensión trasero en su lugar.

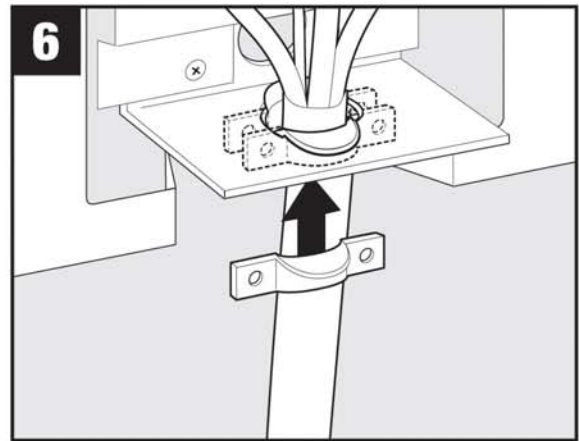

Position front strain relief./Placez la bride avant du dispositif anti-étrirage. Coloque el liberador de tensión delantero en su lugar.

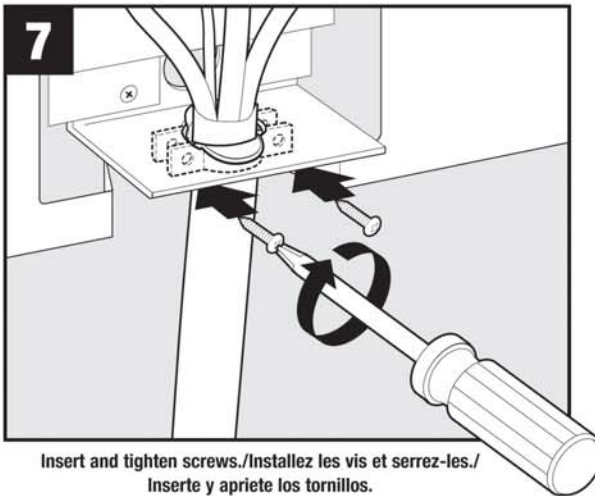

Insert and tighten screws./Installez les vis et serrez-les./
Inserte y apriete los tornillos.

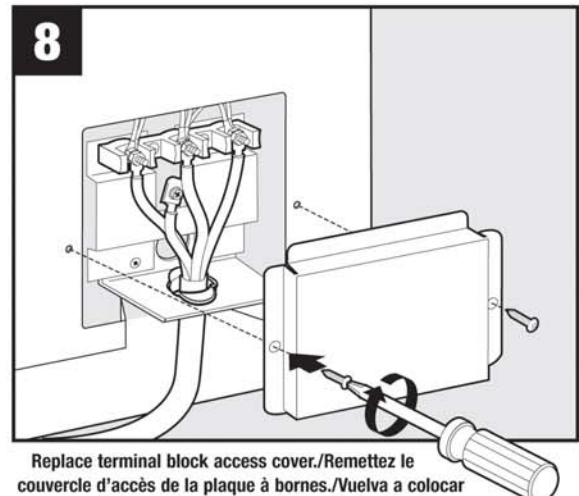

Replace terminal block access cover./Remettez le couvercle d'accès de la plaque à bornes./Vuelva a colocar la tapa de acceso del tablero de terminales.

Anti-tip installation/Installation de la bride antibasquelement/Instalación antivuelco

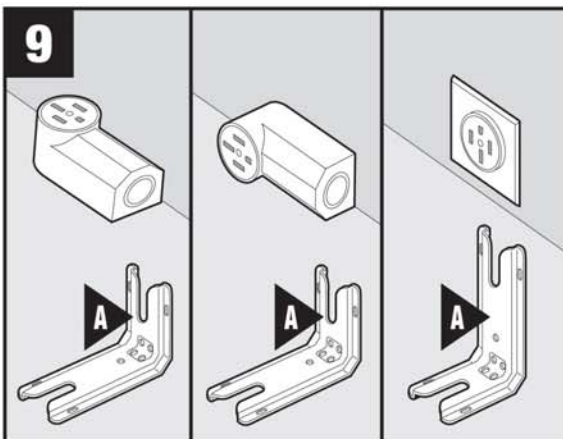

Locate power outlet and position bracket. Go to 9a for wood or 9b for concrete./Repérez la prise d'alimentation et positionnez la bride. Passez à 9a pour le bois ou à 9b pour le béton./Ubique el tomacorriente y coloque el soporte en posición. Vaya al paso 9a para instalación en madera y al paso 9b para instalación en concreto.

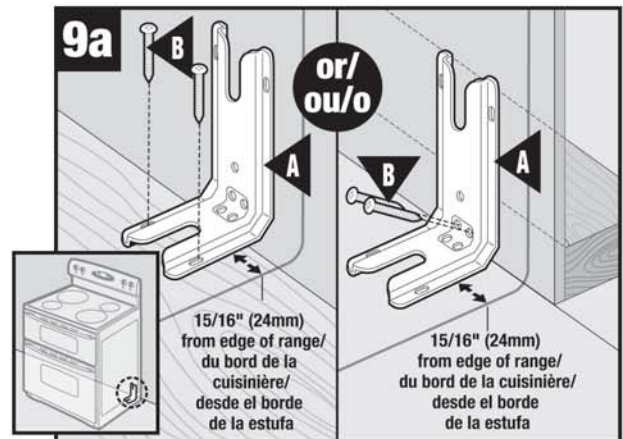

Drill 1/8" (3mm) holes. Mount bracket to wall or floor with 2 screws./Percez des trous de 1/8 po (3 mm). Installez le support ANTIREVERSEMENT au mur ou au sol avec deux vis./Taladre agujeros de 1/8" (3 mm). Instale el soporte ANTIVUELCO en la pared o en el piso usando 2 tornillos.

Installation Instructions

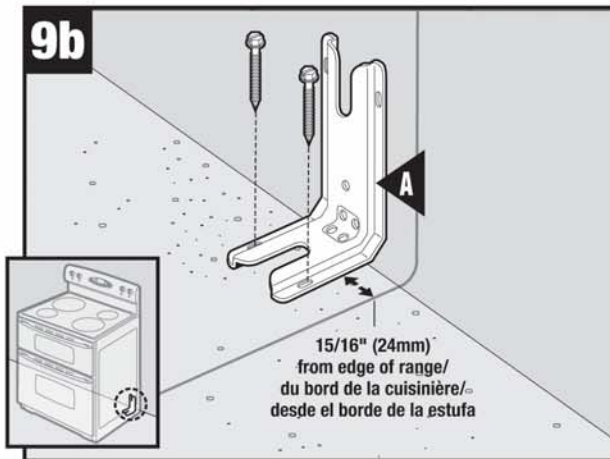

Drill holes as required. Mount bracket to floor with 2 concrete screws (not provided)./Percez des trous selon le besoin. Installez le support ANTIRENVERSEMENT au sol avec deux vis à béton (non fournies)./ Taladre los agujeros que necesite. Instale el soporte ANTIVUELCO en el piso usando 2 tornillos para concreto (no proporcionados).

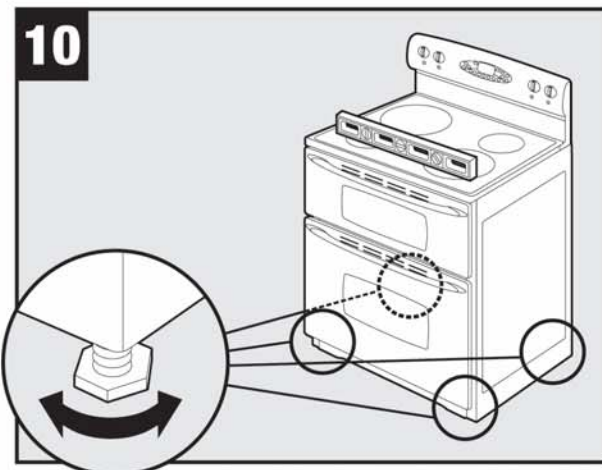

Adjust legs./Ajustez les pieds./Ajuste los tornillos niveladores.

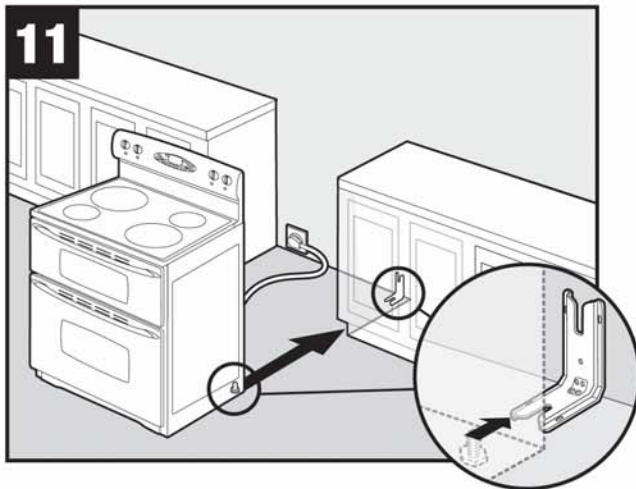

Slide range into position./Repoussez la cuisinière en place./Deslice la estufa a su lugar definitivo.



Check leg position in bracket./Vérifiez que le pied est bien sous la bride./Verifique la posición del tornillo en el soporte.

Final installation/Installation finale/Instalación definitiva

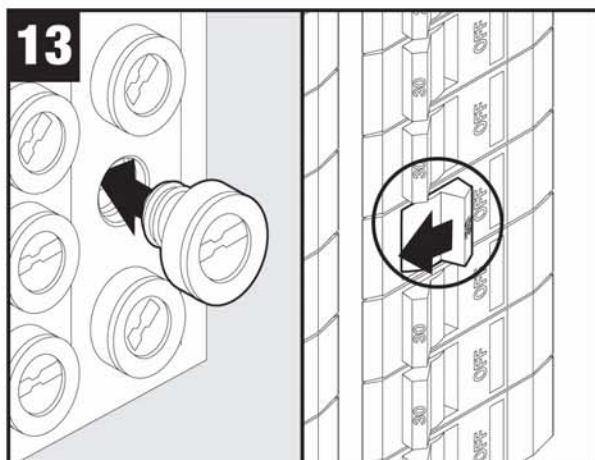

Turn on power source./Ouvrez le courant./Encienda el suministro eléctrico.

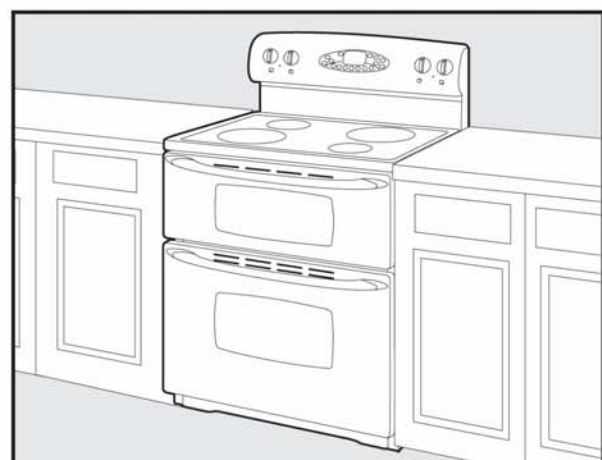

Complete./Terminez./Completo.

Installation Instructions

IMPORTANT: Keep for Local Electrical Inspector/IMPORTANT: À conserver pour l'inspecteur local/IMPORTANTE: Guarde esta información para el inspector local.

30 inches (76.2 cm) minimum clearance required between the top of the cooking surface and the bottom of an unprotected wood or metal cabinet, or 24 inches (61 cm) minimum when bottom of wood or metal cabinet is protected by not less than 1/4-inch (6.4 mm) thick flame retardant millboard covered with not less than No. 28 MSG sheet steel, 0.015-inch (1.381 mm) thick stainless steel, 0.024-inch (0.610 mm) thick aluminum, or 0.020-inch (0.508 mm) thick copper.

To eliminate the risk of burns or fire by reaching over heated surface units, cabinet storage space located above the surface units should be avoided. If cabinet storage is to be provided, the risk can be reduced by installing a range hood that projects horizontally a minimum of 5 inches (13cm) beyond the bottom of the cabinets.

A free-standing range may be installed adjacent to (0" from) side and rear combustible walls.

NOTE: FOR INSTALLATION IN CANADA, A FREE STANDING RANGE IS NOT TO BE INSTALLED CLOSER THAN 12MM FROM ANY ADJACENT SURFACE.

Un dégagement minimum de 76,2 cm (30 pouces) est exigé entre le dessus de la surface de cuisson et le dessous d'une armoire en métal ou en bois non protégée, ou de 61 cm (24 pouces) minimum lorsque le dessous de l'armoire en métal ou en bois est protégé par une plaque de carton ignifuge d'une épaisseur d'au moins 6,4 mm (1/4 po) et recouverte au moins d'une feuille d'acier MSG n° 28, d'une feuille d'acier inoxydable de 1,381 mm (0,015 po), d'une plaque d'aluminium de 0,610 mm (0,024 po), ou d'une feuille de cuivre de 0,508 mm (0,020 po).

Pour éliminer le risque de brûlure ou d'incendie, en passant la main au-dessus des éléments de surface chauffés, l'espace de rangement dans les armoires situées au-dessus des éléments de surface doit être évité. Si une armoire de rangement existe, le risque peut être réduit en installant une hotte d'extraction qui dépasse horizontalement d'un minimum de 13 cm (5 po) de la partie inférieure des armoires.

Une cuisinière autonome peut être installée à côté (dégagement 0 cm/0 po) de parois combustibles sur les côtés et l'arrière.

REMARQUE : POUR L'INSTALLATION AU CANADA, UNE CUISINIÈRE AUTONOME NE DOIT PAS ÊTRE INSTALLÉE À MOINS DE 12 mm DE TOUTE SURFACE ADJACENTE.

Se requiere un espacio de despeje de por lo menos 30 pulgadas (76,2 cm) entre la parte superior de la superficie de cocción y la parte inferior de un armario de madera o metal desprotegido, o por lo menos 24 pulgadas (61 cm) cuando la parte inferior del armario de madera o metal está protegida por un cartón grueso retardante de las llamas de por lo menos 1/4 de pulgada (6,4 mm) recubierto de una placa de acero MSG no menor de No. 28, una placa de acero inoxidable grueso de no menos de 0,015 pulgadas (1,381 mm), una placa de aluminio grueso de no menos de 0,024 pulgadas (0,610 mm), o una placa de cobre grueso de no menos de 0,020 pulgadas (0,508 mm).

Para eliminar el riesgo de quemaduras o de incendios cuando se intenta alcanzar algún objeto sobre los elementos superiores, evite almacenar artículos en los armarios que están sobre la estufa. Si se instala un armario sobre la cubierta, se puede reducir el riesgo instalando una campana de ventilación que se proyecte horizontalmente en un mínimo de 5 pulgadas (13 cm) más allá de la base de los armarios.

Una estufa independiente también puede ser instalada adyacente (a 0" de distancia) a paredes laterales o traseras combustibles.

NOTA: PARA SU INSTALACIÓN EN CANADÁ, LA ESTUFA INDEPENDIENTE NO DEBE SER INSTALADA A MENOS DE 12 MM DE CUALQUIER SUPERFICIE ADYACENTE.

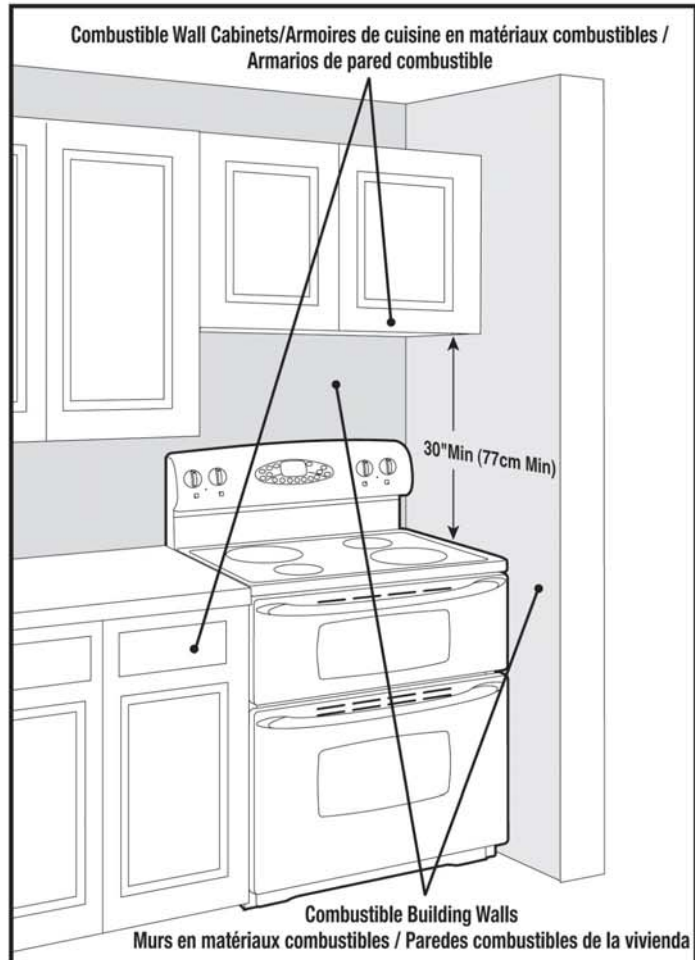

**NOTE: Figure may not be representative of actual unit./
REMARQUE : L'illustration peut ne pas présenter l'appareil actuel./
NOTA: La figura puede no ser exacta a la unidad.**

Appendix B

Surface Cooking

Surface Controls

Use to turn on the surface elements. An infinite choice of heat settings is available from **Low** to **High**. The knobs can be set on or between any of the settings.

Setting the Controls

1. Place pan on surface element.
2. Push in and turn the knob in either direction to the desired heat setting.
 - The control panel is marked to identify which element the knob controls. For example, the graphic at right indicates left front element.
3. There is an element **“ON” indicator light** on the control panel. When any surface control knob is turned on, the light will turn on. The light will turn off when all the surface elements are turned off.
4. After cooking, turn knob to **OFF**. Remove pan.



Suggested Heat Settings

The size, type of cookware and cooking operation will affect the heat setting. For information on cookware and other factors affecting heat settings, refer to “Cooking Made Simple” booklet.

Low (2): Use to keep foods warm and melt chocolate and butter.

High (10): Use to bring liquid to a boil. Always reduce setting to a lower heat when liquids begin to boil or foods begin to cook.

Med. Low (3-4): Use to continue cooking covered foods or steam foods.

Medium (5-7): Use to maintain slow boil for large amounts of liquids and for most frying operations.

Med. High (8-9): Use to brown meat, heat oil for deep fat frying or sauteing. Maintain fast boil for large amounts of liquids.

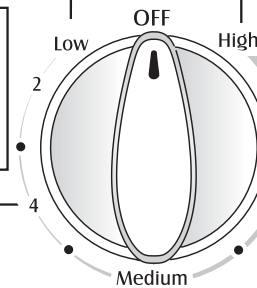

CAUTION

BEFORE COOKING

- Always place a pan on the surface unit before you turn it on. To prevent damage to range, never operate surface unit without a pan in place.
- **NEVER** use the cooktop as a storage area for food or cookware.

DURING COOKING

- Be sure you know which knob controls which surface unit. Make sure you turned on the correct surface unit.
- Begin cooking on a higher heat setting then reduce to a lower setting to complete the operation. Never use a high heat setting for extended cooking.
- **NEVER** allow a pan to boil dry. This could damage the pan and the appliance.
- **NEVER** touch cooktop until it has cooled. Expect some parts of the cooktop, especially around the surface units, to become warm or hot during cooking. Use potholders to protect hands.

AFTER COOKING

- Make sure surface unit is turned off.
- Clean up messy spills as soon as possible.

OTHER TIPS

- If cabinet storage is provided directly above cooking surface, limit it to items that are infrequently used and can be safely stored in an area subjected to heat. Temperatures may be unsafe for items such as volatile liquids, cleaners or aerosol sprays.
- **NEVER** leave any items, especially plastic items, on the cooktop. The hot air from the vent may ignite flammable items, melt or soften plastics, or increase pressure in closed containers causing them to burst.
- **NEVER** allow aluminum foil, meat probes or any other metal object, other than a pan on a surface element, to contact heating elements.

Surface Cooking

Coil Element Surface

Notes:

- Clean cooktop after each use.
- Wipe acidic or sugary spills as soon as the cooktop has cooled as these spills may discolor or etch the porcelain.
- To protect drip bowl finish:**
 - To lessen discoloration and crazing, avoid using high heat for long periods.
 - Do not use oversized cookware. Pans should not extend more than 1-2 inches beyond the element.
 - When home canning or cooking with big pots, use the Canning Element (Model CE1). Contact your Maytag dealer for details or call 1-877-232-6771 USA or 1-800-688-8408 Canada to order.
 - Clean frequently. (See page 17.)

Lift-up Porcelain Cooktop

To lift: When cool, grasp the cooktop front edge. Gently lift up until the two support rods snap into place.

To lower: Hold the cooktop front edge and carefully push back on each support rod to release. Then lower the top into place.

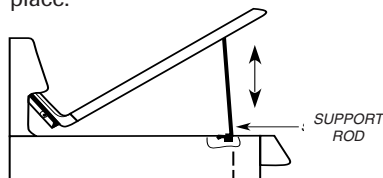

Coil Elements

- When an element is on, it will cycle on and off to maintain the heat setting.
- Coil elements are self-cleaning. Do not immerse in water.

To remove: When cool, raise element. Carefully pull out and away from receptacle.

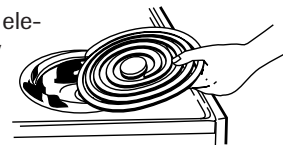

To replace: Insert element terminals into receptacle. Guide the element into place. Press down on the outer edge of element until it sits level on drip bowl.



Drip Bowls

The drip bowls under each surface element catch boilovers and must always be used. Absence of drip bowls during cooking may damage wiring.

To prevent the risk of electric shock or fire, never line drip bowls with aluminum foil.

Drip bowls will discolor (blue/gold stains) or craze over time if overheated. This discoloration or crazing is permanent. This will not affect cooking performance.

Oven Cooking

Control Panel

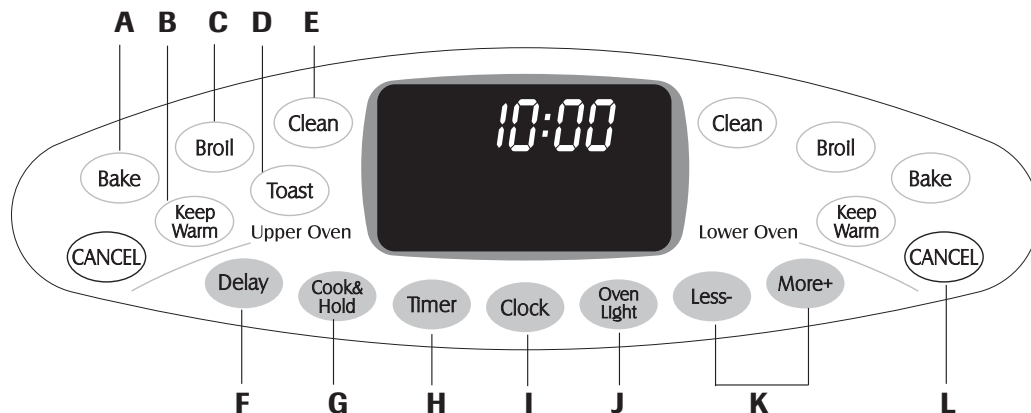

The control panel is designed for ease in programming. The display window on the control shows time of day, timer and oven functions. Control panel shown includes model specific features. (Styling may vary depending on model.)

A	Bake	Use for baking and roasting.
B	Keep Warm	Use to keep cooked food warm in oven.
C	Broil	Use for broiling and top browning.
D	Toast	Use for toasting bread and products toasted in toaster or toaster oven.
E	Clean	Use to set self-clean cycle.
F	Delay	Programs the oven to start baking or cleaning at a later time.
G	Cook & Hold	Bakes for a preset time, then keeps food warm for 1 hour.
H	Timer	Sets timer.
I	Clock	Use to set time-of-day clock.
J	Oven Light	Use to turn the oven lights on or off.
K	Less-/More+	Enters or changes time, oven temperature. Sets HI or LO broil.
L	CANCEL	Cancels all operations except timer and clock.

Clock

The clock can be set to display time in a 12-hour or 24-hour format. The clock is set at the factory for the 12-hour format.

To change the clock to 24-hour format:

1. Press and hold the Upper Oven CANCEL and Delay pads for several seconds.
2. Press the More+ or Less - pad to select 12 or 24 hour.
3. Set the time of day following the directions below.

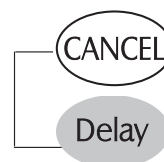

To set the Clock:

1. Press the Clock pad.
 - The colon (:) flashes in the display.
2. Press More+ or Less- pad to set the time of day.
 - Colon continues flashing.
3. Press the Clock pad again or wait four seconds.
 - The colon stops flashing.



When electrical power is supplied or after a power interruption, the last clock time before power was interrupted will flash.

To recall the time of day when another time function is showing, press the Clock pad.

Clock time cannot be changed when the oven has been programmed for Bake, Clean, Delay or Cook & Hold.

To cancel the Clock display:

If you do not want the time of day to display:

Press and hold the Upper Oven CANCEL and Clock pads for several seconds. The time of day will disappear from the display.

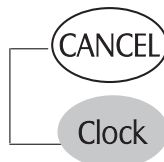

Using the Touchpads

- Press the desired pad.
- Press More+ or Less- pad to enter time or temperature.
- A beep will sound when any pad is touched.
- A double beep will sound if a programming error occurs.

Note: Four seconds after pressing the More+ or Less- pad, the time or temperature will automatically be entered. If more than 30 seconds elapse between touching a function pad and the More+ or Less- pad, the function will be canceled and the display will return to the previous display.



Oven Cooking

When the clock display is canceled, press the Clock pad to briefly display the time of day.

To restore the Clock display:

Press and hold the Upper Oven CANCEL and Clock pads for several seconds. The time of day will reappear in the display.

Timer

The timer can be set from one minute (1:00) up to 11 hours and 59 minutes (11:59).

The timer can be used independently of any other oven activity. It can also be set while another oven function is operating.

The timer does not control the oven.

To set the Timer:

1. Press the Timer pad.
 - "0:00" lights in the display.
 - "Timer" will flash.
2. Press the More+ or Less- pad until the correct time appears in the display.
 - "Timer" will continue to flash.
3. Press Timer pad again or wait four seconds.
 - The time begins counting down.
 - The last minute of the timer countdown will be displayed as seconds.
4. At the end of the set time, three long beeps will sound.

Timer

Less-

More+

To cancel the Timer:

1. Press and hold the Timer pad for three seconds.
OR
2. Press the Timer pad and set the time to 0:00.

Locking the Control and Oven Doors

The touchpads and oven doors can be locked for safety, cleaning, or to prevent unwanted use. They will not function when locked.

If the oven is currently in use, the touchpads and doors cannot be locked.

The current time of day will remain in the display when the controls are locked.

To lock both doors:

Press and hold the Upper Oven CANCEL and Cook & Hold pads for three seconds.

- "Lock" flashes in the display while both oven doors lock. Once complete, "Lock" stops flashing.

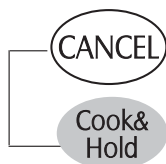

- "OFF" is displayed for 10 seconds whenever a pad is touched.

To unlock both doors:

Press and hold the Upper Oven CANCEL and Cook & Hold pads for three seconds.

- "Lock" flashes and then disappears from the display.
- "OFF" appears in the display for several seconds while the doors are unlocking.

Note: The touchpads and oven doors cannot be locked if the oven temperature is 400° F or above.

Fault Codes

"Bake" or "Lock" may flash rapidly in the display to alert you if there is an error or a problem. If "Bake" or "Lock" flash in the display, press CANCEL pad. If "Bake" or "Lock" continue to flash, disconnect power to the appliance. Wait a few minutes, and then reconnect power. If the flashing still continues, disconnect power to the appliance and call an authorized servicer.

Adjusting the Sound Level

The factory default setting for sound is medium (MEd), but it can be changed to low (LO) or high (HI). To change the setting:

1. Press and hold More+ and upper oven CANCEL pads for three seconds. A beep will sound and the current sound level ("LO", "MEd" or "HI") will appear in the display.
2. Press More+ pad to increase sound level or the Less- pad to decrease sound level.
3. Wait four seconds and the new setting will be accepted.
4. If the More+ or Less- pad is not pressed within 30 seconds, the control will return to the existing settings.

Changing Temp °F/°C

The factory default setting for temperature is Fahrenheit. To change the setting:

1. Press and hold the upper oven Bake and CANCEL pads for three seconds. A beep will sound and the current setting (°F or °C) will appear in the display.
2. Press the More+ or Less- pad to change the setting between °F and °C.
3. Wait four seconds and the new setting will be accepted.
4. If the More+ or Less- pad is not pressed within 30 seconds, the control will return to the existing settings.



Oven Cooking



Return To Factory Default Settings

The control can be reset to the factory default settings. To return to the default settings:

1. Press and hold upper oven Keep Warm and CANCEL pads for three seconds. A single beep will sound and “dEF” (default) will appear in the display.
2. Press the More+ pad to choose the factory settings. “cLr” (clear) will appear in the display.
3. Wait four seconds and the factory settings will be accepted.
4. If the More+ or Less- pad is not pressed within 30 seconds, the control will return to the existing settings.

Setting Upper and Lower Oven Functions

Baking To set bake:

1. Press the Bake pad for desired oven. 
 - “Bake” will flash.
 - “000°” will flash in the display.
2. Select the oven temperature. The oven temperature can be set from 170° to 550°. Press or press and hold the More+ or Less- pad. 
 - “350°” will light when either pad is first pressed.
 - Press the More+ pad to increase the temperature.
 - Press the Less- pad to decrease the temperature.
3. Press Bake pad again or wait four seconds.
 - “Bake” will stop flashing and light in the display.
 - “Preheat” will light in the display.
 - 100° or the actual oven temperature will display. The temperature will rise in 5° increments until the preset temperature is reached.
4. Allow 4-10 minutes for upper oven to preheat and 7-12 minutes for lower oven to preheat.
 - When the set oven temperature is reached, one long beep will sound.
 - To recall the set temperature during preheat, press the Bake pad.

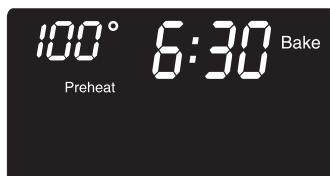

To change the oven temperature during preheat, press Bake once and reset temperature.

5. Place food in the oven.
6. Check cooking progress at minimum cooking time. Cook longer if needed.
7. When cooking is finished, press CANCEL pad. 
8. Remove food from the oven.

Baking Differences Between Your Old and New Oven

It is normal to notice some baking time differences between a new oven and an old one. See “Adjusting the Oven Temperature” on page 12.

Baking Notes:

- If the lower oven is NOT in use, the upper oven will preheat more quickly.
- **Allow at least 1/2-inch between the baking pan or casserole and the top element in the upper oven.** Loaf, angel food or bundt pans are not recommended in the upper oven.
- Do not use temperatures below 140° F to keep food warm or below 200° F for cooking. For food safety reasons, lower temperatures are not recommended.
- The back part of the lower oven bake element will NOT glow red during baking. This is normal.
- When baking frozen, self-rise pizzas in the upper oven, place the pizza on a cookie sheet to avoid overbrowning.
- When preheating with a baking/pizza stone inside the upper oven, do not set above 400° F. To use baking/pizza stones at temperatures above 400° F in the upper oven, put stone in after preheat beep.
- To change the oven temperature during cooking, press the Bake pad and then the More+ or Less- pad until you reach the desired temperature.
- If you forget to turn off the oven, it will automatically turn off at the end of 12 hours. If you wish to deactivate the Automatic Shut-Off/Sabbath Mode feature, see page 12.
- For additional baking and roasting tips, see “Cooking Made Simple” booklet.

Cook & Hold

Cook & Hold allows you to bake for a preset amount of time, followed by a one-hour Keep Warm cycle.

To set Cook & Hold:

1. Press the Cook & Hold pad **once** for upper oven or **twice** for lower oven. 
 - “Bake” and “Hold” flash.
 - “000°” will flash in the display.

cont.



Oven Cooking

- Select the oven temperature. The oven temperature can be set from 170° to 550°. Press or press and hold the More+ or Less- pad.
 - Press the More+ pad to increase the temperature.
 - Press the Less- pad to decrease the temperature.
- Press Cook & Hold pad again OR wait four seconds to set cook time.
 - "Time" flashes.
 - "0:00" flashes in the display
- Enter the amount of time you want to cook by pressing the More+ or Less- pad. Time can be set from 10 minutes (10:00) to 11 hours, 59 minutes (11:59).
 - "Bake", "Preheat" and "Hold" light in the display.
 - The cooking time will start counting down.
 - "100°" or actual oven temperature will light in the display.

Less-

More+

Cook & Hold



When the cooking time has elapsed:

- Three beeps will sound.
- "Bake" will turn off.
- "Hold" will light.

After one hour in HOLD WARM:

- The oven will turn off. Three beeps will sound.

To cancel Cook & Hold at any time:

Press the CANCEL pad. Remove food from oven.

CANCEL

Delay Cook & Hold



Do not use delayed baking for highly perishable foods such as dairy products, pork, poultry, or seafood.

When using **Delay**, the oven begins to cook later in the day. Set the amount of time that you want to delay before the oven turns on and how long you want to cook. The oven begins to heat at the selected time and cooks for the specified length of time, then keeps food warm for one hour.

Delay time can be set from 10 minutes (10:00) to 11 hours, 59 minutes (11:59).

To set a Delayed Baking cycle:

- Press the Delay pad **once** for upper oven or **twice** for lower oven.
 - "dLY" and "0:00" flash in the display.
- Press the More+ or Less- pad **to set the amount of time you want to delay** the Cook & Hold cycle.

Delay

Less-

More+

Cook & Hold

While "dLY" is still flashing:

- Press the Cook & Hold pad.
 - "000°" flashes in the display.
 - "Bake" and "Hold" flash.
- Press More+ or Less- pad to enter the oven temperature.
 - "Bake" flashes.
 - After several seconds, "0:00" and "Time" flash.
 - "Bake" and "Hold" remain steady.
- Press More+ or Less- pad to set the baking time.
 - "Time" flashes.
 - After several seconds, the delay time will count down.
 - "dLY", "Bake" and "Hold" light in the display.

When the Delay time has expired:

- "dLY" will turn off.
- Baking time and temperature are displayed.
- "Bake" and "Hold" are displayed.

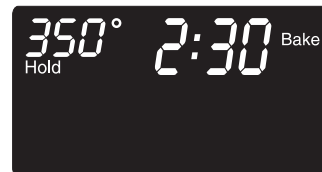

When the oven starts:

- The baking time will count down.
- "dLY" will turn off.
- "Bake" and "Hold" will remain lit.

To cancel:

Press the CANCEL pad.

CANCEL

- All timed and untimed cooking functions will be canceled.
- The time of day will reappear in the display.

Notes:

- Do not use delayed baking for items that require a preheated oven, such as cakes, cookies, and breads.
- Do not use delayed baking if oven is already hot.



Oven Cooking

Keep Warm

For safely keeping foods warm or for warming breads and plates.

To set Keep Warm:

- Press the Keep Warm pad for the appropriate oven.
 - “Warm” flashes.
 - “000°” flashes in the display.
- Select the Keep Warm temperature. The Keep Warm temperature can be set from 145° to 190°. Press or press and hold the More+ or Less- pad.
 - 170° will light when either pad is first pressed.
 - Press the More+ pad to increase the temperature.
 - Press the Less- pad to decrease the temperature.

“Warm” and the temperature will be displayed while Keep Warm is active.



To cancel Keep Warm:

- Press the CANCEL pad.
- Remove food from the oven.



Keep Warm Notes:

- For optimal food quality, oven cooked foods should be kept warm for no longer than 1 to 2 hours.
- To keep foods from drying, cover loosely with foil or a lid.
- **To warm dinner rolls:**
 - cover rolls loosely with foil and place in oven.
 - press Keep Warm and More+ pads to set 170° F.
 - warm for 12-15 minutes.
- **To warm plates:**
 - place 2 stacks of up to four plates each in the oven.
 - press Keep Warm and More+ pads to set 170° F.
 - warm for five minutes, turn off the oven and leave plates in the oven for 15 minutes more.
 - use only oven-safe plates, check with the manufacturer.
 - do not set warm dishes on a cold surface as rapid temperature changes could cause crazing or breakage.

Toasting (upper oven only)

For toasting bread and products that are toasted in a toaster or toaster oven. Toast time can be set from 10 seconds up to six minutes.

- Press the Toast pad.
- Select the toasting time. Press the More+ pad to increase the time or press the Less- pad to decrease the time.

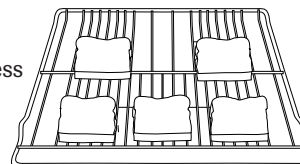

- “Toast” and the toasting time will be displayed. The toasting time will begin to count down.

Browning time may vary, watch toasting carefully to avoid over-browning. Close oven door during toasting.

- At the end of the set toasting time, the oven will beep.

Toasting Notes:

- **Lower oven may not be operated while upper oven is toasting. If the lower oven is operating when the Toast pad is pressed, a beep will sound.**
- Toasting is based on time not temperature.
- For more even browning results, preheat the oven 3-4 minutes.
- Toasting times will be shorter when the oven is hot or when repeated toasting functions are done.
- For optimal results when toasting 4-5 pieces of bread or other similar items, follow illustration above.

Toasting Chart

FOOD	TOAST TIME*/COLD START
Sliced White Bread	3½ - 4½ min.
Waffles (frozen)	4 - 4½ min.
Toaster Pastry (unfrozen)	3½ - 4 min.
Toaster Pastry (frozen)	4½ - 4¾ min
Tortillas (flour)	2½ - 3 min.
Toaster Breaks** or Hot Pockets**	4 - 5 min.
Bagels	4½ - 5 min.
English Muffins	3½ - 4 min.
Cheese Sandwich	3½ - 4½ min

* Toasting times are approximate and should be used as a guide only.

** Brand names are registered trademarks of the respective manufacturers.



Oven Cooking

Broiling

To set Broil:

- Press the Broil pad for desired oven.
 - "Broil" and "SET" flash in the display.
- Press the More+ or Less- pad once to set HI broil. Press the More+ or Less- pad twice to set LO broil.
 - HI or LO will be displayed.
 - Select HI broil (550° F) for normal broiling. Select LO broil (450° F) for low-temperature broiling of longer cooking foods such as poultry.
- After four seconds, the oven will start.
 - "Broil" and HI or LO will remain lit.

Broil

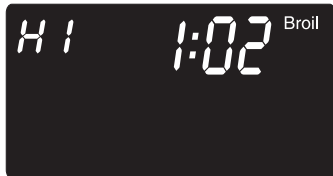

- For optimum browning, preheat broil element for 3-4 minutes before adding food.
- Place food in the oven. Leave oven door open about four inches (the first stop).
- Most meat should be turned once about halfway through cooking.

- When food is cooked, press the CANCEL pad. Remove food and broiler pan from the oven.
 - The time of day will reappear in the display.

CANCEL

Broil Notes:

- For best results when broiling, use a two-piece broiler pan.
- HI broil is used for most broiling. Use LO broil when broiling longer cooking foods to allow them to cook to well done stage without excessive browning.
- Broil times may be longer when the LO broil temperature is selected.
- Never cover broiler pan insert with aluminum foil. This prevents fat from draining to the pan below.
- Expect broil times to increase and browning to be slightly lighter if appliance is installed on a 208-volt circuit.
- If more than 30 seconds elapse between pressing the Broil pad and the More+ or Less- pad, the oven will not be set and the display will return to the previous display.
- Most foods should be turned halfway through broiling time.
- For additional broiling tips and temperatures, refer to the "Cooking Made Simple" booklet.

Broiling Chart - Broil times are based on a 4 minute preheat.

FOODS	UPPER OVEN RACK POSITION*	LOWER OVEN RACK POSITION*	SETTING	UPPER OVEN COOK TIME (MINUTES)**	LOWER OVEN COOK TIME (MINUTES)**
Beef Steak, 1" thick, 4 oz. Hamburgers, 3/4" thick (up to 12) 4 oz. Hamburgers, 3/4" thick (up to 6)	on rack on rack on rack	4 4 4	HI HI HI	8 - 11 (medium) 15 - 20 (well) 12 - 16 (well)	15 - 19 (medium) 15 - 19 (well) 15 - 19 (well)
Chicken Bone-in, skin-on breast Pieces	on rack	3 or 4	LO	25 - 36 (well)	28 - 39 (well)
Fish Filets Steaks, 1" thick	on rack on rack	4 4	LO LO	8 - 12 (flaky) 10 - 14 (flaky)	8 - 13 (flaky) 10 - 16 (flaky)
Pork Chops, 1" thick	on rack	4	HI	18 - 24 (well)	22 - 27 (well)

* When broiling fish, spray broil pan insert with cooking oil. Do not turn fish filets.

** Broiling times are approximate and may vary depending on the thickness of the food. Turn meat halfway through cooking times.



Oven Cooking

Oven Vent

When the oven is in use, the area near the vent may become hot enough to cause burns. NEVER block the vent opening.

The oven vent is located below the backguard vent shield on your range.

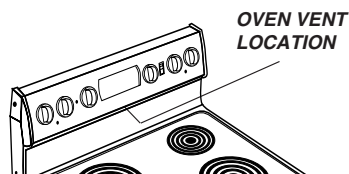

Do not place plastics near the vent opening as heat from the vent could distort or melt the plastic.

- When high moisture foods are cooked in the upper oven, steam may be visible coming from the oven vent. This is normal.

Oven Lights

The oven lights automatically come on when an oven door is opened. When the doors are closed, press the Oven Light pad to turn the oven lights on and off. A beep will sound every time the Oven Light pad is pressed.

Oven Light

Oven Bottom

Protect oven bottom against spillovers, especially acidic or sugary spills, as they may discolor the porcelain enamel. Use the correct pan size to avoid spillovers and boilovers. **Do not place utensils or aluminum foil directly on the oven bottom.**

Oven Racks

CAUTION

- Do not attempt to change the rack position when the oven is hot.
- Do not use the oven for storing food or cookware.

All racks are designed with a lock-stop edge.

Upper Oven

- Is equipped with one rack and rack position.
- When pulling the upper oven rack out to remove or check food, grasp the **top edge** of the rack.

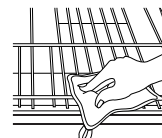

Lower Oven

- Is equipped with two regular flat racks.

To remove oven racks:

- Pull rack straight out until it stops at the lock-stop position; lift up on the front of the rack and pull out.

To replace oven racks:

- Place rack on the rack support in the oven; tilt the front end up slightly; slide rack back until it clears the lock-stop position; lower front and slide back into the oven.

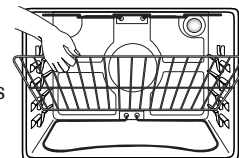

cont.

Oven Cooking

Oven Vent

When the oven is in use, the area near the vent may become hot enough to cause burns. NEVER block the vent opening.

The oven vent is located below the backguard vent shield on your range.

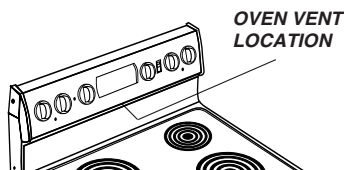

Do not place plastics near the vent opening as heat from the vent could distort or melt the plastic.

- When high moisture foods are cooked in the upper oven, steam may be visible coming from the oven vent. This is normal.

Oven Lights

The oven lights automatically come on when an oven door is opened. When the doors are closed, press the Oven Light pad to turn the oven lights on and off. A beep will sound every time the Oven Light pad is pressed.

Oven Light

Oven Bottom

Protect oven bottom against spillovers, especially acidic or sugary spills, as they may discolor the porcelain enamel. Use the correct pan size to avoid spillovers and boilovers. **Do not place utensils or aluminum foil directly on the oven bottom.**

Oven Racks

CAUTION

- Do not attempt to change the rack position when the oven is hot.
- Do not use the oven for storing food or cookware.

All racks are designed with a lock-stop edge.

Upper Oven

- Is equipped with one rack and rack position.
- When pulling the upper oven rack out to remove or check food, grasp the **top edge** of the rack.

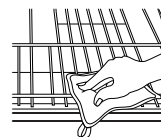

Lower Oven

- Is equipped with two regular flat racks.

To remove oven racks:

- Pull rack straight out until it stops at the lock-stop position; lift up on the front of the rack and pull out.

To replace oven racks:

- Place rack on the rack support in the oven; tilt the front end up slightly; slide rack back until it clears the lock-stop position; lower front and slide back into the oven.

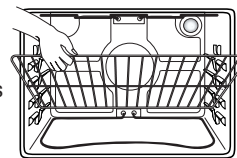

cont.



Oven Cooking

Rack Positions (lower oven)

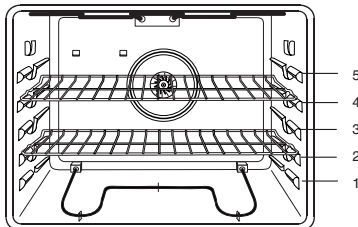

RACK 5: (highest position)

Use for toasting bread or broiling very thin, foods and two-rack baking.

RACK 4:

Use for two-rack baking and for broiling.

RACK 3:

Use for most baked goods on a cookie sheet or jelly roll pan, layer cakes, fruit pies, or frozen convenience foods, and for broiling.

RACK 2:

Use for roasting small cuts of meat, casseroles, baking loaves of bread, bundt cakes or custard pies, and two-rack baking.

RACK 1:

Use for roasting large cuts of meat and poultry, frozen pies, dessert souffles or angel food cake, and two-rack baking.

Multiple Rack Cooking:

Two rack: Use rack positions 2 and 4, 1 and 4, or 2 and 5.

Baking Layer Cakes on Two Racks

For best results when baking cakes on two racks, use racks 2 and 4.

Place the cakes on the rack as shown.

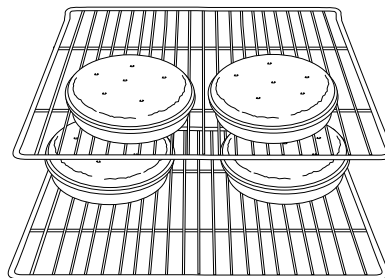

Half Rack Accessory (lower oven only)

A half rack, to increase oven capacity, is available as an accessory. It fits in the left, upper portion of the oven and provides space for a vegetable dish when a large roaster is on the lower rack. Contact your Maytag dealer for the "HALFRACK" Accessory Kit or call 1-877-232-6771 USA or 1-800-688-8408 Canada to order.

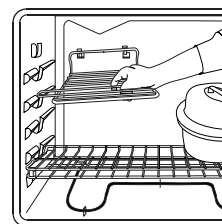

Surface Cooking

Surface Controls

Use to turn on the surface elements. An infinite choice of heat settings is available from **Low** to **High**. The knobs can be set on or between any of the settings.

Setting the Controls

- Place pan on surface element.
- Push in and turn the knob in either direction to the desired heat setting.
 - The control panel is marked to identify which element the knob controls. For example, the graphic at right indicates left front element.
- There is an element **"ON" indicator light** on the control panel. When any surface control knob is turned on, the light will turn on. The light will turn off when all the surface elements are turned off.
- After cooking, turn knob to **OFF**. Remove pan.



Dual Elements (select models)

The cooking surface has two dual elements located in the right front and left front of the smoothtop. This allows you to change the size of these elements. Turn control knob to OFF before switching element size.

Press the switch to the left to use the large element or to the right to use the small element.

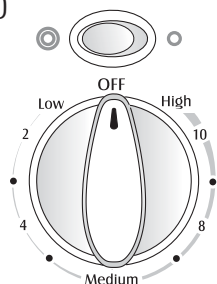

Suggested Heat Settings

The size, type of cookware and cooking operation will affect the heat setting. For information on cookware and other factors affecting heat settings, refer to Cookware Recommendations on page 7 and "Cooking Made Simple" booklet.

Low (2): Use to keep foods warm and melt chocolate and butter.

High (10): Use to bring liquid to a boil. Always reduce setting to a lower heat when liquids begin to boil or foods begin to cook.

Med. Low (3-4): Use to continue cooking covered foods or steam foods.

Medium (5-7): Use to maintain slow boil for large amounts of liquids and for most frying operations.

Med. High (8-9): Use to brown meat, heat oil for deep fat frying or sauteing. Maintain fast boil for large amounts of liquids.

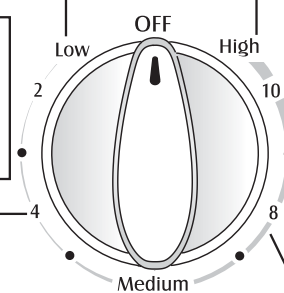

CAUTION

BEFORE COOKING

- Always place a pan on the surface unit before you turn it on. To prevent damage to range, never operate surface unit without a pan in place.
- NEVER** use the cooktop as a storage area for food or cookware.

DURING COOKING

- Be sure you know which knob controls which surface unit. Make sure you turned on the correct surface unit.
- Begin cooking on a higher heat setting then reduce to a lower setting to complete the operation. Never use a high heat setting for extended cooking.
- NEVER** allow a pan to boil dry. This could damage the pan and the appliance.
- NEVER** touch cooktop until it has cooled. Expect some parts of the cooktop, especially around the surface units, to become warm or hot during cooking. Use potholders to protect hands.

AFTER COOKING

- Make sure surface unit is turned off.
- Clean up messy spills as soon as possible.

OTHER TIPS

- If cabinet storage is provided directly above cooking surface, limit it to items that are infrequently used and can be safely stored in an area subjected to heat. Temperatures may be unsafe for items such as volatile liquids, cleaners or aerosol sprays.
- NEVER** leave any items, especially plastic items, on the cooktop. The hot air from the vent may ignite flammable items, melt or soften plastics, or increase pressure in closed containers causing them to burst.
- NEVER** allow aluminum foil, meat probes or any other metal object, other than a pan on a surface element, to contact heating elements.
- NEVER** store heavy items above the cooktop that could fall and damage it.



Surface Cooking

Smoothtop Surface

Smoothtop Surface Notes:

- For Canadian models, the smoothtop does NOT operate during a clean cycle.
- **Cooktop may emit light smoke and odor** the first few times the cooktop is used. This is normal.
- **Smoothtop cooktops retain heat for a period of time after the element is turned off.** Turn the elements off a few minutes before food is completely cooked and use the retained heat to complete cooking. When the Hot Surface indicator light turns off, the cooking area will be cool enough to touch. Because of the way they retain heat, the smoothtop elements will not respond to changes in settings as quickly as coil elements.
- In the event of a potential boilover, remove the pan from the cooking surface.
- **Never attempt to lift the cooktop.**
- The smoothtop surface may appear discolored when it is hot. This is normal and will disappear when the surface cools.

Cooking Areas

The cooking areas on your range are identified by permanent circles on the smoothtop surface. For most efficient cooking, fit the pan size to the element size.

Pans should not extend more than 1/2 to 1-inch beyond the cooking area.

When a control is turned on, a glow can be seen through the smoothtop surface. **The element will cycle on and off to maintain the preset heat setting, even on High.**

For more information on cookware, refer to Cookware Recommendations on page 7 and "Cooking Made Simple" booklet included with your range.

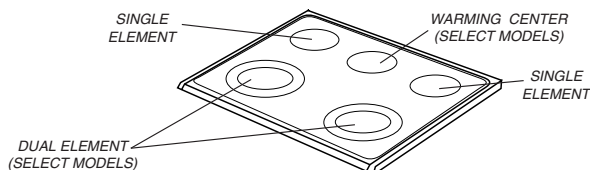

(style varies by model)

Hot Surface Light

The Hot Surface indicator light is located on the control panel. The light will be illuminated when any cooking area is hot. It will remain on, even after the control is turned off, until the area has cooled.



Hot Surface

Warming Center (select models)

Use the Warming Center to keep hot cooked foods warm, such as vegetables, gravies and oven-safe dinner plates.



Setting the Control:

Press switch up to turn off or down to activate.

Notes:

- **Never** warm food for longer than one hour (eggs for 30 minutes), as food quality may deteriorate.
- Do not heat cold food on the Warming Center.
- Warming temperatures of the food will vary depending on type and amount of food. Always hold food at proper food temperatures. USDA recommends food temperatures between 140°-170° F.

Warming Center Notes:

- Use only cookware and dishes recommended as safe for oven and cooktop use.
- Always use oven mitts when removing food from the Warming Center as cookware and plates will be hot.
- All foods should be covered with a lid or aluminum foil to maintain food quality.
- When warming pastries and breads the cover should have an opening to allow moisture to escape.
- Do not use plastic wrap to cover foods. Plastic may melt on to the surface and be very difficult to clean.



Surface Cooking

Tips to Protect the Smoothtop Surface

Cleaning (see page 20 for more information)

- Before first use, clean the cooktop.
- Clean your cooktop daily or after each use. This will keep your cooktop looking good and can prevent damage.
- If a spillover occurs while cooking, immediately clean the spill from the cooking area while it is hot to prevent a tough cleaning chore later. Using extreme care, wipe spill with a clean dry towel.
- Do not allow spills to remain on the cooking area or the cooktop trim for a long period of time.
- **Never** use abrasive cleansing powders or scouring pads which will scratch the cooktop.
- **Never** use chlorine bleach, ammonia or other cleansers not specifically recommended for use on glass-ceramic.

To Prevent Marks & Scratches

- Do not use glass pans. They may scratch the surface.
- **Never** place a trivet or wok ring between the surface and pan. These items can mark or etch the top.
- Do not slide aluminum pans across a hot surface. The pans may leave marks which need to be removed promptly. (See Cleaning, page 20.)
- Make sure the surface and the pan bottom are clean before turning on to prevent scratches.
- To prevent scratching or damage to the glass-ceramic top, do not leave sugar, salt or fats on the cooking area. Wipe the cooktop surface with a clean cloth or paper towel before using.
- **Never** slide heavy metal pans across the surface since these may scratch.

To Prevent Stains

- **Never** use a soiled dish cloth or sponge to clean the cooktop surface. A film will remain which may cause stains on the cooking surface after the area is heated.
- Continuously cooking on a soiled surface may/will result in a permanent stain.

To Prevent Other Damage

- Do not allow plastic, sugar or foods with high sugar content to melt onto the hot cooktop. Should this happen, clean immediately. (See Cleaning, page 20.)
- **Never** let a pan boil dry as this will damage the surface and pan.
- **Never** use cooktop as a work surface or cutting board.
- **Never** cook food directly on the surface.
- Do not use a small pan on a large element. Not only does this waste energy, but it can also result in spillovers burning onto the cooking area which requires extra cleaning.
- Do not use non-flat specialty items that are oversized or uneven such as round bottom woks, rippled bottom and/or oversized canners and griddles.
- Do not use foil or foil-type containers. Foil may melt onto the glass. If metal melts on the cooktop, do not use. Call an authorized Maytag Servicer.



Surface Cooking

Cookware Recommendations

Using the right cookware can prevent many problems, such as food taking longer to cook or achieving inconsistent results. Proper pans will reduce cooking times, use less energy, and cook food more evenly.

Flat Pan Tests

See if your pans are flat.



The Ruler Test:

1. Place a ruler across the bottom of the pan.
2. Hold it up to the light.
3. Little or no light should be visible under the ruler.

The Bubble Test:

1. Put 1 inch of water in the pan. Place on cooktop and turn control to **High**.
2. Watch the formation of the bubbles as the water heats. Uniform bubbles mean good performance, and uneven bubbles indicate hot spots and uneven cooking.

See "Cooking Made Simple" booklet for more information.

Canning and Oversize Cookware

All canners and large pots must have flat bottoms and must be made from heavy-gauge materials. This is critical on smoothtop surfaces. The base must not be more than 1 inch larger than the element.

When canners and pots do not meet these standards, cooking times may be longer, and cooktops may be damaged.

Some canners are designed with smaller bases for use on smoothtop surfaces.

When canning, use the High heat setting only until the water comes to a boil or pressure is reached in the canner. Reduce to the lowest heat setting that maintains the boil or pressure. If the heat is not turned down, the cooktop may be damaged.

See "Cooking Made Simple" booklet for more information.

Select	Avoid
Flat, smooth-bottom pans.	Pans with grooved or warped bottoms. Pans with uneven bottoms do not cook efficiently and sometimes may not boil liquid.
Heavy-gauge pans.	Very thin-gauge metal or glass pans.
Pans that are the same size as the element.	Pans smaller or larger than the element by 1 inch.
Secure handles.	Cookware with loose or broken handles. Heavy handles that tilt the pan.
Tight-fitting lids.	Loose-fitting lids.
Flat bottom woks.	Woks with a ring-stand bottom.

Oven Cooking

Control Panel

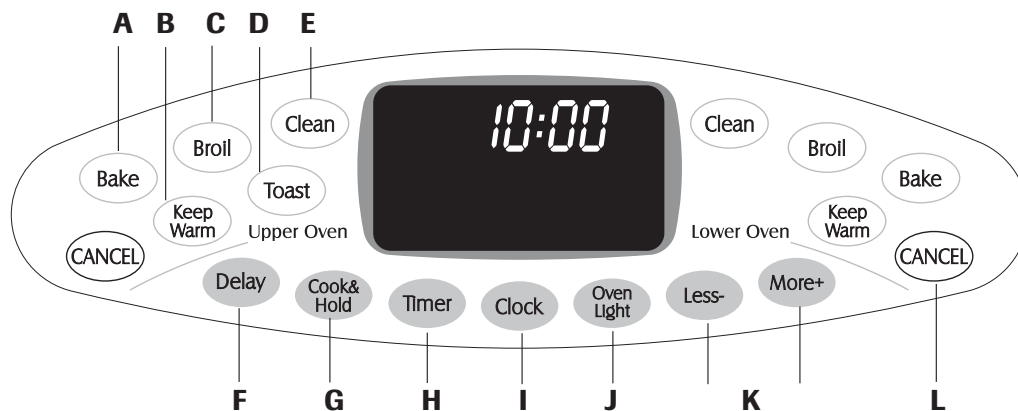

The control panel is designed for ease in programming. The display window on the control shows time of day, timer and oven functions. Control panel shown includes model specific features. (Styling may vary depending on model.)

A	Bake	Use for baking and roasting.
B	Keep Warm	Use to keep cooked food warm in oven.
C	Broil	Use for broiling and top browning.
D	Toast	Use for toasting bread and products toasted in toaster or toaster oven.
E	Clean	Use to set self-clean cycle.
F	Delay	Programs the oven to start baking or cleaning at a later time.
G	Cook & Hold	Bakes for a preset time, then keeps food warm for 1 hour.
H	Timer	Sets timer.
I	Clock	Use to set time-of-day clock.
J	Oven Light	Use to turn the oven lights on or off.
K	Less-/More+	Enters or changes time, oven temperature. Sets HI or LO broil.
L	CANCEL	Cancels all operations except timer and clock.

Clock

The clock can be set to display time in a 12-hour or 24-hour format. The clock is set at the factory for the 12-hour format.

To change the clock to 24-hour format:

1. Press and hold the Upper Oven CANCEL and Delay pads for several seconds.
2. Press the More+ or Less- pad to select 12 or 24 hour.
3. Set the time of day following the directions below.

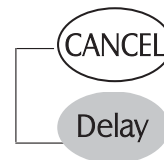

To set the Clock:

1. Press the Clock pad.
 - The colon (:) flashes in the display.
2. Press More+ or Less- pad to set the time of day.
 - Colon continues flashing.
3. Press the Clock pad again or wait four seconds.
 - The colon stops flashing.



Using the Touchpads

- Press the desired pad.
- Press More+ or Less- pad to enter time or temperature.
- A beep will sound when any pad is touched.
- A double beep will sound if a programming error occurs.

Note: Four seconds after pressing the More+ or Less- pad, the time or temperature will automatically be entered. If more than 30 seconds elapse between touching a function pad and the More+ or Less- pad, the function will be canceled and the display will return to the previous display.

When electrical power is supplied or after a power interruption, the last clock time before power was interrupted will flash.

To recall the time of day when another time function is showing, press the Clock pad.

Clock time cannot be changed when the oven has been programmed for Bake, Clean, Delay or Cook & Hold.

cont.

Use and Care - MER6751AA*, MER6755A**, MER6775A**



Oven Cooking

To cancel the Clock display:

If you do not want the time of day to display:

Press and hold the Upper Oven CANCEL and Clock pads for several seconds. The time of day will disappear from the display.

When the clock display is canceled, press the Clock pad to briefly display the time of day.

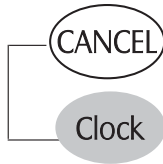

To restore the Clock display:

Press and hold the Upper Oven CANCEL and Clock pads for several seconds. The time of day will reappear in the display.

Timer

The timer can be set from one minute (1:00) up to 11 hours and 59 minutes (11:59).

The timer can be used independently of any other oven activity. It can also be set while another oven function is operating.

The timer does not control the oven.

To set the Timer:

1. Press the Timer pad.
 - “0:00” lights in the display.
 - “Timer” will flash.
2. Press the More+ or Less- pad until the correct time appears in the display.
 - “Timer” will continue to flash.
3. Press Timer pad again or wait four seconds.
 - The time begins counting down.
 - The last minute of the timer countdown will be displayed as seconds.
4. At the end of the set time, three long beeps will sound.



To cancel the Timer:

1. Press and hold the Timer pad for three seconds.
OR
2. Press the Timer pad and set the time to 0:00.

Locking the Control and Oven Doors

The touchpads and oven doors can be locked for safety, cleaning, or to prevent unwanted use. They will not function when locked.

If the oven is currently in use, the touchpads and doors cannot be locked.

The current time of day will remain in the display when the controls are locked.

To lock both doors:

Press and hold the Upper Oven CANCEL and Cook & Hold pads for three seconds.

- “Lock” flashes in the display while both oven doors lock. Once complete, “Lock” stops flashing.
- “OFF” is displayed for 10 seconds whenever a pad is touched.

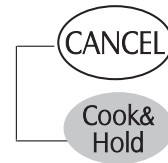

To unlock both doors:

Press and hold the Upper Oven CANCEL and Cook & Hold pads for three seconds.

- “Lock” flashes and then disappears from the display.
- “OFF” appears in the display for several seconds while doors are unlocking.

Note: The touchpads and oven doors cannot be locked if the oven temperature is 400° F or above.

Fault Codes

“Bake” or “Lock” may flash rapidly in the display to alert you if there is an error or a problem. If “Bake” or “Lock” flash in the display, press CANCEL pad. If “Bake” or “Lock” continue to flash, disconnect power to the appliance. Wait a few minutes, and then reconnect power. If the flashing still continues, disconnect power to the appliance and call an authorized servicer.

Adjusting the Sound Level

The factory default setting for sound is medium (MED), but it can be changed to low (Lo) or high (HI). To change the setting:

1. Press and hold More+ and upper oven CANCEL pads for three seconds. A beep will sound and the current sound level (“Lo”, “MED” or “HI”) will appear in the display.
2. Press More+ pad to increase sound level or the Less- pad to decrease sound level.
3. Wait four seconds and the new setting will be accepted.
4. If the More+ or Less- pad is not pressed within 30 seconds, the control will return to the existing settings.

Changing Temp °F/°C

The factory default setting for temperature is Fahrenheit. To change the setting:

1. Press and hold the upper oven Bake and CANCEL pads for three seconds. A beep will sound and the current setting (°F or °C) will appear in the display.
2. Press the More+ or Less- pad to change the setting between °F and °C.
3. Wait four seconds and the new setting will be accepted.



Oven Cooking

- If the More+ or Less- pad is not pressed within 30 seconds, the control will return to the existing settings.

Return To Factory Default Settings

The control can be reset to the factory default settings. To return to the default settings:

- Press and hold upper oven Keep Warm and CANCEL pads for three seconds. A single beep will sound and “dEF” (default) will appear in the display.
- Press the More+ pad to choose the factory settings. “cLr” (clear) will appear in the display.
- Wait four seconds and the factory settings will be accepted.
- If the More+ or Less- pad is not pressed within 30 seconds, the control will return to the existing settings.

Setting Upper and Lower Oven Functions

Baking

To set bake:

- Press the Bake pad for desired oven.
 - “Bake” will flash.
 - “000” will flash in the display.
- Select the oven temperature. The oven temperature can be set from 170° to 550°. Press or press and hold the More+ or Less- pad.
 - “350” will light when either pad is first pressed.
 - Press the More+ pad to increase the temperature.
 - Press the Less- pad to decrease the temperature.
- Press Bake pad again or wait four seconds.
 - “Bake” will stop flashing and light in the display.
 - “Preheat” will light in the display.
 - 100° or the actual oven temperature will display. The temperature will rise in 5° increments until the preset temperature is reached.



- Allow 4-10 minutes for upper oven to preheat and 7-12 minutes for lower oven to preheat.
 - When the set oven temperature is reached, one long beep will sound.
 - To recall the set temperature during preheat, press the Bake pad.

To change the oven temperature during preheat, press Bake once and reset temperature.

- Place food in the oven.
- Check cooking progress at minimum cooking time. Cook longer if needed.
- When cooking is finished, press CANCEL pad.
- Remove food from the oven.



Baking Differences Between Your Old and New Oven

It is normal to notice some baking time differences between a new oven and an old one. See “Adjusting the Oven Temperature” on page 15.

Baking Notes:

- If the lower oven is NOT in use, the upper oven will preheat more quickly.
- Allow at least 1/2-inch between the baking pan or casserole and the top element in the upper oven.** Loaf, angel food or bundt pans are not recommended in the upper oven.
- Do not use temperatures below 140° F to keep food warm or below 200° F for cooking. For food safety reasons, lower temperatures are not recommended.
- The back part of the lower oven bake element will NOT glow red during baking. This is normal.
- When baking frozen, self-rise pizzas in the upper oven, place the pizza on a cookie sheet to avoid overbrowning.
- When preheating with a baking/pizza stone inside the upper oven, do not set oven above 400° F. To use baking/pizza stones at temperatures above 400° in the upper oven, put stone in after the preheat beep.**
- To change the oven temperature during cooking, press the Bake pad and then the More+ or Less- pad until you reach the desired temperature.
- If you forget to turn off the oven, it will automatically turn off at the end of 12 hours. If you wish to deactivate the Automatic Shut-Off/Sabbath Mode feature, see page 14.
- For additional baking and roasting tips, see “Cooking Made Simple” booklet.

Cook & Hold

Cook & Hold allows you to bake for a preset amount of time, followed by a one-hour Keep Warm cycle.

To set Cook & Hold:

- Press the Cook & Hold pad **once** for upper oven or **twice** for lower oven.
 - “Bake” and “Hold” flash.
 - “000” will flash in the display.



cont.

Use and Care - MER6751AA*, MER6755A**, MER6775A**



Oven Cooking

- Select the oven temperature. The oven temperature can be set from 170° to 550°. Press or press and hold the More+ or Less- pad.
 - Press the More+ pad to increase the temperature.
 - Press the Less- pad to decrease the temperature.
- Press Cook & Hold pad again OR wait four seconds to set cook time.
 - "Time" flashes.
 - "0:00" flashes in the display
- Enter the amount of time you want to cook by pressing the More+ or Less- pad. Time can be set from 10 minutes (10:00) to 11 hours, 59 minutes (11:59).
 - "Bake", "Preheat" and "Hold" light in the display.
 - The cooking time will start counting down.
 - "100°" or actual oven temperature will light in the display.



When the cooking time has elapsed:

- Three beeps will sound.
- "Bake" will turn off.
- "Hold" will light.

After one hour in HOLD WARM:

- The oven will turn off. Three beeps will sound.

To cancel Cook & Hold at any time:

Press the CANCEL pad. Remove food from oven.



Delay Cook & Hold

CAUTION

Do not use delayed baking for highly perishable foods such as dairy products, pork, poultry, or seafood.

When using **Delay**, the oven begins to cook later in the day. Set the amount of time that you want to delay before the oven turns on and how long you want to cook. The oven begins to heat at the selected time and cooks for the specified length of time, then keeps food warm for one hour.

Delay time can be set from 10 minutes (10:00) to 11 hours, 59 minutes (11:59).

To set a Delayed Baking cycle:

- Press the Delay pad **once** for upper oven or **twice** for lower oven.
 - "dLY" and "0:00" flash in the display.
- Press the More+ or Less- pad **to set the amount of time you want to delay** the Cook & Hold cycle.
 - While "dLY" is still flashing:
 - Press the Cook & Hold pad.
 - "000°" flashes in the display.
 - "Bake" and "Hold" flash.
 - Press More+ or Less- pad to enter the oven temperature.
 - "Bake" flashes.
 - After several seconds, "0:00" and "Time" flash.
 - "Bake" and "Hold" remain steady.
 - Press More+ or Less- pad to set the baking time.
 - "Time" flashes.
 - After several seconds, the delay time will count down.
 - "dLY", "Bake" and "Hold" light in the display.

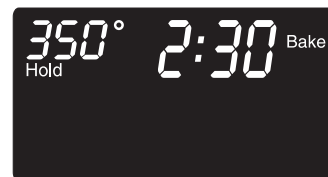

When the Delay time has expired:

- "dLY" will turn off.
- Baking time and temperature are displayed.
- "Bake" and "Hold" are displayed.

When the oven starts:

- The baking time will count down.
- "dLY" will turn off.
- "Bake" and "Hold" will remain lit.

To cancel:

Press the CANCEL pad.

- All timed and untimed cooking functions will be canceled.
- The time of day will reappear in the display.

Notes:

- Do not use delayed baking for items that require a preheated oven, such as cakes, cookies, and breads.
- Do not use delayed baking if oven is already hot.

Oven Cooking

Keep Warm

For safely keeping foods warm or for warming breads and plates.

To set Keep Warm:

- Press the Keep Warm pad for the appropriate oven.
 - “Warm” flashes.
 - “000°” flashes in the display.
- Select the Keep Warm temperature. The Keep Warm temperature can be set from 145° to 190°. Press or press and hold the More+ or Less- pad.
 - 170° will light when either pad is first pressed.
 - Press the More+ pad to increase the temperature.
 - Press the Less- pad to decrease the temperature.

“Warm” and the temperature will be displayed while Keep Warm is active.

Keep Warm

Less-

More+

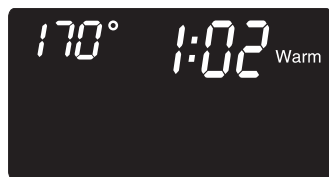

To cancel Keep Warm:

- Press the CANCEL pad.
- Remove food from the oven.

CANCEL

Keep Warm Notes:

- For optimal food quality, oven cooked foods should be kept warm for no longer than 1 to 2 hours.
- To keep foods from drying, cover loosely with foil or a lid.
- **To warm dinner rolls:**
 - cover rolls loosely with foil and place in oven.
 - press Keep Warm and More+ pads to set 170° F.
 - warm for 12-15 minutes.
- **To warm plates:**
 - place 2 stacks of up to four plates each in the oven.
 - press Keep Warm and More+ pads to set 170° F.
 - warm for five minutes, turn off the oven and leave plates in the oven for 15 minutes more.
 - use only oven-safe plates, check with the manufacturer.
 - do not set warm dishes on a cold surface as rapid temperature changes could cause crazing or breakage.

Toasting (upper oven only)

For toasting bread and products that are toasted in a toaster or toaster oven. Toast time can be set from 10 seconds up to six minutes.

- Press the Toast pad.
- Select the toasting time. Press the More+ pad to increase the time or press the Less- pad to decrease the time.
 - “Toast” and the toasting time will be displayed. The toasting time will begin to count down.

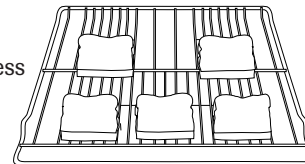

Browning time may vary, watch toasting carefully to avoid over-browning. Close oven door during toasting.

- At the end of the set toasting time, the oven will beep.

Toasting Notes:

- **Lower oven may not be operated while upper oven is toasting. If the lower oven is operating when the Toast pad is pressed, a beep will sound.**
- Toasting is based on time not temperature.
- For more even browning results, preheat the oven 3-4 minutes.
- Toasting times will be shorter when the oven is hot or when repeated toasting functions are done.
- For optimal results when toasting 4-5 pieces of bread or other similar items, follow illustration above.

Toasting Chart

FOOD	TOAST TIME*/COLD START
Sliced White Bread	3½ - 4½ min.
Waffles (frozen)	4 - 4½ min.
Toaster Pastry (unfrozen)	3½ - 4 min.
Toaster Pastry (frozen)	4½ - 4¾ min
Tortillas (flour)	2½ - 3 min.
Toaster Breaks** or Hot Pockets**	4 - 5 min.
Bagels	4½ - 5 min.
English Muffins	3½ - 4 min.
Cheese Sandwich	3½ - 4½ min

* Toasting times are approximate and should be used as a guide only.

** Brand names are registered trademarks of the respective manufacturers.

Use and Care - MER6751AA*, MER6755A**, MER6775A**



Oven Cooking

Broiling

To set Broil:

- Press the Broil pad for desired oven.
 - “Broil” and “SEt” flash in the display.
- Press the More+ or Less- pad once to set HI broil. Press the More+ or Less- pad twice to set LO broil.
 - HI or LO will be displayed.
 - Select HI broil (550° F) for normal broiling. Select LO broil (450° F) for low-temperature broiling of longer cooking foods such as poultry.
- After four seconds, the oven will start.
 - “Broil” and HI or LO will remain lit.

Broil



- For optimum browning, preheat broil element for 3-4 minutes before adding food.
- Place food in the oven. Leave oven door open about four inches (the first stop).
- Most meat should be turned once about halfway through cooking.

- When food is cooked, press the CANCEL pad. Remove food and broiler pan from the oven.
 - The time of day will reappear in the display.

CANCEL

Broil Notes:

- For best results when broiling, use a two-piece broiler pan.
- HI broil is used for most broiling. Use LO broil when broiling longer cooking foods to allow them to cook to well done stage without excessive browning.
- Broil times may be longer when the LO broil temperature is selected.
- Never cover broiler pan insert with aluminum foil. This prevents fat from draining to the pan below.
- Expect broil times to increase and browning to be slightly lighter if appliance is installed on a 208-volt circuit.
- If more than 30 seconds elapse between pressing the Broil pad and the More+ or Less- pad, the oven will not be set and the display will return to the previous display.
- Most foods should be turned halfway through broiling time.
- For additional broiling tips and temperatures, refer to the “Cooking Made Simple” booklet.

Broiling Chart - Broil times are based on a 4 minute preheat.

FOODS	UPPER OVEN RACK POSITION*	LOWER OVEN RACK POSITION*	SETTING	UPPER OVEN COOK TIME (MINUTES)**	LOWER OVEN COOK TIME (MINUTES)**
Beef					
Steak, 1" thick,	on rack	4	HI	8 - 11 (medium)	15 - 19 (medium)
4 oz. Hamburgers, 3/4" thick (up to 12)	on rack	4	HI	15 - 20 (well)	15 - 19 (well)
4 oz. Hamburgers, 3/4" thick (up to 6)	on rack	4	HI	12 - 16 (well)	15 - 19 (well)
Chicken					
Bone-in, skin-on breast Pieces	on rack	3 or 4	LO	25 - 36 (well)	28 - 39 (well)
Fish					
Filets	on rack	4	LO	8 - 12 (flaky)	8 - 13 (flaky)
Steaks, 1" thick	on rack	4	LO	10 - 14 (flaky)	10 - 16 (flaky)
Pork					
Chops, 1" thick	on rack	4	HI	18 - 24 (well)	22 - 27 (well)

* When broiling fish, spray broil pan insert with cooking oil. Do not turn fish filets.

** Broiling times are approximate and may vary depending on the thickness of the food. Turn meat halfway through cooking times.



Oven Cooking

Automatic Shut-Off/Sabbath Mode

The ovens will automatically turn off after 12 hours if you accidentally leave them on. **The oven MUST be set for a bake operation before setting the Automatic Shut-off/Sabbath Mode.**

To cancel the 12-hour shut-off and run the ovens continuously for 72 hours:

1. Set the oven to bake (see page 10).

2. Press and hold the Clock pad for five seconds.

Clock

- “SAbbAth”* will be displayed and flash for five seconds.
- “SAbbAth” will then be displayed continuously until turned off or until the 72-hour time limit is reached.
- “Bake” and the oven temperature will also be displayed if a bake setting is in use while the oven is in Sabbath Mode.

All other functions EXCEPT BAKE (Timer, Keep Warm, Clean, etc.) are locked out during the Sabbath Mode.

To cancel Bake when in Sabbath Mode:

Press the CANCEL pad.

- “Bake” and the oven temperature will turn off in the display.
- “SabbAth” appears in the display.
- “Time” no longer appears in the display.

CANCEL

Clock

To cancel the Sabbath Mode:

1. Press the Clock pad for five seconds.

- “SAbbAth” will flash for 5 seconds.
- The time of day will return to the display.

OR

2. After 72 hours, the Sabbath Mode will end.

- “SAbbAth” will flash for 5 seconds.
- The time of day will return to the display.

Sabbath Mode Notes:

- Sabbath Mode can be turned on **only** when the ovens are on.
- Sabbath Mode cannot be turned on if the touchpads are locked out or when the doors are locked.
- If the oven light is desired while in Sabbath Mode, it must be turned on before the Sabbath Mode is started.
- When the Sabbath Mode is started, no preheat beep will sound.
- All prompts, messages and beeps are deactivated when Sabbath Mode is active.
- The automatic door lock does not operate during the Sabbath Mode.
- Pressing CANCEL pad will cancel a bake cycle, however the control will stay in the Sabbath Mode.
- If power fails, the ovens will power up in Sabbath Mode with 72 hours remaining and no cycle active.

* Note: “SAbbAth” appears in the display on two lines: SAb
bAth

Oven Cooking

Oven Vent

When the oven is in use the area near the vent may become hot enough to cause burns. Never block the vent opening.

The oven vent is located below the backguard vent shield on your range.

When high moisture foods are cooked in the upper oven, steam may be visible coming from the oven vent. This is normal.

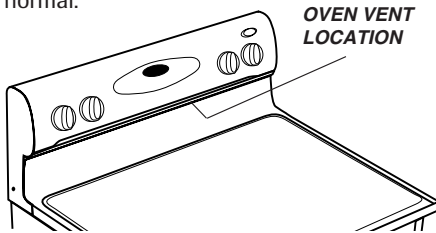

Do not place plastics near the vent opening as heat from the vent could distort or melt the plastic.

Oven Lights

The oven lights automatically come on when an oven door is opened. When the doors are closed, press the appropriate Oven Light pad to turn the oven lights on and off. A beep will sound every time the Oven Light pad is pressed.

Oven Light

Oven Bottom

Protect oven bottom against spillovers, especially acidic or sugary spills, as they may discolor the porcelain enamel. Use the correct pan size to avoid spillovers and boilovers. **Do not place utensils or aluminum foil directly on the oven bottom.**

Oven Racks

CAUTION

- Do not attempt to change the rack position when the oven is hot.
- Do not use the oven for storing food or cookware.

All racks are designed with a lock-stop edge.

Upper oven

- Is equipped with one rack and rack position.
- When pulling the upper oven rack out to remove or check food, grasp the **top edge** of the rack.

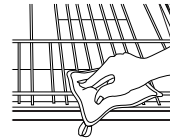

Lower oven

- Is equipped with one RollerGlide™ rack and one flat rack (select models) or two flat racks.

To remove oven racks:

- Pull rack straight out until it stops at the lock-stop position; lift up on the front of the rack and pull out.
- For RollerGlide™ rack, pull both the rack glide and rack base out together.

To replace oven racks:

- Place rack on the rack support in the oven; tilt the front end up slightly; slide rack back until it clears the lock-stop position; lower front and slide back into the oven.

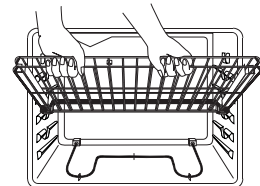

Baking and Roasting with the RollerGuide™ Rack (select models)

Baking

- When baking on two racks, use the RollerGuide™ rack in the lower rack position, and the flat rack in the upper rack position.

Roasting

- When roasting large cuts of meat and poultry, use the RollerGuide™ rack for ease of movement.

cont.

Oven Cooking

Rack Positions (lower oven)

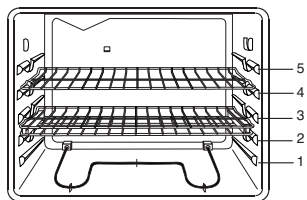

RACK 5: Use for toasting bread or broiling very thin foods and two-rack baking.

RACK 4: Use for two-rack baking and for broiling.

RACK 3: Use for most baked goods on a cookie sheet or jelly roll pan, layer cakes, fruit pies, or frozen convenience foods and for broiling.

RACK 2: Use for roasting small cuts of meat, casseroles, baking loaves of bread, bundt cakes or custard pies and two-rack baking.

RACK 1: Use for roasting large cuts of meat and poultry, frozen pies, dessert souffles or angel food cake and two-rack baking.

MULTIPLE RACK COOKING:

Two rack: Use rack positions 2 and 4, 1 and 4, or 2 and 5.

Baking Layer Cakes on Two Racks

For best results when baking cakes and cookies on two racks, use racks 2 and 4.

Place the cakes on the rack as shown.

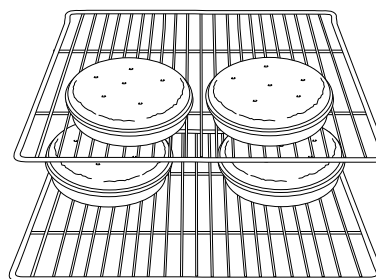

Half Rack Accessory (Lower oven only)

A half rack, to increase oven capacity, is available as an accessory. It fits in the left, upper portion of the lower oven and provides space for a vegetable dish when a large roaster is on the lower rack. Contact your Maytag dealer for the "HALFRACK" Accessory Kit or call 1-877-232-6771 USA or 1-800-688-8408 Canada to order.

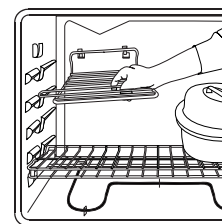

Surface Cooking

Surface Controls

Use to turn on the surface elements. An infinite choice of heat settings is available from **Low** to **High**. The knobs can be set on or between any of the settings.

Setting the Controls

1. Place pan on surface element.
2. Push in and turn the knob in either direction to the desired heat setting.
 - The control panel is marked to identify which element the knob controls. For example, the graphic at right indicates left front element.
3. There is an element **"ON" indicator light** on the control panel. When any surface control knob is turned on, the light will turn on. The light will turn off when all the surface elements are turned off.
4. After cooking, turn knob to **OFF**. Remove pan.



Dual Elements

The cooking surface has two dual elements located in the right front and left front of the smoothtop. This allows you to change the size of these elements.

Press the switch to the left to use the large element or to the right to use the small element.

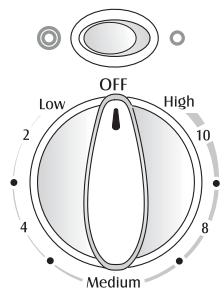

Suggested Heat Settings

The size, type of cookware and cooking operation will affect the heat setting. For information on cookware and other factors affecting heat settings, refer to Cookware Recommendations on page 7 and "Cooking Made Simple" booklet.

Flex Choice Warm
(right rear element only):
Uses a lower heat to keep foods warm for serving.

High (10): Use to bring liquid to a boil. Always reduce setting to a lower heat when liquids begin to boil or foods begin to cook.

Low (2): Use to keep foods warm and melt chocolate and butter.

Med. Low (3-4):
Use to continue cooking covered foods or steam foods.

Medium (5-7): Use to maintain slow boil for large amounts of liquids and for most frying operations.

Med. High (8-9): Use to brown meat, heat oil for deep fat frying or sauteing. Maintain fast boil for large amounts of liquids.

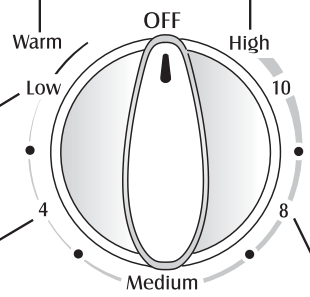

CAUTION

BEFORE COOKING

- Always place a pan on the surface unit before you turn it on. To prevent damage to range, never operate surface unit without a pan in place.
- **NEVER** use the cooktop as a storage area for food or cookware.

DURING COOKING

- Be sure you know which knob controls which surface unit. Make sure you turned on the correct surface unit.
- Begin cooking on a higher heat setting then reduce to a lower setting to complete the operation. Never use a high heat setting for extended cooking.
- **NEVER** allow a pan to boil dry. This could damage the pan and the appliance.
- **NEVER** touch cooktop until it has cooled. Expect some parts of the cooktop, especially around the surface units, to become warm or hot during cooking. Use potholders to protect hands.

AFTER COOKING

- Make sure surface unit is turned off.
- Clean up messy spills as soon as possible.

OTHER TIPS

- If cabinet storage is provided directly above cooking surface, limit it to items that are infrequently used and can be safely stored in an area subjected to heat. Temperatures may be unsafe for items such as volatile liquids, cleaners or aerosol sprays.
- **NEVER** leave any items, especially plastic items, on the cooktop. The hot air from the vent may ignite flammable items, melt or soften plastics, or increase pressure in closed containers causing them to burst.
- **NEVER** allow aluminum foil, meat probes or any other metal object, other than a pan on a surface element, to contact heating elements.
- **NEVER** store heavy items above the cooktop that could fall and damage it.

Surface Cooking

Smoothtop Surface

Smoothtop Surface Notes:

- On Canadian models, the smoothtop does NOT operate during a clean cycle.
- **Cooktop may emit light smoke and odor** the first few times the cooktop is used. This is normal.
- **Smoothtop cooktops retain heat for a period of time after the element is turned off.** Turn the elements off a few minutes before food is completely cooked and use the retained heat to complete cooking. When the Hot Surface Indicator light turns off, the cooking area will be cool enough to touch. Because of the way they retain heat, the smoothtop elements will not respond to changes in settings as quickly as coil elements.
- In the event of a potential boilover, remove the pan from the cooking surface.
- **Never attempt to lift the cooktop.**
- The smoothtop surface may appear discolored when it is hot. This is normal and will disappear when the surface cools.

Cooking Areas

The cooking areas on your range are identified by permanent circles on the smoothtop surface. For most efficient cooking, fit the pan size to the element size.

Pans should not extend more than 1/2 to 1-inch beyond the cooking area.

When a control is turned on, a glow can be seen through the smoothtop surface. **The element will cycle on and off to maintain the preset heat setting, even on High.**

For more information on cookware, refer to Cookware Recommendations on page 7 and "Cooking Made Simple" booklet included with your range.

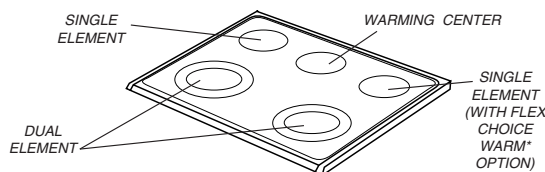

- * **Flex•Choice Warm:** This setting uses a very low heat setting to keep delicate foods or foods in a covered pan warm without cooking.

Hot Surface Indicator Light

The Hot Surface indicator light is located on the control panel. The light will be illuminated  when any cooking area is hot. It will remain on, even after the control is turned off, until the area has cooled. **Hot Surface**

Warming Center (style may vary by model)

Use the Warming Center to keep hot cooked foods warm, such as vegetables, gravies and oven-safe dinner plates.

Setting the Control:

Touch the Surface Warming Center pad and then the Autoset pad. Press Autoset pad again to turn off.



Warming Center Notes:

- **Never** warm food for longer than one hour (eggs for 30 minutes), as food quality may deteriorate.
- Do not heat cold food on the Warming Center.
- Warming temperatures of the food will vary depending on type and amount of food. Always hold food at proper food temperatures. USDA recommends food temperatures between 140°-170° F.
- Use only cookware and dishes recommended as safe for oven and cooktop use.
- Always use oven mitts when removing food from the Warming Center as cookware and plates will be hot.
- All foods should be covered with a lid or aluminum foil to maintain food quality.
- When warming pastries and breads the cover should have an opening to allow moisture to escape.
- Do not use plastic wrap to cover foods. Plastic may melt on to the surface and be very difficult to clean.



Surface Cooking

Tips to Protect the Smoothtop Surface

Cleaning (see page 21 for more information)

- Before first use, clean the cooktop.
- Clean your cooktop daily or after each use. This will keep your cooktop looking good and can prevent damage.
- If a spillover occurs while cooking, immediately clean the spill from the cooking area while it is hot to prevent a tough cleaning chore later. Using extreme care, wipe spill with a clean dry towel.
- Do not allow spills to remain on the cooking area or the cooktop trim for a long period of time.
- **Never** use abrasive cleansing powders or scouring pads which will scratch the cooktop.
- **Never** use chlorine bleach, ammonia or other cleansers not specifically recommended for use on glass-ceramic.

To Prevent Marks & Scratches

- Do not use glass pans. They may scratch the surface.
- **Never** place a trivet or wok ring between the surface and pan. These items can mark or etch the top.
- Do not slide aluminum pans across a hot surface. The pans may leave marks which need to be removed promptly. (See Cleaning, page 21.)
- Make sure the surface and the pan bottom are clean before turning on to prevent scratches.
- To prevent scratching or damage to the glass-ceramic top, do not leave sugar, salt or fats on the cooking area. Wipe the cooktop surface with a clean cloth or paper towel before using.
- **Never** slide heavy metal pans across the surface since these may scratch.

To Prevent Stains

- **Never** use a soiled dish cloth or sponge to clean the cooktop surface. A film will remain which may cause stains on the cooking surface after the area is heated.
- Continuously cooking on a soiled surface may/will result in a permanent stain.

To Prevent Other Damage

- Do not allow plastic, sugar or foods with high sugar content to melt onto the hot cooktop. Should this happen, clean immediately. (See Cleaning, page 21.)
- **Never** let a pan boil dry as this will damage the surface and pan.
- **Never** use cooktop as a work surface or cutting board.
- **Never** cook food directly on the surface.
- Do not use a small pan on a large element. Not only does this waste energy, but it can also result in spillovers burning onto the cooking area which requires extra cleaning.
- Do not use non-flat specialty items that are oversized or uneven such as round bottom woks, rippled bottom and/or oversized canners and griddles.
- Do not use foil or foil-type containers. Foil may melt onto the glass. If metal melts on the cooktop, do not use. Call an authorized Maytag Servicer.



Surface Cooking

Cookware Recommendations

Using the right cookware can prevent many problems, such as food taking longer to cook or achieving inconsistent results. Proper pans will reduce cooking times, use less energy, and cook food more evenly.

Flat Pan Tests

See if your pans are flat.

The Ruler Test:

1. Place a ruler across the bottom of the pan.
2. Hold it up to the light.
3. Little or no light should be visible under the ruler.

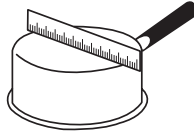

The Bubble Test:

1. Put 1 inch of water in the pan. Place on cooktop and turn control to **High**.
2. Watch the formation of the bubbles as the water heats. Uniform bubbles mean good performance, and uneven bubbles indicate hot spots and uneven cooking.

See "Cooking Made Simple" booklet for more information.

Select	Avoid
Flat, smooth-bottom pans.	Pans with grooved or warped bottoms. Pans with uneven bottoms do not cook efficiently and sometimes may not boil liquid.
Heavy-gauge pans.	Very thin-gauge metal or glass pans.
Pans that are the same size as the element.	Pans smaller or larger than the element by 1 inch.
Secure handles.	Cookware with loose or broken handles. Heavy handles that tilt the pan.
Tight-fitting lids.	Loose-fitting lids.
Flat bottom woks.	Woks with a ring-stand bottom.

Canning and Oversize Cookware

All canners and large pots must have flat bottoms and must be made from heavy-gauge materials. This is critical on smoothtop surfaces. The base must not be more than 1 inch larger than the element.

When canners and pots do not meet these standards, cooking times may be longer, and cooktops may be damaged.

Some canners are designed with smaller bases for use on smoothtop surfaces.

When canning, use the High heat setting only until the water comes to a boil or pressure is reached in the canner. Reduce to the lowest heat setting that maintains the boil or pressure. If the heat is not turned down, the cooktop may be damaged.

See "Cooking Made Simple" booklet for more information.



Oven Cooking

Control Panel

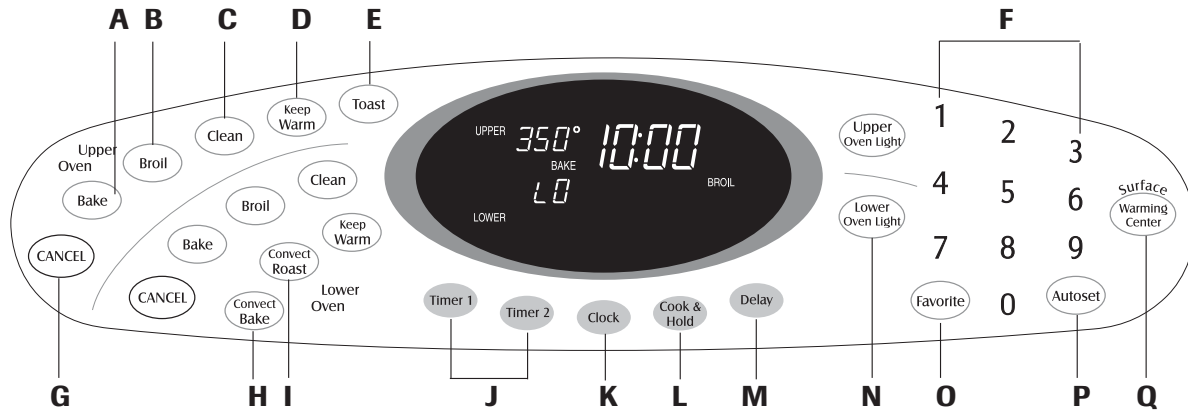

The control panel is designed for ease in programming. The display window on the control shows time of day, timer and oven functions. Control panel shown includes model specific features. (Styling may vary depending on model.)

A	Bake	Use for baking and roasting.
B	Broil	Use for broiling and top browning.
C	Clean	Use to set self-clean cycle.
D	Keep Warm	Use to keep cooked food warm in oven.
E	Toast	Use for toasting bread and products toasted in toaster or toaster oven.
F	Number Pads	Use to set time and temperature.
G	CANCEL	Cancels all operations except timer, clock and Surface Warming Center.
H	Convect Bake	Use for convection baking.
I	Convect Roast	Use for convection roasting.
J	Timer 1 or 2	Sets the timer.
K	Clock	Use to set time-of-day clock.
L	Cook & Hold	Bakes for a preset time, then keeps food warm for 1 hour.
M	Delay	Programs the oven to start baking or cleaning at a later time.
N	Oven Light	Use to turn the oven lights on or off.
O	Favorite	Use to set and save a specific Cook & Hold procedure.
P	Autoset	Use to quickly set temperatures.
Q	Surface Warming Center	Use to keep foods warm on the cooktop for serving.

NOTE: Four seconds after entering the time or temperature it will automatically be entered. If more than 30 seconds elapse between touching a function pad and the number pads, the function will be canceled and the display will return to the previous display.

Clock

The clock can be set to display time in a 12-hour or 24-hour format. The clock is set at the factory for the 12-hour format.

To change the clock to 24-hour format:

- Press and hold the Upper CANCEL pad and Favorite pad for three seconds.
 - 12 Hr flashes in the display.
- Press the Autoset pad to select 24 Hr; press again to select 12 Hr.
- Set the time of day following the directions in the To set the Clock section.

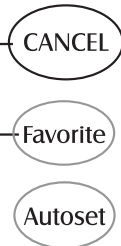

To set the Clock:

- Press the Clock pad.
 - The time of day flashes in the display.
 - Colon flashes in the display.
- Press the appropriate number pads to set the time of day.
- Press the Clock pad again or wait four seconds.
 - The colon will remain on.



Using the Touchpads

- Press the desired pad.
- Press the number pads to enter time or temperature.
- Or, press the Autoset pad to enter temperature.
- A beep will sound when any pad is touched.
- A double beep will sound if a programming error occurs.

When electrical power is supplied or after a power interruption, the last clock time before power was interrupted will flash.

To recall the time of day when another time function is showing, press the Clock pad.



Oven Cooking

To cancel the Clock display:

If you do not want the time of day to display:

Press and hold the Upper Oven CANCEL and Clock pads for three seconds. The time of day will disappear from the display.

When the clock display is canceled, press the Clock pad to briefly display the time of day.

To restore the Clock display:

Press and hold the Upper Oven CANCEL and Clock pads for three seconds. The time of day will reappear in the display.

Timer

Each timer can be set from one minute (00:01) up to 99 hours and 59 seconds (99:59).

The timers can be used independently of any other oven activity. They can also be set while another oven function is operating.

The Timers do not control the oven.

To set the Timer 1 or 2:

1. Press the Timer 1 or 2 pad.
 - 00:00 and TIMER 1 or 2 flash in the display.
2. Press the appropriate number pads until the correct time appears in the display.
 - The colon and TIMER 1 or 2 will continue to flash.
 - TIMER 1 or TIMER 2 will be displayed. If both timers are active, TIMER 1 and TIMER 2 will be displayed.
3. Press Timer pad again or wait four seconds.
 - The colon stops flashing and the time begins counting down.
 - The last minute of the timer countdown will be displayed in seconds.
4. At the end of the set time, one long beep will sound and "End" will be displayed.
5. Press the Timer pad to clear the display.

To cancel the Timer:

1. Press and hold the corresponding Timer pad for three seconds.
OR
2. Press the Timer pad and press '0' using the number pads.

Locking the Control and Oven Doors

The touchpad and oven doors can be locked for safety, cleaning, or to prevent unwanted use. The touchpads will not function when locked.

If an oven is currently in use, the touchpads and doors cannot be locked.

The current time of day will remain in the display when the touchpads and doors are locked.

To lock both doors:

1. Press and release CANCEL pad.
2. Press and hold the Upper Oven CANCEL and Cook & Hold pads for three seconds.

- OFF appears in the display
- LOCK flashes while the doors are locking. Both oven doors lock. LOCK remains in the display.

To unlock both doors:

Press and hold the Upper Oven CANCEL and Cook & Hold pads for three seconds. OFF disappears from the display and LOCK flashes while the doors are unlocking.

Note: The touchpads and oven doors cannot be locked if the oven temperature is 400° F or above.

Fault Codes

BAKE or LOCK may flash rapidly in the display to alert you if there is an error or a problem. If BAKE or LOCK flash in the display, press CANCEL pad. If BAKE or LOCK continue to flash, disconnect power to the appliance. Wait a few minutes, and then reconnect power. If the flashing still continues, disconnect power to the appliance and call an authorized servicer.

Adjusting Sound Level

The factory default setting for sound is medium (MED), but it can be changed to low (LO) or high (HI). To change the setting:

1. Press and hold Delay and upper oven CANCEL pads for three seconds. A beep will sound. "bBEEP" and the current sound level ("LO", "MED" or "HI") will appear in the display.
2. Press the Autoset pad to increase or decrease the sound level.
3. Wait four seconds and the new setting will be accepted.
4. If the Autoset pad is not pressed within 30 seconds, the control will return to the existing setting.

Changing Temp °F/°C

The factory default setting for temperature is Fahrenheit. To change the setting:

1. Press and hold the upper oven Bake and CANCEL pads for 3 seconds. A beep will sound and the current setting (°F or °C) will appear in the display.

Use and Care - MER6875A**



Oven Cooking

2. Press the AutoseT pad to change the setting between °F and °C.
3. Wait 4 seconds and the new setting will be accepted.
4. If the AutoseT pad is not pressed within 30 seconds, the control will return to the existing setting.

Return To Factory Default Settings

The control can be reset to the factory default settings. To return to the default settings:

1. Press and hold upper oven Keep Warm and CANCEL pads for 3 seconds. A single beep will sound and 12:00 will appear in the display.
2. Reset the clock to the current time of day.

Setting Oven Functions



Auto Set Pad

Use with function pads to automatically set:

- 350° F bake temperature
- HI or LO broil
- three hours of cleaning time
- four minutes of toasting time
- 170° F keep warm temperature

Baking

To set Bake:

1. Press the Bake pad for desired oven. 
 - BAKE and 000 will flash in the display.
2. Select the oven temperature. Press the AutoseT pad for 350° F or the appropriate number pads. 
 - Each additional press of the AutoseT pad will increase the temperature by 25°.
 - The oven temperature can be set from 170° to 550°.
3. Press Bake pad again or wait four seconds.
 - BAKE will stop flashing and light in the display.
 - PREHEAT will light in the display.
 - 100° or the actual oven temperature if over 100° F will display. It will rise in 5° increments until the preset temperature is reached.



4. Allow 4-10 minutes for the upper oven to preheat and 7-12 minutes for the lower oven to preheat.
 - When the set oven temperature is reached, one long beep will sound.
 - The set temperature will display.
 - PREHEAT will turn off.
 - To recall set temperature during preheat, press Bake pad.
5. Place food in the oven.
6. Check cooking progress at the minimum cooking time. Cook longer if needed.
7. When cooking is finished, press CANCEL pad. 
8. Remove food from the oven.

Baking Differences Between Your Old and New Oven

It is normal to notice some baking time differences between a new oven and an old one. See "Adjusting the Oven Temperature" on page 16.

Baking Notes:

- If the lower oven is NOT in use, the upper oven will preheat more quickly.
- **Allow at least 1/2-inch between the baking pan or casserole and the top element in the upper oven.** Loaf, angel food or bundt pans are not recommended in the upper oven.
- Do not use temperatures below 140° F to keep food warm or below 200° F for cooking. For food safety reasons, lower temperatures are not recommended.
- The back part of the lower oven bake element will not glow red during baking. This is normal.
- When baking frozen, self-rise pizza in the upper oven, place the pizza on a cookie sheet to avoid overbrowning.
- When preheating with a baking/pizza stone inside the upper oven, do not set oven above 400° F. To use baking/pizza stones at temperatures above 400° in the upper oven, put stone in after the preheat beep.
- To change the oven temperature during cooking, press Bake pad, then press the AutoseT pad or appropriate number pads until the desired temperature is displayed.
- **To change the oven temperature during preheat, press the Bake pad twice, then press the AutoseT pad or appropriate number pads until the desired temperature is displayed.**
- If you forget to turn off the oven, it will automatically turn off at the end of 12 hours. If you wish to deactivate the Automatic Shut Off/Sabbath Mode feature, see page 16.
- For additional baking and roasting tips, see "Cooking Made Simple" booklet.



Oven Cooking

Baking with Convection (lower oven only)

When convection baking, enter your normal baking temperature. The control will automatically reduce the set oven temperature by 25° (even though normal baking temperature is displayed).

To set Convect Bake:

1. Press the Convect Bake pad.
 - LOWER BAKE and the FAN icons will flash.
 - 000 will flash in the display.
2. Select the oven temperature. Press the AutoseT pad for 350° F or the appropriate number pads.
 - Each additional press of the AutoseT pad will increase the temperature by 25 degrees. The oven temperature can be set from 170° to 550°.
3. Press Convect Bake pad again or wait four seconds.
 - LOWER BAKE will stop flashing.
 - PREHEAT and LOWER will light in the display.
 - 100° or the actual oven temperature if over 100° F will display. It will rise in 5° increments until the preset temperature is reached.
 - The FAN icon will start to rotate.
4. Allow the oven to preheat for 7-12 minutes.
 - When the set oven temperature is reached, one long beep will sound.
 - PREHEAT will turn off.
 - The set temperature will display.
 - To recall the set temperature during preheat, press the Convect Bake pad.



5. Place food in the oven.
6. Check cooking progress at the minimum cooking time. Cook longer if needed.
7. When cooking is finished, press lower oven CANCEL pad.
8. Remove food from the oven.

Roasting With Convection (lower oven only)

When convection roasting, enter your normal roasting time and temperature. The control will automatically prompt you to check the food for doneness at 75% of the set time. The convection fan will come on immediately after the oven has turned on.

Roasting Notes:

- When convection roasting, the cooking time must be set before setting the temperature.
- If your recipe requires a preheated oven, add 15 minutes to the cooking time programmed.
- Roasting times can vary with different cuts of meat.
- It is not necessary to preheat when convect roasting large cuts of meat.
- Refer to "Cooking Made Simple" booklet for suggested roasting temperatures and times.

To set Convect Roast:

1. Press the Convect Roast pad.
 - LOWER ROAST, the FAN icon and 00:00 will flash in the display.
 - 000 lights in the display.
2. Enter the roasting time using the number pads.
 - Time can be set from 10 minutes (00:10) to 11 hours, 59 minutes (11:59).
 - Press Convect Roast pad again or wait 4 seconds.
 - LOWER ROAST and the FAN icon flash in the display.
 - 000 will flash in the display.
3. Select the oven temperature. Press the AutoseT pad for 325° F or the appropriate number pads. (Refer to Cooking Made Simple for roasting times.)
 - Each additional press of the AutoseT pad will increase the temperature by 25°.
 - The oven temperature can be set from 170° to 550°.
4. Press Convect Roast pad again or wait four seconds.
 - ROAST will stop flashing and light in the display.
 - 100° or the actual oven temperature will display. It will rise in 5° increments until the preset temperature is reached.
 - The FAN icon will start to rotate.

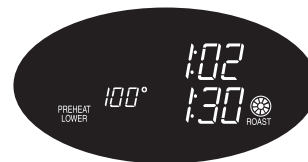

5. Place food in the oven.
 - Time will start counting down once oven starts heating up.
 - To recall the set temperature during preheat, press the Convect Roast pad.
6. When 75% of the set cooking time has elapsed, the oven will signal you to check the cooking progress. Cook longer if needed.

cont.



Oven Cooking

- The oven light will remain on until the Oven Light pad is pressed.
 - Press any pad to recall the cook time remaining.
7. When cooking is finished, press CANCEL pad.
 8. Remove food from the oven.

Cook & Hold

When using the **Cook & Hold** feature, the oven begins to heat immediately after the control has been set. Then, the oven cooks for a specified length of time. When that time has elapsed, the oven will keep the food warm for up to one hour then automatically turn off.

To set Cook & Hold:

1. Press the Cook & Hold pad **once** for upper oven or **twice** for lower oven. 
 - HOLD will flash to indicate that you are in Cook & Hold programming.
 - 00:00 and either UPPER or LOWER will flash in the display.
2. Select the amount of time you want to cook by using the number pads.
 - HOLD continues to flash.
 - The time will light in the display.
 - Time can be set from 00:10 to 11:59.
3. Press Bake (upper and lower ovens), Convect Bake or Convect Roast (lower oven only) and select the oven temperature. Press the Autoset pad for 350° F or the appropriate number pads.  
 - The desired function, 000 and either UPPER or LOWER will flash.
 - The oven temperature can be set from 170° F to 550° F.
4. Press the desired function pad again OR wait four seconds.
 - The desired function will remain lit.
 - The cooking time will show in the display.
 - PREHEAT will show in the display.
 - The actual oven temperature will be displayed during preheat.
 - The set temperature will display when the oven is preheated.

When the cooking time has elapsed:

- Four beeps will sound.
- WARM and HOLD will light.
- 170° appears in the display.



After one hour in WARM HOLD:

- The oven turns off automatically.
- Press CANCEL pad and remove food from the oven.

To cancel Cook & Hold at any time:

Press the CANCEL pad. Remove food from oven.



Delay Cook & Hold



CAUTION

Do not use delayed baking for highly perishable foods such as dairy products, pork, poultry, or seafood.

When using **Delay**, the oven begins to cook later in the day. Set the amount of time that you want to delay before the oven turns on and how long you want to cook. The oven begins to heat at the selected time and cooks for the specified length of time, then keeps food warm for one hour.

Delay time can be set from 10 minutes (00:10) to 11 hours, 59 minutes (11:59).

To set a Delayed Cook & Hold cycle:

1. Press the Delay pad **once** to program the upper oven or **twice** to program the lower oven. 
 - DELAY flashes in the display.
 - 00:00 and either UPPER or LOWER flash in the display.
2. Using the appropriate number pads, enter the amount of time you want to delay the start of the Cook & Hold cycle.
3. Press the Cook & Hold pad. 
 - HOLD and DELAY flash in the display.
 - 00:00 and either UPPER or LOWER flash.
4. Enter the amount of time you want to cook using the number pads.
5. Press Bake (upper and lower ovens), Convect Bake or Convect Roast (lower oven only).
6. Set the oven temperature desired by pressing the Autoset pad or the appropriate number pads. 
 - 350° will light when Autoset is pressed.
 - After four seconds, the entered delay time will appear in the display.
 - BAKE and DELAY remain lit to remind you that a delayed Cook & Hold function has been programmed.

Notes:

- Do not use Delayed Cook & Hold for items that require a preheated oven, such as cakes, cookies, and breads.
- Do not use Delayed Cook & Hold if oven is already hot.

Oven Cooking

Toasting (upper oven only)

For toasting bread and products that are toasted in a toaster or toaster oven.

1. Press the Toast pad.
2. Press the Autoset pad to set 4 minutes of toasting time. Each additional press will increase the toasting time by 1 minute. TOAST and the UPPER will be displayed. The toasting time will begin to count down.

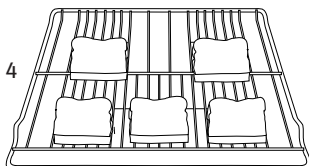

Or, press the appropriate number pads to set the toasting time in minutes and seconds between 10 seconds and 6 minutes.

Example: To set toasting time for two minutes, press 2, 0, 0.

Browning time may vary, watch toasting carefully to avoid over-browning. Close oven door during toasting.

3. At the end of the set toasting time, the oven will beep four times.

Toasting Notes:

- **Lower oven may not be operated while upper oven is toasting. If the lower oven is operating when the Toast pad is pressed, a beep will sound.**
- Toasting is based on time not temperature.
- For more even browning results, preheat the oven 3-4 minutes.
- Toasting times will be shorter when the oven is hot or when repeated toasting functions are done.
- For optimal results when toasting 4-5 pieces of bread or other similar items, follow illustration above.

Toasting Chart

FOOD	TOAST TIME*/COLD START
Sliced White Bread	3½ - 4½ min.
Waffles (frozen)	4 - 4½ min.
Toaster Pastry (unfrozen)	3½ - 4 min.
Toaster Pastry (frozen)	4½ - 4¾ min
Tortillas (flour)	2½ - 3 min.
Toaster Breaks** or Hot Pockets**	4 - 5 min.
Bagels	4½ - 5 min.
English Muffins	3½ - 4 min.
Cheese Sandwich	3½ - 4½ min

* Toasting times are approximate and should be used as a guide only.

** Brand names are registered trademarks of the respective manufacturers.



Oven Cooking

Broiling

To set Broil:

- Press the appropriate Broil pad.
 - BROIL, UPPER and SET flash.
- Press the Autoset pad **once** to set HI broil or **twice** to set LO broil.
 - HI or LO will be displayed.

Broil

Autoset

Select HI broil for normal broiling. Select LO broil for low-temperature broiling of longer cooking foods such as poultry.

- After four seconds, the oven will start.
 - BROIL and HI or LO will remain lit.



- For optimum browning, preheat broil element for 3-4 minutes before adding food.
- Place food in the oven. Leave oven door open about four inches (the first stop).
- Turn meat once while cooking.
- When food is cooked, press the CANCEL pad. Remove food and broiler pan from the oven.

CANCEL

Broil Notes:

- For best results when broiling, use a two-piece broiler pan.
- HI** broil is used for most broiling. Use **LO** broil when broiling longer cooking foods to allow them to cook to well done stage without excessive browning.
- Broil times may be longer when the lower broiling temperature is selected.
- Never cover broiler pan insert with aluminum foil. This prevents fat from draining to the pan below.
- Expect broil times to increase and browning to be slightly lighter if appliance is installed on a 208-volt circuit.
- If more than 30 seconds elapse between pressing the Broil pad and the Autoset pad, the oven will not be set and the display will return to the previous display.
- HI is used for most broiling. Use LO broil when broiling longer cooking foods. The lower temperature allows food to cook to the well done stage without excessive browning.
- Most foods should be turned halfway through broiling time.
- For additional broiling tips and temperatures, refer to the "Cooking Made Simple" booklet.

Broiling Chart - Broil times are based on a 4 minute preheat.

FOODS	UPPER OVEN RACK POSITION*	LOWER OVEN RACK POSITION*	SETTING	UPPER OVEN COOK TIME (MINUTES)**	LOWER OVEN COOK TIME (MINUTES)**
Beef Steak, 1" thick, 4 oz. Hamburgers, 3/4" thick (up to 12) 4 oz. Hamburgers, 3/4" thick (up to 6)	on rack on rack on rack	4 4 4	HI HI HI	8 - 11 (medium) 15 - 20 (well) 12 - 16 (well)	15 - 19 (medium) 15 - 19 (well) 15 - 19 (well)
Chicken Bone-in, skin-on breast Pieces	on rack	3 or 4	LO	25 - 36 (well)	28 - 39 (well)
Fish Filets Steaks, 1" thick	on rack on rack	4 4	LO LO	8 - 12 (flaky) 10 - 14 (flaky)	8 - 13 (flaky) 10 - 16 (flaky)
Pork Chops, 1" thick	on rack	4	HI	18 - 24 (well)	22 - 27 (well)

* When broiling fish, spray broil pan insert with cooking oil. Do not turn fish filets.

** Broiling times are approximate and may vary depending on the thickness of the food. Turn meat halfway through cooking times.



Oven Cooking

Keep Warm

For safely keeping hot foods warm or for warming breads and plates.

To set Keep Warm:

1. Press the appropriate Keep Warm pad.
 - WARM flashes.
 - 000 and either UPPER or LOWER flash in the display.
2. Select the Keep Warm temperature. Press the AutoseT pad or the appropriate number pads.
 - 170° will light when the AutoseT pad is pressed.
 - Each press of the AutoseT pad will increase the temperature by 5°.

Keep Warm

AutoseT

The Keep Warm temperature can be set from 145° to 190°.

WARM and the temperature will be displayed while the function is active.



To cancel Keep Warm:

1. Press the CANCEL pad.
2. Remove food from the oven.

CANCEL

Keep Warm Notes:

- For optimal food quality, oven cooked foods should be kept warm for no longer than 1 to 2 hours.
- To keep foods from drying, cover loosely with foil or a lid.
- **To warm dinner rolls:**
 - cover rolls loosely with foil and place in oven.
 - press Keep Warm and AutoseT pads.
 - warm for 12-15 minutes.
- **To warm plates:**
 - place 2 stacks of up to four plates each in the oven.
 - press Keep Warm and AutoseT pads.
 - warm for 5 minutes, turn off the oven and leave plates in the oven for 15 minutes more.
 - use only oven-safe plates, check with the manufacturer.
 - do not set warm dishes on a cold surface as rapid temperature changes could cause crazing or breakage.

Favorite

The Favorite pad allows you to save the time and temperature from a Cook & Hold Bake, Cook & Hold Convection Bake or Cook & Hold Convection Roast (lower oven only) operation.

To set a Favorite setting, a Cook & Hold function must be either active or just programmed.

To set a new Favorite operation or to save a currently running Cook & Hold as a Favorite:

1. Program a Cook & Hold setting as described in the Cook & Hold section on page 12.
2. Press and hold the Favorite pad for three seconds.
 - The newly set or currently running Cook & Hold setting will be saved.
 - A double then a single beep will sound to indicate that the control has accepted the Favorite setting.

Favorite

To start a cycle programmed into Favorite:

1. Press the Favorite pad.
 - Time and temperature for the set Cook & Hold setting will be displayed. (If no Cook & Hold setting has been programmed, "nonE" is displayed.)
2. Press the Bake, Convection Bake or Convection Roast (lower oven only) pad.
 - The Favorite setting will begin immediately.
 - The selected function will light in the display
 - The cooking time will light in the display

When the cooking time has elapsed:

- The selected function will turn off.
- WARM HOLD will light.
- 170° will display.

To cancel a Favorite setting in progress:

1. Press the CANCEL pad.
2. Remove food from the oven.
 - The stored Favorite setting will not be affected.

CANCEL



Oven Cooking

Automatic Shut-Off/Sabbath Mode

The ovens will automatically turn off after 12 hours if you accidentally leave them on.

To cancel the 12-hour shut-off and run an oven continuously for 72 hours:

1. Press and hold the Clock pad for three seconds **Clock**
 - “SAb” will be displayed and flash for five seconds.
 - “SAb” will then be displayed continuously until turned off or until the 72-hour time limit is reached.
 - BAKE will also be displayed if a bake setting is in use while the oven is in Sabbath Mode.
 - All pads are inactive except CANCEL and Clock. All other functions EXCEPT BAKE (Timer, Keep Warm, Clean, etc.) are locked out during the Sabbath Mode.

To cancel the Sabbath Mode:

1. Press the CLOCK pad for three seconds.
 - “SAb” will flash for five seconds.
 - The time of day will return to the display.
- OR
2. After 72 hours, the Sabbath Mode will end.
 - “SAb” will flash for five seconds.
 - The time of day will return to the display.

Clock

Adjusting the Oven Temperature

Oven temperatures are carefully tested for accuracy at the factory. It is normal to notice some baking or browning differences between a new oven and an old one. As ovens get older, the oven temperature can shift.

You may adjust the oven temperature if you think the oven is not baking or browning correctly. To decide how much to change the temperature, set the temperature 25 degrees higher or lower than your recipe recommends, then bake. The results of the first bake should give you an idea of how much to adjust the temperature.

To adjust the oven temperature:

1. Press the appropriate Bake pad. **Bake**
2. Enter 550° by pressing the appropriate number pads.
3. Press and hold the Bake pad for several seconds or until 00° appears in the display.

If the oven temperature was previously adjusted, the change will be displayed. For example, if the oven temperature was reduced by 15° the display will show “-15”.

4. Press the Autoset pad to adjust the temperature.

Each time the Autoset pad is pressed, the temperature changes by 5°. The oven temperature can be increased or decreased by 5° to 35°.

5. The time of day will automatically reappear in the display.

You do not need to readjust the oven temperature if there is a power failure or interruption. Temperature adjustment applies to Bake, Convection Bake and Convection Roast (lower oven only) only.

Sabbath Mode Notes:

- Sabbath Mode can be turned on at any time with or without the ovens on.
- Sabbath Mode cannot be turned on if the keypads are locked out or when the doors are locked.
- Most prompts and messages and all beeps are deactivated when Sabbath Mode is active.
- If an oven is baking when Sabbath Mode is set, BAKE will go out at the end of the baking cycle or when the CANCEL pad is pressed. There will be no audible beeps.
- If the oven lights are desired while in Sabbath Mode, they must be turned on before the Sabbath Mode is started.
- When the Sabbath Mode is started, the temperature display will immediately show the set temperature, rather than the actual oven cavity temperature. No preheat beep will sound.
- The self-clean cycle and automatic door lock do not operate during the Sabbath Mode.
- Pressing CANCEL pad will cancel a Bake cycle, however the control will stay in the Sabbath Mode.
- If power fails, the ovens will power up in Sabbath Mode with 72 hours remaining and no cycle active.



Oven Cooking

Oven Vent

When the oven is in use the area near the vent may become hot enough to cause burns. Never block the vent opening.

The oven vent is located below the backguard on your range.

When high moisture foods are cooked in the upper oven, steam may be visible coming from the oven vent. This is normal.

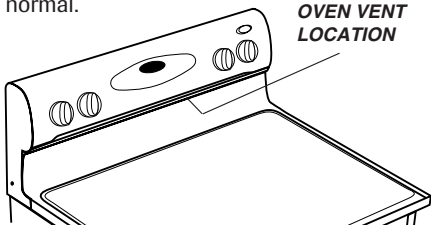

Do not place plastics near the vent opening as heat from the vent could distort or melt the plastic.

Oven Lights

The oven lights automatically come on whenever an oven door is opened. When the door is closed, press the Oven Light pad to turn the oven light on or off. A beep will sound every time the Oven Light pad is pressed.



Oven Bottom

Protect oven bottom against spillovers, especially acidic or sugary spills, as they may discolor the porcelain enamel. Use the correct pan size to avoid spillovers and boilovers. **Do not place utensils or aluminum foil directly on the oven bottom.**

Oven Fan

A convection fan is used to circulate hot air in the oven when the convection feature is selected. It automatically turns on after the Convection Bake or Convection Roast pads are pressed and will turn off when convection is canceled.

Note: The convection fans will automatically stop when the oven door is opened.

Oven Racks

! CAUTION

- Do not attempt to change the rack position when the oven is hot.
- Do not use the oven for storing food or cookware.

All racks are designed with a lock-stop edge.

Upper oven

- Is equipped with one rack and rack position.
- When pulling the upper oven rack out to remove or check food, grasp the **top edge** of the rack.

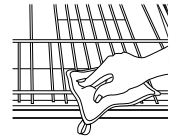

Lower oven

- Is equipped with one RollerGlide™ rack and two regular flat racks.

To remove oven racks:

- Pull rack straight out until it stops at the lock-stop position; lift up on the front of the rack and pull out.
- For RollerGlide™ rack, pull both the rack glide and rack base out together.

To replace oven racks:

- Place rack on the rack support in the oven; tilt the front end up slightly; slide rack back until it clears the lock-stop position; lower front and slide back into the oven.

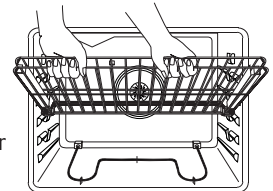

Baking and Roasting with the RollerGlide™ Rack (lower oven only)

Baking

- For optimal baking results when baking on one rack, use the RollerGlide™ rack.
- When baking on two racks, use the RollerGlide™ rack in the bottom rack position, and the flat rack in the upper rack position.

Roasting

- When roasting large cuts of meat and poultry, use the RollerGlide™ rack for ease of movement.



Oven Cooking

Rack Positions (lower oven)

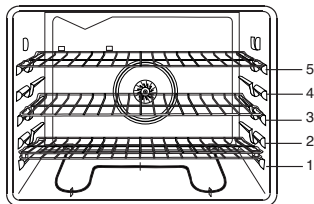

RACK 5: Use for toasting bread or broiling very thin foods and two-rack baking.

RACK 4: Use for two-rack baking and for broiling.

RACK 3: Use for most baked goods on a cookie sheet or jelly roll pan, layer cakes, fruit pies, or frozen convenience foods and for broiling.

RACK 2: Use for roasting small cuts of meat, casseroles, baking loaves of bread, bundt cakes or custard pies and two-rack baking.

RACK 1: Use for roasting large cuts of meat and poultry, frozen pies, dessert souffles or angel food cake and two-rack baking.

MULTIPLE RACK COOKING:

Two rack: Use rack positions 2 and 4, 1 and 4 or 2 and 5.

Three rack: Use rack positions 1, 3 and 5. See illustration above.

Baking Layer Cakes on Two Racks

For best results when baking cakes on two racks, use racks 2 and 4.

Place the cakes on the rack as shown.

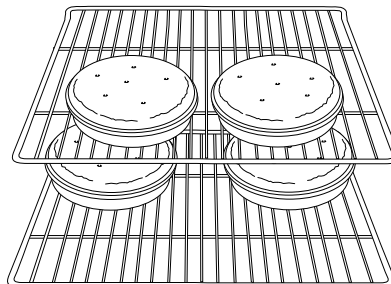

Half Rack Accessory

(Lower oven only)

A half rack, to increase oven capacity, is available as an accessory. It fits in the left, upper portion of the lower oven and provides space for a vegetable dish when a large roaster is on the lower rack. Contact your Maytag dealer for the "HALFRACK" Accessory Kit or call 1-877-232-6771 USA or 1-800-688-8408 Canada to order.

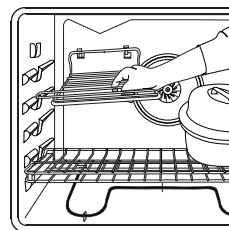

Cleaning Procedures

Care & Cleaning

Self-Clean Ovens

CAUTION

- It is normal for parts of the ovens to become hot during a self-clean cycle.
- To prevent damage to oven doors, do not attempt to open the doors when LOCK is displayed.
- Avoid touching doors, windows or oven vent area during a clean cycle.
- Do not use commercial oven cleaners on the oven finish or around any part of the ovens. They will damage the finish or parts.
- **Do not leave baking/pizza stone in the oven during self-clean.**

The self-clean cycle uses above-normal cooking temperatures to automatically clean the oven interior.

It is normal for flare-ups, smoking, or flaming to occur during cleaning if the oven is heavily soiled. It is better to clean the oven regularly rather than to wait until there is a heavy build-up of soil in the oven.

During the cleaning process, the kitchen should be well ventilated to get rid of normal odors associated with cleaning.

Before Self-Cleaning

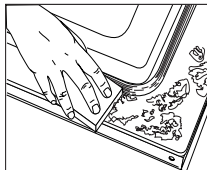

1. Turn off the oven light before cleaning as the light may burn out during the clean cycle.
2. Remove broiler pan, all pans, and oven racks from the oven. The oven racks will discolor and may not slide easily after a self-clean cycle if they are not removed.
3. Clean oven frame, door frame (area outside of gasket, and around the opening in the door gasket) with a nonabrasive cleaner such as Bon Ami* or detergent and water. The self-cleaning process does not clean these areas. They should be cleaned to prevent soil from baking on during the clean cycle. (The gasket is the seal around the oven door and window.)
4. To prevent damage, do not clean or rub the gasket around the oven door. The gasket is designed to seal in heat during the clean cycle.
5. Wipe up excess grease or spillovers from the oven bottom. This prevents excessive smoking, flare-ups or flaming during the clean cycle.
6. Wipe up sugary and acidic spillovers such as sweet potatoes, tomato, or milk-based sauces. Porcelain enamel

is acid-resistant, not acid-proof. The porcelain finish may discolor if acidic or sugary spills are not wiped up before a self-clean cycle.

Notes:

- Oven temperature must be below 400° F to program a clean cycle.
- **Only one oven can be cleaned at a time.**
- Both oven doors lock when either oven is being cleaned.



To set Self-Clean:

1. Close the oven door.
2. Press the Clean pad.
 - CLEAN flashes.
 - SET and UPPER or LOWER flash in the display.
3. Press the Autoset pad.
 - "MEd" (Medium Soil, 3 hours) is displayed.
4. Press the Autoset pad to scroll through the self-cleaning settings.
 - "HVy" (Heavy Soil, 4 hours)
 - "MEd" (Medium soil, 3 hours)
 - "LITE" (Light Soil, 2 hours)

Choosing the soil level of the oven automatically programs the self-cleaning time.

5. After four seconds, the oven will start cleaning.
 - If the door is not closed, beeps will sound and 'door' will display. If the door is not closed within 30 seconds, the self-cleaning operation will be canceled and the display will return to the time of day.
 - CLEAN will appear in the display.
 - LOCK will flash in the display. Once the door locks, LOCK will remain steady.
 - The cleaning time will start counting down in the display.

To Delay a Self-Clean Cycle:

1. Press the Delay pad **once** for upper oven and **twice** for lower oven.
 - DELAY flashes.
 - 00:00 and UPPER or LOWER will flash in the display.
2. Enter the amount of time you want to delay the cycle using the appropriate number pads.
3. Press the appropriate Clean pad.
 - SET flashes in the display.

* Brand names for cleaning products are registered trademarks of the respective manufacturers.

Cleaning Procedures



Care & Cleaning

4. Press the Autoset pad.

- “LITE” (Light soil level) is displayed.

Autoset

5. Press the Autoset pad to scroll through the self-cleaning settings.

“HVY” (Heavy Soil, 4 hours)

“MED” (Medium Soil, 3 hours)

“LITE” (Light Soil, 2 hours)

Choosing the soil level of the oven automatically programs the self-cleaning time.

6. After four seconds, CLEAN, DELAY and UPPER or LOWER will light and LOCK will flash in the display. When the oven door latches, LOCK will stop flashing and light continuously to show that the oven is set for a delayed clean operation. The delay time will display.



During the Self-Clean Cycle

When LOCK shows in the display, both oven doors are locked. To prevent damage to the doors, do not force the doors open when LOCK is displayed.

Smoke and Smells

You may see some smoke and smell an odor the first few times the oven is cleaned. This is normal and will lessen in time.

Smoke may also occur if the oven is heavily soiled or if a broiler pan was left in the oven.

Sounds

As the oven heats, you may hear sounds of metal parts expanding and contracting. This is normal and will not damage the oven.

After Self-Cleaning

About one hour after the end of the self-clean cycle, LOCK will turn off. The doors can then be opened.

Some soil may leave a light gray, powdery ash. Remove it with a damp cloth. If soil remains after wiping, that means the clean cycle was not long enough. The soil will be removed during the next clean cycle.

If oven racks were left in the oven and do not slide smoothly after a clean cycle, wipe racks and rack supports with a small amount of vegetable oil to make them easier to move.

Fine lines may appear in the porcelain because it went through heating and cooling. This is normal and will not affect performance.

A white discoloration may appear after cleaning if acidic or sugary foods were not wiped up before the self-clean cycle. This discoloration is normal and will not affect performance.

Self-Clean Notes:

- If an oven door is left open, “door” will appear in the display and a signal will beep until the door is closed and the Clean pad is pressed again.
- If more than 30 seconds elapse between pressing the Clean pad and the Autoset pad, the program will automatically return to the previous display.
- The oven doors will be damaged if the oven doors are forced to open when LOCK is still displayed.

Cleaning Procedures



Cleaning Procedures

! CAUTION

- Be sure appliance is off and all parts are cool before handling or cleaning. This is to avoid damage and possible burns.
- To prevent staining or discoloration, clean appliance after each use.
- If a part is removed, be sure it is correctly replaced.

* Brand names are registered trademarks of the respective manufacturers.

** To order call 1-877-232-6771 USA and 1-800-688-8408 Canada.

PART	PROCEDURE
Backguard and Cooktop – Porcelain Enamel	<p>Porcelain enamel is glass fused on metal and may crack or chip with misuse. It is acid resistant, not acid proof. All spillovers, especially acidic or sugary spillovers, should be wiped up immediately with a dry cloth.</p> <ul style="list-style-type: none"> • When cool, wash with soapy water, rinse and dry. • Never wipe off a warm or hot surface with a damp cloth. This may cause cracking or chipping. • Never use oven cleaners, abrasive or caustic cleaning agents on exterior finish of range.
Broiler Pan and Insert	<p>Never cover insert with aluminum foil as this prevents the fat from draining to the pan below.</p> <ul style="list-style-type: none"> • Place soapy cloth over insert and pan; let soak to loosen soil. • Wash in warm soapy water. Use scouring pad to remove stubborn soil. • Broiler pan and insert can be cleaned in dishwasher.
Clock and Control Pad Area	<ul style="list-style-type: none"> • To activate “Control Lock” for cleaning, see page 9. • Wipe with a damp cloth and dry. Do not use abrasive cleaning agents as they may scratch the surface. • Glass cleaners may be used if sprayed on a cloth first. DO NOT spray directly on control pad and display area.
Control Knobs	<ul style="list-style-type: none"> • Remove knobs in the OFF position by pulling forward. • Wash, rinse and dry. Do not use abrasive cleaning agents as they may scratch the finish. • Turn on each element to be sure the knobs have been correctly replaced.
Cooktop – Glass-Ceramic	<p>Never use oven cleaners, chlorine bleach, ammonia or glass cleaners with ammonia. NOTE: Call an authorized servicer if the glass-ceramic top should crack, break or if metal or aluminum foil should melt on the cooktop.</p> <ul style="list-style-type: none"> • Allow the cooktop to cool before cleaning. • General – Clean cooktop after each use, or when needed, with a damp paper towel and Cooktop Cleaning Creme* (Part No. 20000001)**. Then, buff with a clean dry cloth. <p>NOTE: Permanent stains will develop if soil is allowed to cook on by repeatedly using the cooktop when soiled.</p> <ul style="list-style-type: none"> • Heavy Soils or Metal Marks – Dampen a “scratchless” or “never scratch” scrubber sponge. Apply Cooktop Cleaning Creme* (Part No. 20000001)** and scrub to remove as much soil as possible. Apply a thin layer of the creme over the soil, cover with a damp paper towel and let stand 30 to 45 minutes (2-3 hours for very heavy soil). Keep moist by covering the paper towel with plastic wrap. Scrub again, then buff with a clean dry cloth. <p>NOTE: Only use a CLEAN, DAMP “scratchless” pad that is safe for non-stick cookware. The pattern and glass will be damaged if the pad is not damp, if the pad is soiled, or if another type of pad is used.</p> <ul style="list-style-type: none"> • Burned-on or Crusty Soils – Scrub with a “scratchless” or “never scratch” scouring pad and Cooktop Cleaning Creme*. <p>NOTE: Hold a razor blade scraper at 30° angle and scrape any remaining soil. Then, clean as described above. Do not use the razor blade for daily cleaning as it may wear the pattern on the glass.</p> <ul style="list-style-type: none"> • Melted Sugar or Plastic – Immediately turn element to LOW and scrape sugar or plastic from hot surface to a cool area. Then turn element OFF and allow to cool. Clean residue with razor blade scraper and Cooktop Cleaning Creme*. 

Cleaning Procedures



Care & Cleaning

PART	PROCEDURE
Oven Windows and Doors – Glass	<ul style="list-style-type: none"> • Avoid using excessive amounts of water which may seep under or behind glass causing staining. • Wash with soap and water. Rinse with clear water and dry. Glass cleaner can be used if sprayed on a cloth first. • Do not use abrasive materials such as scouring pads, steel wool or powdered cleaners as they will scratch glass.
Oven Interiors	<ul style="list-style-type: none"> • Follow instructions on pages 19-20 to set a self-clean cycle.
Oven Racks	<ul style="list-style-type: none"> • Clean with soapy water. • Remove stubborn soil with cleansing powder or soap-filled scouring pad. Rinse and dry. • Racks will permanently discolor and may not slide smoothly if left in the oven during a self-clean operation. If this occurs, wipe the rack edge and rack support with a small amount of vegetable oil to restore ease of movement, then wipe off excess oil.
Stainless Steel (select models)	<ul style="list-style-type: none"> • DO NOT USE ANY CLEANING PRODUCT CONTAINING CHLORINE BLEACH. • DO NOT USE ABRASIVE OR ORANGE CLEANERS. • ALWAYS WIPE WITH THE GRAIN WHEN CLEANING. • Daily Cleaning/Light Soil -- Wipe with one of the following - soapy water, white vinegar/water solution, Formula 409 Glass and Surface Cleaner* or a similar glass cleaner - using a sponge or soft cloth. Rinse and dry. To polish and help prevent fingerprints, follow with Stainless Steel Magic Spray (Part No. 20000008)**. • Moderate/Heavy Soil -- Wipe with one of the following - Bon Ami, Smart Cleanser, or Soft Scrub* - using a damp sponge or soft cloth. Rinse and dry. Stubborn soils may be removed with a damp multi-purpose Scotch-Brite* pad; rub evenly with the grain. Rinse and dry. To restore luster and remove streaks, follow with Stainless Steel Magic Spray*. • Discoloration -- Using a damp sponge or soft cloth, wipe with Cameo Stainless Steel Cleaner*. Rinse immediately and dry. To remove streaks and restore luster, follow with Stainless Steel Magic Spray*.
Door Handle, Side Panels – Painted Enamel	<ul style="list-style-type: none"> • When cool, wash with warm soapy water, rinse and dry. Never wipe a warm or hot surface with a damp cloth as this may damage the surface and may cause a steam burn. • For stubborn soil, use mildly abrasive cleaning agents such as baking soda paste or Bon Ami.* Do not use abrasive, caustic or harsh cleaning agents such as steel wool pads or oven cleaners. These products will scratch or permanently damage the surface. <p>NOTE: Use a dry towel or cloth to wipe up spills, especially acidic or sugary spills. Surface may discolor or dull if soil is not immediately removed. This is especially important for white surfaces.</p>

* Brand names for cleaning products are registered trademarks of the respective manufacturers.

** To order direct, call 1-877-232-6771 USA and 1-800-688-8408 Canada.

Free Manuals Download Website

<http://myh66.com>

<http://usermanuals.us>

<http://www.somanuals.com>

<http://www.4manuals.cc>

<http://www.manual-lib.com>

<http://www.404manual.com>

<http://www.luxmanual.com>

<http://aubethermostatmanual.com>

Golf course search by state

<http://golfingnear.com>

Email search by domain

<http://emailbydomain.com>

Auto manuals search

<http://auto.somanuals.com>

TV manuals search

<http://tv.somanuals.com>