

USER'S GUIDE

Welcome 1

Safety Instructions..... 2

Loading 3

Dishwashing Essentials (Hot water, Detergent, Rinse Aid)..... 6

Cycles at a Glance..... 7

Operating Tips 8

Water Conditions 10

Special Care Items 11

Maintaining the Dishwasher 12

Before You Call..... 13-14

Warranty Back Cover

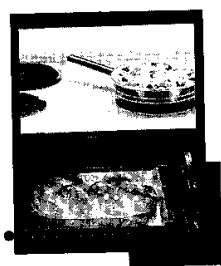
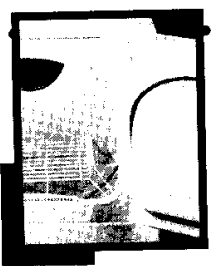

KEEP THESE INSTRUCTIONS FOR FUTURE REFERENCE

ynload.



Models: MDB6000

Welcome.....



Congratulations on your choice of a Maytag Jetclean® dishwasher! As you use your new appliance you will appreciate the many features that have made it the Consumer Rated No. 1 Dishwasher.

Your satisfaction is very important to us, so please read this guide carefully. You will find instructions on the proper operation and maintenance of your new appliance.

Enjoy your new dishwasher and thank you for choosing Maytag!



Save time and money. If something should go wrong, we suggest consulting the “Before You Call” section in the back of this book. It is designed to help you solve basic problems before consulting a servicer.

However, should you need assistance in the future, it is helpful to:

1) Have complete model and serial number identification of your dishwasher. This is located on the upper left of the tub opening.

Record these numbers below for easy access.

Model Number

Serial Number

2) Have proof of original date of purchase.

Please attach your sales receipt here for this information for your records (in case you ever need warranty service).

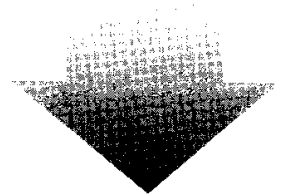

For additional questions, please contact us:

Maytag Appliances Sales Company
Attn: CAIRSM Center
P.O. Box 2370
Cleveland, TN 37320-2370
1-800-688-9900 USA
1-800-688-2002 CANADA
1-800-688-2080 USA TTY (for deaf, hearing impaired or speech impaired)
(Mon.-Fri., 8am-8pm Eastern Time)
Internet: <http://www.maytag.com>

⚠ WARNING: Check with the installer to make sure the appliance has been properly grounded to avoid possible electrical shock. Be sure you read the Personal Safety Instructions on page 2 before using this dishwasher.

Note: In our continuing effort to improve the quality of our dishwashers, it may be necessary to make changes to the appliance without revising this guide.

Important Safety Instructions

Products with a  label have been listed with Underwriter's Laboratories, Inc. – those with a CSA tag have been listed with Canadian Standards Association. Nevertheless, as with any other equipment using electricity and moving parts, there is a potential hazard.

 **WARNING** – When using your dishwasher, follow basic precautions, including the following:

1. Read all instructions before using the dishwasher.
2. Use the dishwasher only for its intended function.
3. Disconnect electrical power to dishwasher before attempting to service.
4. To avoid electrical shock hazard, the sides and back must be enclosed and the front panels must be attached before electrical power is applied to the dishwasher. Refer to the installation instructions for proper grounding procedures.
5. Connect to a properly rated, protected and sized power supply circuit to avoid electrical overload.
6. Children should never be permitted to operate, or play in, with, or around this dishwasher.
7. To reduce the risk of injury when loading items to be washed, sharp or pointed items should be located with the handles up. Also, load sharp items so they are not likely to damage the door seal.
8. Be careful not to touch the heating element on the bottom of the tub during or at the completion of cycle. It may be hot.
9. Use only detergents and rinse additives designed for an automatic dishwasher. Never use soap, laundry detergent, or hand washing detergent in your dishwasher. Keep these products out of reach of children.
10. Do not sit, stand on or abuse the door or dish rack of the dishwasher.
11. Under certain conditions, hydrogen gas may be produced in a hot water system that has not been used for two weeks or more. **Hydrogen gas is explosive.** If the hot water system has not been used for such a period, turn on all hot water faucets and let the water flow from each for several minutes. This will release any accumulated hydrogen gas. As the gas is flammable, do not smoke or use an open flame during this process.
12. Do not wash plastic items unless marked “dishwasher safe” or the equivalent. For plastic items not so marked, check the manufacturer’s recommendations.
13. Do not tamper with controls.
14. Always remove the door to the washing compartment when removing an old dishwasher from service or discarding it.
15. Use caution when unloading the dishwasher. Dishes will be hot if unloaded shortly after a cycle has completed.

Save These Instructions



Loading

Before You Start

- **Don't Prerinse.** Simply scrape off any bones or large food particles. The disposer in your dishwasher will handle the occasional pits, fruit seeds and popcorn. These items will be chopped into small pieces during the drain and removed with the drain water. You may hear a chopping noise during the drain. This is normal.
- If connected to a food waste disposer, **make certain the disposer is empty before starting the dishwasher.** This allows proper draining.
- **Scrape off large amount of tomato-based food soils** (see page 12).

- **Remove certain foods** (such as mustard, mayonnaise, lemon juice, vinegar, salt or dressings) **from steel flatware as soon as possible.** These foods cause rusting and pitting if allowed to remain in contact with the surface for an extended period of time.
- **Scrape or soak items with burnt on foods** such as broiled meats, require more energy than the rest of the load to clean satisfactorily.
- **Soak or wipe a starchy film from utensils** such as those used to cook foods such as potatoes, pasta, rice, oatmeal, etc. as they require more energy than the rest of the load to clean satisfactorily.

General Recommendations

- Place all items in the racks so they are separated and facing center. This ensures the water spray can reach soiled surfaces for good washing and rinsing results.
- Wedge flat, lightweight items (such as plastic lids) next to the silverware basket or along the sides and back of the racks.
- Items can be centered behind a single tine or loaded at an angle to maximize space.

- Load items so they do not rest over the top of the lower rack. This water spray is needed to properly clean items in the upper rack.
- Avoid blocking the upper and lower spray arms by allowing items to extend beyond the racks.
- Caution: Dishes will be hot if unloaded shortly after the cycle is completed.

Your new Maytag® dishwasher is designed to accommodate a variety of dishes, glasses, stemware, utensils and pans. It also has the capacity to accommodate 10 to 12 place settings, with some Maytag® models able to accommodate up to 13 place settings. The following illustrations and information will help you become more familiar with your dishwasher racking system. After a few dishloads, you will be able to determine the best arrangement for your items.

How to Load 10 Place Settings

Upper Rack

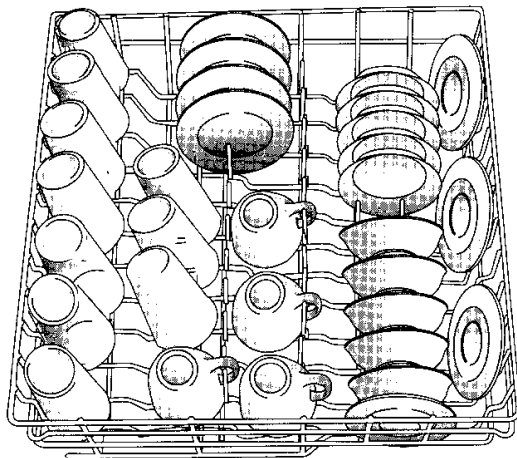

Lower Rack

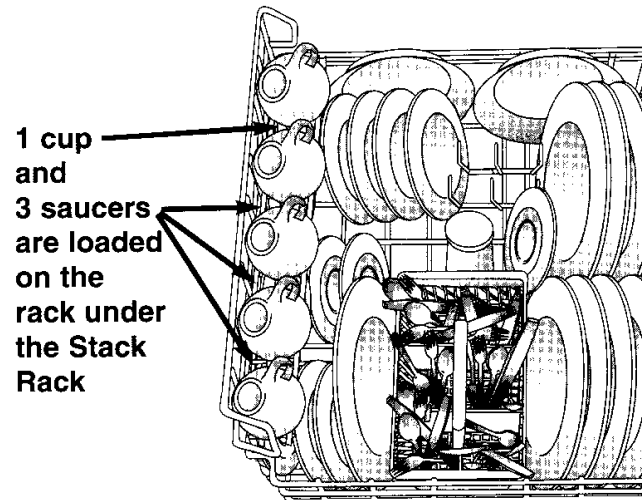



Upper Rack

(Features vary depending on model)

The upper rack is designed with flexibility and versatility. Glasses, cups, stemware, light-weight plastics, small plates, bowls, pans, long-handled utensils etc. can be loaded in this rack. **Do not load glasses over the tines.**

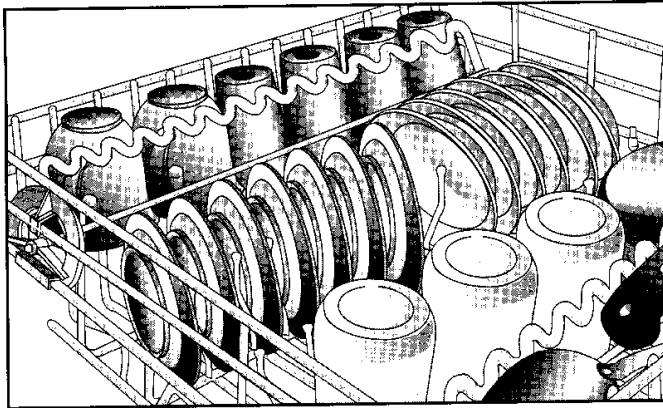

The Vari-Lock™ Snugger on the left (certain models) secures lightweight items in place. It can be adjusted by grasping the curved wire and rotating it left to snug items against the outer rack or to the right to rest on top of light items. **Do not load items on top of the wire.**

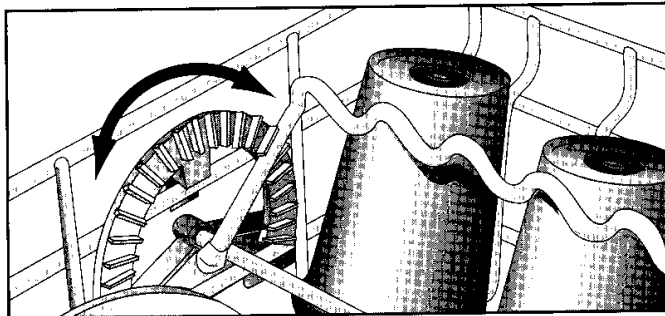

The curved wire on the Vari-Lock™ Snugger (left) and the Stack-Rack (right) is designed to hold stemware in place. Taller stemware will fit better on the right side as the upper rack is deeper on this side.

Correct

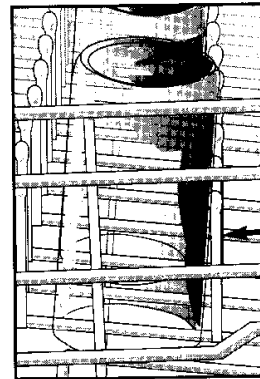

Incorrect

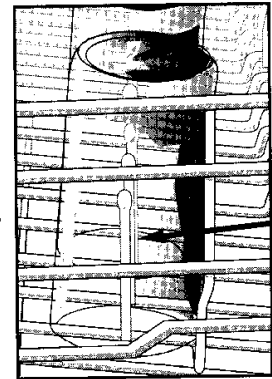

Tine out

The Stack-Rack (certain models) design on the right side of the upper rack folds up or down for loading flexibility of a variety of items. Fold it down to hold long-handled knives, spatulas and spoons or short items like cups or juice glasses. Fold it up for taller items like glasses, bowls, plates, etc.

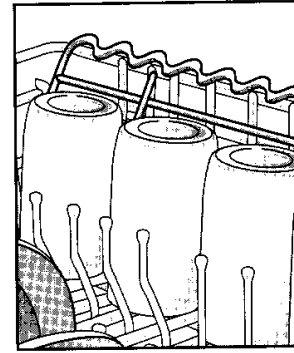
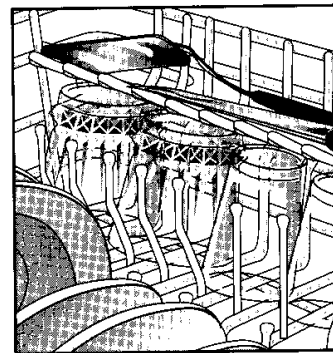

Lower Rack

Removable Utensil Basket

(Design varies depending on model)

The basket can be removed for easy loading and unloading. Place items in the basket with some handles up and some down. This prevents them from nesting together and improves cleaning results. (Knives or sharp, pointed items should be placed in the basket with the handles up. Be sure thin, finely pointed items do not extend through the basket and block the lower wash arm.)

Use the covered section of the basket for small, light-weight items like baby spoons, plastic measuring spoons, small plastic items, etc. Close the cover.

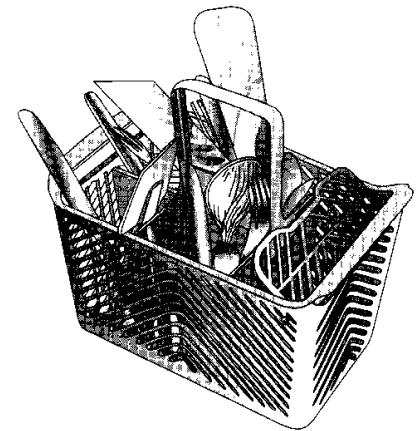



Lower Rack

(Features vary depending on model)

The lower rack is designed to accommodate a variety of large items such as dinner plates, mixing bowls, pots and pans, baking dishes, etc.

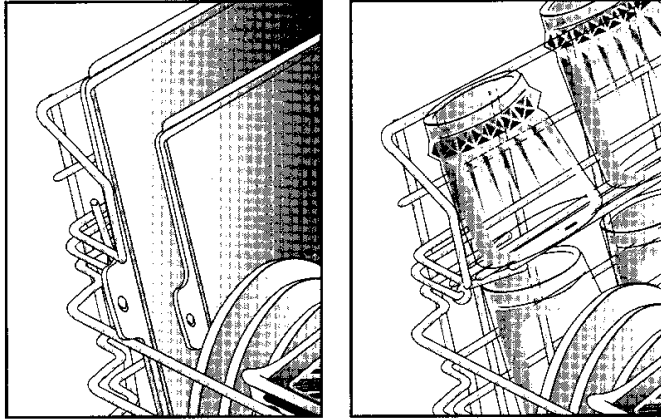

With the **Stack-Rack shelf** raised, thin items like cookie sheets or pizza pans may be placed along the side. With the shelf down, two levels of glasses can also be loaded.

Tall items such as bakeware and large platters can be placed on the left side or across the back of this rack.

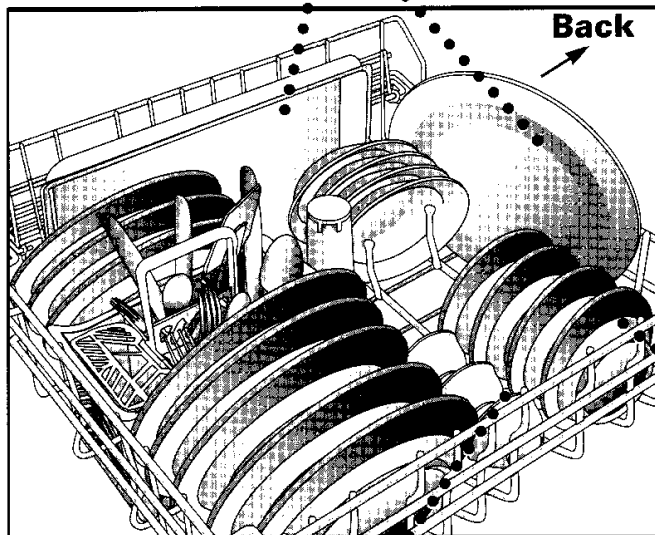

Create-A-Space™ tines are located across the center of the lower rack to the left and right of the center spray nozzle. These allow small saucers to be loaded between rows of plates and/or bowls.

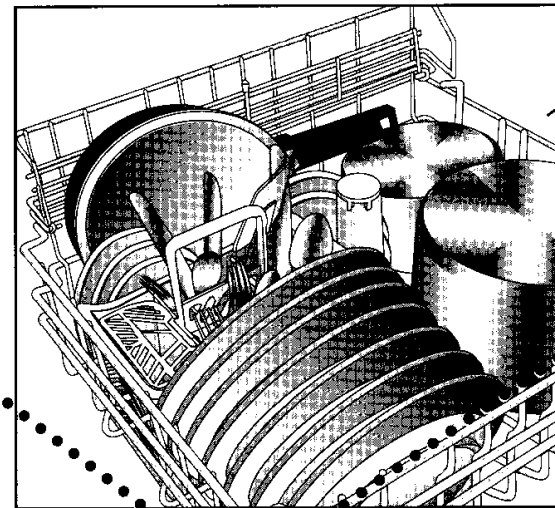

Convertible tines in the back-right corner can be adjusted to provide narrow spacing for loading deep bowls, pots or pans.



Dishwashing Essentials.....

HOT Water

For optimal cleaning and drying results, hot water is necessary. The incoming water temperature should be 120–140° F to properly activate the detergent and melt greasy food soils.

If for any reason (such as laundering, showers, etc.) the incoming water temperature is below 120° F (49° C), select the **Temp Sense** option to have the dishwasher thermostatically heat the water to the proper temperature.

Detergent

Use a detergent designed specifically for use in an automatic dishwasher. Be sure it is fresh and stored in a cool, dry place (not under the sink).

Recommended Amount

The amount of detergent to use depends on the water hardness (measured in grains per gallon — gpg) and the amount of soil on the dishes. Too little detergent results in poor cleaning, hard water filming/spotting and poor drying. Too much detergent can cause permanent etching/cloudiness.

As a rule, use 1 teaspoon of detergent per grain of water hardness, using a minimum of 3 teaspoons in soft water situations. Place the recommended amount of detergent in both cups for Normal and longer cycles. **Do not divide the recommended amount between the cups.**

The following chart includes specific recommendations. Each line in the detergent cup represents 3 teaspoons.

Water Hardness*	Detergent Use
Soft (0–3 gpg)	3 teaspoons
Medium (4–9 gpg)	4–9 teaspoons
Hard (10–12 gpg)	10–12 teaspoons

**Your local water utility or state university extension service can tell you the degree of water hardness in your area.*

For water hardness of 13–14 gpg add more detergent (1 teaspoon for each gpg above 12) to the beginning of the main wash portion of the cycle. Unlatch the door, open it slowly and add detergent to the bottom of the tub. After relatching the door, the dishwasher will continue through the cycle.

If water hardness is 15 gpg or harder, it is difficult to achieve good results with **any** dishwasher. The solution is a mechanical water softener to improve water quality, detergent effectiveness, and protect the dishwasher parts from the damage that hard water deposits can cause.

To check the incoming water temperature, turn on the hot water faucet nearest the dishwasher and let it run for a few minutes. Place a candy thermometer in the glass and check the temperature once it has stopped rising. If the temperature is below 120° F (49° C), have a qualified person raise the water heater thermostat setting.

Before starting the dishwasher, turn on the hot water faucet and let it run until the water is hot.

Never use laundry detergent or hand dishwashing detergent in your dishwasher as it will cause severe oversudsing and possible leaks.

Detergent Placement

Add detergent to the detergent cup just before starting the cycle.

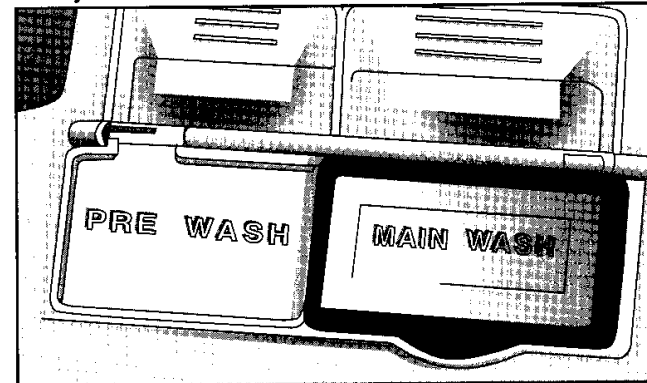

For the **Normal*** or **Light*** cycle, place the recommended amount of detergent in both the PRE WASH and MAIN WASH cups. Close the cover. The dishwasher automatically releases detergent.

The **China/Crystal** cycle requires detergent in the MAIN WASH cup only. Close the cover after adding detergent. The detergent will dispense automatically.

The **Quick Wash/Rinse** cycle needs detergent in the PRE WASH cup only. Close the cover after adding detergent. The detergent will dispense automatically.

Do not use detergent with the **Rinse & Hold** cycle. Leave the detergent cup lid open when running Rinse & Hold.

**When using the IntelliClean™ option:*

If dishes are **not** prerinsed, place proper amount of detergent in both PRE WASH and MAIN WASH cups. If dishes **are** prerinsed, add detergent only to the MAIN WASH cup. Close the cover.



Rinse Aid

Regular use of a rinse aid improves drying, reduces spotting and filming, and reduces moisture left on the dishwasher interior.

Your Maytag Jetclean® dishwasher features an automatic rinse aid dispenser located near the detergent cups in the door.

The clear window in the center of the dispenser cap allows you to see if there is rinse aid in the reservoir. When the window is colored, there is rinse aid in the dispenser. When the window becomes clear, it is time to refill the dispenser. (As a guide, check the dispenser monthly.)

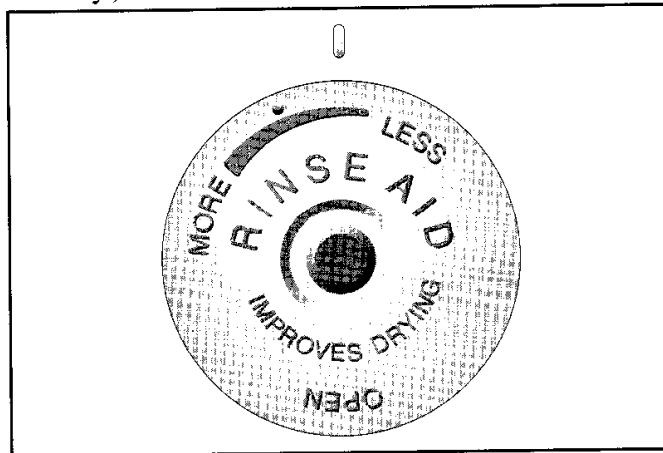

Usage Tips

- **Use HOT Water**
Hot water dissolves and activates the detergent, dissolves grease from the load and improves drying results. Refer to page 6 for more information.
- **Use the Proper Amount of Detergent**
For best soil removal, good drying results and prevention of filming, etching and spotting, the proper amount of detergent must be used. Refer to page 6 for recommended amounts.
- **Use a Rinse Aid**
Regular use of a rinse aid improves drying results and reduces spotting and filming. See above for more information.
- **Load the Dishwasher Properly**
To ensure soiled surfaces get adequate wash action, carefully follow the loading instructions on pages 3–5.

To add rinse aid to the dispenser, turn the cap clockwise to open. Remove the cap and pour rinse aid into the opening. Replace the cap and turn clockwise.

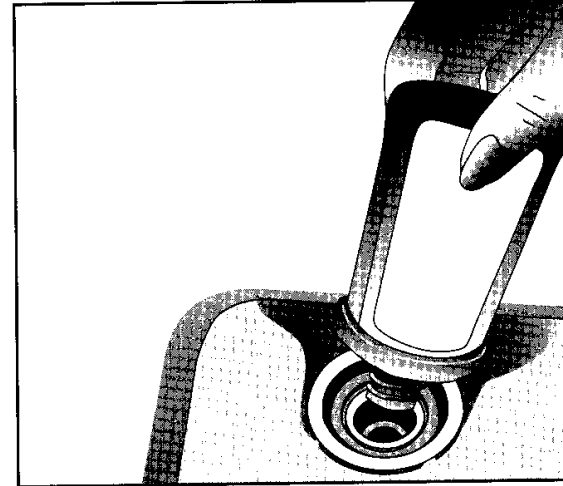

An adjustable cap found on some models allows you to adjust the amount of rinse aid dispensed. A window on the cap indicates the recommended initial setting. Typically, use the LESS setting for soft water and the MORE setting for hard water. Set the cap between these amounts as needed. To improve drying, turn the cap towards the MORE setting. When adjusting or replacing the cap, be sure it is securely in place before closing the dishwasher door.

• Select the Proper Cycle

The cycle selection depends on the amount of soil on the load. See page 8 for cycle descriptions.

• Select Heated Dry

For improved drying select Heated Dry.

Energy Saving Tips

- Don't prerinse!
- Wash full loads. The same amount of electricity and water are used.
- Load correctly for best washing results.
- Operate the dishwasher during off-peak hours. Check your local utility for rates.



Cycles at a Glance.....

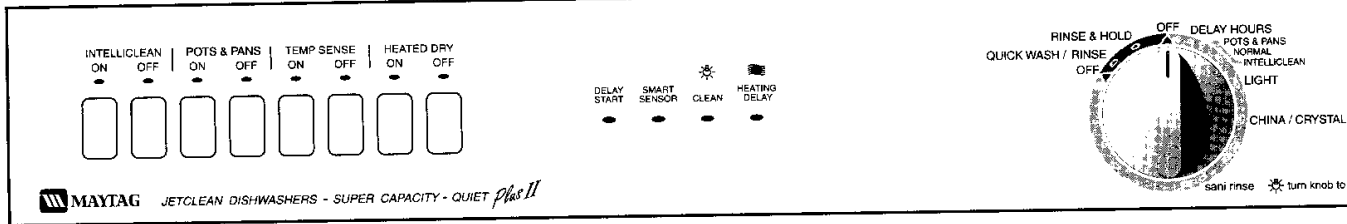

Your dishwasher is designed with technology that *automatically determines the proper number of water fills needed to clean your dishes*. Select IntelliClean™ ON when setting the control knob at Normal or Light. This automatically adjusts the number of drains and fills based on the soil level of the load. Water can be saved because there are no unnecessary drains and fills when the dishes are already clean! This dishwasher also still provides you with the ability to select the specific cycle and/or option of your choice.

Cycles

Located around the knob on the right side of the panel.

CYCLE OPTIONS	SEQUENCE	WATER USAGE
<p>*Normal with IntelliClean ON is designed for washing loads containing dishes with heavy or normal food soils.</p>	<p>Prewash *Sensor check Prerinse *Sensor check Main Wash Prerinse Hi-Temp Rinse Dry</p>	<p>10.4 Gal. (the IntelliClean™ option may decrease water usage to as low as 6.2 gal.)</p>
<p>Light with IntelliClean ON is designed to wash loads containing dishes with lighter amounts of food soils.</p>	<p>Prewash *Sensor check Main Wash Prerinse Hi-Temp Rinse Dry</p>	<p>8.3 Gal. (the IntelliClean™ option may decrease water usage to as low as 6.2 gal.)</p>
<p>China/Crystal is designed for washing crystal, china or lightly soiled dishes.</p>	<p>Main Wash Prerinse Hi-Temp Rinse Dry</p>	<p>6.2 Gal.</p>
<p>Quick Wash/Rinse is designed for use when lightly soiled dishes are needed in a hurry.</p>	<p>Wash Rinse</p>	<p>4.4 Gal.</p>
<p>Rinse & Hold rinses dishes being held until the dishwasher is full. This cycle helps reduce the potential for odors to develop.</p>	<p>Rinse</p>	<p>2.0 Gal.</p>

* Manufacturer's recommended cycle choice.

Delay Start allows you to set the dishwasher to operate at a more convenient time or during off-peak energy rate hours. Simply turn the knob to the desired number of delay hours and latch the door.

IntelliClean™ Option

utilizes a sensor to customize the number of water fills needed for the cycle. This sensor interprets the soil level and assesses the need for a drain and refill of water. While the sensor is making this decision, there is a pause of approximately 4 minutes and the **SMART SENSOR** light is illuminated. Depending on the decision made by the sensor, you may or may not hear a drain and refill during this pause.

Select **IntelliClean ON** when setting the control knob to either the Normal or Light cycle.

Normal with IntelliClean ON has two pauses for water checks, one at the end of the prewash and one at the end of the prerinse portions of the cycle.

Light with IntelliClean ON has one pause for a water check. This occurs at the end of the prewash portion of the cycle.

IntelliClean OFF turns off the **SMART SENSOR** light. The Normal and Light cycles will function with the predetermined number of drains, fills and water usage.

Note: The IntelliClean™ sensor in the pump motor must stay submerged, so a short fill of water is added at the last drain in the cycle.

Other Options

Pots & Pans ON checks the main wash and final rinse temperature. If needed, the cycle is interrupted to heat water to the proper temperature and the **HEATING DELAY** light is illuminated.

Pots & Pans provides additional heated dry time. The Pots & Pans option does NOT add heated dry time in Quick Wash/Rinse.

Note: Use Pots & Pans to aid in the removal of tough, difficult food soils (such as starches and fats) and to boost drying.

Pots & Pans OFF cancels the water temperature checks and the additional heated dry time.

Temp Sense ON ensures proper water temperature in the Normal, Light, and China/Crystal cycles. If necessary, the cycle is extended until proper water temperature is reached. When either the wash or rinse portions of the cycle is being extended, the HEATING DELAY light is illuminated.

Note: Use this option if the incoming water temperature is below 120°F due to other demands as showers and laundry.

Temp Sense OFF cancels the water temperature checks in the main wash and rinse.

Heated Dry ON improves drying results by turning on the heating element during the dry portion of the cycle.

Heated Dry OFF turns the heating element off during the dry portion of the cycle. Towel drying of some items may be necessary with this selection and more moisture may be noticed on the dishwasher interior.

Note: With either dry option, it is normal to have some steam or vapor coming out of the vent area.



Operating Tips

Starting The Dishwasher

- 1 After loading the dishwasher and adding detergent, set the control knob to the desired cycle and press the appropriate option button(s).

Note: When the control knob is set at Normal or Light, IntelleClean ON should be selected.

- 2 Run the water from the hot water tap to clear the line of cold water before starting.
- 3 Press the door until it latches. **The cycle will begin with a drain prior to fill.**

Note: Water heating and dry options can be used separately or together. To make a selection, press the corresponding on/off button.

Adding a Forgotten Item

For best cleaning, the forgotten item should be added early in the cycle.

- 1 Unlatch the door.
- 2 Wait for the water circulation to stop.
- 3 Open the door and add the item.
- 4 Close and latch the door.
- 5 The cycle resumes automatically.

Indicator Lights

Delay Start illuminates when this option is selected. The light stays on until the start of the cycle.

Smart Sensor illuminates after the prerinse and prewash in the IntelliClean™ cycle option. During this time, the dishwasher will either hold or drain its present water fill.

Clean illuminates at the end of the dry cycle and remains lit until the control knob has been advanced to OFF.

Heating Delay illuminates to indicate that the cycle is being extended to heat the water to the proper temperature. The location of the  symbol around the control knob corresponds to the heating delay of the cycle.

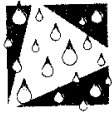

Water Conditions.....

Hard Water contains minerals that can cause a film or deposit on the dishwasher tub and dishes. You may first notice this as “cloudy” glasses. **To confirm if the film is removable, soak a glass for approximately 5 minutes in undiluted white vinegar. Rinse and dry. If the film is removed, it is probably due to hard water (if not removed, see Soft Water).**

To correct:

1. Adjust the detergent amount to the degree of water hardness. (See pg. 6)
2. Check the water temperature. (See pg. 6)
3. Use a rinse aid to improve the sheeting action of the water. (See pg. 7)
4. See page 14 for further information if, after following the above guidelines, wash results are still not satisfactory.

Soft Water can promote etching if too much detergent is used, items are prerinsed or the water temperature is high. Etching is a permanent pitting or eroding of the surface of the glassware.

The beginning stages can be identified by a “rainbow” effect— shades of blue, purple, brown or pink when the glass is held at an angle to the light. In advanced stages the surface appears frosted, spotted or cloudy.

Etching can happen in any dishwasher and there is no relationship to the cost or quality of the glass.

Rust Minerals (iron and manganese) can turn dishes or the tub interior a brown, red or black color.

To prevent:

1. Drain your home’s water heater once a year to flush away any mineral deposits.
2. Check with a water treatment company like Culligan or Kinetico to see if a filter is needed in the home.

To remove film from the dishwasher:

(Try one of the following.)

1. A damp cloth and mild scouring powder.
2. Run a Light cycle with detergent in the MAIN WASH cup only. Pour 1/2 cup of white vinegar into the tub in the bottom of the tub after the first fill.

To prevent:

1. Adjust the detergent amount to water hardness. (See pg. 6)
2. Adjust the water temperature. (See pg. 6)
3. Do not prerinse. This aggravates etching.

To remove:

(Do not use this method on metal items.)

1. Use a rust removing compound like RoVer Remover* (available from an authorized Major Appliance Parts Retailer by using Part No. 057961). **Do not use RoVer with dishwashing detergent.**
2. Fill both detergent cups with RoVer. Complete a Light wash cycle. Follow with a shorter wash cycle using dishwasher detergent.
3. The only permanent solution is to install special filters which can remove iron and manganese from the water.



Special Care Items

Knowing what can and cannot be washed in your dishwasher is important. Most tableware, cookware and silverware can be washed safely in your dishwasher. If you have any doubts about an item, check with the manufacturer. If you cannot reach the manufacturer, simply test-

wash one small item for several washes attempting to wash an entire set.

Note: It is the user's responsibility to determine if dishware should be washed in a dishwasher.

Material	Dishwasher Safe?	Special Information
Aluminum	Yes, except anodized aluminum and some cookware.	High water temperature and detergents may affect finish. Check clear instructions.
Cast Iron	No	Seasoning will be removed, and iron will rust.
China/ Stoneware	No, if antique or hand-painted china. Otherwise, check with manufacturer.	Always check manufacturer's recommendation before washing. Anti-hand-painted or over-the-glaze patterns may fade. Gold leaf may discolor. In doubt, test wash a small item for several weeks before washing entire set.
Crystal	No, if antique or light-weight delicate crystal. Otherwise, check with manufacturer.	Always check manufacturer's recommendation before washing. Some of leaded crystal may etch with repeated washings. If in doubt, test wash a small item for several weeks before washing an entire set.
Glass	Yes, except milkglass.	Milkglass will yellow with repeated dishwasher washing.
Gold-Plated Flatware	No	Will discolor.
Pewter	No	High water temperature and detergents may discolor or pit finish.
Disposable Plastics	No	Cannot withstand high water temperatures and detergents.
Plastics	Yes, top rack (If labeled "dishwasher safe")	Always check manufacturer's recommendation before washing. Plastics in their capacity to withstand high water temperatures and detergents.
Stainless Steel	Yes	Run a Rinse & Hold Cycle if not washing immediately. Prolonged contact with foods containing salt, vinegar, milk products or fruit juice could discolor finish.
Sterling Silver or Silverplate	No, if has commercial "darkening". Otherwise, check with manufacturer.	Always check manufacturer's recommendation before washing. Run a Rinse & Hold Cycle if not washing immediately. Prolonged contact with foods containing salt, acid or sulfide (eggs, mayonnaise and seafood) could darken finish. Commercial "darkening" may be removed by detergent.
Tin	No	
Wooden Items	No	Always check manufacturer's recommendation before washing. Wood can warp, crack or discolor.



Maintaining the Dishwasher.....

Your new Maytag Jetclean® dishwasher requires little maintenance attention. However, if you are going on vacation, leaving a summer home or storing the dishwasher for an extended period of time, you may want to review the following information.

Dishwasher Interior

Cleaning

The inside design is normally self-cleaning. However, you may want to periodically check the bottom of the dishwasher tub to see if any large particles have not gone through the strainer portion of the module.

You may also want to wipe the edge of the inner door liner to remove any food soil splashes which occurred during loading.

The color from some tomato-based food soils has been known to occasionally adhere to today's dishwasher tubs, causing discoloration. To help prevent this, **when washing a load of dishes soiled with tomato sauce:**

Scrape excess tomato-based food soils off of dishes, prior to loading. Do not prewash the dishes, however.

Select the Normal cycle with the IntelliClean™ option OFF.

Do not use the Temp Sense or Pots & Pans options if the incoming water temperature is already 120-140° F (49-60° C).

Odors

Any odor inside the dishwasher is likely related to a chemical (chlorine) odor from the detergent or a food odor from soiled items sitting in the dishwasher. Try using a different detergent, especially a lemon-scented one, or purchase a fresh package and see if the odor decreases.

It is recommended that the Rinse & Hold feature be used if dishes are to be held for a couple of days before washing. This will remove most food soils that can develop an odor.

For a strong odor, try *one* of the following:

1. Place baking soda in both sides of the detergent cup. Select China/Crystal and let the water circulate for about 10 minutes. Stop the dishwasher by unlatching the door and let stand overnight. Restart the dishwasher by latching the door and let it complete the cycle.
2. Use a commercial dishwasher cleaning product such as Jet-Dry Dishwasher Cleaner*, according to package directions.

Storage/Moving

Fill both detergent cups with a fresh-scented dishwasher detergent or baking soda and select a Normal cycle. Allow the dishwasher to complete the cycle. Then turn the water supply off and drain the dishwasher. To drain, start any cycle as all cycles begin with a drain. Let the drain for the drain to complete, then open the door to interrupt the cycle prior to the fill. Operate the drain twice to ensure most of the water is removed. Last, disconnect the electrical supply and prop open the door.

Dishwasher Exterior

The front of the dishwasher can be cleaned with a damp cloth and liquid spray cleaner. Do not use abrasive powders or cleaning pads.



Before You Call

Check these points to help save you time and money:

Won't Fill

- Be sure door is latched securely.
- Be sure the water is turned on.
- Check that the dial/pad is properly selected for a cycle.
- Allow time for select models to drain/pause before filling.
- Check your home's circuit breaker or fuse box.
- Check inlet hose for a kink.
- Check water valve inlet for sediment and clean if necessary.

Won't Drain/Water in Tub Bottom

- If hooked up to a food waste disposer, be sure the knock-out is 1" from the disposer inlet.
- Be sure the drain hose is elevated at least 32" so water cannot siphon into the tub.
- Check for a food obstruction in the drain or disposer.
- Check drain hose for a kink.
- Check your home's circuit breaker or fuse box.
- Check that the cycle is completed.

Dishwasher fills with water at END of cycle

- This is normal. The IntelliClean™ sensor in the pump must stay submerged so a short fill of water is added after the cycle's last drain.
- Check that the cycle is completed.

Detergent Cup Not Empty

- Be sure dispenser is not blocked.
- Use fresh detergent which has been stored in a cool, dry place.

Seems Noisy

- A water valve hiss during fill is normal.
- Water circulation sounds are normal.
- A ticking noise is a normal timer sound.
- A thumping sound may be a wash arm bumping an item that is beyond the racks.
- Chopping or grinding sounds may be heard during drain as the food disposer chops hard items like fruit seeds, nuts, etc.
- Humming during drain is normal.
- A snap noise is the detergent cup lid hitting the door liner when the washer door is opened at the end of the cycle. This is normal.
- Proper installation affects the noise level.

Cycle Takes Too Long— (Heating Delay light stays on)

- Temp Sense has been selected and the cycle is extended if the temperature is low. (See pg. 9)
- Check to see that the incoming water temperature is 120-140° F
- Dishes being held for a full load may need to be run through a Rinse cycle while waiting.

Has An Odor

- Many dishwashers have a "new" smell when first installed. This goes away with use.
- A chemical odor is usually the chlorine bleach in dishwasher detergent. You may want to try another brand.
- Dishwasher not draining properly. (See "Won't Drain" section.)

Leaks

- Check that the dishwasher is level. (Refer to the Installation Instructions.)
- Suds can cause the dishwasher to overflow. Measure the detergent and use only detergents designed for use in a dishwasher. Less detergent is needed in soft water. Try another brand if sudsing continues.
- Follow directions closely on how to add a forgotten item (see page 10).
- To avoid rinse aid leaking from the dispenser, be sure the lid is properly attached.
- Occasionally moisture droplets may be noticed on the door when the door is opened where heated air escapes from the tub. This is normal. If the door is opened before the droplets have evaporated, they may fall to the floor.

**Food Soil Remains
On Dishes**

- Check water temperature. (See pg. 6)
- Run hot water at the sink before starting the dishwasher.
- Select Temp Sense and Pots & Pans.
- Check water hardness and adjust detergent amount accordingly. (See pg. 6)
- Use fresh detergent stored in a cool dry place.
- Select proper cycle for the soil level.
- Load items so they do not block the wash arms or center tower. (See pgs. 3-5)
- Load the utensil basket with some handles up and some down to prevent nesting.
- Do not place glasses over tines.

Glasses Are Cloudy/Spotted

- Adjust detergent amount to water hardness. (See pg. 6 and 10)
- Check water temperature. Incoming hot water should be between 120-140° F (49-60° C).
- Use a rinse aid such as Cascade Rinse Aid* regularly.
- Don't prerinse. The detergent needs food soils to act on.
- If the problems persist after following the above guidelines, it may be due to other factors. In this case, try the following:
 - Lower the incoming water temperature to 120-130° F (49-56° C).
 - Decrease the amount of detergent in the MAIN WASH cup to 3 teaspoons.
 - Set the control dial to Normal.
 - Deselect water heating options.

**Items Washed in the Dishwasher
or the Dishwasher Tub Itself are
Stained/Discolored**

- Aluminum utensils or pans can leave marks when they rub against other items. Leave a slight space between.
- Iron in the water can leave a yellow, brown or orange film on dishes or the dishwasher tub. A filter may be needed. RoVer Rust Remover* can be used to remove rust.
- Color from tomato sauces may adhere to the tub (see page 12). If light staining has occurred, leave the door open to oxidize the stain away. For removing heavier stains, try a dishwasher cleaning product (such as Glisten*) that contains citric acid. Changing to a lemon-scented detergent (such as Sunlight) may also help.

**Items Not Properly Dried/ Moisture
is present on the
dishwasher interior after the dry
cycle.**

- Be sure Heat Dry is selected.
- Water droplets may form on the inner door as part of the drying process.
- Use a rinse aid like Jet Dry or Cascade Rinse Aid* regularly, to improve drying. On models equipped with an adjustable rinse aid cap, turn the dial towards the MORE setting.
- Check water temperature. (See pg. 6)
- Select Temp Sense and Pots & Pans.
- Increase detergent amount to match water hardness.
- Load properly. (See pgs. 3-5)
- Plastic and teflon items are inherently difficult to dry because they have a porous surface and tend to collect water droplets. Towel drying may be necessary.
- Glasses and cups with concave bottoms hold water and require towel drying.
- A Quick Wash/Rinse cycle does not dry the dishes. Towel drying is required.

Dishware is Chipped

- Load dishes according to instructions so they do not strike each other. (See pgs. 3-5)
- We do not recommend washing fine antique china/crystal in the dishwasher.
- Do not load glasses over the tines.
- Do not overload.

** Brand names are trademarks of the respective manufacturer.*

**For further assistance contact Maytag Appliances Sales Company, Maytag Customer Assistance: U.S. 1-800-445-3353
Canada 1-800-445-3353**



Dishwasher Warranty.....

Full One Year Warranty

For ONE (1) year from the date of original retail purchase, any part which fails in normal home use will be repaired or replaced free of charge.

Limited Second Year Warranty

After the first year from the date of original retail purchase, through the second year, parts which fail in normal home use will be repaired or replaced free of charge for the part itself, with the owner paying all other costs, including labor, mileage and transportation.

Limited Third Through Fifth Year Warranty

After the second year from the date of original retail purchase, through the fifth year, all of the following components which fail in normal home use will be repaired or replaced free of charge for the part itself, with the owner paying all other costs, including labor, mileage and transportation. These components include:

Any parts of the Jetclean® system for all models, including the complete power module assembly, sensor, center spray nozzle, spray arms, wash arm hose, and motor.

Computer Touch Control models only – any microprocessor and touch pad assemblies.

All models against rust, including exterior cabinet and front panels of convertible models, the exterior front panels and accessory side panel built-in models, and nylon coated racks (available on selected models).

Full Twenty-Year Warranty

First through the twentieth year

From the date of original purchase through the twentieth year, should the tub develop a water leak in normal home use, the dishwasher itself will be replaced **FREE OF CHARGE**.

First through the twentieth year

From the date of original purchase through the twentieth year, should the door liner develop a water leak in normal home use, repair or replacement of the door liner will be made **FREE OF CHARGE**.

PLEASE NOTE: These full warranties apply only when the dishwasher is located in the United States or Canada. Dishwashers located elsewhere are covered by the limited warranties only, including a limited warranty for parts which fail during the first year.

Canadian Residents

These warranties cover only those dishwashers installed in Canada that have been listed with Canadian Standards Association unless the dishwashers are brought into Canada due to transfer of residence from the United States to Canada.

The specific warranties expressed above are the **ONLY** warranties provided by the manufacturer. These warranties give you specific legal rights, and you may also have other rights that vary from state to state.

To Receive Warranty Service

To locate an authorized service company in your area contact the Maytag dealer from whom your appliance was purchased; or call Maytag Appliances Sales Company, Maytag Customer Assistance at the number listed below. Should you not receive satisfactory warranty service, please

Maytag Appliances Sales Company

Attn: CAIRSM Center

P.O. Box 2370

Cleveland, TN 37320-2370

U.S. 1-800-688-9900

CANADA 1-800-688-2002

U.S. customers using TTY for deaf, hearing impaired or speech impaired, call 1-800-688-2080.

NOTE: When writing about an unsolved service problem, please include the following information:

- (a) Your name, address and telephone number;
- (b) Model number and serial number (found on the upper left corner of the tub opening) of your appliance;
- (c) Name and address of your dealer and the date the appliance was purchased;
- (d) A clear description of the problem you are having;
- (e) Water hardness, detergent brand and amount, water temperature, and cycle used;
- (f) Proof of purchase (sales receipt).

What Is Not Covered By These Warranties:

1. Conditions and damages resulting from any of the following:
 - a. Improper installation, delivery, or maintenance.
 - b. Any repair, modification, alteration or adjustment not authorized by the manufacturer or an authorized servicer.
 - c. Misuse, abuse, accidents, or unreasonable use.
 - d. Incorrect electric current, voltage or supply.
 - e. Improper setting of any control.
2. Warranties are void if the original serial numbers have been removed, altered, or cannot be readily determined.
3. Products purchased for commercial or industrial use.
4. The cost of service or service call to:
 - a. Correct installation errors.
 - b. Instruct the user on proper use of the product.
 - c. Transport the appliance to the servicer.
5. Consequential or incidental damages sustained by any person as a result of any breach of these warranties. Some states do not allow the exclusion or limitation of consequential or incidental damages, so the above exclusion may not apply.

User's Guides, service manuals and parts catalogs are available from Maytag Appliances Sales Company, Maytag Customer Assistance

MAYTAG • One Dependability Square • Newton, Iowa 50208

Free Manuals Download Website

<http://myh66.com>

<http://usermanuals.us>

<http://www.somanuals.com>

<http://www.4manuals.cc>

<http://www.manual-lib.com>

<http://www.404manual.com>

<http://www.luxmanual.com>

<http://aubethermostatmanual.com>

Golf course search by state

<http://golfingnear.com>

Email search by domain

<http://emailbydomain.com>

Auto manuals search

<http://auto.somanuals.com>

TV manuals search

<http://tv.somanuals.com>